✓
AR-147
AR-247
AR-447

MOBILE TRANSCEIVER

USER'S MANUAL



Thank you for purchasing this VHF/UHF mobile transceiver.

IMPORTANT

Please read this instruction manual carefully before attempting operation.

SAVE THIS INSTRUCTION MANUAL.

CAUTION:

Long transmission or extended operation in the HI power mode might cause the rear of this transceiver to get warm. Do not place the transceiver where the heat sink (rear panel) might come in contact with plastic or vinyl surfaces.

This Instruction Manual covers the following models.

- AR-147 144MHz FM TRANSCEIVER
- AR-247 222/230/250MHz FM TRANSCEIVER
- AR-447 430/440MHz FM TRANSCEIVER

NOTE:

If disregarded, inconvenience only, no risk of equipment damage or personal injury.

CAUTION:

Equipment damage may occur, but not personal injury.

FCC WARNING

This equipment generates or uses radio frequency energy. Changes or modifications to this equipment may cause harmful interference unless the modifications are expressly approved in the instruction manual. The user could lose the authority to operation this equipment if an unauthorized change or modification is made.

1. BEFORE OPERATION.....	3		
2. SPECIFICATIONS.....	5		
3. ACCESSORIES.....	6		
4. INSTALLATION INSTRUCTION.....	6		
5. OPERATION.....	9		
CONTROL FUNCTION.....	9		
RECEIVER OPERATION			
Reception.....	14		
Frequency Selection.....	15		
Frequency Step Selection.....	15		
TRANSMITTER OPERATION			
Transmit Basics.....	16		
Time-out Timer(TOT).....	16		
MEMORY			
Memory Channels.....	17		
Initial State.....	17		
System Memory Initialization.....	17		
Specific Memory Channels.....	18		
Memory Entry.....	18		
Memory Channel Recall.....	19		
Memory Shift.....	19		
Memory Channel Clear.....	19		
SCAN			
Scan Operation.....	20		
Hold/Resume Programming.....	20		
Band Scan.....	20		
Programmable Band Scan.....	21		
Memory Channel Scan.....	21		
Memory Channel Lockout.....	22		
DUAL-WATCH OPERATION.....	22		
		REPEATER OPERATION	
		Transmitter Offset.....	24
		Automatic Repeater Offset.....	24
		Reverse Function.....	24
		Tone Operation.....	25
		CTCSS Tone Selection.....	25
		DCS Code Selection.....	26
		CTCSS/DCS FEATURE SELECTION.....	27
		CTCSS Tone/DCS Code Scan.....	27
		C.SQ(Code Squelch System) OPERATION.....	27
		PAGING.....	30
		DTMF CODE DECODING FUNCTION.....	35
		DTMF AUTODIALER OPERATION.....	36
		DTMF REDIALER OPERATION.....	37
		KEYPAD DIRECT FREQUENCY ENTRY.....	37
		APO(Automatic Power Off).....	37
		DIM(Dimmer).....	37
		BEEP.....	38
		LOCK.....	38
		CHANNEL DISPLAY.....	39
		AM RECEPTION(AR-147 option only).....	39
		6. KEY FUNCTION LIST.....	40
		7. MAINTENANCE.....	42
		GENERAL INFORMATION.....	42
		SERVICE.....	42
		IN CASE OF DIFFICULTY.....	43

BEFORE OPERATION

**TO PREVENT ELECTRIC SHOCK, FIRE AND OTHER INJURY.
PLEASE NOTE THE FOLLOWING:**

To avoid risk of electric shock, under no circumstances should the unit be opened.

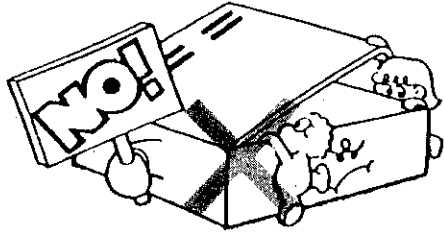

Do not place this unit, where it will be exposed to direct sunlight or close to heating appliances.

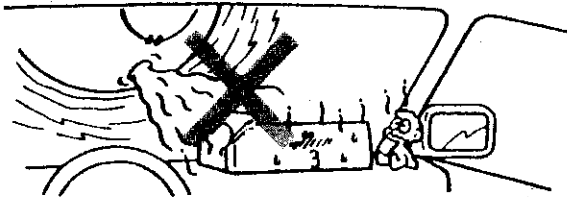

To ensure good ventilation, do not put anything on top of the cabinet and allow at least 15cm (6 inch) of space behind the unit.

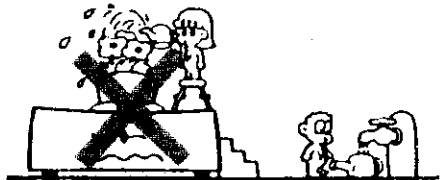

The power requirement is 13.8 VDC.
Never attempt connection to a 24 VDC source.

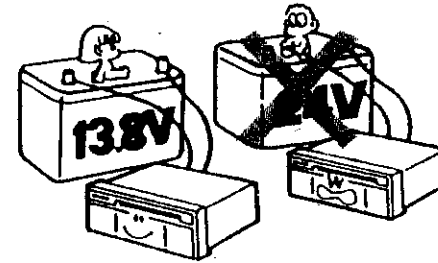

Do not place the Unit in areas off excessive dust, high humidity or on unstable surfaces.



Do not drop pieces of metal, needles, coins and other electrically conductive materials into the unit.

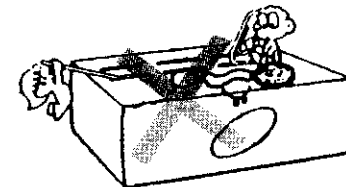

Do not touch the power plug when your hands are wet.



Do not pull the power cord, when disconnecting it from the AC wall outlet. Grasp the plug and ensure that your fingers do not touch the live pins.



If an abnormal odor or smoke is detected, immediately turn the power off and pull out the power plug. Connect the ADI service station or our dealer.



CLEANING

1. Turn the power off, before cleaning the unit.
2. Do not use any type of abrasive pad, thinner, benzene or any substances which may damage the unit.
3. Wipe the front panel and other exterior surfaces of the with a soft dry cloth or a soft cloth lightly moistened with water.

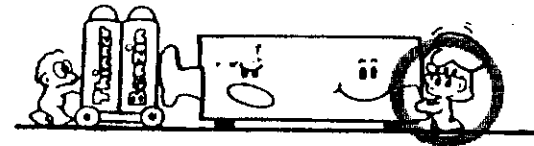

2. SPECIFICATIONS

		AR-147	AR-247	AR-447	
General	Frequency range (MHz)	144 to148(USA)	222 to 225(USA)	430 to 440	
		144 to146	230 to 250		
			250 to 270		
	Mode	F3E(FM)			
	Antenna impedance	50Ω			
	Operating temperature	-20°C to +60°C (-4°F to +140°F)			
	Power requirements	13.8V DC ±15%(11.7-15.8V)			
	Ground	Negative			
	Current drain	Transmit mode	Less than 12A	Less than 9A	Less than10A
		Receive mode	Less than 0.6A		
Frequency Stability	Less than ±5ppm				
Dimensions (WxHxD) (mm)(Projections included)	140x40x166(5-1/2" x 1-37/64" x 6-17/32")				
Weight (kg)	1.2(2.65lbs)				
Transmitter	Output power	HI	Approx 60W	Approx 30W	Approx 35W
		MID	Approx 25W	Approx 15W	Approx 15W
		LOW	Approx 7W	Approx 7W	Approx 7W
	Modulation	Reactance modulation			
	Spurious radiation	Less than -80dB	Less than -70dB	Less than -65dB	
	Maximum frequency deviation	±5kHz			
	Audio distortion(at 60% modulation)	Less than 3%(300 to 3000 Hz)			
Microphone impedance	2.2kΩ				
Receiver	Circuitry	Dual conversion superheterodyne			
	Intermediate frequency	1st / 2nd	10.7MHz/455kHz	30.85MHz/455kHz	30.85MHz/455kHz
	Sensitivity (12dB SINAD)	Less than 0.18 uV			
	Selectivity	70 dB	70 dB	65 dB	
	Squelch sensitivity	Less than 0.1 uV	Less than 0.177 uV	Less than 0.177 uV	
	Audio output(10% distortion)	More than 2W across 8Ω load			
External speaker impedance	8Ω				

Note:1.Circuit and ratings are subject to change without prior notice due to advancement in technology.

2.Recommended duty cycle: 1 minute:Transmit, 3minutes Reception.

ACCESSORIES

Unpack your new transceiver carefully, and examine it for visible damage. If the equipment has been damaged in shipment, notify the transportation company immediately. Save the boxes and packing material for future shipping.

The following accessories should be included in the box with the transceiver.

DTMF Microphone

MC147D.....	1 ea.
or	
Dynamic Microphone (GENERAL market only) MC147.....	1 ea.
Hex wrench.....	1 ea.
Stacking plate	
DC power Cable.....	1 ea.
Fuse.....	1 ea.
Instruction Manual.....	1 ea.
Warranty Card.....	1 ea.

INSTALLATION INSTRUCTION

4.1 INSTRUCTION

MOUNTING BRACKET

When installing the transceiver in a vehicle consider the ease of operation and safety when selecting the location for the mounting bracket.

1. Install the bracket using the supplied flat washer and self tapping screws (4 pc s. each).
2. Attach the transceiver loosely using the 4 SEMS screws.
3. Align the grooves in the bracket with the transceiver's screws (Fig. A) and slide the transceiver to the rear.
4. Adjust the viewing angle in the bracket to the desired position (Fig. B).
5. Hold the transceiver in place and tighten the 4 SEMS screws using the supplied wrench.

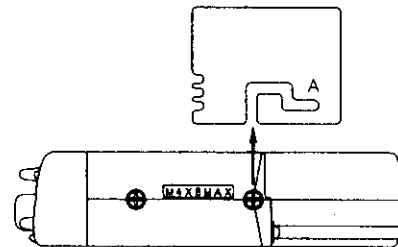

Fig. A

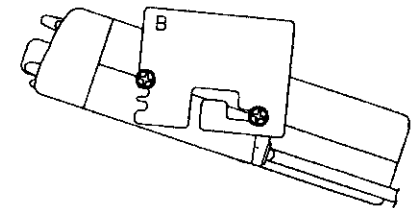

Fig. B

4-2 CONNECTOR

4-2-1 Mobile Installations

Cautions:

1. Before installing the power cable, be sure to remove the negative lead from the battery for safety.
2. After installation and wiring, be sure to double check for correct installation before reconnecting the negative lead to the battery terminal.
3. If the fuse opens, be sure to check that each conductor has been damaged by short circuiting, etc. Then replace with a new fuse of the same rating.
4. After completing the wiring, wrap the fuse holder with heat resistant tape to protect against heat and moisture.
5. Do not remove the fuse even if the power cable is too long.

A. Battery Connections

Connect the power cable directly to the battery terminals. Using of the cigarette lighter socket will lead to a poor connection, and will result in poor performance. Pay close attention to the polarity of the cables when connecting them to the battery.

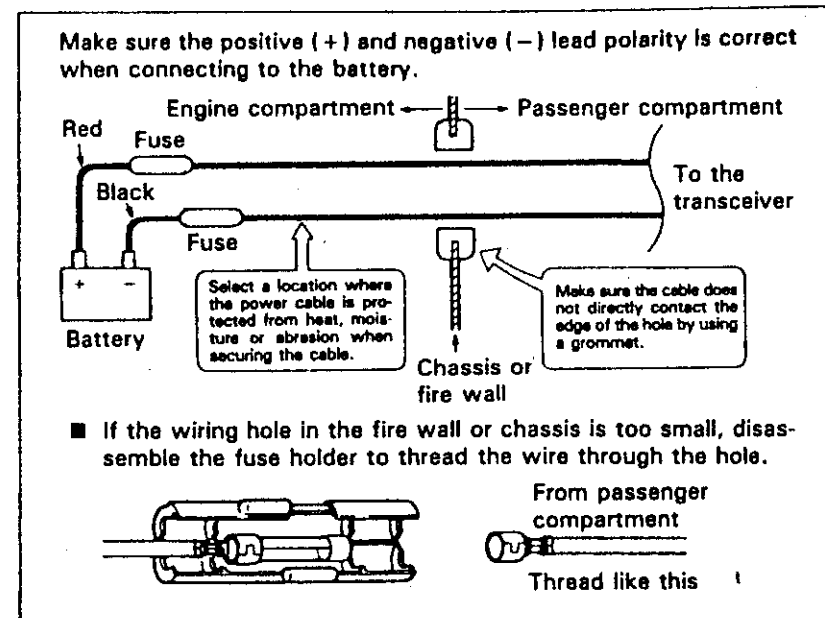

B. Ignition Noise

This transceiver has been designed to suppress ignition noise; however, if excessive noise is present, it may be necessary to use suppressor spark plugs (with resistors).

ACCESSORIES

Unpack your new transceiver carefully, and examine it for visible damage. If the equipment has been damaged in shipment, notify the transportation company immediately. Save the boxes and packing material for future shipping.

The following accessories should be included in the box with the transceiver.

DTMF Microphone

MC147D.....	1 ea.
or	
Dynamic Microphone (GENERAL market only) MC147.....	1 ea.
Hex wrench.....	1 ea.
Stacking plate	
DC power Cable.....	1 ea.
Fuse.....	1 ea.
Instruction Manual.....	1 ea.
Warranty Card.....	1 ea.

INSTALLATION INSTRUCTION

4.1 INSTRUCTION

MOUNTING BRACKET

When installing the transceiver in a vehicle consider the ease of operation and safety when selecting the location for the mounting bracket.

1. Install the bracket using the supplied flat washer and self tapping screws (4 pc s. each).
2. Attach the transceiver loosely using the 4 SEMS screws.
3. Align the grooves in the bracket with the transceiver's screws (Fig. A) and slide the transceiver to the rear.
4. Adjust the viewing angle in the bracket to the desired position (Fig. B).
5. Hold the transceiver in place and tighten the 4 SEMS screws using the supplied wrench.

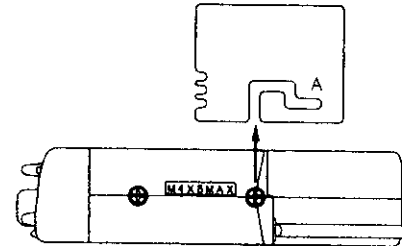

Fig. A

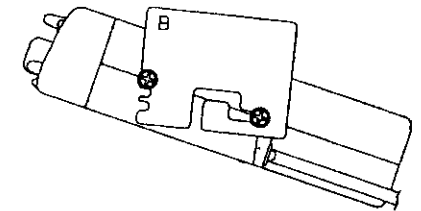

Fig. B

4-2-2 Fixed Station

A regulated DC power supply (13.8 VDC capable of supplying at less 11 Amperes) is required.

1. Never connect the AC power cable to the AC until all other connections have been made.
2. Before connecting and disconnecting the power connector, be sure to turn OFF the POWER switches of both the transceiver and the DC power supply.
3. Observe polarity of the DC power cable. The Transceiver operates on 13.8 VDC, negative ground. Battery polarity must be correct. The power cable is color coded:
 - Red ➔ + (Positive polarity)
 - Red ➔ - (Negative polarity)
4. The transceiver has voltage protection which keeps the voltage under 18VDC.
5. Once the voltage is over 18VDC, the transceiver will shut down automatically. To restart the system, adjust the voltage to 13.8VDC and switch off the power then switch on again.

4-2-3 Antenna

The type of antenna that is use will greatly affect the performance of the transceiver. Use a properly adjusted antenna, of good quality, to enable your transceiver to perform at its best. The antenna input impedance is 50 ohms. Use 50-ohm coaxial cable such as RG-8U or 8D-2V for this connection. If the antenna is far from the transceiver the use of low coaxial cable, such as RG-8U is recommended.

Match the impedance of the coaxial cable and that of the antenna so that the SWR is less than 1.5 to 10. The protection circuit in the transceiver will activate if the SWR is particularly poor (greater than 3 to 1).

High SWR values will cause the transceiver output to drop, and may lead to TVI or BCI reports.

CAUTION:

We recommend that you install a high quality lightning arrester in your antenna lines for protection again fire, electric shock, personal injury, or damage to the radio itself.

5 OPERATION

5-1-1 CONTROL FUNCTIONS

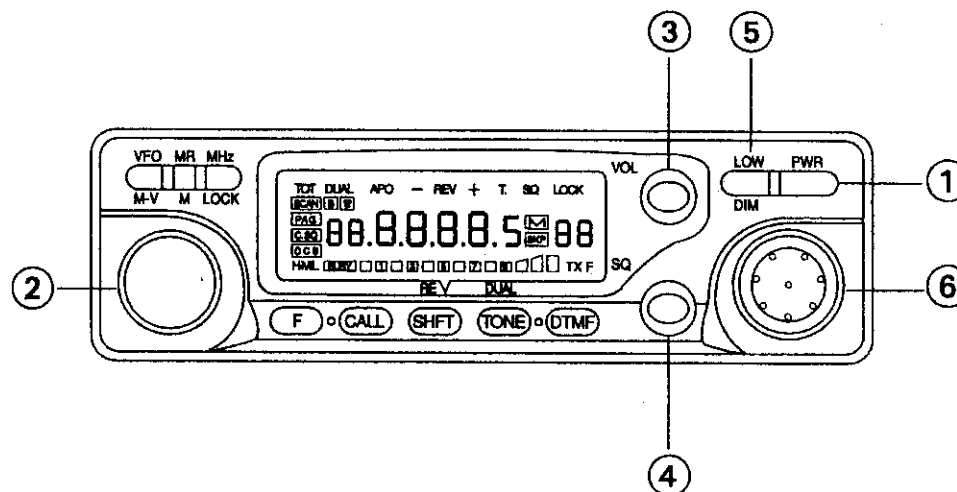

① POWER switch

Press to turn the transceiver on or off.

Press the VFO/M►V or MR/M key and switching the power on will reset the VFO or MEMORY.

② Tuning control

This control is used to select the desired transmit/receive frequency, MHz step, memory channel, frequency step, tone frequency, scan direction, etc.

③ VOL control

This control is used to adjust the volume from the internal and external speaker (if used). Clockwise rotation will increase the volume and counterclockwise rotation will decrease the volume.

④ SQ(Squelch) control

This control is used to select the desired squelch threshold level.

⑤ LOW/DIM key

LOW

This function is used to select the transmit output power level (HI, MID or LOW)

DIM

This function is used to select the intensity of the front panel display illumination.

Pressing the F key for longer than 1 second and then press the LOW/DIM key while the F indicator is flashing will turn the time-out timer function on and off.

⑥ Microphone connector

Attach the supplied microphone to this connector. The pin out of the connector is shown in the accompanying illustration.

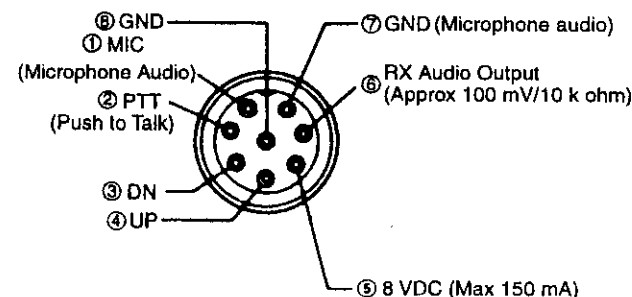

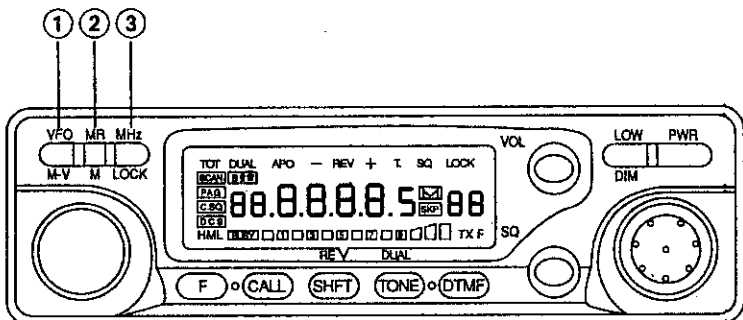

① VFO/M▶V key

This key is used to VFO operation after operating in the MR or CALL channel mode. Pressing this key will allow the turning control and microphone UP/DN keys to increase or decrease the operating frequency.

Press and hold the key for longer than 1 second to initiate VFO scan. Pressing the key after scan has been initiated will cause scan to stop.

Pressing the key within 10 seconds of pressing the F key will copy the memory channel or call channel data to the VFO. This allows you to change parameters of the channel without actually changing the data that has been stored in memory.

Pressing the key F key for longer than 1 second and then pressing the VFO key will allow you to set the offset frequency.

If you press and hold the VFO key while you turn on the POWER switch you will reset the microphone's VFO memory, without destroying the memory channel or call channel data. (VFO Reset)

② MR/M key

This key is used to select MR (Memory Recall) mode from the VFO

mode. The Tuning control can then be used to select the desired memory channel.

Press the key for longer than 1 second will initiate memory channel scanning.

Pressing the key within 10 second of pressing the F key will store the display data into memory.

In the MR channel mode pressing the F key for longer than 1 second and then pressing the MR key will cause the Memory channel to skip during Memory channel scan mode.

If you hold and press this key while you turn on the PWR switch you will clear all the microprocessor's operator programmed memory section.(system reset)

③ MHz/LOCK key

This key is used to tell the microprocessor that you wish to turning the operating frequency in 1 MHz step.If the DTMF board is installed, you also could enter the frequency with the 16-tone DTMF keypad directly.

Pressing this key within 10 seconds of pressing the F key will cause the key lock function to activate, protecting the currently display data from accidental erasure.

Pressing the F key for longer than 1 second and then pressing MHz/LOCK key while the indicator is flashing will turn the AUTOMATIC POWER OFF function on or off.

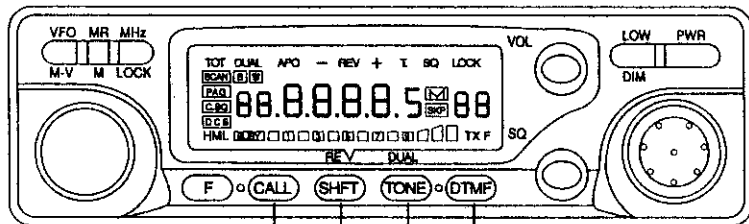

④ CALL key

Press this key to activate the call channel function. Press the F key momentarily and then press the CALL key to store the currently displayed data into the CALL channel (except that PAG/C.SQ activated in VFO mode). The radio will allow you up to 10 seconds to press the CALL key after pressing the F key.

Pressing the F key for longer than 1 second and then pressing the CALL key will enable/disable the programming scan mode.

Press the key within 10 seconds of pressing the F key while PAG/CSQ is active will allow you to change the DTMF transmitting delay time.

⑤ SHFT/REV key

SHIFT function

Pressing this key alone to select the desired transmitter offset feature. Pressing the key will cause the radio to shift from one offset feature to the next, i.e. "-" (minus offset) to "+" (plus offset) to "- +" (automatic repeater mode), then back to simplex mode where no indicator shows.

REV function

Pressing the key within 10 seconds of pressing of pressing the F key will reverse the transmit/receive frequencies during repeater operation.

If you have selected simplex this key will not function!

Pressing the F key for longer than 1 second and then the SHFT/REV key will allow you to select the desired VFO tuning step

and scan step size. Use the tuning control to select the desired tuning step and then press any front panel key except the PWR switch to return to the normal frequency display.

⑥ TONE/DUAL key

TONE (CTCSS/DCS) function

Pressing this key by itself causes the radio to select the desired subaudible tone signaling mode. When the "T." indicator is illuminated in the display the transceiver will transmit the the selected CTCSS tone. When the "T.SQ" indicator is illuminated the transceiver will both transmit the subaudible tone and will also remain squelched until the selected CTCSS tone is received.

When the "DCS" and "T." indicators illuminated, the Transceiver will transmit the selected DCS code. If the "SQ" indicator also illuminated, the transceiver will remain squelched until the selected DCS code is received.

TONE (CTCSS/DCS) selection

Pressing the F key for longer than 1 second and then pressing the TONE/DUAL key will allow you to select the desired subaudible tone. To change to a different subaudible tone rotate the tuning control or press the UP/DN switches on the microphone until the desired subaudible tone appears in the display. To return to the normal frequency display you can press any front panel key except the PWR switch.

DUAL function

If you press the F key momentarily and then press the TONE/DUAL key, DUAL function will be activated.

This function allows you to watch two different frequencies. The Transceiver is capable of following types of dual-watch operation.

- (1) Listen on the dial-frequency and the memory frequency under M1.
- (2) Listen on the dial-frequency and one of the memory frequencies.
- (3) Listen on the dial-frequency and a memory frequency under scanning.

⑦ DTMF key

Pressing this key alone to select the PAG, CSQ function if the DTMF board is installed. Otherwise, a BU-sound will be generated. Pressing the F key for longer than 1 second and pressing the DTMF key will turn the BEEP function OFF or ON.

5-1-2 LCD Display Panel

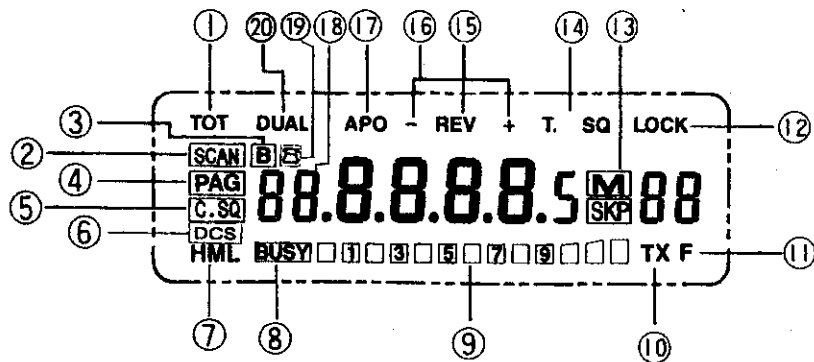

- ①TOT On when the Time Out Timer function has been activated.
- ②SCAN On when the VFO/MR SCAN function has been activated.
- ③B On when the Busy SCAN flag is active.
- ④PAG On when the DTMF PAGING function is active.
- ⑤C.SQ On when the code squelch function has been activated.
- ⑥DCS On when DCS(Digital Code Squelch) function has been activated.
- ⑦HML Indicates the relative output power setting for transmit.
- ⑧ **BUSY** On when the squelch opens.
- ⑨ This level meter indicates the relative receiver signal strength or the relative transceiver power output.

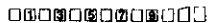

- ⑩TX On during transmit.
- ⑪F On whenever the function has been depressed. Also shows the last memory channel number that has been selected.
- ⑫LOCK On when the Lock function has been activated.
- ⑬ **M 88** Indicates the active memory channel number. SKP indicates that the channel is lock out.
- ⑭T.SQ On when the CTCSS/DCS Decode and Encode function has been activated.
- ⑮REV On when the Reserve function has been activated.
- ⑯ - + Display the selected transmitter Offset direction. Both - and + light when during Automatic Repeater function is activated.
- ⑰APO On when the Automatic Power Off function has been activated.
- ⑱ **88.8.8.8.5** Displays the operating frequency to the nearest kHz digit; or the tone frequency etc.
- ⑲ On when DTMF Autodialer function has been activated.
- ⑳ DUAL On when DUAL-watch function is active.

5-1-3 Rear Panel

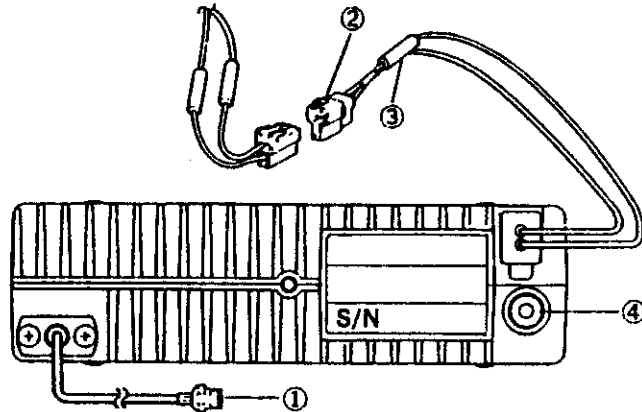

① **ANTENNA connector**

Attach an antenna with a low SWR and impedance of 50 ohms.

② **13.8 VDC power input connector**

Connect the supplied DC power cable to this connector.

Pay close attention to the polarity. Red is positive and black is negative.

③ **Fuse holder**

Contains a required fuse.

Do not use a larger fuse as damage might result to the transceiver.

④ **External speaker jack**

This jack is used to connect an external speaker. The speaker should have an impedance of 8 ohms.

5-1-4 Microphone

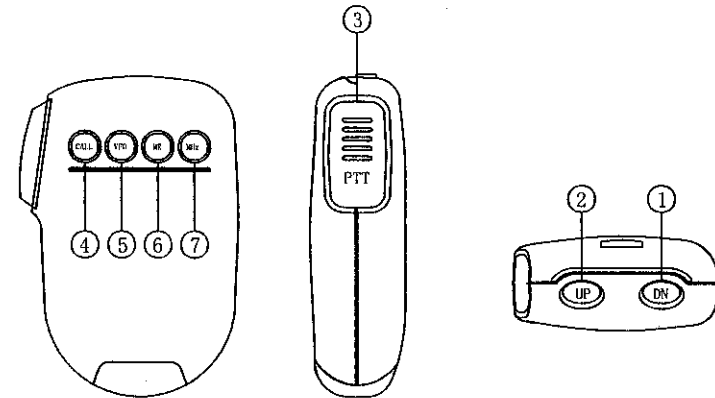

① ② **UP/DOWN switches**

These switches can be used to increase or decrease the VFO frequency, the Memory channel number, and the subaudible tone etc..

③ **PTT(push to Talk) switch**

The transceiver will transmit whenever this switch is depressed.

④ **CALL Key**

This key functions just like the CALL key on the front of the radio.

Repeater Access Tone

The transceiver will transmit with repeater access tone whenever this switch is depressed in Tx mode.

The repeater access tone could be selected as 1450, 1750, or 2100Hz.

⑤ **VFO key**

This key functions just like the VFO key on the front of the radio.

⑥ **MR key**

This key functions just like the MR key on the front of the radio.

⑦ **MHz key**

This key functions just like the MHz key on the front of the radio.

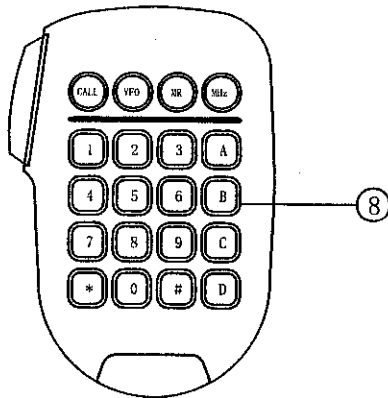

⑧ **16-Tone DTMF keypad**

These buttons are used to activate the DTMF encoder.

⑨ **LOCK key**

This key will deactivate all functions of the microphone except the PTT function and DTMF key pad.

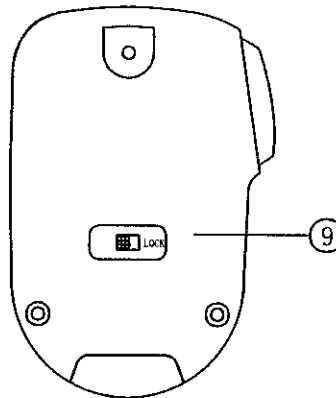

5-2 RECEIVER OPERATION

Audio confirmation is provided whenever a front panel key is depressed. You can disable this function by pressing the F key for longer than 1 second and then pressing the DTMF key.

5-2-1 Reception

1. Connect the power supply, antenna, and microphone and then adjust the controls as follows:

Power switch.....OFF

Volume Control.....Full Counterclockwise

Power switch of power supply

(Fixed station).....OFF

SQ Control.....Full Counterclockwise

2. Turn on the Power Supply and then turn on the transceivers **PWR** switch. The display should indicate a frequency. Fig.1 shows examples of frequencies that will appear on the various models. In addition to the frequency you may see one or more control indicators illuminate on the display.

AR-147

144.000

AR-247

223.500

AR-447

440.000

Note

The frequencies shown above are the default frequencies after a microprocessor reset. If the display shows incomplete data or you think the displayed frequency is in error you should reset the Microprocessor.

3. Rotate the VOL control clockwise until a signal or noise is heard coming from the speaker.
4. Rotate the tuning control or press the microphone UP/DN switches to select an open channel. Then rotate the SQ control clockwise until the noise just disappears and the BUSY indicator turns off. This point is known as the Squelch Threshold point. The squelch control must be adjusted to this setting for the Scan functions to operate properly.
5. Select the desired operating frequency using the microphone or tuning control. When a signal is received the S-meter will deflect and the BUSY indicator will turn ON.

Caution

Turn off the transceiver PWR switch before you start or stop your vehicles engine, or your home power supply.

5-2-2 Frequency Selection

You can change the dial frequency while in the VFO mode. The frequency can then also be stored in memory, or in the call channel using the techniques that will be described in this manual.

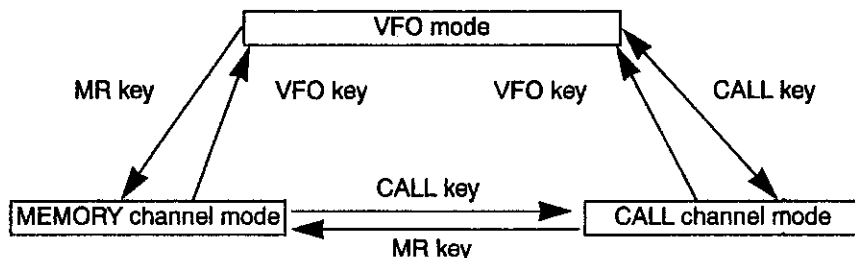

● VFO Mode Operation Frequency Selection

1. Press the VFO/M▶V key to select the VFO mode.
2. Rotate the tuning control or press the microphone UP/DN switches to select the desired frequency.

● Memory Channel Selection

1. Press the MR/M key.
2. Rotate the tuning control or press the microphone UP/DN switches to select the desired memory channel.

● CALL Channel Selection

Press the CALL key to select the Call channel.

5-2-3 Frequency Step Selection

The frequency step is indicated in the chart below.

Frequency step (KHz) 5 ⇄ 10 ⇄ 12.5 ⇄ 15 ⇄ 20 ⇄ 25 ⇄ 50

To select the desired tuning or scan step size use the following procedure:

1. Press the VFO/M▶V key to select the VFO mode.
2. Press the F key for longer than 1 second. The F indicator should light in the display.
3. Press the SHFT/REV key within 10 seconds of pressing the F key. The current frequency step size will be displayed.

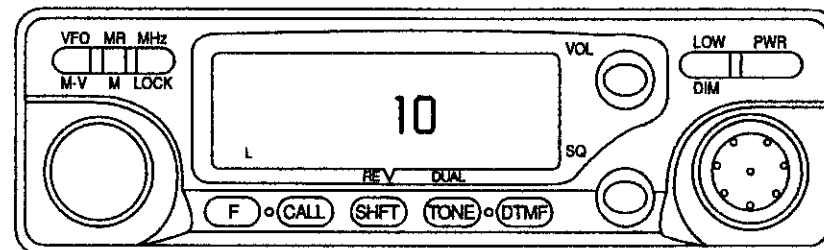

4. Rotate the tuning control or press the UP/DN switches on the microphone until the desired tuning step size appears in the display.
5. To complete the programming of the step size you can press any key on the front panel except the **PWR** key, or simply wait 10 seconds and the microphone will automatically return to the normal frequency display.

5-3 TRANSMITTER OPERATION

Caution

1. Ensure that an antenna with a low standing wave ration (SWR) is attached to the antenna connector before attempting to transmit failure to provide proper termination may result in damage to the final amplifier section.
2. Always check to ensure the frequency is clear before transmitting.

Note

The use LOW power is recommended whenever possible, to avoid interference with other stations.

5-3-1 Transmit Basics

1. Select the desired operation frequency using any of the methods previously discussed.
2. Press the LOW/DIM key to select the desired transmit output.

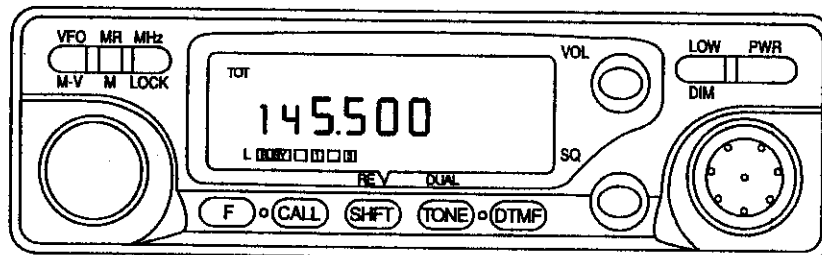

3. Check the frequency to see if it is occupied before you transmit.
4. Press the PTT switch. The TX indicator will light, and the RF meter will deflect to the right.

If you have selected the LOW power position, the indicator will appear in the display and the RF meter will only deflect full scale.

5. Speak into the microphone. The recommended distance to the microphone is 5 cm (2 inches).
- ※ A "OFF" will appear on the display if TX frequency is out of the range.

5-3-2 Time-out-Timer(TOT)

The TOT can limit the continuous transmission time to the TOT time(the default time is 10 minutes).

1. Press the F key for longer than 1 second, then press the LOW/DIM key. The TOT indicator will light. Rotate the tuning control or press the UP/DN switches on the microphone to select the TOT time(1/3/5/10/15/30 minutes).

To cancel the TOT setting, repeat the same procedure.

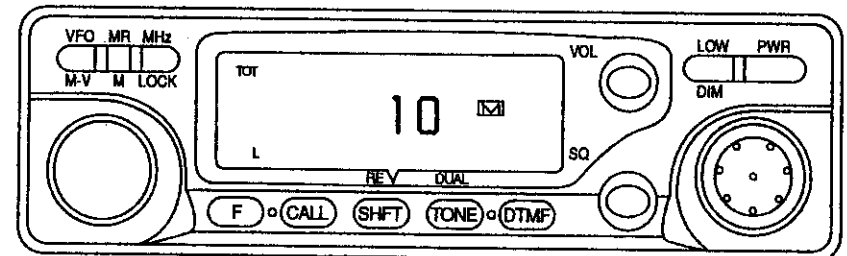

2. When the time of time-out timer is out, the transceiver will disable the transmitter. To transmit again, release the PTT switch and press it again.

5-4 MEMORY

5-4-1 Memory Channels

This transceiver contains a EEPROM to retain 81 memory channels(CALL channel included).

The data listed below can be stored in each memory channel.

- | | |
|-------------------------|------------------------------------|
| 1. RX frequency | 7. C.SQ code |
| 2. TX offset frequency | 8. CTCSS/DCS status |
| 3. TX offset direction | 9. PAG/C.SQ status |
| 4. Repeater access tone | 10. Automatic repeater mode status |
| 5. CTCSS tone frequency | 11. DTMF TX speed |
| 6. DCS code/polarity | 12. DTMF TX delay time |

5-4-2 Initial State

Initial state of the transceiver from the factory is shown in the chart below.

	AR-147	AR-247	AR-447
VFO/Memory channel 1/ CALL channel frequency	144.000 MHz	223.500 MHz	440.000 MHz
VFO step	10kHz	10kHz	10kHz
Memory channel	1 CH	1 CH	1 CH
CTCSS frequency	88.5Hz	88.5Hz	88.5Hz
DCS code	263	263	263
DCS Polarity	Tx/Rx Normal	Tx/Rx Normal	Tx/Rx Normal
Repeater Access Tone	1750 Hz	1750 Hz	1750Hz
Offset Frequency	600KHz	1.6MHz	5MHz
DTMF speed	50ms	50ms	50ms
DTMF Tx delay	450 ms	450 ms	450ms

5-4-3 System Memory Initialization

● Memory channel Initialization (System Reset)

When you want to erase all programmed data or if the display shows erroneous information, you should initialize (reset) the transceiver using the following procedure.

1. Turn the **PWR** switch off.
2. Press and hold the MR/M key and turn on the **PWR** switch.
3. Release the MR/M key.

● VFO Initialization(VFO Reset)

All the settings, except the contents of the memory and call channel, are initialized.

1. Turn the **PWR** switch off.
2. Press and Hold the VFO/M▶V key then turn the **PWR** switch on.
3. Release the VFO/M▶V key .

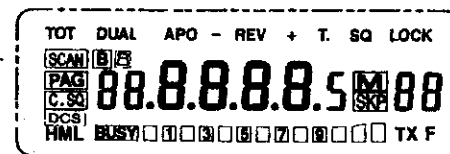

5-4-4 Specific Memory Channels

This transceiver provides 81 Memory Channels(CALL channel included).

In addition to serving as a normal Memory Channel, some of the Memory Channels serve a dual purpose to specify other parameters. The functions of those Memory Channels are described below.

- Memory Channel 1 is used to store the frequency for the DUAL-WATCH function.
- Memory Channel 11 is used to store the lower limit for the Programmable Band Scan function.
- Memory Channel 12 is used to store the upper limit for the Programmable Band Scan function.

5-4-5 Memory Entry

- Simplex/Normal shift

1. Press the VFO/M►V key to select the VFO mode.

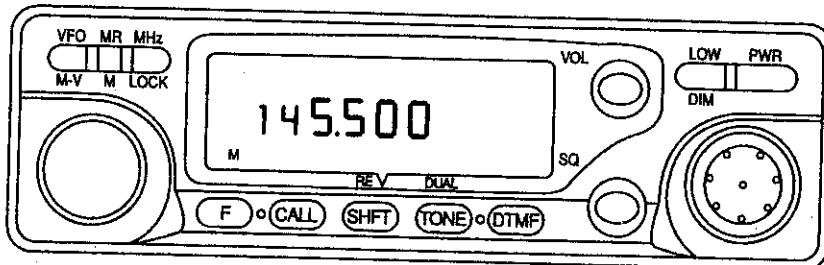

2. Select the desired operating frequency, offset, tone, frequency, etc.(For example 145.500MHz)

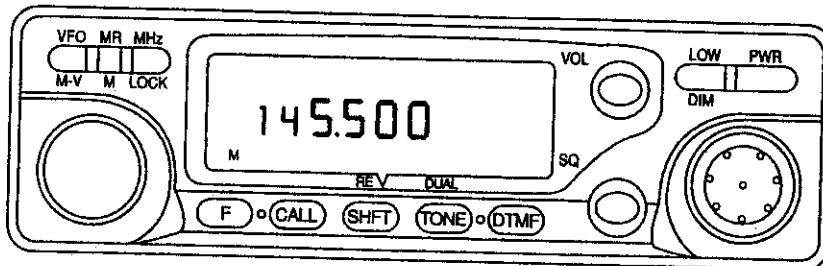

3. Press the F key. The F indicator and a memory channel indicator will light.(For example CH8)

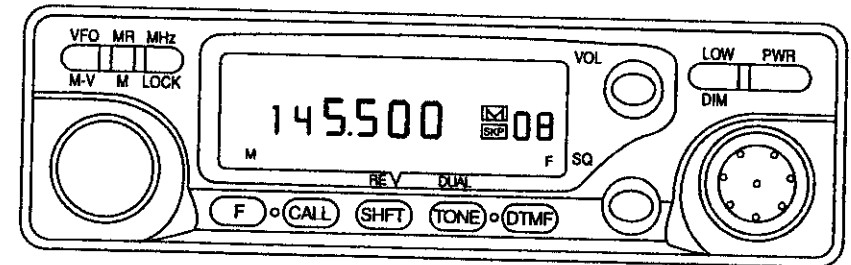

4. Select the desired Memory Channel using the Tuning Control or microphone UP/DN switches.(For example CH5)

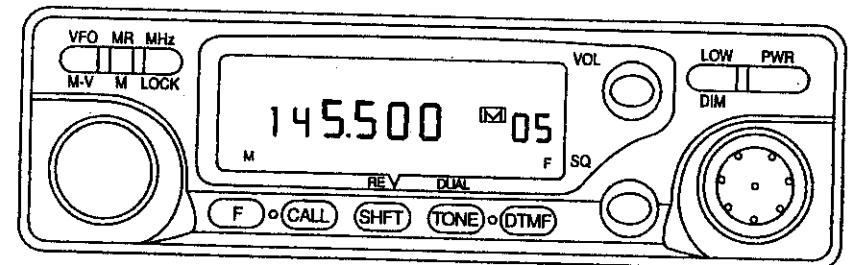

5. Press the MR/M key within 10 seconds of selecting the Memory Channel. A beep will sound and the F indicator and the Memory Channel number will turn on and the transceiver will change into Memory mode.

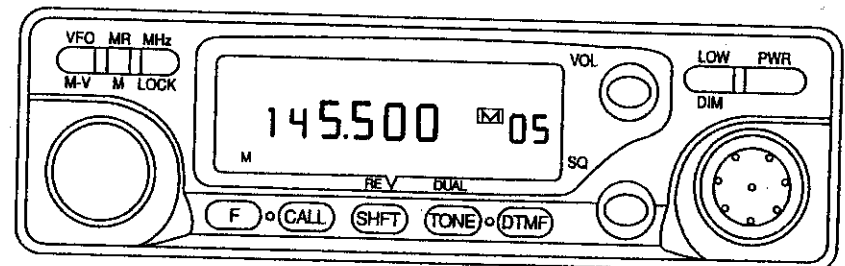

● CALL Channel

1. Select the desired operating frequency in VFO mode or the desired memory channel in memory channel mode, and be sure that PAG/C.SQ not activated.
2. Select the desired offset frequency, tone frequency, etc.
(For example 145.500 MHz in VFO mode)

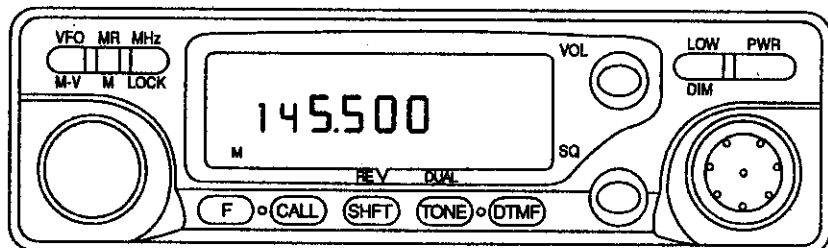

3. Press the F key. The F indicator and the memory channel indicator will light.(For example CH8)

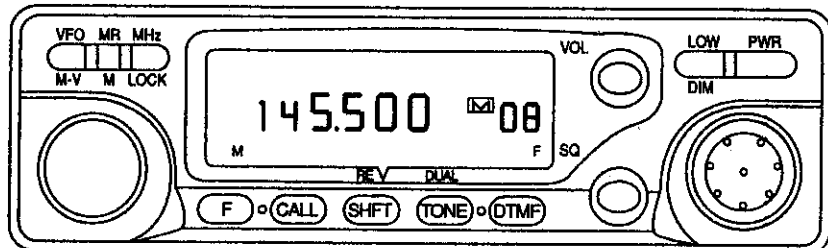

4. Press the CALL key within 10 seconds of pressing the F key. The F indicator and the Memory Channel number will turn OFF, to confirm data entry.

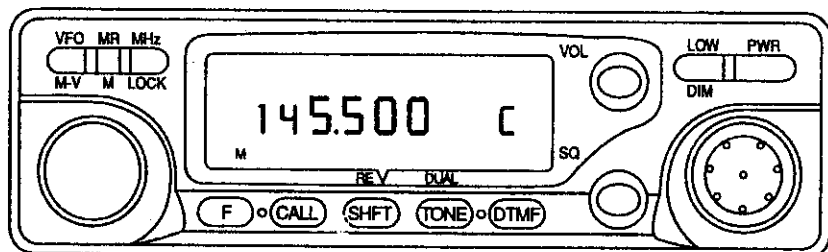

Note CALL channel entry operates only when PAG/C.SQ feature disabled.

5-4-6 Memory Channel Recall

1. Press the MR/M key.
2. Rotate the tuning control or press the microphone UP/DN switches to select the desired memory channel.

5-4-7 Memory Shift

This feature copies Memory channel or CALL channel data to the VFO. This will allow you to recall and alter these frequencies without changing the actual contents of the memory or CALL channel.

1. Press the MR/M key or CALL key.
2. Press the F key. The F indicator will light.
3. Press the VFO /M▶V key within 10 seconds of pressing the F key.
The F indicator and the Memory or CALL channel indicator will turn off to signal the data has been successfully transferred to the VFO.

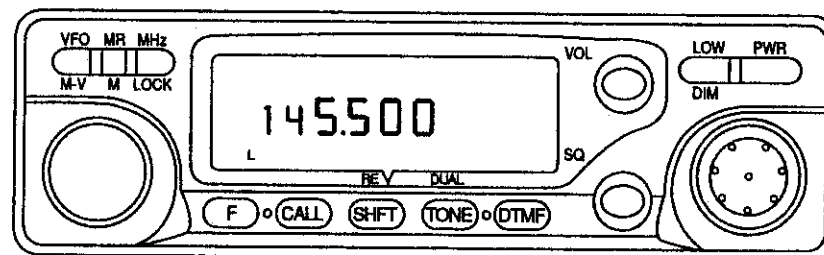

5-4-8 Memory Channel Clear

1. Enter the memory channel recall mode and select the desired memory channel.
2. Press the Power Switch to turn off the transceiver.
3. Press and hold the MHz key and turn on the transceiver. Release the MHz key, the confirmation message will appear on the display.
4. Press MR/M key in 5 seconds, the contents of the selected memory channel are erased.

Note Memory channel 1 cannot be cleared.

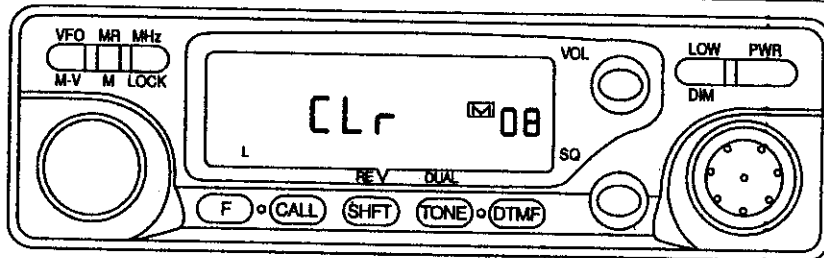

5-5 SCAN

When the scan function is turned on the SCAN indicator will light to indicate the scanning mode.

5-5-1 Scan Operation

The following scan options are available:

1. Band scan

Scan proceeds over the entire band (This function operates in the VFO mode only).

2. Programmable band scan

The scan frequency range is determined by the frequencies stored in Memory Channels 11 and 12 (This function operates in the VFO mode only).

3. Memory channel scan

Scan proceeds through those memory channels that actually have data entered and have not been locked out (This function operates in the Memory Channel mode only)

Notes

1. During scanning, the CTCSS/DCS/PAG/C.SQ operation is still on if any of them is activated.
2. During scanning, transmitting is allowed. When PTT released, transceiver will wait answering for 4 seconds and then start scanning again.

5-5-2 Hold/Resume Programming

The transceiver will stop on a busy channel.

Two type of scan hold/resume have been provided in this transceiver.

● Time operated scan(pause scan)

Scan will resume approximately 3 seconds after stop even if the station is still present.

● Carrier operated scan (Busy scan)

Scan will hold as long as the signal is present, and will resume scan 3 seconds after signal drop out.

This transceiver is delivered from the factory in the time operated scan mode. To switch between the two modes use the following procedure.

1. Press the F key for longer than 1 second. The F indicator will flash.
2. Within 10 seconds of pressing the F key. This will toggle the Scan/Resume mode to carrier operated mode. And B indicator will be on.
3. To return to time operated mode repeat steps 1 and 2.

5-5-3 Band Scan

1. Press the VFO/M▶V key to select the VFO mode.
2. Adjust the SQ control to the threshold point.
3. Press and hold the VFO/M▶V key for longer than 1 second.

The SCAN indicator will turn on as a visual reminder then transceiver is scanning.

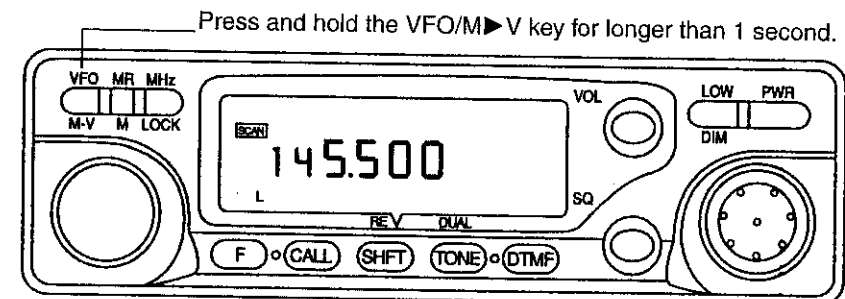

4. You can reverse the direction by rotating the tuning control counterclockwise, or by pressing the microphone UP/DN switch. The scan step size depends upon the current step programming.
5. Scan will stop whenever a signal is received (that activates the BUSY indicator) for a limited time.
6. Press any front panel key except LOW key to stop scanning.

5-5-4 Programmable Band Scan

1. Press the F key for longer than 1 second and then pressing the CALL key to turn ON/OFF the programming scan mode.
2. The lower scan limit must be stored in memory channel 11. The higher scan limit must be stored in memory channel 12.

Note

If the frequency in memory Channel 11 is equal to or greater than the frequency stored in Memory channel 12 scan will proceed over the entire band "Band Scan".

3. Adjust the SQ control to the threshold point.
4. Press the VFO/M►V key to select the VFO mode.
5. Select a VFO frequency between the two programmed scan limits.
6. Press and hold the VFO/M►V key for longer than 1 second.

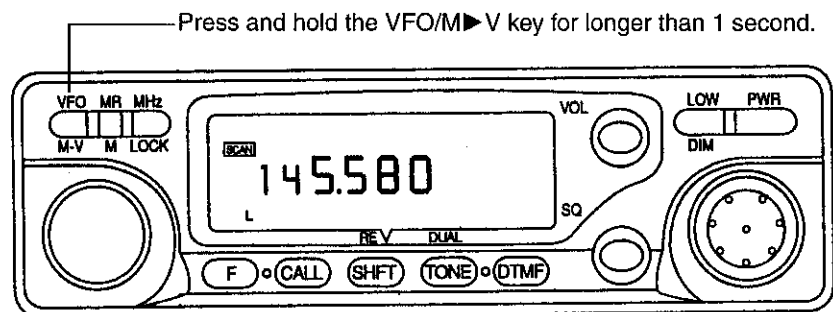

7. You can reverse the direction by rotating the tuning control counterclockwise, or by pressing the microphone UP/DN switch.
8. Scan will stop whenever a signal is received (that activates the BUSY indicator) for a limited time.
9. Press any front panel key except LOW key to stop scanning.

5-5-5 Memory Channel Scan

1. Adjust the SQ control to the threshold point.
2. Press and hold the MR/M key for longer than 1 second. The SCAN indicator will turn on as a visual reminder the transceiver is scanning.

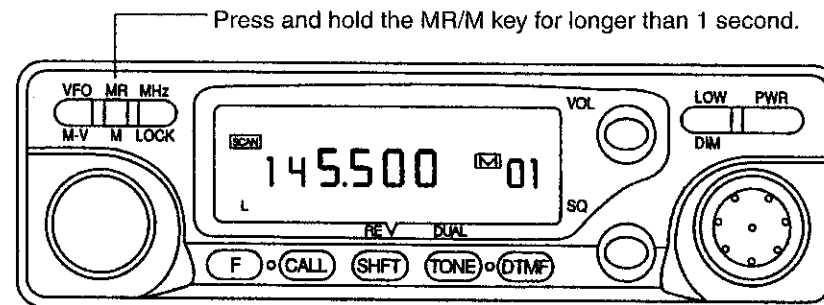

Notes

1. The transceiver will not scan if there is only one memory channel.
 2. The transceiver will skip any lock-out channel.
 3. The transceiver will scan only the memory channels in which frequencies have been stored.
3. Scan will scan at the current memory channel and proceed sequentially i.e. M1 → M2 → M3 → etc. Only those memory channels with data entered are scanned.

4. Scan will stop whenever a signal is received (that activates the BUSY indicator) for a limited time.
5. Press any front panel key except LOW key to stop scanning.

5-5-6 Memory Channel Lockout

The Memory Channel Lockout function allows you to temporarily skip unwanted Memory Channel during Memory Channel scan.

1. Select the MR/M key to select the Memory Channel mode.
2. Select the Memory Channel that you wish to skip by using the Tuning control or the microphone UP/DN switches.
3. Press the F key for longer than 1 second. The F indicator will flash. Within 10 seconds of pressing the F key press the MR/M key. A "SKP" will appear to the left of the Memory Channel number. This indicates the Memory Channel will be skipped during the Memory Channel scan operation.

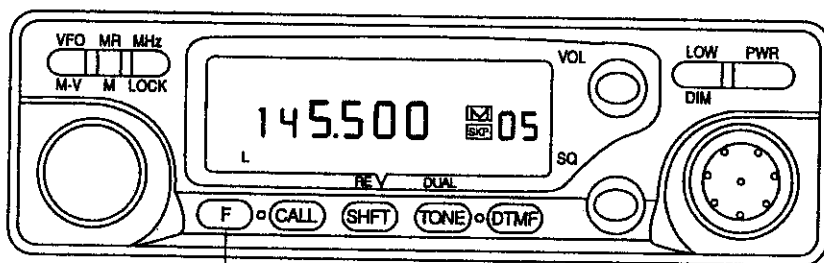

4. Repeat steps 2 and 3 to lock out any other Memory Channel that you want to skip.
5. To cancel the lockout, select the desired Memory Channel as described in step 1,2, and 3 above. The "SKP" will go out. The Memory Channel will now be scanned normally.

5-6 DUAL-WATCH OPERATION

This function allows you to watch two different frequencies. The transceiver is capable of following types of Dual-watch operation.

- (1) Listen on the dial-frequency and the memory frequency under M1.
- (2) Listen on the dial-frequency and one of the memory frequencies.
- (3) Listen on the dial-frequency and a memory frequency under scanning.

Information

- The word "DUAL" is indicated on the display during Dual-watch operation.
- The dial-frequency can be changed during dual-watch operation.
- During dual-watch operation, the Transceiver listens on a memory frequency once every three seconds and instantaneously displays its frequency.
- Dual-watch operation pauses while the memory frequency is being received.
- When a signal is received on the dial-frequency during dual-watch operation, the signal will be heard interruptedly as the transceiver leave the dial-frequency once every three seconds.
- Rotate the squelch control full counterclockwise to pause the Dual-watch operation with the memory frequency to listen.
- Press the VFO/MR key will release the Dual-watch mode.

NOTES:

- (1) During dual-watch operation, transmission is only available at the dial-frequency.
- (2) Press the PTT button to transmit. The dial-frequency is displayed and you can transmit at the dial-frequency. Release the PTT button to return to dual-watch.
- (3) When a signal is received at the memory frequency, release the dual-watch operation and recall the memory frequency for communication.
- (4) During dual-watch operation, the CTCSS/DCS/PAG/C.SQ operation is still on if any of them is activated.

5-6-1 Dual-watch on the dial-frequency and the memory frequency under CH1.

1. Press the VFO/M►V key to select the VFO mode.
2. Press the F key momentarily. The F indicator should light in the display.
3. Press the TONE/DUAL key within 10 seconds of pressing the F key. A "DUAL" will appear on the display to indicate the Dual-watch operation.

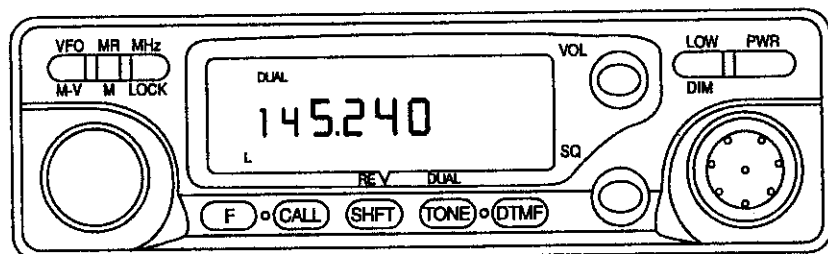

5-6-2 Dual-watch on the dial-frequency and a memory frequency.(or call frequency)

1. Recall a memory frequency you wish to use in the dual-watch function.
2. Press the F key momentarily. The F indicator should light in the display.
3. Press the TONE/DUAL key within 10 seconds of pressing the F key. A "DUAL" will appear on the display to indicate the Dual-watch operation.
4. The display will alternately indicate the dial frequency and a selected memory frequency.

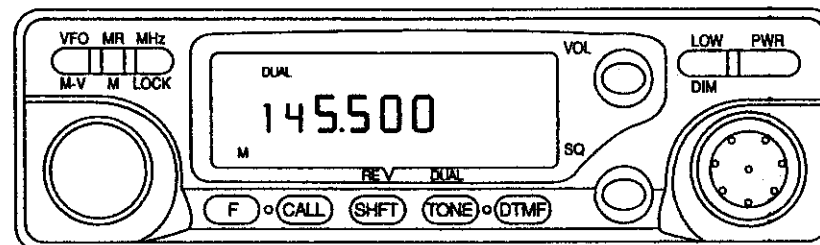

5-6-3 Dual-watch on the dial-frequency and a memory frequency under scanning in sequence

1. Press and hold the MR/M key for longer than 1 second. The SCAN indicator will turn on as a visual reminder the transceiver is scanning.

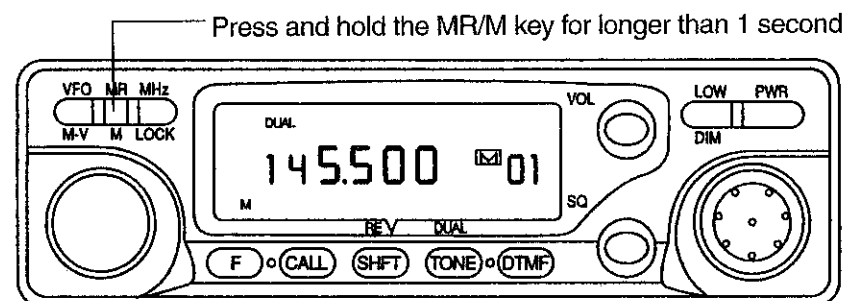

2. Press the **PWR** switch to turn OFF the transceiver.
3. Press and hold the TONE/DUAL key and turn on the **PWR** switch.
4. Release the TONE/DUAL key, A "DUAL" will appear on the display to indicate the Dual-watch operation.
The display will sequentially indicate the dial-frequency and the memory frequencies under scanning one by one.

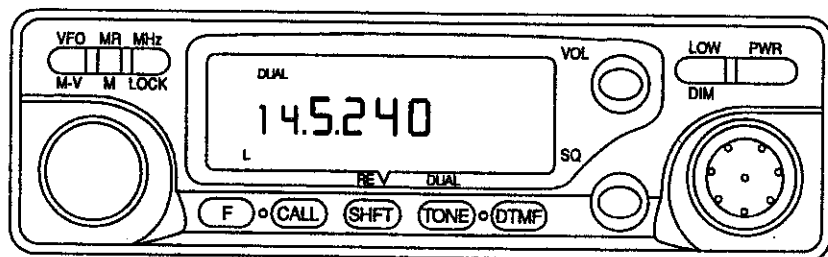

5-7 REPEATER OPERATION

5-7-1 Transmitter Offset

All radio repeaters utilize a separate receive and transmit frequency. The receive frequency may be either above or below that of the transmit frequency. The initial offset frequency is shown as below:

	AR-147	AR-247	AR-447
+	+600kHz	+1.6MHz	+5MHz
-	-600kHz	-1.6MHz	-5MHz

Offset Feature

To select the desired transmitter offset feature press the SHFT/REV key. Each time you press the key the transceiver will advance from one feature to the next.

No indicator → "-" "T." → "+" "T." → "-" "+" "T."
 (Simplex) (automatic repeater offset)

To select the desired offset frequency use the following procedures:

1. Press the VFO/M▶V key to select the VFO mode.

2. Press the F key for longer than 1 second. The F indicator will begin to flash. Press the VFO/M▶V key within 10 seconds of pressing the F key. The current offset frequency will be shown on the display.

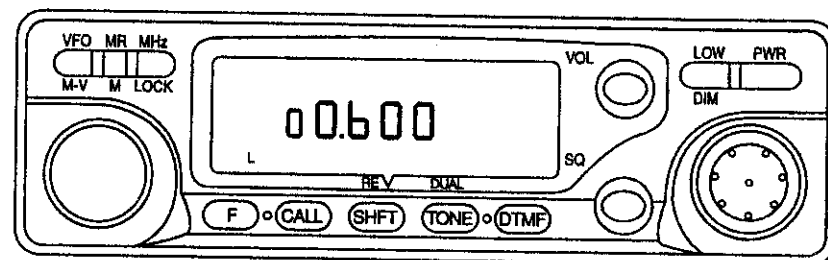

3. Rotate the tuning control or press the microphone UP/DN switches to select the desired offset frequency.
 4. Press the VFO/M▶V key to select the VFO mode.

5-7-2 Automatic Repeater Offset

This function automatically selects an appropriate offset direction and offset frequency according to the operating frequency that you select. The transceiver is programmed for offset direction as shown below.

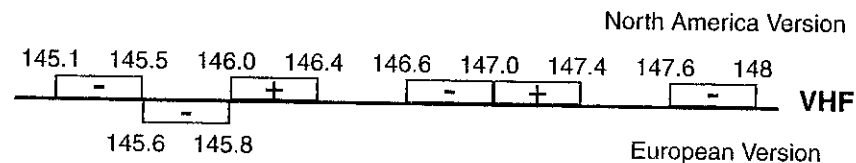

In the automatic repeater offset mode, when the operating frequency falls in the simplex band, the indicators "-" and "+" will light on still. When in minus offset direction band, the indicator "-" flashes. When in plus offset direction band, the indicator "+" flashes also.

Note

The offset frequency and automatic repeater band could be programmable by factory or dealer/service center.

5-7-3 Reverse Function

Some repeaters utilize a " Reverse Pair ", i.e, the transmit/receive frequencies are exactly the reverse of another repeater. For example repeater A uses 146.000 for a transmit frequency (INPUT) and 146.000 for a receiver frequency (OUTPUT). Repeater B might use 146.00 for a receiver frequency. It would be inconvenient to have to reprogram the transceiver each time you use these repeaters.

Press F key momentarily. The F indicator should light in the display.

Press the SHFT/REV key within 10 seconds of pressing the F key.

The REV function is active.

To return to normal press the SHFT/REV key again. The REV indicator will be turned off.

This function is also useful to check the input frequency of the repeater so that you can determine if you are within range for simplex communications.

5-7-4 Tone Operation

Some repeaters require the use of a control signal to activate the repeater. Several different methods are currently in use.

Sub-audible tones are sometimes used. The transceiver provides two types of subaudible tone, CTCSS and DCS. There are 50 selectable CTCSS tones and 106 selectable DCS codes for users.

A repeater access tone is also used in transmit. Press and hold the PTT key to transmit, then press the microphone CALL key will generate a repeater access tone. During the repeater access tone being transmitted, the CTCSS/DCS sub-audible tone is muted.

Repeater Access Tone Selection

1. Press the F key for longer than 1 second when the transceiver not in CTCSS/DCS mode, then press the TONE/DUAL key within 10 seconds. The current repeater access tone will show on the display.
2. Rotate the tuning control or press the microphone UP/DN switches to select the desired repeater access tone (1450,1750 or 2100 Hz)
3. Press any front panel key to return to the normal display.

5-7-5 CTCSS Tone Selection

1. Press the F key for longer than 1 second when the transceiver in CTCSS mode. The F indicator will begin to flash. Press the TONE/DUAL key within 10 seconds of pressing the F key. The current CTCSS tone frequency will show on the display.

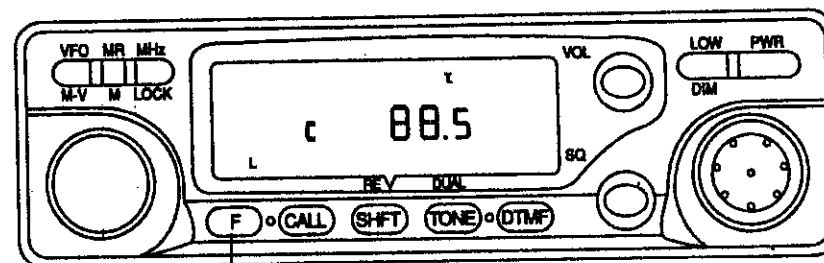

Press the key for longer than 1 second.

2. Rotate the Tuning control or press the microphone UP/DN switches to select the desired CTCSS tone frequency.
3. Press any front panel key to return to the normal frequency display.

CTCSS TONE FREQUENCY(Hz)

67.0	103.5	159.8	199.5
69.3	107.2	162.2	203.5
71.9	110.9	165.5	206.5
74.4	114.8	167.9	210.7
77.0	118.8	171.3	218.1
79.7	123.0	173.8	225.7
82.5	127.3	177.3	229.1
85.4	131.8	179.9	233.6
88.5	136.5	183.5	241.8
91.5	141.3	186.2	250.3
94.8	146.2	189.9	254.1
97.4	151.4	192.8	
100.0	156.7	196.6	

5-7-6 DCS Code Selection

1. Press the F key for longer than 1 second when the transceiver in DCS mode, then press the TONE/DUAL key within 10 seconds. The current DCS code will show on the display.

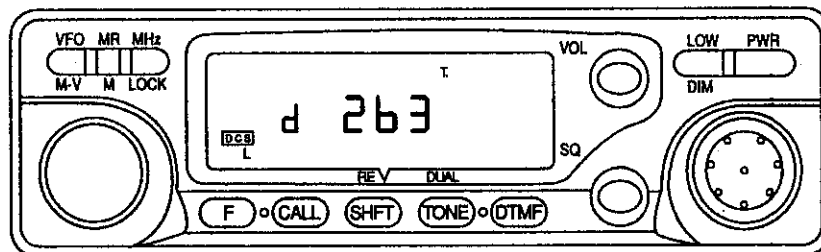

2. Rotate the tuning control or press microphone UP/DN switches to select the desired DCS code.
3. Press any front panel key to the normal display.

DCS CODE TABLE(The bracketed code is inverse code)

017	(050)	152	(115)	325	(526)	523	(246)
023	(047)	155	(731)	331	(465)	526	(325)
025	(244)	156	(265)	332	(455)	532	(343)
026	(464)	162	(503)	343	(532)	546	(132)
031	(627)	165	(251)	346	(612)	565	(703)
032	(051)	172	(036)	351	(243)	606	(631)
036	(172)	174	(074)	356	(212)	612	(346)
043	(445)	205	(263)	364	(131)	624	(632)
047	(023)	212	(356)	365	(125)	627	(031)
050	(017)	223	(134)	371	(734)	631	(606)
051	(032)	225	(122)	411	(226)	632	(624)
053	(452)	226	(411)	412	(143)	654	(743)
054	(413)	243	(351)	413	(054)	662	(466)
065	(271)	244	(025)	423	(315)	664	(311)
071	(306)	245	(072)	431	(723)	703	(565)
072	(245)	246	(523)	432	(516)	712	(114)
073	(506)	251	(165)	445	(043)	723	(431)
074	(174)	252	(462)	446	(255)	731	(155)
114	(712)	255	(446)	452	(053)	732	(261)
115	(152)	261	(732)	454	(266)	734	(371)
116	(754)	263	(205)	455	(332)	743	(654)
122	(225)	265	(156)	462	(252)	754	(116)
125	(365)	266	(454)	464	(026)		
131	(364)	271	(065)	465	(331)		
132	(546)	274	(145)	466	(662)		
134	(223)	306	(071)	503	(162)		
143	(412)	311	(664)	506	(073)		
145	(274)	315	(423)	516	(432)		

DCS Code Polarity Selection

Because DCS code is a 23-bits continuous string of logic 1 and 0, when the DCS signal through the Tx or Rx path, the polarity of the DCS signal changes probably on other transceivers. The polarity-inversed DCS signal is just mapping to a specified DCS code as listed in the DCS code table.

In the DCS encoding/decoding mode, in order to avoid the confusion of signal polarity, the DCS encoding/decoding polarity could be changed.

1. Press the F key longer than 1 second when the transceiver in DCS mode, then press the SHFT/REV key longer than 1 second within 10 seconds. The current DCS signal polarity will show on the display.
2. Rotate the tuning control or press the microphone UP/DN switches to select the desired polarity.
3. Press any front panel key to return to the normal display.

5-8 CTCSS/DCS Feature Selection

When CTCSS/DCS function has been activated, the radio will not open squelch until the proper tone is received.

Press the TONE/DUAL key and select the desired Tone mode. When the T. indicator appears on the display, the transmitter will transmit the desired tone. When the T.SQ indicator appears in the display the transceiver will transmit the desired tone and operate in the Tone Squelch mode, i.e. squelch will not open until the same tone is received as a portion of the incoming signal. When no indicator is displayed on the radio there will be no tone squelch control.

No indicator → T. → T.SQ → DCS T. → DCS T.SQ



CTCSS Tone/DCS Code Scan

When using CTCSS/DCS encoding and decoding function, you can have the transceiver scan through the tones or codes to determine which one is present on a received signal. During CTCSS TONE/DCS scan, the PAG/C.SQ feature is disabled.

1. Let the transceiver enter CTCSS/DCS encoding and decoding mode.
2. Press F key longer than 1 second, then press TONE key longer than 1 second within 10 seconds. The CTCSS TONE/DCS CODE scan starts and the SCAN indicator is illustrated on the display.
3. CTCSS TONE/DCS CODE scan can activate only when the carrier exits in current channel, and stop when the scanned tone/code is received. The scanned CTCSS TONE/DCS CODE will be illustrated on the display.
4. Press any front panel key to return to the normal display, and the transceiver exits the CTCSS TONE/DCS CODE scan mode. As 5-7-5/5-7-6 described, you could save the scanned CTCSS TONE/DCS CODE in memory.

Note

If you press the PTT key to transmit when the sub-audible signal scanned, this scanned signal will be saved to memory automatically.

5-9 C.SQ(CODE Squelch System) OPERATION[Requires optional DTS147]

This function allows squelch to be turned on in the receive mode on reception of a three-digit code matching the C.SQ code selected in your radio.

Once squelch is turn on by reception of a matching code, it operates normally from then on. If no signal is received for longer than 3 seconds, squelch is turned off until a matching code is again received.



5-9-1 Selecting and Storing the C,SQ code

C.SQ code from 000 through 999 can be selected from the VFO mode and stored in memory channel.

5-9-2 C.SQ Code Selection

When DTMF unit DTF147 [option] is installed, the initial setting is 000.

● Selecting and Storing the C.SQ code with the VFO

1. Press the DTMF key twice to light the C,SQ indicator.
2. Press the F key, then press the DTMF key while the F indicator is on in 10 seconds. The first digit of the C.SQ code will flash.

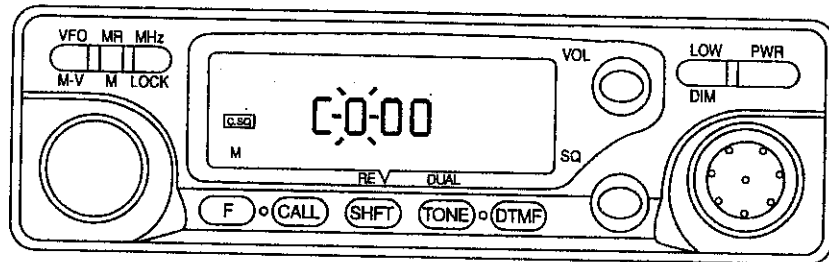

3. Select the first digit by rotating the Tuning control.
4. Press the DTMF key. The first digit is registered and the second digit begins to flash.
5. Select the second digit by rotating the tuning control.
6. Press the DTMF key. The second digit is registered and the third digit begins to flash.
7. Select the third digit by rotating the Tuning control.
8. Press the F key and the complete C.SQ code is registered. The mode returns to the previous one.

● Selecting and Storing a code with the DTMF KEY PAD (MIC 147 D)

1. Press the DTMF key twice to light the C,SQ indicator.
2. Press the F key, then press the DTMF key while the F indicator is on in 10 seconds. The C.SQ code setting mode will be entered and the first digit of the code will flash.
3. Then enter a three-digit number on the key pad.

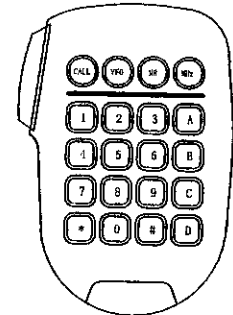
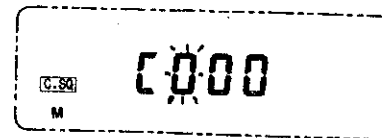

Notes

1. If a key other than the DTMF key on the front panel is pressed during operation, code selection mode is canceled.
2. If no action is taken for longer than 10 seconds, code selection mode is automatically canceled.
3. If the optional DTF 147 is not installed, a Bu-sound will be generated each time you press the DTMF key.

5-9-3 Using PAG/C.SQ Function

1. Adjust the SQL control to the threshold point.
2. Press the DTMF key. The C.SQ indicator will light. Each time the DTMF key is pressed, the PAG and C.SQ functions will be selected:

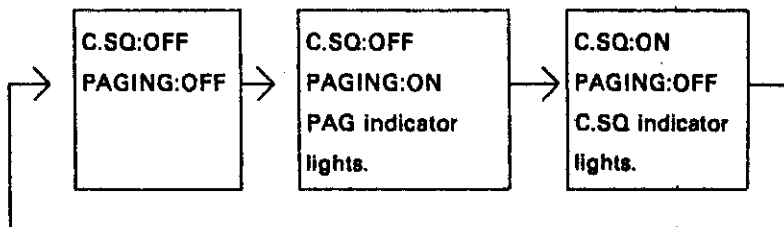

● **RECEPTION**

Squelch will open when the proper code is received.

● **TRANSMISSION SPEED**

The tone duration for each DTMF digit in transmission could be selected as 50 (default), 100, 150 or 200 msec.

1. Press F key then press CALL key for longer than 1 second within 10 seconds. The current DTMF code transmission speed will show on the display.
2. Rotate the tuning control or the UP/DN key on the microphone to select the desired DTMF Transmission speed.
3. Press any front panel key to return to normal display.

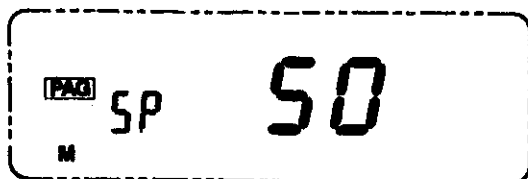

Note

Voice output is muted during PAG/C.SQ code output.

5-9-4 Using PAG/C.SQ with a repeater

The PAG/C.SQ signal is transmitted after a short delay if the PTT switch is pressed. This is to avoid any malfunction due to the PAG/C.SQ signal being interrupted by repeaters with long response time.

● **Transmit Delay during C.SQ or PAG output**

A delay is built in when the C.SQ or PAG code is sent out.

The initial setting is 450 ms, and can be changed to 750, 850 or 1000 ms.

● **Changing the delay time**

1. Turn PAG or C.SQ mode on,
2. To change delay time press the F key momentarily and then press the CALL key within the 10 seconds.

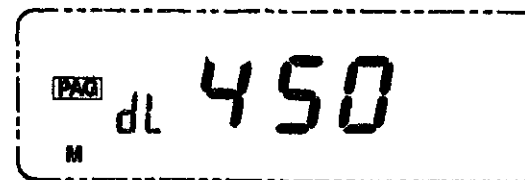

3. Display the desired delay time with the tuning control or the UP/DN key on the microphone.
The displayed delay time takes effect immediately. If any other key is pressed or if, after 10 seconds, no key has been pressed, the delay time setting mode is terminated.

5-10 PAGING

The paging function is available when the optional DTMF unit (DTF147) is installed.

The paging function is useful to call all station a group, a specific station, or wait for a call from another station by using DTMF (Dual Tone Multi Frequency) signaling.

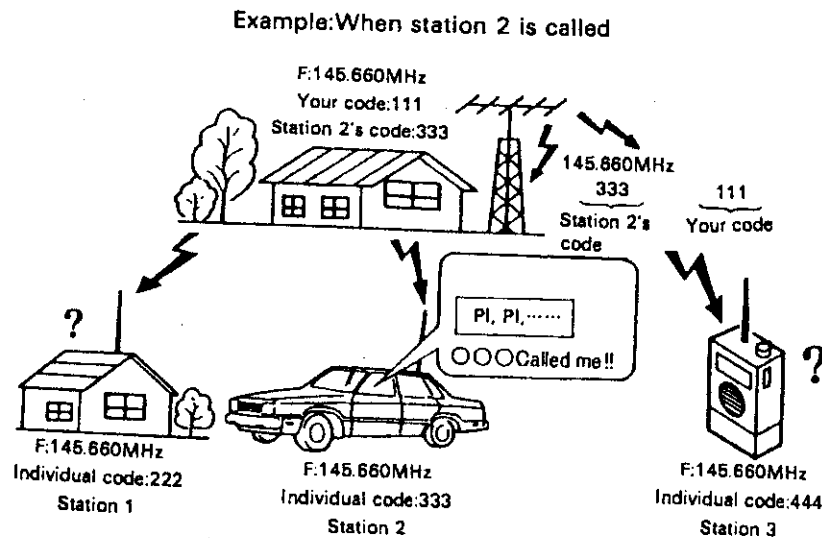

The common group code and individual codes should be determined in advance. These codes should be from 000 to 999 (3digits). Unlike C.SQ the code of the calling station is displayed on the receiver, so the receiver can identify the calling station.

When called by a local station, the individual code of the calling station is displayed. when called by a group code, that group code is displayed.

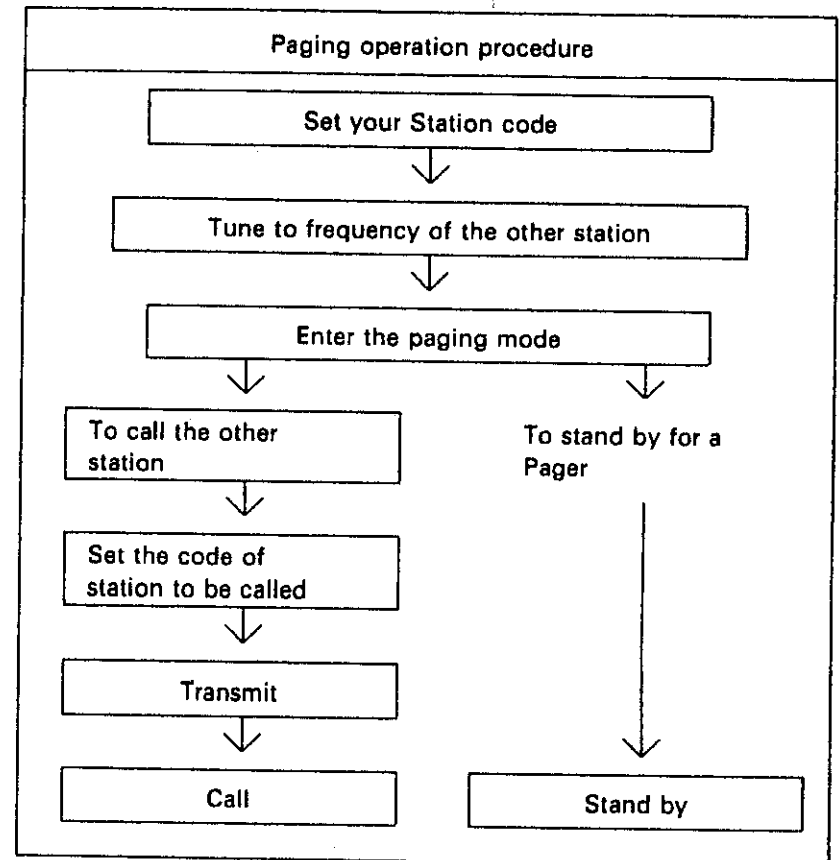

5-10-1 Paging Code Memories

There are five paging code memories.

	Use
PA	Stores your individual ID code in memory.
P0	Automatically stores the calling station's code during reception. Can temporarily set code for the station.
P1 ~ P3	Stores group codes and local station codes in memory.

5-10-2 Setting the Paging Codes

1. Press the DTMF key to enter the paging mode. The PAG indicator will light.
2. Press the F key, then press the DTMF key while the F indicator is on. The code setting mode will be entered and the memory channel indicator will flash.

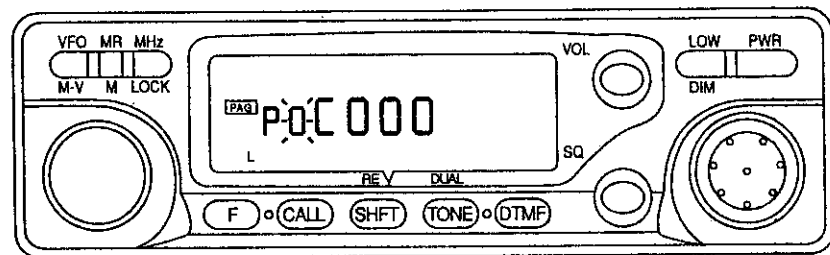

3. Set the desired memory (0 to 3 or A) with the tuning control (or key 0 to 3 or A on the microphone with DTMF keypad).
4. Press the DTMF key. The first digit will flash.
(This operation is not necessary if DTMF microphone is used)

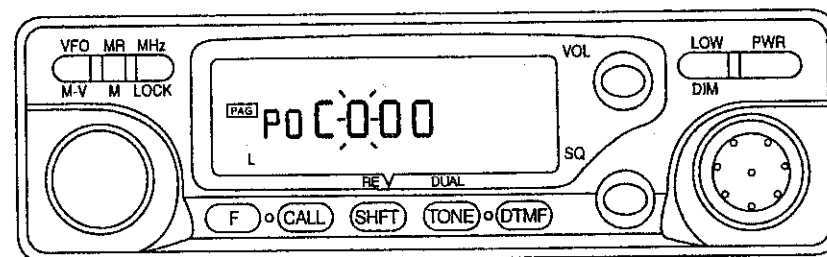

5. Set the desired number with the tuning control and press the DTMF key (or key 0 to 9 on the microphone with DTMF keypad). The first digit be set, and the second digit will flash.

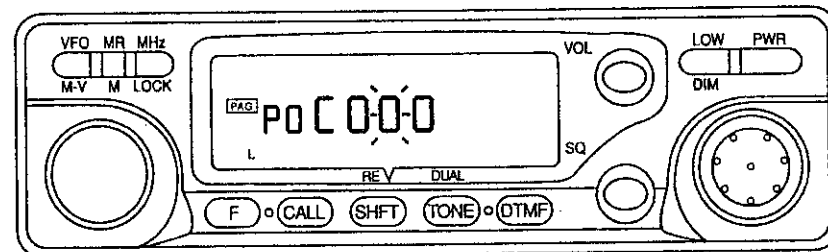

6. Set the second and third digits with the tuning control, and press the DTMF key.
7. If, after 10 seconds, no key has been pressed, or a key other than DTMF is pressed, the code will be set.

For example, the following groups communicate with each other.

Predetermined frequency	145.660MHz	
Your individual code		111
Station 1's individual code		222
Station 2's individual code		333
Station 3's individual code		444
Group code		789

Your memory
 PA 111
 P0
 P1
 P2 444
 P3 789

Station 1 memory
 PA 222
 P0
 P2 789

Station 2 memory
 PA 333
 P0
 P3 789

Station 3 memory
 PA 444
 P0
 P1 789
 P2 111

5-10-3 Paging Transmission (Calling)

Your individual ID code is preset in memory A. (Your individual ID code is always stored in memory A.)

1. Turn to the predetermined frequency.
2. Press the DTMF key to light the PAG indicator.

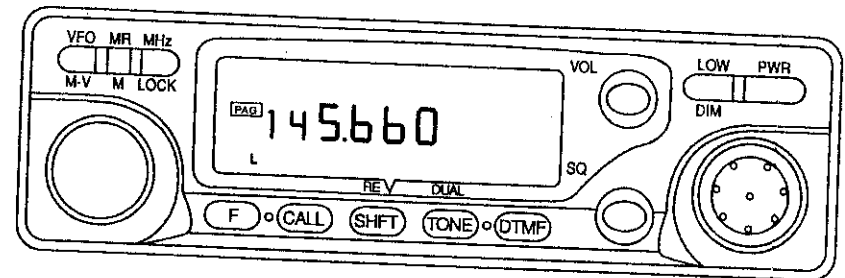

3. Press the F key, then press the DTMF key while the F indicator is on.

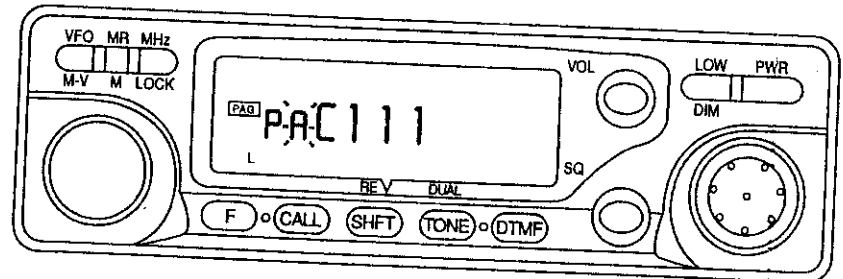

4. Select the memory number in which the local station code is stored using the tuning control. Turn the paging function of the other transceiver on.

Calling all station in the group

1. To call all station in the group, select the memory number in which the group code is stored. In this example, the number is stored in number P3.
2. Press the PTT key once or press a key other than DTMF to display the frequency again.
3. Press the PTT switch.

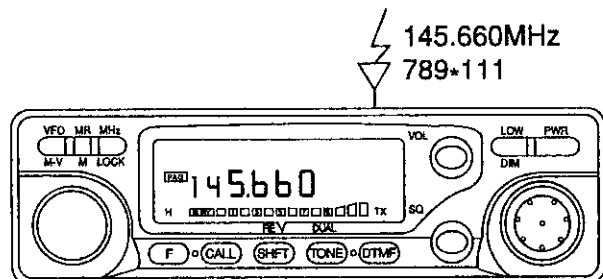

Group code 789 and your station ID code 111 are transmitted. A DTMF tone sounds is heard during transmitting.

Calling a specific station (Example: Call station 3.)

To call a specific station (for example, station 3), use the following procedure:

1. Select the memory in which the local station code is stored (in this example, select memory p2.) or Enter the individual code of the local station in memory 0.
2. Press a key other than DTMF key to display the frequency again.
3. Press the PTT switch.

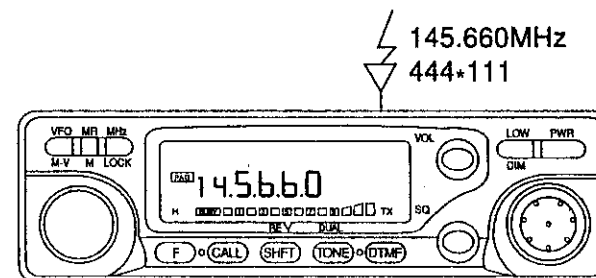

Local station code 444 and your station ID code 111 are transmitted. A DTMF tone sounds is heard during transmitting.

5-10-4 Paging Reception (Stand by)

1. Turn to the predetermined frequency.
2. Press the DTMF key to light the PAG indicator.

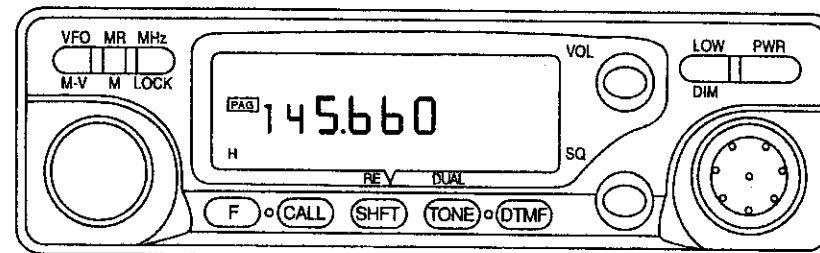

Stand by with individual code (Example: Stand by for station 3.)

- When called with your station ID code, the memory number automatically changes to 0. The ID code of the number 3 is displayed.

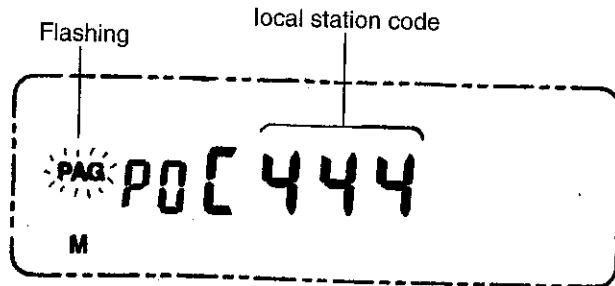

- The squelch is opened.
- The individual code of the calling station is stored in memory 0. Press the PTT switch to respond to the calling station.

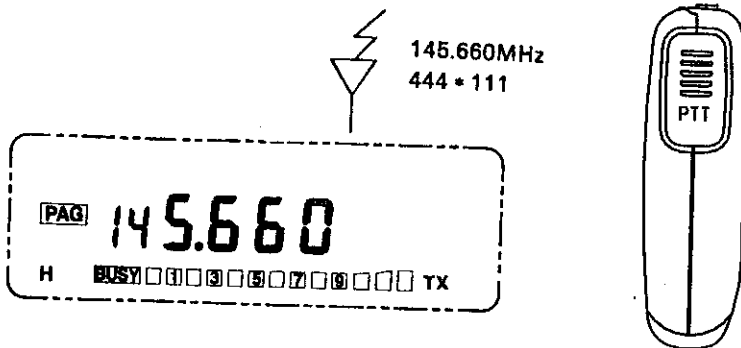

When the transmission ends, the frequency will be displayed again. After the local station has been contacted, cancel paging mode. Communication can be performed more efficiently.

If the local station code can not be decoded, " Err " appears on the display.

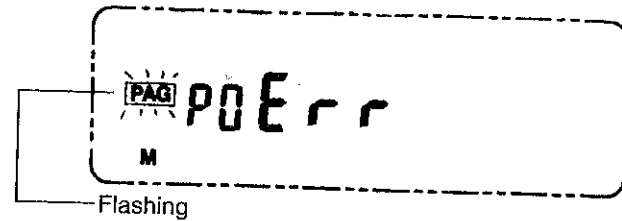

Stand by with group code

- When a call is received with the group code, the squelches of all the members of the group are opened to enable reception. When you are called with the group code, the common group code and its memory channel number are displayed. (Example: Group code 789 is stored in channel 3.)

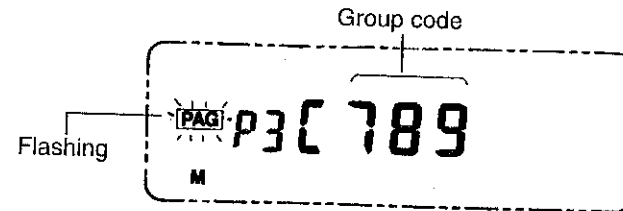

- When the PTT switch is pressed, group code 789 (as displayed) and your station ID code are transmitted. You can participate in the group-round table.
- After the remote station has been called, cancel paging mode. Communication can be performed more efficiently.

5-10-5 Code Lockout

If an individual code is stored in P1, P2 or P3, reception is enabled when the codes match, even if one local station communicates with another. To use memories P1 to P3 for transmission only, lock out the memories. When you are communicating with two or more groups having the same frequency, lock out the group code with which stand by is temporarily stopped.

● Paging memory lockout

1. Enter the code setting mode and display the number (except memory 0 and A) to be locked out using the tuning control.
2. Press the MR/M key.
SKP mark lights and the memory is locked out.

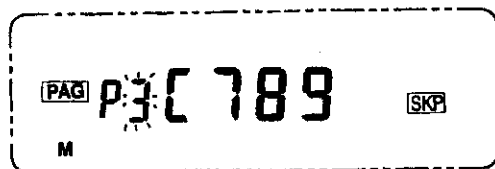

3. To cancel, repeat step 1 and 2.

5-11 DTMF CODE DECODING FUNCTION

The DTMF Code Decoding Function is available when the optional DTMF UNIT (DTF147) is installed.

The Decoding Function is useful to display the receiving DTMF signal on the LCD with 16 Digits Maximum.

5-11-1 Setting the CODE decoding mode

1. Press the DTMF key to return to normal mode.(turn off the PAG, C.SQ)
2. Press the F key . The F indicator will light.
3. Press the DTMF key within 10 seconds. It will enter into the DTMF code decoding mode.

The left 2 small digits represents the position no. of the first decoded DTMF code displayed on the right of LCD.

The right 4 big digits represents the lasted decoded DTMF codes.

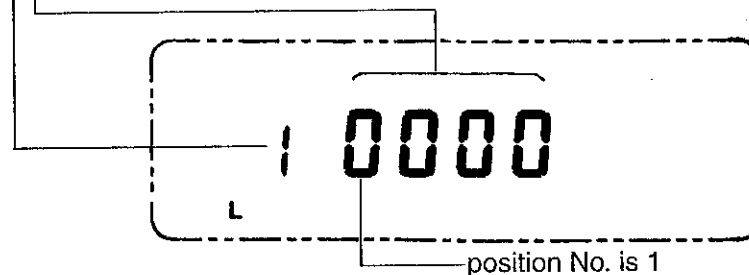

4. You can rotate the tuning control or press the microphone UP/DN switches to select the desired DTMF code position.

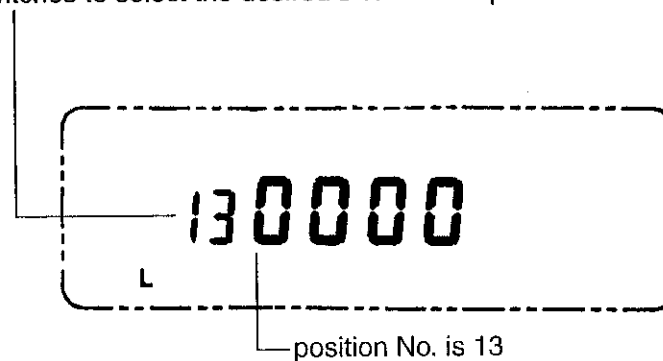

5. Or you can press the MHz/LOCK or the microphone MHz key to clear the decoded of DTMF codes.

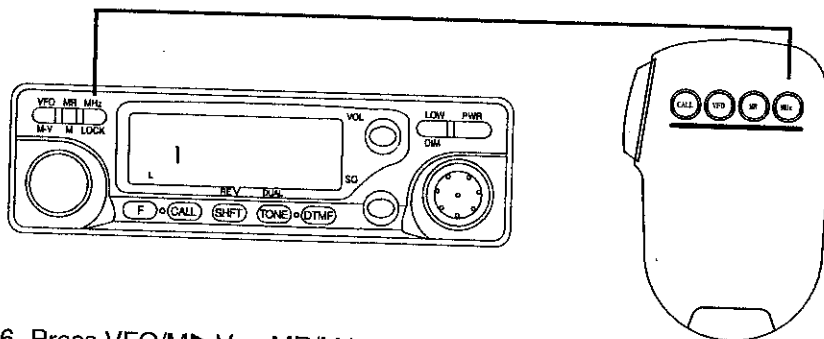

6. Press VFO/M▶V or MR/M key to return to the normal frequency mode.

5-11-2 Store the CODE Memory

You can keep the decoded code even when you power-on next time if necessary.

The procedure is :

Press MR/M key to store the code and a long BI-sound will be generated.

5-12 DTMF AUTODIALER OPERATION

The DTMF Autodialer Operation is available when the optional DTMF unit (DTF147) is installed. DTMF Autodialer memories could be used for remote DTMF control sequence or telephone numbers for repeater or personal autopatch systems.

9 autodial memories store DTMF tone sequences of up to 16 digits each.

Press the F key and than press DTMF key for longer than 1 second within 10 seconds, the DTMF Autodialer operation will switch between ON and OFF indicated by the telephone icon on the display.

DTMF Autodial Memory Setting

When the DTMF Autodialer operation turn on, the display will show as follows.(Autodial Memory 1, empty)

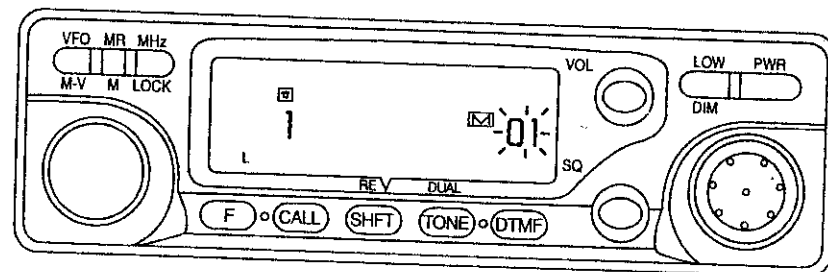

1. Rotate the tuning control or press microphone UP/DN key to select the desired autodial memory.
2. Press the MHz key, then the DTMF sequence is reset. key the 16 digits on the microphone to set the desired number.
3. Press the DTMF key, with rotating tuning control or pressing the UP/DN key on microphone, you can check the DTMF sequence alternatively.
4. Press any other front panel key, the transceiver will return to normal display.

Send DTMF Autodial Sequence

1. Turn the transceiver to DTMF autodialer operation.
2. Press the PTT key, the transceiver goes to transmission mode.
3. In transmission mode, press the VFO key on microphone. The display will show the current autodial memory number and the first 4 DTMF codes.
4. Press the UP/DN key on microphone to select the desired autodial memory, then press the VFO key on microphone again, the DTMF sequence will be sent out .

5-13 DTMF REDIALER OPERATION

The DTMF Redialer Operation is available when the optional DTMF unit (DTF147) is installed and the DTMF Autodialer operation is disabled (the telephone icon disappears on display).

The DTMF sequence sent last time in transmission will be sent again by activating the DTMF Redialer operation.

1. Turn the transceiver to leave DTMF Autodialer operation (the telephone icon will disappear on display).
2. Press the PTT key, the transceiver goes to transmission mode.
3. In transmission mode, press the VFO key on microphone, the DTMF sequence sent during last transmission will be sent again.

5-14 KEYPAD DIRECT FREQUENCY ENTRY

The operating frequency could be selected by entering numbers directly from DTMF microphone when the optional DTMF unit DTF147 is installed.

1. Press VFO key to enter VFO mode.
2. Press MHz key to start 1 MHz step frequency tuning.
3. Use the microphone keypad to enter the desired frequency.
Enter the digits in order from the most significant digit down to the least significant one.
4. If the number entered is other than 0 ~ 9, the bu-sound is generated, and the number is inhibited to be entered. The out-of-band entered frequency is also inhibited.
5. The entered frequency will be automatically modified for the least significant digits to match the current frequency step.

5-14 APO (Automatic Power Off)

The automatic power-off function turns the power off automatically if you forget to turn off your radio.

The initial setting is OFF.

1. To turn the APO function off and on, press the F key for longer than 1 second, then MHz/LOCK key within 10 seconds. The APO indicator lights.
2. If, after the 30 minutes in inactive receive mode, no key has been pressed, the APO indicator flashes and a beep sounds. After that, all the functions are disabled, and the transceiver enters the automatic power-off state.

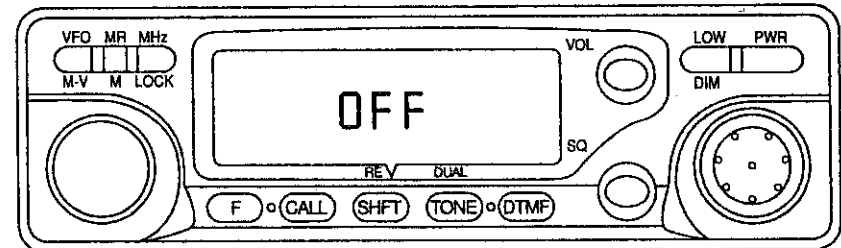

3. To leave the automatic power-off state, turn the power switch off and on again.

Note

A small current flows during the automatically power off state. If the transceiver is not going to be used, be sure to switch the power off.

5-15 DIM(Dimmer)

The intensity of illumination can be set to be one of four levels.

1. Press the F key, then press the LOW/DIM key while the F indicator lights.

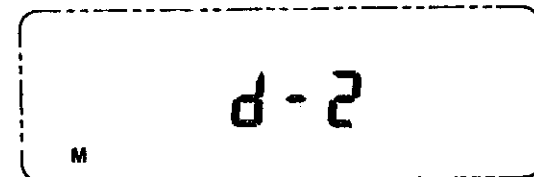

2. Select the desired value with the tuning control or the UP/DN key on the microphone.
3. If, after 10 seconds, no key has been pressed, the displayed level is set and the original frequency is redisplayed.

5-16 BEEP

The beep can be turned on and off.

Press the F key for longer than 1 second, then press the DTMF key while the F indicator is flashing. Each time this is done, the beep is turned on and off.

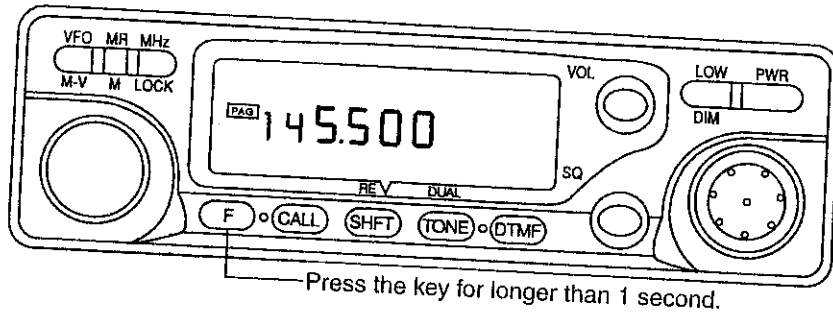

5-17 LOCK

There are two types of lock functions.

① Microphone key lock

When the switch on the rear of the microphone is set to the LOCK position, all the microphone keys except the PTT key are disabled.

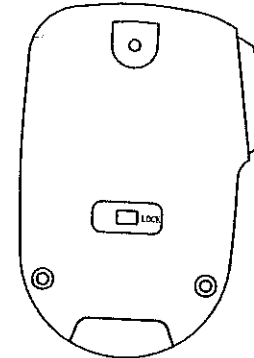

② LOCK

The panel keys (except F and MHz/LOCK and LOW key) and the tuning control are disabled. However, the microphone function works. Press the F key, then press the MHz/LOCK key within 10 seconds. The LOCK indicator lights.

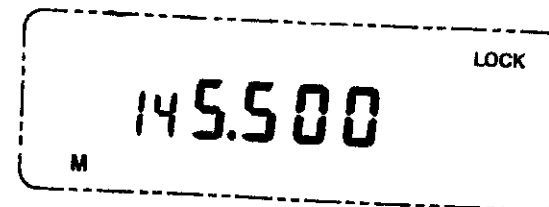

To release the lock, press the F key again, then press the MHz/LOCK key within 10 seconds.

5-18 CHANNEL DISPLAY

The frequency display can be changed to channel number display. CH01 is memory channel 1, CH02 is memory channel 2, etc.

5-18-1 Channel display mode

1. Press the MR/M key to select the Memory channel mode.
2. Turn OFF the Transceiver by pressing the POWER switch.
3. Press both the PTT and CALL key of microphone, press the MHz/LOCK and hold these 3 keys depressed while turn ON the transceiver.
4. The LCD will display " PASS " to indicate entering into the CH mode successfully.

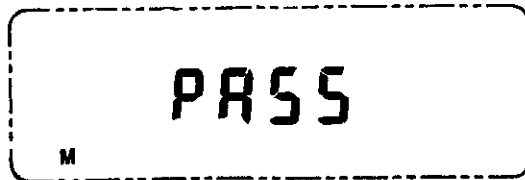

5. Turn OFF the power switch and then turn on the power. It will the CH mode display on LCD.

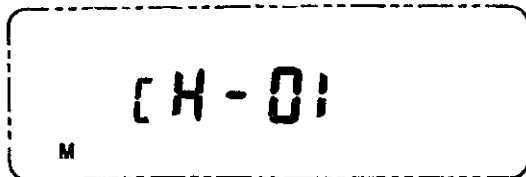

5-18-2 Normal frequency display mode

Performs the procedures 2,3,4,5 as indicated in 5-18-1 will return to the normal frequency display mode.

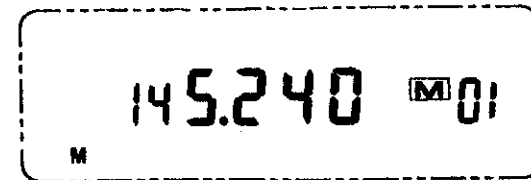

5-19 AM RECEPTION (AR-147 option only)

When the AM RECEPTION option is installed in the AR-147, it is able to receive AM signals within the frequency range of 118.000 to 135.995 MHz (Air Band).

1. Turn the transceiver to VFO display mode.
2. Press the MHz key for longer than 1 second. The LCD will display "A" to indicate it is in the AM RECEPTION mode. Transmitting is not allowed whilst in this mode.
3. Press the MHz key for longer than 1 second again, it returns the transceiver to normal FM mode.

6 KEY FUNCTION LIST

(1)VFO + PWR/ON	→	VFO RESET
(2)MR + PWR/ON	→	SYSTEM RESET
(3)MHz+PTT+MIC CALL+PWR/ON	→	CHANNEL DISPLAY MODE ON/OFF
(4)MHz + PWR/ON	→	MEMORY CHANNEL CLEAR IF THE MR KEY PRESSED IN 5 SECONDS UNDER MEMORY MODE
(5)TONE + PWR/ON	→	DUAL WATCH WITH MEMORY SCAN IN MEMORY SCAN MODE

(6)LOW/DIM	→	TX POWER LEVEL SETTING (H/M/L)
(7)F + LOW/DIM	→	ILLUMINATION INTENSITY LEVEL SETTING(1-4)
(8)F-1Sec + LOW/DIM	→	TOT (TIME OUT TIMER) ON/OFF AND SETTING(1/3/5/10/30 Minutes)

(9)VFO 1Sec	→	VFO SCAN
(10)F + VFO	→	CALL/MR DATA TRANSFERRED TO VFO CHANNEL
(11)F-1Sec + VFO	→	TX OFFSET FREQ SETTING

(12)MR-1Sec	→	MEMORY SCAN
(13)F + MR	→	SAVE DATA TO MEMORY CHANNEL
(14)F-1Sec + MR	→	MEMORY CHANNEL SKIP ON/OFF

(15)MHz	→	MHz FREQUENCY TUNING
(16)MHz + MIC DIGITAL KEY 0-9	→	ENTER FREQUENCY FROM KEYPAD
(17)F + MHz	→	PANEL KEYLOCK ON/OFF
(18)F-1Sec + MHz	→	APO ON/OFF

(19)F + CALL	→	(A) SAVE DATA TO CALL CHANNEL IF NOT IN PAG/C.SQ MODE (B) DTMF TX DELAY TIME SETTING IN PAG/C.SQ MODE
(20)F + CALL 1Sec	→	DTMF SPEED SETTING IN PAG/C.SQ MODE
(21)F-1Sec + CALL	→	PROGRAMMABLE BAND SCAN ON/OFF

(22)F + F	→	PANEL LED OFF
(23)F-1Sec + F	→	PAUSE/BUSY SCAN

(24)F + SHFT	→	REV ON/OFF
(25)F-1Sec + SHFT	→	CHANNEL STEP SETTING (5/10/12.5/20/25/50 KHz)
(26)F-1Sec + SHFT-1Sec	→	DCS TX/RX POLARITY SETTING IF IN DCS MODE

(27)F + TONE	→	DUAL WATCH
(28)F-1Sec + TONE	→	(A) CTCSS CODE SETTING IN CTCSS MODE (50 CODES)
		(B) DCS CODE SETTING IN DCS MODE (106 CODES)
		(C) REPEATER ACCESS TONE SETTING (1450/1750/2100 Hz)
(29)F-1Sec + TONE-1Sec	→	(A) CTCSS CODE SCAN IN CTCSS TX+ RX MODE
		(B) DCS CODE SCAN IN DCS TX + RX MODE

(30)F + DTMF	→	(A) C.SQ CODE SETTING IN C.SQ MODE
		(B) PAGING CODE SETTING IN PAG MODE
		(C) DTMF CODE DECODING IF NOT IN PAG/C.SQ MODE
(31)F + DTMF + MR	→	SAVING DTMF DECODING CODES TO EEPROM IF NOT IN PAG/C.SQ MODE
(32)F + DTMF + MHz	→	CLEAR DTMF DECODING CODES BUFFER IF NOT IN PAG/C.SQ MODE

(33)F + DTMF - 1Sec	→	DTMF AUTODIALER ON/OFF
		DTMF AUTODIAL MEMORY SETTING (EACH MEMORY COULD CONTAIN 16 DTMF CODES MAXIMUM, WITH 9 INDIVIDUAL MEMORIES)
		ROTARY SW OR MIC UP/DN KEY →SELECT MEMORY
		MHz KEY→DTMF CODE SETTING
		DTMF KEY→DTMF CODE VIEW
(34)F - 1Sec + DTMF	→	BEEP ON/OFF

(35)PTT + MIC CALL	→	SEND REPEATER ACCESS TONE
(36)PTT + MIC VFO	→	(A) DTMF REDIALING IF NOT IN DTMF AUTODIALER MODE
		(B) DTMF AUTODIALING
		MIC UP/DN KEY →SELECT DTMF AUTODIALER MEMORY
		MIC VFO KEY →SEND DTMF CODE

7 MAINTENANCE

7-1 GENERAL INFORMATION

Your transceiver have been factory aligned and tested to specification before shipment. Under normal circumstances the transceiver will operate in accordance with these operating instructions. All adjustable trimmer and coils in your transceiver have been adjusted at the factory and should only be readjusted by a qualified technician with proper test equipment. Attempting service or alignment without factory authorization can void the transceiver's warranty.

When operated properly, the transceiver will provide many years of service without requiring realignment. The information in this section gives some general service procedures which can be accomplished without sophisticated test equipment.

7-2 SERVICE

If it ever become necessary to return the equipment to your dealer or service center for repair, pack it in its original box and packing, and include a full description of the problems involved. Please include your daytime telephone number. You need not return accessory items unless directly related to the service problem.

Service note:

Dear OM, if you desire to correspond on a technical or operational problem, please make your note short, complete, and to the point, and please make it readable.

Please list: Model and serial number.

The problem you are having.

Please give sufficient detail for diagnosis. Provide information such as other equipment in the station, meter readings and anything else you feel might be useful in attempting diagnosis.

Caution:

Do not pack the equipment in crushed newspapers for shipment. Extensive damage may result during shipment.

Note:

1. Record the date of purchase, serial number and dealer from whom purchased.
2. For your own information, retain a written record of any maintenance performed on the unit.
3. When claiming warranty service, please include a photocopy of the bill of sale, or other proof of purchase showing the date of sale.

7-3 IN CASE OF DIFFICULTY

The problems described in this table are failures caused, in general, by improper operation or connection of the transceiver, not by defective components. Check according to the following table.

Symptom	Probable	Corrective action
Indicators do not light and no receiver noise is heard when the POWER switch is turned on.	1. Bad power cable or connections. 2. Blown power supply fuse.	1. Check cables and connections. 2. Check for the cause of the blown fuse and replace the fuse.
No sound from the speaker. No signal can be received.	1. Squelch is closed. 2. CTCSS/DCS/PAG/C.SQ is operating.	1. Turn the SQ control counterclockwise. 2. Press the TONE/DUAL or DTMF key to turn off the CTCSS/DCS or PAG/C.SQ feature.
No transmitter output.	1. Microphone is not plugged in. 2. Poor antenna connection.	1. Plug jack in. 2. Connect antenna securely.
Weak signal cannot be received.	Poor antenna connection.	Connect antenna securely
Display is dark.	1. Power voltage is low. 2. The DIM is selected too dark.	1. Check voltage for 13.8 VDC \pm 15%. 2. Press the F key and the LOW/DIM key, select the desired dimmer value.
The display will not change when the tuning controls rotated or a key is pressed.	The lock is on action.	Press the MHz/LOCK key within ten seconds of pressing the F key.

Installing accessories

CAUTION

Before installation, be sure to disconnect the DC power supply, or battery, or damage may occur the equipment.

DTMF unit DTF147

1. Remove the 2 screws securing the top cover.
2. Carefully remove the top cover.(Fig. 1)

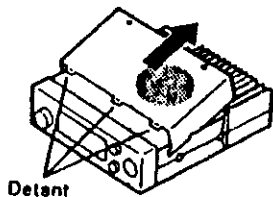

Fig. 1

3. Remove the backing from the small cushion provided with the DTF147 and attach it to the back of the DTF147.
4. Plug the three connectors into the sockets in the units.
5. Attach the cable from DTF147 as shown in Fig.2

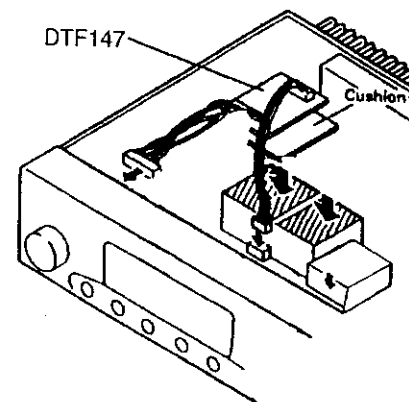

Fig. 2

6. Replace the cover and tighten the screws to complete the installation.

● Installing DTF147

Attach this unit on the top of VCO shield (Fig. 2)



ONE YEAR LIMITED WARRANTY

- ADI Communications Corp. warrants this product against defects in material and workmanship.
- In the unlikely event of any failure due to defect in material or workmanship, occurring within one year of purchase, this product will be repaired or replaced at our discretion at no charge.
- The defective product should be returned in its original packing and with proof of the date of the original retail purchase to your dealer for warranty service.
- The warranty does not cover accident, misuse, fire, flood and other Act of God, unauthorized repair or altered serial numbers.
- Some statutory regulations do not allow for the exclusion or limitation of incidental or consequential damages, nor allow limitations on how long an implied warranty lasts, therefore the above limitations may not apply to you,

ADI Communications and **ADI** are registered trademark of ADI Communications Corporation

NX255A038E