



225WB BOOMER

220-225 MHz YAGI



951347 (11/87)

FIGURE 1

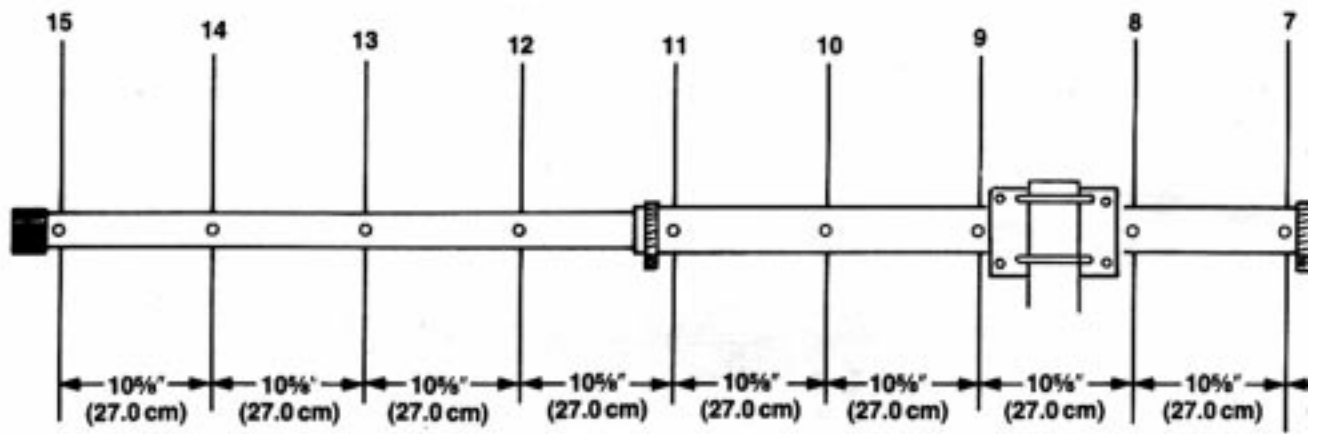
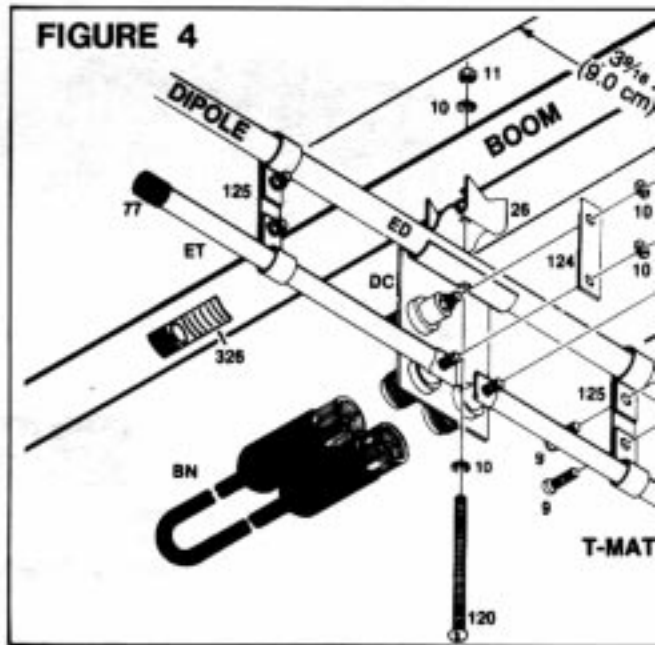
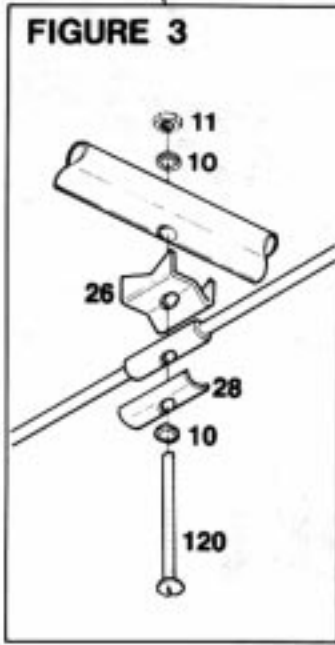
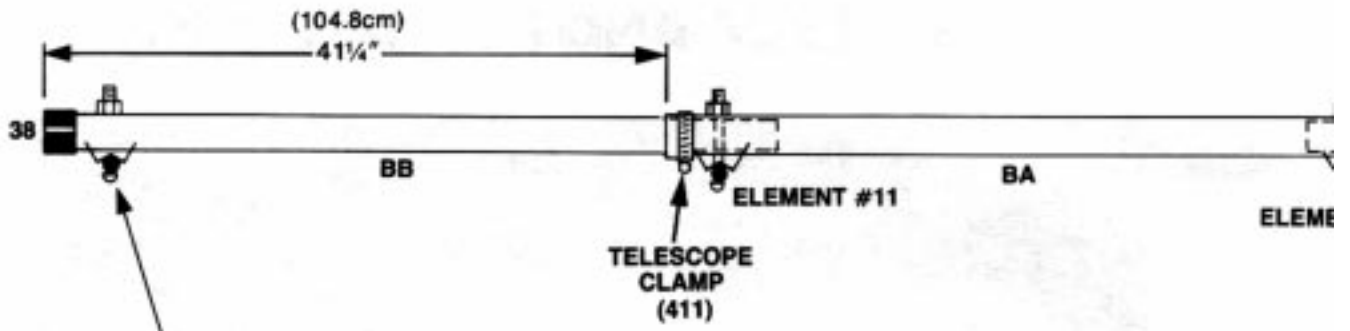
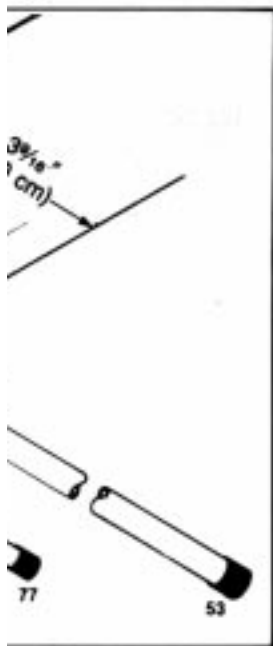
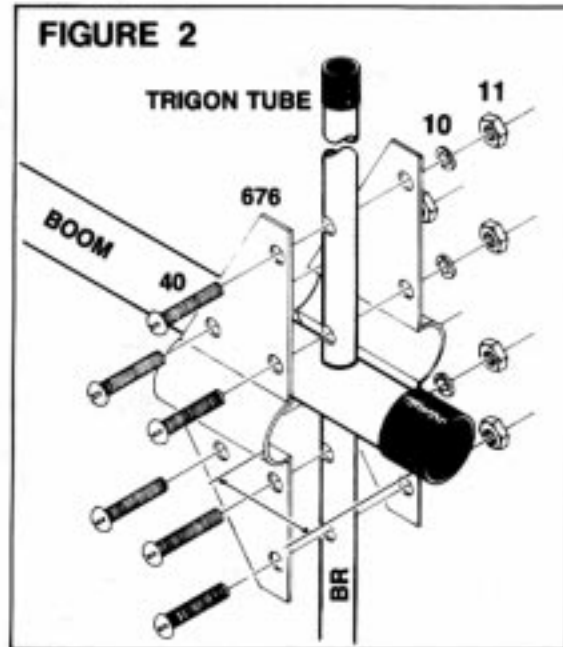
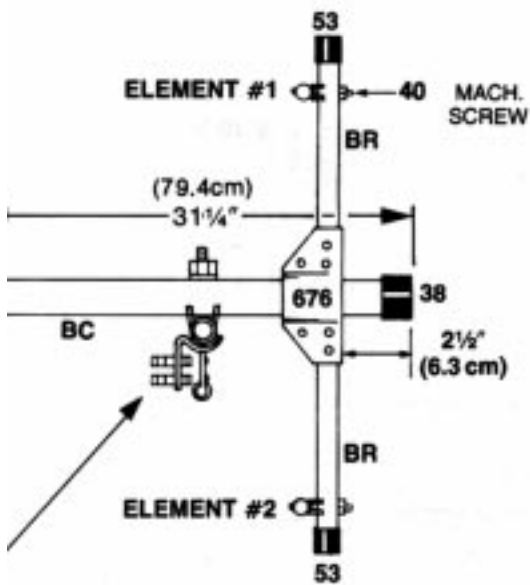

FIGURE 6



Element	Length
E1, 2	25 5/8\"/> (65 cm)
E3	26 9/16\"/> (66.8 cm)
E5	24 1/2\"/> (62.7 cm)
E6	24 9/16\"/> (61.4 cm)
E7	23 1/4\"/> (60.2 cm)
E8, 15	23 3/8\"/> (59.3 cm)
E9, 14	23\"/> (58.4 cm)
E10-13	22 9/16\"/> (57.3 cm)

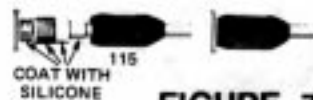
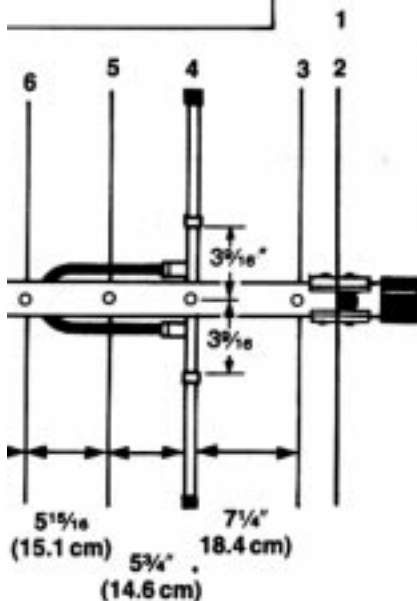
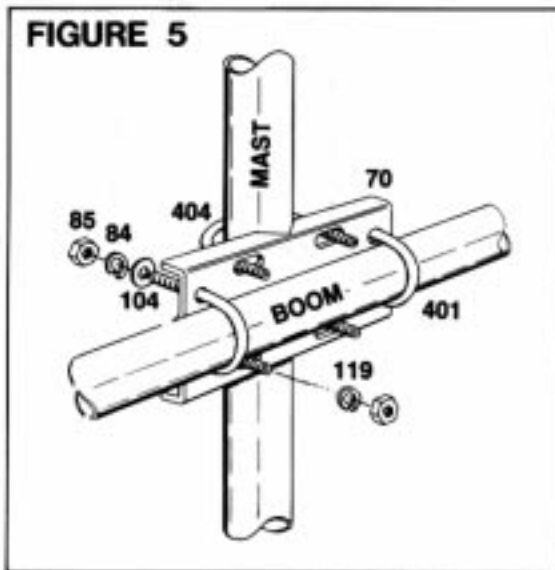

FIGURE 7

INSTRUCTIONS

Your Cushcraft 225WB is manufactured to give top performance and trouble free service. The antenna will perform as specified, if the instructions and suggestions are followed, and if care is used in assembly and installation.

MASTING: The 225WB mast mount bracket will take up to a 2" O.D. mast. Before deciding on location and height of your antenna you should check with your local building department for zoning and building regulations pertaining to antenna installations.

ROTATOR: Select a good quality rotator designed for use with amateur radio antenna installations.

LOCATION: Location of the antenna is very important. Surroundings such as trees, power lines, other antennas, etc., will seriously reduce efficiency. To minimize the effects of surrounding objects, mount the antenna as high and in the clear as possible. If metal guy wires are used, they should be broken with strain insulators. **WARNING: THIS ANTENNA IS AN ELECTRICAL CONDUCTOR, CONTACT WITH POWER LINES CAN RESULT IN DEATH OR SERIOUS INJURY. DO NOT INSTALL THIS ANTENNA WHERE THERE IS ANY POSSIBILITY OF CONTACT WITH, OR HIGH VOLTAGE ARC-OVER FROM POWER CABLES OR SERVICE DROPS TO BUILDINGS. THE ANTENNA, SUPPORTING MAST AND/OR TOWER MUST NOT BE CLOSE TO ANY POWER LINES DURING INSTALLATION, REMOVAL, OR IN THE EVENT PART OF THE SYSTEM SHOULD ACCIDENTALLY FALL. FOLLOW THE GUIDELINES FOR ANTENNA INSTALLATION RECOMMENDED BY THE U.S. CONSUMER PRODUCT SAFETY COMMISSION AND LISTED IN THE ENCLOSED PAMPHLET.** Plan your installation carefully. If you use volunteer helpers be sure that they are qualified to assist you. Make certain that everyone involved understands that you are the boss and that they must follow your instructions. If you have any doubts at all, employ a professional antenna installation company to install your antenna.

ASSEMBLY: Follow these steps in sequence and your assembly will go quickly.

STEP 1: Assemble the boom as shown in Figure 1. The boom sections are aligned with 8-32 machine screws. The sections are held securely in position with (411) telescope clamps. The trigon reflector assembly mounts on section BC, as illustrated in Figures 1 and 2.

STEP 2: Assemble the T-Match to the dipole as illustrated in Figure 4. The sliding strap positions are shown in Figure 4. The flattened end of tube ET attaches to a connector as illustrated. The connecting strap (124) must be attached as shown between the upper and lower connector. The feedline is connected to the upper connector and the balun to the two lower connectors. Mount the dipole at the boom position illustrated in Figure 6.

STEP 3: When connecting the balun, coat the outside of the aluminum connector threads and the PL-259 with the silicone grease provided. **DO NOT COAT THE CONNECTOR CENTER PIN AND SOCKET WITH SILICONE.** Slide the vinyl boots over the connectors and against the plate for a good weather-tight connection, Figure 7.

STEP 4: Follow the same procedure for your 50 Ohm coaxial feed cable and be sure to slide the vinyl boot over the cable before attaching the PL-259 connector.

STEP 5: The solid rod elements are bundled together. Follow Figures 3, 6 and the parts list when attaching the elements to the boom. Double check to be sure the correct length element has been mounted at each element location. Use the 1/4" machine screws to fasten elements 1 and 2.

CAUTION! The last directors are longer than the middle directors. It is very important to properly position the elements as listed in the parts list, in their correct order. Failure to do so will result in degraded performance.

STEP 6: Mount the antenna to your support mast as illustrated in Figure 5. Tighten the U-Bolts.























MOUNTING: The 225WB provides excellent gain, clean pattern and low SWR across the entire 220 MHz band.

















VERTICAL (FM): If you plan to mount the 225WB for vertical polarization, best results can be obtained by mounting the antenna at the top of the mast with none of the mast extending beyond the boom-to-mast plate. Center the boom-to-mast mounting plate midway between elements 8 and 9 as shown in Figure 6. Install the 225WB with the elements on the opposite side of the boom from your support mast. A vertically polarized 225WB on a metal mast will have a VSWR of under 2:1 from 220 to 225 MHz. A Dual array of horizontally spaced 225WBs (6' 10" or 2.08m apart) presents the best means of installing the antenna for maximum gain.

HORIZONTAL (CW/SSB): Mount your 225WB horizontally and as high as possible, with the boom-to-mast plate midway between elements 8 and 9. Should you desire increased gain, another antenna may be added 6 feet 10 inches (2.08m) lower on your mast. Spacing between other antennas for different bands should be 2 feet (0.6m) or more.

TUNE-UP PROCEDURES: The 225WB does not normally require tuning after assembly. If you wish to check the VSWR before installation, please observe the following procedures. Mount the antenna clear of surrounding objects. Keep all metal obstructions such as guy wires and other antennas at least 25 feet away.

Attach a good quality VSWR bridge in the coaxial cable as close to the antenna as possible and note the VSWR at your operating frequency. Move the sliding straps on both sides of the driven element towards the end of the dipole by 1/4". Check the VSWR. If the VSWR deteriorated, move the straps back to their original position, then go 1/4" towards the center of the driven element. Check the VSWR again. If the reading improved, keep moving both straps equally in the same direction until no further improvement is observed. Tighten all connections on the T-Match/Driven Element assembly. Do not attempt to tune this Yagi by other methods. Ground effects will nullify any adjustments and degraded performance will result.

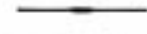
P/N	KEY	DETAIL	DESC.	SIZE	QTY.
010010	10		#8 SS INT. TOOTH LOCK WASHER	#8	43
010011	11		SS HEX NUT	8-32	28
010040	40		SS MACH. SCREW	8-32 x 1 1/4" (3.2 cm)	8
010009	9		SS MACH. SCREW	8-32 x 3/8" (1.6 cm)	4
010084	84		SS LOCK WASHER	1/4" (.64 cm)	4
010085	85		SS HEX NUT	1/4" (.64 cm)	4
010104	104		FLAT WASHER	1/4" (.64 cm)	4
010118	118		SS HEX NUT	3/16" (.79 cm)	4
010119	119		SS LOCK WASHER	3/16" (.79 cm)	4
010120	120		SS MACH. SCREW	8-32 x 2" (3.0 cm)	13
010401	401		SS U-BOLT	1 1/2" x 3" (3.8 x 7.6 cm)	2
010404	404		SS U-BOLT	2 1/8" x 3" (5.5 x 7.6 cm)	2
030411	411		SS WORM CLAMP	1 1/8" (2.86 cm)	2
050038	38		BLK. PLASTIC CAP	1" (2.5 cm)	2
050115	115		VINYL BOOT		1
050077	77		BLK. PLASTIC CAP	3/8" (.95 cm)	2
050053	53		BLK. PLASTIC CAP	1/2" (1.3 cm)	4
190026	26		FORMED ALUMINUM BRACKET	3/8" (2.2 cm)	15
190028	28		ALU. HALF WASHER		14
190124	124		CONN. STRAP		1
200125	125		T-MATCH STRAP		2
240116	116		SILICONE		2
BA			MID BOOM	1 1/8" x 48" (2.9 x 121.9 cm)	1
BB			FRONT BOOM	1" x 48" (2.5 x 121.9 cm)	1

P/N	KEY	DETAIL	DESC.	SIZE	QTY.
BC			REAR BOOM	1" x 36" (2.5 x 91.4 cm)	1
BR			TRIGON TUBE	1/2" x 8 3/4" (1.3 x 22.2 cm)	2
191676			REFLECTOR SUPPORT BRACKET	2" x 5" (5.1 x 12.7 cm)	2
DC			CONNECTOR BRACKET		1
ED			DIPOLE	1/2" x 25 3/4" (1.3 x 64.4 cm)	1
ET			T-MATCH TUBE	3/8" x 4 3/4" (12.1 x .95 cm)	2
190070	70		FORMED MOUNTING PLATE	4" x 6" (10.2 x 15.2 cm)	1
BN			COAX BALUN	16 1/2" (42.36 cm)	1
E1, 2			ELEMENT	25 3/8" (65 cm)	2
E3			ELEMENT	26 3/16" (66.8 cm)	1
E5			ELEMENT	24 1/2" (62.7 cm)	1
E6			ELEMENT	24 3/16" (61.4 cm)	1
E7			ELEMENT	23 1/16" (60.2 cm)	1
E8, 15			ELEMENT	23 3/8" (59.3 cm)	2
E9, 14			ELEMENT	23" (58.4 cm)	2
E10-13			ELEMENT	22 3/16" (57.3 cm)	4
290326	326		DANGER LABEL		1

225WB SPECIFICATIONS

Frequency Range	220-225 MHz	Recommended Stacking Distance	E: 7' 4" (2.24m)
Forward Gain	15.5 dBd	Boom to Boom	H: 6' 10" (2.08m)
Front to Back Ratio	24 dB	Weight (Net)	5.25 lbs (2.4Kg)
E Plane Beamwidth	2 × 17°	Length	10' (3.05m)
H Plane Beamwidth	2 × 18°	Longest Element	26.3" (66.8cm)
Impedance	50 OHMS	Turning Radius	70" (1.78m)
Connector Type	SO-239 (UHF)	Wind Surface Area	.95ft ² (.09m) ²
SWR	1.2:1 Typical	Wind Survival	100 MPH (160Km/H)

LIMITED WARRANTY

CUSHCRAFT CORPORATION, P.O. BOX 4680, MANCHESTER, NEW HAMPSHIRE 03108, WARRANTS TO THE ORIGINAL CONSUMER PURCHASER FOR ONE YEAR FROM DATE OF PURCHASE THAT EACH CUSHCRAFT ANTENNA IS FREE OF DEFECTS IN MATERIAL OR WORKMANSHIP. IF, IN THE JUDGEMENT OF CUSHCRAFT, ANY SUCH ANTENNA IS DEFECTIVE, THEN CUSHCRAFT CORPORATION WILL, AT ITS OPTION, REPAIR OR REPLACE THE ANTENNA AT ITS EXPENSE WITHIN THIRTY DAYS OF THE DATE THE ANTENNA IS RETURNED (AT PURCHASER'S EXPENSE) TO CUSHCRAFT OR ONE OF ITS AUTHORIZED REPRESENTATIVES. THIS WARRANTY IS IN LIEU OF ALL OTHER EXPRESSED WARRANTIES. ANY IMPLIED WARRANTY IS LIMITED IN DURATION TO ONE YEAR. CUSHCRAFT CORPORATION SHALL NOT BE LIABLE FOR ANY INCIDENTAL OR CONSEQUENTIAL DAMAGES WHICH MAY RESULT FROM A DEFECT. SOME STATES DO NOT ALLOW LIMITATIONS ON HOW LONG AN IMPLIED WARRANTY LASTS OR EXCLUSIONS OR LIMITATIONS OF INCIDENTAL OR CONSEQUENTIAL DAMAGES. SO THE ABOVE LIMITATION AND EXCLUSION MAY NOT APPLY TO YOU. THIS WARRANTY GIVES YOU SPECIFIC LEGAL RIGHTS, AND YOU MAY ALSO HAVE OTHER RIGHTS WHICH VARY FROM STATE TO STATE. THIS WARRANTY DOES NOT EXTEND TO ANY PRODUCTS WHICH HAVE BEEN SUBJECT TO MISUSE, NEGLIGENCE, ACCIDENT OR IMPROPER INSTALLATION. ANY REPAIRS OR ALTERATIONS OUTSIDE OF THE CUSHCRAFT FACTORY WILL NULLIFY THIS WARRANTY.

STACKING INFORMATION

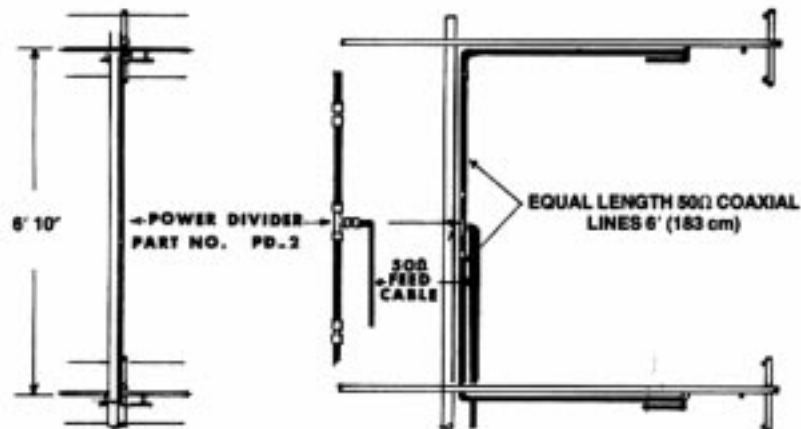

SPECIFICATIONS SUBJECT TO CHANGE WITHOUT NOTICE.

