

15-4CD

SKYWALKER

**15 METER
4 ELEMENT YAGI**



951352(6/88)

Your Cushcraft 15 meter beam is designed and manufactured to give top performance and trouble free service. All hardware is stainless steel. The antenna will perform as specified if the instructions and suggestions are followed and care is used in assembly and installation. When checking the components received in your antenna package use the parts lists in each section. It is easiest to identify the various dimensions of tubing by separating them into groups of the same diameter and length. If you are unable to locate any tube or component, check the inside of all tubing. **IMPORTANT:** save the weight label from the outside of the carton. Each antenna is weighed at the factory to verify the parts count. If you claim a missing part, you will be asked for the weight verification label. There is a master parts list on page 6.

LOCATION

Location of the antenna is very important. Surrounding objects such as trees, power lines, other antennas, etc. will seriously reduce efficiency. To minimize the effects of surrounding objects, mount the antenna as high and in the clear as possible. If metal guy wires are used, they should be broken with strain insulators.

WARNING: THIS ANTENNA IS AN ELECTRICAL CONDUCTOR. CONTACT WITH POWER LINES CAN RESULT IN DEATH, OR SERIOUS INJURY. DO NOT INSTALL THIS ANTENNA WHERE THERE IS ANY POSSIBILITY OF CONTACT WITH OR HIGH VOLTAGE ARC-OVER FROM POWER CABLES OR SERVICE DROPS TO BUILDINGS. THE ANTENNA, SUPPORTING MAST AND/OR TOWER MUST NOT BE CLOSE TO ANY POWER LINES DURING INSTALLATION, REMOVAL OR IN THE EVENT PART OF THE SYSTEM SHOULD ACCIDENTALLY FALL. FOLLOW THE GUIDELINES FOR ANTENNA INSTALLATIONS RECOMMENDED BY THE U.S. CONSUMER PRODUCT SAFETY COMMISSION AND LISTED IN THE ENCLOSED PAMPHLET.

Plan your installation carefully. If you use volunteer helpers be sure that they are qualified to assist you. Make certain that everyone involved understands that you are the boss and that they must follow your instructions. If you have any doubts at all employ a professional antenna installation company to install your antenna.

MOUNTING

The mast mount bracket will accommodate up to a 2" OD (5.1 cm) mast. A 1 1/2" OD (3.8 cm) or larger heavy wall tubing mast should be used. A good heavy duty antenna rotator will provide the best service and longest life. Often it is desirable to mount several antennas on one mast. To keep possible interaction to a minimum, place your antennas as far apart as you can.

SYSTEM GROUNDING

Direct grounding of the antenna, mast and tower is very important. This serves as protection from lightning strikes and static buildup, and from high voltage which is present in the radio equipment connected to the antenna. A good electrical connection should be made to one or more ground rods (or other extensive ground system) directly at the base of the tower or mast, using at least 10AWG ground wire and non-corrosive hardware. For details and safety standards, consult the National Electrical Code. You should also use a coaxial lightning arrester. Cushcraft offers several different models, such as LAC-1, LAC-2 and the LAC-4 series.

TUNING PROCEDURE

If you wish to check the SWR before installation, please observe the following procedures. Temporarily mount the antenna with the boom vertical, reflector at least one foot (30 cm) off the ground on a non-metallic support (wooden box), to prevent detuning the antenna. Guy the top of the boom. Do not use line with wire in it (some clotheslines have a wire core). Keep other antennas, metal objects and guy lines clear of the antenna under test. Do not attempt to tune the Yagi near the ground with the boom parallel to the ground since ground effects will nullify any adjustment and degraded performance will result.

Run the coax cable from your transmitter to the area in which the antenna is going to be tested. The length of this cable or your feedline is not critical. Connect a good quality SWR bridge to the end of this cable. Connect a short length of cable [2 feet (61 cm) or less] from the SWR bridge to the antenna. Set the transmitter to your center operating frequency. When you read SWR, be sure you move far enough away from the antenna so that your body does not effect the reading.

Measure the SWR. If it is high, move the Reddi-Match clamp (108) by 1/4" (.6 cm) in one direction and check the SWR, if the SWR improved then continue moving the Reddi-Match clamp in the same direction. If the SWR deteriorated then move the Reddi-Match clamp in the opposite direction.

When no further improvement can be made you have matched your antenna to 50 Ohms. Then tighten all connections on the Reddi-Match assembly. Tape the feedline to the boom and mast.

#1 - BOOM ASSEMBLY

Place a worm clamp (414) over the slotted ends of the BA and BB tubes. Join the four sections of tube in the order illustrated below in figure A. Align the drilled holes and install screws (232), lock washers (10) and nuts (11). Tighten screws and worm clamps. Push end caps (99) onto each end of the boom.

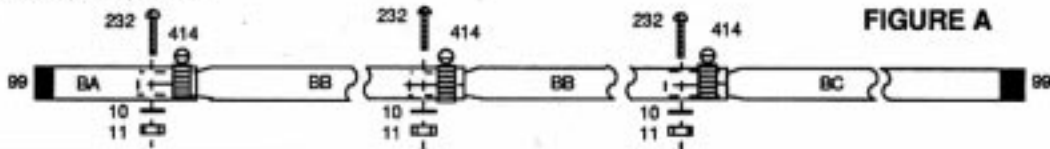

FIGURE A

KEY	P/N	DISPLAY	DESC	SIZE	QTY	KEY	P/N	DISPLAY	DESC	SIZE	QTY
BA			ALUM TUBE	2" x 24" (5.1 x 61 cm)	1	232	010232		SS MACH SCREW	8-32 x 2 1/8" (5.4 cm)	3
BB			ALUM TUBE	2" x 75" (5.1 x 190.5 cm)	2	10	010010		SS LOCK WASHER	#8	3
BC			ALUM TUBE	2" x 75" (5.1 x 190.5 cm)	1	11	010011		SS HEX NUT	8-32	3
414	030414		SS WORM CLAMP	2 1/4" (5.7 cm)	3	99	050099		PLASTIC CAP	2" (1.9 cm)	2

#2 - ELEMENT ASSEMBLY

Install clamp (88) on EA tube of #2 element. Place a worm clamp (410) on the end of each EA tube. Insert the EB tubes 4" (10.2 cm) into each end of the EA tube. Tighten the clamps securely. On the driven element section, slide the Reddi Match clamp (108) on as far as it will go. Place a worm clamp (409) on the end of each EB tube. Insert the EC tubes 4" (10.2 cm) into both ends of elements 1, 2 and 3. Place worm clamps on the slotted ends. Insert the element tips ED, EE, EF and EG in the appropriate elements. Figure B below. Adjust the element tips and overall length to the dimensions shown below. Tighten all worm clamps. Install end caps (27 and 12) on the element tips.

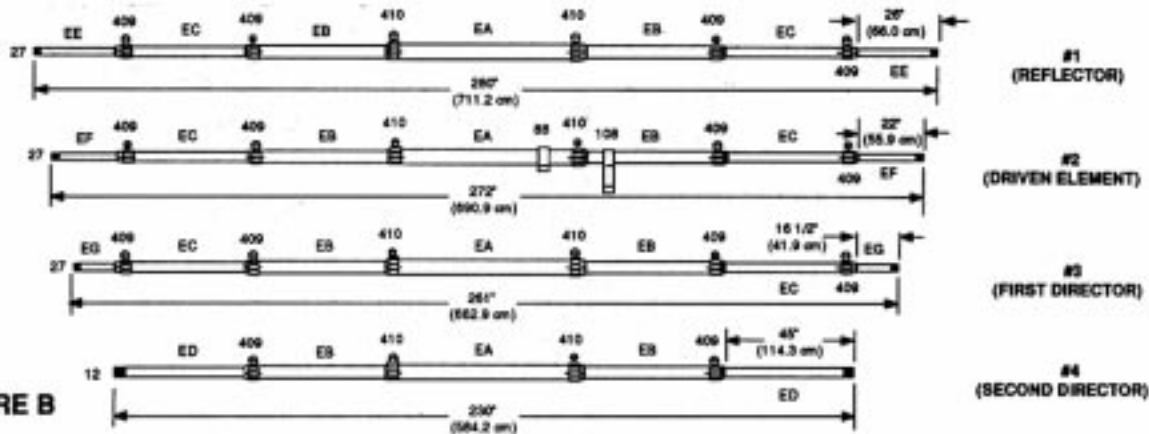







FIGURE B

KEY	P/N	DISPLAY	DESC	SIZE	QTY	KEY	P/N	DISPLAY	DESC	SIZE	QTY
EA			ALUM TUBE	1" x 48" (2.5 x 122 cm)	4	409	030409		SS WORM CLAMP	7/8" (2.2 cm)	14
EB			ALUM TUBE	7/8" x 50" (2.2 x 127 cm)	8	410	030410		SS WORM CLAMP	1" (2.5 cm)	8
EC			ALUM TUBE	3/4" x 48" (1.9 x 122 cm)	6	12	050012		PLASTIC CAP	3/4" (1.9 cm)	2
ED			ALUM TUBE	3/4" x 48" (1.9 x 122 cm)	2	27	050027		PLASTIC CAP	5/8" (1.6 cm)	6
EE			ALUM TUBE	5/8" x 30" (1.6 x 76 cm)	2	88	200088		REDDI-M CLAMP	1" (2.54 cm)	1
EF			ALUM TUBE	5/8" x 26" (1.6 x 66 cm)	2	108	200108		REDDI-M CLAMP	7/8" to 3/8" (2.2 to .9 cm)	1
EG			ALUM TUBE	5/8" x 20 1/2" (1.6 x 52 cm)	2						









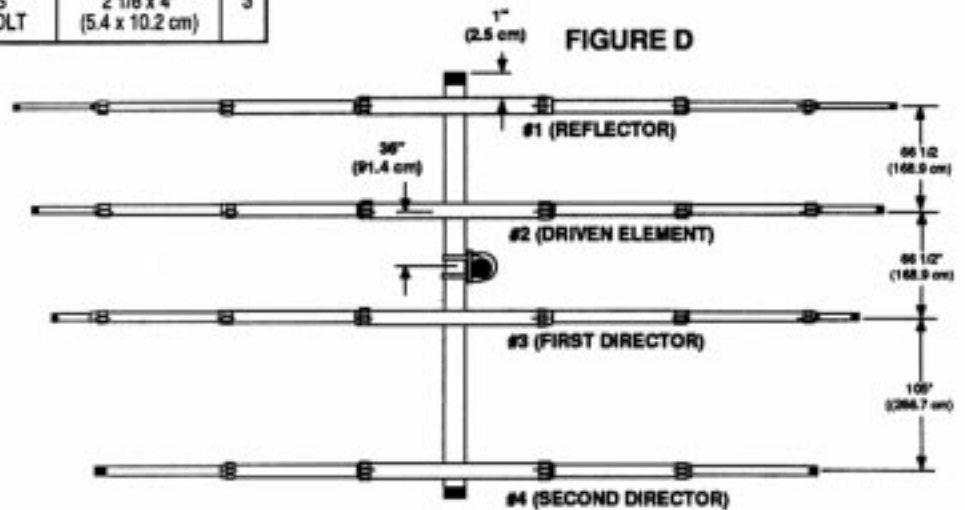
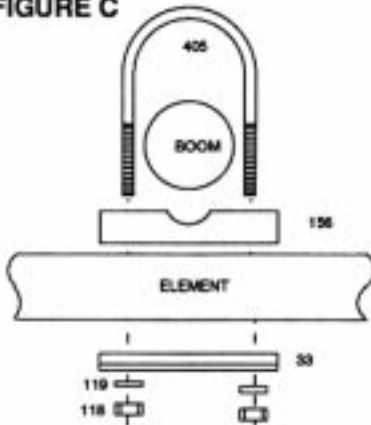

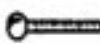

KEY	P/N	DISPLAY	DESC	SIZE	QTY
33	190033		BACKING PLATE	3 1/2" (8.9 cm)	3
118	010118		SS HEX NUT	5/16" (.8 cm)	6
119	010119		SS SPLIT LOCK WSHR	5/16" (.8 cm)	3
156	190156		U-BOLT BRACKET	2" (5.1 cm)	3
405	010405		SS U-BOLT	2 1/8 x 4" (5.4 x 10.2 cm)	3

#3 - ELEMENT MOUNTING

Mount the element/boom brackets (156) as shown in figure C and E. Position the elements on the boom as shown in figure D. The longest element (reflector) is #1. Align the elements and tighten the U-bolts. Note that the driven element backing plate includes the connector bracket (CB). See figure E. This should be mounted with the connector pointing to the center of the boom to allow easy connection of the feedline.

FIGURE C

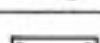





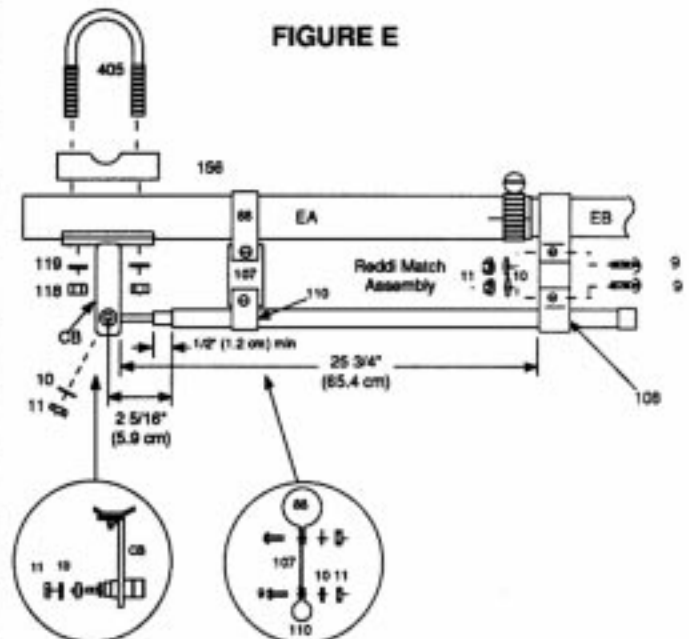

KEY	P/N	DISPLAY	DESC	SIZE	QTY
9	010009		SS MACH SCREW	8-32 x 5/8" (1.6 cm)	2
10	010010		SS LOCK WASHER	#8	3
11	010011		SS HEX NUT	8-32	3
118	010118		SS HEX NUT	5/16" (.8 cm)	2
119	010119		SS LOCK WASHER	5/16" (.8 CM)	2
156	190156		U-BOLT BRACKET	2 1/8" (5.4 cm)	1
405	010405		SS U-BLOT	2 1/8 x 4" (5.4 x 10.2 cm)	1
CB			CONNECTOR BRACKET		1
			REDDI MATCH		1
88	200088		REDDI-M CLAMP	1" (2.5 cm)	1
108	200108		REDDI-M CLAMP	3/8 x 7/8" (.95 X 2.2 cm)	1
107	150107		REDDI-M INSULATOR		1
110	200110		REDDI-M CLAMP		1

#4 - REDDI-MATCH

Mount the Reddi Match to the driven element (#2) as shown in figure E.

FIGURE E



KEY	P/N	DISPLAY	DESC	SIZE	QTY
63	170063		ALUM V-BLOCK	2" (5.1 cm)	4
119	010119		SS LOCK WASHER	5/16" (.8 cm)	8
118	010118		SS HEX NUT	5/16" (.8 cm)	8
130	190130		ALUM PLATE	6 x 6" (15.2 X 15.2 cm)	1
326	290326		DANGER LABEL		1
404	010404		SS U-BOLT	2 1/8 x 3" 5.4 x 7.6 cm)	4

#5 - BOOM / MAST

Assemble and mount the boom/mast bracket at the balance point. Refer to figure D for the approximate balance point and F for assembly.

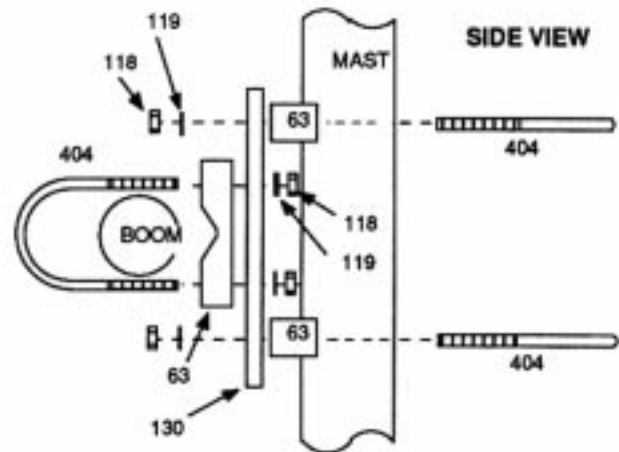
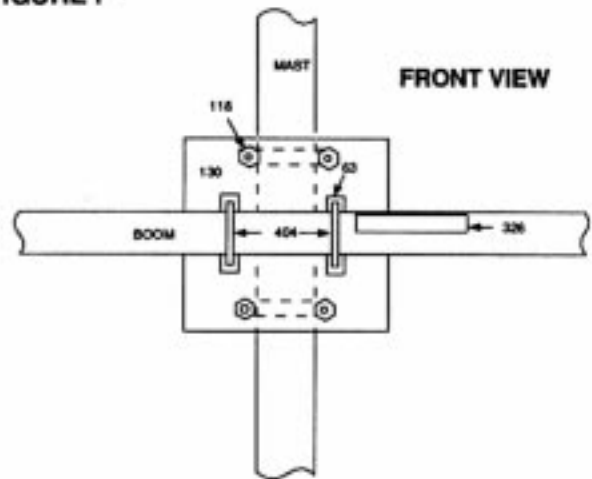



FIGURE F



KEY	P/N	DISPLAY	DESC	SIZE	QTY
115	050115		CONN BOOT		1
116	240116		SILICONE PACKAGE		1

#6 - FEEDLINE ASSEMBLY

Before attaching the feedline permanently, tune the antenna as outlined on page 2. The antenna is designed for use with 50 ohm coaxial cable terminated with a PL-259 connector. Any length of feedline can be used with your Yagi. The shortest length cable will have the least loss. A connector boot is included for use with your new antenna. Figure G. Slide the boot over the cable before attaching your PL-259. Coat only the outside connector threads and shell with silicone grease. Do not coat the center pin and/or receptacle. After the PL-259 is firmly screwed on to the antenna connector, slide the vinyl boot over the connector and against the mast bracket.

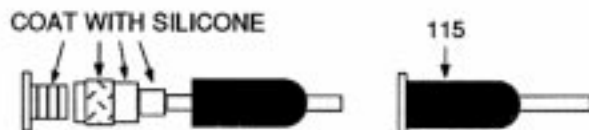

FIGURE G

MASTER PARTS LIST

KEY	P/N	DESCRIPTION	QTY	KEY	P/N	DESCRIPTION	QTY
119	010119	5/16" (.8 cm) stainless steel split lock washers	16	27	050027	5/8" (1.6 cm) black plastic caps	6
118	010118	5/16" (.8 cm) stainless steel hex nuts	16	108	200108	3/8 x 7/8" (.95 x 2.2 cm) Reddi Match strap	1
33	190033	3 1/2" (8.9 cm) aluminum U-bolt backing plates	3	88	200088	1" (2.5 cm) Reddi Match clamp	1
156	190156	2" (5.1 cm) aluminum U-bolt brackets	4	99	050099	2" (5.1 cm) black plastic caps	2
63	170063	2" (5.1 cm) aluminum V-blocks	4				
107	150107	Reddi Match insulator	1	BA		2" x 24" (5.1 x 61 cm) aluminum tube drilled and slotted one end	1
115	050115	Connector boot	1	BB		2" x 75" (5.1 x 190.5 cm) aluminum tube swaged and drilled one end, slotted and drilled one end	2
116	240116	Silicone package	1	BC		2" x 75" (5.1 x 190.5 cm) aluminum tube swaged and drilled one end	1
326	290326	Danger label	1				
9	010009	8-32 x 5/8" (1.6 cm) stainless steel round head slotted machine screws	4	EA		1" x 48" (2.5 x 122 cm) aluminum tube drilled for U-bolt and slotted both ends	4
232	010232	8-32 x 2 1/8" (5.4 cm) stainless steel round head slotted machine screws	3	EB		7/8" x 50" (2.2 x 127 cm) aluminum tube slotted one end	8
10	010010	#8 stainless steel internal tooth lock washers	8	EC		3/4" x 48" (1.9 x 122 cm) aluminum tube slotted one end	8
11	010011	8-32 stainless steel hex nuts	8	ED		3/4" x 48" (1.9 x 122 cm) aluminum tube	2
110	200110	3/8" (.95 cm) Reddi Match clamp	1	EE		5/8" x 30" (1.6 x 76 cm) aluminum tube	2
409	030409	7/8" (2.2 cm) stainless steel worm clamps	14	EF		5/8" x 26" (1.6 x 66 cm) aluminum tube	2
410	030410	1" (2.5 cm) stainless steel worm clamps	8	EG		5/8" x 20 1/2" (1.6 x 52 cm) aluminum tube	2
414	030414	2 1/4" (5.7 cm) stainless steel worm clamps	3	CB		Coaxial connector bracket assembly	1
405	010405	2 1/8 x 4" (5.4 x 10.2 cm) stainless steel U-bolts	4	130	190130	6" x 6" (15.2 x 15.2 cm) aluminum plate Reddi Match Tube Assembly	1
404	010404	2 1/8 x 3" (5.4 x 7.6 cm) stainless steel U-bolts	4				
12	050012	3/4" (1.9 cm) black plastic caps	2				

SPECIFICATIONS

Model	15-4CD
Forward Gain	10.0 dBd
Front to Back Ratio	>30 dB
SWR typical	1.2 : 1
Boom Length	20 ft. (6.2 m)
Longest Element	23 ft. 4 in. (7.1 m)
Turning Radius	15 ft. 6 in. (4.7 m)
Wind Surface Area	4.5 ft. sq. (.42 m sq.)
Weight	25 lb. (11.4 kg)

Cushcraft Corporation, P.O. Box 4680, Manchester, New Hampshire 03108, warrants to the original consumer purchaser for one year from date of purchase that each Cushcraft antenna is free of defects in material or workmanship. If, in the judgement of Cushcraft, any such antenna is defective, then Cushcraft Corporation will, at its option, repair or replace the antenna at its expense within thirty days of the date the antenna is returned (at purchasers expense) to Cushcraft or one of its authorized representatives. This warranty is in lieu of all other expressed warranties, any implied warranty is limited in duration to one year. Cushcraft Corporation shall not be liable for any incidental or consequential damages which may result from a defect. Some states do not allow limitations on how long an implied warranty lasts or exclusions or limitations of incidental or consequential damages, so the above limitation and exclusion may not apply to you. This warranty gives you specific legal rights, and you may also have other rights which vary from state to state. This warranty does not extend to any products which have been subject to misuse, neglect, accident or improper installation. Any repairs or alterations outside of the Cushcraft factory will nullify this warranty.



48 PERIMETER ROAD, MANCHESTER, NH 03108
603-627-7877 / TELEX 4949472 / FAX 603-627-1764