

729B

70 CM BOOMER
430-440 MHz



951456 (4/95)

WARNING

THIS ANTENNA IS AN ELECTRICAL CONDUCTOR. CONTACT WITH POWER LINES CAN RESULT IN DEATH, OR SERIOUS INJURY. DO NOT INSTALL THIS ANTENNA WHERE THERE IS ANY POSSIBILITY OF CONTACT WITH OR HIGH VOLTAGE ARC-OVER FROM POWER CABLES OR SERVICE DROPS TO BUILDINGS. THE ANTENNA, SUPPORTING MAST AND/OR TOWER MUST NOT BE CLOSE TO ANY POWER LINES DURING INSTALLATION, REMOVAL OR IN THE EVENT PART OF THE SYSTEM SHOULD ACCIDENTALLY FALL. FOLLOW THE GUIDELINES FOR ANTENNA INSTALLATIONS RECOMMENDED BY THE U.S. CONSUMER PRODUCT SAFETY COMMISSION AND LISTED IN THE ENCLOSED PAMPHLET.

Your Cushcraft 729B Boomer antenna is designed and manufactured to give trouble free service. This antenna will perform as specified if the instructions and suggestions in this manual are followed and care is used in the assembly and installation. When checking the components received in your antenna package use the parts listed beside each diagram. There is a master parts list on page 7. If you are unable to locate any tube or component, check the inside of all tubing. *IMPORTANT: Save the weight label from the outside of the carton. Each antenna is weighed at the factory to verify the parts count. If you claim a missing part, you will be asked for the weight verification label.*

PLANNING

Plan your installation carefully. If you use volunteer helpers be sure that they are qualified to assist you. Make certain that everyone involved understands that you are in charge and that they must follow your instructions. If you have any doubts at all, employ a professional antenna installation company to install your antenna.

LOCATION

Location of the antenna is very important. Surrounding objects such as trees, power lines, other antennas, etc. will seriously reduce efficiency. To minimize the effects of surrounding objects, mount the antenna as high and in the clear as possible. If metal guy wires are used, they should be broken with strain insulators. **EXTREME CARE MUST BE USED FOR YOUR SAFETY. YOU MUST INSURE THAT WHILE THE 729B IS IN OPERATION NEITHER PEOPLE OR PETS CAN COME IN CONTACT WITH ANY PORTION OF YOUR ANTENNA. DEADLY VOLTAGES AND CURRENTS MAY EXIST. ALSO, SINCE THE EFFECTS OF EXPOSURE TO RF FIELDS ARE NOT FULLY UNDERSTOOD, LONG TERM EXPOSURE TO INTENSE RF FIELDS IS NOT RECOMMENDED. THERE IS A WARNING STICKER WHICH MUST BE ATTACHED TO THE BOOM AS SHOWN IN FIGURE F.**

MOUNTING

The mast mount bracket will accommodate up to a 2" (5.1 cm) mast. A 1-1/2" OD (3.8 cm) or larger heavy wall tubing mast should be used. A good heavy duty antenna rotator will provide the best service and longest life. Often it is desirable to mount several antennas on one mast. To keep possible interaction to a minimum, place your antennas as far apart as you can.

SYSTEM GROUNDING

Direct grounding of the antenna, mast and tower is very important. This serves as protection from lightning strikes and static buildup, and from high voltage which is present in the radio equipment connected to the antenna. A good electrical connection should be made to one or more ground rods (or other extensive ground system) directly at the base of the tower or mast, using at least #10AWG ground wire and non-corrosive hardware. For details and safety standards, consult the National Electrical Code. You should also use a coaxial lightning arrester. Cushcraft offers several different models, such as LAC-1, LAC-2 and the LAC-4 series

ASSEMBLY

Assemble your antenna by following the directions and illustrations in steps 1 through 5. After the antenna is completely assembled, verify dimensions and element spacings for accuracy. Then, return to the section below for final tuning. Stacking options are shown in Figures G & H.

TUNING PROCEDURE

The 729B does not normally require tuning after assembly. However, if you wish to check the VSWR before installation, please observe the following procedures. To prevent detuning the antenna, it should be tuned in place or at least 7 feet (2.13 meters) above ground and clear of surrounding objects. Keep all metal obstructions such as guy wires and other antennas at least 10 feet (3.05 m) away since they will nullify any adjustment and degraded performance will result.

Run the coax cable from your transmitter to the area in which the antenna is going to be tested. The length of this cable or your feedline is not critical. Connect a good quality VHF VSWR bridge to the end of this cable. Connect a short length of cable [20 ft (610 cm) or less] from the VSWR bridge to the antenna. Set the transmitter to your center operating frequency. When you read VSWR, be sure you move far enough away from the antenna so that your body does not effect the reading.

Measure the VSWR. If it is too high, move both T-Match straps (921) by 1/4" (.6 cm) either inward or outward and check the VSWR. *Both T-Match straps should be the same distance from the center of the driven element.* If the VSWR improved, then continue moving the T-Match straps in the same direction. If the VSWR deteriorated then move the T-Match straps in the opposite direction. Repeat this procedure until no further improvement can be made. You have matched your antenna. Tighten all connections on the T-Match driven element assembly. Tape the feedline to the boom and mast as shown in figure E.

#1 - ASSEMBLE BOOM

Assemble the boom in two sections, the rear and front (figure A). Slide worm clamps (411) onto both slotted ends of tubes BB and BE and slide worm clamps (412) onto slotted ends of BC and BD. Refer to figure A to determine the proper orientation of all tubes. This is done by measuring and comparing the hole locations as shown. Insert tube BA into the smaller end of tube BB until the first set of holes are aligned. Pin in place with screw, washer and nut (120, 41, & 11). Do the same with the remaining tubes BB, BC, BD and BF. Join the two ends together with tube BG. Tighten all hardware and clamps. Note that the pins installed in tubes BC and BD furthest from the center are permanent. All other pins will be removed for element placement at a later time. Push end caps (61) on to the free ends of tubes BA and BF.

FIGURE A

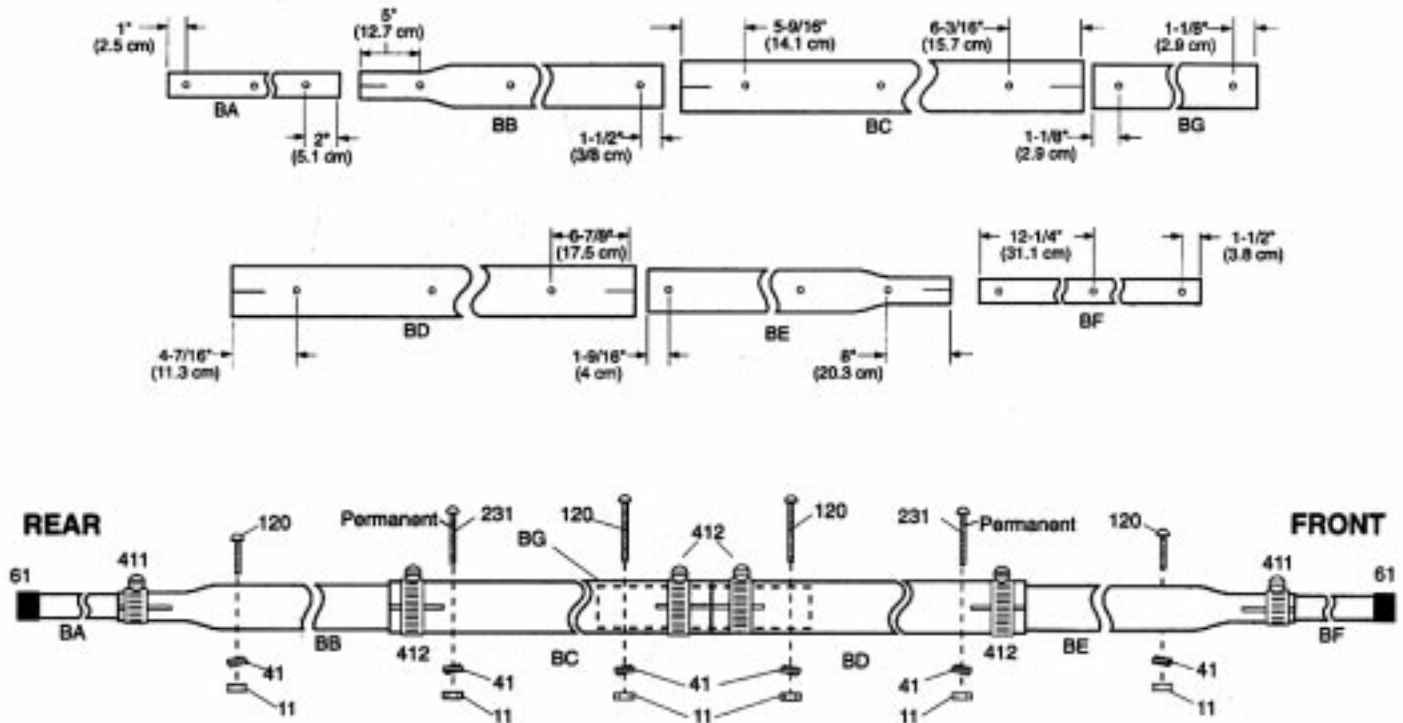

KEY	P/N	DESC.	SIZE	QTY
BA		ALUM TUBING	7/8" x 24" (2.2 x 61 cm)	1
BB		ALUM TUBING	1-1/8" x 50" (2.9 x 127 cm)	1
BC		ALUM TUBING	1-1/4" x 75" (3.2 x 190 cm)	1
BD		ALUM TUBING	1-1/4" x 75" (3.2 x 190 cm)	1
BE		ALUM TUBING	1-1/8" x 50" (2.9 x 127 cm)	1
BF		ALUM TUBING	7/8" x 24" (2.2 x 61)	1
BG		ALUM TUBING	1-1/8" x 12-13/16" (2.9 x 32.5 cm)	1

KEY	P/N	DESC.	SIZE	QTY
11	010011	SS HEX NUT	8-32	6
231	010231	SS SCREW	8-32 x 1-3/4" (4.4 cm)	2
41	011941	SS LOCK WASHER	#8	6
61	050061	PLASTIC CAP	7/8" (2.54 cm)	2
120	010120	SS SCREW	8-32 x 2" (5.1 cm)	4
411	030411	SS WORM CLAMP	1-3/8" (3.5 cm)	2
412	030412	SS WORM CLAMP	1-1/2" (3.8 cm)	4

#2 - ASSEMBLE T-MATCH

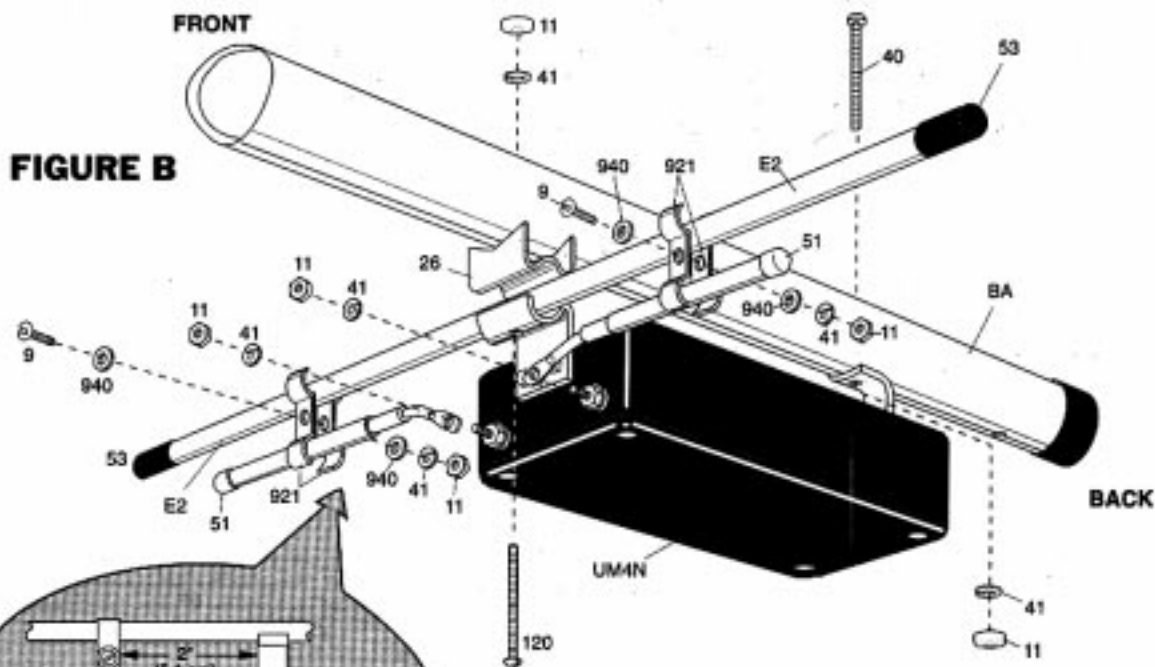

FIGURE B-1





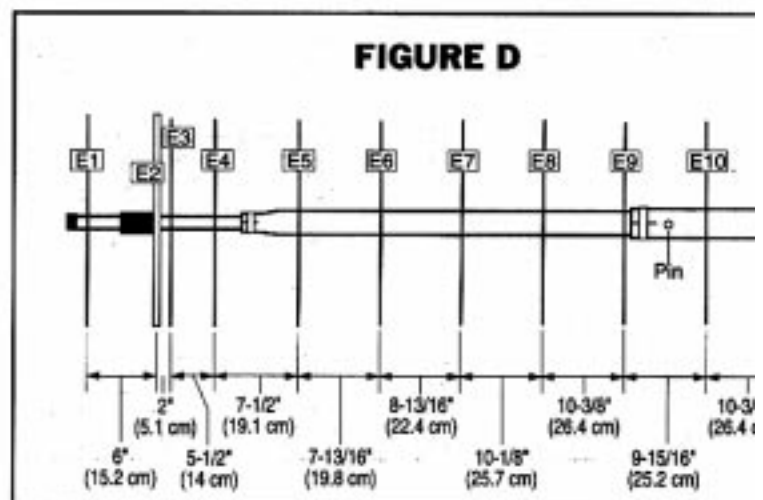

NOTE: Use same settings for both side of Reddi-Match

KEY	P/N	DISPLAY	DESC	SIZE	QTY
E2			ALUM TUBING	1/2" x 13-1/4" (1.3 x 33.7 cm)	1
RM			REDDI MATCH	3/8" x 3-1/2" (.95 x 8.9 cm)	2
UM4N	UM4N		UltraMatch BALUN	4-3/4" x 2-1/2" (12 x 6.4 cm)	1
9	010009		SS MACHINE SCREW	8-32 x 5/8" (1.6 cm)	2
11	010011		SS HEX NUT	8-32	6
26	190026		ALUM BRACKET	7/8" (2.2 cm)	1
40	010040		SS MACHINE SCREW	8-32 x 1-1/4" (3.2)	1
41	011941		SS LOCK WASHER	#8	6
51	060051		WHITE CAP	3/8" (.95 cm)	2
53	050053		PLASTIC CAP	1/2" (1.27 cm)	2
120	010120		SS MACHINE SCREW	8-32 x 2" (5.1 cm)	1
921	200921		REDDI-MATCH CLAMP		4
940	360940		ALUM FLAT WASHER	#8	4

Assemble the modified T-Match to driven element E2 as illustrated in figure B. Assemble the two reddi-matches and attach to UltraMatch with washer and nut (41 & 11). Assemble both sets of reddi-match clamps and position as shown in figure B. Do not tighten at this time. Push on end caps (53) on to ends of dipole and push on white caps (51) onto ends of reddi-match. Attach Ultramatch and dipole to boom BA as shown. Note that the N connector should point to the rear of the boom. Set dimensions (figure B-1). Tighten all hardware.

FIGURE D



KEY	P/N	DISPLAY	DESC	SIZE	QTY
11	010011		SS HEX NUT	8-32	26
26	190026		ALUMINUM BRACKET	7/8" (2.2 cm)	26
28	190028		ALUMINUM HALF WASHER	1" (2.54)	26
231	010231		SS SCREW	8-32 x 1-3/4" (4.5 cm)	5
41	011941		SS LOCK WASHER	#6	26
120	010120		SS MACHINE SCREW	8-32 x 2" (3.1 cm)	23

#3 - MOUNT ELEMENTS

Sort and group elements by length. Note element lengths are within $\pm 1/16"$ ($\pm .16$ cm) of the stated value in Table A are acceptable. The elements are progressively shorter as you proceed towards the front of the boom. Attach elements, starting at the rear, using the correct hardware (figure C) and proper placement (figure D). Note that you will be removing the temporary pins in order to mount some of the elements. **Do not remove the pins joining booms BB and BC or booms BD and BE.**

TABLE A
(Element Lengths)

E1	13-11/16"	(34.8 cm)
E2	1/2" x 13-1/4"	(1.3 x 33.7cm)
E3	12-7/16"	(31.6 cm)
E4	12-3/16"	(31 cm)
E5	12-3/16"	(31 cm)
E6	12-1/16"	(30.6 cm)
E7	11-15/16"	(30.3 cm)
E8	11-11/16"	(29.7 cm)
E9	11-11/16"	(29.7 cm)
E10	11-11/16"	(29.7 cm)
E11	11-7/16"	(29.1 cm)
E12	11-7/16"	(29.1 cm)
E13	11-7/16"	(29.1 cm)
E14	11-5/16"	(28.7 cm)
E15	11-5/16"	(28.7 cm)
E16	11-5/16"	(28.7 cm)
E17	11-5/16"	(28.7 cm)
E18	11-3/16"	(28.4 cm)
E19	11-3/16"	(28.4 cm)
E20	11-3/16"	(28.4 cm)
E21	11-3/16"	(28.4 cm)
E22	11-3/16"	(28.4 cm)
E23	11-1/16"	(28.1 cm)
E24	11-1/16"	(28.1 cm)
E25	11-1/16"	(28.1 cm)
E26	11-1/16"	(28.1 cm)

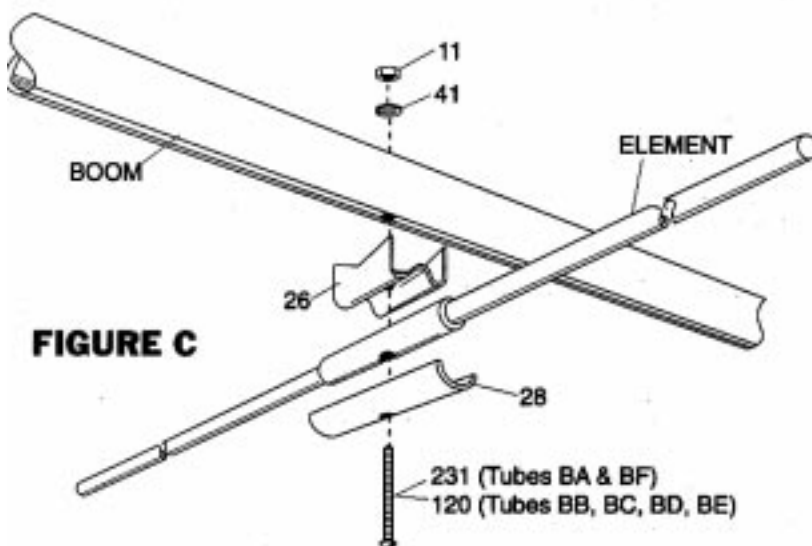
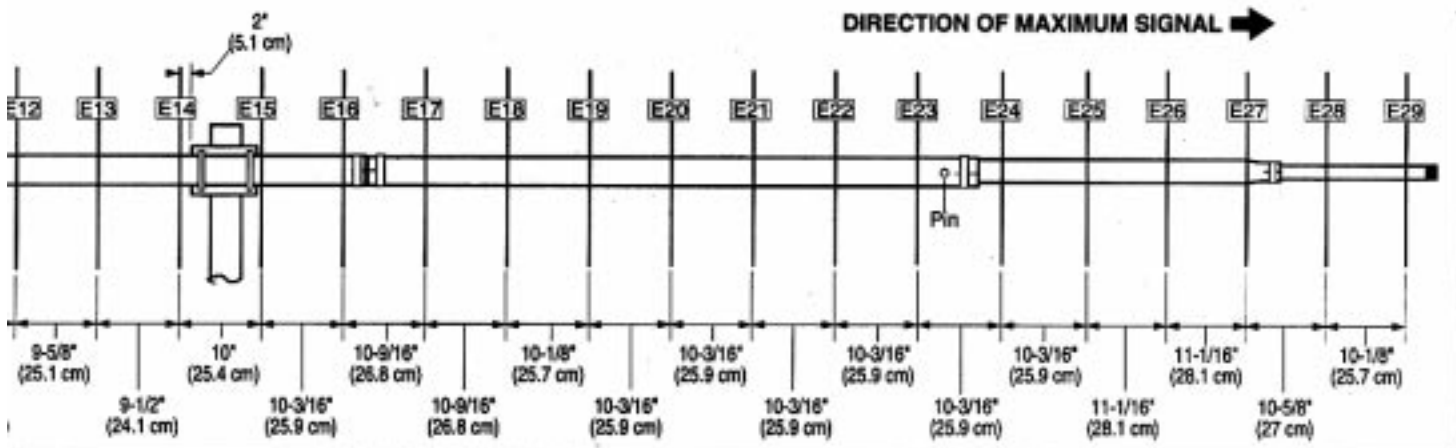
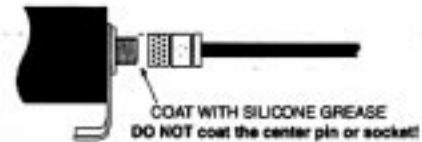

FIGURE C



#4 - FEEDLINE ATTACHMENT

Due to the length of the boom, connect the feedline before attaching the antenna to the mast. Apply silicone (116) to threaded portion of the female N-Connector located on the UM4N. Do not coat the center pins of either N-Connectors. Attach and tape the feedline in place as shown in figure E. Before proceeding to the next section, return to the tuning section on page 1 for instructions on how to test your new 729B.



KEY	P/N	DISPLAY	DESC	SIZE	QTY
116	240116		SILICONE PACKET		1

FIGURE E



#5 - ASSEMBLE BOOM TO MAST MOUNT

Assemble and mount the boom to mast plate (70) between elements 14 and 15 with U-bolts (401) (figure F). Secure with flat washer, lock washer, and nut (104, 84, & 85). The clamp should be centered between elements and 2" (5.1 cm) from element 14 (figure D). Affix danger label to boom (326) (figure F). Install antenna to your mast with U-bolts, lock washers, and nuts (404, 119, & 118). Note that elements should be on top of boom and parallel to the ground if you intend to operate SSB or CW. If you intend to operate FM, position the elements vertical to the mast and on the opposite side of the mast (figure F). Tighten all hardware.

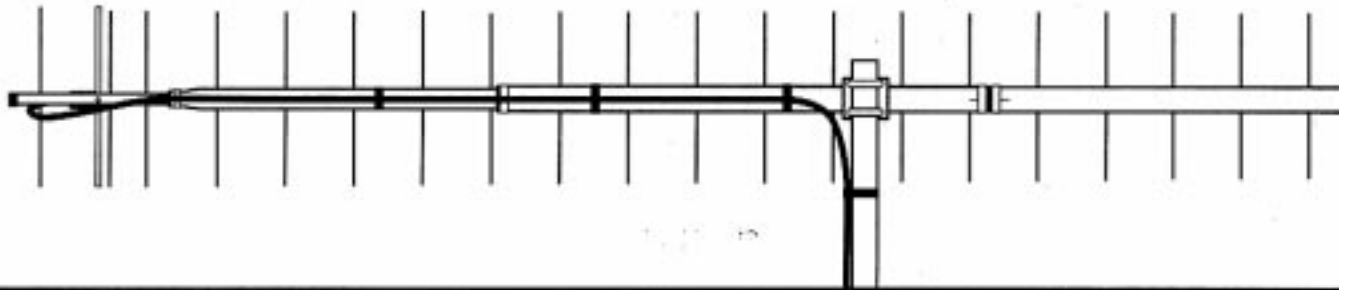







KEY	P/N	DISPLAY	DESC	SIZE	QTY
84	010084		SS LOCK WASHER	1/4" (.64 cm)	4
85	010085		SS HEX NUT	1/4" (.64 cm)	4
104	010104		SS FLAT WASHER	1/4" (.64 cm)	4
118	010118		SS HEX NUT	5/16" (.79 cm)	4
119	010119		SS LOCK WASHER	5/16" (.79 cm)	4
401	010401		SS U-BOLT	1 1/2" x 3" (3.8 x 7.6 cm)	2
404	010404		SS U-BOLT	2 1/2" x 3" (5.5 x 7.6 cm)	2
70	190070		MOUNTING PLATE	4" x 6" (10.2 x 15.2 cm)	1
326	290326		DANGER LABEL		1

FIGURE F



2 ANTENNA STACK

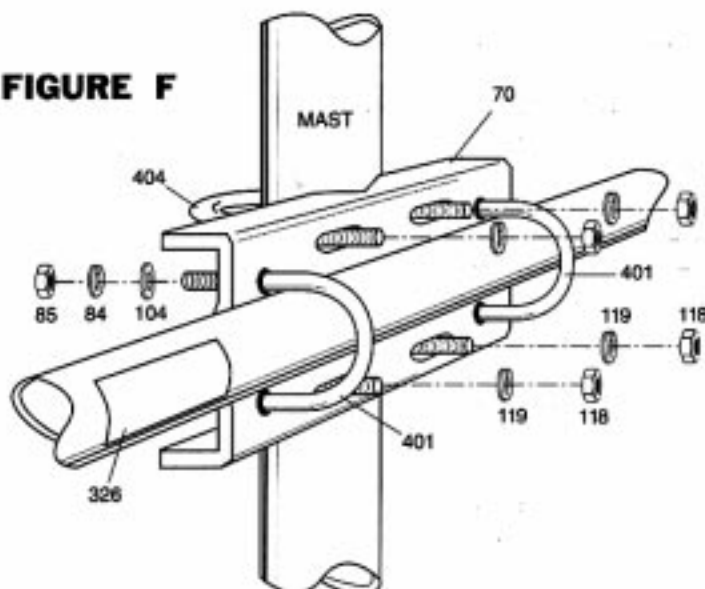
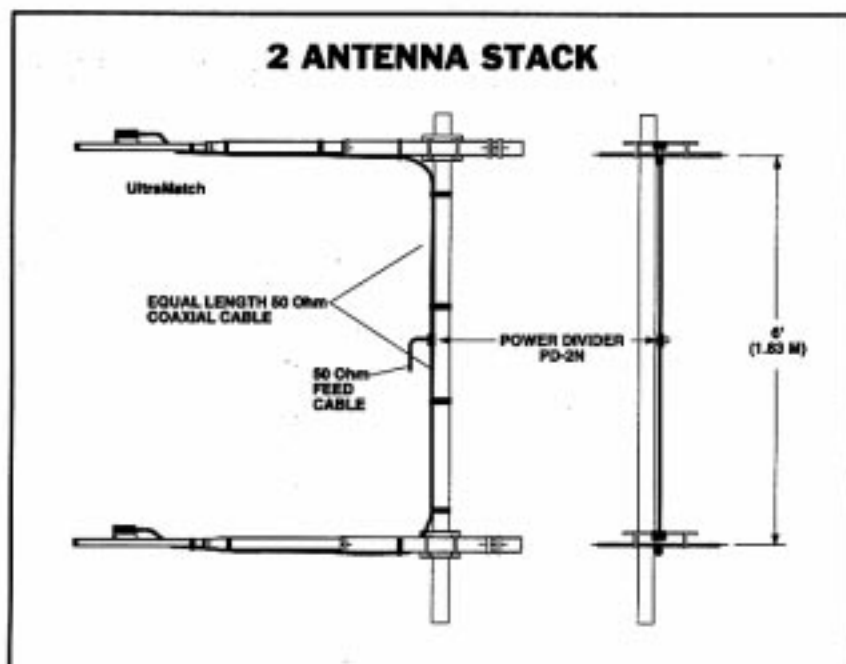

FIGURE G

STACKING OPTIONS

You can stack any number of 729B's as long as you follow the advice below. The optimum stacking distance in the vertical plane is 6' (1.83 m). Note that the UM4N's must be in the same position otherwise the antennas will not work properly due to opposite polarity. When stacking side by side (horizontal), the distance is 6'-3" (1.9 M). The UM4N's must be in the same orientation. Cushcraft manufactures 2 power dividers for the 729B. Use the PD-2N divider for stacking 2 antennas or for 4 729B's use the PD-4N. In either case, use equal lengths of 50 ohm cable for connecting the antennas to the power divider.

FIGURE H

4 ANTENNA STACK

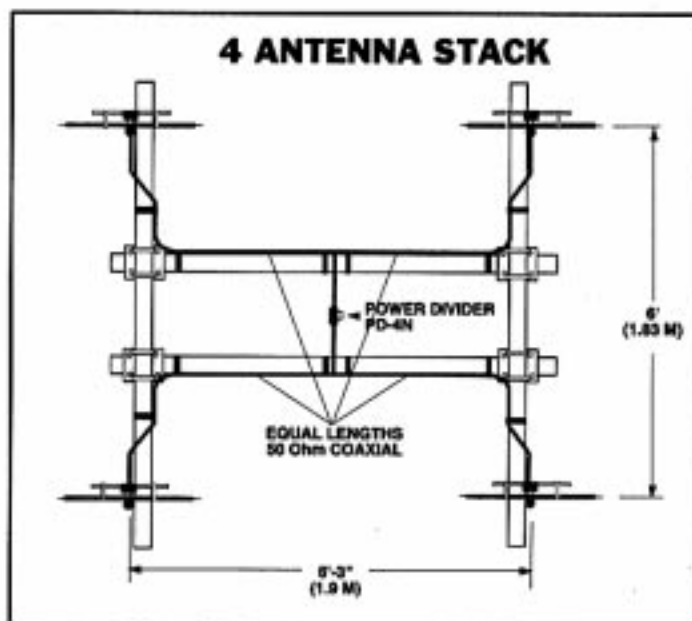

SPECIFICATIONS

MODEL	729B	Side Lobe Atten., dB, E Plane	60
Frequency, MHz	430-440	Boom Length, ft (m)	22.17 (6.75)
No. Elements	29	Electrical Wavelength	9.8
Forward Gain, dBd	17.8	Longest Element, in (cm)	13.75 (34.9)
Front to Back Ratio, dB	25	Turning Radius, ft (m)	12.5 (3.8)
SWR 1.2:1 Typical		Mast Size Range, in (cm)	1.25-2
2:1 Bandwidth MHz	>10		(3.2-5.1)
Power Rating, Watts PEP	2000	Wind Load, ft ² (m ²)	2.2 (.21)
3 dB Beamwidth, Degrees		Weight, lb (kg)	8.6 (3.9)
E Plane	20		
H Plane	22		

MASTER PARTS LIST

KEY	P/N	DESCRIPTION	QTY	KEY	P/N	DESCRIPTION	QTY
9	010009	#8 x 5/8" (1.6 cm) stainless steel hex screw	2	E1	13-11/16" (34.8 cm) aluminum rod	1	
11	010011	#8 hex nut stainless steel	36	E2	1/2" x 13-1/4" (1.3 x 33.7) drilled aluminum tube	1	
26	190026	Element bracket #8 hole	29	E3	12-7/16" (31.6 cm) aluminum rod	1	
28	190028	Aluminum half washer	28	E4	12-3/16" (31 cm) aluminum rod	1	
40		8-32 x 1-1/4" (3.2 cm) stainless steel machine screw	1	E5	12-3/16" (31 cm) aluminum rod	1	
41	010941	#8 stainless steel split lock washer	36	E6	12-1/16" (30.6 cm) aluminum rod	1	
51	050251	1/2" (1.3 cm) white plastic cap	2	E7	11-15/16" (30.3 cm) aluminum rod	1	
53	050053	1/2" (1.3 cm) black plastic cap	2	E8	11-11/16" (29.7 cm) aluminum rod	1	
61	050061	7/8" (2.2 cm) black plastic cap	2	E9	11-11/16" (29.7 cm) aluminum rod	1	
70	190070	Formed mast plate 4" x 6" (10.2 x 15.2 cm)	1	E10	11-11/16" (29.7 cm) aluminum rod	1	
84	010084	1/4" (.6 cm) stainless steel split lock washer	4	E11	11-7/16" (29.1 cm) aluminum rod	1	
85	010085	1/4" (.6 cm) stainless steel hex nut	4	E12	11-7/16" (29.1 cm) aluminum rod	1	
104	010104	1/4" (.6 cm) stainless steel flat washer	4	E13	11-7/16" (29.1 cm) aluminum rod	1	
116	240116	Silicone package	1	E14	11-5/16" (28.7 cm) aluminum rod	1	
118	010118	5/16" (.8 cm) stainless steel hex nut	4	E15	11-5/16" (28.7 cm) aluminum rod	1	
119	010119	5/16" (.8 cm) stainless steel split lock washer	4	E16	11-5/16" (28.7 cm) aluminum rod	1	
120	010120	8-32 x 2" (5.1 cm) stainless steel machine screw	24	E17	11-5/16" (28.7 cm) aluminum rod	1	
231	010231	8-32 x 1-3/4" (4.5 cm) stainless steel machine screw	7	E18	11-3/16" (28.4 cm) aluminum rod	1	
326	290326	Danger label	1	E19	11-3/16" (28.4 cm) aluminum rod	1	
401	010401	U-bolt 3" x 1-3/4" (7.6 x 4.4 cm) stainless steel	2	E20	11-3/16" (28.4 cm) aluminum rod	1	
404	010404	U-bolt 3-1/4" x 2-7/16" (8.3 x 6.2 cm) stainless steel	2	E21	11-3/16" (28.4 cm) aluminum rod	1	
411	030411	Worm clamp 1-1/4" (3.2 cm) stainless steel	2	E22	11-3/16" (28.4 cm) aluminum rod	1	
412	030412	Worm clamp 1-1/2" (3.8 cm) stainless steel	4	E23	11-1/16" (28.1 cm) aluminum rod	1	
921	200921	T-match clamp	4	E24	11-1/16" (28.1 cm) aluminum rod	1	
940	360940	#8 aluminum flat washer	4	E25	11-1/16" (28.1 cm) aluminum rod	1	
BA		7/8" x 24" (2.2 x 61) aluminum tube 6 holes	1	E26	11-1/16" (28.1 cm) aluminum rod	1	
BB		1-1/8" x 50" (2.9 x 127) swedged aluminum tube 6 holes	1	E27	10-15/16" (27.8 cm) aluminum rod	1	
BC		1-1/4" x 75" (3.2 x 190) aluminum tube 8 holes	1	E28	10-13/16" (27.5 cm) aluminum rod	1	
BD		1-1/4" x 75" (3.2 x 190) aluminum tube 8 holes	1	E29	10-7/16" (26.5 cm) aluminum rod	1	
BE		1-1/8" x 50" (2.9 x 127) swedged aluminum tube 5 holes	1	RM	Reddi-match assembly	2	
BF		7/8" x 24" (2.2 x 61) aluminum tube 3 holes	1	UM	UM4N ultramatch balun assembly	1	
BG		1-1/8" x 12-11/16" (2.9 x 32.2) aluminum tube 2 holes	1				

LIMITED WARRANTY

Cushcraft Corporation, P.O. Box 4880, Manchester, New Hampshire 03108, warrants to the original consumer purchaser for one year from date of purchase that each Cushcraft antenna is free of defects in material or workmanship. If, in the judgement of Cushcraft, any such antenna is defective, then Cushcraft Corporation will, at its option, repair or replace the antenna at its expense within thirty days of the date the antenna is returned (at purchasers expense) to Cushcraft or one of its authorized representatives. This warranty is in lieu of all other expressed warranties, any implied warranty is limited in duration to one year. Cushcraft Corporation shall not be liable for any incidental or consequential damages which may result from a defect. Some states do not allow limitations on how long an implied warranty lasts or exclusions or limitations of incidental or consequential damages, so the above limitation and exclusion may not apply to you. This warranty gives you specific legal rights, and you may also have other rights which vary from state to state. This warranty does not extend to any products which have been subject to misuse, neglect, accident or improper installation. Any repairs or alterations outside of the Cushcraft factory will nullify this warranty.



48 PERIMETER ROAD, MANCHESTER, NH 03108 USA

603-627-7877 • TELEX 4949472 • FAX 603-627-1764 • E-mail: techsup@cushcraft.com

SPECIFICATIONS SUBJECT TO CHANGE WITHOUT NOTICE