

ASSEMBLY AND INSTALLATION INSTRUCTIONS

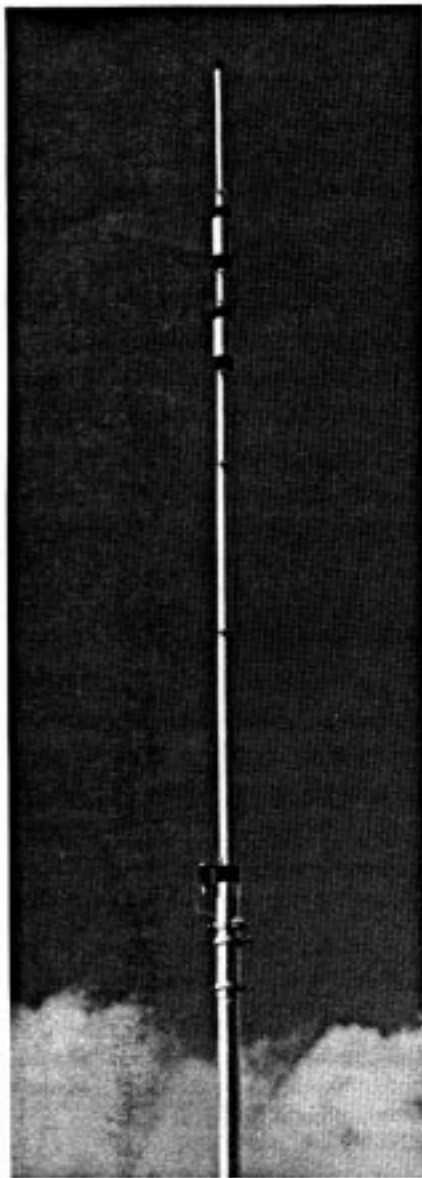

AV-3

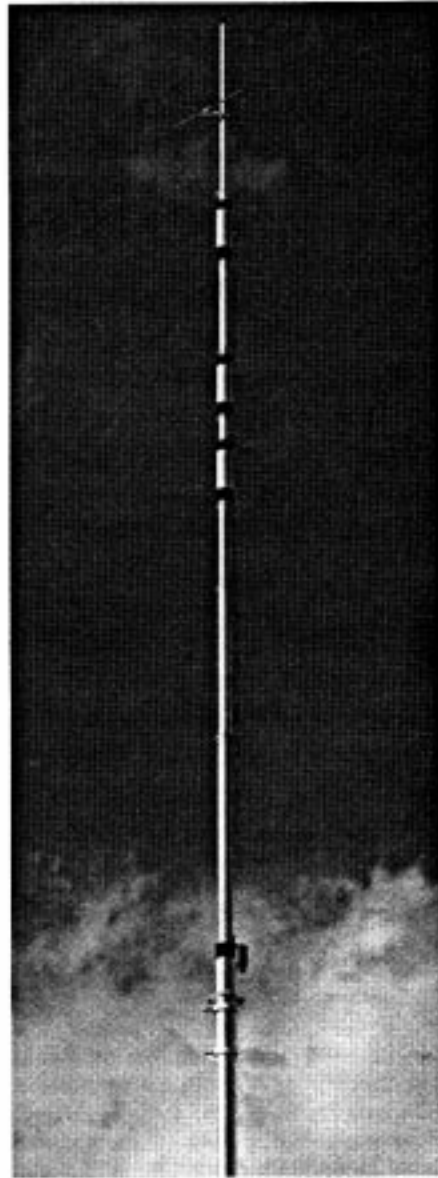

AV-4

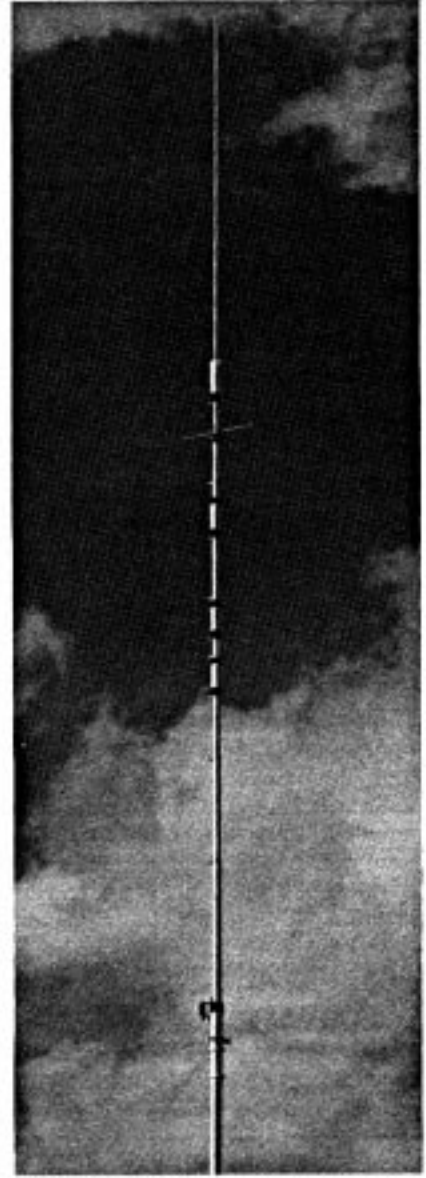

AV-5

ANTENNAS

Your Cushcraft $\frac{1}{4}$ wavelength vertical antenna is designed and manufactured to give trouble free service. The antenna will perform as specified if the instructions and suggestions are followed and care is used in assembly and installation. When checking the tubing received with your antenna package using the parts list, it is easiest to identify the various dimensions of tubing by separating them by diameter.

LOCATION

Location of the antenna is very important. Surrounding objects such as trees, power lines, other antennas, etc. will seriously reduce efficiency. To minimize the effects of surrounding objects, mount the antenna as high and in the clear as possible. If metal guy wires are used, they should be broken with strain insulators. **WARNING: THIS ANTENNA IS AN ELECTRICAL CONDUCTOR. CONTACT WITH POWER LINES CAN RESULT IN DEATH, OR SERIOUS INJURY. DO NOT INSTALL THIS ANTENNA WHERE THERE IS ANY POSSIBILITY OF CONTACT WITH OR HIGH VOLTAGE ARC-OVER FROM POWER CABLES OR SERVICE DROPS TO BUILDINGS. THE ANTENNA, SUPPORTING MAST AND/OR TOWER MUST NOT BE CLOSE TO ANY POWER LINES DURING INSTALLATION REMOVAL OR IN THE EVENT PART OF THE SYSTEM SHOULD ACCIDENTLY FALL. FOLLOW THE GUIDELINES FOR ANTENNA INSTALLATIONS RECOMMENDED BY THE U.S. CONSUMER PRODUCT SAFETY COMMISSION AND LISTED IN THE ENCLOSED PAMPHLET.**

ASSEMBLY

Lay out the parts of the antenna in the order that they will be assembled following Figs. 1, 2 or 3. All arrows on the traps point toward the base. Starting at the base, assemble the radiator and tighten clamps as you move toward the top. Each tubing insert should be 4" (110.2cm) except the section just below each trap which is adjusted using dimensions from Chart I.

Assemble the base as shown in Fig. 8. For AV-4 and AV-5 assemble the capacitive X-hat.

Cushcraft has included weatherproof connector boots for PL259 connector used on your new antenna. To get the most out of them, please follow these simple directions:

1. Insert the antenna end of your coax through the small end of the connector boot. RGB is very tight which results in an excellent weather seal. Attach the PL259. If your antenna includes a phasing harness this step was completed at the factory.
2. Cut off the top of the silicone seal package and apply a liberal amount to the threads of the connector mounted on the antenna. Screw the PL259 on the feedline on this connector. Tighten it finger tight.
3. Now apply the remaining silicone to the outside of the connector. Cover it liberally. Be sure to cover the back as this will insure a good weather seal. Slip boot over the connector. Push it as far forward as possible.

INSTALLATION



The AV-3, AV-4, and AV-5 may be mounted in any of several configurations. It is important to mount the antennas as "in the clear" as possible, away from any metallic or conducting objects that might interfere with normal operation. The desired mounting configuration will determine which type radial/ground system will be the most efficient and practical.

CAUTION: WHEN OPERATING THE ANTENNA, ENSURE THAT NO ONE CAN COME IN CONTACT WITH THE ANTENNA OR RADIAL SYSTEM, A SERIOUS SHOCK CAN RESULT. IN ADDITION, BE SURE THE ANTENNA AND RADIALS CANNOT COME IN CONTACT WITH ELECTRICAL CONDUCTORS ESPECIALLY POWER LINES AT ANY TIME.

TESTING AND ADJUSTMENT

After assembling and installing your Cushcraft vertical, check the SWR, using low power, to determine if it is tuned to the desired part of the band. There are apt to be slight variations, due to the mounting configuration and radial system, but except for 80 meters, and to a lesser extent 40 meters, these should not be of great consequence. Some variation from the typical SWR graphs should not seriously degrade performance. If the antenna does not exhibit a low SWR at the desired frequency, it can be adjusted by using the Nominal Dimensions Chart and the SWR curves as a guide. For example, adjusting the "A" dimension will affect 10 meters and, to a lesser extent, all lower frequencies. The "B" dimension, primarily affecting 15 meters, will not change 10 meters, but does have a small effect on the lower frequency bands.

NOMINAL DIMENSIONS - CHART 1

SECTION	 CW	 CENTER	 PHONE
AV-3			
A	84" (213.4cm)	82½" (209.6cm)	80½" (204.5cm)
B	6¾" (17.1cm)	6¾" (16.2cm)	5¾" (14.6cm)
C	33¾" (84.5cm)	33" (83.8cm)	32¾" (83.2cm)
OVERALL*	13'1½" (4.00m)	12'11¾" (3.94m)	12'8½" (3.87m)
AV-4			
A	84" (213.4cm)	82½" (209.6cm)	80½" (204.5cm)
B	6¾" (17.1cm)	6¾" (16.2cm)	5¾" (14.6cm)
C	21¼" (54.0cm)	20¾" (51.8cm)	20¼" (51.4cm)
D	59½" (151.1cm)	57" (144.8cm)	54½" (138.4cm)
OVERALL*	18' (5.48m)	17'6¾" (5.35m)	17'1¼" (5.21m)
AV-5			
A	84" (213.4cm)	82½" (109.6cm)	80½" (204.5cm)
B	6¾" (17.1cm)	6¾" (16.2cm)	5¾" (14.6cm)
C	21" (53.3cm)	20½" (52.1cm)	19¾" (50.2cm)
D	47½" (120.7cm)	45½" (115.6cm)	43¾" (111.1cm)
E1	112" (284.5cm)	99½" (252.7cm)	86" (218.4cm)
E2	110" (279.4cm)	96" (243.8cm)	82½" (209.6cm)
E3	106½" (270.5cm)	92¼" (234.3cm)	79" (200.7cm)
E4	103" (161.6cm)	88¾" (225.4cm)	76" (193.0cm)
OVERALL*	27¾" (8.24m)	25'9¾" (7.87m)	24'1¼" (7.36m)

* Overall height, including base

TYPICAL SWR GRAPHS

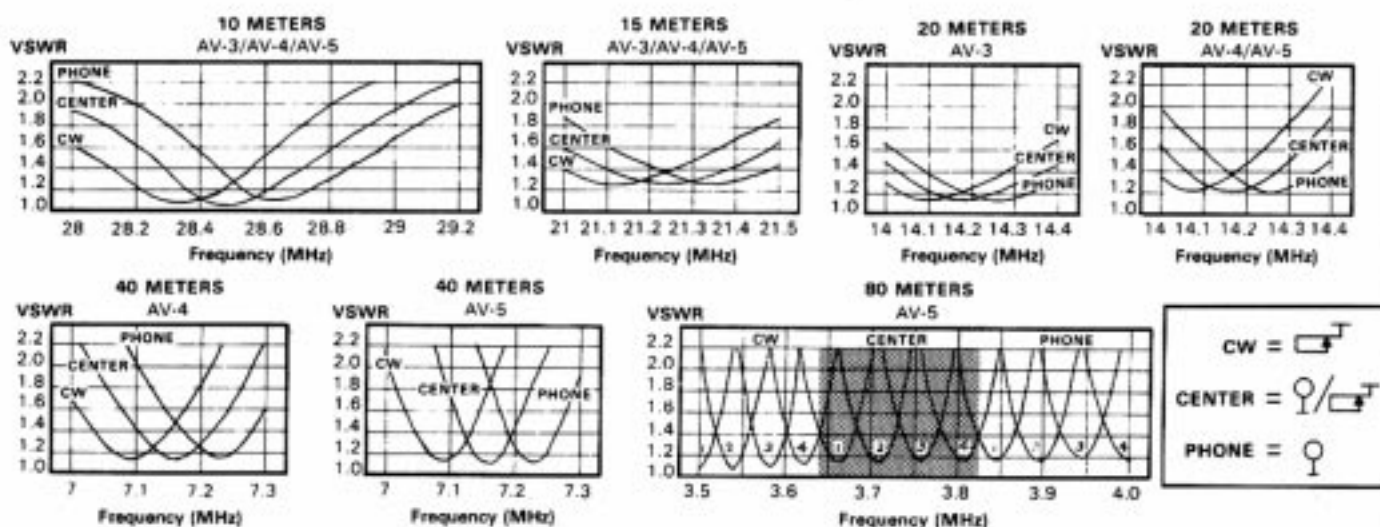

10 METERS
AV-3/AV-4/AV-5

VSWR vs Frequency (MHz) 28-29.2

15 METERS
AV-3/AV-4/AV-5

VSWR vs Frequency (MHz) 21-21.5

20 METERS
AV-3

VSWR vs Frequency (MHz) 14-14.4

20 METERS
AV-4/AV-5

VSWR vs Frequency (MHz) 14-14.4

40 METERS
AV-4













VSWR vs Frequency (MHz) 7-7.3

40 METERS
AV-5

VSWR vs Frequency (MHz) 7-7.3

80 METERS
AV-5

VSWR vs Frequency (MHz) 3.5-4.0

P/N	DETAIL	DESC.	SIZE	QTY		
				AV-3	AV-4	AV-5
HSS-16		WORM CLAMP	1½" (3.81cm)	7	10	10
GS-4SS		WORM CLAMP	¾" (.95cm)	-	-	2
40		MACHINE SCREW	#8-32 x 1¼" (3.2cm)	-	1	1
10		INTERNAL TOOTH WASHER	#8	-	3	3
11		HEX NUT	#8-32	-	1	1
157		FORMED ALUMINUM BRACKET	2" x ¾" (5.1 x 1.9cm)	-	1	1
116		SILICONE GREASE PKT.	-	1	1	1
115		VINYL CONN. BOOT	-	1	1	1
61		BLACK PLASTIC CAP	¾" (2.2cm)	1	1	-
25		FORMED ALUMINUM BRACKET	¾" (2.2cm)	-	1	1
77		BLACK PLASTIC CAP	¾" (.95cm)	-	-	1
500		WARNING LABEL	-	1	1	1

AV-4, AV-5 X-HAT ASSEMBLY

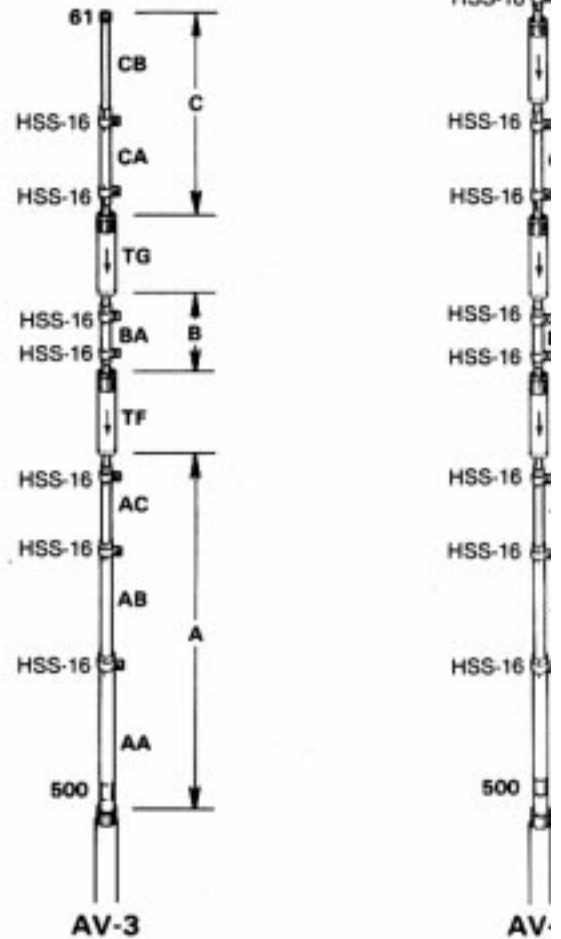
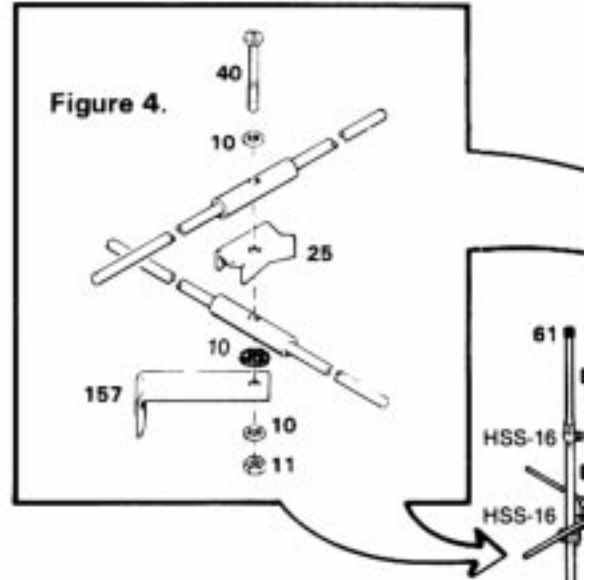

Figure 1.

Figur

ASSEMBLY

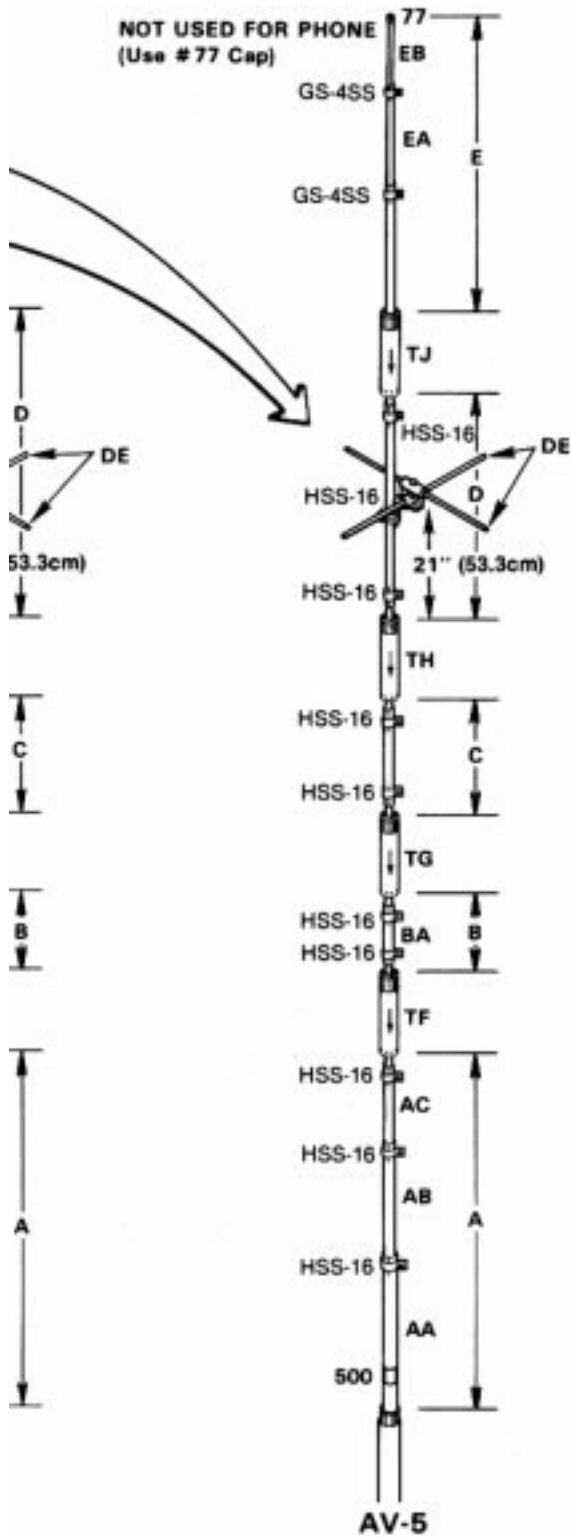

Figure 3.

P/N	DETAIL	DESC.	SIZE	QTY		
				AV-3	AV-4	AV-5
AA		ASSEMBLED BASE SECT.	-	1	1	1
AB		ALUMINUM TUBING	1 1/4" OD x 16" (3.2 x 40.6cm) x .058"	1	1	1
AC		ALUMINUM TUBING	1 1/4" OD x 50" (2.86 x 127cm) SWAGED	1	1	1
BA		ALUMINUM TUBING	1" OD x 5 1/4" (2.54 x 13.34cm) x .058"	1	1	1
CA		ALUMINUM TUBING	1" OD x 18" (2.54 x 45.7cm) x .058"	1	1	1
DA		ALUMINUM TUBING	1" OD x 42" (2.54 x 106.7cm) x .049"	-	1	1
CB/DB		ALUMINUM TUBING	3/4" x 24" (2.2 x 60.9cm) x .049"	1	1	-
EA		ALUMINUM TUBING	3/4" x 48 (0.95 x 121.92cm) x .058"	-	-	1
EB		ALUMINUM ROD	3/4" x 36" (0.64 x 91.44cm)	-	-	1
TF		10 METER	-	1	1	1
TG		15 METER	-	1	1	1
TH		20 METER	-	-	1	1
TJ		40 METER	-	-	-	1
DE		ALUMINUM ROD	3/16" x 28 3/4" (0.48 x 73.03cm)	-	2	2
-		INSTRUCTION MANUAL	-	1	1	1

MOUNTING CONFIGURATIONS

**GROUND MOUNTED
RADIAL LENGTH (CHART 2)**

BAND	FREQUENCY	LENGTH	
		ft./inches	Meters
80	3.500	56-2	17.13
	3.750	52-5	15.97
	4.000	49-2	14.99
40	7.000	28-1	8.56
	7.150	27-6	8.38
	7.300	26-11	8.20
20	14.000	14-0	4.27
	14.175	13-10	4.21
	14.350	13-8	4.18
15	21.000	9-5	2.87
	21.225	9-4	2.84
	21.450	9-2	2.80
10	28.000	7-0	2.13
	28.500	6-11	2.10
	29.000	6-10	2.07

Figure 5.
Example: AV-5

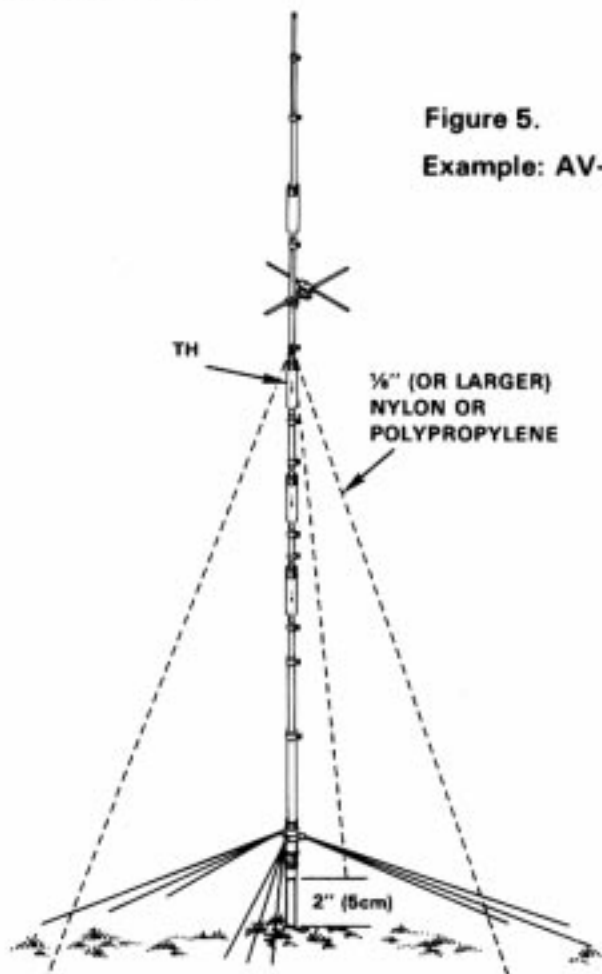
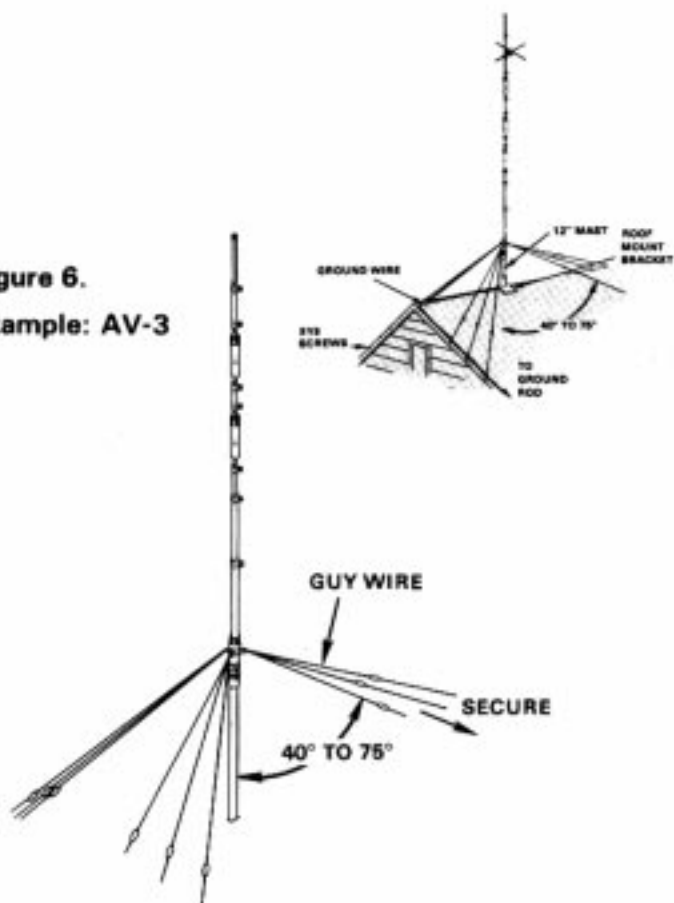







Figure 6.
Example: AV-3



**ROOF MOUNTED
RADIAL LENGTH (CHART 3)**

BAND	FREQUENCY	LENGTH	
		ft./inches	Meters
80	3.500	70-8	21.55
	3.750	66-0	20.12
	4.000	61-10	18.86
40	7.000	35-4	10.78
	7.150	34-7	10.55
	7.300	33-7	10.33
20	14.000	17-8	5.39
	14.175	17-5	5.32
	14.350	17-3	5.26
15	21.000	11-9	3.59
	21.225	11-8	3.56
	21.450	11-7	3.52
10	28.000	10-8	2.69
	28.500	8-9	2.65
	29.000	8-7	2.60

BASE ASSEMBLY

P/N	DETAIL	DESC.	SIZE	QTY		
				AV-3	AV-4	AV-5
83		MACHINE SCREW	¼-20 x 1¼" (3.2cm)	5	5	5
84		SPLIT WASHER	¼" (.64cm)	8	8	8
85		HEX NUT	¼-20	8	8	8
90		MAST MOUNT RING CLAMP	-	2	2	2
104		FLAT WASHER	¼" (.64cm)	6	6	6
105		FORMED ALUMINUM CLAMP	-	3	3	3

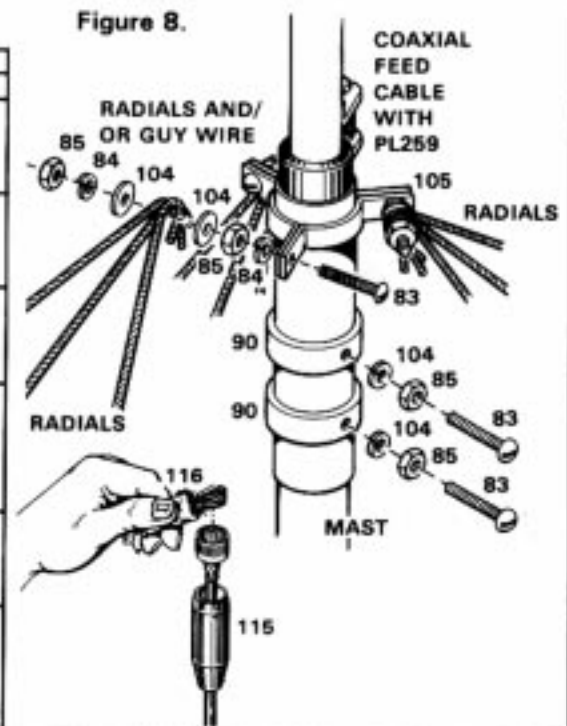

TROUBLESHOOTING

TROUBLE	PROBABLE CAUSE	REMEDY
VSWR high or intermittent on 10-meters only; possibly noticeable change on 15-meters. (AV-3/4/5)	10-meters ground system loose connection(s) or incorrect radial length. 10-meter trap is defective.	Repair 10-meter ground connection(s) or reset radial length. Replace 10-meter trap.
VSWR high or intermittent on 15-meters only; possibly noticeable change on 20-meters. (AV-3/4/5)	15-meter ground system has loose connection(s) or incorrect radial length. 15-meter trap is defective.	Repair 15-meter ground connection(s) or reset radial length. Replace 15-meter trap.
VSWR high or intermittent on 20-meters only; possibly noticeable change on 40-meters. (AV-3/4/5)	20-meter ground system has loose connection(s) or incorrect radial length. 20-meter trap (AV-4/5) has defective capacitor.	Repair 20-meter ground connection(s) or reset radial length. Replace 20-meter trap.
VSWR high or intermittent on 40-meters only; possibly noticeable change on 80-meters. (AV-4/5)	40-meter ground system has loose connection(s) or incorrect radial length. 40-meter trap (AV-5) is defective.	Repair 40-meter ground connection(s), or reset radial length. Replace 40-meter trap.
VSWR high or intermittent on 80-meters only. (AV-5)	80-meter ground system has loose connection(s) or incorrect radial length. 40-meter trap is defective.	Repair 80-meter ground connection(s), or reset radial length. Replace 40-meter trap.
VSWR high or intermittent on all bands (AV-3/4/5)	Ground system has loose connection(s) or incorrect radial lengths. Feed line or transmitter connection(s) faulty. 10-meter trap is defective.	Repair ground connections or radial lengths. Repair or replace feedline or connection(s). Replace 10-meter trap.
VSWR high or intermittent on all bands, except 10-meters. (AV-3/4/5)	15-meter trap defective. Ground system has loose connection(s) or incorrect radial lengths, except on 10-meters.	Replace 15-meter trap. Repair ground connections or radial lengths.
VSWR high or intermittent on all bands, except 10 and 15-meters. (AV-4/5)	20-meter trap defective. Ground system has loose connection(s) or incorrect radial lengths, except on 10 and 15-meters.	Repair ground connections or radial lengths. Replace 20-meter trap.
VSWR high or intermittent on 40 and 80-meters. (AV-5)	40-meter trap defective. 40 and 80-meter ground system has loose connection(s) or incorrect lengths.	Repair ground connections or radial lengths. Replace 40-meter trap.

SPECIFICATIONS			
	AV-3	AV-4	AV-5
Overall Height - CW - Phone	13 ft. 1½" (3.98m) 12 ft. 8½" (3.94m)	18 ft. (5.58m) 17 ft. 1¼" (5.33m)	27 ft. ¾" (8.37m) 24 ft. 1¾" (7.44m)
Wind Surface Area - CW	1.02 sq. ft. (.10 sqm)	1.46 sq. ft. (.14 sqm)	1.89 sq. ft. (.1859 sqm)
Assembled Weight	5.21 lbs (2.33kg)	7.15 lbs (3.22kg)	8.41 lbs (3.78kg)
Maximum Mast Diameter	1¾" (4.5cm)	1¾" (4.5cm)	1¾" (4.5cm)
Frequency Coverage (MHz)	28.0 - 29.2 21.0 - 21.5 14.0 - 14.4	28.0 - 29.2 21.0 - 21.5 14.0 - 14.4 7.0 - 7.3	28.0 - 29.2 21.0 - 21.5 14.0 - 14.4 7.0 - 7.3 3.5 - 4.0
Nominal Input Impedence	50 ohms (Takes PL-259 Connector)		
Standing - Wave Ratio	1.5:1 or less at Resonance		
Power Handling Capability	2000 Watts P.E.P.		
Element Material	6063 - T832 Hard-Drawn, Bright Finish Aluminum Tubing		
Trap Material	¾" (3.1cm) Wall Fiberglass Tubing, with Copper or Aluminum Wire		

LIMITED WARRANTY

CUSHCRAFT CORPORATION, P.O. BOX 4680, MANCHESTER, NEW HAMPSHIRE 03108. WARRANTS TO THE ORIGINAL CONSUMER PURCHASER FOR ONE YEAR FROM DATE OF PURCHASE THAT EACH CUSHCRAFT ANTENNA IS FREE OF DEFECTS IN MATERIAL OR WORKMANSHIP. IF, IN THE JUDGEMENT OF CUSHCRAFT, ANY SUCH ANTENNA IS DEFECTIVE, THEN CUSHCRAFT CORPORATION WILL, AT ITS OPTION, REPAIR OR REPLACE THE ANTENNA AT ITS EXPENSE WITHIN THIRTY DAYS OF THE DATE THE ANTENNA IS RETURNED (AT PURCHASER'S EXPENSE) TO CUSHCRAFT OR ONE OF ITS AUTHORIZED REPRESENTATIVES. THIS WARRANTY IS IN LIEU OF ALL OTHER EXPRESSED WARRANTIES. ANY IMPLIED WARRANTY IS LIMITED IN DURATION TO ONE YEAR. CUSHCRAFT CORPORATION SHALL NOT BE LIABLE FOR ANY INCIDENTAL OR CONSEQUENTIAL DAMAGES WHICH MAY RESULT FROM A DEFECT. SOME STATES DO NOT ALLOW LIMITATIONS ON HOW LONG AN IMPLIED WARRANTY LASTS OR EXCLUSIONS OR LIMITATIONS OF INCIDENTAL OR CONSEQUENTIAL DAMAGES. SO THE ABOVE LIMITATION AND EXCLUSION MAY NOT APPLY TO YOU. THIS WARRANTY GIVES YOU SPECIFIC LEGAL RIGHTS, AND YOU MAY ALSO HAVE OTHER RIGHTS WHICH VARY FROM STATE TO STATE. THIS WARRANTY DOES NOT EXTEND TO ANY PRODUCTS WHICH HAVE BEEN SUBJECT TO MISUSE, NEGLIGENCE, ACCIDENT OR IMPROPER INSTALLATION. ANY REPAIRS OR ALTERATIONS OUTSIDE OF THE CUSHCRAFT FACTORY WILL NULLIFY THIS WARRANTY.

