

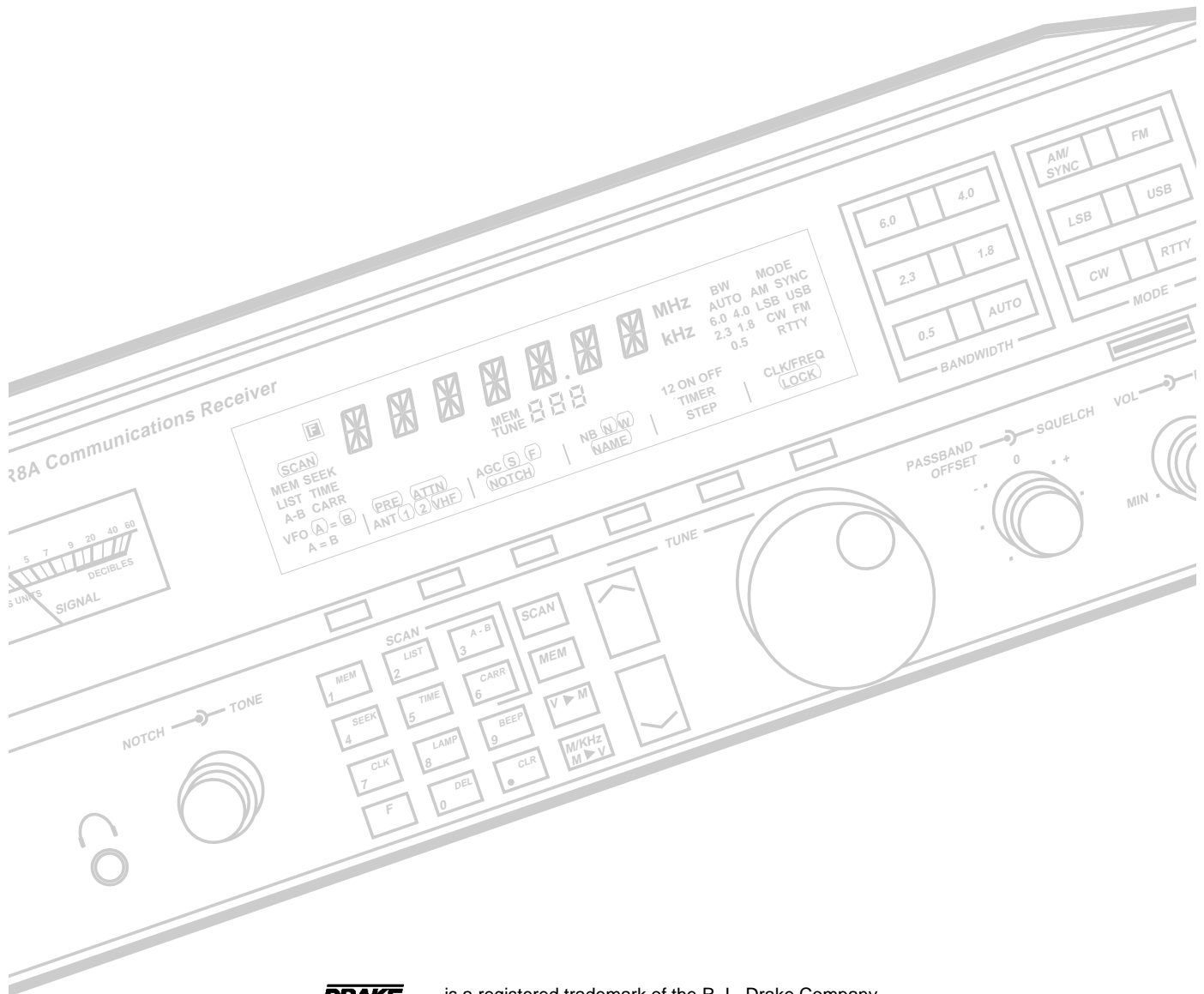

R8A Communications Receiver

Owner's Manual



DRAKE® is a registered trademark of the R. L. Drake Company

© Copyright 1997 R. L. Drake Company P/N: 3851299H-1-1997 Printed in the U. S. A.

Declaration of Conformity

We, Manufacturer/Importer

(Full address)

R. L. Drake Company
230 Industrial Drive
Franklin, Ohio 45005 United States of America

declare that the product

(Description of the apparatus, system, installation to which it refers)

R8A Communications Receiver
1293

is in conformity with

(reference to the specifications under which conformity is declared)
in accordance with 89/336 EEC-EMC Directive

- | | | | |
|---------------------------------------------------------|------------------------------------------------------------------------------------------------------------------------------------------------------------|---------------------------------------------------|-----------------------------------------------------------------------------------------------------------------------|
| <input type="checkbox"/> EN 55011 | Limits and methods of measurement of radio disturbance characteristics of industrial, scientific and medical (ISM) high frequency equipment | <input checked="" type="checkbox"/> EN 61000-3-2* | Disturbances in supply systems caused by household appliances and similar electrical equipment "Harmonics" |
| <input checked="" type="checkbox"/> EN 55013 | Limits and methods of measurement of radio disturbance characteristics of broadcast receivers and associated equipment | <input checked="" type="checkbox"/> EN 61000-3-3* | Disturbances in supply systems caused by household appliances and similar electrical equipment "Voltage fluctuations" |
| <input type="checkbox"/> EN 55014 | Limits and methods of measurement of radio disturbance characteristics of household electrical appliances, portable tools and similar electrical apparatus | <input type="checkbox"/> EN 50081-1 | Generic emission standard |
| <input type="checkbox"/> EN 55015 | Limits and methods of measurement of radio disturbance characteristics of fluorescent lamps and luminaries | <input checked="" type="checkbox"/> EN 50082-1 | Generic immunity standard |
| <input type="checkbox"/> EN 55020 | immunity from radio interference of broadcast receivers and associated equipment | <input checked="" type="checkbox"/> prEN 55024-2 | Electrostatic discharge requirements "ESD" (IEC 801-2) |
| <input checked="" type="checkbox"/> EN 55022 | Limits and methods of measurement of radio disturbance characteristics of information technology equipment | <input checked="" type="checkbox"/> prEN 55024-3 | Radiated, radio frequency electromagnetic field (IEC 801-3) |
| <input type="checkbox"/> DIN V VDE 0855 part 10 part 12 | Cabled distribution systems; Equipment for receiving and/or distribution from sound and television signals | <input checked="" type="checkbox"/> pr EN 55024-4 | Electrical fast transient requirements "Burst" (IEC 801-4) |
| <input checked="" type="checkbox"/> CE marking | | <input type="checkbox"/> prENV 50142 | Surge immunity requirements (IEC 801-5) |
| | | <input type="checkbox"/> ENV 50141 | Immunity to conducted disturbances induced by radio frequency fields above 9kHz (IEC 801-6) |
| | | <input type="checkbox"/> | |

* Replacement of EN60555-2/-3

CE (EC conformity marking)

The manufacturer also declares the conformity of above mentioned product with the actual required safety standards in accordance with LVD 73/23 EEC.

- | | | | |
|----------------------------------------------|---------------------------------------------------------------------------------------------------------------|----------------------------------------------|-------------------------------------------------------------------------------------|
| <input checked="" type="checkbox"/> EN 60065 | Safety requirements for mains operated electronic and related apparatus for household and similar general use | <input checked="" type="checkbox"/> EN 60950 | Safety for information technology equipment including electrical business equipment |
|----------------------------------------------|---------------------------------------------------------------------------------------------------------------|----------------------------------------------|-------------------------------------------------------------------------------------|

Manufacturer/Importer

DRAKE®
(Stamp)

Signature Ronald E. Wysong

Date: January 01, 1997

Name: Ronald E. Wysong

EMC Tested by  electronic GmbH



Date: October 16, 1995

Signature G. Raithel

Ref. No. 953427

Name: G. Raithel Dipl.-Ing.

WARNING: TO PREVENT FIRE OR ELECTRICAL SHOCK DO NOT EXPOSE TO RAIN OR MOISTURE

	!WARNING! RISK OF ELECTRIC SHOCK DO NOT OPEN	
<p>WARNING: TO REDUCE THE RISK OF ELECTRIC SHOCK, DO NOT REMOVE COVER (OR BACK) NO USER-SERVICABLE PARTS INSIDE REFER SERVICING TO QUALIFIED PERSONNEL</p>		



An appliance and cart combination should be moved with care. Quick stops, excessive force and uneven surfaces may cause the appliance and cart combination to overturn.

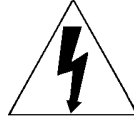

The lightning flash with arrow head symbol, within an equilateral triangle, is intended to alert the user to the presence of uninsulated "dangerous voltage" within the product's enclosure that may be of sufficient magnitude to constitute a risk of electric shock to persons.



The exclamation point within an equilateral triangle is intended to alert the user to the presence of important operating and maintenance (servicing) instructions in the literature accompanying the appliance.

WARNING: TO REDUCE THE RISK OF FIRE OR ELECTRIC SHOCK, DO NOT EXPOSE THIS APPLIANCE TO RAIN OR MOISTURE.
DO NOT OPEN THE CABINET, REFER SERVICING TO QUALIFIED PERSONNEL ONLY.

CAUTION: TO PREVENT ELECTRIC SHOCK, DO NOT USE THE THREE WIRE CORD WITH AN EXTENSION CORD RECEPTACLE OR OTHER OUTLET UNLESS THE BLADES CAN BE FULLY INSERTED TO PREVENT BLADE EXPOSURE.

ATTENTION: POUR PREVENIR LES CHOCS ELECTRIQUES, NE PAS UTILISER CETTE FICHE POLARISEE AVEC UN PROLONGATEUR, UNE PRISE DE COURANT OU UNE AUTRE SORTIE DE COURANT, SAUF SI LES LAMES PEUVENT ETRE INSEREES A FOND SANS EN LAISSER AUCUNE PARTIE A DECOUVERT.

1. Read Instructions—All the safety and operating instructions should be read before the appliance is operated.

2. Retain Instructions—The safety and operating instructions should be retained for future reference.

3. Heed Warnings—All warnings on the appliance should be adhered to.

4. Follow Instructions—All operating and use instructions should be followed.

5. Cleaning—Unplug this appliance from the wall outlet before cleaning. Do not use liquid cleaners or aerosol cleansers. Use a damp cloth for cleaning.

6. Do Not Use Attachments—not recommended by the manufacturer or they may cause hazards.

7. Water and Moisture—Do not use this product near water—for example, near a bathtub, wash bowl, kitchen sink, laundry tub, in a wet basement, or near a swimming pool—and the like.

8. Accessories—Do not place this product on an unstable cart, stand, tripod, bracket, or table. The product may fall, causing serious injury to a child or adult, and serious damage to the appliance.

9. Ventilation—This product should never be placed near or over a radiator or heat register. This product should not be placed in a built-in installation such as a bookcase or rack unless proper ventilation is provided or the manufacturer's instructions have been adhered to. Any slots or openings in the cabinet are provided for ventilation. To ensure reliable operation of the video product and to protect it from overheating, these openings must not be blocked or covered. The openings should never be blocked by placing the product on a bed, sofa, rug, or other similar surface.

10. Grounding or Polarization—This product is equipped with a 3-wire line cord receptacle. It is intended for use with a 3-wire properly grounded power socket. Do not defeat the safety purpose of the supplied line cord and plug.

10A. Mise à la terre ou Polarisation—Cet appareil est équipé avec un cordon d'alimentation à trois fils. Il est à brancher sur une prise ayant un connecteur à la terre. Assurez-vous que la connection à la terre ne manque pas.

11. Power Sources—This product should be operated only from the type of power source indicated on the marking label. If you are not sure of the type of power supplied to your home, consult your appliance dealer or local power company.

12. Power-cord Protection—Power-supply cords should be routed so they are not likely to be walked on or pinched by items placed upon or against them. Pay particular attention to cords at plugs, convenience receptacles, and the point where they exit from the appliance.

13. Lightning—For added protection for this product during a lightning storm, or when it is left unattended and unused for long periods of time, unplug it from the wall outlet.

14. Power Lines—An outside antenna system should not be located in the vicinity of overhead power lines, other electric light or power circuits, where it can fall into such power lines or circuits. When installing an outside antenna system, extreme care should be taken to keep from touching such power lines or circuits as contact with them may be fatal.

15. Overloading—Do not overload wall outlets and extension cords as this can result in a risk of fire or electric shock.

16. Object and Liquid Entry—Never push objects of any kind into this product through openings as they may touch dangerous voltage points or short-out parts that could result in a fire or electric shock. Never spill liquid of any kind on the product.

17. Servicing—Do not attempt to service this product yourself as opening or removing covers may expose you to dangerous voltage or other hazards. Refer all servicing to qualified service personnel.

18. Damage Requiring Service—Unplug this product from the wall outlet and refer servicing to qualified service personnel under the following conditions:

- a. When the power-supply cord or plug is damaged.
- b. If liquid has been spilled, or objects have fallen into the product.
- c. If the product has been exposed to rain or water.
- d. If the product does not operate normally by following the operating instructions. Adjust only those controls that are covered by the operating instructions. An improper adjustment may result in damage and will often require extensive work by a qualified technician to restore the product to its normal operation.
- e. If the product has been dropped or the cabinet has been damaged.
- f. When the product exhibits a distinct change in performance—this indicates a need for service.

19. Replacement Parts—When replacement parts are required, be sure the service technician has used replacement parts specified by the manufacturer or have the same characteristics as the original parts. Unauthorized substitutes may result in fire, electric shock or other hazards.

20. Safety Check—Upon completion of any service or repairs to this product, ask the service technician to perform safety checks to determine that the product is in proper operating condition.

21. Outdoor Antenna Grounding—Before attempting to install this product, be sure the antenna or cable system is grounded so as to provide some protection against voltage surges and built-up static charges.

- a. Use No.10 AWG (5.3mm²) copper, No.8 AWG (8.4mm²) aluminum, No.17 AWG (1.0mm²) copper-clad steel or bronze wire or larger, as ground wire.
- b. Secure antenna lead-in and ground wires to house with stand-off insulators spaced from 4 feet (1.22m) to 6 feet (1.83m) apart.
- c. Mount antenna discharge unit as close as possible to where lead-in enters house.
- d. A driven rod may be used as the grounding electrode where other types of electrode systems do not exist. Refer to the National Electrical Code, ANSI/NFPA 70-1990 for information.
- e. Use jumper wire not smaller than No.6 AWG (13.3mm²) copper or equivalent, when a separate antenna grounding electrode is used.

" INSTALL WIRING ACCORDING TO THE CANADIAN ELECTRICAL CODE"
"EFFECTUER LE CABLAGE CONFORMEMENT AU CODE CANADIEN DE L' ELECTRICITE"

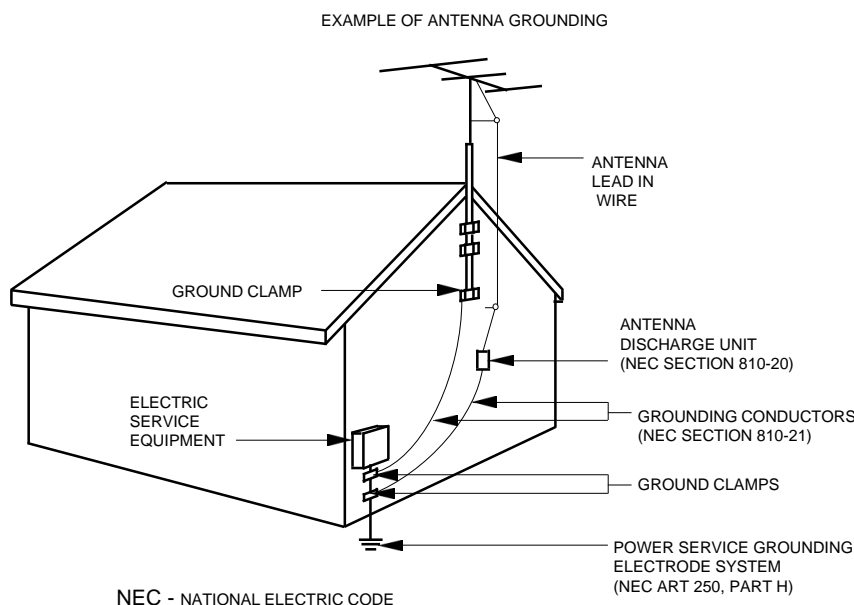

Thank you for purchasing a Drake R8A Communications Receiver. This receiver has been designed and manufactured to high quality standards, and will provide reliable operation for many years.

Please carefully read the Owner's Manual in order to take advantage of the many interesting features that will provide enjoyable listening to radio broadcasts around the world.

Important Safeguards	1	Memory Functions	20
Introduction	4	Memory Location Programming	21
Safety / Voltage Selection		Recalling A Memory Location	21
General Description	5	Deleting A Memory Location	21
Specifications / Accessories	6	Erase All Memory Channels	21
Installation	7	Locking A Memory Location	21
Unpacking		Scan Functions	22
Location		Scan Memory	22
Fixed Installation		Scan Memory List Block	23
Mobile Installation		Locking A Memory Location	23
Antenna Requirements		Scan A - B	24
Installation Diagram	8	Important Notes About Scanning	24
Front Panel Description	9	Clock and Timer Functions	25
Front Panel Display	11	Time Display	25
Rear Panel Description	13	Setting The 24 Hour Clocks	25
Mute Operation of the Receiver	14	Timer Operation	25
Getting Started	15	Setting Timer On/Off Times	25
General Operating Information	15	Enabling/Disabling Timer Operation	26
Microprocessor Reset	15	Timer Connector Interface	28
Beep Tones	15	Special Use Features and Functions	29
Getting Started	15	Function Line Invert	29
Frequency Step Selection	15	Setting Power Off (On) Lamp Brightness	29
Dual VFO's	16	10 kHz/9 kHz Scan	29
Direct Frequency Entry	16	Delete All Memory Locations	29
Front Panel Lock	17	Power On Button Functions	29
Passband Offset Operation	17	Held Button Functions	29
Notch Operation	17	RS232C Interface	30
AM Synchronous Detector	17	Glossary of Terms	34
RF Function (Attenuator/Preamplifier)	17	Suggested References	35
Noise Blanker	18	Quick Reference Guide	36
CW Operation	18	Troubleshooting	38
RTTY Operation	18	Special Display Messages	38
SSB Operation	18	Service	39
FM Operation	18	Warranty	40
Gain and AGC Operation	19		

SAFETY/VOLTAGE SELECTION

WARNING!!!

Please read before applying power

The receiver is normally shipped with the input line voltage selector switch set to 108-132 VAC for operation in the U.S. and Canada. If your operating voltage is different than this, please refer to FIGURE 1 below. The voltage select switch is located on the rear panel and must be set to the proper voltage range for your area. In addition, the proper mains fuse may need to be installed. The unit may be set to operate over the following voltage ranges: 90-110 VAC, 108-132 VAC, 180-220 VAC and 216-264 VAC. Most countries outside the U.S. and Canada use either 220 VAC or 240 VAC line voltage. Please be certain of the operating voltage before connecting to the mains source. The receiver will operate on either 50 Hz or 60 Hz line frequency.

Note: The warranty does not cover damage as a result of improper voltage selection, or replacement of fuse with ratings other than those specified.

Antenna grounding is necessary if the unit is connected to an outdoor antenna. Grounding of the antenna system is required to protect against static build up and voltage surges. Refer to section 810-21 of the National Electric Code, ANSI/NFPA No. 70-1990.

The power cord and antenna lead-in should be disconnected if the unit is not to be used for an extended period of time or if threatening weather containing damaging lightning is likely.

FIGURE 1 VOLTAGE SELECTOR SWITCH SETTINGS

Setting for 108-132 VAC
Fuse rating 400mA

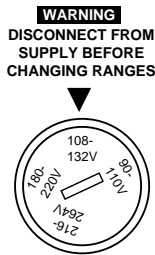

Setting for 90-110 VAC
Fuse rating 400mA

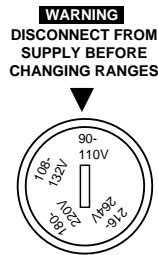

Setting for 180-220 VAC
Fuse rating 200mA

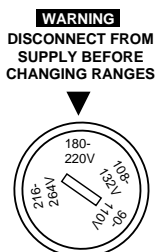

Setting for 216-264 VAC
Fuse rating 200mA

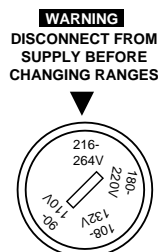

CAUTION

In accordance with international safety standards, this instrument is equipped with a three-wire power cable receptacle. The unit is shipped with a detachable type three-wire power cable intended for nominal 115/127 VAC mains supply. When connected to an appropriate power line outlet, this cable grounds the instrument cabinet. For operation of this unit on nominal 220/240 VAC mains supply, use the proper power cable assembly approved by your local codes.

For use of this product outside the U. S. A. or Canada on supply voltages of 220 VAC or greater, the discharge resistor (4.7 Meg Ohm) connected from the neutral wire terminal of the AC input receptacle to the receiver chassis must be removed.

Refer modification to a qualified service technician.

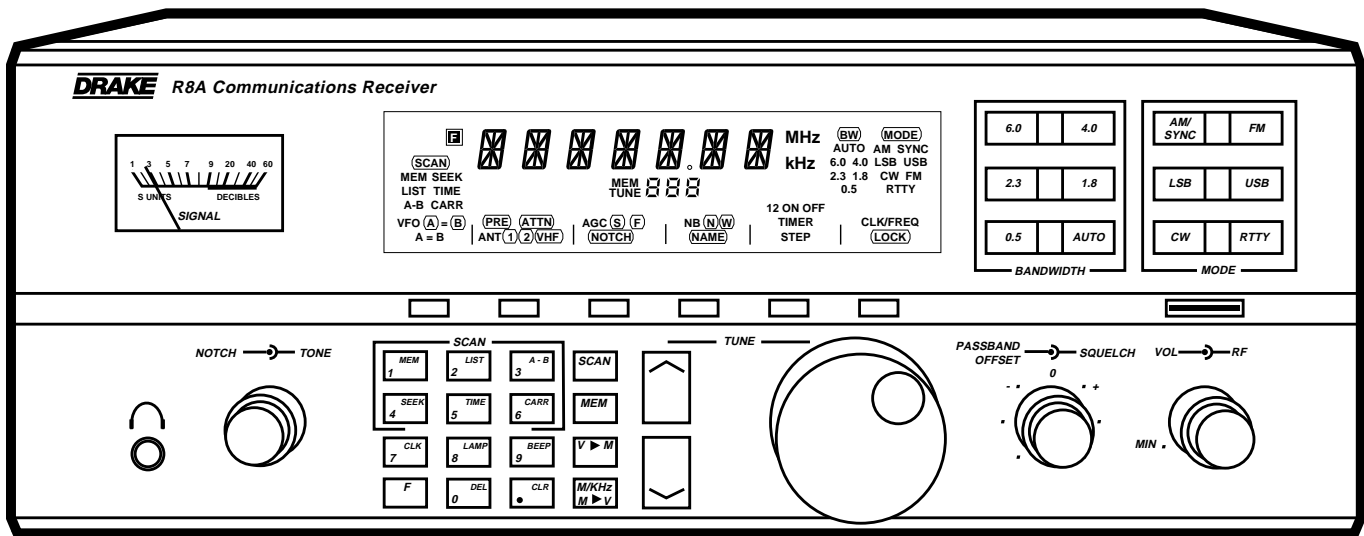

The R8A communications receiver is a microprocessor controlled, synthesized, all mode, world band receiver with continuous coverage capability from 100 through 30,000 kHz. The receiver offers excellent sensitivity, selectivity, high dynamic range and offers features for the most demanding shortwave reception. Conveniently located front panel controls allow for rapid operator programming and ease of use. Operating mode and corresponding bandwidth are quickly selected by front panel buttons. The selectable AC input allows for operation around the world. In addition, a DC input is provided for mobile operation.

A High-Q, 8-pole, electronically switched IF filter provides a range of five commonly used bandwidths. These bandwidths are automatically selected by mode, however any bandwidth may be selected at the touch of a button.

The front panel liquid crystal display provides visual feedback to the operator of the current status of the receiver. The seven digit frequency display allows tuning resolution to 10 Hz accuracy.

In the AM mode, a selectable synchronous detector (SYNCHRO) allows for enhanced reception by eliminating or reducing distortion due to fading signals and allowing the passband to be shifted toward one sideband, to reject interference, without causing audio distortion.

A PASSBAND OFFSET control also aids in reducing or eliminating interfering signals by electronically shifting the receiver's IF frequencies without disturbing the operating frequency. This action allows the operator to electronically move interfering signals out of the receiver's passband thus utilizing the high degree of selectivity provided by the High-Q, 8-pole IF filter.

Other built-in reception aids include selectable AGC speed, dual antenna inputs, noise blanker (NB), RF preamplifier for enhancing weak signals, RF attenuator for further improvement of strong signal handling capabilities, adjustable RF gain, NOTCH, TONE and SQUELCH controls.

Two independent, real time clocks provide a local and alternative time selection. Also provided is a two event timer.

A programmable memory area allows for 440 independent receive memories. In addition, these memories are stored in an electronically erasable memory chip which does not require a battery backup and is thus impervious to power line failure. Any of these memories may be altered by the operator and re-stored. These memory channels may be accessed manually or by various scanning methods.

Finally, a built-in RS-232 compatible interface allows complete digital control of the receiver including memory and scanning functions.

Frequency Range	100-30,000 kHz	IP ₃ - Intercept Point	+20 dBm @
Modes	AM, LSB, USB, CW, RTTY, FM	(preamp off)	100 kHz spacing
Sensitivity: SSB, CW (10dB S+N/N)	0.5 μ V nominal, 100-30,000 kHz (preamp off)		-20 dBm @
	Less than 0.25 μ V, 100-30,000 kHz (preamp on)	1st IF	5 kHz spacing
		2nd IF	45 MHz
			50 kHz
		AGC	Threshold: 0.8 μ V
Sensitivity: AM (10dB S+N/N, 1000 Hz, 30% mod)	1.5 μ V nominal, 100-30,000 kHz (preamp off)		Attack time: 1mS
	Less than 1.0 μ V, 100-30,000 kHz (preamp on)		Release time: SLOW: 2 Sec
			FAST: 300mSec
			Nominal 6dB change in audio output for 100 dB input change above AGC threshold
Sensitivity: FM (12 dB SINAD)	Less than 0.5 μ V, 100-30,000 kHz		
Frequency Stability	\pm 5ppm, -10 ⁰ to 50 ⁰ C	Ant 1, Converter	50 Ohms unbalanced
Frequency Accuracy	Better than \pm 100 Hz, -10 ⁰ to 50 ⁰ C	Ant 2	50 or 500 Ohms unbalanced
Selectivity: AM, LSB, USB, RTTY, CW	6 KHz @ -6 dB, less than 12 kHz @ -60 dB	Notch Filter Attenuation	AF type, 40 dB min. Depth (500-5000 Hz)
	4 KHz @ -6 dB, less than 8 kHz @ -60 dB	External Speaker Output	2.5 W, 4 Ohms @ less than 5% distortion
	2.3 KHz @ -6 dB, less than 4.5 KHz @ -60 dB	Line Outputs	300 mV, 4.7K Ohms
	1.8 KHz @ -6 dB, less than 3.6 KHz @ -60 dB	AC Power Requirements	100/120/200/240 VAC, \pm 10%
	500 Hz @ -6 dB, less than 1.5 KHz @ -60 dB		50 or 60 Hz, 40 Watts nominal
FM Only	12 KHz @ -6 dB, less than 25 KHz @ -60 dB	DC Power Requirements	11-16 VDC @ 2 A
Ultimate Selectivity	Greater than 95 dB	Operating Temperature	-10 ⁰ to +50 ⁰ Celsius
Image Rejection	Greater than 80 dB, 100-30,000 kHz	Weight	13 lbs. (5.9 Kg)
IF Rejection	Greater than 80 dB, 45 MHz	Size	Width 13 1/8" (33.4 cm)
	Greater than 100 dB, 50 kHz		Height 5 1/4" (13.4 cm) including feet
Dynamic Range	97 dB, 100-30,000 kHz @ 100 kHz spacing		Depth 13" (33 cm), including front knobs and rear connectors

ACCESSORIES

Accessories for the receiver include:

- 1) A VHF converter with frequency coverage of 35-55 MHz and 108-174 MHz.
- 2) A complementary styled MS8 external speaker.

CAUTION: The optional VHF Converter accessory should be installed by a qualified service technician to prevent personal injury or damage to the equipment.

UNPACKING

Carefully remove the receiver from the shipping carton and examine it for evidence of damage. If any damage is noted, immediately contact the transportation company responsible for delivery or return the unit to the dealer from whom it was purchased. Keep the shipping carton and all packing material for the transportation company to inspect. The original carton and packing material should be retained for repackaging should it be necessary to return the unit. Inspect the packing material for any accessories or printed material before storing the box. Locate the registration card, fill out, and immediately return to the R. L. Drake Company to insure registration and validation of warranty.

LOCATION

The location of the receiver is not critical so long as adequate clearance is provided to allow air circulation in and around the unit. Do not cover any ventilation slots in top cover or overheating may result. The ventilation slots also double as a speaker grill and any blockage may result in poor sound quality. For added operating convenience, the front bail may be flipped down to elevate the front of the unit. Refer to Figure 2

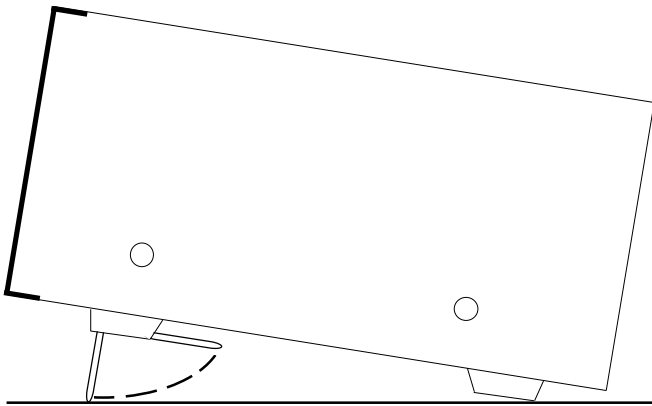

Side View of Receiver

FIGURE 2 ADJUSTING FRONT BAIL

FIXED INSTALLATION

After unpacking the unit and checking the voltage select switch for proper setting and correct fusing, connect antenna system to the appropriate antenna input. Connect AC cord to mains voltage. Connect ground system to ground screw on rear panel of radio. Connect any other external equipment at this time. Refer to Figure 3 for the diagram of a typical fixed installation.

MOBILE INSTALLATION

For use in a mobile environment, the receiver includes a fused external DC input connector. This connector is located on the rear panel. The receiver works well with a DC input voltage of 11-16 VDC. Typical automotive systems supply 13.8 VDC. Due to the relatively low current draw, the receiver may be powered from the vehicle's cigarette lighter socket. Connect DC power cord observing the correct polarity. An internal protection device will protect the receiver from reverse polarity hookup. Connect the mobile antenna(s) to appropriate antenna input(s). This will typically be a whip antenna with a coaxial cable thus permitting the cable to be run under floor mats, etc. Connect a grounding wire from the grounding screw on the rear panel to the vehicle's chassis. To further reduce current draw from the vehicle's battery system, it is recommended the LCD backlighting be turned off for extended listening periods.

ANTENNA REQUIREMENTS

The receiver incorporates internal switching to allow two separate antenna systems to be connected simultaneously. Refer to Figure 3. Ant 1 is a 50 Ohm, SO-239 coaxial input requiring a mating PL-259 connector. This input would typically be used as the primary antenna input. Antennas such as dipoles, trapped dipoles, verticals and beams will provide the best results. Ant 2 is a compression terminal type connection, providing a choice of high impedance (500 Ohms typical) or low impedance (50 Ohms typical). Antennas such as long wires or end fed Zepps will provide the best results. The best antenna will depend on the frequency range and time of day for the particular signal in question. Refer to publications such as the [ARRL Handbook](#) or [ARRL Antenna Manual](#) (available in most public libraries) for help on selection and/or construction of the antennas mentioned above.

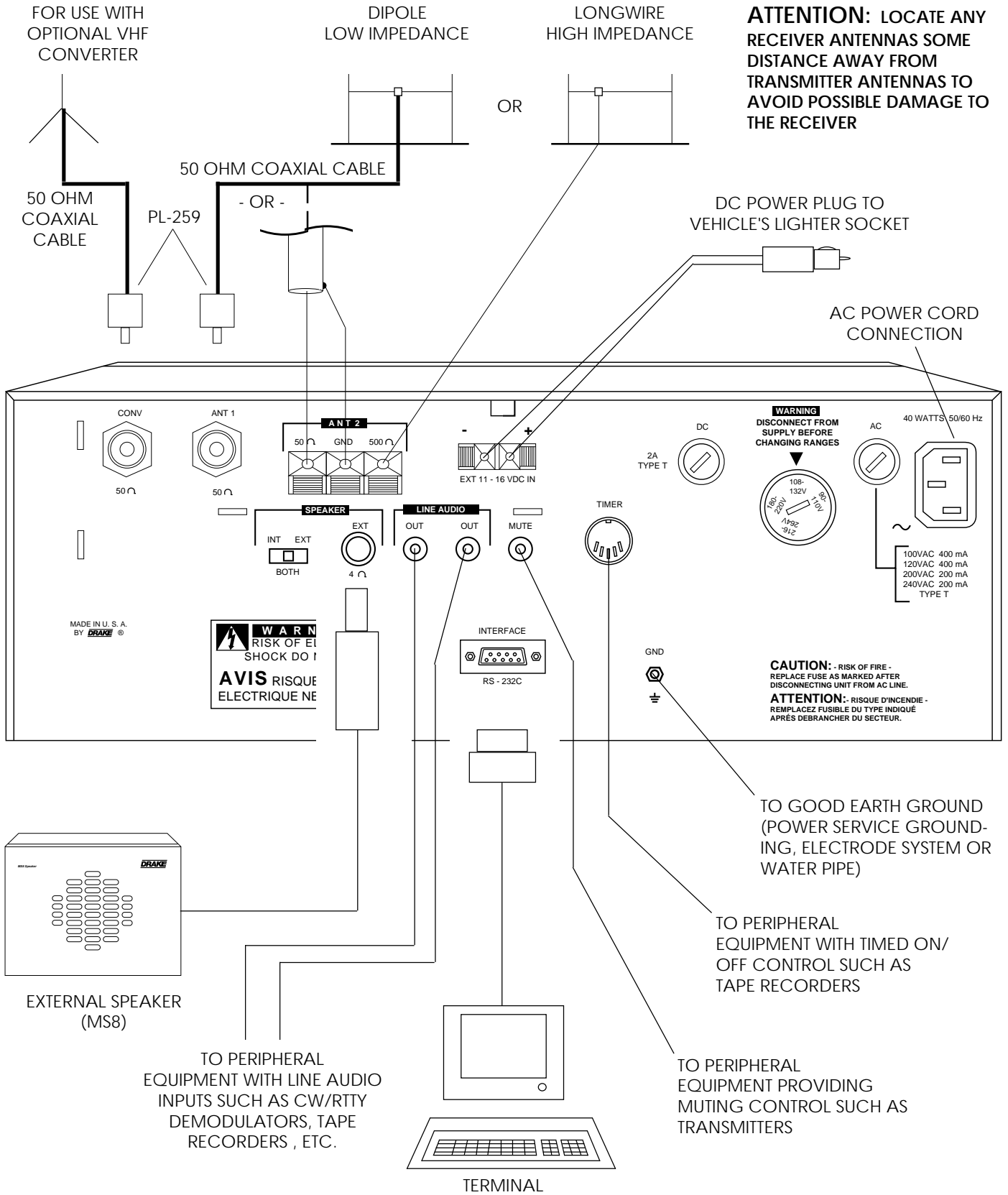

FIGURE 3 INSTALLATION DIAGRAM

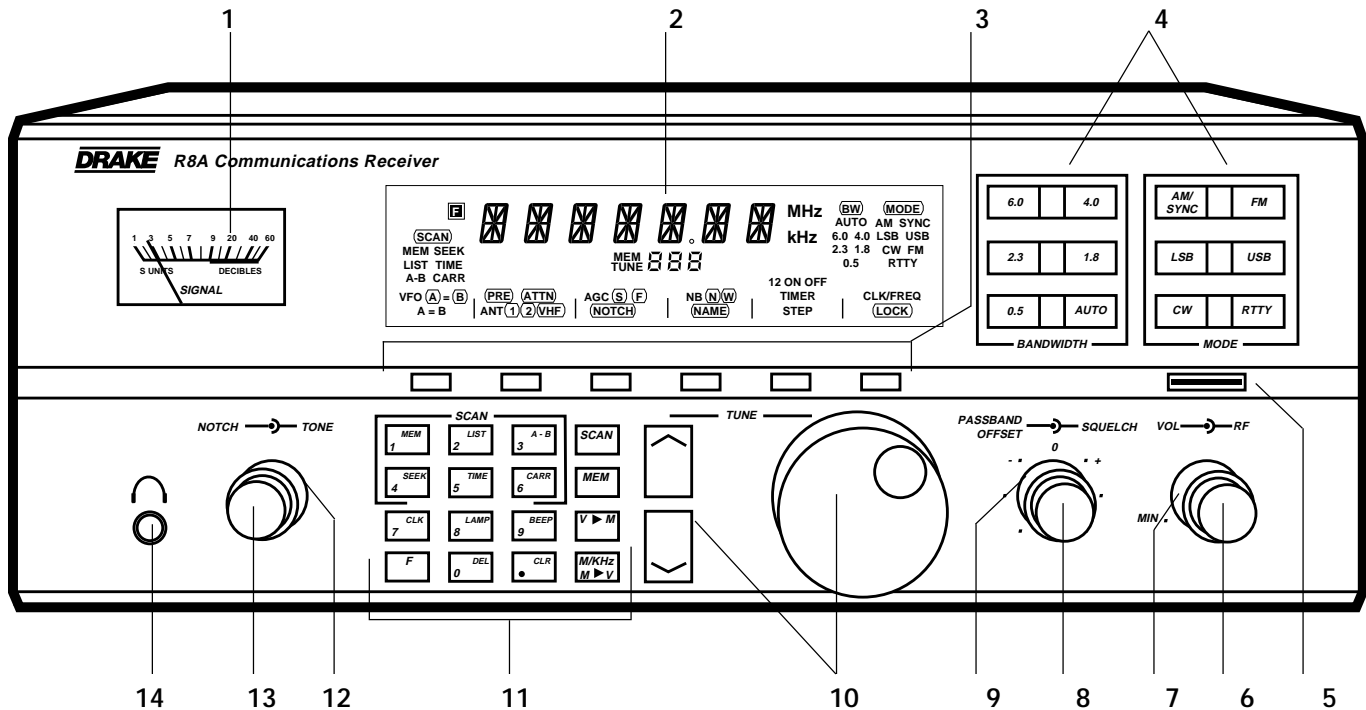

FIGURE 4 FRONT PANEL

1) SIGNAL - This meter indicates the relative signal level in S-units and dB above S9.

2) Display - The backlit, liquid crystal display provides the current status of the receiver such as frequency, mode, bandwidth, etc. Refer to **FRONT PANEL DISPLAY** page 11 for full description.

3) Function Buttons - These (6) buttons control the various functions of the receiver which are indicated on the display directly above each button.

4) MODE/BANDWIDTH Buttons - The operating mode and bandwidth are directly entered with these front panel buttons. Press the AUTO button to permit automatic setting of bandwidth as mode is selected. Press the AM/SYNC button to enable the synchronous detector in AM mode.

5) POWER - This button turns the receiver on or off. When unit is off, the clock will be displayed.

6) VOLUME - This control adjusts the receiver's audio speaker level. Turn clockwise to increase level or counterclockwise to decrease level.

7) RF - This control adjusts the gain of the receiver and is normally left in the fully clockwise position for maximum gain.

8) PASSBAND OFFSET - This control alters the position of the receiver's IF passband without disturbing the main tuning. Normally, this control should be set at the "0" or 12 o'clock position. This control is not active in FM mode.

9) SQUELCH - This control sets the signal level at which the audio is muted. For normal operation, this control is set fully counterclockwise.

10) TUNING (VFO) - The tuning wheel and the  and

 buttons are the primary tuning controls of the receiver. Clockwise rotation of the tuning wheel increases frequency and counterclockwise rotation decreases frequency. The tuning wheel also incorporates variable speed tuning. The faster the tuning wheel is rotated, the faster the tuning speed.

TUNING WHEEL STEPS

The receiver can be programmed to tune in three different resolutions (steps) with the corresponding display readout. The three choices are as follows:

- A) 1 kHz display readout (tuning in 1 kHz steps). Used for fairly rapid frequency search.
- B) 100 Hz display readout (tuning in 100 Hz steps). Used for tuning AM and FM signals.
- C) 10 Hz display readout (tuning in 10 Hz steps). Used for tuning SSB, CW, or data signals.

The step size may be programmed per mode. The receiver, as shipped from the factory, has step sizes programmed as shown in Table 1 below:

Mode	Tuning and Display Resolution (Hz)
LSB, USB, RTTY, CW	10
AM, FM	100

Table 1

To reset the receiver to the factory settings for STEP size, AGC setting, BANDWIDTH, etc.:

Press the POWER button to turn the receiver off. Press the CLR button and hold while pressing the POWER button to turn Power on. After three seconds, the receiver will reset.

The tuning wheel incorporates variable rate tuning. The faster the tuning wheel is rotated, the greater the frequency change per tuning wheel revolution.



The button increases and the button decreases the frequency by fixed steps with each depression as programmed. Pressing and holding either button will allow continuous stepping up or down as long as the button is depressed. The fixed steps are as follows:

Frequency Range	Step
100-540 kHz	5 kHz
540-1800 kHz	10 kHz (9 kHz if programmed)
1800-30,000 kHz	5 kHz

To tune in 100 kHz steps, press the F button. With the

F displayed, press the / buttons, as desired, to tune in 100 kHz increments.

Note that, regardless of the / button step increments, the display always indicates the programmed tuning resolution (step) available by using the tuning wheel at any frequency.

11) Program Buttons -

SCAN (Scan) - Pressing this button starts a scan as defined by the scan indicators () on the display.



Please refer to SCAN FUNCTIONS on pages 22-23 for details.

MEM (Memory) - Pressing this button in VFO mode switches the receiver to memory mode. Please refer to MEMORY FUNCTIONS on pages 20-21 for details.

V M (VFO to Memory) - Pressing this button in VFO mode transfers the current status of the receiver, for example, frequency, mode, bandwidth, etc., into memory. Please refer to MEMORY FUNCTIONS on pages 20-21 for details.

M/KHz (MHz or kHz Frequency Readout or Memory to VFO) - Pressing the F button followed by the M/KHz button, changes the frequency readout to MHz or kHz as desired. Pressing this button in memory mode transfers the contents of the current memory location, i.e., frequency, mode, bandwidth, etc. to the selected VFO. Refer to MEMORY FUNCTIONS on pages 20-21 for details.

F (Function) - Pressing this button accesses secondary functions, printed in orange, on the numeric buttons 0-9 and switches the function line on the display above the 6 function buttons.

DEL to BEEP - These buttons are normally used for direct numeric entries in VFO, memory, clock, and timer modes. Each button also has a secondary function printed in orange. These secondary functions are used as follows: Press F, MEM 1 to CARR 6 for programming scan methods. Refer to SCAN FUNCTIONS pages 22-23.

Press F, 7 CLK to access the clock. Refer to CLOCK & TIMER FUNCTIONS page 25-26.

Press F, 8 LAMP to adjust display and signal meter backlight intensity.

Press F, 9 BEEP to turn audible beep on or off. Refer to BEEP TONES page 15.

Press F, 0 DEL to delete a program from a memory location. Refer to DELETING A MEMORY LOCATION page 21.

CLR (Decimal) - This button is used when entering a frequency directly with the numeric buttons. Also used in conjunction with the F button to provide a Clear entry function. Refer to DIRECT FREQUENCY ENTRY page 16.

12) TONE - This control is used to modify the tonal quality of the audio. Counterclockwise rotation increases bass response. Flat response occurs at the 12 o'clock setting.

13) NOTCH - This control is used to "tune" the notch frequency and is active when NOTCH is displayed. This control is not active in FM mode.

14) Headphone - This connector accepts a standard 1/4" diameter 2-circuit (monaural) or 3-circuit (stereo) phone plug. Audio is monaural in either case. All speaker outputs are automatically switched off when using headphones.

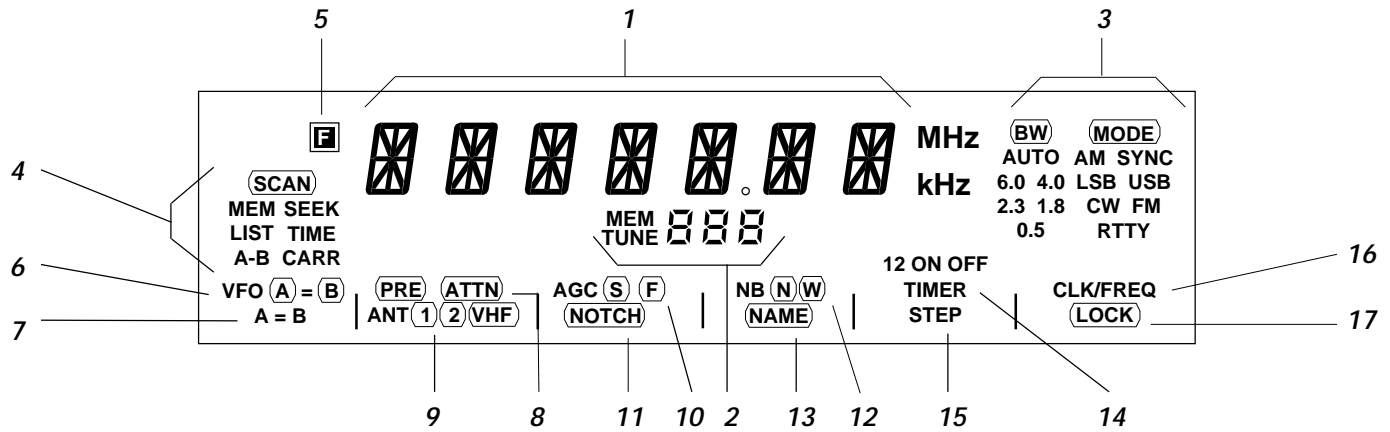
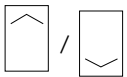

FIGURE 5 FRONT PANEL DISPLAY

1) 7-Digit Alpha/Numeric Display Readout - This display indicates frequency, in 'MHz' or 'kHz' as selected, of the current VFO or Memory channel. The readout will also display the channel name if assigned and selected in addition to various programming and error messages. In the clock mode, indicates either 'Local' or 'Universal' time in 24 hour format as selected. Time display is as follows: HH:MM:SS. In the Timer mode, indicates time in 24 hour format as follows: HH:MM, with no seconds indicated.

2) MEM/TUNE - This annunciator indicates the current memory location. 'MEM' will light when the receiver enters the Memory mode and all memory channel locations can be sequentially tuned by use of the 'TUNE



' buttons or Tuning wheel. With 'TUNE' displayed, use of the Tuning wheel will allow the user to tune away from the selected memory channel.

3) BANDWIDTH/MODE Indicators - The currently selected IF filter Bandwidth and mode of reception are indicated. For FM mode operation, only the mode (FM) is displayed. When 'AUTO' is illuminated, the appropriate bandwidth is automatically set for the corresponding selected mode.

Note: The AGC setting, tuning step size, display resolution and bandwidth are user programmable and stored per mode.

The modes are:

AM - Amplitude Modulation

AM/SYNC - Amplitude Modulation (with Synchronous Detection)

FM - Frequency Modulation

CW - Continuous Wave (Morse Code)

RTTY - Radio Teletype or data

LSB - Lower Sideband

USB - Upper Sideband

4) SCAN - The annunciators under this heading indicate the current scan function programming. **SCAN** will light when the receiver enters the **SCAN** mode. Refer to the 'Scan Functions' section of this manual.

IMPORTANT - PLEASE READ

The function lines of the display, described in callouts 5) through 17) are activated by the unmarked function button located directly below the displayed function. The primary function line is the top most line. Pressing the **F** allows access to the alternate function line (lower line). Alternate function availability 'times out' after any front panel activity which alters the display.

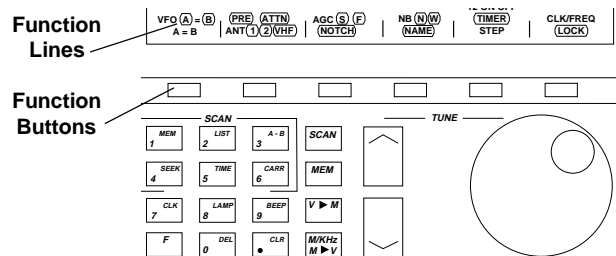

5) F - This annunciator lights to indicate that the alternate function selection is enabled.

6) VFO A/B - This annunciator indicates the VFO in use. A box appears around the active VFO.

7) A=B - An '=' sign appears between the 'A' and 'B' of the top function line to indicate that one of the VFO's has been set to the same frequency as the other. This function serves as a temporary 'scratchpad' memory of the first VFO frequency as the second VFO frequency is changed by tuning.

8) PREamp/ATTenuator - A box appears around the appropriate legend when the Preamp or attenuator is activated.

9) ANTenna 1/2/VHF - A box appears around the selected antenna input: 'ANT 1', 'ANT 2' or the 'VHF' ('CONV') connector at the rear panel of the receiver.

NOTE: VHF is only accessible when the accessory VHF Converter module is installed.

10) AGC S/F - A box appears around the selected AGC setting. With no box illuminated, the AGC is Off. As the receiver is factory supplied, two choices are possible: **S** or **F**. Select either the Slow or Fast AGC setting for most all modes of operation. However, to add the 'Off' condition as a third selection: Press and hold the AGC function line button for three seconds. The choices for AGC setting will now be among three possible conditions: **(S)** , **(F)** or no box displayed (AGC Off).
AGC is not displayed when the FM mode is selected.

11) NOTCH - A box appears around this annunciator to indicate that the variable frequency audio notch control is active.

12) Noise Blanker Narrow/Wide - A box appears around the selected noise blanking range, either Narrow or Wide. No box indicates that the noise blanker is not activated.

13) NAME - Whenever a box appears around this annunciator, the receiver will display channel names if the tuned frequency is within ± 1 kHz of a stored memory channel frequency with a name assigned. It is important to note that, if a name is not assigned to a memory channel, only the frequency will be displayed for that channel when it is recalled even though **(NAME)** is illuminated.

When the frequency first enters the 1kHz window, the name will be displayed. It will remain until the frequency is tuned out of the window. If tuning is stopped inside the window (such as when the listener is interested in the signal) name display is reversed; when tuning resumes, the name will be replaced by the frequency to allow fine tuning of the tuned signal. The frequency will remain on the display until tuning is stopped for 2 seconds, then the name will return.

If, while fine tuning, the frequency goes outside the window, the display will revert to the original name and will be displayed as soon as the frequency enters the window.

14) TIMER - The number **1** or **2** will light to indicate which timer is selected. If one or both timers (Timer **1** and/or Timer **2**) is/are enabled, the **1** and/or **2** annunciator(s) will continue to be displayed after the receiver is turned off. The **ON** and **OFF** annunciators are displayed to indicate which respective time is being programmed.

15) STEP - When selected, permits setting of three different step sizes and corresponding display resolutions. Refer to 'FREQUENCY STEP SELECTION' on page 16.

16) CLOCK/FREQUENCY - Either the Time or Frequency can be displayed by pressing the function button below this annunciator.

17) LOCK - A box appears around this annunciator to indicate that all front panel buttons and Tuning wheel entries are locked out.

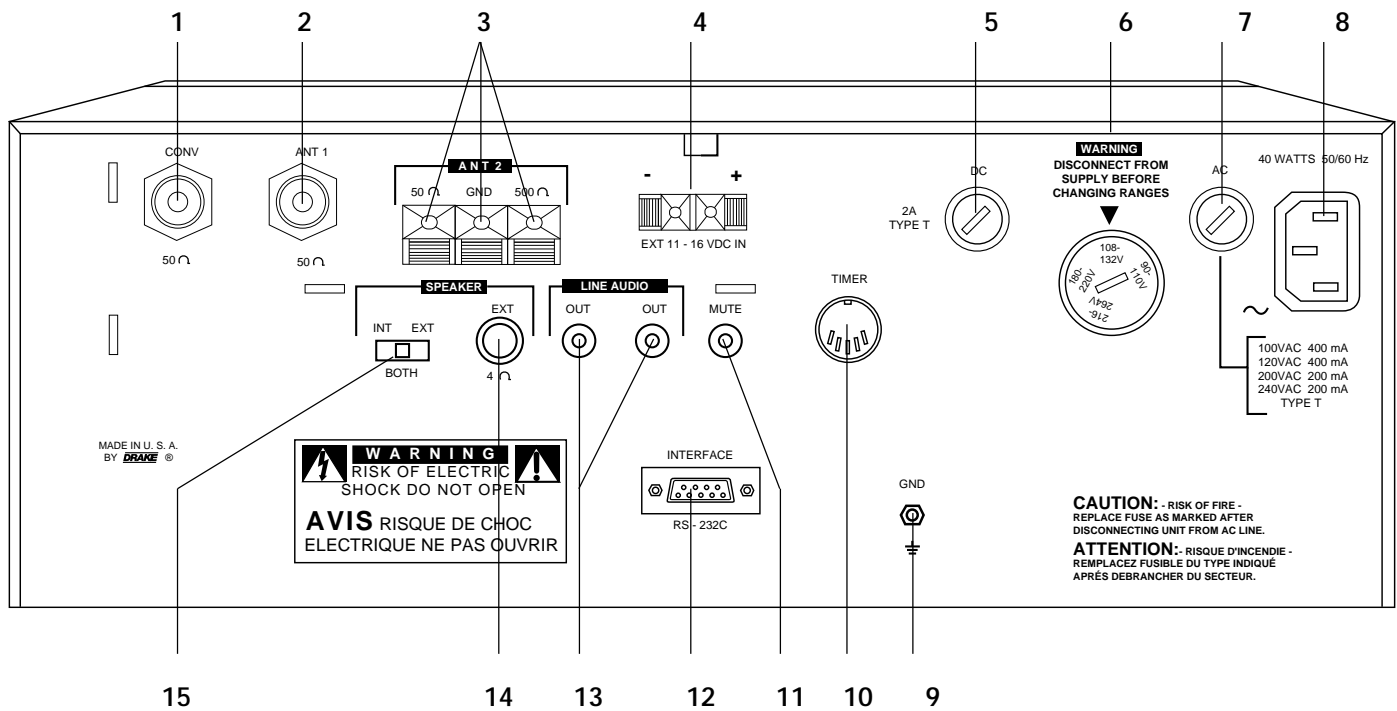

FIGURE 6 REAR PANEL

1) CONV - This connector is the antenna input to the optional VHF Converter. Attach a 50 OHMS nominal impedance coaxial feed line from the antenna. This connector accepts a standard PL-259 plug.

2) ANT 1 - This connector is used when attaching receiving antennas with coaxial feed lines of 50 OHMS nominal impedance. Accepts a standard PL-259 plug.

3) ANT 2 - This connector can be used to attach either a low impedance (50 OHMS nominal) or high impedance (500 Ohm nominal) antenna. The center clip is ground and its connection should be as short as possible.

4) EXT 11-16 VDC IN - This connector is used for powering the receiver from an external DC source such as a car battery. Observe proper polarity when attaching wires. This connector is internally protected from reverse polarity.

5) DC Fuse - This is a 2 ampere type T fuse. Replace with same type and rating.

6) AC LINE Voltage Selector - This switch is used to select the proper line voltage setting for your particular area. BE CERTAIN OF THE OPERATING VOLTAGE BEFORE CONNECTING THIS RECEIVER TO THE MAINS SOURCE. Also, the proper mains fuse and line cord may need to be installed. See items (7) and (8).

7) Fuse - Check for proper fusing prior to connecting this receiver to the mains source (see page 4). Fuse is 5x20 mm SLO-BLO®, T400 mA for nominal 115/127 VAC operation; T200 mA, 250V for nominal 220/240 VAC operation.

8) Power Line Cord Receptacle - This receptacle accepts a three-wire power cable. When the cable is connected to an appropriate power line outlet, the instrument is grounded.

This unit is shipped with a cord intended for nominal 115/127 VAC mains supply. For operation of this unit on nominal 220/240 VAC mains supply, use the proper cable assembly approved by your local codes.

9) GND (Ground) - The earth ground wire connected here should be as short as possible.

10) TIMER - This 5 pin din connector provides switching contacts for on/off control of an external device such as a cassette tape recorder. Refer to **CLOCK & TIMER FUNCTIONS** page 25.

11) MUTE - The RCA connector provides a method of muting the receiver for use with a transmitter. Ground center pin to mute.

12) Interface RS-232C - This 9 pin DB-9 connector provides a standard RS-232C interface to a keyboard terminal. Refer to **RS-232C INTERFACE** page 30.

13) LINE AUDIO OUT - Both RCA connectors provide a constant low level audio source independent of the setting of the volume control. They are designed to interface to tape recorders, CW/RTTY demodulators, amplifiers, etc.

14) EXT (External Speaker) - This connector accepts a standard 1/4" diameter, 2-circuit, (monaural) phone plug for connection of a 4-8 ohm external speaker.

15) Speaker Switch (INT/BOTH/EXT) - This 3 position switch allows selection of internal only, both internal and external, or external only speaker outputs.

MUTE OPERATION OF THE R8A COMMUNICATIONS RECEIVER

When using this receiver with an external transmitter, it is often desirable to be able to externally mute the receiver during transmission. The receiver provides this external control by use of the "MUTE" connector located on the rear panel. Grounding the center pin of this connector forces the AGC circuitry to shut down all RF/IF stages, thus quieting or muting the receiver.

The mute line does not disconnect the antenna. Older Drake equipment required the mute line to be grounded for receive. This receiver requires ground to mute. When using the receiver with older Drake equipment, an external relay is recommended to operate the mute line. Sometimes this may be accomplished by using a spare set of relay contacts on the antenna switch-over relay.

If you are not operating a linear amplifier, you can use the vox relay contacts to provide control of the receiver muting. Simply connect the two pin jack or RCA phono socket of the AC-4, PS-75, PS-7, power supply to the mute jack on the R8A.

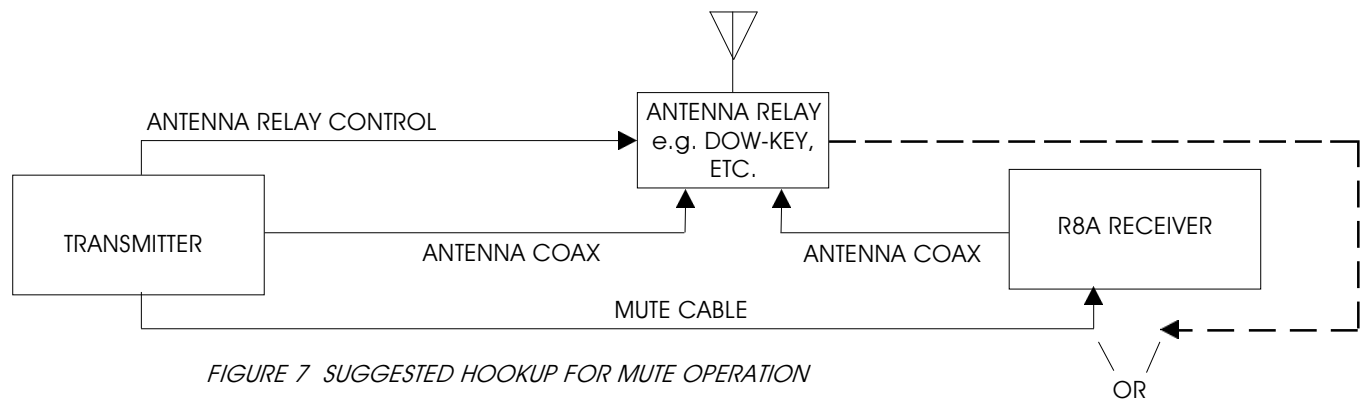

FIGURE 7 SUGGESTED HOOKUP FOR MUTE OPERATION

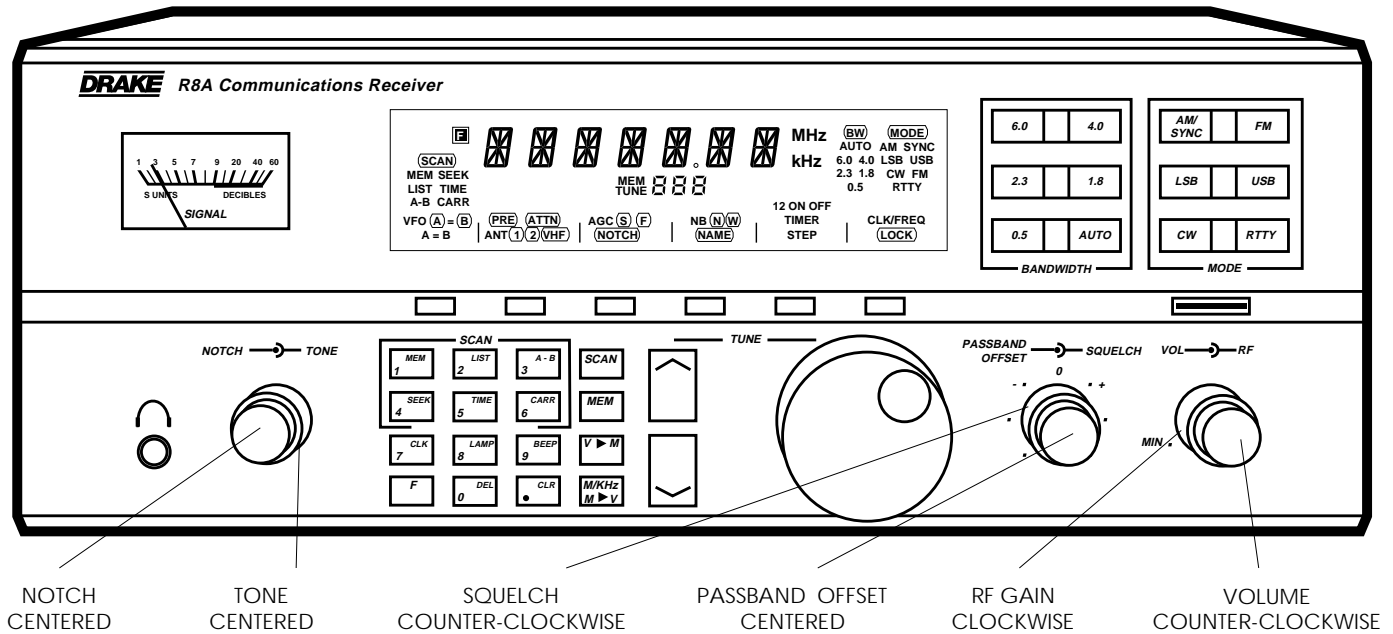

FIGURE 8

GENERAL OPERATING INFORMATION

The three choices are as follows:

- A) 1 kHz display readout (tuning in 1 kHz steps).
Used for fairly rapid frequency search.
- B) 100 Hz display readout (tuning in 100 Hz steps).
Used for tuning AM and FM signals.
- C) 10 Hz display readout (tuning in 10 Hz steps).
Used for tuning SSB, CW, or data signals.

The step size may be programmed per mode. The receiver, as shipped from the factory, has step sizes programmed as shown in Table 2 below:

Mode	Tuning and Display Resolution (Hz)
LSB, USB, RTTY, CW	10
AM, FM	100

Table 2

To change the step, press the button followed by the STEP function line button.

To reset the receiver to the factory settings for STEP size, AGC setting, BANDWIDTH, etc.:

Press the POWER button to turn the receiver off. Press the button and hold while pressing the POWER button to turn Power on. After three seconds, the receiver will reset. The tuning wheel incorporates variable rate tuning. The faster the tuning wheel is rotated, the greater the frequency change per tuning wheel revolution.



The button increases and the button decreases the frequency by fixed steps with each depression as programmed. Pressing and holding either button will allow continuous stepping up or down as long as the button is depressed. The fixed steps are as follows:

Frequency Range	Step
100-540 kHz	5 kHz
540-1800 kHz	10 kHz* (9 kHz if programmed)
1800-30,000 kHz	5 kHz

To tune in 100 kHz steps, press the button. With the

displayed, press the / buttons, as desired, to tune in 100 kHz increments. Note that, regardless of the

/ button step increments, the display always indicates the programmed tuning resolution (step) available by using the tuning wheel at any frequency.

DUAL VFO's

A) VFO A/VFO B

Two VFOs (A and B) are provided on the receiver. Selection is made with the VFO function key. Each VFO can be set to any frequency and act as a temporary memory location.

For example, suppose you want WWV at 10 MHz in VFO B while using VFO A to tune other frequencies.

Press: **VFO** to select **B**

Press: **AM** mode button

Press: - WWV is now stored in **VFO B**.

Press: **VFO** to select **A**

Tune other frequencies with **VFO A**. To recall WWV, press **VFO** function button. **NOTE:** See 'DIRECT FREQUENCY ENTRY' section below for explanation of second entry.

B) A=B

This function is used to transfer the frequency of the active VFO into the inactive VFO. This is handy if you are tuning and would like to temporarily hold a certain frequency as you continue tuning. For example, suppose you are tuning in VFO B and come across a station at 4.5 MHz you would like to occasionally check.

Press: , then **A=B**. Equal (=) symbol now appears between **VFO A = B**.

Continue tuning and recall station at 4.5 MHz anytime by pressing the **VFO** button.

DIRECT FREQUENCY ENTRY

Direct keyboard entry of a frequency is possible using numeric buttons **0-9** and decimal allowing for rapid frequency change. Pressing the button sequence , will cancel any frequency or memory channel number entry in progress and return the setting to its previous state.

NOTE: With the optional VHF Converter installed, entering a three digit frequency (in MHz) is possible after first selecting antenna.

Press: **VFO** select **VFO A** or **VFO B**

TO ENTER FREQUENCY IN MHz:

Press: , to select 'MHz' display mode if required. Enter frequency in MHz beginning with the most significant digit. You do not need to enter leading or trailing zeros.

Examples:

1) 1.410 MHz - Press:

2) 29.660 MHz - Press:

The second depression of the decimal button acts as an 'Enter' and causes immediate response to the entered digits. If you forget to press the decimal button a second time, the receiver will automatically do so for you, but with a slight delay.

3) 700 kHz (= .70 MHz) - Press: . After 3 second pause, frequency will be entered.

TO ENTER FREQUENCY IN kHz:

Press: , to select 'kHz' display mode if not already selected. Enter frequency in kHz beginning with the most significant digit, followed by a double depression of the button. Example:

1) 700 kHz - Press:

Frequency will be immediately displayed. Attempting to enter a frequency outside of the tuning range of the receiver will cause the word **ERROR** to be displayed along with the error beep to be heard. The receiver will then return to the last displayed frequency.

FRONT PANEL LOCK (UNLOCK)

First be sure the receiver is in the **VFO** mode, (**MEM** or **SCAN** not displayed). All button entries, display settings and the large tuning knob can be locked if desired.

Press **F** **LOCK** to lock front panel. All analog control knob functions, except tuning, will still remain operable.

Press **F** **LOCK** to unlock front panel if previously locked.

PASSBAND OFFSET OPERATION

When the **PASSBAND OFFSET** control is centered, the receiver will properly position its IF passband with mode change. Occasionally, an interfering signal will appear above or below the desired signal. Rotating the **PASSBAND OFFSET** "+" or "-" will reduce or eliminate this interfering signal by electronically shifting the receiver's IF passband. Refer to **FIGURE 9**. This shifting of the IF passband also alters the audio quality. For example, if you are receiving a signal in USB and rotate the **PASSBAND OFFSET** control "-", the audio will become low pitched. Conversely if the control is rotated to the "+" position, the audio will become high pitched. The results are reversed in LSB; rotated "+" the audio becomes low pitched, rotated "-" the audio becomes high pitched.

In AM, the **PASSBAND OFFSET** can enhance audio quality. For example, with the **PASSBAND OFFSET** control at the normal 12 o'clock position and the 6 kHz IF filter selected, the maximum audio response will begin to roll off at 3 kHz. If the **PASSBAND OFFSET** control is moved to one side or the other, audio response exceeding 5 kHz is obtainable thus enhancing fidelity. Try both offset directions to determine which side of the signal is least subject to any possible adjacent signal interference. The **PASSBAND OFFSET** control is also coupled to the synchronous detector (SYNCHRO) allowing the passband to be altered while the detector is in use.

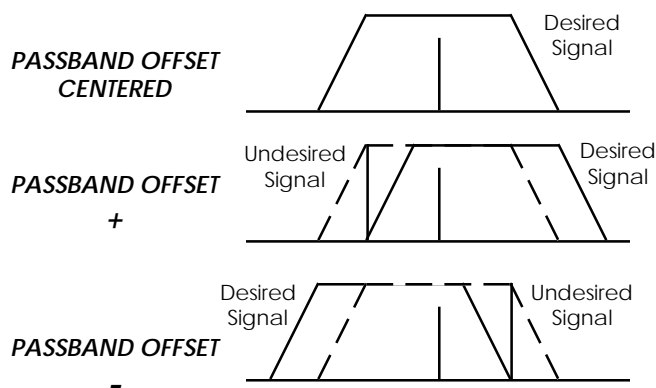

FIGURE 9 PASSBAND OFFSET Operation

NOTCH OPERATION

Audio notch will nullify signals from 500 Hz at the counter-clockwise setting of the control to 5kHz at the clockwise setting. Adjust control to nullify an undesired signal.

AM SYNCHRONOUS DETECTOR OPERATION

For general tuning and listening, the normal AM detector is best. It allows normal AM reception while providing the capability to offset the IF passband without causing distortion. If the received signal is experiencing severe fading as is common on many SW and BC bands, the synchronous detector should be engaged. Make sure the main tuning is set to within 1 kHz of the station's transmitting frequency. Adjust the **PASSBAND OFFSET** control and change bandwidth as required to minimize any interference. Press **AM/SYNC** to activate the synchronous detector. The word **SYNC** is displayed following **AM** to indicate the synchronous detector is selected and locked. **SYNC** will flash to indicate that the detector is acquiring lock. This detector provides a very powerful aid in reducing the severe audio distortion that can occur during the time period when the carrier of the received AM signal is cancelled or reduced by propagation effects.

When the synchronous detector has been activated, moving the main tuning over ± 200 Hz will automatically switch the receiver out of synchronous detection while the synchronous detector re-acquires lock. The 'SYNC' annunciator will flash briefly until lock is achieved. Also, moving the **PASSBAND OFFSET** control while the synchronous detector is engaged, will cause the receiver to momentarily switch out of synchronous detection while the synchronous detector re-acquires lock. The 'SYNC' annunciator will flash briefly until lock is achieved.

RF FUNCTION (ATTENUATOR/PREAMP)

Occasionally, a received signal may be very strong such as from a local broadcast station. When this happens, distortion could degrade the signal's quality. To help combat this, the **(ATTN)** should be selected. It provides 10 dB of loss to the incoming signal, thereby allowing the receiver to function normally. Also, when trying to listen to a weak station in the presence of an undesired stronger station, selecting the attenuator will lower the received level of both. This action could make it possible, however, to receive the desired station. The attenuator is available for use across the entire tuning range of the receiver, except for the ranges covered by the optional VHF Converter module.

Another RF function available is a preamplifier **(PRE)** which provides an additional 10 dB of gain to the received signal. This can be useful on the higher shortwave frequencies when trying to receive a weak signal perhaps at the noise level. Use caution when using the preamp as it could amplify an adjacent signal causing distortion on the desired signal. The preamplifier is not selected for frequency ranges covered by the optional VHF Converter module.

For general tuning, operate the receiver with both the **PREAMPLIFIER** and **ATTENUATOR** off.

To enable or disable the **PREAMPLIFIER** or **ATTENUATOR**: Press the function line button below the displayed **PRE** **ATTN** annunciators. The selected function is indicated by a displayed box around the function. Conversely, no box indicates that the function is not selected.

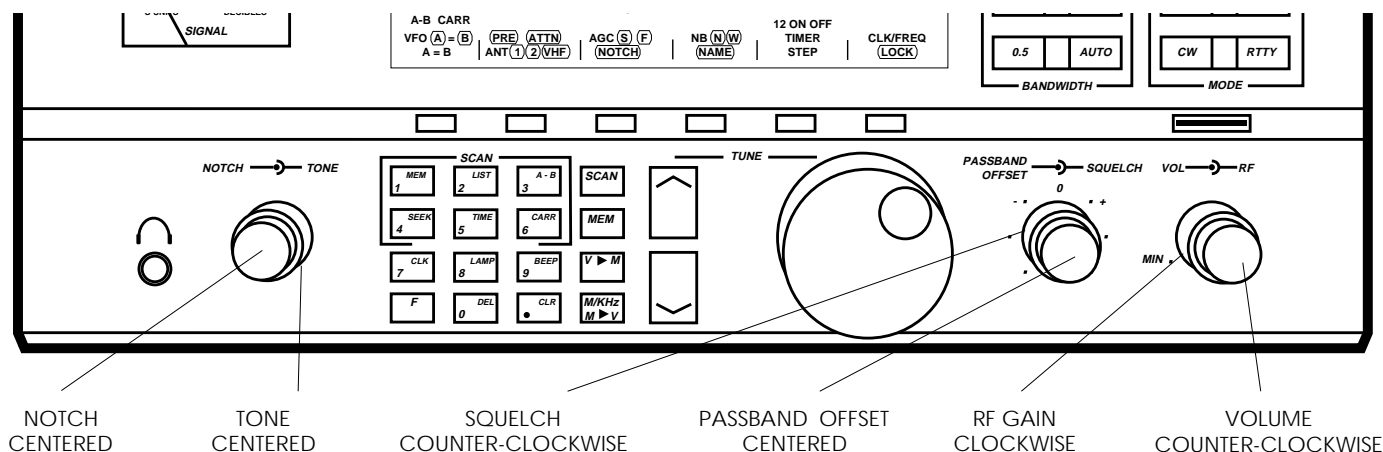

FIGURE 10

NOISE BLANKER

The NOISE BLANKER **NB** provides two settings which will reduce or eliminate much noise interference encountered. The **(N)** (or narrow) setting is for short duration, high impulse noise such as automotive ignition noise. The **(W)** (or wide) setting is to reduce longer duration impulses. Unfortunately, there exists no blanker capable of eliminating all possible noise either atmospheric or man-made. Another side effect of the **NOISE BLANKER** use is on AM signals. Occasionally, if a strong AM signal is tuned in and the **NOISE BLANKER** is engaged, blanking can occur on modulation peaks causing a popping or breaking up of the audio. If this is noticed, be sure the **NOISE BLANKER** is off.

CW OPERATION

For general tuning in **CW** mode, the 1.8 kHz bandwidth is recommended since the 0.5 kHz bandwidth is very narrow. When the desired signal is found, tune the receiver until an approximately 800 Hz audio note is heard, then select the 0.5 kHz filter. If interference is present, the passband offset can be employed to reduce or eliminate the interfering signal.

RTTY OPERATION

In **RTTY** mode, the receiver selects the user programmed bandwidth (1.8 kHz recommended) filter and positions it for the 2125 Hz mark and 2975 Hz space high tone group. When receiving other shifts such as 425 Hz or 170 Hz, the **PASSBAND OFFSET** may need to be adjusted to pass both tones equally. Additionally, the selected IF bandwidth should not be smaller than the shift of the received signal. Therefore, the 0.5 kHz bandwidth filter can not be used when receiving a 850 Hz shift **RTTY** signal but could be selected for a 425 Hz or 170 Hz shift **RTTY** signal.

SSB OPERATION

Tuning in a single sideband (SSB) signal can be somewhat frustrating for the first time listener. With the 'AUTO' bandwidth selected in either of the receiver's SSB modes, LSB (lower sideband) or USB (upper sideband), the receiver will select the 2.3 kHz bandwidth, 10 Hz tuning steps and Slow AGC setting.

If the default 'AUTO' settings have been programmed by the user, then those particular settings are recalled. Generally, LSB is used below 10 MHz and USB is used above 10 MHz.

First, be sure the **PASSBAND OFFSET** control is centered. When initially tuning in the desired station, tune slowly. If the station is unintelligible, try the other sideband again tuning slowly. A station tuned in on the wrong sideband is totally unreadable but a station mistuned on the right sideband may sound like "Donald Duck". Further tuning will result in a more normal voice sound. Once the station is tuned in, the **PASSBAND OFFSET** can be used to alter the audio response of the received SSB signal. Refer to **PASSBAND OFFSET OPERATION** for details. Additionally, if adjacent stations are causing interference, the 1.8 kHz bandwidth filter may be selected in conjunction with the **PASSBAND OFFSET** to further reduce or eliminate interfering signals.

FM OPERATION

Frequency modulation (FM) is perhaps the easiest mode to use on the receiver. When the FM mode is selected the receiver defaults to PRE only. No AGC or **BANDWIDTH** settings are used in FM mode. In fact, attempting to activate these buttons will result in an error beep. Additionally, **NB**, **NOTCH**, **PASSBAND OFFSET**, and **RF GAIN** controls are not used.

Most FM transmissions are above 29 MHz and are generally amateur radio in nature. A very active frequency, when conditions permit, is 29.660 MHz.

Peculiar to FM transmissions is the fact that a stronger signal on the same frequency or close to the same frequency will completely cover up a weaker signal. Also, there are no controls to help reduce or eliminate an interfering signal. This is not a fault of the receiver but of the FM mode of transmission. However, to help in eliminating the background hiss, the **SQUELCH** control may be used to quiet the receiver during periods of no signal.

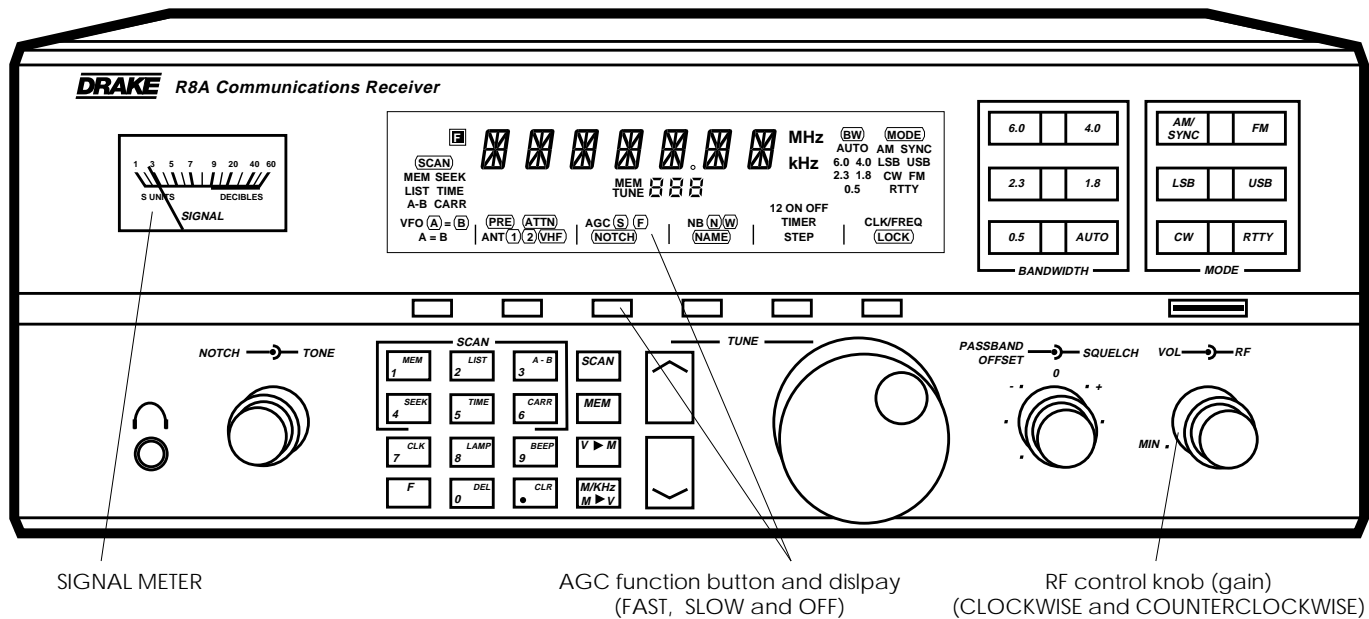

FIGURE 11

Gain and AGC OPERATION

In a basic sense, gain means amplification. **AGC** is an abbreviation for Automatic Gain Control. Thus, **AGC** helps tune in weak signals by conveniently amplifying them automatically. When a strong signal is tuned in, the **AGC** automatically reduces the amplification since it is not needed. This also prevents overloading the receiver and minimizes distortion. When factory supplied, **AGC** can be selected to operate S(LOW) or F(FAST). The **SLOW AGC** setting is used for reception of slowly changing signal levels such as SSB signals. The **FAST AGC** setting allows more rapid automatic receiver gain adjustment to fast changing signal levels such as AM signals. The user can select an off position, if desired. To select this feature, press and hold the **AGC** function button until a memory confirmation beep is heard. The **AGC** button will now permit SLOW, FAST or OFF settings. The OFF condition is indicated by the display not showing a around S or F. To remove the OFF selection option, repeat the press-and-hold sequence. If the **AGC** is turned off, the receiver gain must be manually set by using the **RF** (gain) control knob to produce distortion free reception.

HOW AGC, RF GAIN AND THE SIGNAL METER WORK TOGETHER

The **AGC** function button, **RF** Gain control knob and the **SIGNAL METER** work together in the same circuit in three basic ways.

1) Fully Automatic Gain Control -

Selecting either the **S(LOW)** or **F(FAST)** **AGC** setting and full clockwise **RF** Gain setting makes the gain (amplification) control fully automatic. No other gain adjustments are required. Using the **AGC** is the most convenient way to operate the receiver and is recommended for almost all receiving conditions.

The Signal Meter needle automatically fluctuates with the

strength of the signal received. A weak signal is indicated by the signal meter needle moving to the left (for example - 3). A strong signal is indicated by the signal meter needle moving to the right (for example - 40).

2) Manual Gain Control With AGC On (Slow or Fast) -

The maximum gain level can be reduced manually, as desired, by using the **RF** control knob. Turning the **RF** control knob counterclockwise will reduce the gain, causing the signal meter needle to move upscale. With the gain reduced manually, there will be less background noise when no signal is present, but signals stronger than the S-meter setting will be received normally.

3) Manual Gain Control With AGC Off -

With the **AGC** off, the **RF** Gain control must be rotated counterclockwise until the gain is reduced to the point where no signal distortion occurs. This mode of operation is seldom used.

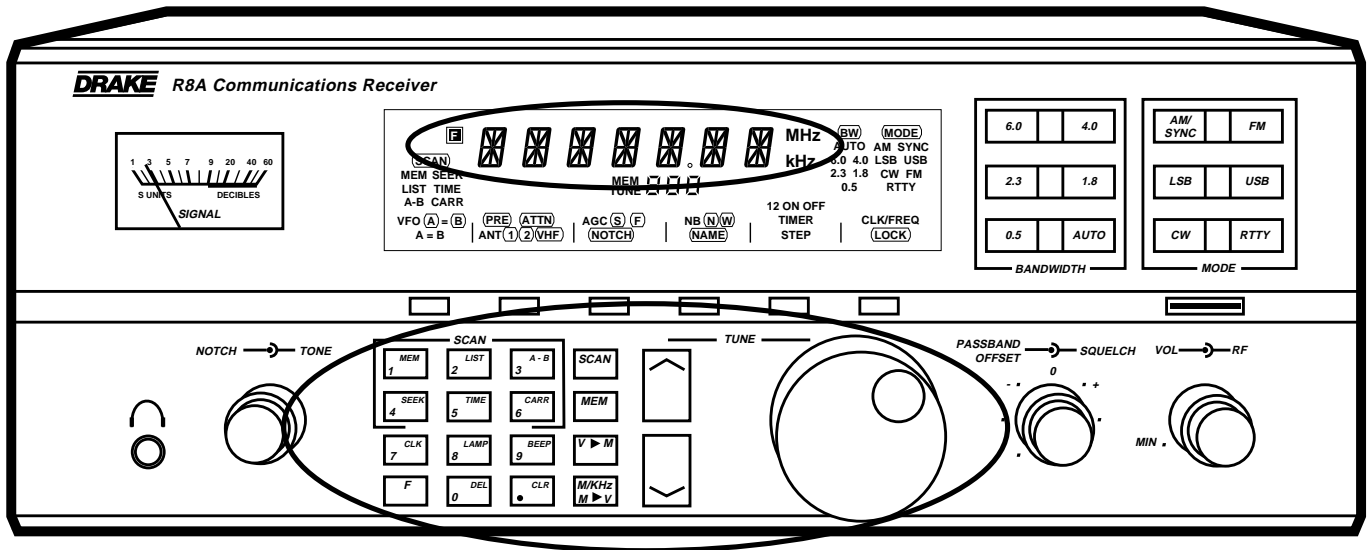

FIGURE 12

MEMORY FUNCTIONS

The receiver contains 440 programmable memory locations that can be used to store and recall commonly monitored frequencies. These 440 locations are divided into blocks of 10, ie, 00-09, 10-19, 20-29, etc. This allows convenient grouping of frequencies. As an example, 00-09 could be broadcast stations, 10-19 could be time stations such as CHU and WWV, frequencies for listening at different times of day, etc. **The receiver is preprogrammed (at the factory) with (20) useful frequencies and corresponding mode in memory channels 00-19.** With memory locations programmed, you can use the various scan functions to automatically monitor desired memory frequencies. The following may be stored in any memory location:

- 1) Frequency
- 2) Mode
- 3) Bandwidth
- 4) AGC setting
- 5) PRE or ATTN setting
- 6) Antenna
- 7) Notch ON/OFF
- 8) Noise blanker setting
- 9) Synchronous detector ON/OFF

PREPROGRAMMED MEMORY CHANNELS LIST

<u>MEMORY CHANNEL</u>	<u>FREQUENCY</u>	<u>NAME</u>	<u>MODE</u>
MEM 00	530	AM BCB	AM
MEM 01	2300	120M	AM
MEM 02	3200	90M	AM
MEM 03	3900	75M	AM
MEM 04	4750	60M	AM
MEM 05	5800	49M	AM
MEM 06	7100	41M	AM
MEM 07	9500	31M	AM
MEM 08	11600	25M	AM
MEM 09	13570	22M	AM
MEM 10	15100	19M	AM
MEM 11	17480	16M	AM
MEM 12	21450	13M	AM
MEM 13	25600	11M	AM
MEM 14	5000	WWV	AM
MEM 15	10000	WWV	AM
MEM 16	15000	WWV	AM
MEM 17	20000	WWV	AM
MEM 18	7335	CHU	AM
MEM 19	14670	CHU	AM

All above are stored as **VFO A**, **ANT 1**, **PREAMPLIFIER** Off, **AGC S** and **BW** as selected by the particular mode.

MEMORY LOCATION PROGRAMMING

First be sure the receiver is in the **VFO** mode (**MEM**, **MEM TUNE** or **SCAN** not displayed).

A) Select the desired frequency, mode, bandwidth, etc.

B) Press: and within three seconds, enter a three digit number from 000 to 439. A confirmation beep is heard.

C) Receiver will switch to NAME mode. The receiver is now ready to accept a 7-digit name for this particular memory channel as indicated by the blinking NAME annunciator.

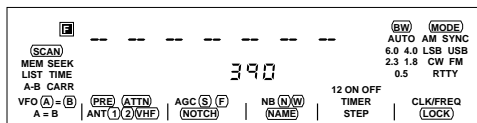
Name Assignment

If you do not want to store a name with this memory channel, press the button.

To assign a name to this memory channel, turn the Tuning wheel slowly to select the desired character or blank

space at each flashing digit location. Press the

button to scroll right. Press the

button to scroll left. After entering all desired name information, press to store the information and return the receiver to the **VFO** mode. The stored name and assigned memory channel number will be displayed.

RECALLING A MEMORY LOCATION

First, be sure that the receiver is in the **VFO** mode (**MEM**, **MEM TUNE** or **SCAN** not displayed). There are two basic methods for selecting a memory location. The **MEM TUNE** method permits frequency tuning after recalling a memory location by turning the Tuning wheel. Additional programmed memory locations are conveniently recalled

by pressing the or buttons or by directly entering

the three digit memory number. The **MEM** method, does not permit frequency retuning, but does permit convenient selection of programmed memory channels by

turning the Tuning wheel, pressing the buttons, or

by directly entering the three digit memory number.

A) MEM TUNE

First, be sure that the receiver is in the **VFO** mode (**MEM**, **MEM TUNE** or **SCAN** not displayed). Press the button. **MEM TUNE** should be displayed. If not, press the button and hold to switch to **MEM TUNE**. A confirmation

beep will be heard. Press the buttons or directly enter the desired three digit memory number.

Normal **VFO** operation will resume and the **MEM TUNE** indicator will extinguish if the Tuning wheel is turned. To recall the original memory settings, press the button.

To save any altered settings, press the button, and

within three seconds, enter the three digit memory number.

B) MEM

First be sure that the receiver is in the **VFO** mode (**MEM**, **MEM TUNE** or **SCAN** not displayed). **MEM** should be displayed. If not, press and hold the button until a confirmation beep is heard and the **MEM** annunciator is displayed. Select the desired memory channel by turning

the Tuning wheel, pressing the buttons, or

directly entering the three digit memory number. To retune the frequency, press the button and the receiver will return to **VFO** mode. Contents of the memory location are not lost. Alternately, to return to the **VFO** mode, press the **VFO** function line button. The receiver returns to the **VFO** mode and restores the last used frequency before was pressed.

DELETING A MEMORY LOCATION

A) Press and select desired memory location with the buttons, or by direct entry of a three digit

memory location. If recalling an unprogrammed location with direct entry, an error beep is heard and **Error** is displayed.

B) Press , and hold until a short, high pitched beep is heard. Display will show a new memory channel number.

C) Press or **VFO** to return to **VFO** mode.

ERASE ALL MEMORY CHANNELS

With power off, Press and hold while turning power on. Hold for 3 seconds until a confirmation beep is heard and the display shows a single '-' in the Memory Number display.

LOCKING A MEMORY LOCATION

First be sure the receiver is in the **VFO** mode (**MEM** or **SCAN** not displayed).

A) Press and select desired memory location with the buttons, or by direct entry of a three digit

memory location. If recalling an unprogrammed location with direct entry, an error beep is heard and **Error** is displayed.

B) To lock memory location: Press **LOCK**. A confirmation beep will be heard and **MEM** will now flash.

To unlock a locked memory location: Press **LOCK**. A confirmation beep will be heard and **MEM** will stop flashing.

C) Press or **VFO** to return to **VFO** mode.

SCAN FUNCTIONS

The receiver provides nine distinct scan functions which are programmed with keys **1-6** on the numeric keypad and indicated in the scan status area of the display.

Keys **1-3** are considered *modes*.

- 1 - **MEM** Scans all unlocked memory locations.
- 2 - **LIST** Scans all unlocked memory locations within a user selected group or groups of channels.
- 3 - **A-B** Scans from frequency **A** to frequency **B**.

Keys **4-6** are considered *methods*.

- 4 - **SEEK** Stops scan at first carrier detected.
- 5 - **TIME** Stops at detected carrier for five seconds, then resumes scan.
- 6 - **CARR** Stops at detected carrier until carrier drops for five seconds, then resumes scan.



A scan program therefore consists of any combination of a mode and method. For example, scanning **A** to **B** and stopping at a detected carrier five seconds, then resum- ing would be programmed with:

F **3** **F** **5** and display would indicate

A-B and TIME

Table 3 charts the nine (9) scan functions.

Scan methods can be changed while the receiver is scanning. The STEP size can be changed while the receiver is scanning. Press the **F** button followed by the STEP function line button. The PREAMPLIFIER and/or ATTENUATOR setting is unchanged from the setting prior to starting the scan, but may be changed while the receiver is scanning. Press the **F** button followed by the PREamp/ATTEN function line button. The clock display can be accessed while the receiver is in the scan mode, but only after the receiver stops on a station. All other functions are locked out until scan functions are terminated.

Pressing the   buttons during scan will reverse the scan direction. When starting a scan, the direction is always the same as the last time a scan was ended.

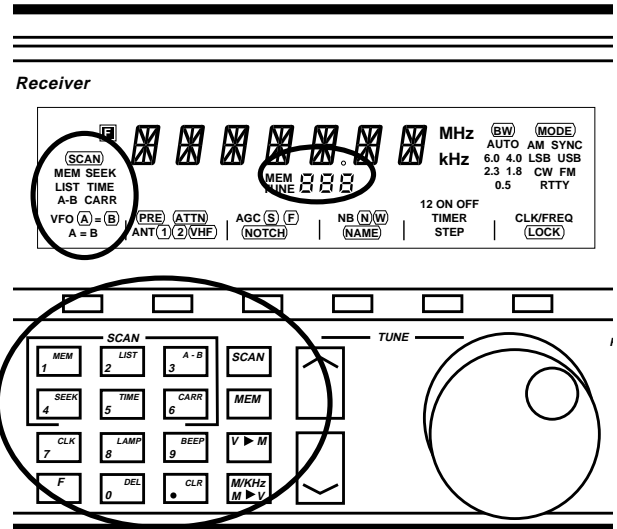

FIGURE 13

SCAN MEMORY

To scan all unlocked memory locations from 000 to 439:

Press: **F**, **MEM**; selects memory scan;
Result: **MEM** lights in status area.

Select method: **SEEK** **F**, **4** or **TIME** **F**, **5**
or **CARRIER** **F**, **6**
Result: **SEEK**, **TIME**, or **CARR** lights in status area.
Adjust squelch to quiet receiver audio.

Press: **SCAN**; **SCAN** flashes in status area and **MEM SCAN** is displayed when the scan is activated.

Scan direction may be reversed with the   buttons.

Scanning can be stopped or restarted with repeated depressions of the **SCAN** button. When scan action is stopped, the receiver remains in MEMORY mode. Press **VFO** to return to last **VFO** frequency before entering the **SCAN** mode or **M/KHz** to load contents of indicated memory location into indicated **VFO**.

MODE \ METHOD		Scan All Unlocked Memory Locations	Scan All Unlocked Memory Locations of User-Selected Lists	Scan From A to B
		1 MEM	2 LIST	3 A-B
4 SEEK	Stop at First Carrier detected	(F) (1) (F) (4)	(F) (2) (F) (4)	(F) (3) (F) (4)
5 TIME	Pause at Detected Carrier 5 Seconds Then Resume SCAN.	(F) (1) (F) (5)	(F) (2) (F) (5)	(F) (3) (F) (5)
6 CARR	Pause at Detected Carrier until Carrier Drops for 5 Seconds, Then Resume SCAN.	(F) (1) (F) (6)	(F) (2) (F) (6)	(F) (3) (F) (6)

Table 3 Scan Functions

SCAN MEMORY LIST BLOCK

The memory locations 000 to 439 are partitioned into 44 LISTS (blocks), with each block having ten memory locations (total of 440 locations). See Table 4.

A) Single list scan

Press: **F**, **LIST** selects list scan;

Result: **LIST** flashes in status area prompting list number entry, 00 - 43. Enter desired list number. For example, to scan 340 to 349, press **A-B**, **SEEK**.

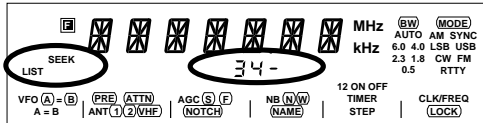

List Number	Memory Location	List Number	Memory Location
0	000 - 009	26	260 - 269
5	050 - 059	31	310 - 319
10	100 - 109	37	370 - 379
15	150 - 159	42	420 - 429
20	200 - 209	43	430 - 439

Table 4 Examples of Memory Location Blocks

Select method: **SEEK** **F**, **SEEK** **4** or **TIME** **F**, **TIME** **5**
or **CARRIER** **F**, **CARR** **6**

Result: **SEEK**, **TIME**, or **CARR** lights in status area.

Adjust squelch to quiet receiver audio.

Press: **SCAN**; **SCAN** lights in status area when scan is activated and display will indicate MEM SCAN until scanning detects a carrier on a scanned channel. Upon carrier detection, the **SCAN** will flash.

Pressing the **UP** **DOWN** buttons during scan will reverse the scan direction. Scanning can be stopped or re-started with repeated depressions of the **SCAN** button. When scan action is stopped, the receiver will be in MEMORY mode. Press **VFO** to return to last VFO frequency before entering scan or **M/KHZ** to load contents of indicated memory location into indicated VFO.

B) Multiple LIST scan

Press: **F**, **LIST** selects list scan.

Result: **LIST** flashes in status area and the memory channel number will display the first list number in the current setup. At first, this will be - - -, indicating that no list has been entered. Enter first list number as two digits, **00** through **43**.

To enter another list number, press the **UP** button, followed by the second list number. For example, to scan 340 to 349, and 400 to 409,

press **A-B**, **SEEK**, **UP**, **SEEK**, **DEL**.

To review the current setup, press the **DOWN** button.

Attempting to scan an empty list will result in an error tone and request for a new value. To clear a single entry, press **CLR**. To clear the entire list, press **F**, **CLR**.

Select method: **SEEK** **F**, **SEEK** **4** or **TIME** **F**, **TIME** **5**

or **CARRIER** **F**, **CARR** **6**

Result: **SEEK**, **TIME**, or **CARR** lights in status area. Adjust squelch to quiet receiver audio.

Press: **SCAN**; **SCAN** flashes in status area when scan is activated, and display will indicate MEM SCAN until scanning detects a carrier on a scanned channel.

Pressing the **UP**, **DOWN** button during scan will reverse the scan direction. Scanning can be stopped or re-started with repeated depressions of the **SCAN** button. When scan action is stopped, the receiver remains in MEMORY mode. Press **VFO** to return to the last VFO frequency before entering scan or **M/KHZ** to load contents of indicated memory location into indicated VFO.

LOCKING A MEMORY LOCATION

First be sure the receiver is in the **VFO** mode (**MEM** or **SCAN** not displayed).

A) Press **MEM** and select desired memory location with

the **UP** **DOWN** buttons, or by direct entry of a two digit memory location. If recalling an unprogrammed location with direct entry, an error beep is heard and **Error** is displayed.

B) To lock memory location: Press **F** **LOCK**. A confirmation beep will be heard and **MEM** will now flash.

To unlock a locked memory location: Press **F** **LOCK**. A confirmation beep will be heard and **MEM** will stop flashing.



C) Press **M/KHZ** or **VFO** to return to **VFO** mode.

SCAN A - B

An A - B scan allows continuous tuning of frequencies between two programmed limits. Table 4 charts the tuning step size and display resolution for all models. If the selected scan range includes the AM broadcast band, the receiver automatically switches to a 10 kHz step size (9 kHz selectable) while in the AM broadcast band range.

To perform an **A - B** scan, press **F**, **3** **A-B**.

Result: **A - B** flashes and the frequency display changes to show one of the current scan frequency endpoints. To change this endpoint, enter a new frequency. To set the

second endpoint, press the  or  button. The

display now shows the other frequency endpoint. Enter a new frequency, if desired. To review the endpoints, press

the  or  buttons.

Select method: **SEEK** **F** **4** **SEEK** or **TIME** **F** **5** **TIME**

or **CARRIER** **F** **6** **CARR**

Result: **SEEK**, **TIME**, or **CARR** lights in status area.

Select desired mode, bandwidth (BW), antenna, etc.

Adjust squelch to quiet receiver audio.

Press **SCAN**; **(SCAN)** flashes in status area when scan is activated.

To adjust step rate: Press **F** **STEP** and step size will change as per table 5.

Display will indicate scanned frequency. Scanning can be stopped or restarted with repeated depressions of the **SCAN** button. When scan action is stopped, the receiver will be in the **VFO** mode.

To program a 9 kHz step rate for overseas broadcast band reception-

Press **POWER** to turn receiver off

Hold **TIMER/STEP** function button

Press **POWER** to turn receiver on

9 kHz step in broadcast band is now programmed. This setting is saved even if power is removed from the receiver. To change back to 10 kHz, repeat above steps.

Mode	Scanning Resolution (Hz)			Display Resolution (Hz)		
	Default	Step 1	Step 2	Default	Step 1	Step 2
USB, LSB, CW, RTTY, AM, FM	1K	5K	100	1K	1K	100
AM Broadcast Band	1K	10K*	100	1K	1K	100

(*or 9kHz if programmed)

Table 5 Scan Tuning Rates

Important Notes About Scanning

To avoid impaired scanning action, it is recommended not intermix HF with VHF channels, which imposes rapid switching on the antenna select relay.

In all scanning modes the setting of the SQUELCH control is important for proper scanning action. Due to atmospheric noises alone, using a squelch control in the HF spectrum is, at best, a compromise. A more exact method of SQUELCH setting is provided here.

First, be sure the SQUELCH control is counterclockwise. Next, adjust the RF gain control slowly counterclockwise until the S METER reads the signal level desired to trip the squelch circuit. For example, if you want only signals S-7 or stronger to break the SQUELCH, rotate the RF GAIN control until the S-METER is reading S-7. Next, leaving the RF GAIN control alone, advance the SQUELCH control clockwise until the receiver audio just quiets. Finally, advance the RF GAIN fully clockwise. The receiver is now ready for accurate scanning.

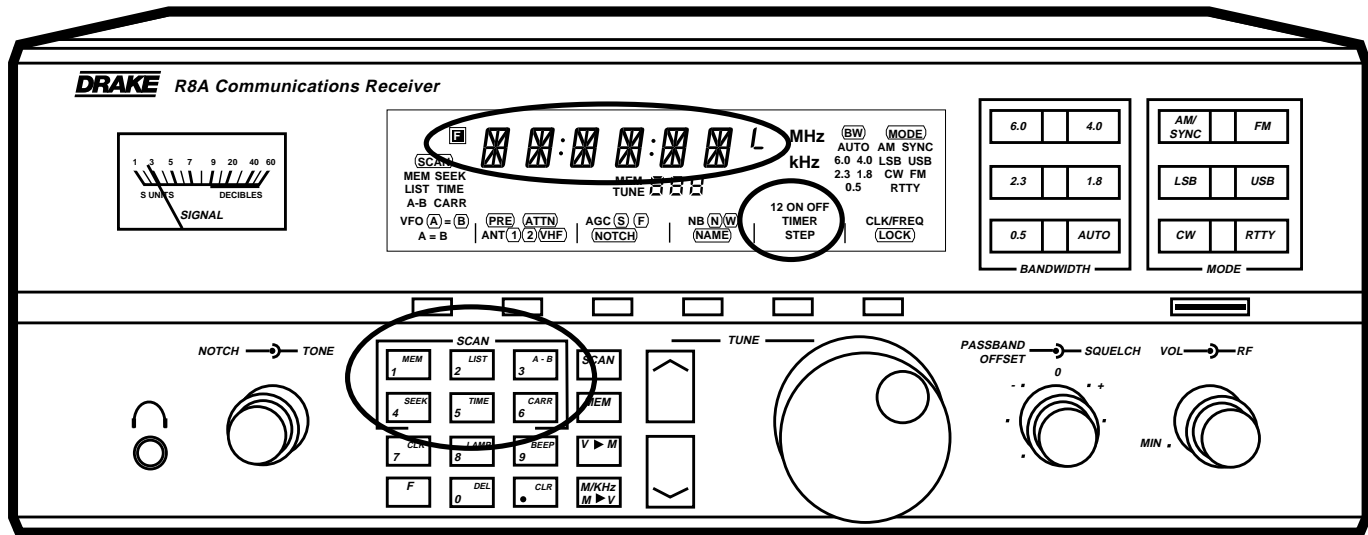

FIGURE 14

TIME DISPLAY

The receiver incorporates dual time clocks allowing two 24 hour clocks to be set and maintained. During loss of AC power, clock operation is maintained for a period of approximately 30 minutes. The two-event timer functions are also derived from the last displayed clock, therefore the clocks must be set first for proper TIMER operation. TIMER Settings are maintained through a power loss.

Pressing the **CLK/FREQ** function button will toggle the display between the time of the current clock and the operating frequency. Press the **F** button followed by the **7** button to toggle between the two clocks, **L** and **U**. Normally the clock accompanied by the **L** on the display will be set with the local time, while the alternate clock will be set to display GMT (UTC) time. The receiver will display the selected clock when the **POWER** is turned off.

SETTING THE 24 HOUR CLOCKS

Select local (**L**) or alternate time clock by pressing the **F** button followed by the **7** button.

With the **F** displayed, press and hold the **7** button for three seconds until the colons begin flashing rapidly. If the **L** is illuminated, you are setting the local clock.

With **U** displayed, you are setting the alternate clock. Either clock can be set first. Time is entered in a 24 hour format.

Enter the time in 'HH:MM:SS', with the 'colons' understood.

If an erroneous entry is made, simply enter the correct time again. The incorrect entry will scroll off the display.

Press the **F** button to start the clock when the actual time value agrees with the entered time.

Example for Local Clock Set:

With either frequency or time displayed, suppose it is desired to set **13:01:00** -

Press the **F** button, then press and hold the **7** button until the colons flash rapidly.

Press the following sequence of numeric buttons:

1 MEM	3 A-B	0 DEL
00:00:01 ^L	00:00:13 ^L	00:01:30 ^L
1 MEM	0 DEL	0 DEL
00:13:01 ^L	01:30:10 ^L	13:01:00 ^L

When the actual time is 13:01:00, Press the **F** button. The clock is now started.

TIMER OPERATION

Two programmable event timers allow the receiver to turn ON or OFF at preset times. The timers may be used separately or together and may recall a currently displayed frequency, memory channel or a combination of both. In addition, programming only an OFF time provides a Sleep timer; programming only an ON time provides a Wake timer. **Note that the timers, when activated, respond to the last displayed clock.**

Programming the timers is a two step process. Step one is to set the ON and OFF times. Step two is to assign a frequency or memory channel to a timer. This assignment occurs when the desired timer is actually enabled.

SETTING TIMER ON/OFF TIMES

Press and hold the **TIMER** function button for approximately 2 seconds until the **ON** annunciator flashes. The **ON** Time will also be indicated in the frequency portion of the display (same readout format as the clock) as well as the number **1** or **2** displayed to the left of the **ON** annunciator. The number **1** or **2** indicates which one of the two event timers you are programming.

Press the desired numeric buttons to enter a new **ON** time. Enter the time in 'HH:MM' and in 24 hour format. Press the **F** button followed by the **CLR** button to remove the 'On Time' to use the timer as a Sleep timer. For a Wake timer, program an 'On Time' and remove the 'OFF' time.

To set the **OFF** time, Press the **TIMER** function button again to display **OFF** time. Press the desired numeric buttons to enter a new **OFF** time. Enter the time in 'HH:MM' and in 24 hour format.

Press the **F** button followed by the **CLR** button to remove the **OFF** time, if desired.

Press the **TIMER** function button again to enter **TIMER 2 ON** time.

Press the **TIMER** function button again to enter **TIMER 2 OFF** time.

Finally, press the **TIMER** function button to save the settings and switch the display to normal readout values.

ENABLING/DISABLING TIMER OPERATION

Press the **TIMER** function button. A '1' or '2' or '- -' will be displayed. After two seconds with no entry, the display reverts back to frequency or time readout. Timer '1' can be disabled/enabled by pressing the numeric digit **1** on the keypad while the timer enable display is showing. Timer '2' can be disabled/enabled by pressing the numeric digit **2** on the keypad while the timer enable display is showing.

Prior to enabling either or both timers, consider one of two possible cases for each timer:
eg.) - To Enable **TIMER 1** —

1) '- -' is displayed: Press the **1** button to display 1.

2) '1 -' is displayed: Press the **1** button **twice** to again display 1.

Setting a - for either timer **DISABLES** the respective timer.

Timers **1** and **2** Enabled

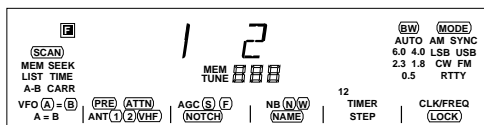

Timer **1** Enabled; Timer **2** Disabled

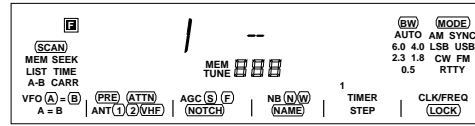

If either one or both the timer **1** or timer **2** are enabled, the **1** or **2** annunciator will continue to be displayed after the receiver is turned off. **Be certain to leave the volume setting at the desired level.** The receiver will automatically turn on and off as programmed. If both timers are disabled, the timer programming in either or both timers is retained, but no **TIMER** action will take place until one or both are enabled.

1) Example for Setting Timer '1'

With frequency displayed, suppose it is desired to set Timer **1** for a local ON Time: '16:59'
OFF Time: '18:01'

Action:

Press and hold the **TIMER** function button until the **1 ON** annunciator flashes.

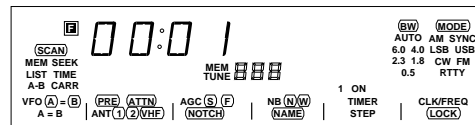

Press the sequence: **1**, **6**, **5**, **9**

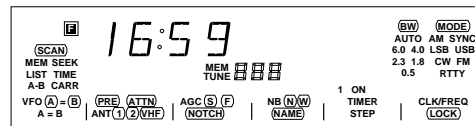

Press the **TIMER** function button.

Press the sequence: **1**, **8**, **0**, **1**

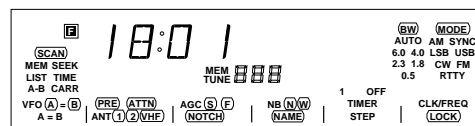

Press the **TIMER** function

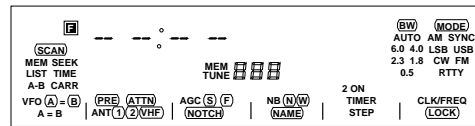

If it is desired to set 'Timer 2', use the same procedure as that for 'Timer 1', otherwise, press the **TIMER** function button twice to exit setting Timer operation and return to normal frequency display.

It is important to note that the timer is enabled only when the timer is deliberately changed from a - to 1, or - to 2. Even if the 1 or 2 is already displayed, the timer is not enabled unless the - to 1 or 2 transition occurs.

2) Example for Setting Events on Two Different Memory Channels:

eg.) PROGRAMMING MEM 008 in Timer 1;
MEM 029 in Timer 2:

With frequency displayed,

Press **MEM** followed with the numeric button sequence:



Press the timer function button followed within 2 seconds by depression(s) of the **MEM 1** button until the 1 is displayed with **MEM 008** indicated. Even if the 1 is already displayed, the timer is not enabled unless the '-' to 1 transition occurs.

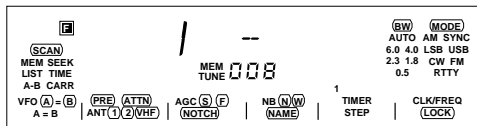

After 3 seconds, the display reverts to the frequency readout.

With frequency displayed,

Press **MEM** followed with the button sequence:

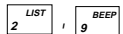

Press the timer function button followed within 2 seconds by depression(s) of the **2 LIST** button until the 2 is displayed with **MEM 029** indicated. Even if the 2 is already displayed, the timer is not enabled unless the '-' to 2 transition occurs.

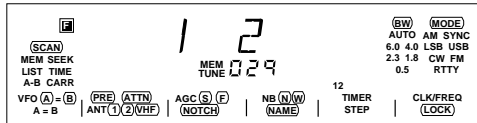

After 3 seconds, the display reverts to the frequency readout.

To set a timer without recalling a specific memory channel, exit the memory mode before enabling the timer. In this case, the receiver maintains its current settings. Refer to 'ENABLING/DISABLING TIMER OPERATION' to enable or disable either of the two timers.

3) Example for Setting Overlapping Events:

With frequency displayed, suppose it is desired to record a one hour program on one frequency with a beginning time of '16:59' and an ending time of '18:00'; and a second program on the same frequency with a beginning time of '18:00' and an ending time of '19:01'.

Action:

Press and hold the **TIMER** function button until the 1 **ON** annunciator flashes.

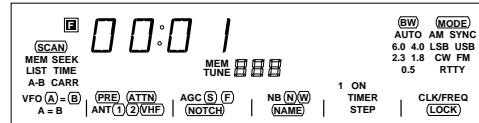

Press the sequence: **MEM 1**, **CARR 6**, **5 TIME**, **9 BEEP**

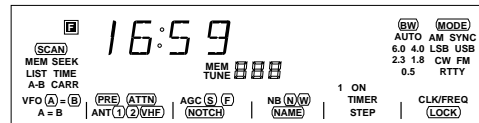

Press the **TIMER** function button.

Press the **TIMER** function button (enters no OFF Time for timer 1)

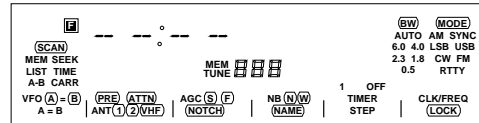

Press the **TIMER** function button

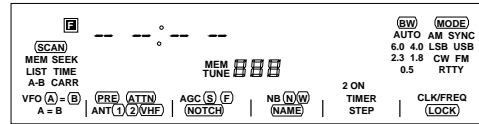

Press the sequence: **MEM 1**, **LAMP 8**, **0 DEL**, **0 DEL**

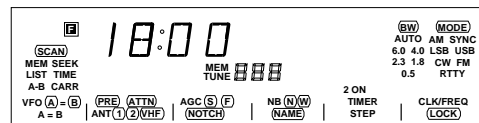

Press the **TIMER** function button

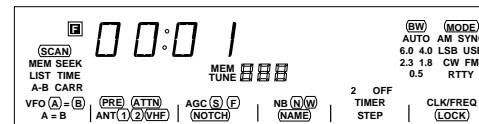

Press the button sequence: **MEM 1**, **BEEP 9**, **0 DEL**, **MEM 1**

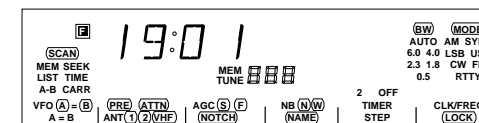

Press the **TIMER** function button for normal frequency display.

TIMER CONNECTOR INTERFACE

A standard 5 pin DIN connector located on the rear panel provides the connections for unattended, programmed Timer control of cassette recorders, RTTY or FAX demodulators, etc. Please refer to **Figure 15** for a pin by pin description of this connector.

WARNING!!!

DO NOT USE TIMER CONNECTIONS TO SWITCH STANDARD 120 VAC LINE OPERATED EQUIPMENT DIRECTLY. MAXIMUM RATINGS OF TIMER CONNECTIONS ARE 30 VDC AT 1 AMPERE. IF IT IS NECESSARY TO SWITCH THE 120 VAC LINE UNDER TIMER CONTROL, IT WILL REQUIRE THE ADDITION OF AN EXTERNAL RELAY WITH THE PROPER CONTACT RATING THAT IS DRIVEN FROM THE RECEIVER'S TIMER CONNECTOR.

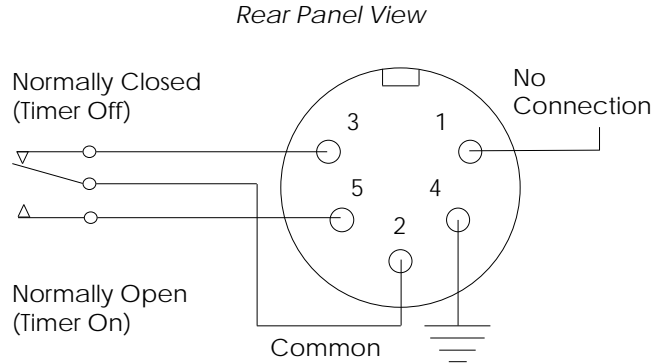

Figure 15 Timer Connections
Contacts shown with **TIMER OFF**

- Pin 1: No Connection.
- Pin 2: Timer Relay Common Connection. This connection switches between Pins 3 and 5 depending on the state of **Timer 1** or **2**.
- Pin 3: Timer Relay Normally Closed Connection. Connected to relay Common when **Timer 1** or **2** is OFF.
- Pin 4: Chassis Ground Connection.
- Pin 5: Timer Relay Normally Open Connection. Connected to relay Common when **Timer 1** or **2** is ON.

As mentioned above, a common usage of the internal timer relay is to control a tape recorder to provide automatic, unattended recordings of received programs. By programming **Timer 1** or **2** On/Off times into the receiver, the recorder will be turned On at the **Timer ON** time, record the program, and then turn off at the **Timer OFF** time.

A typical connection diagram is shown in **FIGURE 16**.

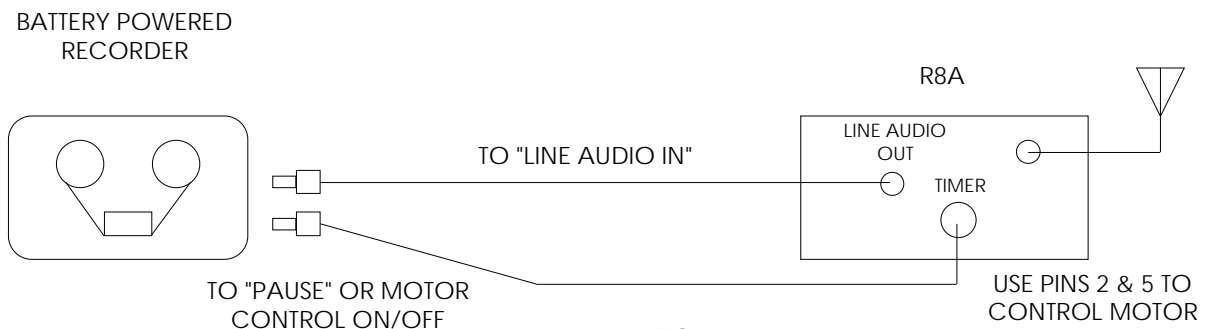

FIGURE 16

This receiver has several special features that are referred to in the main body of this owner's manual but may require additional explanation.

FUNCTION LINE INVERT

As described on page 11 of this manual, the six function buttons, located below the display area of the receiver, activate a primary or secondary function if the **F** annunciator is displayed or not. The user can define either of two function lines as primary functions. To continuously access the alternate function line without incurring the time out action, Press the **F** button and hold for 3 seconds until a confirmation beep is heard. The **F** annunciator will remain lit indicating that the alternate function line is now continuously active.

To summarize, pressing the **F** button allows access to the alternate function line for the short duration. Alternate function availability times out after any front panel inactivity. Pressing the **F** button and holding it for 3 seconds acts as a Shift Lock on the function lines.

SETTING POWER OFF (ON) LAMP BRIGHTNESS

To set the brightness of the display when the power is turned off, press the **F** button followed by the **LAMP B** button until the desired brightness is selected. Continue to hold down the **LAMP B** button and turn power off. This action will store the Off state brightness. Turn power on and press the button sequence **F**, **LAMP B** to set the power On state brightness. Now the lamp will automatically change to the desired brightness for power on and power off states. This can be used to dim or blackout the display when power is off, without changing the lamp state during use of the radio.

POWER ON BUTTON FUNCTIONS

Press the button shown while turning power on to perform the indicated function.

* Indicates hold for two seconds.

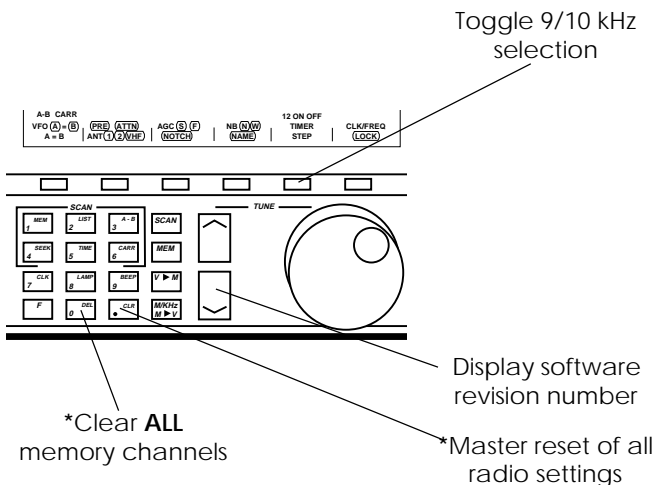

10 kHz/9 kHz SCAN

If a selected scan range includes the 540-1800 kHz broadcast band, the receiver automatically switches to a 10kHz step size while the receiver scans the broadcast band. The 10 kHz step size is practical for tuning the U.S. and Canadian broadcast bands. The step size can be changed to 9 kHz for the 540 - 1800 kHz broadcast band to permit practical tuning of European broadcast stations. To select the alternate step size:

With the **POWER OFF**

Press the **TIMER/STEP** function button and hold while pressing the **POWER** button.

If the step size was 10 kHz prior to performing the above procedure, then the 9 kHz step size is now programmed. To change back to 10 kHz, repeat the same procedure.

DELETE ALL MEMORY LOCATIONS

If it is desired to delete **ALL** programmed memory locations, perform the following procedure:

With **POWER OFF**,

Press the **DEL** button and hold while pressing the **POWER** button.

Hold the **DEL** button until a double 'beep' is heard to indicate that ALL memory locations have been cleared.

HELD BUTTON FUNCTIONS

Hold the indicated button for two seconds to perform the function shown.

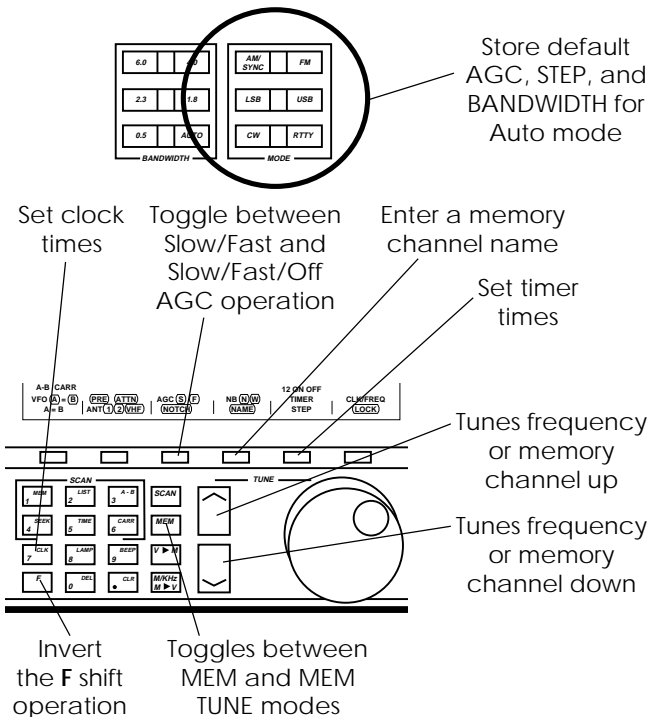

The receiver rear panel provides a common DB-9 connector which conforms to the RS-232C serial data communications standard with the receiver configured as DCE. This connector may be attached to a basic dumb ASCII terminal or a personal computer such as an IBM XT/AT running a terminal emulation program such as PROCOMM PLUS™ or BITCOM™. Standard BASIC terminal programs will run equally well.

The interface provides complete control and programming capability of the receiver. Only the analog controls such as volume, RF gain, etc. are not controllable. The receiver front panel buttons and tuning wheel are normally operable when the receiver is under computer control. The buttons and tuning wheel can be locked out, if desired, either by pressing the button sequence: F, **LOCK** function line button or by use of the 'LO' computer command.

Please refer to **FIGURE 17** for interface connector pin out.

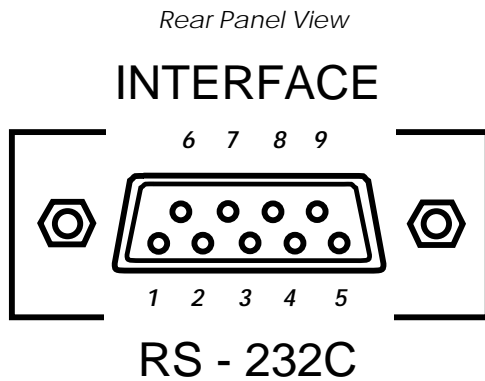

Pin	Signal Description
1	Scan Feedback; +5 Volts = Receiver Unsquelled
2	Rx DATA
3	Tx DATA
4	No Connection
5	Ground
6	No Connection
7	No Connection
8	No Connection
9	Ground

FIGURE 17 RS232C Interface Connections

PROCOMM PLUS™ is registered to DATASTORM Technologies, Inc.
P.O. Box 1471
Columbia, MO 65205

BITCOM™ is registered to BIT Software, Inc.
830 Hillview Court, Suite 160
Milpitas, CA 95035

NOTE:

The following additional items apply when using the RS232C Interface capability of the receiver:

WARNING:

SHIELDED INTERFACE CABLES MUST BE USED WITH THIS RECEIVER FOR FCC COMPLIANCE TO LIMITS FOR A CLASS B DIGITAL DEVICE.

When interfacing the receiver to a computer utilizing a 25 pin male connector for the RS-232C serial port, the following wiring convention should be followed:

Receiver DB9 Connector	Computer DB25 Connector
1	8
2	3
3	2
4	20
5	7
6	6
7	4
8	5
9	22

Note: This equipment has been tested and found to comply with the limits for a Class B digital device, pursuant to Part 15 of the FCC rules. These limits are designed to provide reasonable protection against harmful interference in a residential installation. This equipment generates, uses and can radiate radio frequency energy and, if not installed and used in accordance with the instructions, may cause harmful interference to radio communications. However, there is no guarantee that interference will not occur in a particular installation. If this equipment does cause harmful interference to radio or television reception, which can be determined by turning the equipment off and on, the user is encouraged to try to correct the interference by one or more of the following measures:

- Reorient or relocate the receiving antenna.
- Increase the separation between the equipment and the receiver.
- Connect the equipment into an outlet on a circuit different from that to which the receiver is connected.
- Consult the dealer or an experienced radio/TV technician for help.

Index to Commands (listed by function group, then in alphabetical order of function)

FUNCTION	COMMAND GROUP	RESPONSE
1. Basic Radio Controls		
AGC Setting	AF, AS, AO	CR AND LF
Antenna selection	A1, A2, AC	CR AND LF
Bandwidth selection	W0, W1, W2, W4, W6	CR AND LF
Frequency entry	F[nnn.nnnnn],F[nnnnn.nn] or F[nnnnnnn]	CR AND LF
Mode selection	M1, M2, M3, M4, M5, M6	CR AND LF
Noise blanker setting	BF, BN, BW	CR AND LF
Notch setting	NF, NO	CR AND LF
Power on/off (5)	PF, PO	CR AND LF
Quick Set (7)	Qddddddd	CR AND LF
RF gain setting	G+, G-, G0	CR AND LF
Step size selection (2)	ST0, ST1, ST2, ST3, or ST	CR AND LF
Synchronous detector setting (2)	SF, SO	CR AND LF
Tune Up (2)	U	NONE
Tune Down	D	NONE
VFO selection	VA, VB	CR AND LF
VFO A = VFO B	A E B	CR AND LF
2. Memory Management		
Block Read (7)	BR sss, eee	SS
Block Store (7) *(10)	BS sss ← ddddddd	CR AND LF
Erase All	EA[Y]	CR, LF or NONE
Erase Channel	ECn[nn]	CR AND LF
Mem Tune Control	CTF, CTO	CR AND LF
Name Channel	NCccccccc	CR AND LF
Name Mode Control	NA, NI	CR AND LF
Recall Channel	C[nnn]	CR AND LF
Store (Program) Channel	PR ← [nnn]	CR AND LF
3. Information Retrieval		
Identify Receiver (5)	ID	R8A.n CR LF
Output Control (8)	OO, OF	CR AND LF
Report (9)	R[A][F][C][M][SS][S][N][R]	Scan Report
Report the Scan List (9)	R (SL)	Scan Report
4. Scan Functions		
Scan Method (2)	S1, S2, S3	CR AND LF
Scan Mode (2)	S4, S5, S6	CR AND LF
Start/Stop Scan (2)	SC, SCO, SCF	CR AND LF
Scan [Transfers the current VFO (A or B) to the A - B scan limits]	SA, SB	CR AND LF
Scan List [Allows entry of lists to scan - any 10 of a possible 44 lists ('00' - '43')]	SL XX, XX, XX, ... ←	CR AND LF
5. Clock & Timer Functions		
Timer Disable	TD[1,2]	CR AND LF
Timer Enable	TE[1,2]	CR AND LF
Timer Relay Control	TF, TO	CR AND LF
Activate Relay on Squelch Break	TSF, TSO	CR AND LF
Local Time Report,[Entry]	TL[hhmmss]	CR AND LF
UTC Time Report,[Entry]	TU[hhmmss]	CR AND LF
Timer Time Report,[Entry]	T[1,2][F,O][hhmm]	TR LF
6. Miscellaneous		
Lock Front Panel	LF, LO	CR AND LF
Load Defaults	LD[Y]	CR AND LF
Set AM BCB Step size	SSE, SSU	CR AND LF
Select MHz/kHz	SM, SK	CR AND LF
Select Frequency Display Mode	FR	CR AND LF
Select Time Display Mode	TI	CR AND LF
Select Display Brightness	LB	CR AND LF

← =
Enter key

← =
Enter key

← =
Enter key

Note: The Lock front panel commands (LO and LF) work as expected when locking and unlocking the front panel from a PC - (LO locks it and LF unlocks it). However, when locking and unlocking a scanned channel, LO toggles the lock on and off, and LF has no affect at all.

NOTES:

(1) All commands terminated by carriage return CR, except U and D. Commands 'Cx' and 'Fxxxxxx' require an optional Carriage Return as follows:

- If 'Cx' is followed by a Carriage Return, response is immediate.

- If 'Cxxx' is entered, response is immediate (but note that no Carriage Return was required in this case).

(2) These commands may be used during scanning. Others are locked out.

(3) A null entry (carriage return by itself) results in a LF response.

Invalid commands result in a 'Not recognized' response.

(4) Format: RS-232C levels at rear panel connector. 9600 baud, half Duplex 1 start bit, 8 data, 1 stop bit, no parity

Data is ASCII encoded.

(5) These commands allowed even if power is turned off (see PO/PF). Others are locked out.

(6) Backspace can be used to correct typing error before hitting return.

(7) Commands Intended for use in computer control use hexadecimal data.

(8) Causes a report from the receiver whenever any receiver setting is changed.

(9) Report types may be entered in any combination for customized reports.

*(10) Block Store might not work under PROCOMM PLUS™. Use Windows™ Terminal program or Telix™ program.

NOTE that PROCOMM PLUS™ might not work with the Block Store command. There are two suggested methods that will allow programming the Block Store command:

1) WINDOWS™ Terminal Instructions -

The WINDOWS™ terminal can be used with the delay per character set to 1/10 second to permit ASCII downloads to function properly with Block Store commands.

Under the 'Settings' menu, select 'Text Transfers'. Under 'Flow Control', select 'A Character at a Time'.

Under 'Transfer a Character at a Time', select 'Delay Between Characters /10 second'.

ASCII downloads are performed by selecting the 'Transfer' menu and selecting the 'Send Text File'.

- OR -

2) TELIX™ (V3.20) Instructions -

Alt 0 Select Terminal options

A Port COM? Baud: 9600, Parity: None
Data bits: 8, Stop bits: 1

B Emulate before translate table: Off

C Default terminal type: ANSI

D Status Line: Bottom

E Local echo: On

F Add line feeds after carriage returns: Off

G Strip high bit (in-coming data): Off

H Received Backspace destructive: Off

I Backspace key sends: BS

J XON/XOFF software flow control: Off

K CTS/RTS hardware flow control: Off

L DSR/DTR hardware flow control: Off

M Compuserve Quick B transfers: On

N Z Modem auto-downloads: On

O Answerback string

Select ASCII Transfers:

A Strip high bit: Off

B Remote abort character: 0 (ASCII)

C Local echo: Off

D Expand blank lines: Off

E Pace Character: 42 (ASCII)

F Line Pacing: 10

G Character Pacing: 999

H CR translation: None

I LF translation: None

J CR translation: None

Telix™ V.20 was demonstrated to work with the Block Store command using the pacing character feature of Telix™.

The pacing character used is '*' (decimal 42). This action prevents the receiver from being overrun with data from Telix™.

The ASCII transfer setup parameter 'E' is set to 42. The ASCII transfer setup parameter 'G' is machine dependent. The delay of '999' represents the greatest delay and therefore ensures proper operation.

CTS handshaking is supported, but many PC programs overrun the receiver's RS232C buffer causing Block Store operations to fail when the overrun conditions exist.

Block Store download files are created using editors which support binary/hex editing modes or by using the Block Read command to upload memory information from the receiver.

Setting Strings used in Quick Set, Block Store, and Block Read commands:

Some commands work with 'setting strings'. These allow fast and direct setting or reading of certain radio information. They are intended for use within a computer program only. All operations using these can be done manually with other commands using much less cryptic formats. Note that invalid settings will be overridden in most cases without warning.

Since these commands use hexadecimal data in the command strings, it is important that the host terminal use an RS232 receiver program that does not attempt to translate control characters into their respective actions. For example, some programs intended for modem communications translate a data byte received as hex 08 into the destructive backspace action. Such programs usually supply option settings to select whether control characters are translated or not. Translation of data into control actions will result in unpredictable results, since some of the setting information will be lost or changed.

A setting string consists of from 7 to 14 bytes formatted as follows: dd nn nn nn nn dd dd [c[c[c[c[c[c]]]]]]

where dd = a hexadecimal data byte, format described below
 nn = two digits 0-9
 c = any ASCII character value, in the R8A character set

The format for each of the bytes is:

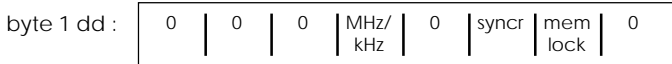

bytes 2-5: frequency in 'little-endian' form. These are the digits of the frequency in decimal form but in reverse order pairs. For example, a frequency of 123.45670 MHz would be entered as 70 56 34 12. The MHz decimal is always fixed between the nibbles of byte number 4.

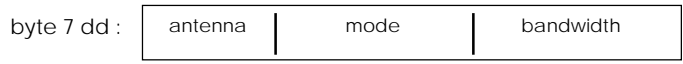

bytes 8-14 : These bytes are optional and contain the name for the accompanying data. This is intended for use with high speed memory store and recall functions. Names can be less than 7 characters without filling the string out to 7. When doing block store operations, a hexadecimal 7F can be used to terminate names shorter than 7 characters, eliminating the need to send unneeded bytes. For example, if the radio is doing a block store of channels 20 through 30, and channel 21 is named 'NAME' while 22 is unnamed, the data strings sent for each of those would be:

ch 21 data: 00 70 56 34 12 00 00 'N' 'A' 'M' 'E' 07FH
 ch 22 data: 00 25 12 94 02 00 00 07FH

Thus, instead of sending 28 bytes for these two channels, only 20 are required to convey all the information.

Similarly, a 7F can be used to indicate a blank channel in a string.

In the above example, if channel 22 were blank, the string for channel 22 could be sent as simply: ch 22 data: 07FH

This reduces the data for a blank channel from 8 meaningless bytes to only 1. Data sent in a block store must be terminated with a hex value of 7D.

Data for various fields listed above:

- | | |
|--------------------------------------------------------|---------------------------------------------------------------------------------------------|
| Noise Blanker (2 bits): 00 OFF
01 NARROW
11 WIDE | Mode (3 bits): 000 LSB
001 USB
010 RTTY
011 CW
100 FM
101 AM |
| AGC (2 bits): 00 OFF
10 FAST
11 SLOW | Bandwidth (3 bits): 000 0.5 kHz
001 1.8 kHz
010 2.3 kHz
011 4.0 kHz
100 6.0 kHz |
| Antenna (2 bits): 00 ANT 1
01 VHF CONV
10 ANT 2 | |

Table 6

RESPONSE TO THE RM AND RMR COMMANDS:

ASCII CHARACTER DISPLAYED ON SCREEN	FIRST CHARACTER		SECOND CHARACTER		THIRD CHARACTER		FOURTH CHARACTER	FIFTH CHARACTER				ASCII
	NOISE BLANKER	AGC	RF	NOTCH FILTER	ANT	MODE	BANDWIDTH	VFO	SYNCHRO DET.	SCANNING	MHz/kHz	
0	OFF	OFF	OFF	OFF	1		.5 KHz	B	OFF	NO	K	0
1	-	-	OFF	OFF	1		1.8			NO	M	1
2	OFF	FAST	OFF	ON	1		2.3			YES	K	2
3	OFF	SLOW	OFF	ON	-		4.0			YES	M	3
4	NARROW	OFF	ATTEN	OFF	CONV		6.0			NO	K	4
5	-	-	ATTEN	OFF	CONV		-			NO	M	5
6	NARROW	FAST	ATTEN	ON	CONV		-			YES	K	6
7	NARROW	SLOW	ATTEN	ON	-		-			YES	M	7
8	-	-	PREAMP	OFF	2		0.5	A	OFF	NO	K	8
9	-	-	PREAMP	OFF	2		1.8			NO	M	9
:	-	-	PREAMP	ON	2		2.3			YES	K	:
;	-	-	PREAMP	ON	-		4.0			YES	M	;
<	WIDE	OFF	-	-	-		6.0		ON	NO	K	<
=	-	-	-	-	-		-			NO	M	=
>	WIDE	FAST	-	-	-		-			YES	K	>
?	WIDE	SLOW	-	-	-		-			YES	M	?

EXAMPLE: You type - RM (ENTER) and the radio response on your screen is:

3 0 2 < 8 FROM TABLE

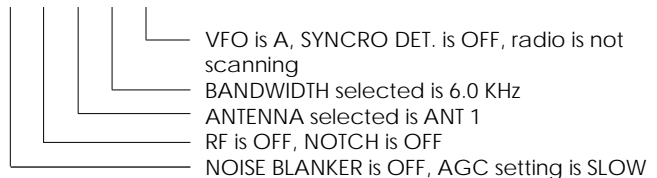

And using characters 3&4, from Table 7:



Table 7

THIRD CHARACTER	FOURTH CHARACTER	
0, 4, OR 8	0, 1, 2, 3, OR 4	8, 9, :, ;, OR <
1, 5, OR 9	LSB	USB
2, 6, OR :	RTTY	CW
	FM	AM

- 1) AC Input** - Alternating Current power source available at wall outlet sockets.
- 2) AM** - Amplitude Modulated signals in which the information or intelligence being transmitted changes the instantaneous amplitude of the transmitted carrier. Not to be confused with the AM Broadcast Band (frequencies of 540 to 1610 kHz).
- 3) AGC** - Automatic Gain Control which is employed in receivers to adjust the amount of gain in the receiver's circuitry to prevent distortion and maintain a nearly constant audio volume level over wide variations in received signal strength.
- 4) Attenuation** - Loss, as applied in the text of this manual, added prior to the input stages of the receiver to reduce the level of very strong signals that may occur on certain bands, in certain locations, at certain times or a combination of all three factors. Each 10 dB (decibel) step reduces the power of the received signal by a factor of ten.
- 5) CW** - Continuous Wave transmission signals. Actually, the signal is keyed on and off at precise intervals to convey information. Morse code is the most common CW signal.
- 6) DC Input** - Direct Current power source such as is available from batteries or regulated power supplies. Lead acid storage batteries, such as employed in cars and boats, have a 12-14 volt DC output which is the proper operating voltage for the receiver's DC input. Another requirement of the battery is its AMP-HR rating. To determine the number of hours of operation before battery recharging is required, divide the AMP-HR rating of the battery by (2 AMPS) the current requirement of the receiver.
- 7) Dynamic Range** - Ability of the receiver to faithfully reproduce high quality audio over a wide range of signal strength conditions - from very weak signals to very strong signals.
- 8) Frequency** - Rate of reoccurrence in hertz or cycles/second of electromagnetic wave or carrier.
- 9) FM** - Frequency Modulated signals in which the information or intelligence being transmitted changes the instantaneous frequency of the transmitter carrier. Not to be confused with the FM Broadcast Band (frequencies of 88 to 108 MHz).
- 10) High Q, Electronically Switched Filter** - A multi bandwidth filter with high adjacent channel attenuation switched electronically.
- 11) GMT** - Greenwich Mean Time.
- 12) LCD - Liquid-crystal display** - composed of two parallel glass plates with conductive coatings sandwiching a liquid-crystal compound between them. The compound becomes opaque and reflective when subjected to an electric field. LCD displays are used as information displays on many types of electronic equipment.
- 13) LSB** - Lower Side Band, the mirror image of the USB containing all of the modulation information of amplitude modulation in one half the bandwidth. The lower half, excluding the carrier, of an AM signal.
- 14) Notch** - A response producing attenuation of signals over a narrow range of frequencies.
- 15) Passband Offset** - A frequency conversion technique which skews the desired channel off center of the detection filters allowing low or high frequency components to be selectively attenuated.
- 16) Passive Double Balanced Mixer** - A frequency conversion device requiring a locally generated oscillator (LO) to operate. An incoming RF signal is shifted relative to the LO producing an intermediate or IF frequency.
- 17) RF** - Radio frequency
- 18) RS232** - Electronics Industries Association standard physical-level interface between DTE (terminal) and DCE (modem).
- 19) RTTY** - Radio Teletype communications.
- 20) Squelch** - A user controlled adjustment which mutes the audio output below a certain signal strength.
- 21) Synchronous Detector** - An amplitude modulation detector which utilizes a replica of the original transmitted carrier signal to improve the reception of weak signals.
- 22) Synthesized** - Capable of generating a large number of different output frequencies, all related to a single, highly stable reference source.
- 23) Up Conversion** - A frequency conversion technique that translates an incoming RF signal to a higher frequency.
- 24) USB** - Upper side band, the mirror image of the LSB containing all of the modulation information of amplitude modulation in one half the band width. The upper half, excluding the carrier, of an AM signal.
- 25) UTC** - Universal Time Coordinated.
- 26) VFO** - Variable frequency oscillator
- 27) VHF** - Very High Frequency band extends from approximately 30MHz to 300 MHz.

SUGGESTED REFERENCES**1) *Passport to World Band Radio***

Published by:
International Broadcasting Services, Ltd.
P. O. Box 300
Penn's Park, Pennsylvania 18943

2) *World Radio TV Handbook*

Volume 37
Published by:
Billboard Publications Inc.
1515 Broadway
New York, NY 10036

3) *The ARRL Antenna Book*























Published by:
The American Radio Relay League
Newington, CT USA 06111
Copyright © 1988 by The American Radio Relay League
Library of Congress Catalog Card Number: 55-8966

4) *The ARRL Handbook*

Published by:
The American Radio Relay League
Newington, CT USA 06111
Copyright © 1989 by The American Radio Relay League
Library of Congress Catalog Card Number: 41-3345

5) *Radio Interference - How to Find it and Cure it*

Published by:
The American Radio Relay League
Newington, CT 06111
U. S. A.

- Select VFO (page 16) Press **VFO** function button until desired VFO is enclosed in box.
- Adjust Frequency (page 16) Select **VFO** function button. Use numeric keypad, , or , or tuning wheel.
- Preamp or Attenuator (page 17) Press **PRE ATTN** function button until **(PRE)** or **(ATTN)** is enclosed in box.
- Select AGC (page 12) Press **AGC** function button until desired AGC action is enclosed in box.
- Activate Noise Blanker (page 12, 18) Press **NB** function button until desired noise blanker mode is displayed.
- Select Bandwidth (page 9) Press **BANDWIDTH** buttons to select appropriate filter.
- Select Mode (page 9) Press **MODE** buttons to select appropriate mode.
- Select Synchro (page 9) Press **AM/SYNC** button to activate or deactivate the Synchronous detector.
- Set TIMER On/Off times (page 25, 26, 27) Press and hold **TIMER** function button until **ON** annunciator turns on and flashes. Use keypad to enter On time for Timer 1. Press **TIMER** function button again. Use keypad to enter Off time for Timer 1. Press **TIMER** function button again. Use keypad to enter ON time for Timer 2. Press **TIMER** function button again. Use keypad to enter Off time for Timer 2. Press **TIMER** function button again to exit set mode.
- Press **TIMER** function button, enter **1** and/or **2**.
- Activate TIMER (page 26) Press **CLK/FREQ** function button to display time or frequency read-out.
- Select CLOCK/FREQUENCY Display (page 9, 12)
-
- Most front panel pushbuttons perform two functions. The second function requires that the  button be pressed first, and then the desired 2nd function button pressed within 3 seconds. The symbol  indicates that button is to be pressed within 3 seconds.
- Set VFO A=VFO B (page 11) Press   press **VFO** function button until display shows **VFO A = B**.
- Select Antenna (page 11, 15) Press  , **ANT** function button until desired antenna is enclosed in box. Note: **VHF** is only accessible if the optional VHF converter module is installed.
- Activate NAME (page 12, 21) Press   press **NAME** function button until display shows **NAME**.
- Activate Notch (page 11) Press   press **NOTCH** function button, use **NOTCH** control to adjust for desired results.
- Adjust Step Size (page 9, 12, 16) Press   press **STEP** function button. Frequency display will adjust accordingly.
- Lock Controls (page 12, 17) Press   press **LOCK** function button. Must be in VFO mode. Pushbuttons are inactive.
- Set Time (page 25) Press   press  (hold until colon flashes). Use keypad to enter either **L** (local) or **U** (alternate) time in **HH:MM:SS** format. Press  to start clock.
- Display Time (page 25) Press   press  (press  again within 3 seconds to display alternate time). Press **CLK/FREQ** function button to display current selected time.

Dim Lamp (10,29)

Press 3 → press Press until dial lighting is at desired level.

Disable Beep (10)

Press 3 → press to enable or disable beep.

MEMORY FUNCTIONS

Program Memory Channel (page 21)

Select VFO & mode, adjust frequency & bandwidth.
 Press (MEM will flash), 3 → use keypad to enter 3 digit memory channel number. Use the Tuning Wheel to enter character at each location for NAME. Press to advance cursor and press to backspace. Press to exit.

Recall Memory Channel (page 21)

Press use keypad to enter channel number, or use or the tuning wheel.

Recall Memory Tune Channel (page 21)

Press (hold until MEM TUNE is displayed). Use keypad or . Use tuning wheel to change frequency.

Move Memory to VFO (page 21)

Press . Will move memory contents to last used VFO.

Lock Memory Channel (page 21)

Select memory channel to be locked, 3 → press **LOCK**.

Delete Memory Channel (page 21)

Select memory channel to be deleted. Press 3 → press (hold until 2nd beep).

SCAN MODES

All SCAN modes require selecting one of three SCAN METHODS. Select desired SCAN MODE and then select 'SEEK', 'TIME' or 'CARRIER'.

Scan Memory (page 22)

Press 3 → press then select method,
 Press 3 → press or press 3 → press or
 Press 3 → press . Press .

Scan List (page 23)

Press 3 → press then select method,
 Press 3 → press or press 3 → press or
 Press 3 → press . Press .

Scan Multiple Lists (page 23)

Press 3 → press , Enter number, to enter additional
 number, to review list. Select method. Press .

Scan A - B (page 24)

Press 3 → press or press 3 → press or
 Press 3 → press or press .

Press 3 → press , Enter one endpoint frequency.
 Press or , Enter second endpoint frequency.
 Press .

Other Controls Used in Scan Mode.

Passband Offset

Adjust for optimum reception.

Squelch/RF

Set squelch counterclockwise. Adjust RF (gain) counterclockwise until S-meter indicates desired signal level to trip squelch. Advance the Squelch control clockwise until the audio just quiets. Advance the RF (gain) fully clockwise.

TROUBLESHOOTING

<i>Symptom</i>	<i>Probable Cause</i>	<i>Corrective Action</i>
No front panel display or lights when power is depressed	A) Power connection B) Blown supply fuse	A) Check power supply cables B) Check fuse C) Contact service
Scrambled front panel display when power is depressed	A) Microprocessor malfunction	A) Unplug from power source and re-connect to reset microprocessor
No signals heard when antenna is connected or sensitivity low	A) Squelch enabled B) Incorrect antenna input selected C) RF ATTN enabled D) RF gain improperly set	A) Turn squelch counterclockwise B) Select correct antenna input C) Turn off RF ATTN D) Turn RF gain clockwise
S meter indication, but remains constant	A) RF gain improperly set	A) Turn RF gain clockwise
S meter indication, but no sound heard	A) Improper mode selected B) External speaker selected C) Squelch enabled	A) Check mode selection B) Check external speaker switch on rear panel
SSB signals have excessively high or low frequency response	A) PASSBAND OFFSET improperly set	A) Center PASSBAND OFFSET control
No front panel operation i.e. tuning, frequency entry, etc.	A) Lock enabled	A) Press <input type="checkbox"/> F "LOCK" to unlock front panel
Timer does not operate	A) Timer not properly set B) Alternate clock selected	A) Program timer ON/OFF times
Direct frequency entry will not work	A) Alternate button functions enabled i.e.) <input type="checkbox"/> F is displayed	A) Press <input type="checkbox"/> F for confirmation beep and <input type="checkbox"/> F annunciator not displayed

R8A Special Display Messages

"PWRLOS^L" or "PWRLOS^U" (power lost) indicates that power has been disrupted to the receiver and the clocks have lost their time settings. There is no problem with the receiver, and it may be operated as normal. To extinguish this message, simply reset the clocks.

"PWRFAIL" (Power Fail) indicates that the power supplied to the receiver does not meet the specified requirements. This could be caused by an improperly selected AC line voltage, low AC line voltage (brown out), or low DC voltage. Normal operations of the receiver are halted in the "PWRFAIL" mode. To return to normal operation, disconnect the receiver from the power source. Make sure the proper AC Voltage range is selected from the rear panel switch, then reconnect the power.

Continued "PWRFAIL" messages under a known good

power source could indicate receiver power supply problems. Should this occur, contact the Service Department.

"UNLOCKD" (unlocked) indicates that the synthesizer of the phased locked loop circuit is not locking to the proper frequency. If this should occur with the receiver, contact the Service Department with details on what operations are affected.

SERVICE INFORMATION

You may contact the R. L. DRAKE Service Department for additional information or assistance by calling (513) 746-6990, Monday through Friday, 8:00 A.M. - 5:00 P.M. EST, except on holidays.

You may also contact the R. L. DRAKE Service Department by E-mail at the following address:
bill_frost@rldrake.com

or by Telefax:
+1 (513) 743-4576.

Should you want to return your unit for service, package the receiver carefully using the original carton or other suitable container. Write your return address clearly on the shipping carton and on an enclosed cover letter describing the service required, symptoms or problems. Also include your daytime telephone number and a copy of your proof of purchase.

The receiver will be serviced under the terms of the R. L. Drake Company Limited Warranty and returned to you.

ONE YEAR LIMITED WARRANTY

R. L. DRAKE COMPANY warrants to the original purchaser this product shall be free from defects in material or workmanship for one year from the date of original purchase.

During the warranty period the R. L. DRAKE COMPANY or an authorized Drake service facility will provide, free of charge, both parts and labor necessary to correct defects in material and workmanship. At its option, R. L. Drake Company may replace a defective unit.

To obtain such warranty service, the original purchaser must:

(1) Complete and send in the Warranty Registration Card within ten (10) days of purchase.

(2) Notify the R. L. DRAKE COMPANY or the nearest authorized service facility, as soon as possible after discovery of a possible defect, of:

(a) the model and serial number.

(b) the identity of the seller and the approximate date of purchase.

(c) a detailed description of the problem, including details on the electrical connection to associated equipment and the list of such equipment.

(3) Deliver the product to the R. L. DRAKE COMPANY or the nearest authorized service facility, or ship the same in its original container or equivalent, fully insured and shipping charges prepaid.

Correct maintenance, repair, and use are important to obtain proper performance from this product. Therefore carefully read the Instruction Manual. This warranty does not apply to any defect that R. L. DRAKE COMPANY determines is due to:

(1) Improper maintenance or repair, including the installation of parts or accessories that do not conform to the quality and specification of the original parts.

(2) Misuse, abuse, neglect or improper installation.

(3) Accidental or intentional damage.

All implied warranties, if any, including warranties of merchantability and fitness for a particular purpose, terminate one (1) year from the date of the original purchase.

The foregoing constitutes R. L. DRAKE COMPANY'S entire obligation with respect to this product, and the original purchaser shall have no other remedy and no claim for incidental or consequential damages, losses or expenses. Some states do not allow limitations on how long an implied warranty lasts or do not allow the exclusions or limitation of incidental or consequential damages, so the above limitation and exclusion may not apply to you.

This warranty gives you specific legal rights and you may also have other rights which vary from state to state.

This warranty shall be construed under the laws of Ohio.



R. L. Drake Company
230 Industrial Drive
Franklin, Ohio 45005 U.S.A.
Customer Service and Parts Telephone:
+1 (513) 746-6990
Telefax:
+1 (513) 743-4576
World Wide Web Site:
<http://www.rldrake.com>