

HEATHKIT® ASSEMBLY MANUAL



RF SIGNAL GENERATOR
MODEL RF-1

RESISTOR AND CAPACITOR COLOR CODES

RESISTORS

The colored bands around the body of a color coded resistor represent its value in ohms. These colored bands are grouped toward one end of the resistor body. Starting with this end of the resistor, the first band represents the first digit of the resistance value; the second band represents the second digit; the third band represents the number by which the first two digits are multiplied. A fourth band of gold or silver represents a tolerance of $\pm 5\%$ or $\pm 10\%$ respectively. The absence of a fourth band indicates a tolerance of $\pm 20\%$.

The physical size of a composition resistor is related to its wattage rating. Size increases progressively as the wattage rating is increased. The diameters of 1/2 watt, 1 watt and 2 watt resistors are approximately 1/8", 1/4" and 5/16", respectively.

The color code chart and examples which follow provide the information required to identify color coded resistors.

COLOR	CODE		MULTIPLIER
	1ST DIGIT	2ND DIGIT	
BLACK	0	0	1
BROWN	1	1	10
RED	2	2	100
ORANGE	3	3	1,000
YELLOW	4	4	10,000
GREEN	5	5	100,000
BLUE	6	6	1,000,000
VIOLET	7	7	10,000,000
GRAY	8	8	100,000,000
WHITE	9	9	1,000,000,000
GOLD	-	-	.1
SILVER	-	-	.01

EXAMPLES

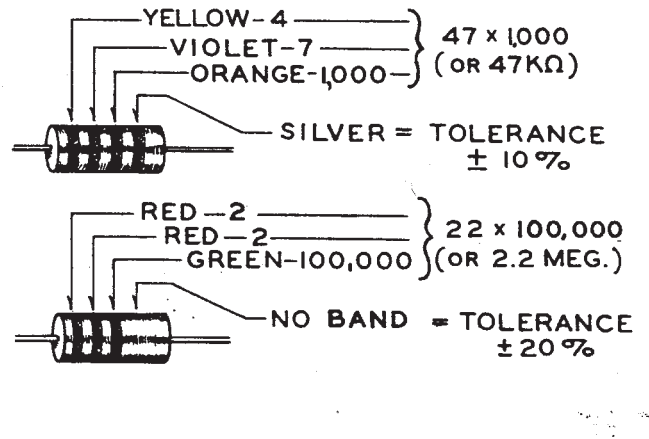

CAPACITORS

Generally, only mica and tubular ceramic capacitors, used in modern equipment, are color coded. The color codes differ somewhat among capacitor manufacturers, however the codes

shown below apply to practically all of the mica and tubular ceramic capacitors that are in common use. These codes comply with EIA (Electronics Industries Association) Standards.

MICA

COLOR	CODE		MULTIPLIER	TOLER. %
	1ST DIGIT	2ND DIGIT		
BLACK	0	0	1	± 20
BROWN	1	1	10	± 10
RED	2	2	100	± 5
ORANGE	3	3	1,000	± 3
YELLOW	4	4	10,000	± 5
GREEN	5	5	—	—
BLUE	6	6	—	—
VIOLET	7	7	—	—
GRAY	8	8	—	—
WHITE	9	9	—	—
GOLD	-	-	.1	± 10
SILVER	-	-	.01	± 10

EXAMPLE

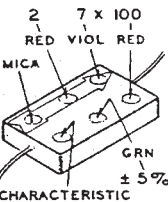

2,700 μf $\pm 5\%$
 OR .0027 μfd

OBSERVE DIRECTION OF ARROW

WHT. OR BLK. DOT INDICATES MICA

CHARACTERISTIC—SEE NOTE 1 BELOW

(VALUE IN μf —SEE NOTE 3 BELOW)

TUBULAR CERAMIC

Place the group of rings or dots to the left and read from left to right.

COLOR	CODE		MULTIPLIER	TOLER. %
	1ST DIGIT	2ND DIGIT		
BLACK	0	0	1	± 20
BROWN	1	1	10	± 0.1
RED	2	2	100	± 2
ORANGE	3	3	1,000	± 2.5
YELLOW	4	4	10,000	—
GREEN	5	5	—	± 0.5
BLUE	6	6	—	± 5
VIOLET	7	7	—	—
GRAY	8	8	—	± 0.25
WHITE	9	9	—	± 1.0

EXAMPLE

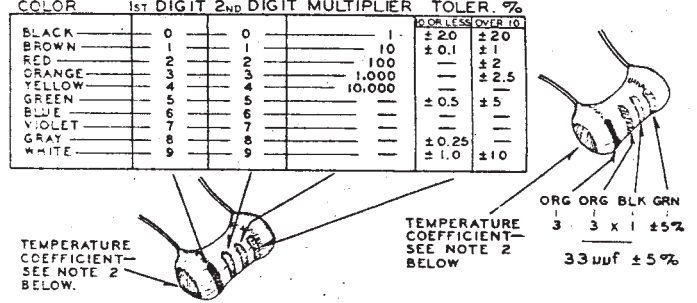

TEMPERATURE COEFFICIENT—SEE NOTE 2 BELOW.

TEMPERATURE COEFFICIENT—SEE NOTE 2 BELOW

(VALUE IN μf —SEE NOTE 3 BELOW)

33 μf $\pm 5\%$

NOTES:

1. The characteristic of a mica capacitor is the temperature coefficient, drift capacitance and insulation resistance. This information is not usually needed to identify a capacitor but, if desired, it can be obtained by referring to EIA Standard, RS-153 (a Standard of Electronic Industries Association.)

2. The temperature coefficient of a capacitor is the predictable change in capacitance with temperature change and is

expressed in parts per million per degree centigrade. Refer to EIA Standard, RS-198 (a Standard of Electronic Industries Association.)

3. The farad is the basic unit of capacitance, however capacitor values are generally expressed in terms of μf (microfarad, .000001 farad) and $\mu\mu\text{f}$ (micro-micro-farad, .000001 μf); therefore, 1,000 $\mu\mu\text{f}$ = .001 μf , 1,000,000 $\mu\mu\text{f}$ = 1 μf .

USING A PLASTIC NUT STARTER

A plastic nut starter offers a convenient method of starting the most used sizes: 3/16" and 1/4" (3-48 and 6-32). When the correct end is pushed down over a nut, the pliable tool conforms to the shape of the nut and the nut is gently held while it is being picked up and started on the screw. The tool should only be used to start the nut.

6-32

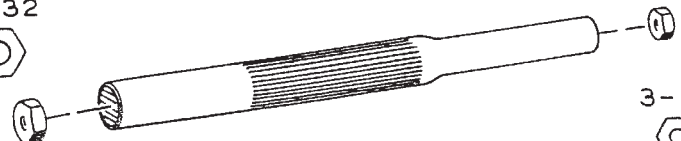

3-48



ASSEMBLY AND OPERATION OF THE HEATHKIT RF SIGNAL GENERATOR MODEL RF-1



SPECIFICATIONS

Frequency Range:

Band A:.....	100 kc to 320 kc.
Band B:.....	310 kc to 1100 kc.
Band C:.....	1 mc to 3.2 mc.
Band D:.....	3.1 mc to 11 mc.
Band E:.....	10 mc to 32 mc.
Band F:.....	32 mc to 110 mc.
Calibrated Harmonics:.....	100 mc to 220 mc.

Accuracy:..... 2%.

Output:

Impedance:.....	50 Ω .
Voltage:.....	In excess of 100,000 μ v.

Modulation:

Internal:.....	400 cycle, approximately 30% depth.
External:.....	Approximately 3 volts across 50 K Ω for 30%.

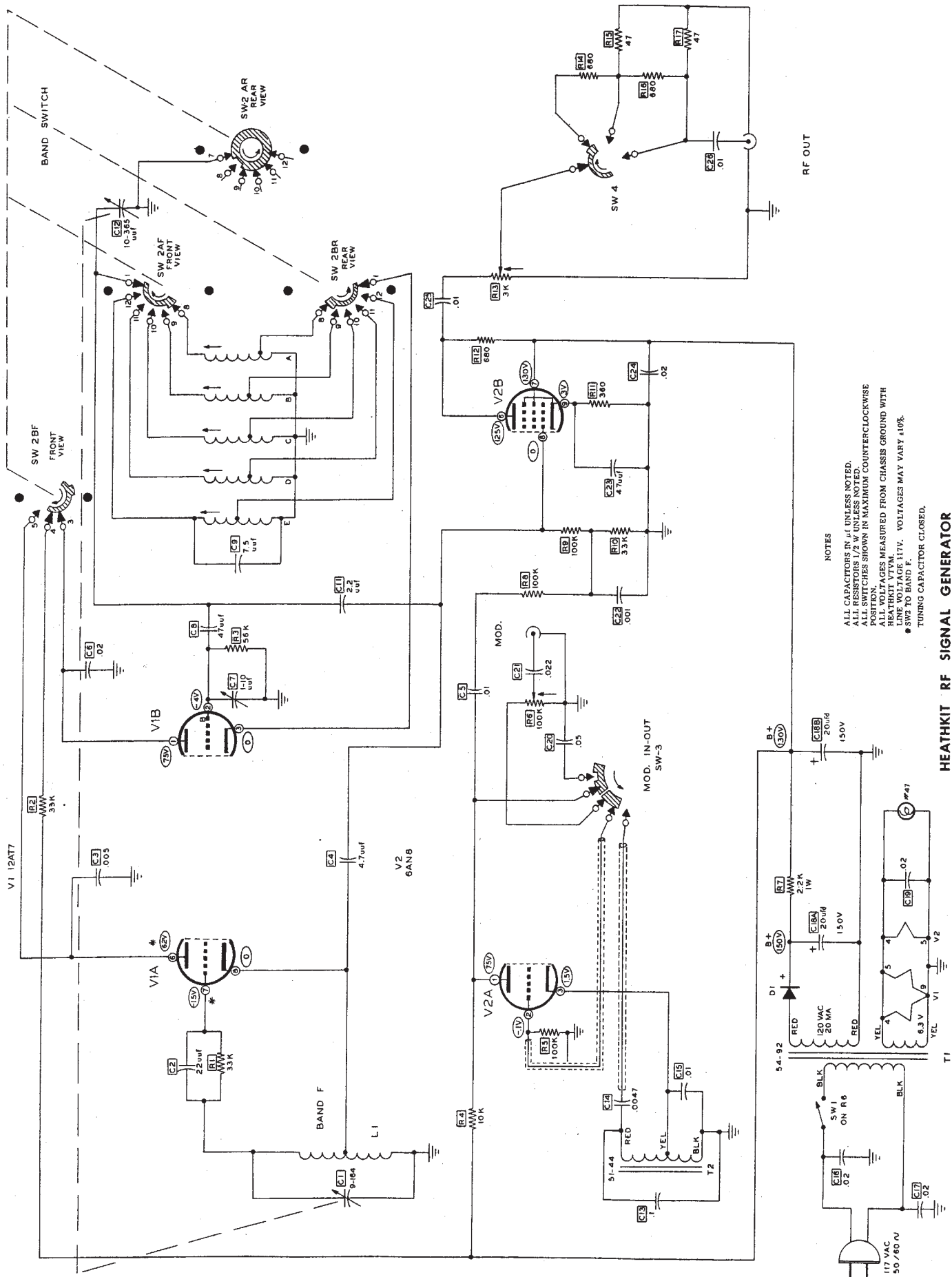

NOTES
 ALL CAPACITORS IN μ F UNLESS NOTED.
 ALL RESISTORS $1/2$ W UNLESS NOTED.
 ALL SWITCHES SHOWN IN MAXIMUM COUNTERCLOCKWISE POSITION.
 ALL VOLTAGES MEASURED FROM CHASSIS GROUND WITH LINE VOLTAGE 117V. VOLTAGES MAY VARY $\pm 10\%$.
 * SW2 TO BAND F.
 TUNING CAPACITOR CLOSED.

HEATHKIT RF SIGNAL GENERATOR

MODEL RF-1

400 Cycle Audio Output:..... Approximately 10 volts open circuit.

Tube Complement:..... V1 - 12AT7 - RF oscillator.
V2 - 6AN8 - modulator and RF output.

Power Requirements:..... 105-125 volts 50/60 cycle AC 15 watts.

Aluminum Cabinet Dimensions:..... 6 1/2" wide x 9 1/2" high x 5" deep.

Net Weight:..... 4 1/2 lbs.

Shipping Weight:..... 7 lbs.

INTRODUCTION

The Heathkit RF (radio frequency) Signal Generator Model RF-1 has been designed to provide the service technician, ham and experimenter, with an accurate and stable source of RF signals. A preassembled band switch and coil assembly, aligned to factory precision standards, eliminates the necessity of having costly equipment to calibrate the finished kit. To insure that the maximum performance that is available in this kit be realized, it is suggested that the builder take a few minutes now to read the CIRCUIT DESCRIPTION and CONSTRUCTION NOTES.

CIRCUIT DESCRIPTION

The RF oscillator for Bands A, B, C, D and E consists of one-half of a 12AT7 tube (V1B), the tuning capacitor C12 and the five adjustable Hartley oscillator coils. These coils are supplied as a pre-aligned band switch assembly (SW2). The cathode of the tube is connected to the tap of the coils through switch SW2-BR. Because one end of each coil is grounded, the current from the cathode will excite the coil at resonance. The feedback necessary to maintain oscillation is coupled from the "hot" end of the coil through switch SW2-AF and then through capacitor C8 to the tube grid. Switch SW2-AR shorts out the unused coils to prevent any undesirable suckouts.

The coil for Band F is mounted directly on the tuning capacitor and is permanently connected to the other half of the 12AT7 oscillator tube (V1A). This arrangement eliminates the stray capacities that would be involved in switching and thus provides a more desirable LC ratio. Band switching is accomplished by switching the B+ to Band F through switch SW2-BF.

The triode of a 6AN8 (V2A) is used for the 400 cycle oscillator. A Hartley Oscillator is also used in this circuit but, of course, the coil or reactor is of the iron core type because of the frequency involved. The modulation in-out switch SW3 connects either the plate or the grid through control R6 to the modulation jack. This arrangement enables the 400 cycle output to be amplitude controlled, and also controls the level of external modulation applied to the grid of V2A.

RF signals are coupled to the grid of the 6AN8 output tube (V2B) through capacitors C4 and C11. Modulation is coupled to the grid through capacitor C5, resistors R8 and R9. These components, along with resistor R10, establish the modulation level. The modulated RF signal is then coupled from the plate of V2B through capacitor C25, fine attenuator R13 and the step attenuator switch SW4 to the RF output jack.

The power for the RF-1 is supplied through transformer T1. A conservatively rated silicon diode (D1) is used in a half-wave rectifier circuit to supply the B+ for the generator.

CONSTRUCTION NOTES

This manual is supplied to assist you in every way to complete your kit with the least possible chance for error. While the arrangement shown is probably not the only satisfactory arrangement, nevertheless it is the result of extensive experimentation and trial. If followed carefully, it will result in a stable instrument, operating at a high degree of accuracy and dependability. We suggest that you retain the manual in your files for future reference, both in the use of the instrument and for its maintenance.

UNPACK THE KIT CAREFULLY AND CHECK EACH PART AGAINST THE PARTS LIST. In so doing, you will become acquainted with the parts. Refer to the charts and other information on the inside covers of your manual to help you identify the components. If some shortage or parts damage is found in checking the Parts List, please read the REPLACEMENT section and supply the information called for therein, and include all inspection slips in your letter to us.

CAUTION: The tuning capacitor supplied with this kit has been specially calibrated. Care must be taken that the plates are not bent or damaged in any way. Always keep the plates fully meshed while constructing the kit.

Resistors generally have a tolerance rating of 10% unless otherwise stated in the Parts List. Tolerances on capacitors are generally even greater. Limits of +100% and -20% are common for electrolytic capacitors.

PROPER SOLDERING TECHNIQUES

Only a small percentage of Heathkit purchasers find it necessary to return an instrument for factory service. Of these instruments, by far the largest proportion of malfunctions are due to poor or improper soldering.

If terminals are bright and clean and free of wax, frayed insulation and other foreign substances, no difficulty will be experienced in soldering. Correctly soldered connections are essential if the performance engineered into a kit is to be fully realized. If you are a beginner with no experience in soldering, a half hour's practice with some odd lengths of wire may be a worthwhile investment.

For most wiring, a 30 to 100 watt iron or its equivalent in a soldering gun is very satisfactory. A lower wattage iron than this may not heat the connection enough to flow the solder smoothly over the joint. Keep the iron tip clean and bright by wiping it from time to time with a cloth.

CHASSIS WIRING AND SOLDERING

1. Unless otherwise indicated, all wire used is the type with the colored insulation (hookup wire); the size of the conductor is the same for all colors of hookup wires furnished with your kit. In the case that bare wire is to be covered with insulating sleeving, the phrase "use sleeving" will be used.

2. Leads on resistors, capacitors and transformers are generally much longer than they need to be to make the indicated connections. In these cases, the excess leads should be cut off before the part is added to the chassis. In general, the leads should be just long enough to reach their terminating points. Wherever there is a possibility of bare leads shorting to other parts or to the chassis, the leads should be covered with insulating sleeving.
3. Crimp or bend the lead (or leads) around the terminal to form a good joint without relying on solder for physical strength. If the wire is too large to allow bending, position the wire so that a good solder connection can still be made.
4. Position the work, if possible, so that gravity will help to keep the solder where you want it.
5. Place a flat side of the soldering iron tip against the joint to be soldered until it is heated sufficiently to melt the solder.
6. Then place the solder against the heated terminal and it will immediately flow over the joint; use only enough solder to thoroughly wet the junction. It is usually not necessary to fill the entire hole in the terminal with solder.
7. Remove the solder and then the iron from the completed junction. Use care not to move the leads until the solder is solidified.

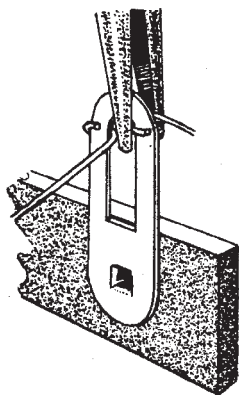

CRIMP WIRES

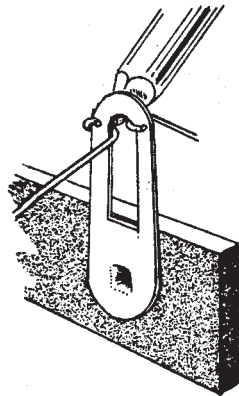

HEAT CONNECTION

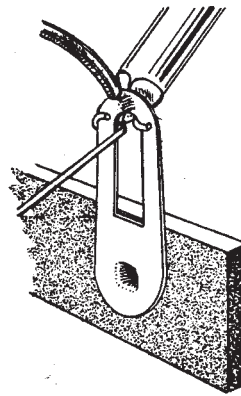

APPLY SOLDER

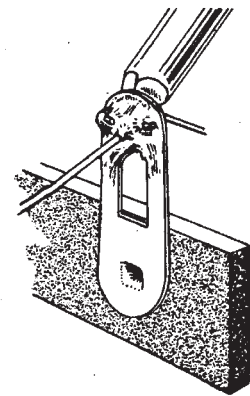

ALLOW SOLDER TO FLOW

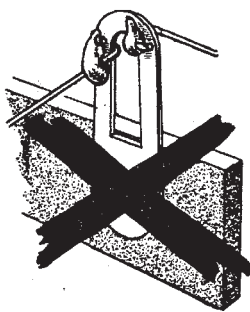

COLD SOLDER JOINT CONNECTION INSUFFICIENTLY HEATED

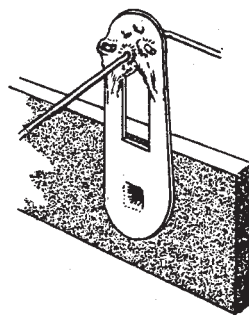

PROPER SOLDER CONNECTION

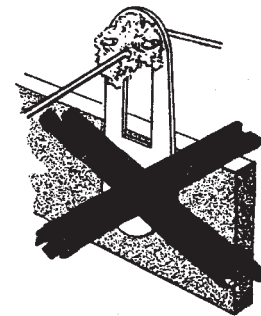

COLD SOLDER JOINT CONNECTION MOVED WHILE COOLING

A poor or cold solder joint will usually look crystalline and have a grainy texture, or the solder will stand up in a blob and will not have adhered to the joint. Such joints should be reheated until the solder flows smoothly over the entire junction. In some cases, it may be necessary to add a little more solder to achieve a smooth, bright appearance.

NOTE: ALL GUARANTEES ARE VOIDED AND WE WILL NOT REPAIR OR SERVICE INSTRUMENTS IN WHICH ACID CORE SOLDER OR PASTE FLUXES HAVE BEEN USED. WHEN IN DOUBT ABOUT SOLDER, IT IS RECOMMENDED THAT A NEW ROLL PLAINLY MARKED "ROSIN CORE RADIO SOLDER" BE PURCHASED.

We suggest that you do the following before work is started:

1. Attach the large folded pictorials to the wall above your work bench.
2. Read several steps ahead of the actual step being performed. This will familiarize you with the relationship of the subsequent operations.
3. Lay out all parts so that they are readily available.
4. Provide yourself with good quality tools. Basic tool requirements consist of a screwdriver with a 1/4" blade; a small screwdriver with a 1/8" blade; long-nose pliers; wire cutters, preferably separate diagonal cutters; a pen knife or a tool for stripping insulation from wires; a soldering iron (or gun) and rosin core solder. A set of nut drivers and a nut starter, while not necessary, will aid extensively in construction of the kit.

Most kit builders find it helpful to separate the various parts into convenient categories. Muffin tins or molded egg cartons make convenient trays for small parts. Resistors and capacitors may be placed with their lead ends inserted in the edge of a piece of corrugated cardboard until they are needed. Values can be written on the cardboard next to each component. The illustration shows one method that may be used.

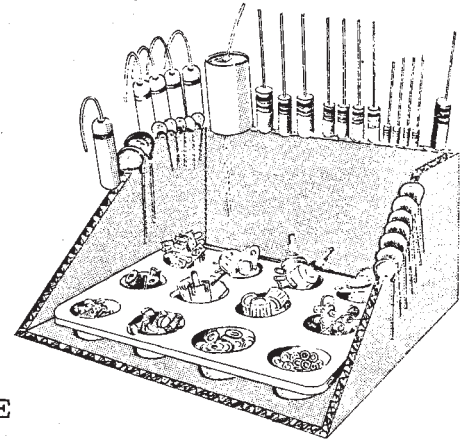

STEP-BY-STEP PROCEDURE

The following instructions are presented in a logical step-by-step sequence to enable you to complete your kit with the least possible confusion. Be sure to read each step all the way through before beginning. When the step is completed, check it off in the space provided. This is particularly important as it may prevent errors or omissions, especially if your work is interrupted. Some kit builders have also found it helpful to mark each lead in colored pencil on the pictorial as it is added.

The abbreviation "NS" indicates that a connection should not be soldered as yet for other wires may need to be added. When the last wire is installed, the terminal should be soldered and the abbreviation "S" is used to indicate this. Note that a number will appear after each solder instruction. This number indicates the number of leads that are supposed to be connected to the terminal in question before it is soldered. For example, if the instruction reads, "Connect one lead of a 47 K Ω resistor to lug 1 (S-2)," it will be understood that there will be two leads connected to the terminal at the time it is soldered. This additional check will help avoid errors.

NOTE: Because of the RF frequency involved in this instrument it is imperative that all mounting hardware be tightened securely. A loose ground lug, for example, could cause an intermittent frequency change that would be extremely difficult to locate.

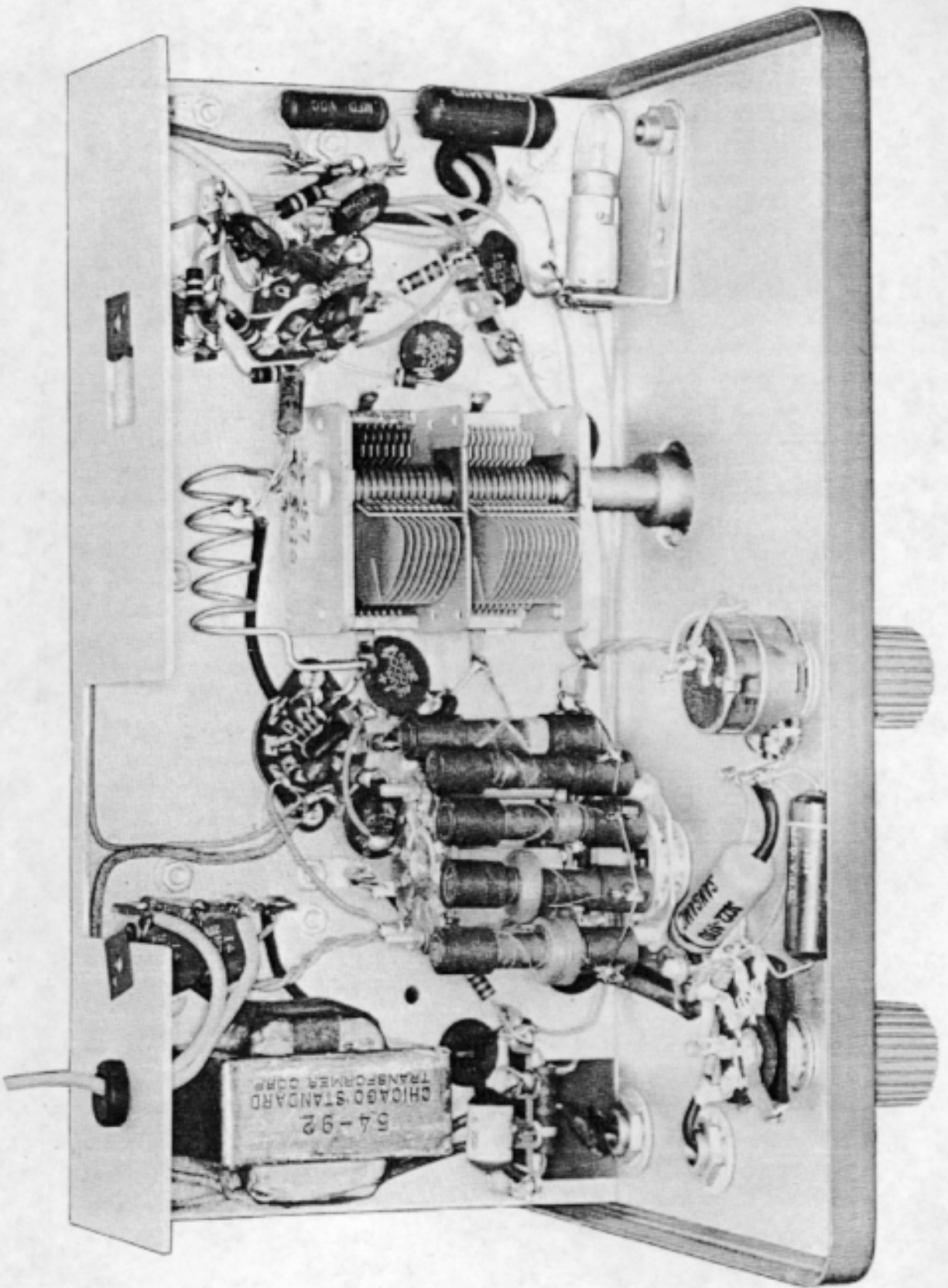

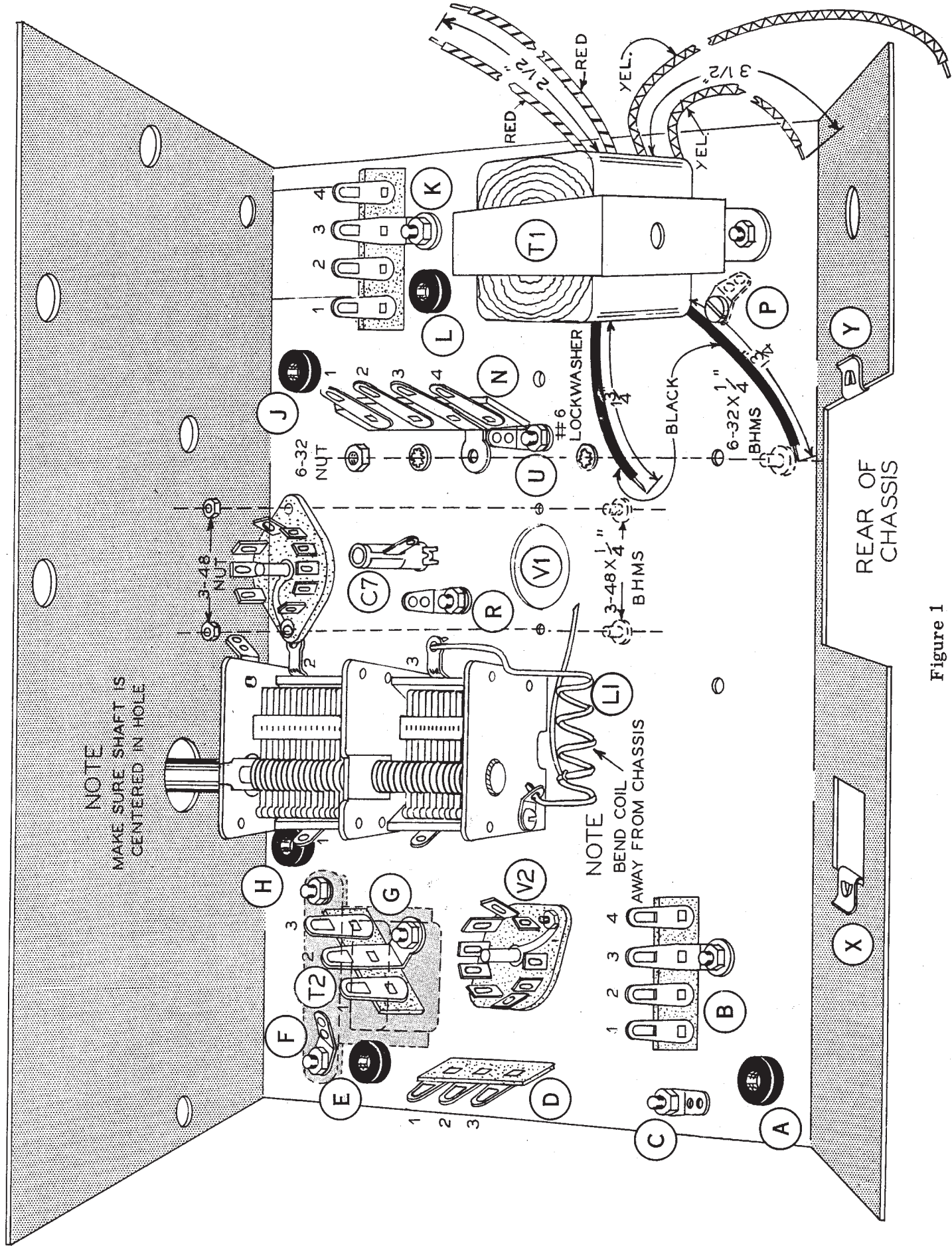
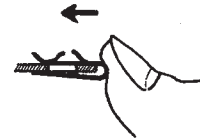

Figure 1

- () Orient the chassis as shown in Figure 1. Install the five rubber grommets A, E, H, J and L.
- () Mount the tube socket V1 as shown in Figures 1 and 2, using 3-48 hardware.
- () In like manner, mount tube socket V2.
- () Install the two speednuts X and Y. The flat side must be toward the outside of the chassis.
- () Mount the 4-lug terminal strip N. Use a 6-32 x 1/4" BHMS, a #6 lockwasher under the mounting foot and another #6 lockwasher under the 6-32 nut.
- () In a similar manner, mount the 4-lug terminal strip B.
- () Mount the 3-lug terminal strip D.
- () Mount the 3-lug terminal strip G.
- () Mount the 4-lug terminal strip K.
- () Using a 6-32 x 1/4" BHMS and nut, mount the ground lug C.
- () Mount transformer (#51-44) T2 on the opposite side of the chassis. At the same time, install ground lug F. Use 6-32 x 1/4" BHMS. The transformer leads should be toward the rear of the chassis. See Figure 9 on Page 18.
- () Install ground lugs R and U.
- () Install ground lug P on the opposite side of the chassis.
- () Push the trimmer capacitor C7 through its mounting hole until the spring snaps open on the opposite side of the chassis.
- () Cut one of the yellow leads of the power transformer (#54-92) to a length of 3 1/2", the two red leads to 2 1/2" and the two black leads to 1 3/4".
- () Strip approximately 1/4" of the insulation from the ends of the leads and tin. Mount the transformer, using 6-32 hardware.



Start SPEEDNUT over edge of metal.



Push into position with thumb, snapping extrusion on lower leg of SPEEDNUT into screw hole.

NOTE: Keep the plates of the tuning gang fully meshed during construction.

- () Prepare the tuning gang as shown in Figure 2 and mount the assembly on the chassis using three short 6-32 RHMS with lock washers under the heads.

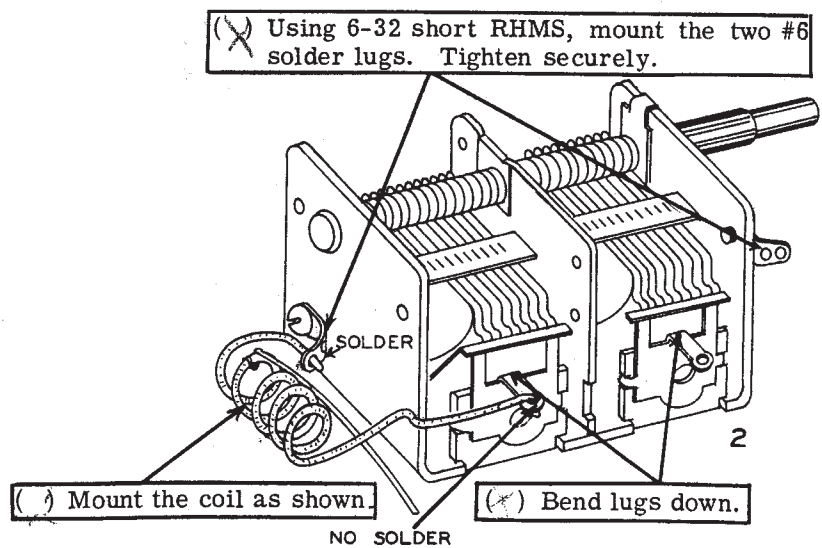

Figure 2

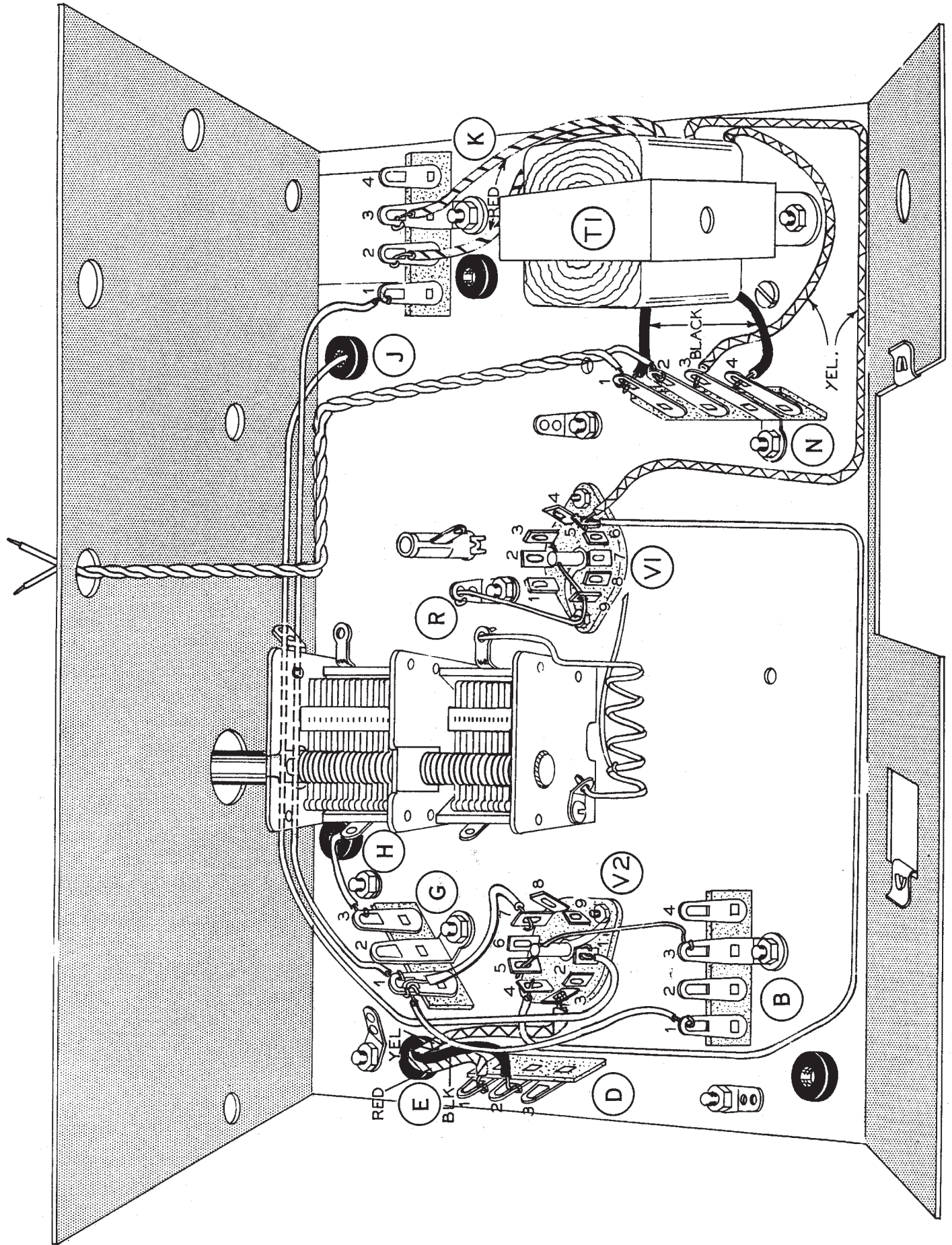

Figure 3

- () Refer to Figure 3 and feed the three wires from transformer T2 through Grommet E. Connect the yellow wire to pin 3 (NS) of tube socket V2.
- () Connect the black wire to lug 2 (NS) of terminal strip D.
- () Connect the red wire to lug 1 (NS) of terminal strip D.
- () Connect the long yellow wire from the power transformer T1 to pin 5 (NS) of tube socket V1. Dress wire as shown.
- () Connect the short yellow wire from T1 to lug 3 (NS) of terminal strip N.
- () Connect one of the black wires from T1 to lug 1 (NS) of terminal strip N.
- () Connect the remaining black wire to lug 4 (NS) of terminal strip N.
- () Connect one of the red wires from T1 to lug 2 (NS) of terminal strip K.
- () Connect the remaining red wire to lug 3 (S-1) of terminal strip K.

NOTE: The individual lengths of wire to be used in the following steps have been measured and the lengths are noted in each step. The wire should be cut to the specified length and approximately 1/4" of the insulation stripped from each end before it is used.

- () Connect one end of a 9 1/4" length of wire to pin 5 (NS) of socket V1. Connect the other end of the wire to pin 4 (NS) of socket V2. Dress wire as shown.
- () Feed one end of a 2" length of bare wire through the center ground lug (NS) of V2 and connect to pin 5 (S-1). Connect the other end of the wire to lug 3 (NS) of terminal strip B.
- () Connect a 12 1/2" wire to pin 1 (NS) of socket V2. Temporarily dress the wire through grommet J.
- () Connect one end of a 9 1/2" wire to lug 1 (NS) of terminal strip G. Connect the other end to lug 1 (NS) of terminal strip K.
- () Connect one end of a 3 1/2" length of wire to lug 1 (NS) of terminal strip B. Connect the other end to lug 1 (NS) of terminal strip G.
- () Connect one end of a 5" wire to lug 3 (NS) of terminal strip G. Feed the other end through grommet H.
- () Connect one end of a 2" length of wire to lug 1 (NS) of terminal strip G. Connect the other end to pin 7 (S-1) of socket V2.
- () Twist two 11" lengths of wire together to form a twisted pair. Connect the wires at one end of the pair to lugs 1 (S-2) and 2 (NS) respectively, of terminal strip N. Dress the other end of the pair toward the front of the chassis, as shown.
- () Feed a 2 1/2" length of bare wire through pin 9 of V1. Connect one end of the wire to ground lug R (NS) and the other end of the wire to the center ground lug of tube socket V1 (NS). Now solder pin 9.

- () Refer to Figure 4 and connect a 33 K Ω (orange-orange-orange) resistor between lug 3 (NS) and lug 4 (NS) of terminal strip B.
- () Connect a .001 μ fd disc ceramic capacitor between lug 3 (NS) and lug 4 (NS) of terminal strip B.
- () Connect a 100 K Ω (brown-black-yellow) resistor between lug 2 (NS) and lug 4 (NS) of terminal strip B.
- () Connect a 100 K Ω (brown-black-yellow) resistor between lug 4 (S-4) of terminal strip B and pin 8 (NS) of V2.
- () Connect a 390 Ω (orange-white-brown) resistor between lug 3 (S-4) of terminal strip B and pin 9 (NS) of socket V2.
- () Connect a .001 μ fd disc ceramic capacitor between pin 1 (NS) and the center ground (NS) of tube socket V2.
- () Connect a 10 K Ω (brown-black-orange) resistor between lug 1 (S-2) of terminal strip B and pin 1 (NS) of socket V2.
- () Connect a .01 μ fd disc capacitor between lug 2 (S-2) of terminal strip B and pin 1 (S-4) of V2.
- () Connect a 100 K Ω (brown-black-yellow) resistor between pin 2 (NS) of socket V2 and lug 2 (NS) of terminal strip D.
- () Connect a .01 μ fd capacitor between pin 3 (S-2) of V2 and lug 2 (S-3) of terminal strip D.
- () Connect a .0047 μ fd tubular capacitor between lug 1 (NS) and lug 3 (NS) of terminal strip D.
- () Connect one lead of a .1 μ fd tubular capacitor to lug 1 (S-3) of terminal strip D. Connect the other lead to ground lug F (NS).
- () Connect a .02 μ fd ceramic capacitor between lug 1 (NS) and lug 2 (S-1) of terminal strip G.
- () Connect a 680 Ω (blue-gray-brown) resistor between lug 1 (S-5) of terminal strip G and pin 6 (NS) of socket V2.
- () Connect a .01 ceramic capacitor between pin 6 (S-2) of V2 and lug 3 (S-2) of terminal strip G.
- () Connect a 47 μ fd ceramic capacitor between the center ground lug (S-3) and pin 9 (S-2) of socket V2.
- () Connect one lead of a 2.2 μ fd (red-red-white) small phenolic tubular capacitor to pin 8 (NS) of V2. Connect the other lead to lug 1 (S-1) of the tuning gang.

- () Connect one lead of a $4.7 \mu\mu\text{f}$ ceramic tubular capacitor to pin 8 (S-3) of V2. Connect the other lead to the tap on the high frequency coil L1 (S-1). Dress this capacitor close to the tuning gang.
- () Connect one lead of a $56 \text{ K}\Omega$ (green-blue-orange) resistor to ground lug R (NS). Connect the other lead to pin 2 (NS) of socket V1.
- () Connect a $.02 \mu\text{fd}$ ceramic capacitor between ground lug R (S-3) and pin 1 (NS) of socket V1.
- () Feed one lead of a $47 \mu\mu\text{f}$ mica capacitor through the lug of the trimmer capacitor C7, and connect to pin 2 (S-2) of V1. Now solder C7. Connect the other lead to lug 2 (NS) of the tuning gang.
- () Feed one lead of a $.02 \mu\text{fd}$ ceramic capacitor through pin 4 (S-1) of V1 and connect to pin 5 (S-3) of V1. Connect the other lead to ground lug U (S-1).
- () Connect a $.005 \mu\text{fd}$ ceramic capacitor between the center ground lug (S-2) and pin 6 (NS) of V1.
- () Using sleeving, connect the wire from the tap of coil L1 to pin 8 (S-1) of V1.
- () Prepare the $22 \mu\mu\text{f}$ mica capacitor and a $33 \text{ K}\Omega$ (orange-orange-orange) resistor as shown and connect one lead to pin 7 (S-1) of V1. Connect the other lead to lug 3 (S-2) of the tuning gang.

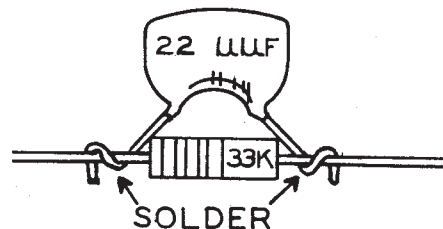

- () Connect a $.02 \mu\text{fd}$ ceramic capacitor between lug 2 (NS) and lug 3 (NS) of terminal strip N.
- () Connect another $.02 \mu\text{fd}$ capacitor between lugs 3 (S-3) and 4 (NS) of terminal strip N.
- () Connect a $2.2 \text{ K}\Omega$ (red-red-red) 1 watt resistor between lug 1 (NS) and lug 4 (NS) of terminal strip K.
- () Feed the two wires on the positive (+) end of the $20\text{-}20 \mu\text{fd}$ filter capacitor through grommet L from the tube side of the chassis. Connect the negative (-) lead of the capacitor to ground lug P (S-1). Connect one of the positive (+) leads to lug 1 (NS) and the other lead to lug 4 (NS) of terminal strip K. Use sleeving on both leads.
- () Connect the positive (+), or red, lead of the silicon rectifier to lug 4 (S-3) of terminal strip K. Connect the negative (-), or black, lead to lug 2 (S-2).
- () Connect one lead of a $33 \text{ K}\Omega$ (orange-orange-orange) resistor to lug 1 (S-4) of terminal strip K, leaving about 1" of lead between resistor body and lug 1. Dress the resistor toward V1. The other lead of the resistor will be connected later.

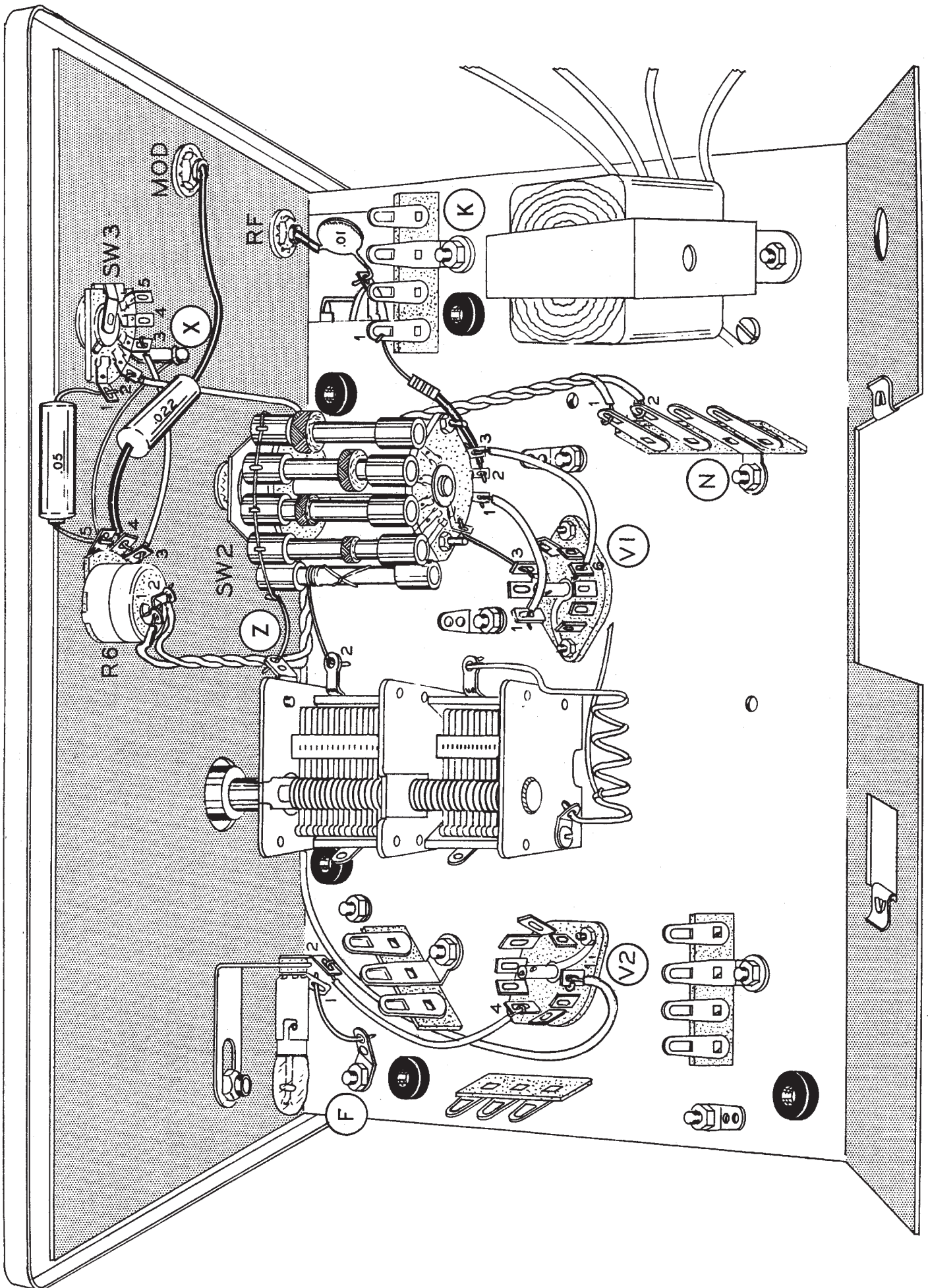

Figure 5

MOUNTING THE FRONT PANEL

Make sure that the chassis and panel are properly aligned before tightening any mounting hardware securely.

- () Refer to Figure 5 and mount the front panel to the chassis with the modulation control R6 (#19-11). Use a control lockwasher between the control and the chassis. Use a flat control washer under the nut.
- () Mount the modulation switch SW3 (#63-211). Use a control solder lug, positioned as shown, and a flat control washer.
- () Mount the pilot light socket, using the pilot light jewel and nut, as shown.
- () Mount the RF and modulation jacks. Discard the solder lugs and use a lockwasher between the chassis and nut.
- () Connect the twisted pair of wires from terminal strip N to lugs 1 (S-1) and 2 (S-1), respectively, of control R6. Either wire to either lug.
- () Connect a 3" length of bare wire between lug 5 (NS) of control R6 and solder lug X (NS).
- () Connect a 2 1/2" length of hookup wire between lug 3 (S-1) of R6 and lug 3 (S-1) of the modulation switch SW3.
- () Connect the previously installed wire from pin 1 of V2 to lug 2 (S-1) of SW3. This wire was temporarily inserted through grommet J.
- () Connect a .05 μ fd tubular capacitor between lug 5 (S-2) of R6 and lug 1 (S-1) of SW3.
- () Connect a .022 μ fd tubular capacitor between lug 4 (S-1) of R6 and the modulation jack. Use sleeving on both leads. The sleeving must cover the lead on the inside of the jack. Use enough solder on the jack to insure good contact with the connector.
- () Connect a short length of bare wire from solder lug F (S-2) to lug 1 (S-1) of the pilot light socket.
- () Connect a 2 1/2" wire between pin 4 (S-2) of socket V2 and lug 2 (S-1) of the pilot light socket.
- () Install the #47 pilot light.
- () Install the band switch SW2. Use a control lockwasher, flat washer and nut. Orient switch as shown so that knob pointer will indicate properly.
- () Connect the ground wire from the coils to ground lug Z (S-1) on the tuning gang. The ground wire is the short wire connected to the coil lug nearest the tuning capacitor.
- () Connect the wire from the front wafer of SW2 to lug 2 (S-2) of the tuning gang.
- () Connect the wire from the rear wafer of SW2 to pin 3 (S-1) of V1.
- () Connect the 33 K Ω (orange-orange-orange) resistor which was previously connected to terminal strip K to lug 2 (S-1) of SW2. Use sleeving.
- () Connect a 1 3/4" length of wire between pin 1 (S-2) of V1 and lug 1 (S-1) of SW2.
- () Connect a 2 1/4" wire between pin 6 (S-2) of V1 and lug 3 (S-1) of SW2.

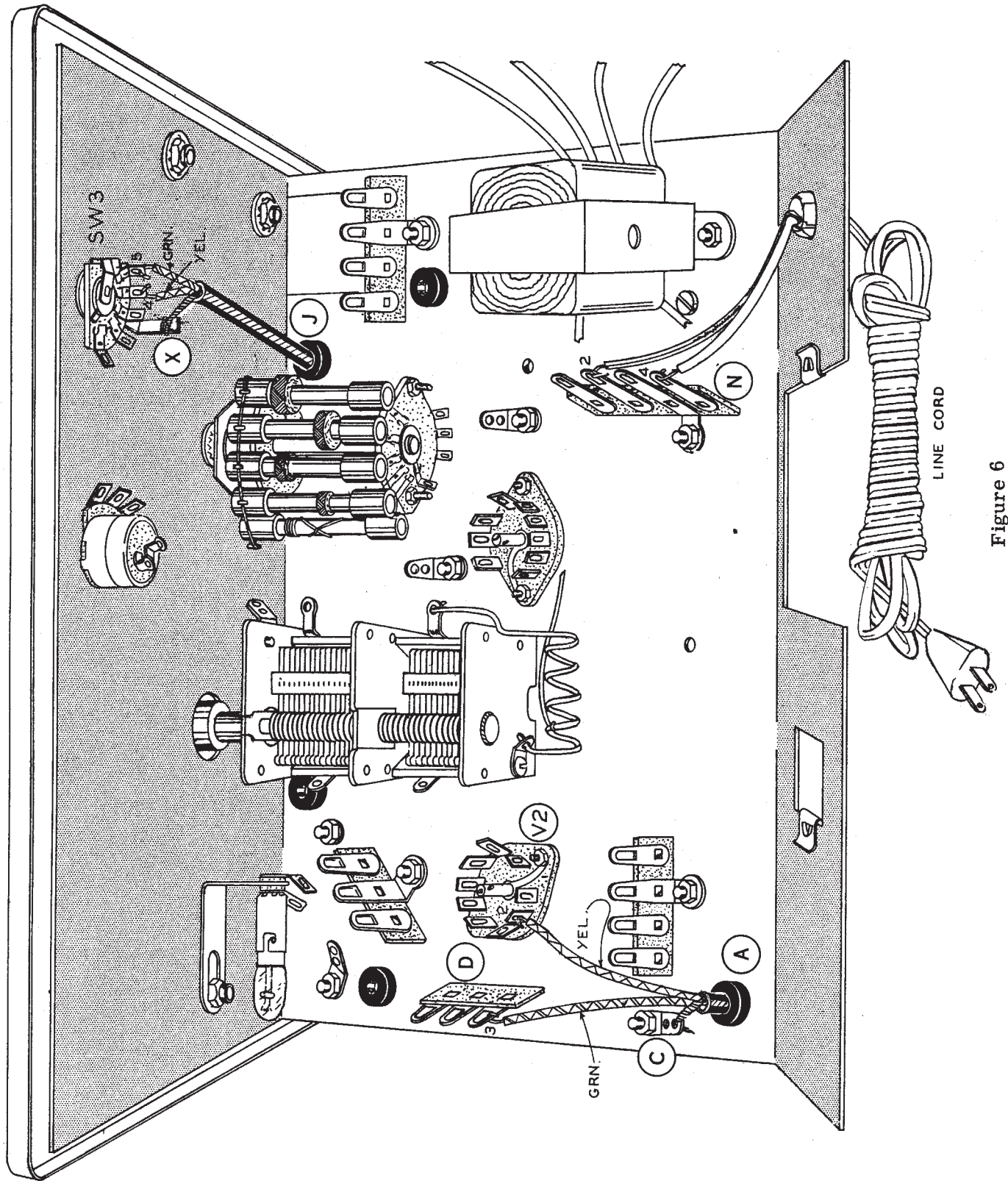

Figure 6

() Prepare the two-conductor shielded cable as shown in Figure 7. Tin ends of leads.

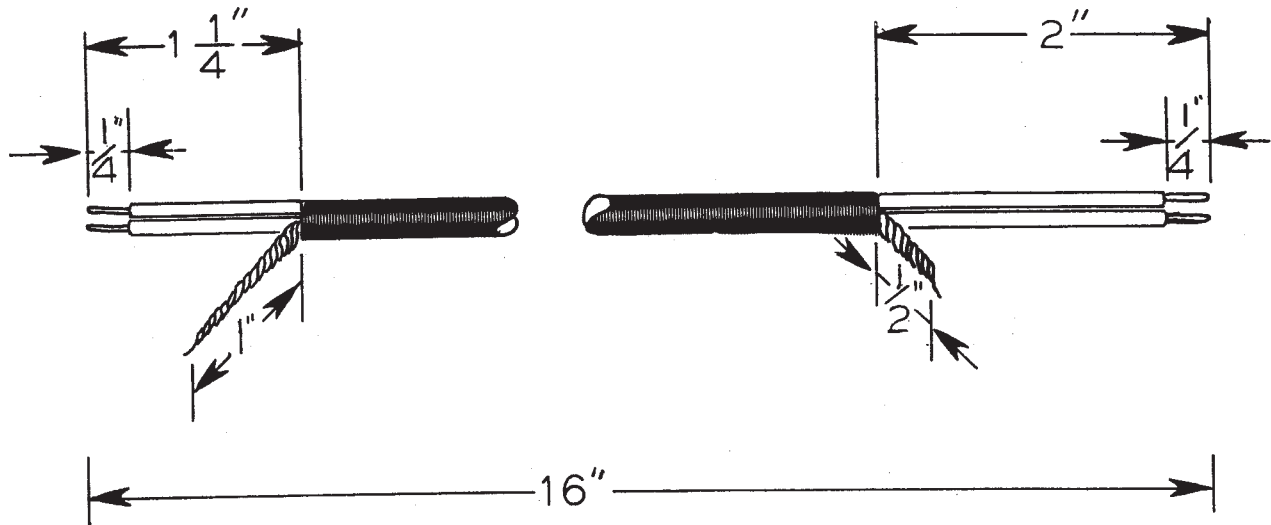

Figure 7

- () Refer to Figure 6 and insert the end of the shielded cable with the shortest leads through grommet J, from the tube side of the chassis. Connect the yellow wire to lug 4 (S-1) and the green wire to lug 5 (S-1) of SW3. Connect the shield to solder lug X (S-2). Insert the other end of the cable through grommet A. Connect the yellow wire to pin 2 (S-2) of V2, the green wire to lug 3 (S-2) of terminal strip D and the shield to ground lug C (S-1).
- () Install the line cord as shown in Figure 8. First tin leads and then connect one wire to lug 2 (S-3) and the other wire to lug 4 (S-3) of terminal strip N.

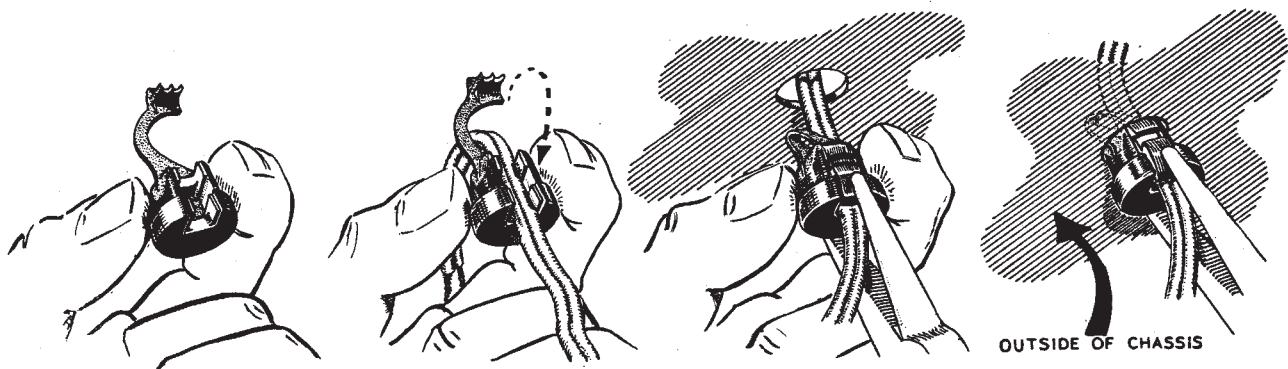

Figure 8

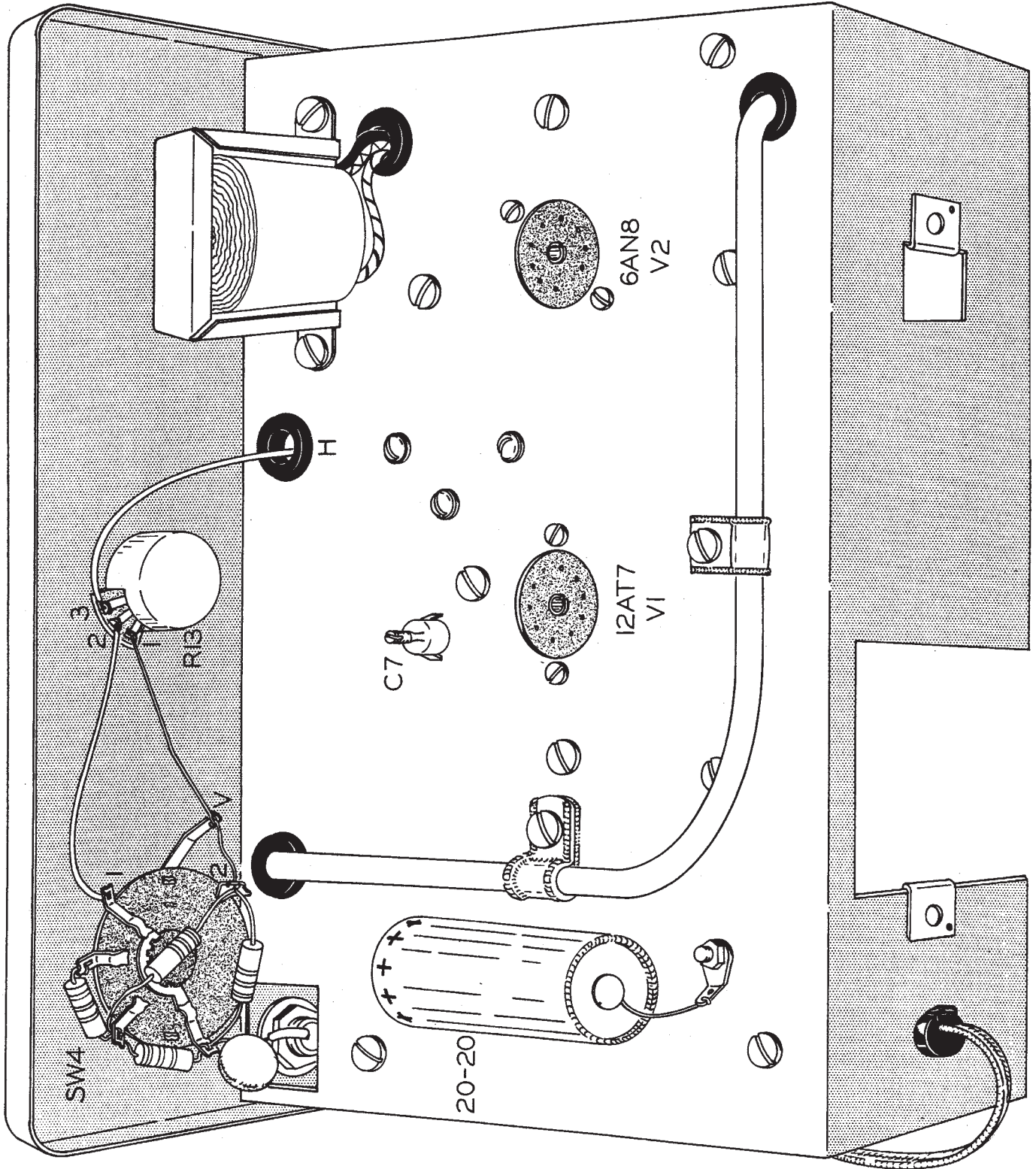
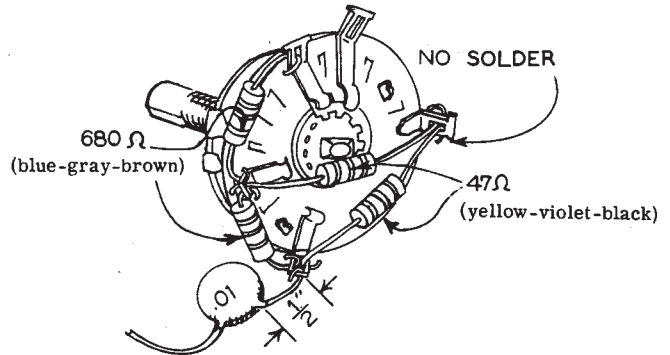

Figure 9

- () Turn the unit over and install the two cable clamps as shown in Figure 9. Use 6-32 x 3/8" BHMS.
- () Install the fine attenuator control (#10-27) R13. Use two control lockwashers between the control and panel.
- () Prepare the attenuator switch SW4 as shown in Figure 10. Install the switch, using a control lockwasher and a control solder lug next to the panel. Orient as shown, so that knob pointer will indicate properly.
- () Connect the wire from terminal strip G through grommet H to lug 3 (S-1) of R13.
- () Connect one end of a 2 1/2" length of bare wire to lug 1 (S-1) of R13. Wrap the wire around the solder lug V (S-1) and connect to lug 2 (S-3) of SW4.
- () Connect a 2 1/2" wire between lug 2 (S-1) of R13 and lug 1 (S-1) of SW4.
- () With the use of sleeving, connect the .01 μ fd capacitor from SW4 to the RF output jack (S).



NOTE:
INSTALL THE COMPONENTS AS
SHOWN AND SOLDER. KEEP THE
LEADS SHORT.

Figure 10

This completes the wiring of your Heathkit Model RF-1 Signal Generator. Carefully check each operation for accuracy. Remove any solder splashes, wire clippings or any other foreign material. Inspect the wiring to be sure that all components are dressed to avoid shorts to each other, or to the chassis.

IMPORTANT WARNING: MINIATURE TUBES CAN BE EASILY DAMAGED WHEN INSTALLING THEM IN THEIR SOCKETS. THEREFORE, USE EXTREME CARE WHEN INSTALLING THESE TUBES. WE DO NOT GUARANTEE OR REPLACE MINIATURE TUBES BROKEN DURING INSTALLATION.

- () Install the 12AT7 and 6AN8 tubes, V1 and V2. Refer to Figure 9.

() Refer to Figure 11 and install the dial pointer, using an 8-32 setscrew. Make sure that the pointer lines up with the end marking at the low end of the dial scale when the tuning gang is at its maximum counterclockwise rotation. Tighten the setscrew securely.

() Install the knobs.

NOTE: The BAND switch and ATTEN switch may have to be oriented so that the knob pointers line up with the panel markings.

() Prepare the output cable as shown in Figure 12.

() Mount the handle on the cabinet, using #10 self-tapping screws. After completing the calibration procedure, install the instrument in the cabinet and secure with 6-32 x 3/8" BHMS.

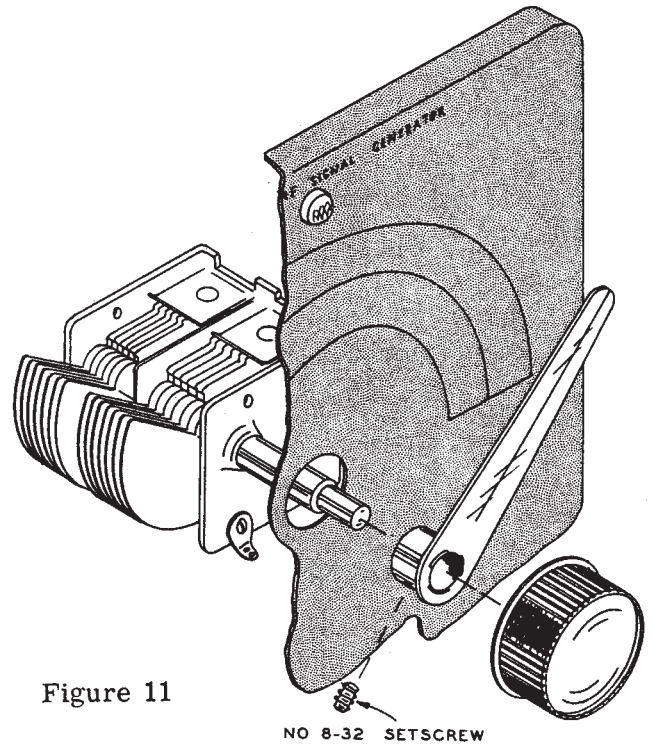

Figure 11

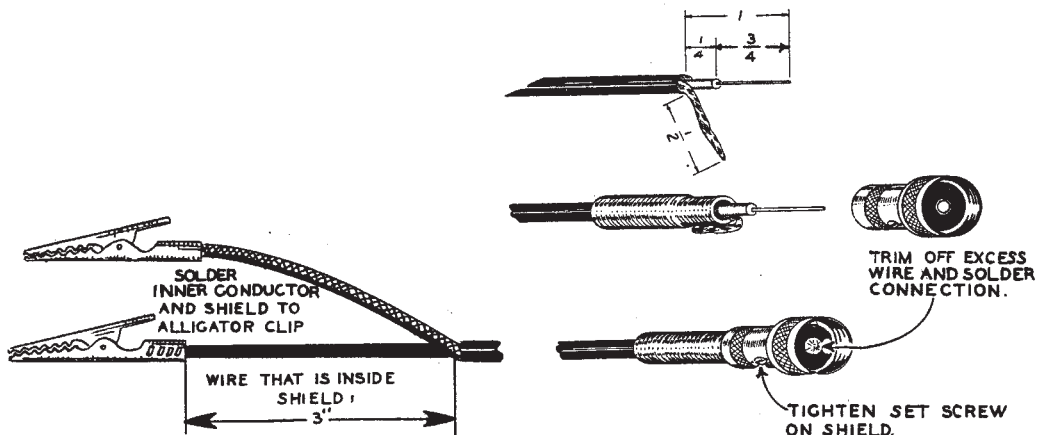
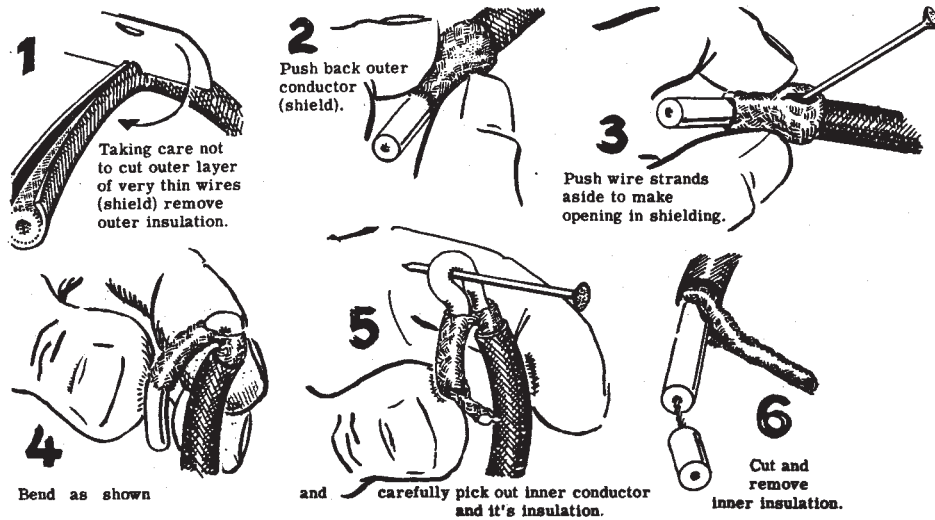

Figure 12

CALIBRATING THE RF-1

The only equipment needed for calibration is an AM and an FM radio. Before proceeding with the following steps, turn on both the RF-1 and the radios and allow approximately ten minutes warmup time.

1. () Carefully tune the AM radio to a station of known frequency between 800 kc and 1000 kc. The frequency of the chosen station should preferably be one that falls on a Band B dial calibration point, such as 850 kc or 1000 kc.
2. () Turn the trimmer capacitor C7 to approximately the center of its range.
3. () Set the band switch of the generator to Band B, the modulation switch to EXT. MOD., and the coarse and fine attenuators to their maximum clockwise rotation.
4. () Connect the output cable to the RF output jack. Place the end of the cable in close proximity to the loop or antenna lead of the radio, but not directly connected to the radio.
5. () Turn the tuning control of the RF-1 until a squeal is heard in the radio receiver. Adjust the tuning for the lowest pitched squeal, or preferably a point where there is a slow popping, with an increasing squeal on either side of this setting. The slow popping, or its complete cessation, is known as "zero beat". The pointer should now indicate a frequency very close to the frequency of the station to which the receiver is tuned.
6. () Reset the tuning of the generator so that the pointer indicates the same frequency as that of the broadcasting station. Now adjust the trimmer capacitor C7 to re-establish the zero beat.
7. () Tune the FM radio to a station around 90 mc.
8. () Connect the output cable to the FM antenna terminals.
9. () Turn the generator to Band F and turn the modulation switch to INT. MOD.
10. () Adjust the tuning of the RF-1 to the frequency to which the receiver is tuned. It will be noted that as the generator is tuned through the frequency, that the 400 cycle modulation will be louder on both sides of the center frequency. This is normal and is due to the fact that the generator is amplitude modulated and has very little frequency modulation. The point where the 400 cycle tone is at a minimum is the correct position.
11. () If, in Step #10, the RF-1 dial indicated a frequency lower than the station frequency, gently squeeze the turns of the Band F coil together until the dial indicates the correct frequency. If the dial indicates a higher frequency, the coil turns should be spread apart slightly.

This concludes the general calibration of the instrument. The coils for Bands A through E have been preadjusted at the factory to precision standards. A slight improvement in accuracy may possibly be realized if the individual coil slugs are tuned, utilizing a communication type receiver and WWV, or a laboratory generator with an accuracy of at least 1% in conjunction with an oscilloscope to indicate zero beat. It is recommended, however, that the coil slugs not be turned unless the preceding equipment is available and the operator is thoroughly familiar with alignment procedures using such equipment.

ACCURACY

Any signal generator is designed as a convenient and controlled source of modulated, or unmodulated, signals. No ordinary signal generator is designed as a frequency standard. Expensive standard signal generators have very accurate (3% to 20%) attenuators which control the output voltage. The frequency calibration accuracy is rarely closer than 1%. The Heathkit RF-1 Signal Generator may be expected to fall within 2% of the dial calibration, which is quite satisfactory for service work and alignment. In receiver adjustment the frequency at which the particular adjustment is made is not very critical, but the adjustment itself for maximum signal output from the receiver is frequently quite critical. For accurate calibration of home-built receivers or equipment, proceed as follows: Make a rough calibration with a signal generator, then with a receiver tune in WWV (Bureau of Standards) at 2.5 mc, 5 mc or 10 mc. Set the generator to a suitable subharmonic such as 500 kc or 1000 kc, then adjust the generator for zero beat. Now, harmonics of the signal generator occur every 500 kc or 1 mc, and these harmonics may be used to give accurate calibration at points 500 kc or 1000 kc apart, such as 2500 kc or 3000 kc. These known frequency points can be marked on the dial of the equipment being calibrated. The object of the rough calibration is merely to furnish a means of identifying, for example, the 3000 kc point from the 2500 kc point, or 3500 kc point. For calibration of higher frequency equipment, a choice of higher reference frequency will reduce the confusion between the multitude of harmonics and will also insure adequate signal strength. When checking the calibration accuracy of the RF-1, the most convenient standards of comparison of sufficient accuracy are broadcast and FM stations of known frequencies. Do not depend on the receiver dial calibrations, however, because they are usually not of sufficient accuracy to warrant consideration.

IN CASE OF DIFFICULTY

1. Recheck the wiring. Trace each lead in colored pencil on the pictorial as it is checked. It is frequently helpful to have a friend check your work. Someone who is not familiar with the unit may notice something consistently overlooked by the constructor.
2. It is interesting to note that about 90% of the kits that are returned for repair are defective due to poor connections and soldering. Therefore, many troubles can be eliminated by reheating all connections to make sure that they are soldered as illustrated in the Figures found in the SOLDERING TECHNIQUES section of this manual.
3. Check to be sure that all tubes are in their proper locations. Make sure that all tubes light up properly.
4. Check the values of the component parts. Be sure that the proper part has been wired into the circuit, as shown in the pictorial diagram and as called out in the wiring instructions.
5. Check for bits of solder, wire ends or other foreign matter which may be lodged in the wiring, tube sockets or terminal strips.
6. Check the tubes with a tube tester or by substituting a known good tube of the same type.
7. If, after careful checks, the trouble is still not located and a voltmeter is available, check voltage readings against those found on the Schematic Diagram. NOTE: All voltage readings were taken with a Heathkit Vacuum Tube Voltmeter. Voltages may vary 10% due to line voltage variations.
8. A review of the circuit description will prove helpful in indicating where to look for trouble.
9. If the RF-1 fails to function on any one particular band, the coil for that band may be open.

SERVICE

If, after applying the information contained in this manual and your best efforts, you are still unable to obtain proper performance, it is suggested that you take advantage of the technical facilities which the Heath Company makes available to its customers.

The Technical Consultation Department is maintained for your benefit. This service is available to you at no charge. Its primary purpose is to provide assistance for those who encounter difficulty in the construction, operation or maintenance of HEATHKIT equipment. It is not intended, and is not equipped to function as a general source of technical information involving kit modifications nor anything other than the normal and specified performance of HEATHKIT equipment.

Although the Technical Consultants are familiar with all details of this kit, the effectiveness of their advice will depend entirely upon the amount and the accuracy of the information furnished by you. In a sense, YOU MUST QUALIFY for GOOD technical advice by helping the consultants to help you. Please use this outline:

1. Before writing, fully investigate each of the hints and suggestions listed in this manual under "IN CASE OF DIFFICULTY." Possibly it will not be necessary to write.
2. When writing, clearly describe the nature of the trouble and mention all associated equipment. Specifically report operating procedures, switch positions, connections to other units and anything else that might help to isolate the cause of trouble.
3. Report fully on the results obtained when testing the unit initially and when following the suggestions under "IN CASE OF DIFFICULTY." Be as specific as possible and include voltage readings if test equipment is available.
4. Identify the kit model number and date of purchase, if available.
5. Print or type your name and address, preferably in two places on the letter.

With the preceding information, the consultant will know exactly what kit you have, what you

would like it to do for you and the difficulty you wish to correct. The date of purchase tells him whether or not engineering changes have been made since it was shipped to you. He will know what you have done in an effort to locate the cause of trouble and, thereby, avoid repetitious suggestions. In short, he will devote full time to the problem at hand, and through his familiarity with the kit, plus your accurate report, he will be able to give you a complete and helpful answer. If replacement parts are required, they will be shipped to you, subject to the terms of the Warranty.

The Factory Service facilities are also available to you, in case you are not familiar enough with electronics to provide our consultants with sufficient information on which to base a diagnosis of your difficulty, or in the event that you prefer to have the difficulty corrected in this manner. You may return the completed instrument to the Heath Company for inspection and necessary repairs and adjustments. You will be charged a minimal service fee, plus the price of any additional parts or material required. However, if the completed kit is returned within the Warranty period, parts charges will be governed by the terms of the Warranty. State the date of purchase, if possible.

Local Service by Authorized HEATHKIT Service Centers is also available in some areas and often will be your fastest, most efficient method of obtaining service for your HEATHKIT equipment. Although you may find charges for local service somewhat higher than for factory service, the amount of increase is usually offset by the transportation charge you would pay if you elected to return your kit to the Heath Company.

HEATHKIT Service Centers will honor the regular 90 day HEATHKIT Parts Warranty on all kits, whether purchased through a dealer or directly from Heath Company; however, it will be necessary that you verify the purchase date of your kit.

Under the conditions specified in the Warranty, replacement parts are supplied without charge; however, if the Service Center assists you in locating a defective part (or parts) in your kit, or installs a replacement part for you, you may be charged for this service.

HEATHKIT equipment purchased locally and returned to Heath Company for service must be accompanied by your copy of the dated sales receipt from your authorized HEATHKIT dealer in order to be eligible for parts replacement under the terms of the Warranty.

THIS SERVICE POLICY APPLIES ONLY TO COMPLETED EQUIPMENT CONSTRUCTED IN ACCORDANCE WITH THE INSTRUCTIONS AS STATED IN THE MANUAL. Equipment that has been modified in design will not be accepted for repair. If there is evidence of acid core solder or paste fluxes, the equipment will be returned NOT repaired.

For information regarding modification of HEATHKIT equipment for special applications, it is suggested that you refer to any one or more of the many publications that are available on all phases of electronics. They can be obtained at or through your local library, as well as at most electronic equipment stores. Although the Heath Company sincerely welcomes all comments and suggestions, it would be impossible to design, test, evaluate and assume responsibility for proposed circuit changes for special purposes. Therefore, such modifications must be made at the discretion of the kit builder, using information available from sources other than the Heath Company.

REPLACEMENTS

Material supplied with HEATHKIT products has been carefully selected to meet design requirements and ordinarily will fulfill its function without difficulty. Occasionally improper instrument operation can be traced to a faulty component. Should inspection reveal the necessity for replacement, write to the Heath Company and supply all of the following information.

- A. Thoroughly identify the part in question by using the part number and description found in the manual Parts List.
- B. Identify the type and model number of kit in which it is used.

C. Mention date of purchase.

D. Describe the nature of defect or reason for requesting replacement.

The Heath Company will promptly supply the necessary replacement. PLEASE DO NOT RETURN THE ORIGINAL COMPONENT UNTIL SPECIFICALLY REQUESTED TO DO SO. Do not dismantle the component in question as this will void the guarantee. This replacement policy does not cover the free replacement of parts that may have been broken or damaged through carelessness on the part of the kit builder.

SHIPPING INSTRUCTIONS

In the event that your instrument must be returned for service, these instructions should be carefully followed.

ATTACH A TAG TO THE EQUIPMENT BEARING YOUR NAME, COMPLETE ADDRESS, DATE OF PURCHASE, AND A BRIEF DESCRIPTION OF THE DIFFICULTY ENCOUNTERED. Wrap the equipment in heavy paper, exercising care to prevent damage. Place the wrapped equipment in a stout carton of such size that at least three inches of shredded paper, excelsior, or other resilient packing material can be placed between all sides of the wrapped equipment and the carton. Close and seal the carton with gummed paper tape, or alternately, tie securely

with stout cord. Clearly print the address on the carton as follows:

To: HEATH COMPANY
Benton Harbor, Michigan

Include your name and return address on the outside of the carton. Preferably affix one or more "Fragile" or "Handle With Care" labels to the carton, or otherwise so mark with a crayon of bright color. Ship by parcel post or prepaid express; note that a carrier cannot be held responsible for damage in transit if, in HIS OPINION, the article is inadequately packed for shipment.

All prices are subject to change without notice. The Heath Company reserves the right to discontinue instruments and to change specifications

at any time without incurring any obligation to incorporate new features in instruments previously sold.

USING THE RF-1

In order to realize the maximum usefulness of this instrument, the operator should thoroughly familiarize himself with the following information on panel markings, operating procedures, alignment, etc.

The six bands of the RF-1 are calibrated on three large dial scales, rather than six separate scales. This arrangement permits the use of larger lettering and radius on the scales, thereby increasing readability and accuracy. Bands A, C and E are on the first scale, which is calibrated from 10 to 32. On Band A it is necessary to multiply the number by 10, just as is done on many radio dials. For example, if the band switch was on Band A and the pointer at 23 (see Figure 13), the frequency would be 230 kc. On Band C, it is necessary to divide by 10. In other words, 23 on Band C is 2.3 mc. Band E is read directly. Bands B and D are on another scale. On Band B, you must multiply by 10. Therefore, 75 would be 750 kc. On Band D, the number must be divided by 10, thus making 75 equal 7.5 mc. Band F is a separate scale and can be read directly. Another feature of the dial scales is the special markings at 10.7 mc and 455 kc. These are the most commonly used IF frequencies for FM and AM radios, respectively.

The RF fine attenuator, coarse attenuator and RF output are self explanatory. 400 cycle audio frequency is available at the EXT MOD IN/AF OUT jack, when the modulation switch is in the internal modulation position. When the switch is in the external modulation position, the internal 400 cycle modulation is turned off, and the RF signal may be modulated by feeding an audio frequency signal into the modulation jack. Approximately 3 volts is required for 30% modulation. The EXT MOD/AF OUT control enables the user to control the level of external modulation and also the level of the 400 cycle output. This control also turns the instrument off and on.

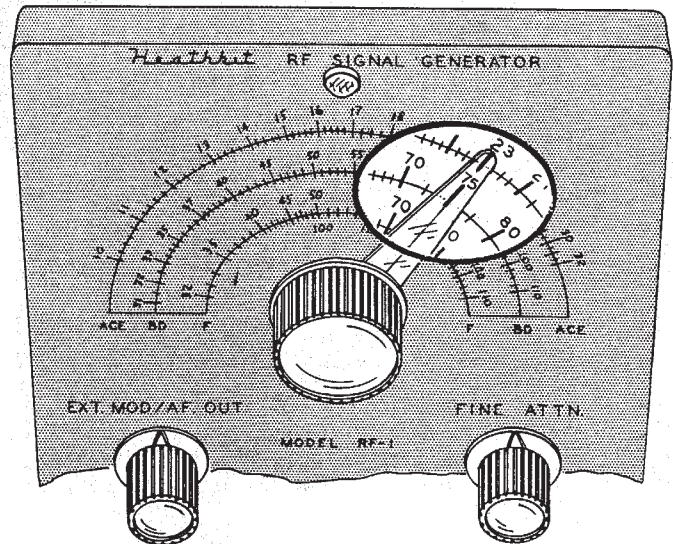

Figure 13

ALIGNMENT OF AM TUNERS AND RECEIVERS

Today's modern AM radios have become quite standardized; therefore, it is seldom necessary to refer to a specific manufacturer's alignment instructions. The most important thing to note is the IF frequency used. 455 kc is by far the most common; however, 262 kc and 460 kc are used occasionally. The following Step-By-Step Procedure can be used in most cases.

The schematic diagram of Figure 14 illustrates a typical AM receiver; the following alignment procedure would be applicable.

1. () Turn both the signal generator and the receiver on and allow several minutes for both to reach normal operating temperature.
2. () While the speaker may be used as an indication of output, it is much more desirable to use some other type of output indicator. This may be an AC voltmeter, connected directly across the speaker voice coil or perhaps a VTVM, connected to measure AVC voltage, would be more desirable.

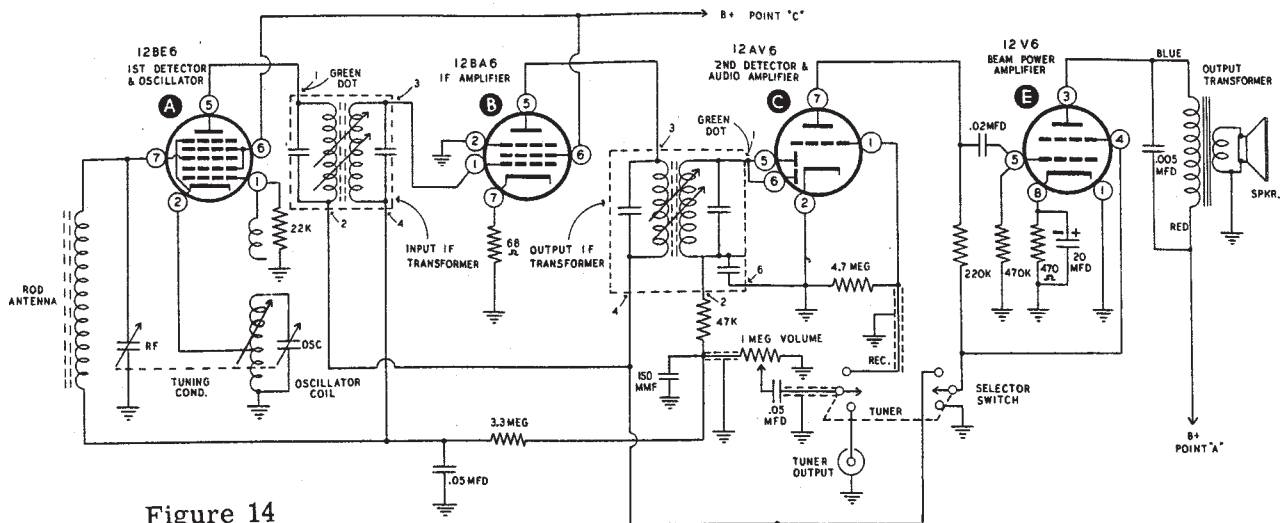

Figure 14

3. () Turn the receiver dial so that the tuning capacitors are completely open (high frequency end of dial).
4. () Couple the signal generator to the receiver antenna. The most convenient method of accomplishing this is to place the "hot" lead of the generator output cable in close proximity to the loop or rod antenna. In some extreme cases it may be necessary to connect directly to the antenna terminals or the IF grid. Set the generator to the IF frequency (455 kc) and set the modulation switch to INT MOD.
5. () Adjust the output of the signal generator to the point where the signal can just be heard, or read on the output indicator.
6. () Adjust the IF transformers for maximum output. Keep reducing the signal generator output as necessary to keep a low reading on the output indicator. Repeat these adjustments at least once to correct for any interaction between primary and secondary windings of the individual transformers. Interaction is most likely to occur in sets where adjustment is by means of iron core slugs rather than trimmer capacitors.
7. () Next, tune the receiver to its highest calibrated frequency setting (usually somewhere around 1600 kc). Set the generator to the same frequency and adjust the oscillator trimmer for maximum output.
8. () Now tune the receiver and signal generator to 1400 kc and adjust the RF trimmer for maximum output.
9. () Set the signal generator to 600 kc and tune the receiver to the low frequency end of the dial. Now "rock" (turn slightly back and forth) the receiver tuning capacitor while at the same time adjusting the oscillator trimmer (or slug) for maximum output. In some receivers, the low frequency oscillator adjustment will be made by means of an iron core slug in the oscillator coil rather than by a trimmer. On receivers that have no low end oscillator adjustment, it may be necessary to compromise between the high and low end tracking.
10. () Step 8 should be repeated if it was found necessary to readjust the trimmer, or slug, as directed in Step 9.

The RF alignment procedure for multiband AM receivers is essentially the same as outlined above for a single band set. Each band is aligned separately, starting with the highest frequency and working toward the lowest. The technique outlined above should be used but with appropriate high and low frequency settings for each band.

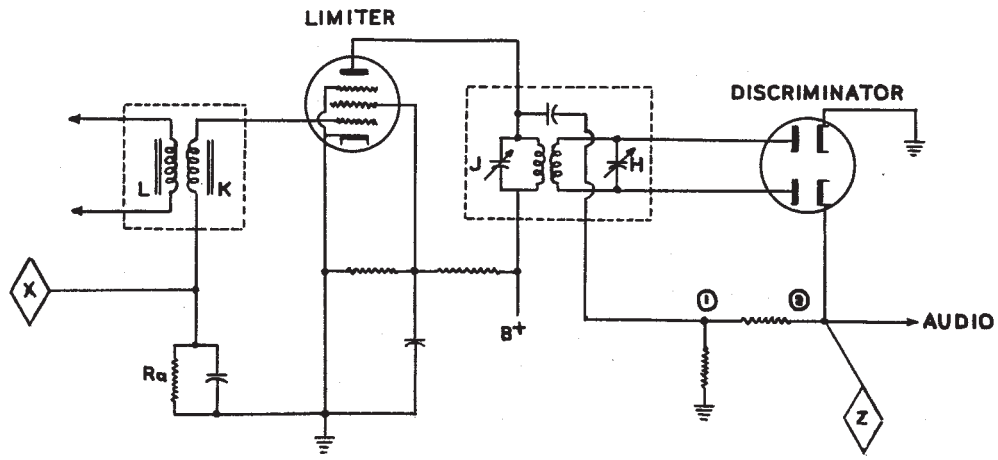

Figure 15

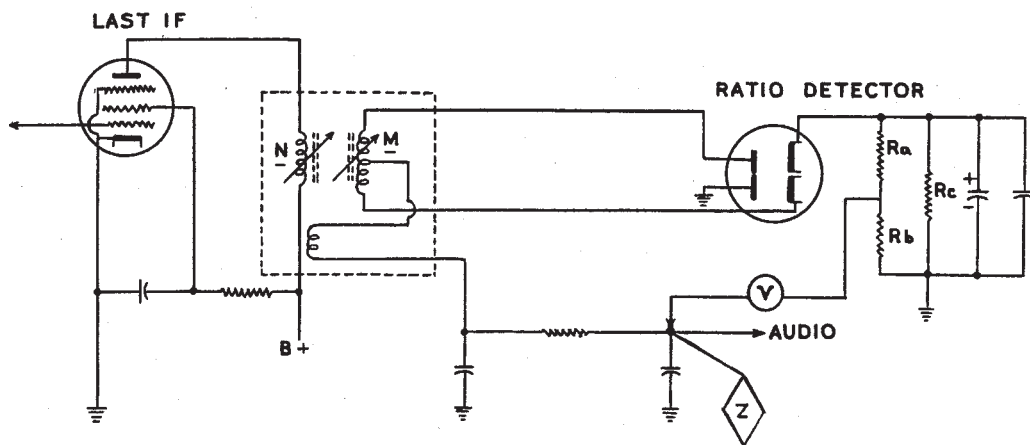
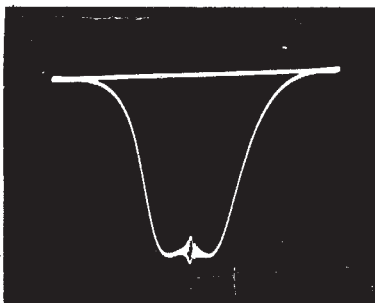
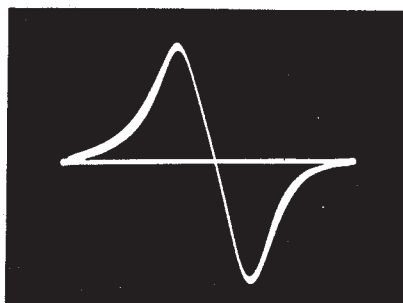

Figure 16



17A

FM IF response with 10.7 mc marker.



17B

Ratio detector or discriminator response with 10.7 mc marker at 0.

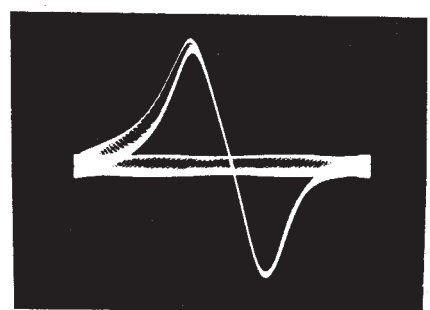

17C

Ratio detector or discriminator response with 10.7 mc marker not at 0. Note 400 cycle modulation.

FM TUNER AND RECEIVER ALIGNMENT

While the procedure of aligning the IF, and then the oscillator and RF, of an FM receiver is similar to that of an AM receiver, there are several important differences, the greatest one being that the ratio detector or discriminator must be aligned after the IF alignment. Due to the many varied IF bandwidths and types of IF transformer coupling that are used, it is imperative that the unskilled operator consult the receiver manufacturer's alignment notes before attempting FM alignment. While many FM receivers may be aligned with a standard AM generator by peaking the IF's to the IF frequency (usually 10.7 mc), as many others will have to be aligned using a sweep generator. Therefore, only a general procedure will be outlined here. The RF-1 may be used, no matter which procedure is recommended by the manufacturer, either as an AM generator or as an accurate marker generator during sweep alignment.

Most procedures call for the use of either a vacuum tube voltmeter or oscilloscope as an output indicator. The specified indicator is generally connected in series with an approximately 100 K Ω resistor to the grid return of the last limiter (point X in Figure 15): Output indications for both RF and IF alignment are obtained from this point. Oscilloscope connections for both a ratio detector and a discriminator are shown as point Z in accompanying Figures 15 and 16, respectively. When aligning the secondary of a ratio detector or discriminator, it is sometimes very difficult to see the 10.7 marker on the S curve because the 10.7 mc point is at 0, or the crossover point. To facilitate alignment of the secondary, it is helpful to turn the modulation from the RF generator on and adjust the secondary for a minimum amount of 400 cycle signal on the S curve (see Figures 17B and 17C). A ratio detector or discriminator inherently has a certain amount of AM suppression. Therefore, when the 400 cycle AM modulation is at a minimum, the operator can be sure that the 10.7 marker is at 0 even though it may not be visible. This procedure is only effective when an AM signal generator such as the RF-1, which has very little incidental FM, is used.

Signal generator connections to the receiver vary with different procedures. Some procedures align each stage successively, starting with the last limiter stage and proceeding toward the mixer; in other procedures, the generator is connected directly to the mixer. A convenient method that can be used to connect the generator to the mixer stage without upsetting alignment is to connect the "hot" lead of the generator to an ungrounded tube shield over the mixer tube. For RF alignment, the generator is usually connected to the antenna terminals through a suitable matching pad.

SERVICING BY SIGNAL INJECTION

Another use of the generator is a method of servicing called signal injection. This procedure may prove very helpful in isolating defective stages in a receiver when other troubleshooting methods fail. The method involves the application of first, an audio signal to the grid of the audio output tube, and then moving forward to the first audio amplifier. From there an audio modulated IF frequency signal should be fed into the grid of the last IF tube. Continue to move the signal injection point toward the antenna terminals (using the appropriate frequency) until the defective stage is located; this of course would be where there is no signal heard through the receiver. For example, if a clear tone is heard when the "hot" generator lead is touched to point E in Figure 18, but not when it is touched to point F, we are reasonably sure that capacitor C1 is open. The accompanying Block Diagram may also help to illustrate this procedure. See Figure 19.

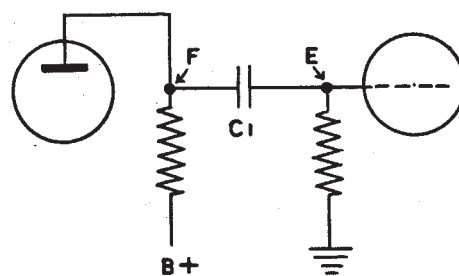

Figure 18

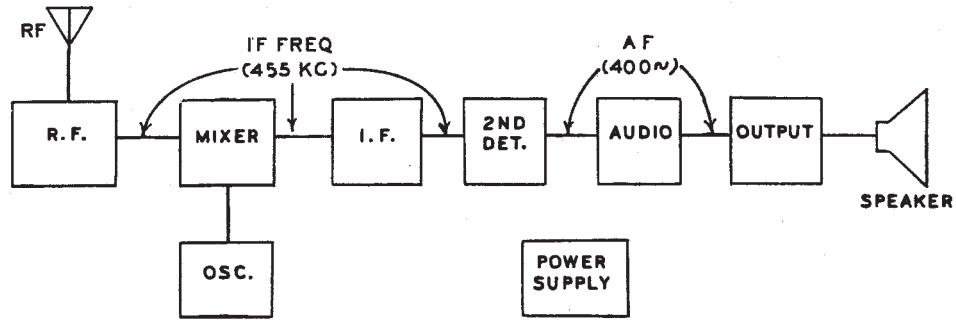

Figure 19

WARRANTY

Heath Company warrants that for a period of three months from the date of shipment, all Heathkit parts shall be free of defects in materials and workmanship under normal use and service and that in fulfillment of any breach of such warranty, Heath Company shall replace such defective parts upon the return of the same to its factory. The foregoing warranty shall apply only to the original buyer, and is and shall be in lieu of all other warranties, whether express or implied and of all other obligations or liabilities on the part of Heath Company and in no event shall Heath Company be liable for any anticipated profits, consequential damages, loss of time or other losses incurred by the buyer in connection with the purchase, assembly or operation of Heathkits or components thereof. No replacement shall be made of parts damaged by the buyer in the course of handling or assembling Heathkit equipment.

NOTE: The foregoing warranty is completely void and we will not replace, repair or service instruments or parts thereof in which acid core solder or paste fluxes have been used.

HEATH COMPANY

PARTS LIST

PART No.	PARTS Per Kit	DESCRIPTION
----------	---------------	-------------

Resistors

1-1	2	47 Ω 1/2 watt (yellow-violet-black)
1-7	3	680 Ω 1/2 watt (blue-gray-brown)
1-20	1	10 K Ω 1/2 watt (brown-black-orange)
1-24	3	33 K Ω 1/2 watt (orange-orange-orange)
1-26	3	100 K Ω 1/2 watt (brown-black-yellow)
1-47	1	56 K Ω 1/2 watt (green-blue-orange)
1-48	1	390 Ω 1/2 watt (orange-white-brown)
1A-23	1	2.2 K Ω 1 watt (red-red-red)



1/2 Watt Resistor



1 Watt Resistor

PART No.	PARTS Per Kit	DESCRIPTION
----------	---------------	-------------

Capacitors

20-99	1	22 $\mu\mu\text{f}$ mica
20-101	1	47 $\mu\mu\text{f}$ mica
21-14	2	.001 μfd disc ceramic
21-16	4	.01 μfd ceramic
21-27	1	.005 μfd ceramic
21-29	1	4.7 $\mu\mu\text{f}$ N750 tubular ceramic
21-31	5	.02 μfd disc ceramic
21-32	1	47 $\mu\mu\text{f}$ disc ceramic
23-28	1	.1 μfd 200 V tubular
23-39	1	.0047 μfd 600 V tubular
23-50	1	.022 μfd 400 V tubular
23-59	1	.05 μfd 200 V tubular
25-7	1	20-20 at 150 V electrolytic
26-57	1	164 $\mu\mu\text{f}$ and 364 $\mu\mu\text{f}$ tuning (dual)
28-1	1	2.2 $\mu\mu\text{f}$ $\pm 20\%$ molded phenolic
31-8	1	1-10 $\mu\mu\text{f}$ trimmer

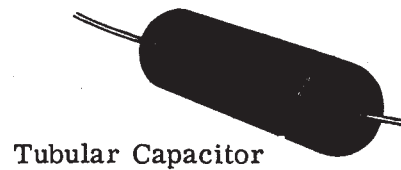
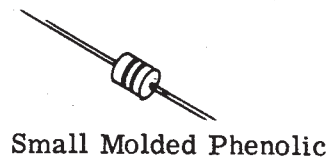
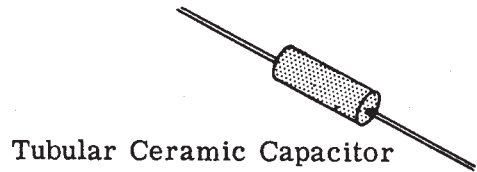
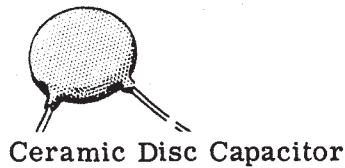

Controls-Transformers-Switches

A-19-11	1	100 K Ω control w/switch
B-10-27	1	3 K Ω audio taper control
51-44	1	Oscillator transformer
54-92	1	Power transformer
63-70	1	3-position attenuator switch
63-211	1	2-position modulation switch
163-2	1	Band switch and coil assembly

Consisting of:

20-52	1	7.5 $\mu\mu\text{f}$ mica capacitor
40-188	1	Band A oscillator coil
40-189	1	Band B oscillator coil
40-190	1	Band C oscillator coil
40-191	1	Band D oscillator coil
40-192	1	Band E oscillator coil
63-212	1	6-position band switch

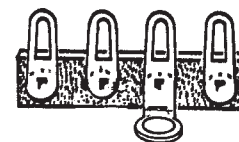
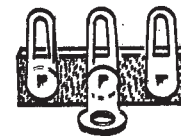

Terminal Strips-Connectors-Sockets

431-10	2	3-lug terminal strip
431-40	3	4-lug terminal strip
432-1	1	Cable connector
432-3	2	Chassis connector
434-77	2	9-pin wafer tube socket
434-87	1	Pilot light socket

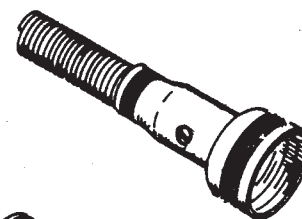

Tubes-Lamps

411-24	1	12AT7 tube
411-68	1	6AN8 tube
412-1	1	#47 pilot lamp
413-4	1	Pilot light jewel with nut



PART No.	PARTS Per Kit	DESCRIPTION
----------	---------------	-------------

Wire-Cable-Sleeving

340-2	1	Length #20 bare wire
343-2	1	Length coax cable
344-1	1	Length hookup wire
346-1	1	Length sleeving
347-3	1	Length 2-conductor shielded cable



6-32 RHMS



8-32 Setscrew



#10 Sheet Metal Screw



3-48 BHMS

Metal Parts

90-110	1	Cabinet
100-M10	1	Dial pointer assembly
200-M221	1	Chassis
203-180F273	1	Front panel



6-32 BHMS



3-48 Nut



6-32 Nut

Hardware

250-7	5	6-32 x 3/16" RHMS
250-16	1	8-32 setscrew
250-49	4	3-48 x 1/4" BHMS
250-56	13	6-32 x 1/4" BHMS
250-83	2	#10 sheet metal screw
250-89	4	6-32 x 3/8" BHMS
252-1	4	3-48 nut
252-3	15	6-32 nut
252-7	5	3/8" control nut
252-22	2	Speednut
253-10	5	Control flat washer
254-1	18	#6 lockwasher
254-4	7	Control lockwasher
259-1	7	#6 solder lug
259-10	2	Control solder lug
260-1	2	Alligator clip



Control Nut



Speednut



Control Flat Washer



#6 Lockwasher



Control Lockwasher



#6 Solder Lug

Miscellaneous

40-193	1	Band F oscillator coil
57-23	1	200 ma silicon rectifier
73-1	5	3/8" rubber grommet
75-24	1	Line cord strain relief
89-1	1	Line cord
207-4	2	1/4" plastic clamp
211-4	1	Handle
462-19	5	Knob, pointer
462-44	1	Knob, large
490-1	1	Alignment tool
595-274	1	Manual

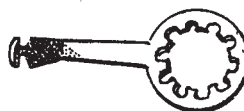

Control Solder Lug

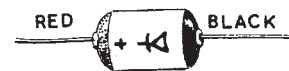

Silicon Rectifier



Line Cord Strain Relief



Rubber Grommet

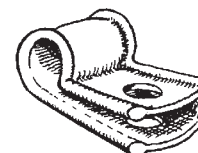









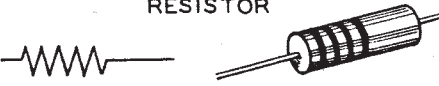
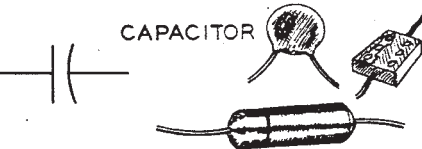
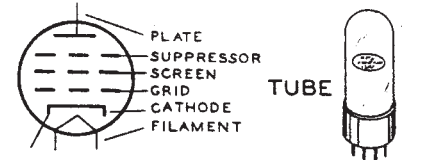
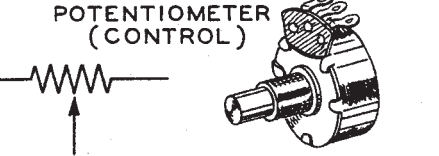
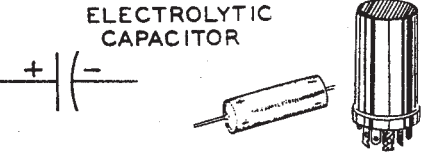

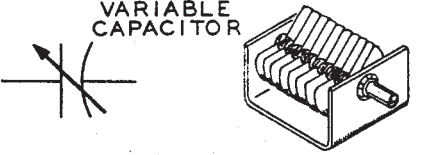
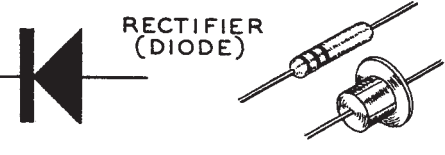
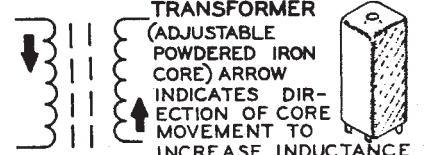
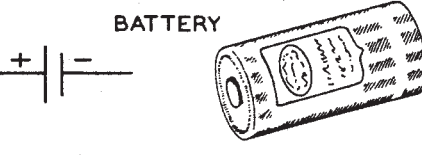
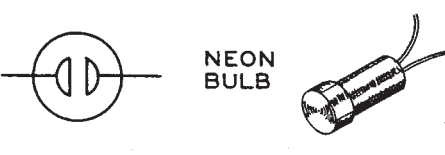
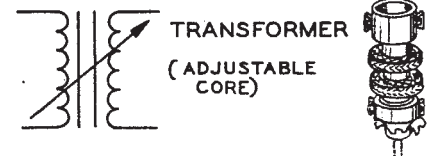
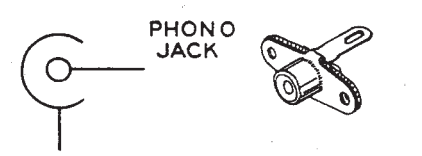
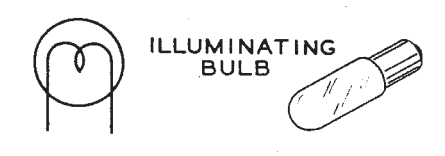
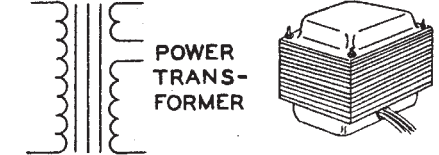
Cable Clamp

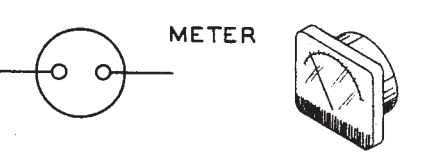
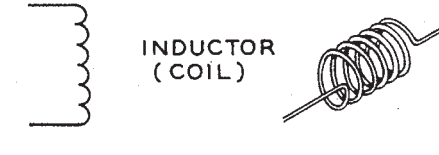
TYPICAL COMPONENT TYPES

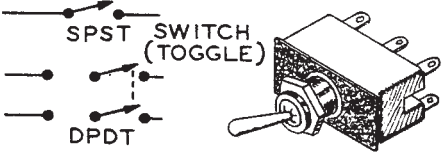
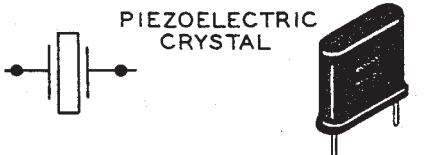
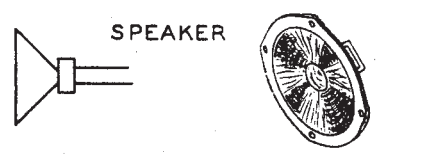
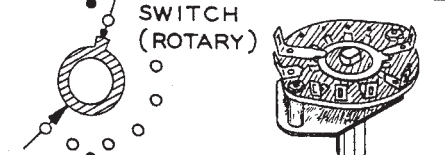
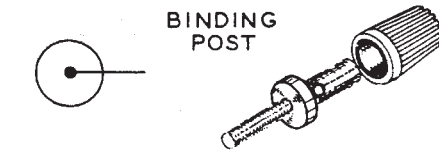
This chart is a guide to commonly used types of electronic components. The symbols and related illustrations

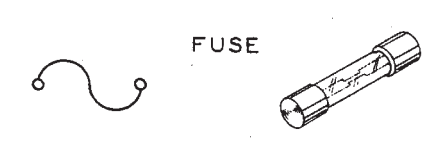
should prove helpful in identifying most parts and reading the schematic diagrams.

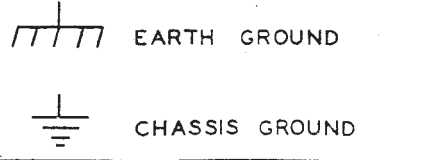
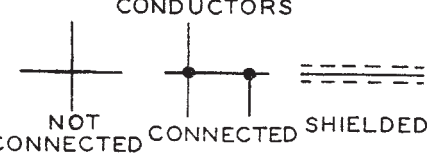
<p style="text-align: center;">RESISTOR</p> 	<p style="text-align: center;">CAPACITOR</p> 	<p style="text-align: center;">TUBE</p> 
<p style="text-align: center;">POTENTIOMETER (CONTROL)</p> 	<p style="text-align: center;">ELECTROLYTIC CAPACITOR</p> 	<p style="text-align: center;">TRANSISTOR</p> 
<p style="text-align: center;">TRANSFORMER (IRON CORE)</p> 	<p style="text-align: center;">VARIABLE CAPACITOR</p> 	<p style="text-align: center;">RECTIFIER (DIODE)</p> 
<p style="text-align: center;">TRANSFORMER (ADJUSTABLE POWDERED IRON CORE) ARROW INDICATES DIR- ECTION OF CORE MOVEMENT TO INCREASE INDUCTANCE</p> 	<p style="text-align: center;">BATTERY</p> 	<p style="text-align: center;">NEON BULB</p> 
<p style="text-align: center;">TRANSFORMER (ADJUSTABLE CORE)</p> 	<p style="text-align: center;">PHONO JACK</p> 	<p style="text-align: center;">ILLUMINATING BULB</p> 
<p style="text-align: center;">POWER TRANS- FORMER</p> 	<p style="text-align: center;">PHONE JACK</p> 	<p style="text-align: center;">METER</p> 
<p style="text-align: center;">INDUCTOR (COIL)</p> 	<p style="text-align: center;">RECEPTACLE</p> 	<p style="text-align: center;">SWITCH (TOGGLE)</p> 
<p style="text-align: center;">PIEZOELECTRIC CRYSTAL</p> 	<p style="text-align: center;">SPEAKER</p> 	<p style="text-align: center;">SWITCH (ROTARY)</p> 
<p style="text-align: center;">BINDING POST</p> 	<p style="text-align: center;">MICROPHONE</p> 	<p style="text-align: center;">FUSE</p> 
<p style="text-align: center;">ANTENNA</p> 	<p style="text-align: center;">EARTH GROUND</p>  <p style="text-align: center;">CHASSIS GROUND</p>	<p style="text-align: center;">CONDUCTORS</p> 

HEATH COMPANY

BENTON HARBOR, MICHIGAN

 *a subsidiary of*
DAYSTROM, INCORPORATED

THE WORLD'S FINEST ELECTRONIC EQUIPMENT IN KIT FORM