

ICOM

INSTRUCTION MANUAL

Radio mods manuals
K B2LJJ

MARINEPLOTTER/SOUNDER

FP-100

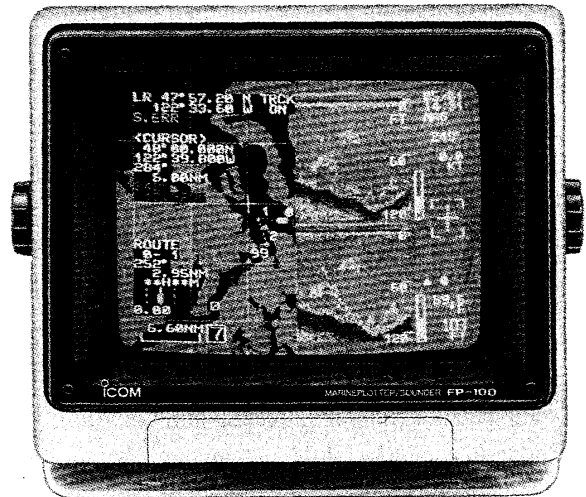

Icom Inc.

GENERAL CAUTION

The FP-100 is a supplemental aid to navigation only and is not intended to be a substitute for accurate and current nautical charts.

DO NOT try to install a transducer by yourself. If a through hull transducer is selected for your boat, have a dealer install it.

DANGER! HIGH VOLTAGE

- **NEVER OPEN THE UNIT**

This product contains high voltages that are FATAL. This product has no user-serviceable parts inside. All repairs and adjustments MUST be made by a qualified electronics technician.

- **HIGH VOLTAGES**

High voltages of up to tens of thousands of volts are used in this equipment. Although prudent measures for safety have been adopted, sufficient care must be taken in the operation, maintenance and adjustment of the equipment.

Electric shock of 1000 volts or more causes electrocution and death; even an electric shock of only 100 volts can be fatal.

- **PREVENTION OF ELECTRIC SHOCK
(FOR QUALIFIED ELECTRONICS TECHNICIAN ONLY)**

To prevent such accidents, turn OFF the power source and do not reach inside until you have: ① discharged capacitors through a wire securely grounded at one end; and ② checked that no electrical charges remain inside the device.

Also, it is safest to wear dry wool gloves. NEVER use both hands simultaneously; keep one hand in your pocket.

IMPORTANT

READ ALL INSTRUCTIONS carefully and completely before using the FP-100.

SAVE THIS INSTRUCTION MANUAL— This instruction manual contains important safety and operating instructions for the FP-100.

FOREWORD

Thank you for purchasing Icom's FP-100 MARINE-PLOTTER/SOUNDER.

The FP-100 consists of both a plotter and sounder. You can use both simultaneously or separately on either the supplied 10 inch color CRT or on an external CRT.

If you have any questions regarding the operation of the FP-100, contact your nearest authorized Icom Dealer or Service Center.

EXPLICIT DEFINITIONS

The following explicit definitions apply to this instruction manual.

WORD	DEFINITION
WARNING	Personal injury, fire hazard or electrical shock may occur.
CAUTION	Equipment damage may occur.
NOTE	If disregarded, inconvenience only. No personal injury, fire hazard or electrical shock will occur.

PRECAUTIONS

NEVER let metal, wire or other objects touch any internal part of the FP-100.

NEVER place the FP-100 within the reach of children.

NEVER expose the FP-100 to rain, salt water or any other liquids.

NEVER connect the FP-100 to AC or more than 40 V DC. This will damage the FP-100.

AVOID using the FP-100 near any magnetic materials, such as a loudspeaker or a large power transformer, as this can cause distortion to the CRT screen.

AVOID placing the FP-100 near heating equipment or in direct sunlight or where hot or cold air blows directly onto it.

AVOID using the FP-100 in areas where the temperature is over + 50 °C or under 0 °C .

AVOID using strong agents such as benzine or alcohol for cleaning the FP-100 as they may damage the surfaces.

UNPACKING

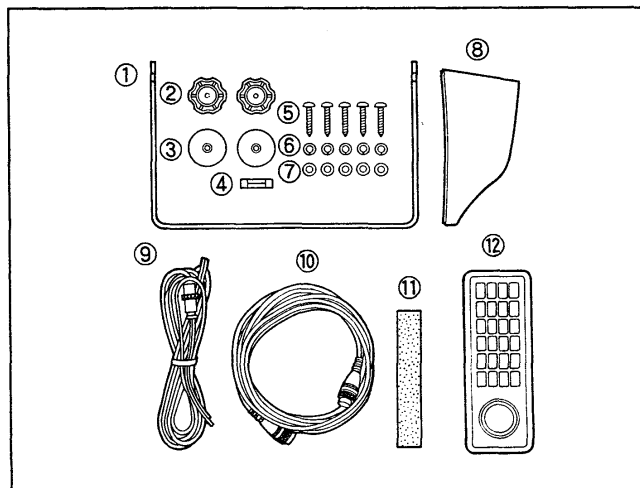

Accessories included with the FP-100:	Qty.
① Mounting bracket	1
② Mounting knobs	2
③ Rubber washers	2
④ Spare fuse (10 A)	1
⑤ Self-tapping screws (M6 x 30)	5
⑥ Spring washers (M6)	5
⑦ Flat washers (M6)	5
⑧ Viewing hood	1
⑨ DC power cable (OPC-275)	1
⑩ Remote controller cable (OPC-321)	1
⑪ Sponge	1
⑫ Remote controller	1

TABLE OF CONTENTS

GENERAL CAUTION	i	3 PLOTTER OPERATION	11 ~ 48
DANGER! HIGH VOLTAGE	i	3-1 Selecting plotter mode	11 ~ 16
IMPORTANT.....	ii	■ Plotter mode	12
FOREWORD	ii	■ Plot screen	13
EXPLICIT DEFINITIONS	ii	■ Navigation monitor screen	14
PRECAUTIONS	ii	■ GPS monitor screen	15
UNPACKING	ii	■ Loran-C monitor screen	16
TABLE OF CONTENTS	iii ~ iv	3-2 Chart operation	17 ~ 22
BEFORE OPERATION	v ~ vi	■ Changing the chart scale	17
		■ Moving the chart	18
		■ Memorizing a chart into the FP-100 memory	19
1 PANEL DESCRIPTION	1 ~ 5	■ Selecting the navigation receiver	20
■ Front panel and remote controller	1	■ Selecting the position data method.....	20
■ Display explanation	3	■ Various indications	21
		■ Distance measurement	22
2 FIRST APPLYING POWER	6 ~ 10	3-3 Track operation	23 ~ 24
2-1 Notice	6	■ Track indication	23
2-2 Initial setting in the set mode	7	■ Track color selection	23
2-3 Initial setting for chart	8	■ Plotting interval	24
2-4 Initial setting for GP-2000	9	■ Erasing the track	24
2-5 Initial setting for RX-1203	10	3-4 Event mark	25 ~ 28
		■ Programming event marks	25
		■ Erasing event marks or changing event type, color and comment	27
		■ Listing-up event marks	28
		3-5 Navigation function	29 ~ 41
		■ Function description	29
		■ Programming waypoints	29
		■ Erasing waypoints	31
		■ Changing waypoint comment and Lat/Lon data	32
		■ Destination navigation (Basic navigation)	33
		■ Programming, erasing and reprogramming routes	37
		■ Route navigation	38
		■ External navigation	41
		3-6 Plotter alarms	42
		■ Alarm types	42
		■ Alarm setting	42
		3-7 RAM card	43 ~ 44
		3-8 GPS data correction	45
		3-9 Loran-C data correction	46 ~ 48

4 SOUNDER OPERATION	49 ~ 72	5 COMMON FUNCTIONS	73 ~ 78
4-1 Selecting sounder mode	49 ~ 56	■ Screen memory	73
■ Sounder mode	50	■ Key illumination	74
■ Compulsory settings	51	■ Trip log	74
■ Basic screen	53	■ Heading data	75
■ Dual screen	54	■ Speed data	75
■ Basic + bottom lock screen	55	■ GPS/Loran-C priority	76
■ Basic + expansion screen	55	■ Positioning correction	76
■ Basic + temperature graph screen	56	■ True or magnetic bearing	77
4-2 Basic settings	57 ~ 59	■ Declination	77
■ Depth range setting	57	■ Built-in simulator	78
■ Phase shift setting	57	■ CRT brightness	78
■ Sensitivity adjustment	58	6 INSTALLATION AND CONNECTIONS ...	79 ~ 82
■ Sensitivity of outer layer adjustment	58	■ System connections	79
■ Frequency selection	59	■ Installation	81
4-3 Advanced settings	60 ~ 62	7 MAINTENANCE	83 ~ 84
■ Depth measuring (VRM).....	60	■ Troubleshooting	83
■ Range of bottom lock	60	■ Preventive maintenance	84
■ Range of expansion	61	■ Fuse replacement	84
■ Period of temperature graph	61	■ Incorrect display	84
■ Auto function	62	■ Backup battery	84
■ Pause function	62	8 MENU MODE CHART	85 ~ 86
4-4 Sounder menus	63 ~ 66	9 SCREEN FLOW CHART	87 ~ 88
■ Interference rejection	63	10 LORAN-C MAP	90
■ Noise reduction	63	11 SPECIFICATIONS	91
■ Display speed setting	64	12 OPTIONS	92
■ Bottom discrimination	64		
■ Display background color	65		
■ Depth scale	65		
■ Data indication	66		
■ Transmit power	66		
4-5 Display interpretation	67 ~ 70		
■ Color bar and time mark	67		
■ Echo from the sea bottom	67		
■ Fish school echos	68		
■ Second echo	68		
■ Plankton and tidal current	69		
■ Thermoclines	69		
■ Aeration	70		
■ Spurious bottom lines by side lobes	70		
4-6 Sounder alarms	71 ~ 72		
■ Alarm types	71		
■ Alarm setting	72		
■ Alarm operation	72		

BEFORE OPERATION

The following descriptions will assist in operation.

• Condition indicator

The condition indicator shows the selected function or condition, or appears when the condition matches a pre-set condition.

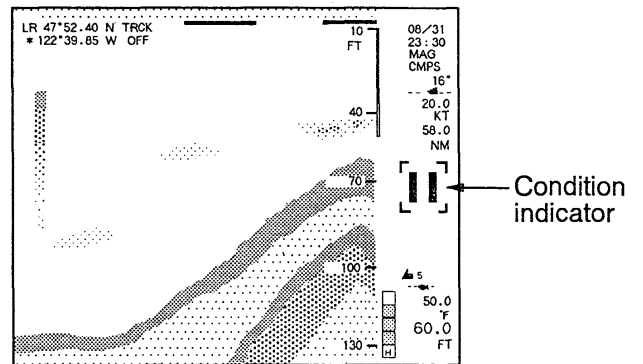
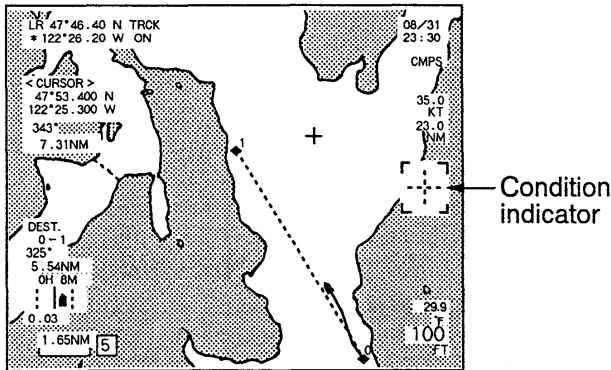

INDICATION	DESCRIPTION	INDICATION	DESCRIPTION
	ERROR INDICATOR Appears with a beep sound when you push a key which is not applicable for the setting, selection or choice.		CENTER INDICATOR Appears when the center function is activated in the plotter mode.
	CURSOR INDICATOR Appears when the cursor is ON in the plotter mode or combination mode.		TRACK ERASING INDICATOR Appears when the track erasing condition is selected in the plotter mode.
	PAUSE INDICATOR Appears when the pause function is activated in the sounder mode or combination mode.		MEMORY INDICATORS - "MR" appears when calling up a screen memory. - "MW" appears when programming a screen memory. - "CL" appears when erasing a screen memory. See p. 73 for details.
	SOUNDER ALARM INDICATORS Appear with alarm beeps when the sea condition matches the pre-set alarm condition. See p. 71 for details.		PLOTTER ALARM INDICATORS Appear with alarm beeps when your vessel position matches the pre-set alarm condition. See p. 42 for details.

• **Data card description**

TYPES OF DATA CARDS

Icom offers 3 types of optional data cards as described below. The ROM cards should be programmed to suit your navigation needs.

EX-1140 ROM CARD	Offers pre-programmed charts. 1 or 2 charts are programmed into each card in the factory.
EX-1141 ROM CARD	Offers pre-programmed charts. Several charts are programmed into each card in the factory.
EX-1142 RAM CARD	Used for programming of displayed track event marks, waypoints and routes. The card has memory space for storing 2 sets of separate data.

DATA CARD PRECAUTIONS

The displayed chart on the screen is only for navigation reference. **USE AN ACTUAL MARINE CHART** when you need to make a decision.

NEVER bend the data card or place any heavy objects on the card.

NEVER throw or drop the data card.

AVOID leaving the data card in a dusty area and **NEVER ALLOW** dust to enter the connector.

Since the usual life of the internal battery of a RAM card is approx. 5 years, your important data such as event marks and routes should be recorded into a notebook.

DATA CARD INSTALLATION

Insert the data card into the card slot straight and smoothly until the card stops with the Icom logo mark upside as shown in the figure at right.

- When a data card is not inserted completely, the card will not operate.

To pull out the data card, pinch the card, then pull the card straight and smoothly.

CAUTION:

NEVER insert or pull out the data card under the following conditions:

- When the center function has been activated.
- While selecting a chart.
- While the displayed chart is moving.
- When reading, programming or erasing the data with a RAM card.

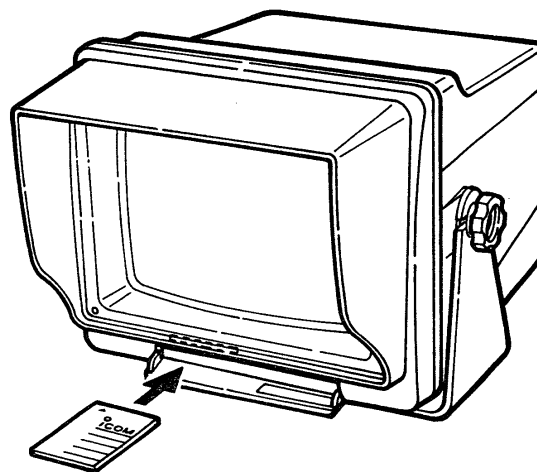

• **Trackball and [△]/[▽] keys**

For function setting, condition selecting, etc. in the menu mode, the trackball is normally used, but the [△] and [▽] keys can be used instead.

NOTE: In this manual, the method for setting or selecting using the [△]/[▽] keys is not described.

• **Cyan letters in the menu mode**

In the menu mode, function names or positioning data, etc. may appear in cyan letters.







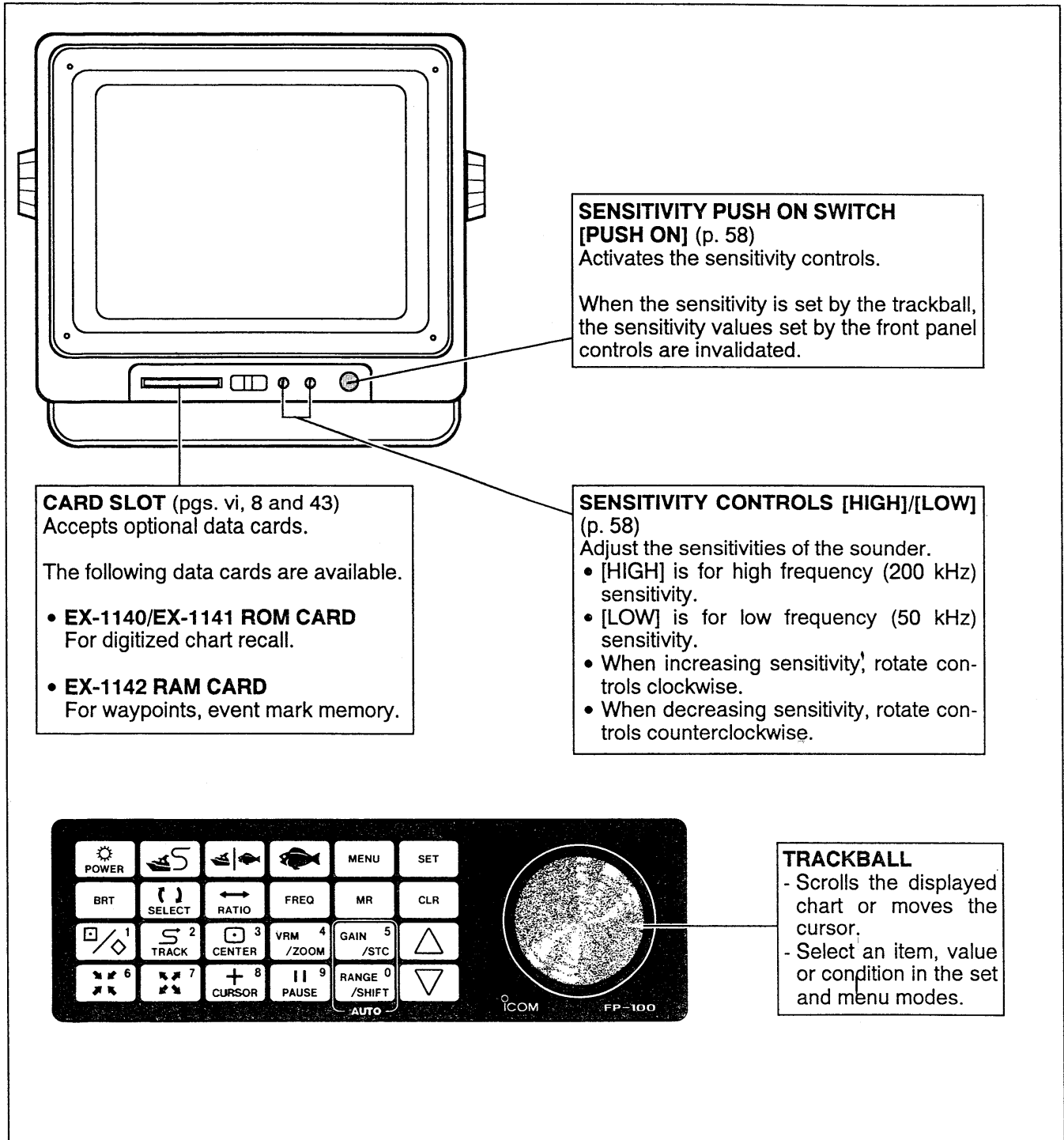











These cyan letters indicate that you **CANNOT** set the function or edit the positioning data, because the function or positioning data will be incorrect if they are reset.

1 PANEL DESCRIPTION

■ Front panel and remote controller



KEY	FUNCTION	Ref. page
	- Turns power ON. - Turns power OFF when pushed for 3 sec.	6
	Sets the CRT brightness level. Use this key together with [▽]/[△]/trackball.	78
	- Programs and clears event marks or waypoints. Use this key together with [SET] and [CLR]. - Selects item number "1" or enters the digit "1" in the menu mode.	25 ~ 35
	- Reduces the scale of the displayed chart. <ul style="list-style-type: none"> • This key continuously changes the chart scale when pushed and held. - Selects item number "6" or enters the digit "6" in the menu mode.	17

KEY	FUNCTION	Ref. page
	- Selects the plotter mode when the sounder mode has been selected. - Selects a screen when the plotter or combination mode has been selected. • Plot screen → Navigation screen → GPS monitor screen → Loran-C monitor screen	11 ~ 12
	- Changes between plot screen 1 and 2 when plot screen has been selected. - Performs as the selecting key in the menu mode. - Changes event type.	12, 17
	- Clears the displayed track. Use this key together with [CLR]. - Selects item number "2" or enters the digit "2" in the menu mode.	24
	- Magnifies the scale of the displayed chart. • This key continuously changes the chart scale when pushed and held. - Selects item number "7" or enters the digit "7" in the menu mode.	17
	Changes between the plotter or sounder mode and the combination mode.	11, 49
	Changes the rate of plot screen to sounder screen in the combination mode.	87
	- Moves the chart with the cursor or vessel position being in the center. • When the cursor is turned off, the vessel is in the center. • When the cursor is on, the cursor is in the center. - Selects item number "3" or enters the digit "3" in the menu mode.	18
	- Turns the cursor ON and OFF. - Selects item number "8" or enters the digit "8" in the menu mode.	25, 29, 33, 40
	- Selects the sounder mode when the plotter mode has been selected. - Selects a screen when the sounder or combination mode has been selected. • Basic screen → Dual screen → Basic + expansion screen → Basic + bottom lock screen → Basic + temperature graph screen	49 ~ 50
	Selects the sounder frequency: High (200 kHz) or Low (50 kHz).	59
	- Displays the variable range marker. - Changes the magnifying rate for the bottom lock and expansion screens when pushing this key for 3 sec. Use this key together with [▽]/[△]/track ball. - Selects item number "4" or enters the digit "4" in the menu mode.	60 ~ 61
	- Pauses the sweep of the sounder display. - Selects item number "9" or enters the digit "9" in the menu mode.	62
	- Selects the MENU mode. - Returns to the previous window in MENU mode.	88
	- Enters the memory call up condition. - Enters the memory program and erase conditions when pushed and held for 3 sec.	73
	- Sets the sensitivity level. Use this key together with [▽]/[△]/trackball. - Sets the STC level when pushed and held for 3 sec. Use this key together with [△]/[▽]/t-ball. - Selects item number "5" or enters the digit "5" in the menu mode.	58
	- Sets the depth range. Use this key together with [▽]/[△]/trackball. - Sets the phase shift of the depth range when pushed and held for 3 sec. Use this key together with [▽]/[△]/trackball. - Selects item number "0" or enters the digit "0" in the menu mode.	57
	- Determines the input data. - Selects a navigation receiver being used, positioning data method and track indication ON/OFF. Use this key together with [▽]/[△].	vi
	- Clears event marks, waypoints and track displayed. - Cancels settings.	-
	- Increases or decreases setting values. - Selects an item in the menu mode. - Selects a screen in the plotter screen window and sounder screen window.	20, 23

1 PANEL DESCRIPTION

■ Display explanation

• Opening screen after the power is ON

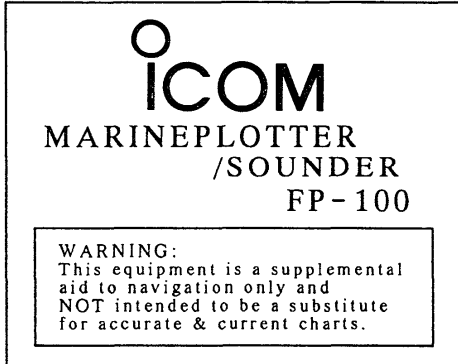

After the power ON, opening screen appears for 10 sec., the previously used screen is automatically selected.

• Set mode screen

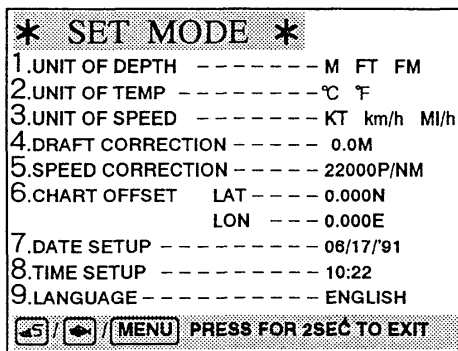

Shows the set mode contents for setting seldom changed variables.

This set mode display can be selected only if the [MENU] key is pushed at power ON. See p. 7 for selecting the set mode.

• Plot screen (Plotter mode)

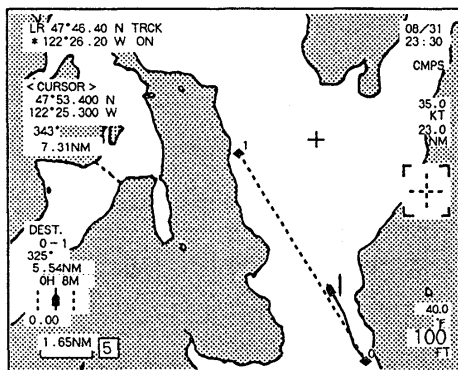

Shows your vessel position and track on an electronic chart.* Also shows waypoints, event marks and selected route.

The FP-100 includes 10 plot screen sizes. In addition, plotter screen 1 and plotter screen 2 are available for instant, often-used size selection. Push the [SELECT] key to change between plot screen 1 and 2.

*An optional ROM card is necessary to display a chart.

• Navigation screen (Plotter mode)

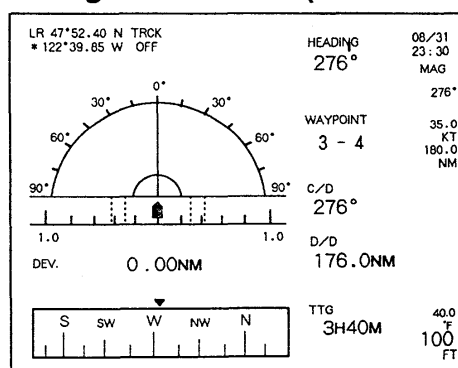

Shows information required for the navigation functions, on one screen, in numerals and graphics.

Almost no indicators and readouts will be displayed when all navigation functions are turned OFF.

• GPS monitor screen (Plotter mode)

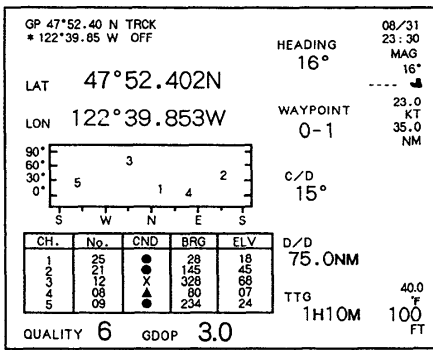

Shows the receiving and setting conditions of an optional GP-2000 GPS RECEIVER UNIT. Almost no readouts will be displayed when the GP-2000 is not connected.

• Loran-C monitor screen (Plotter mode)

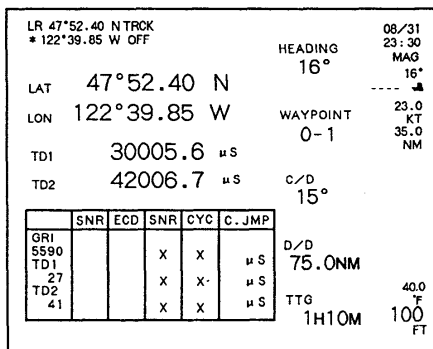

Shows the receiving and setting conditions of an optional RX-1203 LORAN-C RECEIVER UNIT. Almost no readouts will be displayed when the RX-1203 is not installed.

• Basic screen (Sounder mode)

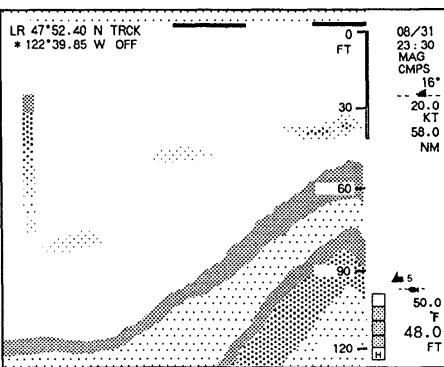

Shows the basic sounder display on the whole screen according to the value of [SHIFT] and [RANGE].

• Dual screen (Sounder mode)

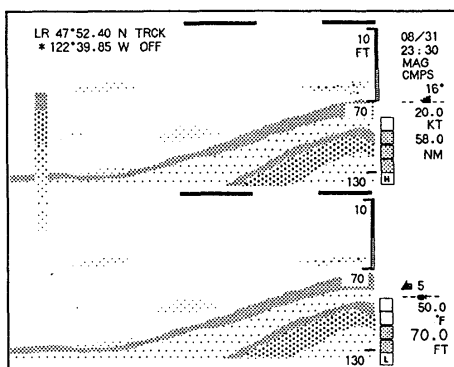

Shows high frequency (200 kHz) and low frequency (50 kHz) displays simultaneously. The display location of the two frequencies are exchanged by the [FREQ] key.

1 PANEL DESCRIPTION

• Basic + bottom lock screen (Sounder mode)

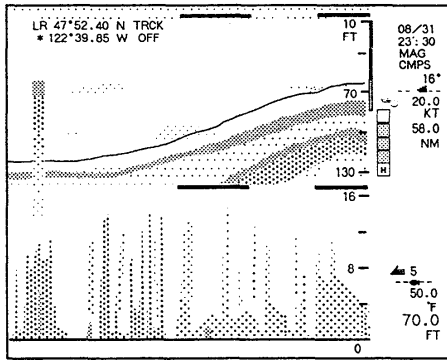

Shows the basic and bottom lock screens simultaneously. This screen is convenient for observing the condition of the sea bottom or investigating fish near the sea bottom.

• Basic + expansion screen (Sounder mode)

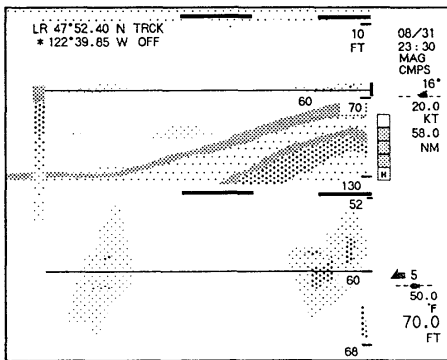

Shows the basic and expansion screens simultaneously. This screen is convenient for observing fish schools, etc.

• Basic + temperature graph screen (Sounder mode)

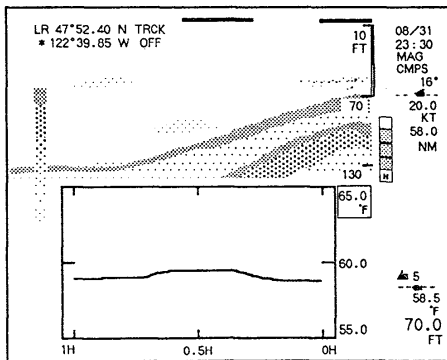

Shows the basic and temperature graph screens simultaneously.

To display the temperature graph, use the EX-1010 THROUGH HULL TYPE TRANSDUCER or connect the EX-983 SPEED/TEMPERATURE SENSOR.

• Combination screen

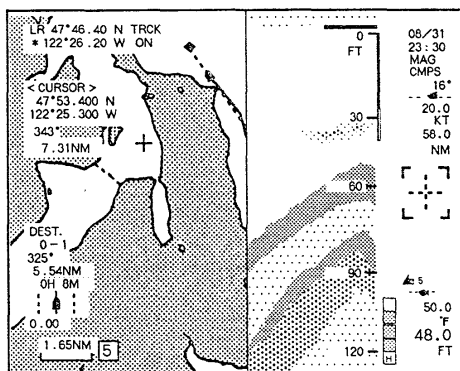

Shows one of the screens in the plotter mode and one of the screens in the sounder mode simultaneously, moreover, the rate of each screen size can be changed in 4 steps.

2-1 Notice

When first applying power, the FP-100 requires several initial settings. Required settings vary depending on the FP-100 operating condition. See the box below for details.

The initial settings are necessary again (except for "2-2 Initial setting in the set mode") when vessel position has changed by more than 60 miles or more than 1 degree while the power was OFF.

CONNECTED NAVIGATION RECEIVER	REQUIRED INITIAL SETTING	
	WITH ROM CARD	WITHOUT ROM CARD
Non-Icom navigation receiver only	2-2 Initial setting in the set mode.	2-2 Initial setting in the set mode.
GP-2000 GPS RECEIVER UNIT only	2-2 Initial setting in the set mode. 2-3 Initial setting for chart. 2-4 Initial setting for GP-2000.	2-2 Initial setting in the set mode. 2-4 Initial setting for GP-2000.
RX-1203 LORAN-C RECEIVER UNIT only	2-2 Initial setting in the set mode. 2-3 Initial setting for chart. 2-5 Initial setting for RX-1203.	2-2 Initial setting in the set mode. 2-5 Initial setting for RX-1203.
GP-2000 GPS RECEIVER UNIT and RX-1203 LORAN-C RECEIVER UNIT.	2-2 Initial setting in the set mode. 2-3 Initial setting for chart. 2-4 Initial setting for GP-2000. 2-5 Initial setting for RX-1203.	2-2 Initial setting in the set mode. 2-4 Initial setting for GP-2000. 2-5 Initial setting for RX-1203.

NOTE: "2-3 Initial setting for chart" MUST be performed before "2-4 Initial setting for GP-2000" and "2-5 Initial setting for RX-1203."

• Power ON/OFF

- 1) When you have optional data cards, read the box on p. vi for data card descriptions before turning power ON.
- 2) Push [POWER] to turn power ON.
 - The opening screen appears for 10 sec., then one of the plotter mode, sounder mode or combination mode is selected.
- 3) To turn power OFF, push and hold [POWER] for 3 sec.

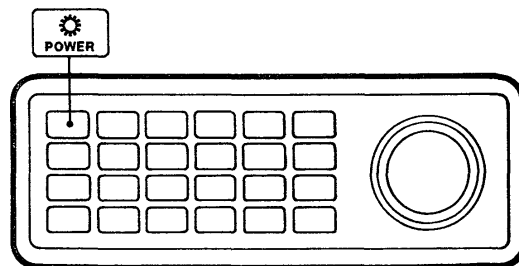

NOTE: While the opening screen is displayed, you can change the CRT brightness by rotating the track ball vertically without pushing [BRT].

2-3 Initial setting for chart

The initial setting for the chart is necessary when you use the FP-100 with an optional GP-2000 or RX-1203, and a ROM card.

This setting is not necessary when you do not use an optional ROM card.

- 1) Make sure the center function is NOT activated.
 - "⊙" is not displayed.
- 2) Push [MENU] to select the menu mode.
- 3) Select "DATA CARD" by rotating the trackball vertically; then, push [SET].
 - Pushing [6] also performs this function.
 - The data card menu window appears.
- 4) Insert your ROM card into the card slot.
- 5) Select "CHART MEMORY" by rotating the trackball vertically; then, push [SET].
 - Pushing [1] also performs this function.
 - "CHART MEMORY" turns green.
- 6) Rotate the trackball horizontally to select "MANU"; then, push [SET].
 - The chart select window appears.
- 7) Rotate the trackball vertically to select the desired chart; then, push [SET].
 - "CHART MEMORY" turns yellow.
- 8) Push [SET] again.
 - Pushing [1] also performs this function.
 - "CHART MEMORY" turns green again.
- 9) Rotate the trackball horizontally to select "AUTO"; then, push [SET].
 - "CHART MEMORY" turns yellow again.
- 10) You can pull out the ROM card if you desire.
 - When the ROM card is pulled out, only the selected chart can be used for FP-100 operation.
- 11) Push [←5] or [←6] to exit the menu mode.

NOTE 1: Selected chart may not appear until the section 2-4 Initial setting for GP-2000 (p. 9) or 2-5 Initial setting for RX-1203 (p. 10) is complete.

NOTE 2: "AUTO" and "MANU" in "CHART MEMORY" are also used for memorizing a chart into the FP-100. See p. 19 for details.

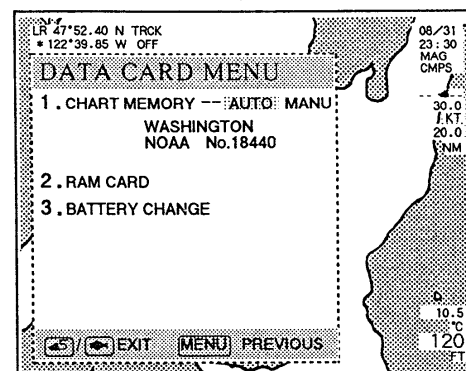
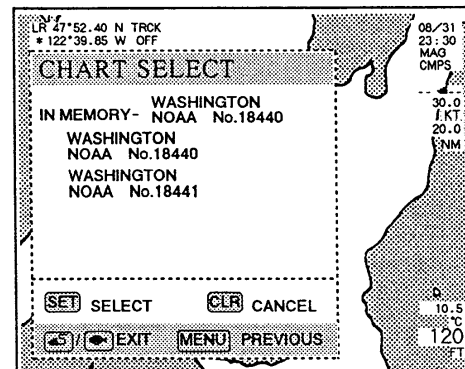
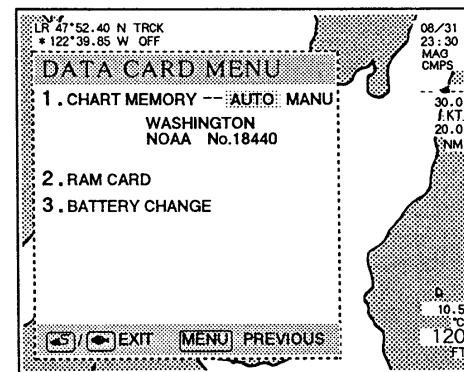
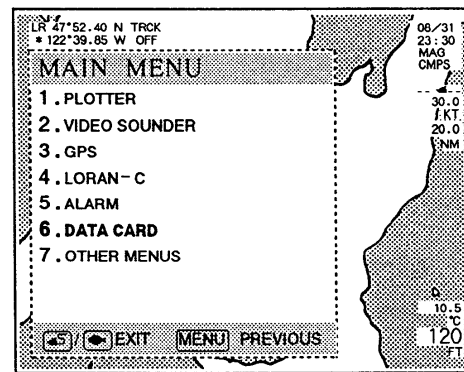

2-4 Initial setting for GP-2000

The initial setting for the GP-2000 is necessary when you use the FP-100 with an optional GP-2000 GPS RECEIVER UNIT.

NOTE: Initial settings in the GP-2000 itself are necessary before the FP-100 can be initialized. See the GP-2000 instruction manual for details.

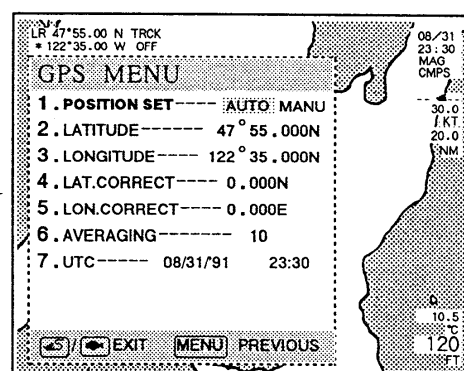
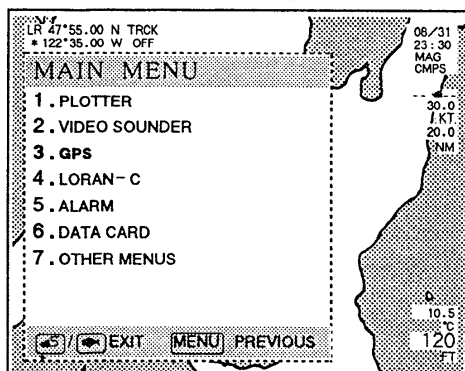

• When using an optional ROM card

- 1) Perform the initial setting for chart described on p. 8.
- 2) Push [MENU] to select the menu mode.
- 3) Make sure the ROM card has been inserted.
 - If it is not inserted, insert it into the card slot.
- 4) Select "GPS" by rotating the trackball vertically; then, push [SET].
 - Pushing [3] also performs this function.
 - The GPS menu window appears.
- 5) Select "POSITION SET" by rotating the trackball vertically; then, push [SET].
 - Pushing [1] also performs this function.
 - "POSITION SET" turns green.
- 6) Select "AUTO" by rotating the trackball horizontally; then push [SET].
 - "POSITION SET" turns yellow.
- 7) Make sure the UTC is correct.
 - If the UTC is wrong, set the UTC by the trackball and [SET].
- 8) Push [←5] or [→5] to exit the menu mode.
- 9) Push [⌘] or [⌘] to display the chart.

• When not using an optional ROM card

- 1) Push [MENU] to select the menu mode.
- 2) Select "GPS" by rotating the trackball vertically; then, push [SET].
 - Pushing [3] also performs this function.
 - The GPS menu window appears.
- 3) Set items in the GPS menu window using the trackball and [SET].
 - Refer to the diagram below.
- 4) After setting is complete, push [←5] or [→5] to exit the menu mode.

GPS menu window items

No.	ITEM	SETTING
1	POSITION SET	Select "MANU" when not using a data card.
2	LATITUDE	Enter Lat/Lon data which are exact to within 1 degree . Once satellite data is caught, Lat and Lon data are corrected automatically.
3	LONGITUDE	
4	LAT.CORRECT	
5	LON.CORRECT	No need to set. See p. 45 for explanation and setting.
6	AVERAGING	
7	UTC	Enter UTC (Universal Time Coordinate) data which are exact to within 30 min. Once satellite data is acquired, UTC is corrected automatically.

2-5 Initial setting for RX-1203

The initial setting for the RX-1203 is necessary when you use the FP-100 with an optional RX-1203 LORAN-C RECEIVER UNIT.

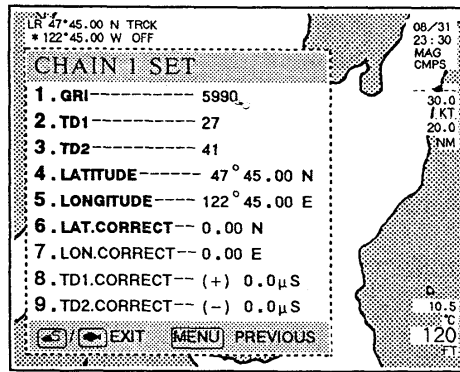
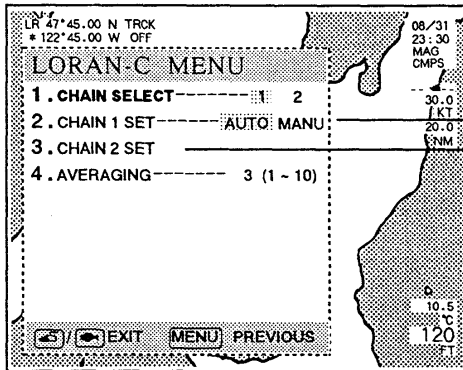

CHAIN 2 SETTING DISPLAY
Same contents as the chain 1 setting display.

• When using an optional ROM card

- 1) Perform the initial setting for chart. (p. 8)
- 2) Push [MENU] to select the menu mode.
- 3) Make sure the ROM card has been inserted.
 - If it is not inserted, insert it into the card slot.
- 4) Select "LORAN-C" by rotating the trackball vertically; then, push [SET].
 - Pushing [4] also performs this function.
 - The Loran-C menu window appears.
- 5) Select "CHAIN SELECT" by rotating the trackball vertically; then, push [SET].
 - Pushing [1] also performs this function.
 - "CHAIN SELECT" turns green.
- 6) Select "1" by rotating the trackball horizontally; then, push [SET].
 - "CHAIN SELECT" turns yellow.
- 7) Select "CHAIN 1 SET" by rotating the trackball vertically; then, push [SET].
 - Pushing [2] also performs this function.
 - "CHAIN 1 SET" turns green.
- 8) Select "AUTO" by rotating the trackball horizontally; then, push [SET].
 - "CHAIN 1 SET" turns yellow.
- 9) Push [←5] or [←] to exit the menu mode.
- 10) Push [⏏] or [⏏] to display the chart.

• When not using an optional ROM card

- 1) Push [MENU] to select the menu mode.
- 2) Select "LORAN-C" by rotating the trackball vertically; then, push [SET].
 - Pushing [4] also performs this function.
 - The Loran-C menu window appears.
- 3) Set items in the Loran-C menu window and chain 1 or chain 2 setting window using the trackball and [SET].
 - Refer to the diagrams below.
- 4) After setting is complete, push [←5] or [←] to exit the menu mode.

Loran-C menu window items

No.	ITEM	SETTING
1	CHAIN SELECT	Select "1" or "2."
2	CHAIN 1 SET	Select "MANU," then perform chain 1 setting as described in the box at right.
3	CHAIN 2 SET	Perform the chain 2 setting as described in the box at right.
4	AVERAGING	No need to set. See p. 48 for explanation and setting.

Chain 1 and 2 setting window items

No.	ITEM	SETTING
1	GRI	Enter the main station's number.
2	TD1	Enter the sub 1 station's number.
3	TD2	Enter the sub 2 station's number.
4	LATITUDE	Enter Lat/Lon data which are exact to within 1 degree.
5	LONGITUDE	
6	LAT.CORRECT	No need to set. See pgs. 46 - 47 for explanation and setting.
7	LON.CORRECT	
8	TD1.CORRECT	
9	TD2.CORRECT	

3 PLOTTER OPERATION

3-1 Selecting plotter mode

To display the digitized chart on a plot screen, an optional ROM card is necessary.

If an optional GP-2000 GPS RECEIVER UNIT or RX-1203 LORAN-C RECEIVER UNIT has been installed, the receiver requires initial settings again when vessel position has changed by more than 60 miles or more than 1 degree while the power was OFF. See pgs 9 ~ 10 for details.

Push [POWER] to turn power ON.

- See p. 6 for details.
- Either the plotter mode, sounder mode, or combination mode screen will appear depending on what screen was selected before the power was turned OFF.



Power ON

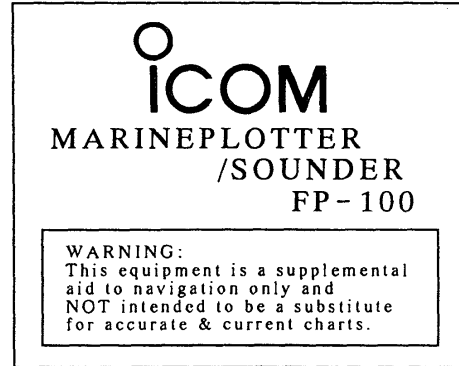

Opening display

PLOTTER

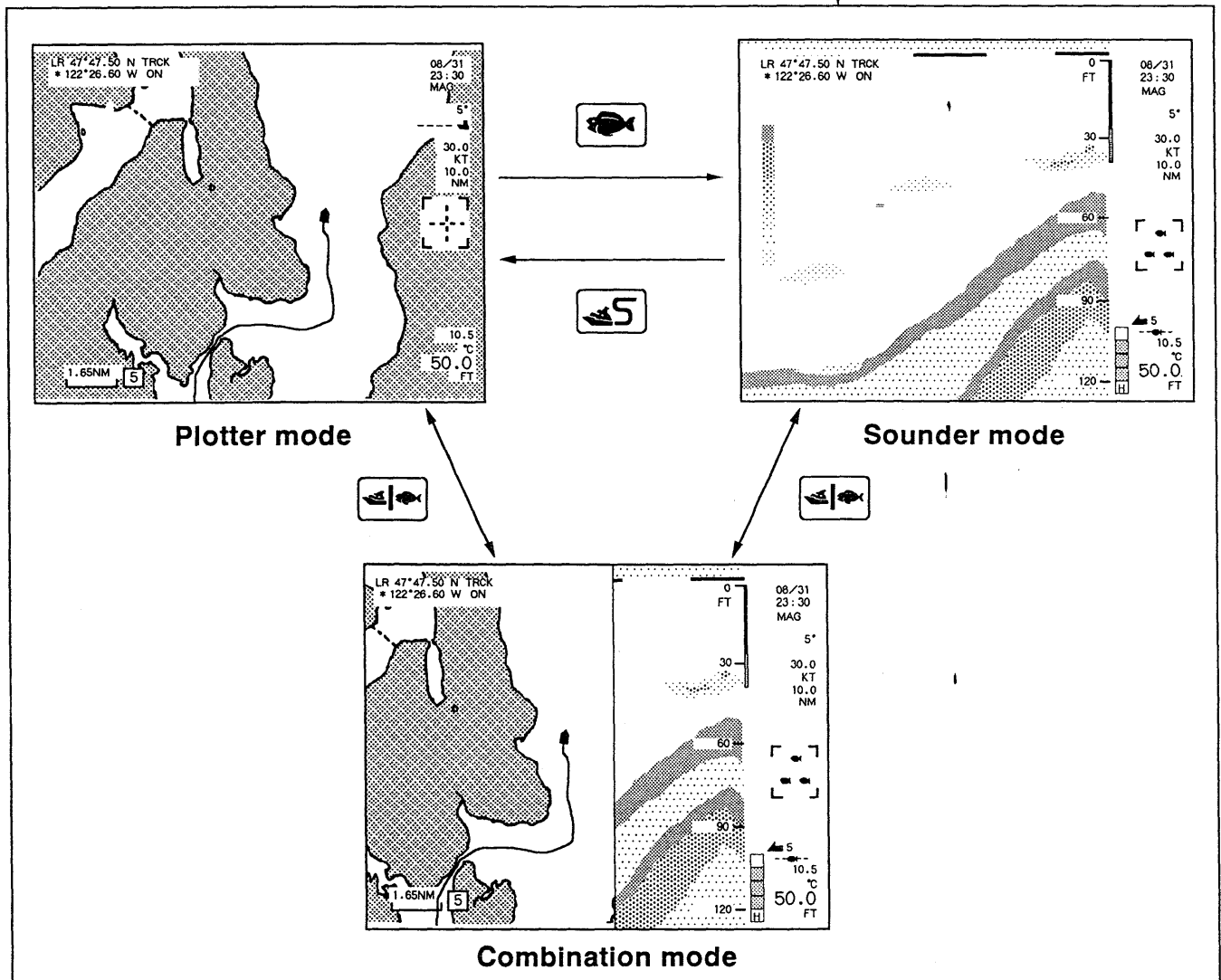

Plotter mode

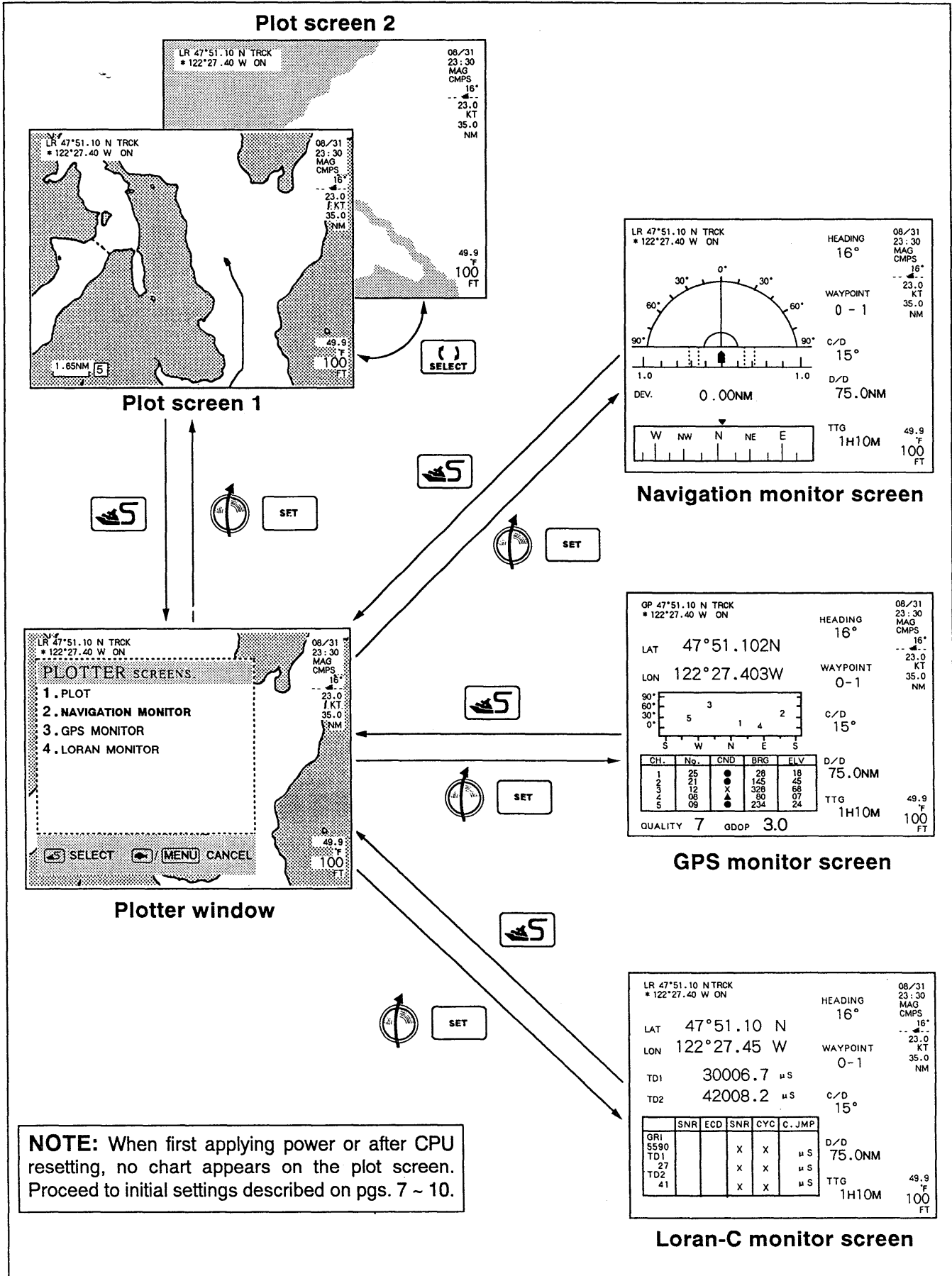

Plot screen

PLOTTER

NAVIGATION INDICATORS
(pgs. 34 and 39)

1 NAVIGATION RECEIVER INDICATOR (p. 20)
Displays navigation receiver being used.

2 POSITIONING DATA ERROR INDICATOR
"S.ERR" appears when the positioning equipment sends error signals.

"R.ERR" appears when the FP-100 cannot receive positioning data for more than 10 sec.

3 CURSOR POSITION READOUT
Appears when using a cursor. Shows cursor position in Lat/Lon and bearing/distance from your vessel when the cursor is ON.

4 DISTANCE MEASUREMENT READOUT (p. 22)
Shows the bearing/distance from the red cursor to blue cursor when the function is ON.

5 CHART SCALE READOUT (p. 21)
Shows the chart scale or distance.

6 CHART SCALE NUMBER (p. 17)
Shows the chart scale in 10 steps, "0" ~ "9." "0" is the highest magnification.

7 WATER DEPTH READOUT
Shows the water depth.

8 WATER TEMPERATURE READOUT
Shows the water temperature.
• When using the EX-1010 or the EX-983. (p. 92)

9 CONDITION INDICATOR (p. v)
Shows the condition. See p. v for details.

10 TRIP LOG READOUT (p. 74)
Shows the trip log.

11 VESSEL SPEED READOUT (p. 75)
Shows the vessel speed. The boat character moves corresponding to your vessel speed.

12 HEADING READOUT (p. 75)
Shows the vessel heading.
"CMPS" appears when compass is selected as a heading data source.

13 MAGNETIC BEARING INDICATOR (p. 77)
Appears when magnetic bearing is selected.

14 DATE/TIME READOUT (p. 7)
Shows date and time.

15 TRACK ON/OFF INDICATOR (p. 23)
Shows the track function condition.

16 VESSEL POSITION READOUT (p. 20)
Shows your vessel position in Lat/Lon or TD.

Navigation monitor screen

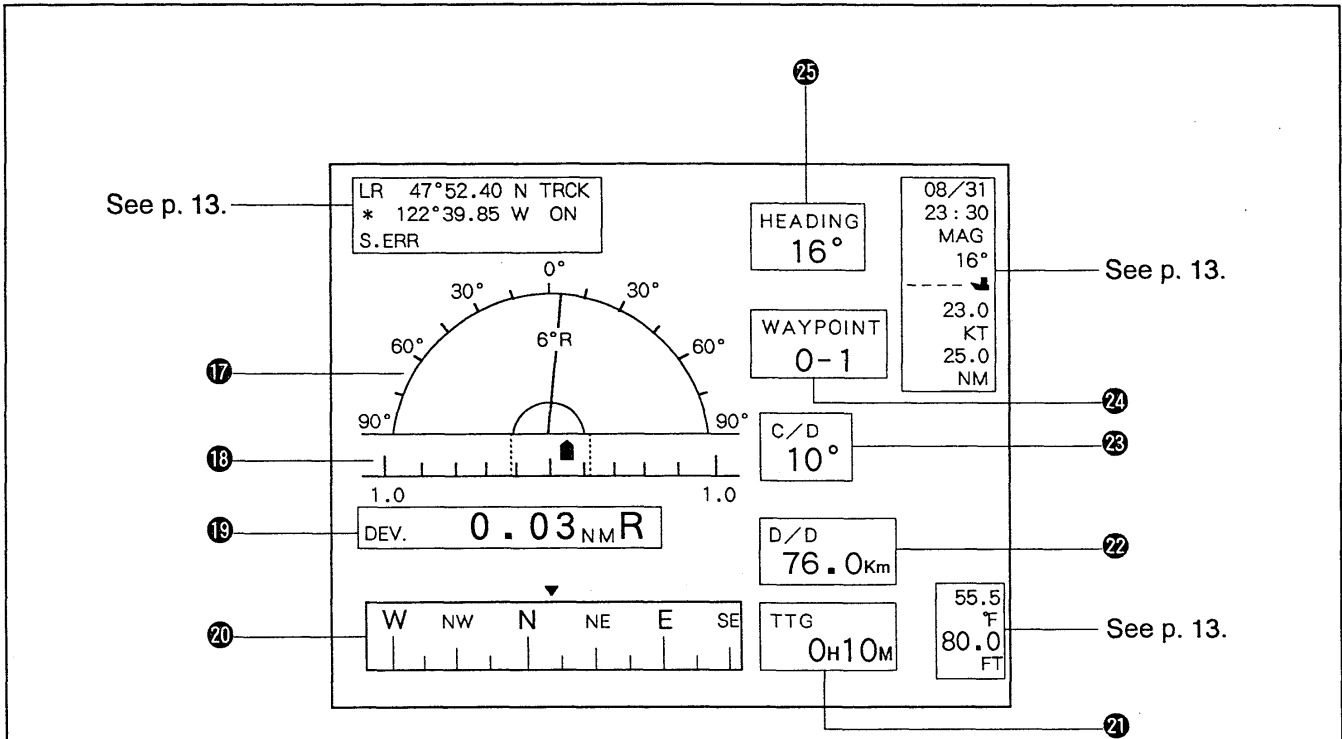

17 COURSE INDICATOR

Shows the course direction to the target waypoint graphically.

18 COURSE DEVIATION INDICATOR

Shows alarm range from the selected navigation course.

- The green dotted lines show the course out alarm range.
- The red dotted lines show the course in alarm.
- When the course out and course in alarms are set to the same range, only yellow lines appear.

19 COURSE DEVIATION READOUT

Shows distance from the selected navigation course.

20 COMPASS

Shows your vessel heading graphically.

21 TTG (TIME TO GO) READOUT

Shows the expected time to the target waypoint.

22 D/D (DISTANCE TO DESTINATION) READOUT

Shows the distance to the target waypoint.

23 C/D (COURSE TO DESTINATION) READOUT

Shows the direction to the target waypoint.

24 WAYPOINT READOUT

Shows the course. (e.g. 0-1 shows that the selected course is from waypoint 0 to waypoint 1.)

25 HEADING READOUT (p. 75)

Shows the vessel heading.

- The same value as "Heading readout" (11 on p. 13).

PLOTTER

■ GPS monitor screen

PLOTTER

GP 47°52.401N TRCK
* 122°39.852W OFF
S.ERR

LAT 47°52.401N
LON 122°39.852W

CH.	No.	CND	BRG	ELV
1	25	●	28	18
2	21	●	145	45
3	12	X	328	68
4	08	▲	80	07
5	09	●	234	24

QUALITY 7 GDOP 3.0

HEADING 16°

WAYPOINT 0-1

C/D 10°

D/D 76.0Km

TTG 0H10M

08/31
23:30
MAG 16°
23.0 KT
56.0 NM
55.5 °F
100 FT

26 VESSEL POSITION READOUT
Indicates your vessel position in Lat/Lon.

27 SATELLITE POSITION INDICATORS
Shows all watched satellite positions. The numbers indicate channel numbers of the GP-2000.

- When the satellite is tracked, the color of the each indicator color is changed.

28 SATELLITE RECEIVING CONDITION READ-OUT
"CH." shows the channel number of an optional GP-2000 GPS RECEIVER.

- When a channel acquires the satellite, the color of the channel number is changed.

"No." shows the satellite number.

"CND" shows tracking condition of satellites by the following symbols:

- "○": The satellite is tracked completely, and navigation data is being taken.
- "▲": The satellite is being tracked.
- "X": The satellite has not be tracked yet or cannot be tracked.

"BRG" shows the bearing (azimuth angle) of the satellite.

"ELV" shows the elevation angle of the satellite.

29 QUALITY READOUT
Indicates quality of received satellite signals from "0" ~ "9." The higher the number, the higher the quality.

30 GDOP READOUT
Shows GDOP value for checking satellite conditions. The lower the values, the better the condition.

Loran-C monitor screen

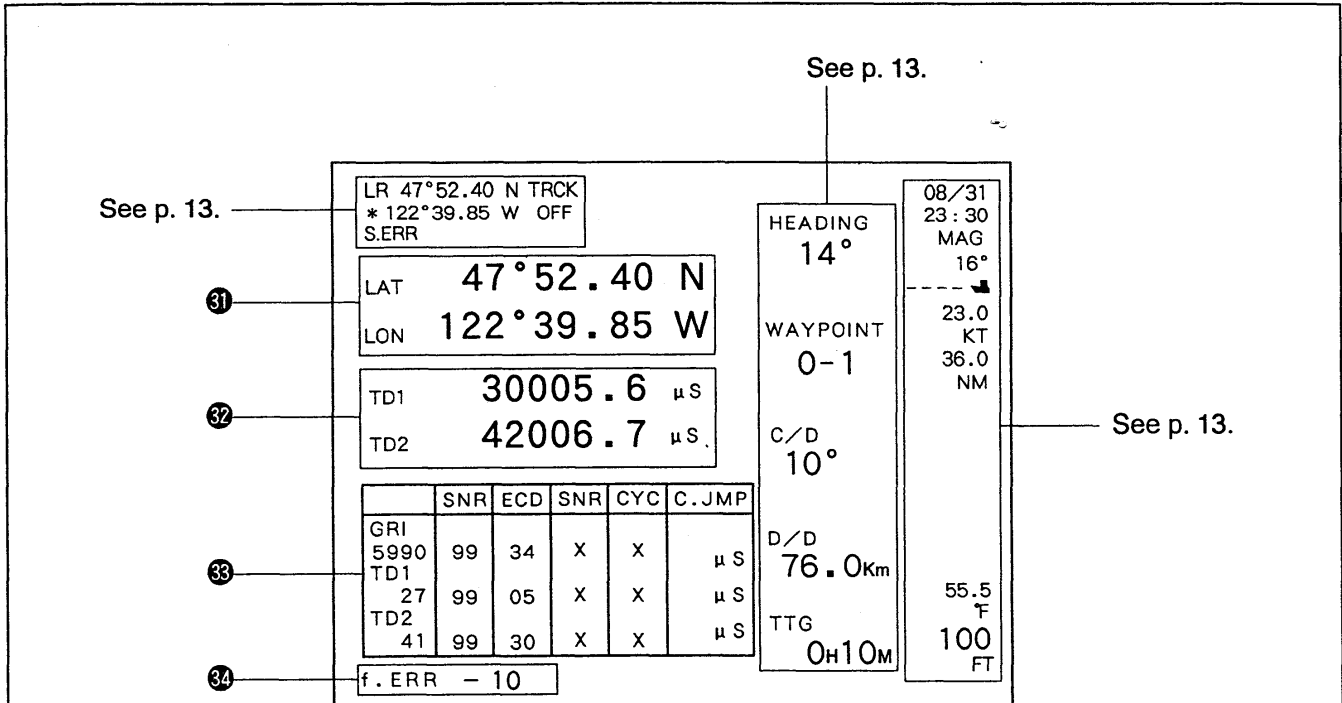

31 VESSEL POSITION READOUT

Indicates your ship position in Lat/Lon.

- The readout flashes when location data differs more than 1 min. from the GP-2000 (optional) data and the GP-2000 is selected as a navigation receiver.

32 TIME DELAY READOUT

Indicates the delay time of selected slave stations (TD1 and TD2).

33 LORAN-C RECEIVING CONDITION READOUT (p. 48)

Left "SNR" shows the signal-to-noise levels from the selected Loran-C stations. "X" appears in the right "SNR" when these levels are too low.

"ECD" shows the envelope-to-cycle discrepancy level of the selected Loran stations.

In the "CYC" column "X" appears when the ECD levels are unacceptable.

"C.JMP" is used to select the cycle jump for correcting Loran-C data with another cycle.

34 FREQUENCY ERROR READOUT

Shows the Loran-C receiver's, reference oscillator, off frequency.

NOTE: If the readout shows - 50 ~ - 128 or + 50 ~ + 128, frequency adjustment is necessary. Ask your dealer for details.

3-2 Chart operation

Changing the chart scale

The FP-100 has 2 kinds of plot screens, plot screen 1 and 2, moreover each screen can be set to 10 different scales for your convenience.

KEY	FUNCTION
⇐⇐	Magnifies the chart scale.
⇒⇒	Reduces the chart scale.
SELECT	Exchanges plot screen 1 and 2.

WHEN THE CURSOR IS DISPLAYED:

When the chart is magnified or reduced, the chart is shifted to indicate the cursor position in the center.

WHEN THE CURSOR IS NOT DISPLAYED:

When the chart is magnified or reduced, the chart is shifted to indicate the vessel position in the center.

PLOT SCREEN 1

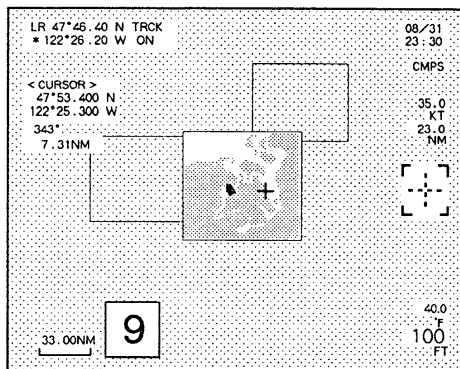

When chart scale "9" is selected, other charts' frames may appear depending on the inserted ROM card.

In this case, you can select another chart manually with the cursor and [CENTER] key.

PLOT SCREEN 2

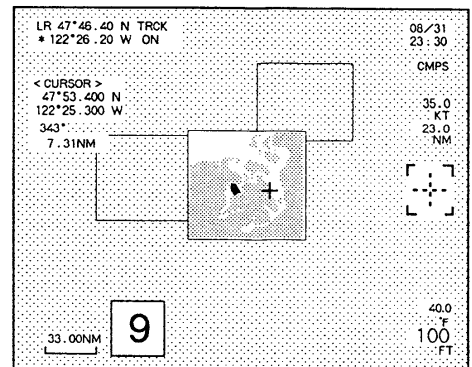

PLOTTER

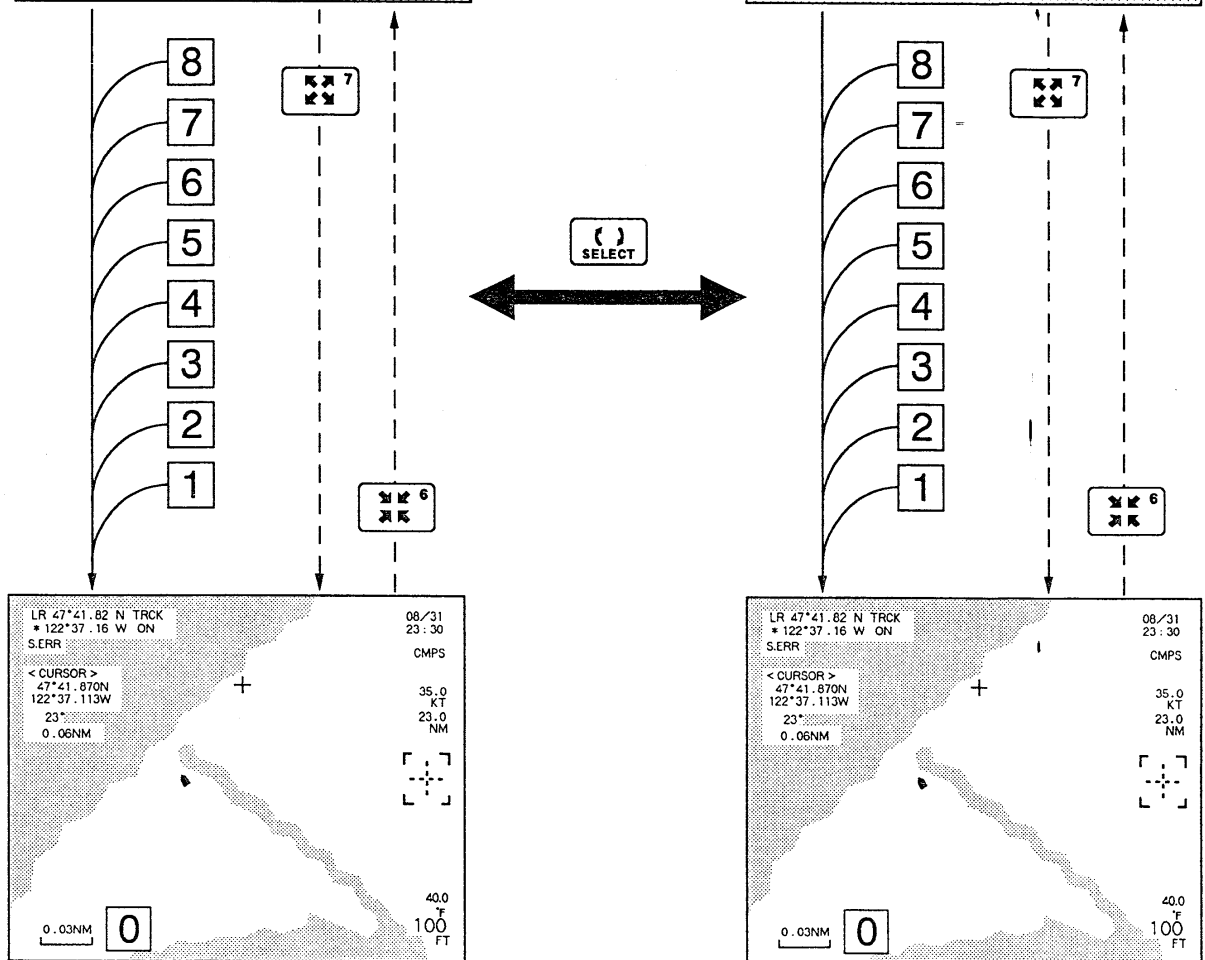

Moving the chart

The displayed chart can be shifted to view a desired area. Select one of the following methods: (If the ROM card has more than 1 chart, the next chart is automatically selected when your vessel goes beyond the displayed chart.)

- ① When the cursor is not displayed, rotate the trackball to shift the displayed chart.

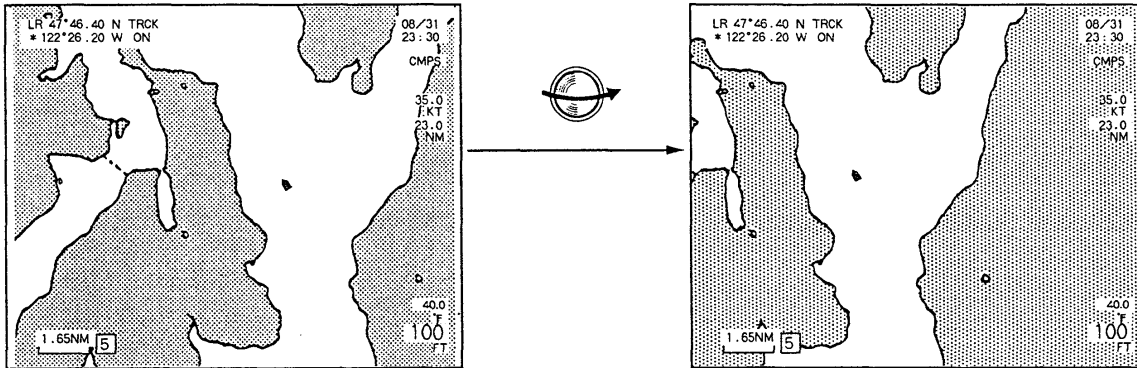

- ② When the cursor is displayed, set the cursor position to your desired centering position, and then push [CENTER].

- The chart is shifted to indicate the cursor position in the center.
- [↔] and [↕] also shift the chart.

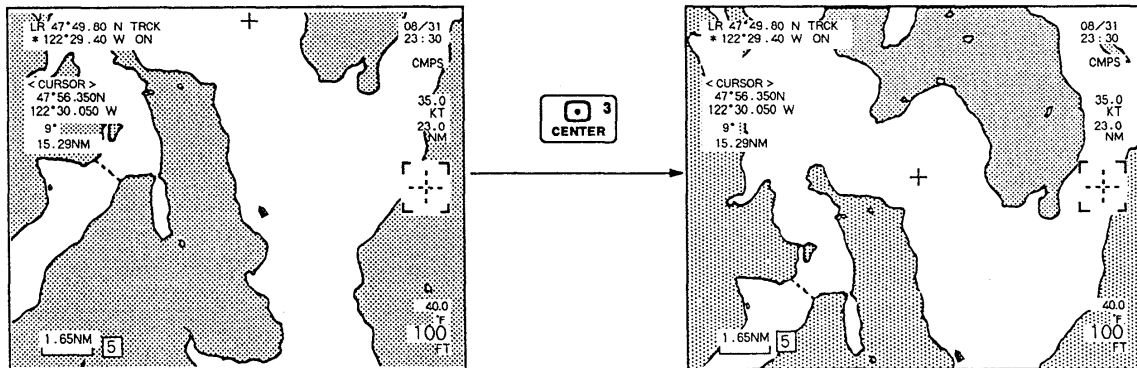

- ③ When the cursor is not displayed, push [CENTER] to activate the center function.

- "□" appears.
- The chart will move with the vessel position always remaining in the center.
- To turn OFF the center function, push [CENTER] again.

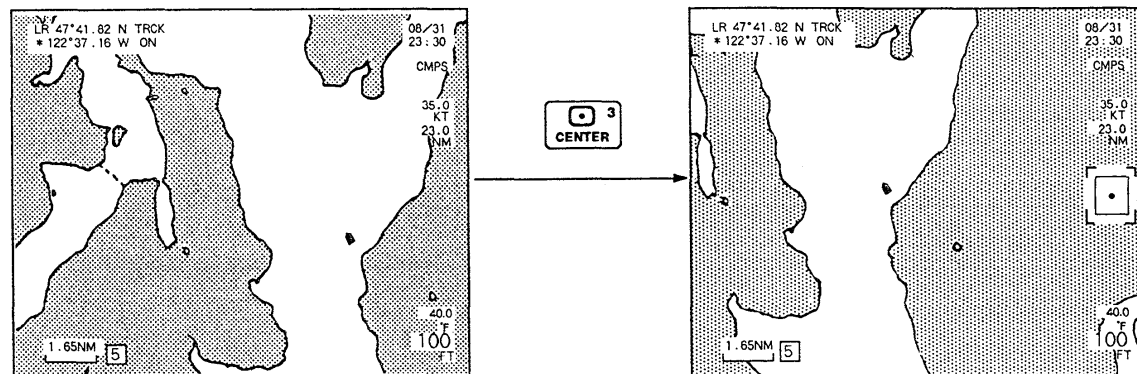

PLOTTER

Memorizing a chart into the FP-100 memory

Once the chart is memorized into the FP-100, the chart is backed up and is displayed on a screen

even if the ROM card is pulled out.

• Auto memorization

When a new chart is selected on a plot screen, the chart is automatically memorized into the FP-100 memory.

- 1) Push [MENU] to select the menu mode.
- 2) Select "DATA CARD" by rotating the trackball vertically; then, push [SET].
 - Pushing [6] also performs this function.
 - The data card menu window appears.
- 3) Select "CHART MEMORY" by rotating the trackball vertically; then, push [SET].
 - Pushing [1] also performs this function.
 - "CHART MEMORY" turns green.

- 4) Rotate the trackball horizontally to select "AUTO"; then, push [SET].
 - Auto memorization is selected.
- 5) Push [←5] or [←] to exit the menu mode.

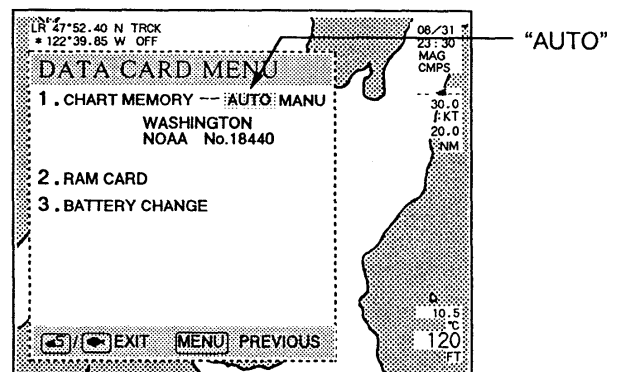

• Manual memorization

Even when a new chart is selected on a plot screen, the chart is not memorized into the FP-100 memory. Memorization in the menu mode is necessary.

- 1) Push [MENU] to select the menu mode.
- 2) Select "DATA CARD" by rotating the trackball vertically; then, push [SET].
 - Pushing [6] also performs this function.
 - The data card menu window appears.
- 3) Make sure the ROM card is inserted.
 - If it is not inserted, insert it into the card slot.
- 4) Select "CHART MEMORY" by rotating the trackball vertically; then, push [SET].
 - Pushing [1] also performs this function.
 - "CHART MEMORY" turns green.
- 5) Rotate the trackball horizontally to select "MANU"; then, push [SET].
 - The manual memorization is selected and the chart window appears.
- 6) Rotate the trackball vertically to select the desired chart; then push [SET].
 - "CHART MEMORY" turns yellow and the selected chart is memorized in the FP-100 memory.
- 7) Push [←5] or [←] to exit the menu mode.

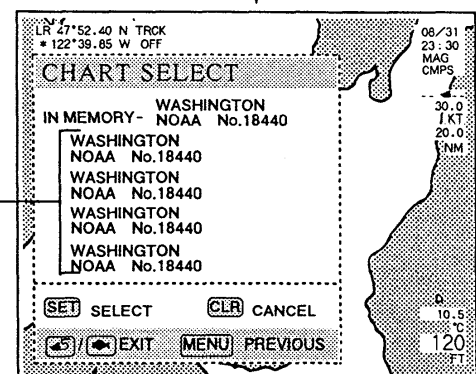
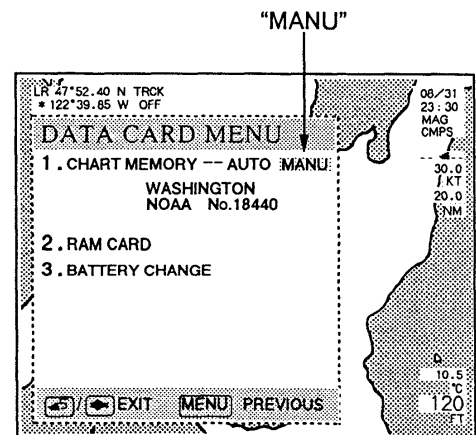

The chart names in the inserted ROM card appear.

Selecting the navigation receiver

When more than one navigation receiver, such as both the GP-2000 and RX-1203, are connected to the FP-100, you can designate which data to display or select dual watch navigation.

- 1) Push [SET].
 - "GP," "LR" or "EX" for navigation receiver indicator turns green.
- 2) Push [Δ]/[∇] to select the desired data source for display.
 - "LR" shows that data from the RX-1203 is adopted.
 - "GP" shows that data from the GP-2000 is adopted.
 - "EX" shows that data from other navigation equipment is adopted.
 - "*" shows the dual watch navigation is activated.
- 3) Push [SET] three times.

DUAL WATCH NAVIGATION

The navigation receiver, the GP-2000 or RX-1203, is automatically designated depending on the GPS/Loran-C priority (p. 76). When data from the high priority navigation receiver is interrupted, the low priority navigation receiver is selected. If the data from both the GP-2000 and RX-1203 are interrupted, the external navigation receiver is selected.

Navigation receiver indicator

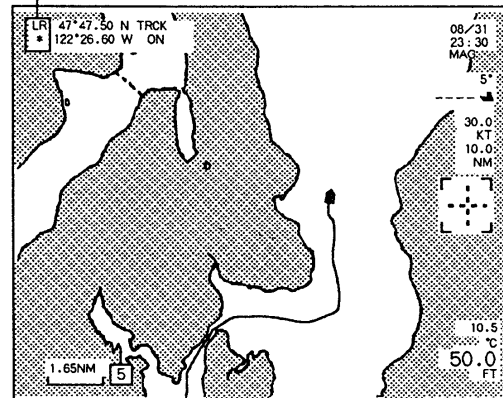

PLOTTER

Selecting the position data

You can select the data for vessel position from Lat/Lon indication or TD (time delay) indication when an optional RX-1203 LORAN-C RECEIVER UNIT is installed.

- 1) Push [SET] twice.
 - Position indication turns green.
- 2) Push [Δ]/[∇] to select the desired data for position indication.
- 3) Push [SET] twice.

NOTE 1: Even when GPS data is adopted as a positioning data source, TD indication can be selected. In this case TD is indicated in cyan and if TD data differ more than 1 min. from the RX-1203 data, the readout flashes.

Position readout

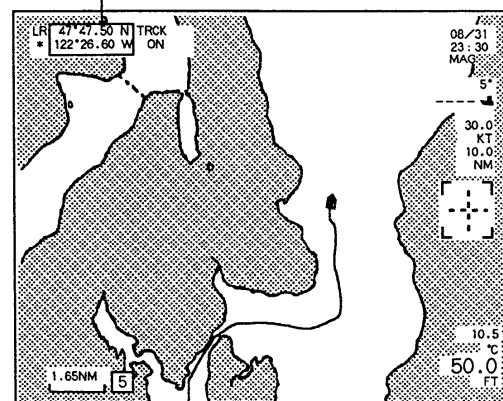

Various indications

• Scale/distance indication key

The scale or distance indication can be selected for your convenience.

- 1) Push [MENU] to select the menu mode.
- 2) Select "PLOTTER" by rotating the trackball vertically; then, push [SET].
 - Pushing [1] also performs this function.
 - The plotter menu window appears.
- 3) Select "SCREEN SETTING" by rotating the trackball vertically; then, push [SET].
 - Pushing [8] also performs this function.
 - The screen setting window appears.
- 4) Select "SCALE" by rotating the trackball vertically; then, push [SET].
 - Pushing [1] also performs this function.
 - "SCALE" turns green.
- 5) Rotate the trackball horizontally to select "DIST" for distance indication or "SCALE" for scale indication; then, push [SET].
 - "SCALE" turns yellow.
- 6) Push [←5] or [←5] to exit the menu mode.

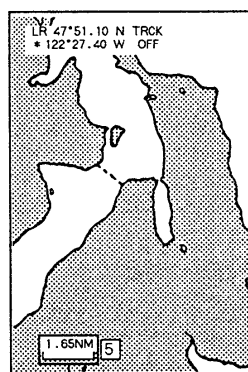
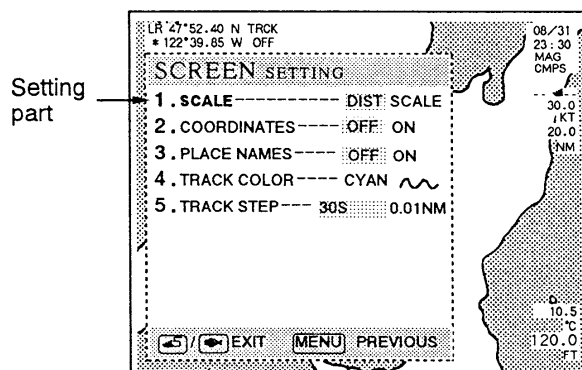

Distance indication key

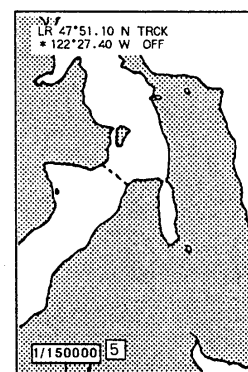

Scale indication key

• Coordinates indication

The coordinates indication can be turned ON or OFF for your convenience.

- 1) Push [MENU] to select the menu mode.
- 2) Select "PLOTTER" by rotating the trackball vertically; then, push [SET].
 - Pushing [1] also performs this function.
 - The plotter menu window appears.
- 3) Select "SCREEN SETTING" by rotating the trackball vertically; then, push [SET].
 - Pushing [8] also performs this function.
 - The screen setting window appears.
- 4) Select "COORDINATES" by rotating the trackball vertically; then, push [SET].
 - Pushing [2] also performs this function.
 - "COORDINATES" turns green.
- 5) Rotate the trackball horizontally to select "ON" or "OFF"; then, push [SET].
 - "SCALE" turns yellow.
- 6) Push [←5] or [←5] to exit the menu mode.

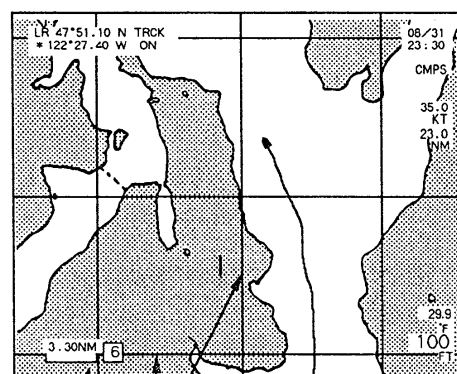

Coordinates

CHART SCALE		UNIT OF COORDINATES
[9] [8]		1 degree
[7] [6] [5]		10 minutes
[4] [3] [2]		1 minute
[1] [0]		1/10 minute

• Place name indication

The place name can be displayed for your convenience.

- 1) Push [MENU] to select the menu mode.
- 2) Select "PLOTTER" by rotating the trackball vertically; then, push [SET].
 - Pushing [1] also performs this function.
 - The plotter menu window appears.
- 3) Select "SCREEN SETTING" by rotating the trackball vertically; then, push [SET].
 - Pushing [8] also performs this function.
 - The screen setting window appears.
- 4) Select "PLACE NAMES" by rotating the trackball vertically; then, push [SET].
 - Pushing [3] also performs this function.
 - "PLACE NAMES" turns green.
- 5) Rotate the trackball horizontally to select "ON" or "OFF," then push [SET].
 - "PLACE NAMES" turns yellow.
- 6) Push [5] or [fish icon] to exit the menu mode.

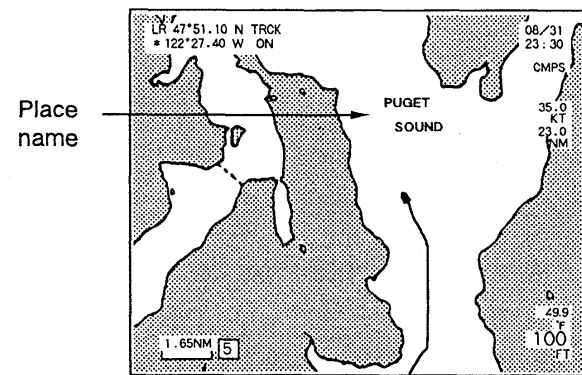
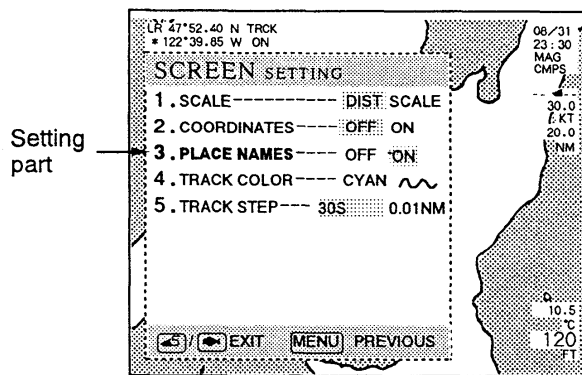

Place name "ON"

PLOTTER

■ Distance measurement

The distance from your ship to the cursor position is indicated on the plot screen continuously when the cursor is ON. Moreover, you can measure the distance and direction from one point to another point on the plot screen.

- 1) Push [CURSOR] to display the cursor.
- 2) Rotate the trackball to set the cursor to the point you wish to measure from.
- 3) Push and hold [CURSOR] for 2 sec.
 - A single beep sounds and a red cross appears.
- 4) Rotate the trackball to move the cursor to desired points.
 - The distance and bearing are indicated in red.
- 5) Push [CURSOR] to end the distance measurement.

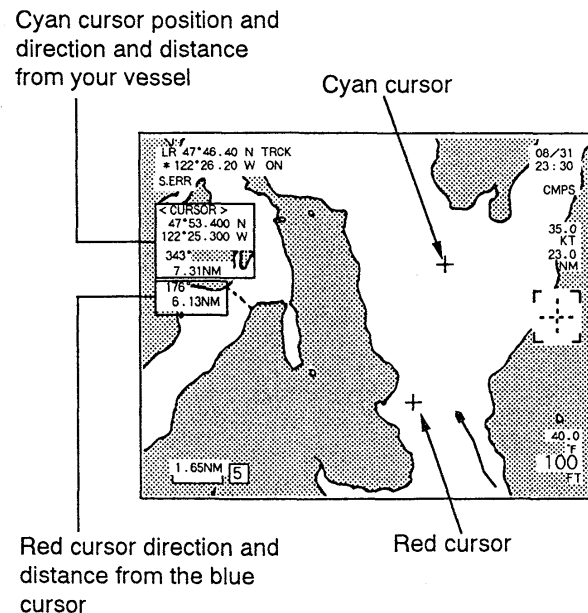

3-3 Track operation

When you are cruising, the vessel track can be displayed in your favorite color. Vessel position is marked at certain intervals, and the plotter draws a line between the points.

The track is drawn in up to 1200 points. When the maximum has been reached, the points of the old track are erased.

Track indication

Track indication ON/OFF

Track indication can be turned ON or OFF for your convenience.

- 1) Push [SET] 3 times.
 - "TRCK" turns green.
- 2) Push [Δ] or [∇] to select ON or OFF.
- 3) Push [SET] to exit the setting condition.
 - "TRCK" turns white.

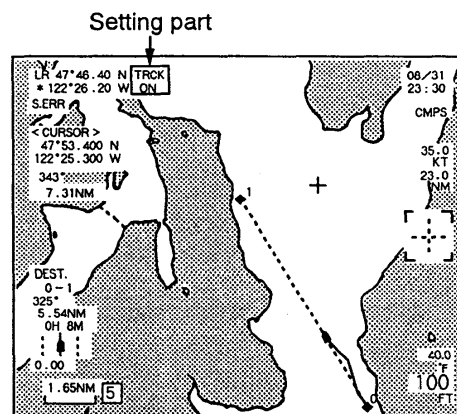

Track color selection

Your favorite track color can be selected from 7 different colors.

- 1) Push [MENU] to select the menu mode.
- 2) Select "PLOTTER" by rotating the trackball vertically; then, push [SET].
 - Pushing [1] also performs this function.
 - The plotter menu window appears.
- 3) Select "SCREEN SETTING" by rotating the trackball vertically; then, push [SET].
 - Pushing [8] also performs this function.
 - The screen setting window appears.
- 4) Select "TRACK COLOR" by rotating the trackball vertically; then, push [SET].
 - Pushing [4] also performs this function.
 - "TRACK COLOR" turns green.
- 5) Rotate the trackball vertically to select the desired track color.
 - Pushing [Δ] / [∇] also performs this function.
- 6) Push [SET] to set the color.
 - "Track color" turns yellow.
- 7) Push [5] or [fish icon] to exit the menu mode.

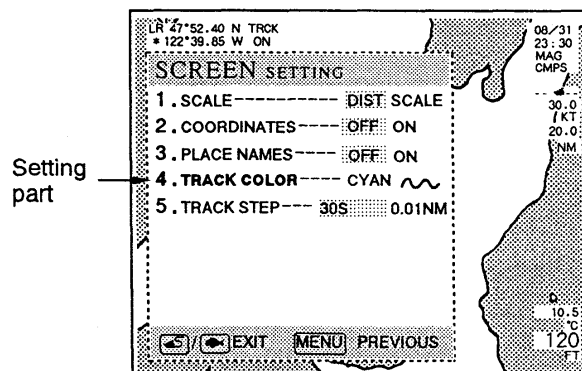

TRACK COLORS AVAILABLE

- | | |
|----------|-----------|
| • Red | • Magenta |
| • Green | • Cyan |
| • Yellow | • White |
| • Blue | |

NOTE: Even when the color is changed, the track color already drawn will not change. Only the subsequent tracks will change color.

■ Plotting interval

The intervals along the track can be selected to fit your cruising style.

- 1) Push [MENU] to select the menu mode.
 - The plotter menu window appears.
- 2) Select "PLOTTER" by rotating the trackball vertically; then, push [SET].
 - Pushing [1] also performs this function.
 - The plotter menu window appears.
- 3) Select "SCREEN SETTING" by rotating the trackball vertically; then, push [SET].
 - Pushing [8] also performs this function.
 - The screen setting window appears.
- 4) Select "TRACK STEP" by rotating the trackball vertically; then, push [SET].
 - Pushing [5] also performs this function.
 - "TRACK STEP" turns green.
- 5) Select time or distance as a step unit by rotating the trackball horizontally.
 - The selected time or distance step turns yellow.
- 6) Select the desired value by rotating the trackball horizontally and vertically.
 - Direct digit entry can also be performed. The time unit can also be changed with the [SELECT] key.
- 7) Push [SET] to set the value.
 - "TRACK STEP" turns yellow.
- 8) Push [←5] or [→5] to exit the menu mode.

INTERVAL METHOD		DESCRIPTION
TIME	DISTANCE	
5 sec.	0.01 NM	Detailed track can be drawn.
60 min.	9.99 NM	Long track can be drawn.

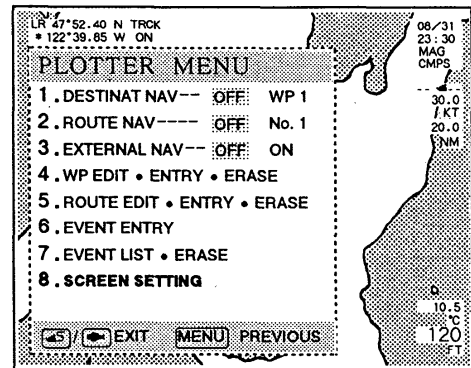

Setting part

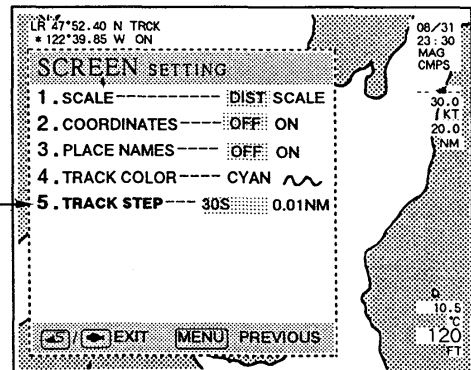

PLOTTER

■ Erasing the track

The displayed track can be erased.

- 1) Push [TRACK].
 - "S" appears.
 - To cancel erasing, push [TRACK] again.
- 2) Push [CLR] to erase.
 - After a few seconds, the track disappears.

NOTE: When track erasing is performed, all track is erased regardless of the track color.

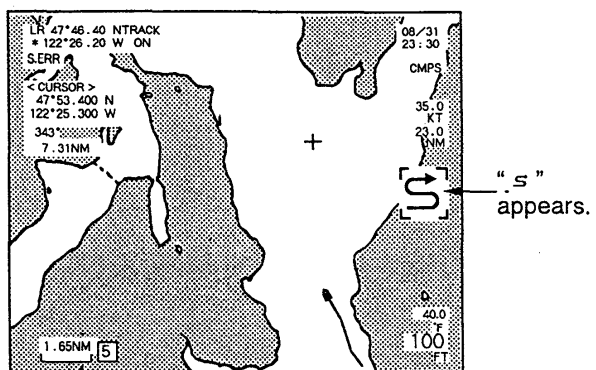

3 PLOTTER OPERATION

3-4 Event mark

Event marks memorize desired reference positions on the chart. 7 colors can be used to distinguish, good fishing points, shallow areas, reefs, light-houses, etc. 2 types of event marks are programmed into the FP-100 as follows:

TYPE	FIGURE	NUMBERS	COMMENT
EVENT 1		100	Yes
EVENT 2		500	No

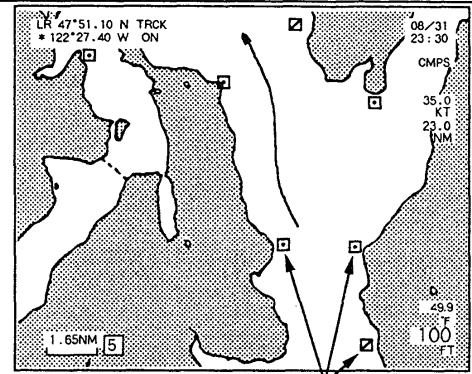

Event marks

PLOTTER

■ Programming event marks

There are 2 methods for programming event marks.

- Programming on the plot screen
- Programming in the plotter menu

• Programming on the plot screen

You can program an event mark at your vessel position or the cursor position.

When programming an event type 1 at your vessel position, date, time, water temperature and water depth are programmed with Lat/Lon.

- 1) When programming an event mark at the cursor position, push [CURSOR] to turn the cursor ON; then, set the cursor at the desired position with the trackball.
- 2) Push [].
 - "EVENT 1" or "EVENT 2" appears.
- 3) Push [SELECT] to select the event type.
 - "EVENT 1" for event type 1 and "EVENT 2" for event type 2 appear alternately.
 - To cancel the programming push [CLR].
- 4) Push []/[] several times to select a color for the event mark, then push [SET].
 - For event type 1, the comment entering screen appears.
 - For event type 2, programming is complete.
- 5) Enter a comment for event type 1 using the trackball and [SET]. After entering the comment, select "SET" with the trackball and push [SET].
 - Event type 1 programming is complete.

[SCREEN EXAMPLE FOR PROGRAMMING AT YOUR VESSEL POSITION]

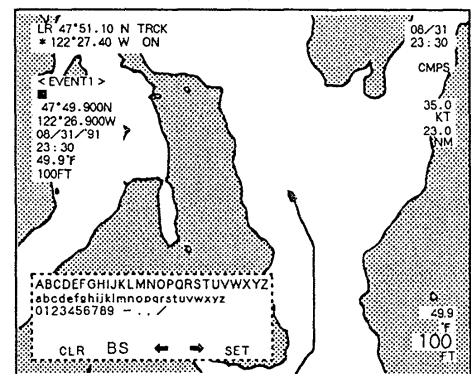
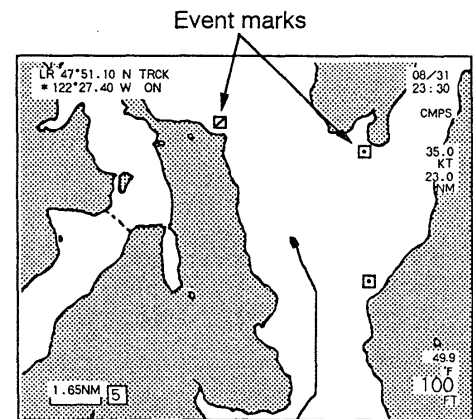

Comment entry window

• Programming in the plotter menu.

Event marks can be programmed anywhere you want by directly entering latitude and longitude.

- 1) Push [MENU] to select the menu mode.
 - Pushing [1] also performs this function.
 - The plotter menu window appears.
- 2) Select "PLOTTER" by rotating the trackball vertically; then, push [SET].
 - Pushing [6] also performs this function.
 - The event entry window appears and "COMMENT" turns green.
- 3) Select "EVENT ENTRY" by rotating the trackball vertically; then, push [SET].
 - Pushing [6] also performs this function.
 - The event entry window appears and "COMMENT" turns green.
- 4) Rotate the trackball horizontally to select "YES" for event type 1 or "NO" for event type 2; then, push [SET].
 - "COLOR" turns green.
- 5) Rotate the trackball vertically to select a color for the event mark; then, push [SET].
 - Pushing [Δ]/[∇] + [SET] also performs this function.
 - "LATITUDE" turns green.
- 6) Rotate the trackball vertically and horizontally to select the latitude, then push [SET].
 - Direct digit entry can also be performed. The direction can also be changed with the [SELECT] key.
 - "LONGITUDE" turns green.
- 7) Rotate the trackball vertically and horizontally to select the longitude, then push [SET].
 - Direct digit entry can also be performed. The direction can also be changed with the [SELECT] key.
 - For event type 1, the comment entering screen appears.
 - For event type 2, the programming is complete and other event programming is automatically started. If you want to program other events, repeat steps 3 ~ 7 (and 8 for event type 1).
- 8) For event type 1, enter the comment using the trackball and [SET]. After entering the comment, select "SET" with the trackball and push [SET].
 - Event programming is complete and other event programming is automatically started. If you want to program other events, repeat steps 3 ~ 7 (and 8 for event type 1).
- 9) Push [←5] or [→5] to exit the menu mode.

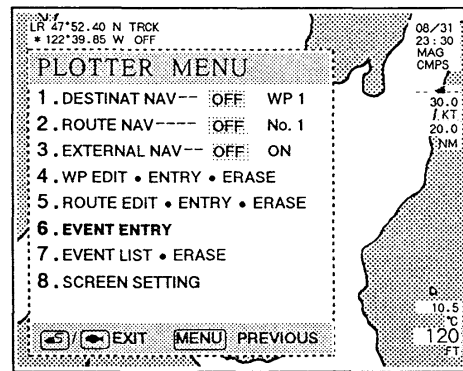
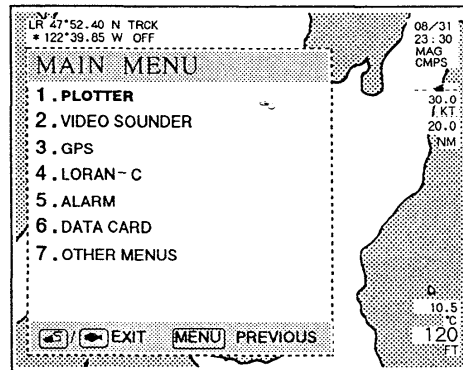

Number of stored event marks. (Separate number appears depending on the selected type.)

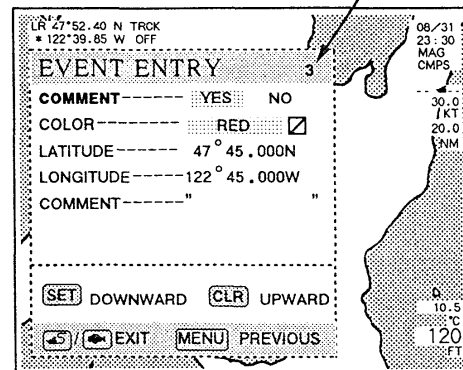

Event entry window (for event type 1)

NOTE 1: It is impossible to program an event mark with latitude and longitude the same as an event mark previously programmed. An error message appears with a beep if this is attempted.

NOTE 2: If you attempt to program more than 100 event marks for event type 1 and more than 500 for event type 2, error messages appear.

PLOTTER

■ Erasing event marks or changing event type, color and comment

Unnecessary event marks can be cleared, moreover, event type can be changed as well as the comment of event type 1.

• Erasing the event mark.

- 1) Push [CURSOR] to turn the cursor ON.
- 2) Set the cursor on the event mark to be cleared with the trackball.
- 3) Push [$\frac{\text{M}}{\text{O}}$].
 - Programmed event type is indicated in the programmed color; latitude and longitude are indicated in white.
- 4) Push [CLR].
 - The event mark is erased.
- 5) Push [CURSOR] to turn the cursor OFF.

NOTE: Event mark erasing can be performed in the menu mode. See the box on the next page for details.

• Changing event type

- 1) Push [CURSOR] to turn the cursor ON.
- 2) Set the cursor on the event mark to be changed with the trackball.
- 3) Push [$\frac{\text{M}}{\text{O}}$].
 - Programmed event type is indicated in the programmed color; latitude and longitude are indicated in white.
- 4) Push [SELECT] to change the type; then, push [SET].
 - When changing the type from type 2 to type 1, comment entry display appears. Enter the comment with the trackball and [SET]. After entering, set the cursor to "SET" with the trackball and push [SET].
- 5) Push [CURSOR] to turn the cursor OFF.

• Changing event color

- 1) Push [CURSOR] to turn the cursor ON.
- 2) Set the cursor on the event mark to be changed with the trackball.
- 3) Push [$\frac{\text{M}}{\text{O}}$].
 - Programmed event type is indicated in the programmed color; latitude and longitude are indicated in white.
- 4) Push [Δ]/[∇] several times; then, push [SET].
 - When changing the color of event type 1, comment entry display appears. Push [SET] again on the display.
- 5) Push [CURSOR] to turn the cursor OFF.

• Changing comment (for event type 1)

- 1) Push [CURSOR] to turn the cursor ON.
- 2) Set the cursor on the event mark to be changed with the trackball.
- 3) Push [$\frac{\text{M}}{\text{O}}$].
 - Programmed event type is indicated in the programmed color; latitude and longitude are indicated in white.
- 4) Push [SET].
 - Comment entry display appears. Change the comment with the trackball and [SET]. After changing, set the cursor to "SET" with the trackball and push [SET].
- 5) Push [CURSOR] to turn the cursor OFF.

Listing-up event marks

• Event mark listing-up

Event marks are listed in the menu mode, and can be displayed easily. Event mark erasing can also be performed on the list.

- 1) Push [MENU] to select the menu mode.
- 2) Select "PLOTTER" by rotating the trackball vertically; then, push [SET].
 - Pushing [1] also performs this function.
 - The plotter menu window appears.
- 3) Select "EVENT LIST•ERASE" by rotating the trackball; then, push [SET].
 - Pushing [7] also performs this function.
 - Event list window appears.
- 4) Rotate the trackball to scroll the list.
 - To erase the event mark, see the box below.
- 5) Push [5] or [fish] to exit the menu mode.

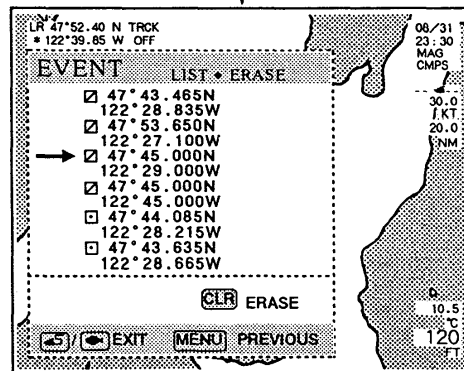
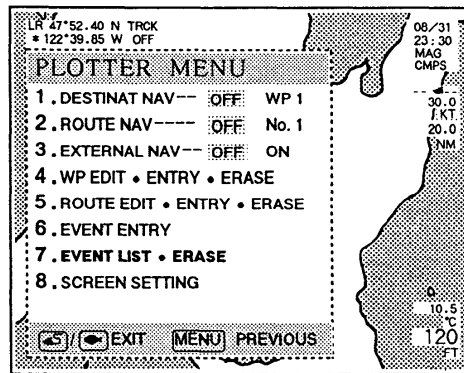

PLOTTER

• Erasing

Event mark erasing can also be performed in the plotter menu. Note that simultaneous erasing of all event marks can only be performed in the event list window.

- 1) Push [MENU] to select the menu mode.
- 2) Select "PLOTTER" by rotating the trackball vertically; then, push [SET].
 - Pushing [1] also performs this function.
 - The plotter menu window appears.
- 3) Select "EVENT LIST•ERASE" by rotating the trackball; then, push [SET].
 - Pushing [7] also performs this function.
 - Event list window appears.
- 4) Rotate the trackball to select the event number to be erased, then push [CLR], or push and hold [CLR] for all event erasing.
 - "ALL EVENTS ERASE" appears when [CLR] is pushed and held.
- 5) Push [SET] to erase the event.
 - To cancel erase, push [CLR].
- 6) Push [5] or [fish] to exit the menu mode.

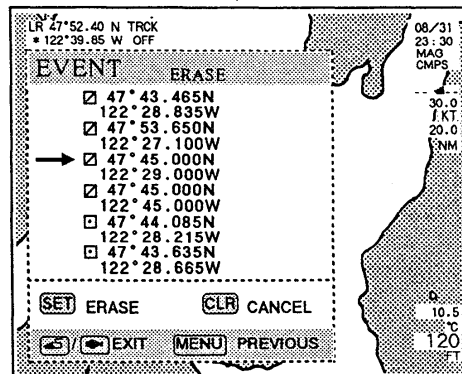
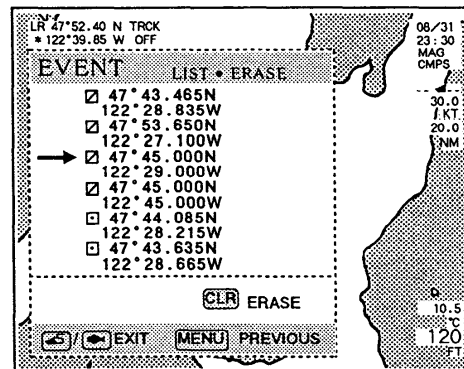

3-5 Navigation function

■ Function description

The navigation function allows you to lead your vessel to a destination (waypoint) or along a desired route using the navigation indicators. The FP-100 shows your preset route, course error, distance, and direction on the screen.

This function allows you to ignore tidal currents and winds during cruising. The VP-21 has 3 navigating functions as follows:

- Destination navigation
- Route navigation
- External navigation.

Before activating destination or route navigation, waypoints must be programmed.

■ Programming waypoints

A waypoint is used as a destination in destination navigation. Waypoints are also used as relay points and destinations in route navigation. Up to 99 waypoints (waypoint numbers 1 ~ 99) can be programmed in the FP-100.

Waypoint number "0" is your vessel position.

There are 2 methods for programming the waypoints.

- Programming on the plotter screen
- Programming in the plotter menu.

NOTE: When a navigation function such as destination navigation is activated, waypoints cannot be programmed.

• Programming on the plot screen.

You can program a waypoint at your vessel position or the cursor position.

- 1) When destination navigation or route navigation is activated, turn the function OFF. (pgs. 35, 36, 40)
- 2) When programming a waypoint at the cursor position, push [CURSOR] to turn the cursor ON; then, set the cursor at the desired position with the trackball.
- 3) Push [\square/\diamond] twice.
 - "WAYPOINT" and green Lat/Lon appear.
- 4) Push [\triangle]/[∇] several times to select a waypoint number.
- 5) Push [SET].
 - Comment entry display appears.
 - To cancel the programming, push [CLR].
- 6) Enter a comment using the trackball and [SET] key. After entry, set the cursor to "SET" then push [SET] to input the comment.
 - Waypoint programming is complete.

[SCREEN EXAMPLE FOR PROGRAMMING AT THE CURSOR POSITION]

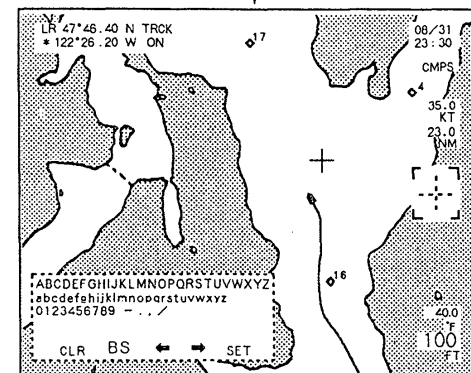
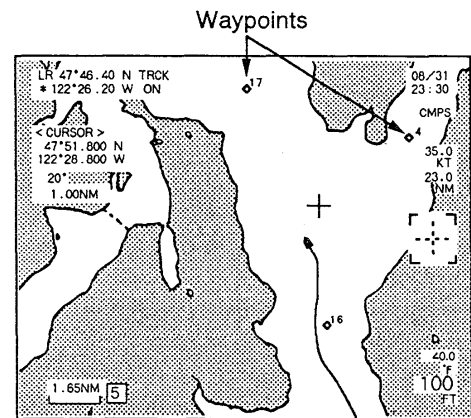

Comment entry window

• Programming in the plotter menu

Waypoints can be programmed anywhere you want by entering latitude and longitude directly.

- 1) When destination navigation or route navigation is activated, turn the function OFF. (pgs. 35, 36, 40)
- 2) Push [MENU] to select the menu mode.
- 3) Select "PLOTTER" by rotating the trackball vertically; then, push [SET].
 - Pushing [1] also performs this function.
 - The plotter menu window appears.
- 4) Select "WP EDIT•ENTRY•ERASE" by rotating the trackball vertically; then, push [SET].
 - Pushing [4] also performs this function.
 - The waypoint edit window appears.
 - If "WP EDIT•ENTY•ERASE" is displayed in blue, the destination or route navigation function has been activated. Turn the function OFF.
- 5) Rotate the trackball vertically to select the waypoint number to be programmed.
- 6) Push [SET].
 - The present vessel location appears when the cursor is OFF.
 - The cursor position appears when the cursor is ON.
- 7) Rotate the trackball horizontally and vertically to set the latitude of the waypoint, then push [SET].
 - Direct entry is also possible with the digit keys.
- 8) Rotate the trackball horizontally and vertically to set the longitude of the waypoint, then push [SET].
 - Direct entry is also possible with the digit keys.
- 9) Enter a comment using the trackball and [SET] key. After entry, set the cursor to "SET" then push [SET] to input the comment.
 - Waypoint programming is complete.
- 10) When programming more than one waypoint, repeat steps 5 ~ 9.
- 11) Push [EXIT] or [PREVIOUS] to exit the menu mode.

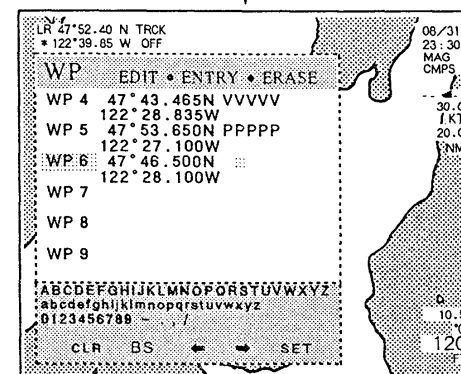
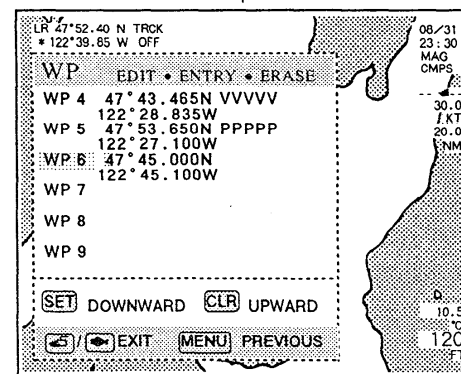
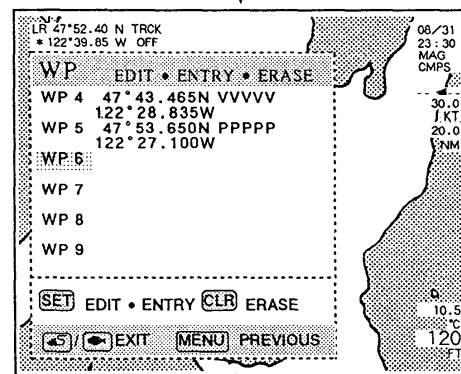
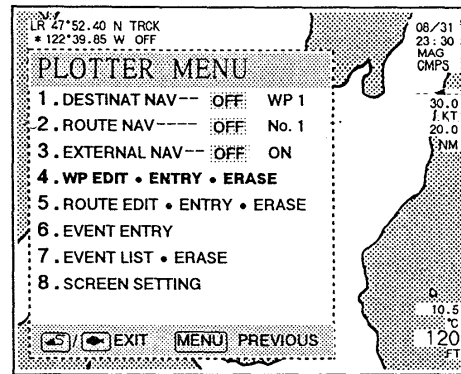

PLOTTER

NOTE: Programming a waypoint with latitude and longitude the same as a previously programmed waypoint is not possible. An error message appears with a beep if this is attempted.

3 PLOTTER OPERATION

■ Erasing waypoints

• Erasing on the plot screen.

- 1) When destination navigation or route navigation is activated, turn the function OFF. (pgs. 35, 36, 40)
- 2) Push [CURSOR] to turn the cursor ON.
- 3) Rotate the trackball to set the cursor on the waypoint to be cleared.
- 4) Push [$\frac{\square}{\square}$] twice.
 - "WAYPOINT" and waypoint information appear.
- 5) Push [CLR] to erase the waypoint.
 - If the error indicator appears with a low beep, the waypoint may already be programmed into a route. In this case, erase the route before erasing the waypoint. See p. 37 for erasing route details.
- 6) Push [CURSOR] to turn the cursor OFF.

Set the cursor to the waypoint to be cleared.

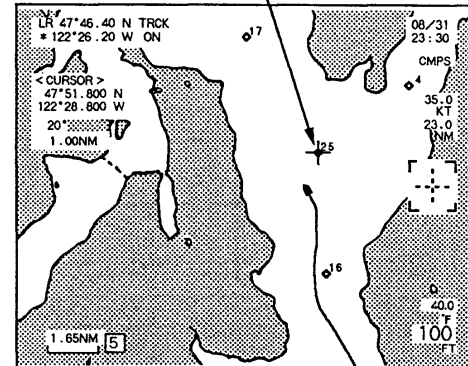

• Erasing in the plotter menu.

- 1) When destination navigation or route navigation is activated, turn the function OFF. (pgs. 35, 36, 40)
- 2) Push [MENU] to select the menu mode.
- 3) Select "PLOTTER" by rotating the trackball vertically; then, push [SET].
 - Pushing [1] also performs this function.
 - The plotter menu window appears.
- 4) Select "WP EDIT•ENTRY•ERASE" by rotating the trackball vertically; then, push [SET].
 - Pushing [4] also performs this function.
 - The waypoint edit window appears.
 - If "WP EDIT•ENTRY•ERASE" is displayed in blue, the destination or route navigation function has been activated. Turn the function OFF.
- 5) Rotate the trackball to select the waypoint number to be erased.
- 6) Push [CLR].
 - The blue-data waypoints cannot be edited because they have been programmed into routes. To erase the blue-data waypoints, first erase the route which contains the waypoints. (p. 37)
 - To cancel erasing, push [CLR] again.
- 7) Push [SET] to erase.
 - Waypoint erasing is complete.

• Erasing all waypoints

All waypoints erasing command can be activated in the plotter menu under the following conditions.

- All navigation functions are OFF.
- 2 or more waypoints have been programmed.
- No route has been programmed.

- 1) Push [MENU] to select the menu mode.
- 2) Select "PLOTTER" by rotating the trackball vertically; then, push [SET].
 - Pushing [1] also performs this function.
 - The plotter menu window appears.
- 3) Select "WP EDIT•ENTRY•ERASE" by rotating the trackball vertically; then, push [SET].
 - Pushing [4] also performs this function.
 - The waypoint edit display appears.
- 4) Push and hold [CLR].
 - "ALL WAYPOINTS ERASE" appears.
 - When conditions do not match those listed above, "ALL WAYPOINTS ERASE" does not appear and the command does not activate.
 - To cancel erasing, push [CLR] again.
- 5) Push [SET] to erase.
 - Waypoint erasing is complete.

■ Changing waypoint comment and Lat/Lon data

• Changing the comment

Programmed waypoint comments can be changed on the plot screen.

- 1) When destination navigation or route navigation is activated, turn the function OFF. (pgs 35, 36, 40)
- 2) Push [CURSOR] to turn the cursor ON.
- 3) Set the cursor on the waypoint with the trackball.
- 4) Push [\square/\diamond] twice.
 - "WAYPOINT," waypoint number, comment and white LAT/LON appears.
- 5) Push [SET].
 - The comment entry display appears.
- 6) Enter comment with the trackball and [SET]. After entry, set the cursor to "SET" with the trackball then push [SET].
- 7) Push [CURSOR] to turn the cursor OFF.

NOTE: Even if the waypoint has been programmed in routes, its comment can be changed only on the plot screen. It is impossible to change such a waypoint's comment in the menu mode.

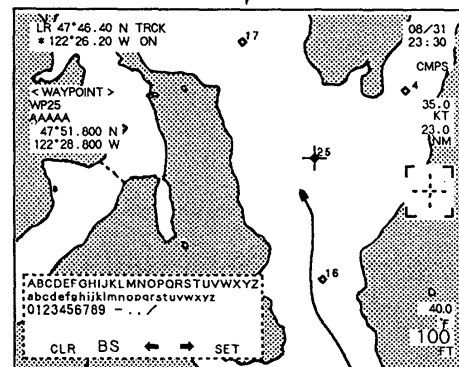
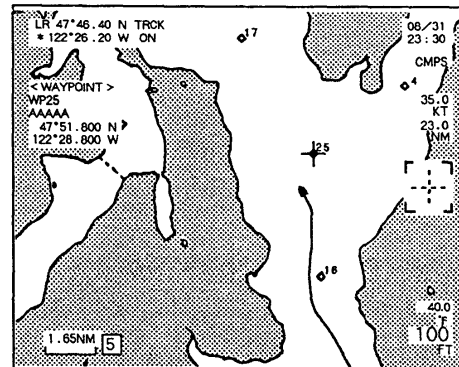

PLOTTER

• Changing Lat/Lon data

The Lat/Lon data can be changed in the plotter menu only. Waypoint comments can also be changed.

- 1) Push [MENU] to select the menu mode.
- 2) Select "PLOTTER" by rotating the trackball vertically; then, push [SET].
 - Pushing [1] also performs this function.
 - The plotter menu window appears.
- 3) Select "WP EDIT•ENTRY•ERASE" by rotating the trackball; then, push [SET].
 - Pushing [4] also performs this function.
 - The waypoint edit window appears.
- 4) Rotate the trackball vertically to select the white-data waypoint to be edited; then push [SET].
 - The blue-data waypoints cannot be edited because they have been programmed into routes. To erase the blue-data waypoints, first erase the route which contains the waypoints. (p. 37)
 - The cursor appears on the first digit of the latitude.
- 5) Rotate the trackball vertically and horizontally to select the latitude; then push [SET].
 - Direct entry is also possible with the digit keys.
 - The cursor moves to the first digit of the longitude.
- 6) Rotate the trackball vertically and horizontally to select the longitude; then push [SET].
 - Direct entry is also possible with the digit keys.
 - The waypoint comment setting display appears.
- 7) Push [SET].
 - When you want to change the comment, enter the new comment with the trackball. After the new comment is entered, set the cursor to "SET," then push [SET].
- 8) When you want to change the Lat/Lon data of other waypoints, repeat steps 4 - 7.
- 9) Push [MENU] to finish editing.
 - "WP EDIT•ENTRY•ERASE" turns yellow.
- 10) Push [\leftarrow 5] or [\rightarrow] to exit the menu mode.

Destination navigation (Basic navigation)

Destination navigation leads the vessel to one desired position. Course error can be checked by using it together with the alarm function.

This function is not useful when the shortest course (a straight course) cannot be taken. If, for example, an island lies in the way, use the route navigation described on pgs. 38 ~ 41.

Starting and cancelling the navigation can be performed both on the plot screen and in the menu mode.

During navigation, the navigation monitor screen is useful for monitoring the navigation data. (p. 14)

Starting on the plot screen

- 1) Program a waypoint (destination) if the desired waypoint has not been programmed. (p. 29)
- 2) Push [CURSOR] to turn the cursor ON.
- 3) Decide on a waypoint for the destination and set the cursor on the waypoint with the trackball.
- 4) Push [\square/\diamond] 2 times.
 - The waypoint information appears.
- 5) Push [\triangle] or [∇].
 - Green "NAV" appears next to the waypoint number.
- 6) Push [SET] to start destination navigation.
 - After a few seconds, a green, dotted line appears between your vessel and the destination.
- 7) Push [CURSOR] to turn the cursor OFF.

See p. 35 ~ 36 for cancelling the navigation function.

Turn ON "NAV" with [\triangle] or [∇].

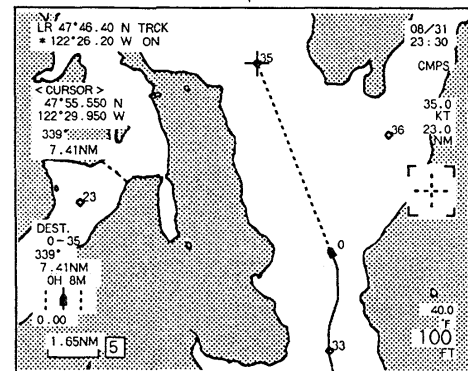
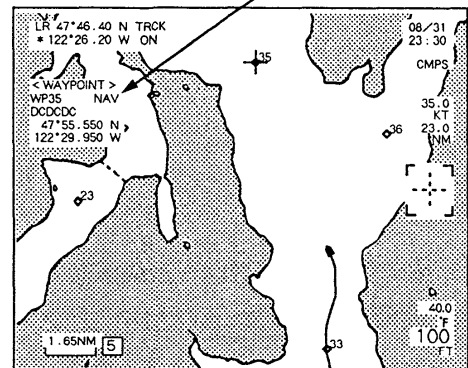

CONVENIENT

Use the arrival alarm: (p. 42)

The arrival alarm beeps when you reach your destination.

Use the course out alarm: (p. 42)

The course out alarm beeps if you deviate from your plotted course.

• Screen description during destination navigation

NAVIGATION INDICATORS

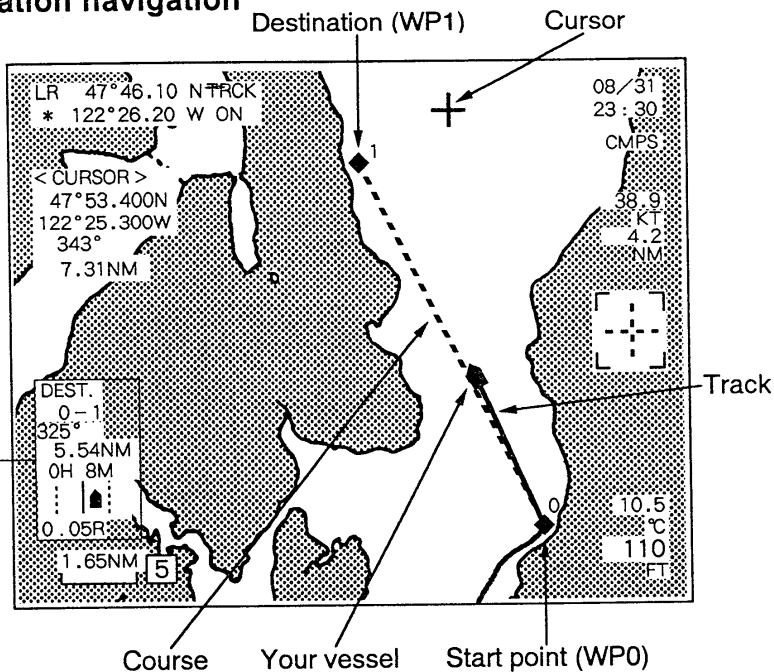
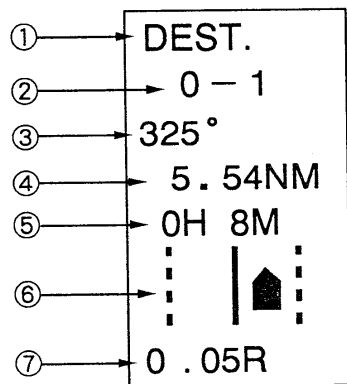

PLOTTER

- ① **NAVIGATION NAME**
Shows navigation name.
• "DEST." appears during destination navigation.
- ② **WAYPOINT READOUT**
Shows the selected course.
• "0 - 1" shows that the selected course is from waypoint 0 to waypoint 1.
- ③ **C/D (COURSE TO DESTINATION) READOUT**
Shows the direction to the target waypoint.
• Target waypoint is the destination during destination navigation.
- ④ **D/D (DISTANCE TO DESTINATION) READOUT**
Shows the distance to the target waypoint.
• Target waypoint is the destination during destination navigation.
- ⑤ **TTG (TIME TO GO) READOUT**
Shows the expected time to the target waypoint.
• Target waypoint is the destination during destination navigation.



⑥ **COURSE OUT INDICATOR**

INDICATION	DESCRIPTION
	Your vessel is left of the preset, course limits/alarm ranges.
	Your vessel is between the preset, course in and course out, alarm ranges.
	Your vessel is inside the preset, course in and course out, alarm ranges.
	Your vessel is right on course.
	Your vessel is inside the preset, course in and course out, alarm ranges.
	Your vessel is between the preset, course in and course out, alarm ranges.
	Your vessel is right of the preset, course limits/alarm ranges.

- ⑦ **COURSE DEVIATION READOUT**
Shows distance from the selected navigation course.

3 PLOTTER OPERATION

• Starting in the plotter menu

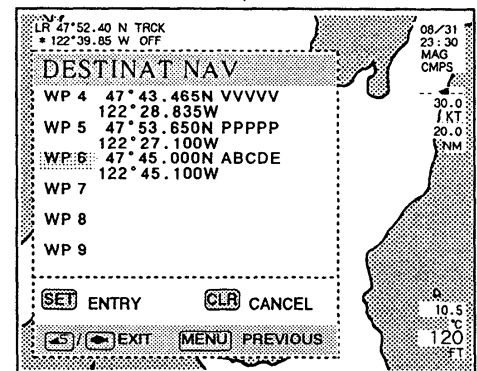
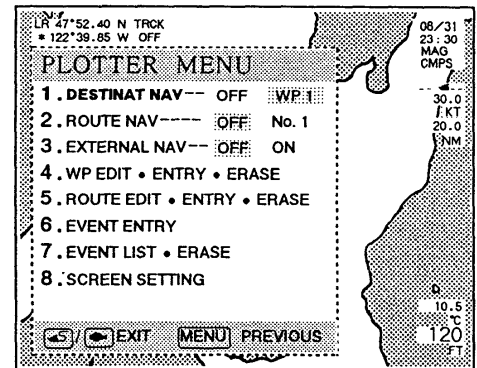

- 1) Program a waypoint (destination) if the desired waypoint has not been programmed.
- 2) Push [MENU] to select the menu mode.
- 3) Select "PLOTTER" by rotating the trackball vertically; then, push [SET].
 - Pushing [1] also performs this function.
 - The plotter menu appears.
- 4) Select "DESTINAT NAV" by rotating the trackball vertically; then, push [SET].
 - Pushing [1] also performs this function.
 - "DESTINAT NAV" turns green.
- 5) Rotate the trackball horizontally to select "WP XX," then push [SET].
 - The waypoints list appears.
- 6) Rotate the trackball vertically to select the waypoint as a destination, then push [SET].
 - "DESTINAT NAV" turns yellow.
- 7) Push [] or [] to exit the menu mode.
 - A green, dotted line appears between your vessel position ("0" is indicated) and the destination.

See the boxes below and on p. 36 for cancelling the navigation function.



PLOTTER

• Function cancelling on the plot screen

- 1) Push [CURSOR] to turn the cursor ON.
- 2) Set the cursor on the destination waypoint with the trackball.
- 3) Push [] twice.
 - The waypoint information appears.
- 4) Push [] or [].
 - Green "NAV" disappears.
- 5) Push [SET] to cancel destination navigation.
 - The green, dotted line disappears.
- 6) Push [CURSOR] to turn the cursor OFF.

Set the cursor on the destination waypoint.

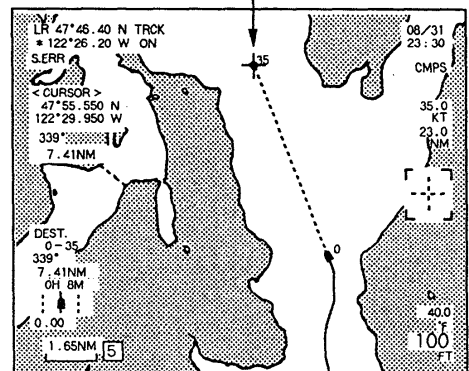

NOTE: When route navigation or external navigation is selected from the plotter menu during destination navigation, destination navigation will be automatically cancelled.

• **Function cancelling in the plotter menu**

- 1) Push [MENU] to select the menu mode.
- 2) Select "PLOTTER" by rotating the trackball vertically; then, push [SET].
 - Pushing [1] also performs this function.
 - The plotter menu window appears.
- 3) Select "DESTINAT NAV" by rotating the trackball vertically; then, push [SET].
 - Pushing [1] also performs this function.
 - "DESTINAT NAV" turns green.
- 4) Select "OFF" by rotating the trackball vertically.
- 5) Push [SET].
 - "DESTINAT NAV" turns yellow.
 - Destination navigation is cancelled.

NOTE: When route navigation or external navigation is selected in the plotter menu during destination navigation, destination navigation will be automatically cancelled.

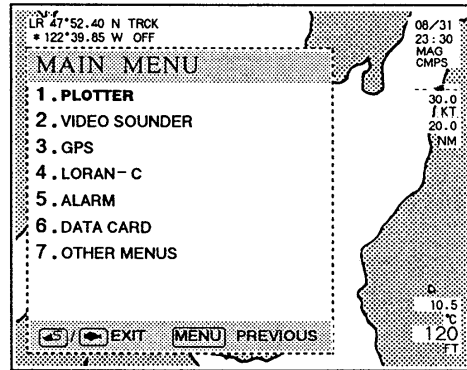

Setting part

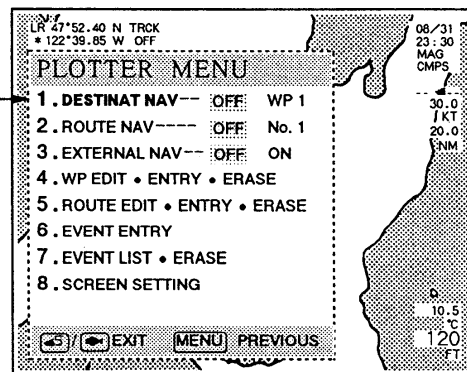

PLOTTER

Programming, erasing and reprogramming routes

For route programming, several waypoints must be programmed in advance.

- 1) When route navigation is activated, turn the navigation OFF. (p. 40)
- 2) Push [MENU] to select the menu mode.
- 3) Select "PLOTTER" by rotating the trackball vertically; then, push [SET].
 - Pushing [1] also performs this function.
 - The plotter menu window appears.
- 4) Select "ROUTE EDIT•ENTRY•ERASE" by rotating the trackball vertically; then, push [SET].
 - Pushing [5] also performs this function.
 - The route edit•entry•erase window appears.
- 5) When programming a new route, rotate the trackball vertically to select a cyan route number from No 1 ~ No 10; then, push [SET].
 - When reprogramming the programmed route, select a white route number, then push [SET]. Follow the instructions on the route edit window to reprogram a route.
 - When erasing the programmed route, select a white route number, then push [CLR], then [SET].
- 6) Rotate the trackball vertically to select the first waypoint; then, push [SET].
 - Cyan (blue) waypoints cannot be selected since they have not been programmed.
- 7) Set the subsequent waypoints as described in step 5.
 - To cancel a waypoint, push [△] several times to select the waypoint number to be cleared, then push [CLR].
- 8) When all waypoints have been programmed, push [△] or [▽] several times to set the cursor under the route number.
 - The route name entry display appears.
- 9) Enter the route name using the trackball and [SET]. After entering route name, rotate the trackball to select "SET," then push [SET] to input the entered route.
 - The return route is automatically programmed in reverse.
- 10) Repeat steps 4 ~ 9 to program other routes.
- 11) Push [5] or [fish] to exit the menu mode.

[DISPLAY FOR ROUTE PROGRAMMING]

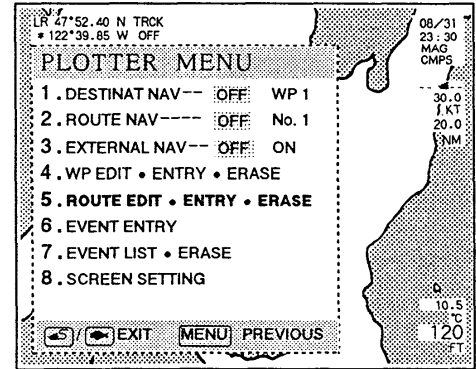

Route number selection

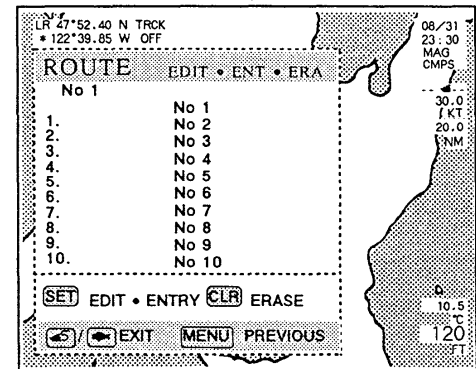

Route programming

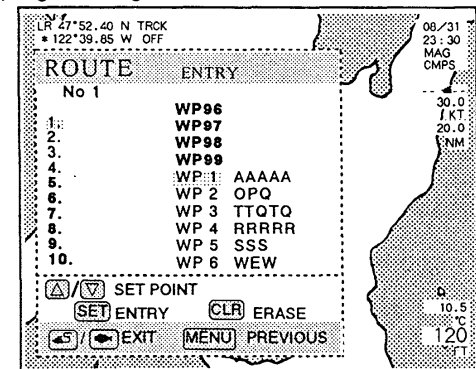

Route name entry

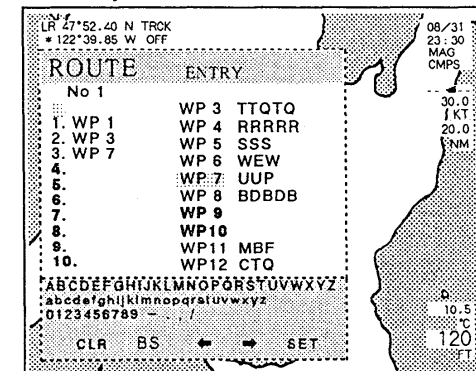

PLOTTER

Route navigation

Route navigation guides the vessel to a desired location along a preset route. Route navigation is convenient if navigating to several points in sequence.

For route navigation, routes must be programmed in advance.

Route navigation can only be started in the menu mode but can be cancelled both on the plot screen and in the menu mode.

During navigation, the monitor screen is useful to get the navigation information. (p. 14)

Starting navigation

- 1) Program waypoints and routes if the desired route has not yet been programmed.
- 2) Push [MENU] to select the menu mode.
- 3) Select "PLOTTER" by rotating the trackball vertically; then, push [SET].
 - Pushing [1] also performs this function.
 - The plotter menu window appears.
- 4) Select "ROUTE NAV" by rotating the trackball vertically; then, push [SET].
 - Pushing [2] also performs this function.
 - "ROUTE NAV" turns green.
- 5) Rotate the trackball horizontally to select "No. XX," then push [SET].
 - The routes list appears.
- 6) Rotate the trackball vertically to select a route.
 - Blue routes cannot be selected since they have not been programmed.
- 7) Push [△] or [▽] to select the route direction: "going" or "returning"
- 8) Push [SET].
 - "ROUTE NAV" turns yellow and navigation starts.
- 9) Push [←5] or [←6] to exit the menu mode.
 - A green, dotted line appears between your vessel position ("0" is indicated) and the first waypoint. Purple dotted lines connect the first waypoint, and all subsequent waypoints, to the destination (the last waypoint).

See p. 40 for cancelling the navigation function.

CONVENIENT

Use the arrival alarm: (p. 42)

The arrival alarm beeps when you reach each waypoint.

Use the course out alarm: (p. 42)

The course out alarm beeps if you deviate from your plotted course.

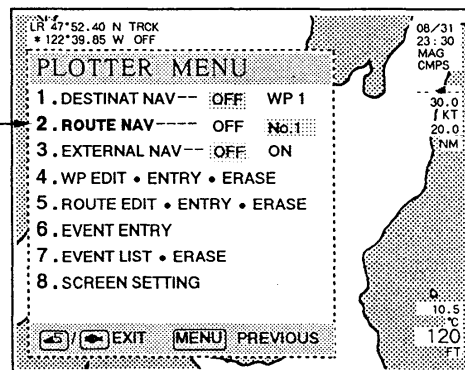
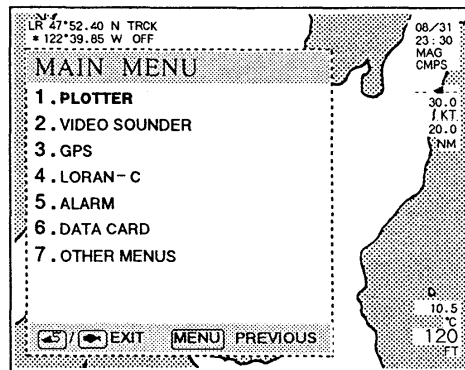

ROUTE DIRECTION
"GO" : going
"RETURN": returning

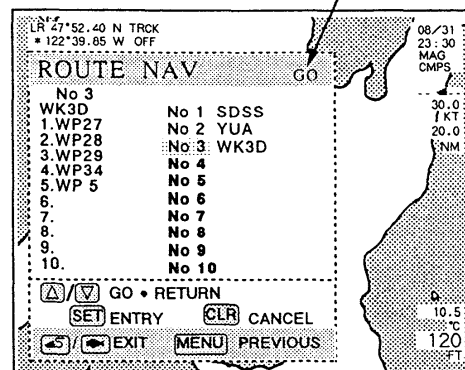

PLOTTER

• Screen description during route navigation

NAVIGATION INDICATORS

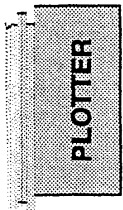
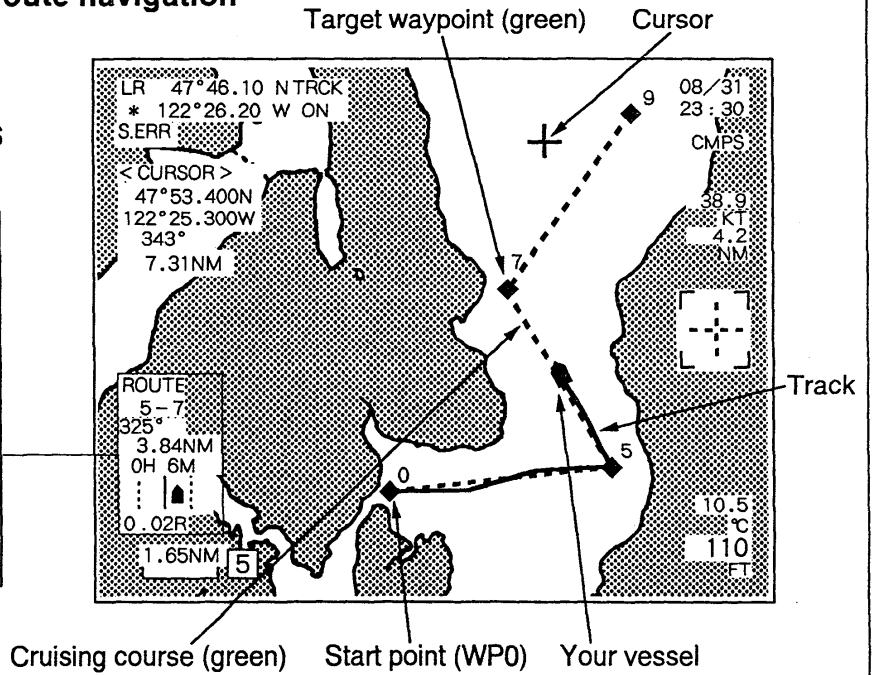
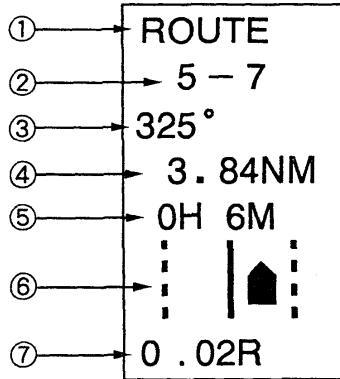

① NAVIGATION NAME

Shows navigation name.
• "ROUTE" appears during route navigation.

② WAYPOINT READOUT

Shows the selected course.
• "5 - 7" shows that the present cruising course is from waypoint 5 to waypoint 7.
• When your vessel arrives* at a target waypoint, the next waypoint becomes the target and the next course is selected automatically.

③ C/D (COURSE TO DESTINATION) READOUT

Shows the direction to the target waypoint.
• Target waypoint is green.

④ D/D (DISTANCE TO DESTINATION) READOUT

Shows the distance to the target waypoint.
• Target waypoint is green.

⑤ TTG (TIME TO GO) READOUT

Shows the expected time to the target waypoint.
• Target waypoint is green.

*The judgement of whether the vessel has arrived at a target waypoint depends on the range of the arrival alarm. Even when the alarm is not activated, the memorized range is effective for judgement.

⑥ COURSE OUT INDICATOR

INDICATION	DESCRIPTION
	Your vessel is left of the preset, course limits/alarm ranges.
	Your vessel is between the preset, course in and course out, alarm ranges.
	Your vessel is inside the preset course in and course out, alarm ranges.
	Your vessel is right on course.
	Your vessel is inside the preset, course in and course out, alarm ranges.
	Your vessel is between the preset, course in and course out, alarm ranges.
	Your vessel is right of the preset, course limits/alarm ranges.

⑦ COURSE DEVIATION READOUT

Shows distance from the selected navigation course.

• **Starting navigation with part of a route**

You can start route navigation in the middle of a programmed route.

- 1) Start route navigation with your desired route.
 - Perform steps 1 ~ 9 described on p. 38.
- 2) On the plot screen, decide the desired target waypoint in the indicated route.
- 3) Push [CURSOR] to turn the cursor ON.
- 4) Set the cursor on the target waypoint.
- 5) Push [\square/\diamond] twice.
 - The waypoint information appears.
- 6) Push [SET].
 - Cruising course is determined to the target waypoint and is displayed in green.
 - C/D, D/D and TTG readouts show the information for the selected target waypoint.

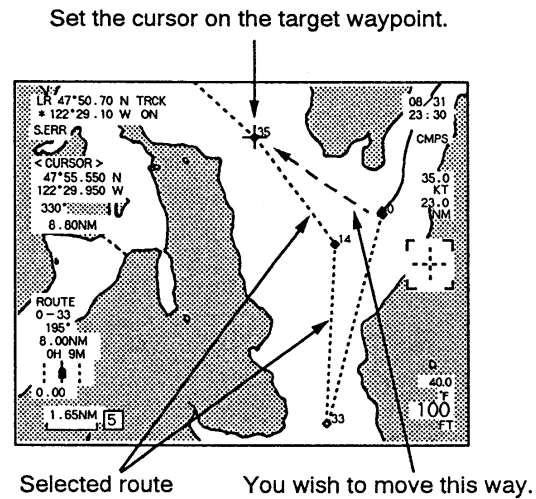

PLOTTER

• **Function cancelling on the plot screen**

- 1) Push [CURSOR] to turn the cursor ON.
- 2) Set the cursor on one of the waypoints of the selected route with the trackball.
- 3) Push [\square/\diamond] twice.
 - Waypoint information appears.
- 4) Push [\triangle] or [∇].
 - Green "NAV" disappears.
- 5) Push [SET].
 - Route navigation is cancelled.

NOTE: When destination navigation or external navigation is selected in the plotter menu during route navigation, route navigation will automatically be cancelled.

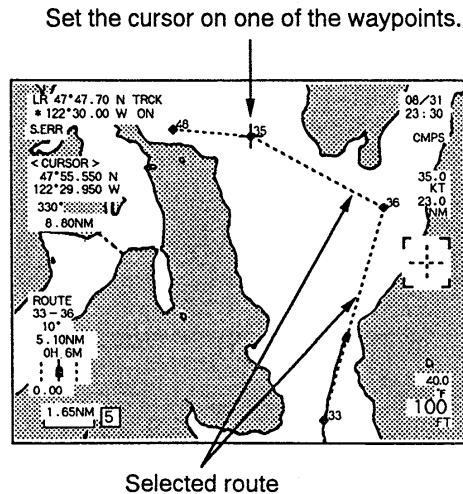

• **Function cancelling in the plotter menu**

- 1) Push [MENU] to select the menu mode.
- 2) Select "PLOTTER" by rotating the trackball vertically; then, push [SET].
 - Pushing [1] also performs this function.
 - The plotter menu window appears.
- 3) Select "ROUTE NAV" by rotating the trackball vertically; then, push [SET].
 - Pushing [2] also performs this function.
 - "ROUTE NAV" turns green.
- 4) Rotate the trackball horizontally to select "OFF."
- 5) Push [SET].
 - "ROUTE NAV" turns yellow.
 - Route navigation is cancelled.

NOTE: When destination navigation or external navigation is selected in the plotter menu during route navigation, route navigation will automatically be cancelled.

External navigation

When a connected navigation receiver has waypoint capability, the waypoint can be used as the destination. Operation is nearly the same as destination navigation.

NOTE: External navigation can be used only when the connected navigation receiver outputs “*WPL” data of the NMEA0183 format.

- 1) Push [MENU] to select the menu mode.
- 2) Select “PLOTTER” by rotating the trackball vertically; then, push [SET].
 - Pushing [1] also performs this function.
 - The plotter menu window appears.
- 3) Select “EXTERNAL NAV” by rotating the trackball vertically; then, push [SET].
 - Pushing [3] also performs this function.
 - “EXTERNAL NAV” turns green.
- 4) Rotate the trackball horizontally to select “ON”; then, push [SET].
 - “EXTERNAL NAV” turns yellow and navigation starts.
- 5) Push [5] or [fish icon] to exit the menu mode.
 - After a few seconds, a green, dotted line appears between your vessel position (waypoint 0) and external waypoints.
- 6) To finish external navigation, repeat steps 1 ~ 3 above, then select “OFF” with the trackball; then, push [SET].

NOTE: When destination navigation or route navigation is selected in the plotter menu during external navigation, external navigation will automatically be cancelled.

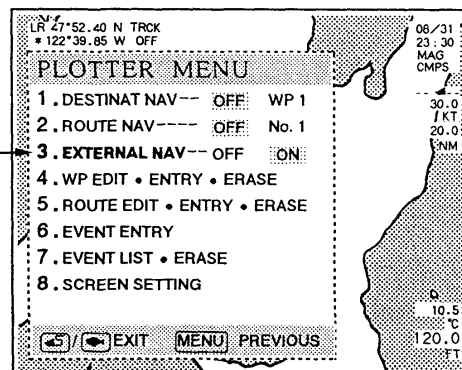
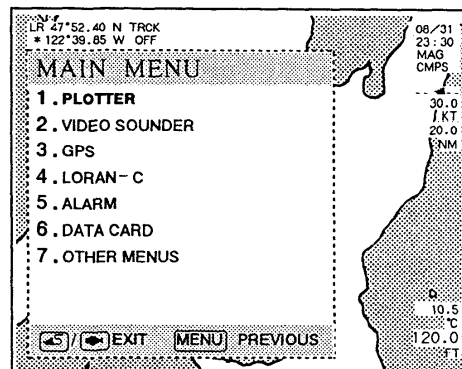





PLOTTER

3-6 Plotter alarms

Alarm types

The FP-100 has 4 types of plotter alarms to suit your operating needs.

ALARM	INDICATION	FUNCTION
Arrival		The alarm sounds when your vessel reaches the pre-set area of the destination.
Anchor		The alarm sounds when your vessel leaves the pre-set area of the destination.
Course out		The alarm sounds when your vessel goes out of the pre-set alarm area.
Course in		The alarm sounds when your vessel enters the pre-set alarm area.

Alarm setting

Set the desired alarm. Multiple alarms can be activated simultaneously.

- 1) Push [MENU] to select the menu mode.
- 2) Select "ALARM" by rotating the trackball vertically; then, push [SET].
 - Pushing [5] also performs this function.
 - The alarm menu window appears.
- 3) Rotate the trackball vertically to select the desired alarm; then, push [SET].
 - Digit keys can also select an alarm.
 - Numbers 5 ~ 8 are sounder alarms.
- 4) Rotate the trackball horizontally to select the value (not "OFF"), then rotate it vertically to set a distance.
 - The maximum value is 1.00 NM.
 - The arrival alarm value cannot be set more than the anchor alarm value. If this is attempted, the anchor alarm value will automatically be set to the same value as the arrival alarm.
 - To cancel the setting, select "OFF."
 - The units of distance can be changed in the set mode.

- 5) Push [SET] to set the alarm.
 - The alarm is activated.
- 6) When setting more than one alarm, repeat steps 3 ~ 5 above.
- 7) Push [←5] or [←] to exit the menu mode.

Plotter alarms

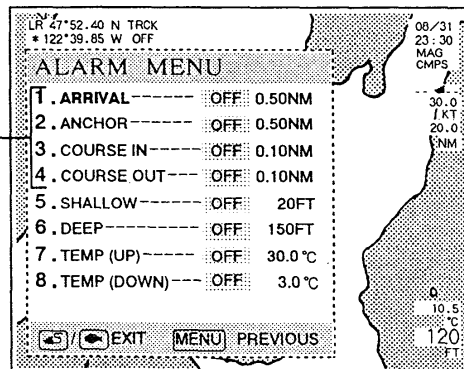

• Operation

The plotter alarms are available only when one of the navigation functions has been activated.

Start one of the navigation functions. When the vessel meets an alarm condition, the alarm sounds.

To stop the alarm after it sounds, push [CLR].

NOTE: If your vessel meets the pre-set condition again, the alarm sounds again.

To cancel the alarm setting, select "OFF" in step 4 above.

3 PLOTTER OPERATION

3-7 RAM card

Drawn track, programmed event marks, waypoints and routes remain in the FP-100. However, when the information exceeds a certain limit, a RAM card is needed to store the information.

The EX-1142 RAM CARD stores 2 sets of data.

• Battery installation

Install the supplied battery, as shown at right, before use.

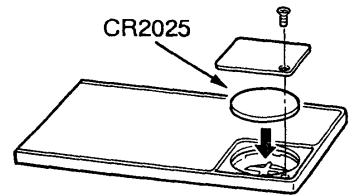

• Memory protection switch

The EX-1142 RAM CARD has a memory protection switch to protect from accidental erasing. For programming, erasing the memory or replacing the battery, set this switch to the OFF position.

Use a pointed object such as a sharp pencil to slide the switch.

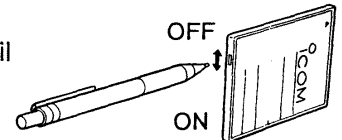

PLOTTER

• Data programming

- 1) Push [MENU] to select the menu mode.
- 2) Select "DATA CARD" by rotating the trackball vertically; then, push [SET].
 - Pushing [6] also performs this function.
 - The data card menu window appears.
- 3) Insert the RAM card into the card slot.
- 4) Select "RAM CARD" by rotating the trackball vertically; then, push [SET].
 - Pushing [2] also performs this function.
 - The RAM card window appears.
 - When the RAM card already has information, the comment and programmed date appear.
- 5) When the RAM card already has 2 sets of data, erase one set for programming new data. See p. 44 for details.
- 6) Select "WRITE" by rotating the trackball horizontally; then, select "No 1" or "No 2," whichever does not have data, by rotating the trackball vertically.
- 7) Push [SET] to write the new data.
 - The data comment entry display appears.
- 8) Enter the comment with the trackball and [SET]. After comment entry, set the cursor to "SET," then push [SET].
 - The data card window appears and programming is complete.
- 9) To check the comment, push [SET] again to select the RAM card menu.
- 10) Push [5] or [fish icon] to exit the menu mode.

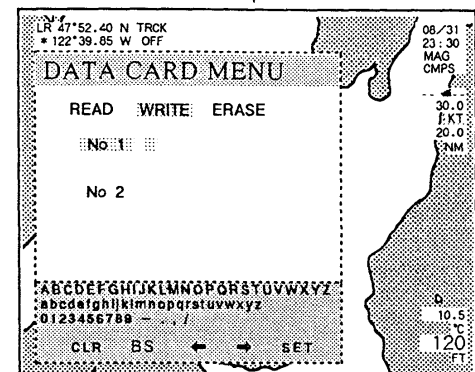
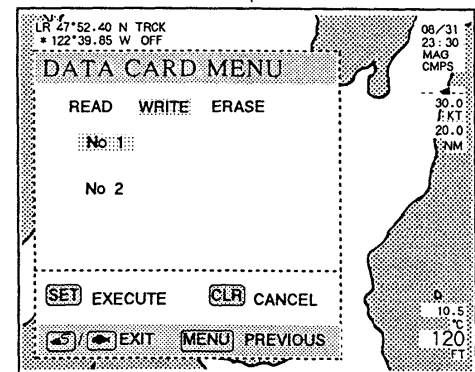
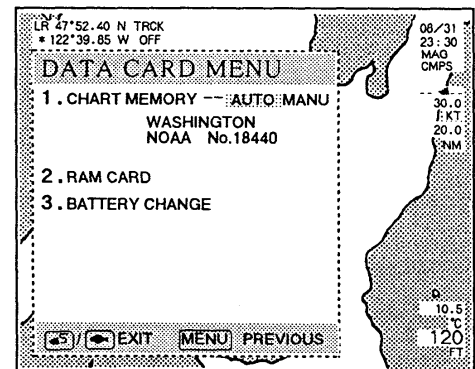

• **Data reading/erasing**

- 1) Turn OFF destination navigation and route navigation if they are activated. (pgs. 35, 36, 40)
- 2) Push [MENU] to select the menu mode.
- 3) Select "DATA CARD" by rotating the trackball vertically; then, push [SET].
 - Pushing [6] also performs this function.
 - The data card menu window appears.
- 4) Insert the RAM card into the card slot.
- 5) Select "RAM CARD" by rotating the trackball vertically; then, push [SET].
 - Pushing [2] also performs this function.
 - The RAM card window appears.
 - The comment and date of programmed data appear.
- 6) Select "READ" for reading, or "ERASE" for erasing, by rotating the trackball horizontally; then, select either data "No 1" or "No 2" by rotating the trackball vertically.
 - If destination or route navigation is activated, "READ" is indicated in blue and cannot be selected.
- 7) Push [SET] to read/erase the data.
 - The data card display appears and reading/erasing is complete.
- 8) Push [5] or [6] to exit the menu mode.

When reading a set of data

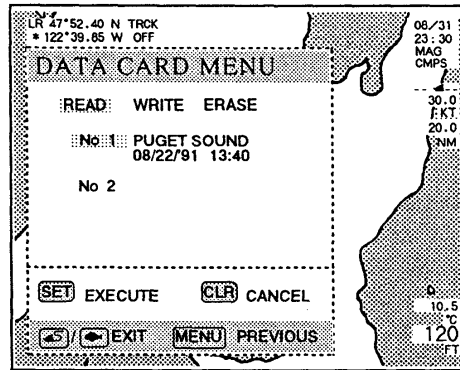

When erasing a set of data

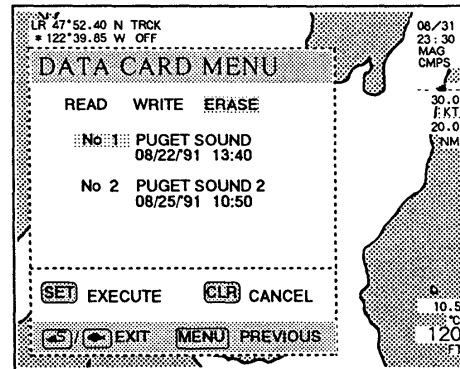

PLOTTER

• **Battery replacement**

When replacing the battery, BE SURE to follow the procedure below.

- 1) Push [MENU] to select the menu mode.
- 2) Select "DATA CARD" by rotating the trackball vertically; then, push [SET].
 - Pushing [6] also performs this function.
 - The data card menu window appears.
- 3) Insert the RAM CARD into the slot.
- 4) Select "BATTERY CHANGE" by rotating the trackball vertically; then, push [SET].
 - Pushing [3] also performs this function.
 - The display at right appears.
- 5) Pull out the RAM card; then replace the battery.
- 6) Insert the RAM card into the slot again; then, push [SET].
 - Battery replacement is complete.

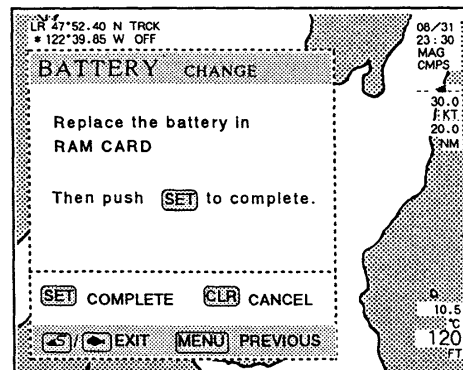

3-8 GPS data correction

GPS positioning data may differ from your actual position depending on the satellite conditions. If the GP-2000 GPS RECEIVER UNIT is connected, slight Lat/Lon adjustment can be performed from FP-100.

The GP-2000 includes an averaging function for smooth plotting. This setting can be performed in the FP-100.

• Lat/Lon correction

Lat/Lon correction is performed when your exact ship position can be figured out using a nautical chart.

CAUTION: Before correction, make sure that "GP" is indicated in the navigation receiver indicator if both the GP-2000 and RX-1203 are connected. See p. 20 for details.

The correcting value =

$$\text{Lat/Lon on the nautical chart} - \text{Lat/Lon on the screen (data from the GP-2000)}$$

- 1) Push [MENU] to select the menu mode.
- 2) Select "GPS" by rotating the trackball vertically; then, push [SET].
 - Pushing [3] also performs this function.
 - The GPS menu window appears.
- 3) Select "LAT.CORRECT" by rotating the trackball vertically; then push [SET].
 - Pushing [4] also performs this function.
 - "LAT.CORRECT" turns green.
- 4) Rotate the trackball vertically and horizontally to enter the latitude correction, then push [SET].
 - Direct digit entry can also be performed. The direction can also be changed with [SELECT].
 - "LAT.CORRECT" turns yellow.
- 5) Select "LON.CORRECT" by rotating the trackball vertically; then push [SET].
 - Pushing [5] also performs this function.
 - "LON.CORRECT" turns green.
- 6) Rotate the trackball vertically and horizontally to enter the longitude correction, then push [SET].
 - Direct digit entry can also be performed. The direction can also be changed with [SELECT].
 - "LON.CORRECT" turns yellow.
- 7) Push [←5] or [←] to exit the menu mode.

• Averaging setting

For a smooth and accurate plot, positioning data is averaged from previous data and current readings.

VALUE	AVERAGING
1	Awkward track is drawn.
1	1
10	Recommended value.
1	1
999	Too smooth a track is drawn.

For GPS averaging function details, see the GP-2000 instruction manual.

- 1) Push [MENU] to select the menu mode.
- 2) Select "GPS" by rotating the trackball vertically; then, push [SET].
 - Pushing [3] also performs this function.
 - The GPS menu window appears.
- 3) Select "AVERAGING" by rotating the trackball vertically; then push [SET].
 - Pushing [6] also performs this function.
 - "AVERAGING" turns green.
- 4) Rotate the trackball vertically and horizontally to select the averaging value in the range of 1 - 999; then, push [SET].
 - Direct digit entry can also be performed.
 - "AVERAGING" turns yellow.
- 5) Push [←5] or [←] to exit the menu mode.

3-9 Loran-C data correction

If an optional RX-1203 LORAN-C RECEIVER UNIT has been installed, receiving data can be corrected in the plotter menu. There are 2 types of corrections: Lat/Lon and TD1/TD2 (delay time of slave stations).

Both Lat/Lon and TD1/TD2 are required for exact correction. However, for rough corrections, only one may be enough.

CAUTION: Before Lat/Lon or TD1/TD2 correction, make sure that "LR" is indicated in the navigation receiver indicator if both the GP-2000 and RX-1203 are connected. See p. 20 for details.

• Lat/Lon correction

Lat/Lon correction is performed when your exact vessel position can be figured out using a nautical chart.

The correcting value =

Lat/Lon on the nautical chart -

Lat/Lon on the screen (data from the RX-1203)

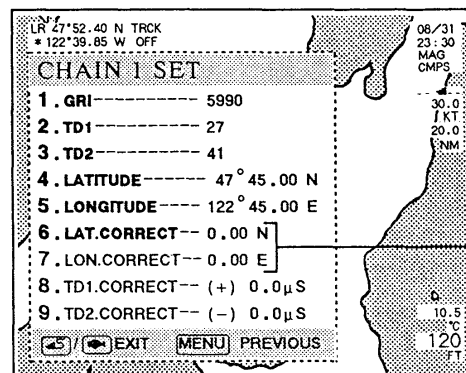
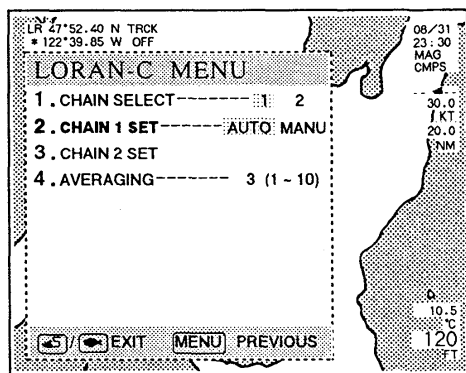

- 1) Push [MENU] to select the menu mode.
- 2) Select "LORAN-C" by rotating the trackball vertically; then, push [SET].
 - Pushing [4] also performs this function.
 - The Loran-C menu window appears.
- 3) Select "CHAIN 1 SET" or "CHAIN 2 SET" by rotating the trackball vertically; then, push [SET].
 - Select "CHAIN 1 SET" when "1" is selected in "CHAIN SELECT"
 - Select "CHAIN 2 SET" when "2" is selected in "CHAIN SELECT"
 - Pushing [2] or [3] also performs this function.
 - The chain setting window appears when "CHAIN 2 SET" is selected.
- 4) When "CHAIN 1 SET" is selected, "CHAIN 1 SET" turns green. Push [SET] to display the chain setting window.
 - The chain setting window appears.
- 5) Select "LAT.CORRECT" by rotating the trackball vertically; then push [SET].
 - Pushing [6] also performs this function.
 - "LAT.CORRECT" turns green.
- 6) Rotate the trackball vertically and horizontally to enter the longitude correction, then push [SET].
 - Direct digit entry can also be performed. The direction can also be changed with [SELECT].
 - "LAT.CORRECT" turns yellow.
- 7) Select "LON.CORRECT" by rotating the trackball vertically; then push [SET].
 - Pushing [7] also performs this function.
 - "LON.CORRECT" turns green.
- 8) Rotate the trackball vertically and horizontally to enter the longitude correction, then push [SET].
 - Direct digit entry can also be performed. The direction can also be changed with [SELECT].
 - "LON.CORRECT" turns yellow.
- 9) Push [←S] or [←] to exit the menu mode.

PLOTTER

3 PLOTTER OPERATION

• Time delay correction

Time Delay (TD) correction can be performed when you have a loran table for TD correction.

- 1) Push [MENU] to select the menu mode.
- 2) Select "LORAN-C" by rotating the trackball vertically; then, push [SET].
 - Pushing [4] also performs this function.
 - The Loran-C menu window appears.
- 3) Select "CHAIN 1 SET" or "CHAIN 2 SET" by rotating the trackball vertically; then, push [SET].
 - Select "CHAIN 1 SET" when "1" is selected in "CHAIN SELECT"
 - Select "CHAIN 2 SET" when "2" is selected in "CHAIN SELECT"
 - Pushing [2] or [3] also performs this function.
 - The chain setting window appears when "CHAIN 2 SET" is selected.
- 4) When "CHAIN 1 SET" is selected, "CHAIN 1 SET" turns green. Push [SET] to display the chain setting window.
 - The chain setting window appears.
- 5) Select "TD1.CORRECT" by rotating the trackball vertically; then push [SET].
 - Pushing [8] also performs this function.
 - "TD1.CORRECT" turns green.
- 6) Rotate the trackball vertically and horizontally to enter the TD1 (delay time for slave station 1) correction, then push [SET].
 - Direct digit entry can also be performed, +/- can also be changed with [SELECT].
 - "TD1.CORRECT" turns yellow.
- 7) Select "TD2.CORRECT" by rotating the trackball vertically; then push [SET].
 - Pushing [9] also performs this function.
 - "TD2.CORRECT" turns green.
- 8) Rotate the trackball vertically and horizontally to enter the TD2 (delay time for slave station 2) correction, then push [SET].
 - Direct digit entry can also be performed, +/- can also be changed with [SELECT].
 - "TD2.CORRECT" turns yellow.
- 9) Push [5] or [fish] to exit the menu mode.

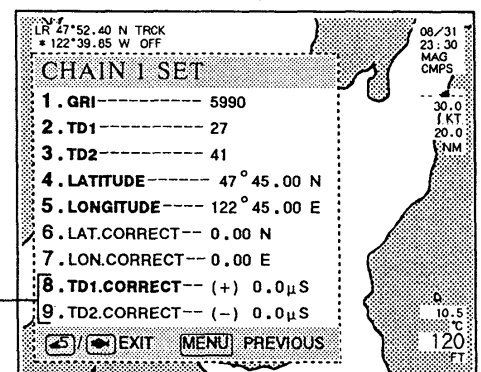
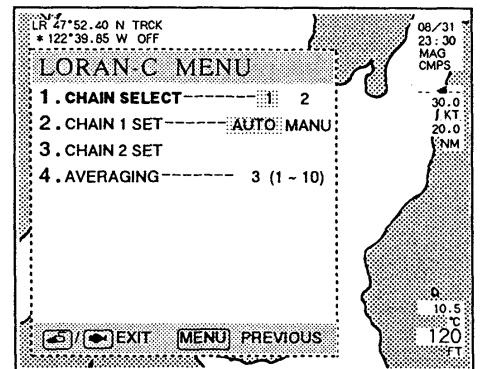
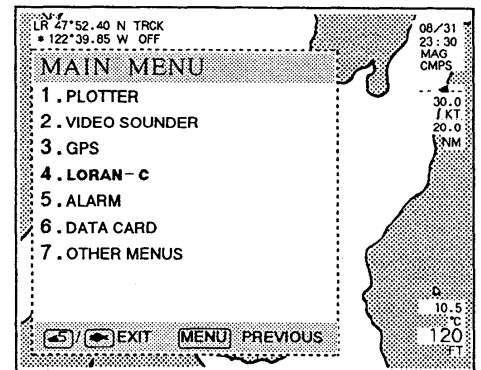

• Cycle jump correction

When your vessel position is distant from a Loran-C station or in a fringe area, the loran signal may be distorted, causing your receiver to catch the wrong cycle.

The RX-1203 catches the 3rd cycle of the loran signal. When the signal is too distorted, the 2nd or 4th cycle may be caught, thus a 3 mile miscalculation may result. In such a case, the ECD readout will be outside the 10 ~ 25 range.

Even if receiving another cycle, the actual position can be indicated, by correcting the delay time with compulsion. One cycle is 10 μs, so that cycle adjustment can be performed in 10 μs steps.

ECD READOUT INFORMATION

DISPLAYED VALUE	SIGNAL CONDITION
00	BAD ("CYC" may appear). This value shows a strong possibility of front cycle receiving.
01 ~ 09	These values show a possibility of front cycle receiving.
10 ~ 25	GOOD.
26 ~ 33	These values show a possibility of rear cycle receiving.
34	BAD ("CYC" may appear). This value shows a strong possibility of rear cycle receiving.

- 1) Push [5] to select the plotter screen window.
- 2) Select the yellow "LORAN MONITOR" by rotating the trackball vertically; then, push [SET].
 - Pushing [4] also performs this function.
 - The loran monitor screen appears.
- 3) Rotate the trackball downwards vertically to select the station with a distorted signal, "GRI," or "TD1" or "TD2."
 - Selected station is indicated with a blue belt.
- 4) Push [SET].
 - "0" appears.
- 5) Rotate the trackball vertically to select the cycle adjusting time.
 - - 30 ~ + 30 can be selected.
- 6) Push [SET].
 - The selected value is erased, but the cycle jump functions using the selected value.

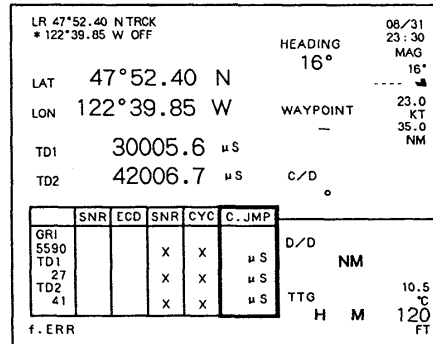

Loran-C monitor screen

• Averaging setting

For a smooth and accurate plot, positioning data is averaged with previous data and current readings.

VALUE	AVERAGING
1	Awkward track is drawn.
2	
3	Recommended value.
4 ~ 9	
10	Too smooth a track is drawn.

- 1) Push [MENU] to select the menu mode.
- 2) Select "LORAN-C" by rotating the trackball vertically; then, push [SET].
 - Pushing [4] also performs this function.
 - The Loran-C menu window appears.
- 3) Select "AVERAGING" by rotating the trackball vertically; then push [SET].
 - Pushing [4] also performs this function.
 - "AVERAGING" turns green.
- 4) Rotate the trackball vertically and horizontally to select the average value in the range of 1 ~ 10; then, push [SET].
 - Direct digit entry can also be performed.
 - "AVERAGING" turns yellow.
- 5) Push [5] or [] to exit the menu mode.

4 SOUNDER OPERATION

4-1 Selecting sounder mode

- 1) Push [POWER] to turn power ON.
 - Either the plotter mode, sounder mode, or combination mode screen will appear depending on what screen was selected before the power was turned OFF.
- 2) Push [] to select the sounder mode when the plotter mode has been selected.
 - The video sounder is activated with all settings, such as mode, depth range, phase shift, etc. at previously set values.
 - To turn the power OFF, push and hold [POWER] for 1 sec.



Power ON

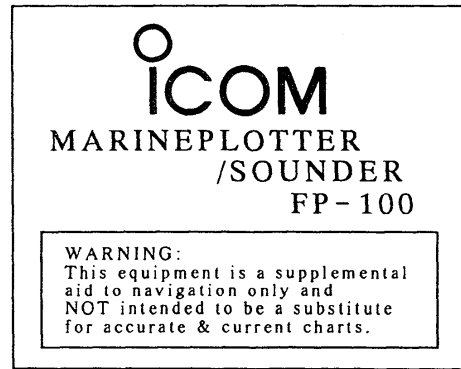

Opening display

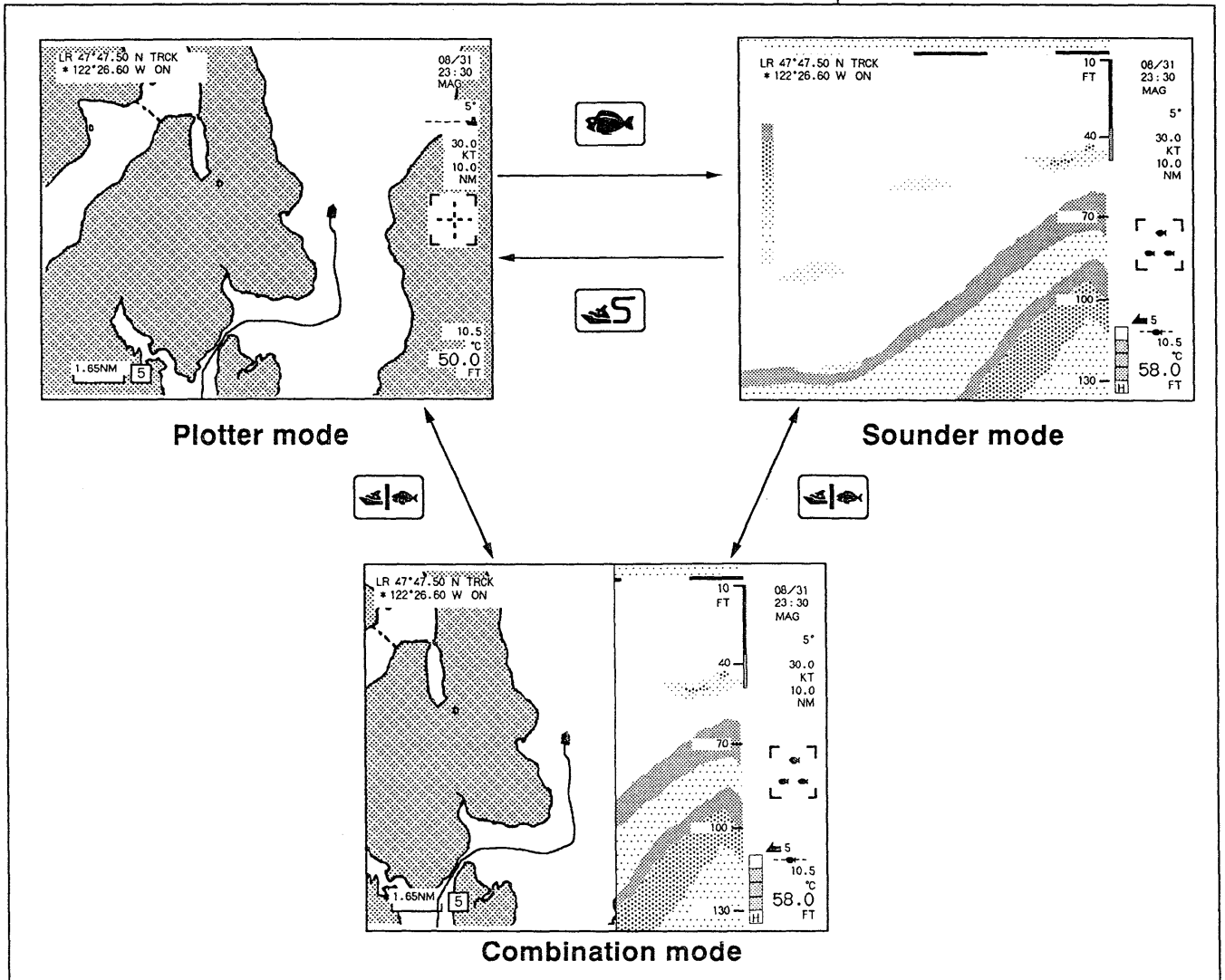

SOUNDER

■ Sounder mode

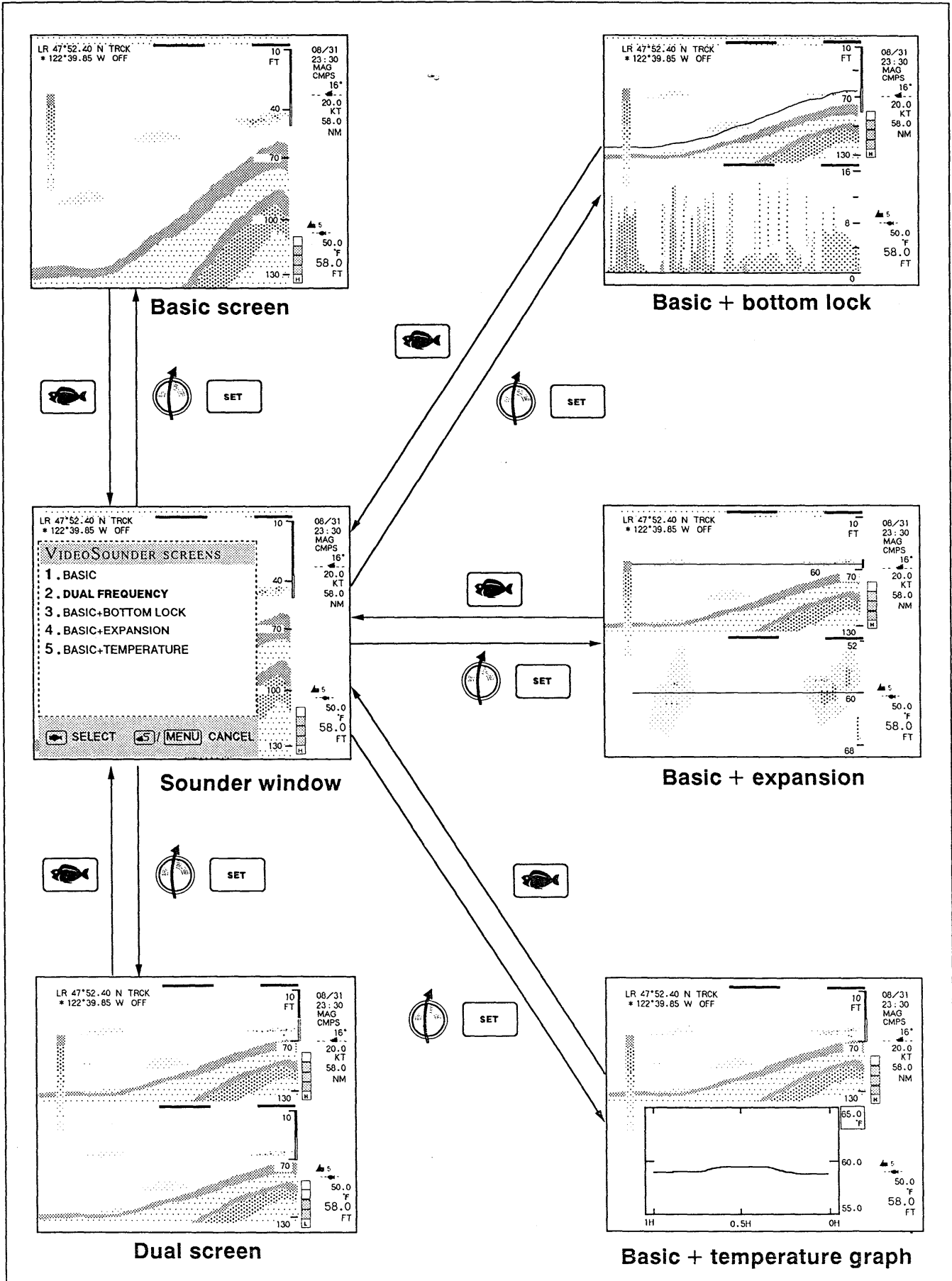

SOUNDER

4 SOUNDER OPERATION

■ Compulsory settings

The following operations are required for using the sounder. For details of each setting, see pgs. 57 ~ 58.

① **Basic screen selection** (p. 50)

Select the basic screen.

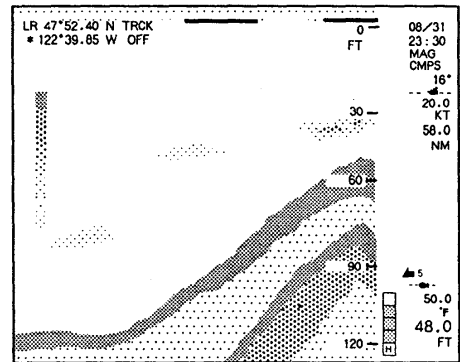

② **Depth range setting** (p. 57)

Push [RANGE/SHIFT]; then, select the depth range with the trackball or [Δ]/[▽].

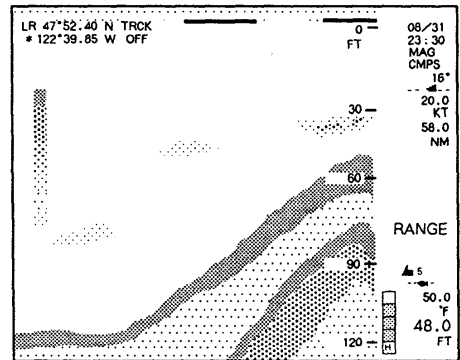

③ **Phase shift setting** (p. 57)

Push and hold [RANGE/SHIFT] until "SHIFT" appears; then, select the phase shift with the trackball or [Δ]/[▽].

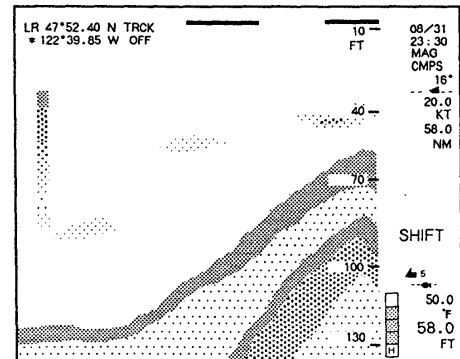

④ **Sensitivity adjustment** (p. 58)

Push [GAIN/STC]; then, set the sensitivity with the trackball or [Δ]/[∇].

- When sensitivity is adjusted with the remote controller, the value set by the front panel control becomes invalid.

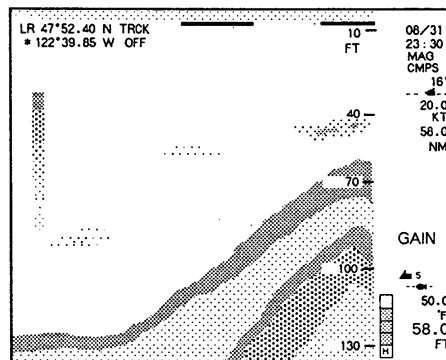

⑤ **Sensitivity of outer layer adjustment**

(p. 58)

Push and hold [GAIN/STC] until "STC" appears; then, set the STC with the trackball or [Δ]/[∇].

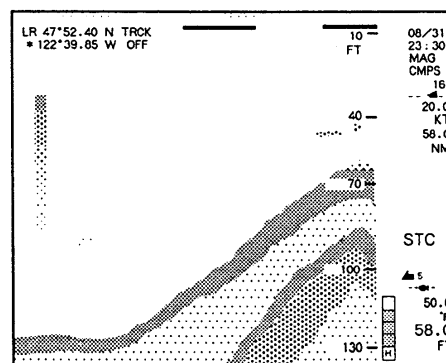

SOUNDER

Basic screen

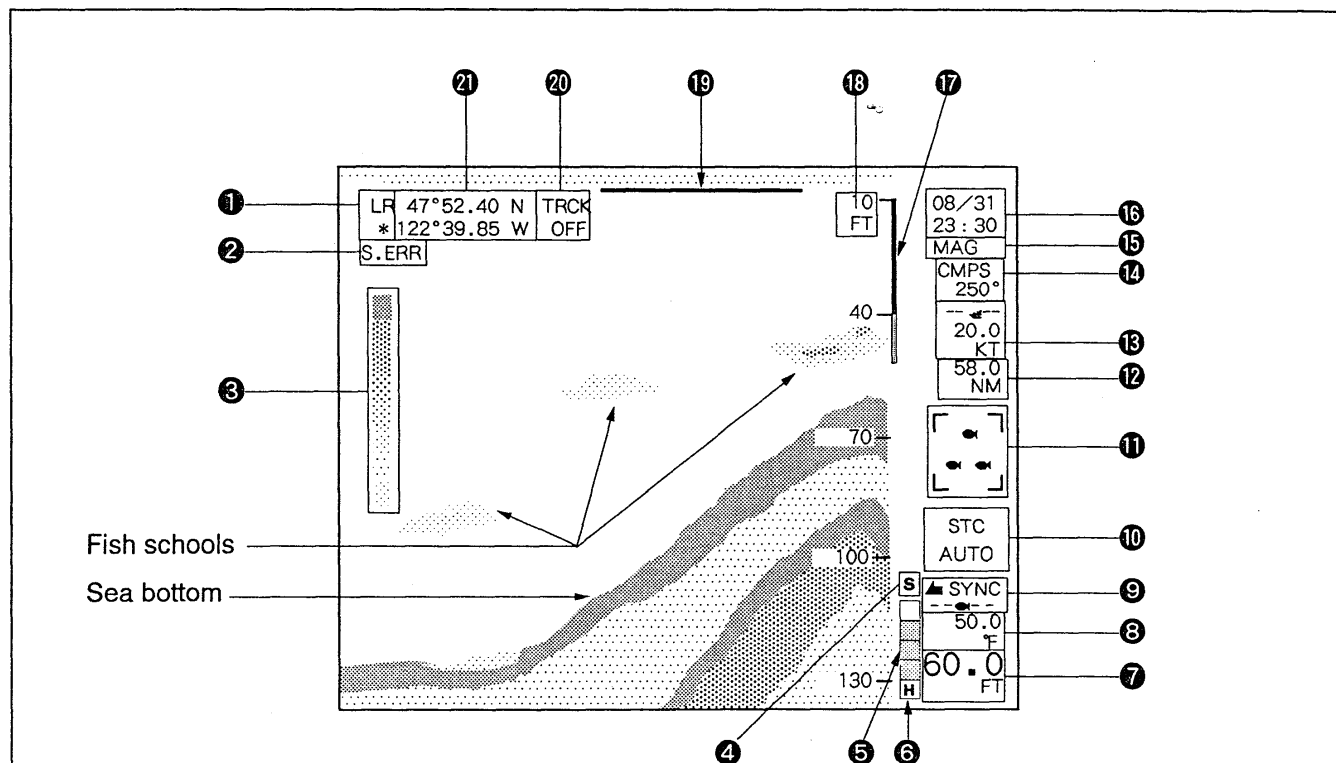

- 1 NAVIGATION RECEIVER INDICATOR** (p. 20)
Displays navigation receiver being used.
- 2 POSITIONING DATA ERROR INDICATOR**
"S.ERR" appears when the positioning equipment sends error signals.

"R.ERR" appears when the FP-100 cannot receive positioning data for more than 10 sec.
- 3 COLOR BAR** (p. 67)
Shows the color reference.
• All colors may not be displayed when the noise reduction is activated.
- 4 STC INDICATOR** (p. 58)
Shows the sensitivity bar is displaying the STC value.
- 5 SENSITIVITY BAR** (p. 58)
Shows the selected sensitivity value.
• When "S" is indicated above, it shows the STC value.
- 6 FREQUENCY INDICATOR** (p. 59)
Shows the selected frequency.
• "H" shows 200 kHz is selected.
• "L" shows 50 kHz is selected.
- 7 WATER DEPTH READOUT**
Shows the water depth.
- 8 DISPLAY SPEED INDICATOR** (p. 64)
Shows the selected display speed.
• One of "1" ~ "5" or "SYNC" appears and the fish character moves corresponding to the selected display speed.
- 9 FUNCTION INDICATOR**
Shows the activated setting condition or function.
• "RANGE" is for depth range.
• "SHIFT" is for phase shift.
• "GAIN" is for sensitivity.
• "STC" is for STC.
• "VRM" is for variable range marker.
• "ZOOM" is for expansion or bottom lock range and temperature graph display time period.
• "AUTO" is for the auto function.
- 10 CONDITION INDICATOR** (p. v)
Shows the condition. See p. v for details.
- 11 TRIP LOG READOUT** (p. 74)
Shows the trip log.
- 12 VESSEL SPEED READOUT** (p. 75)
Shows the vessel speed.
• The boat character moves corresponding to your vessel speed.
- 13 WATER TEMPERATURE READOUT**
Shows the water temperature.
- 14 MAG**
- 15 08/31 23:30**
- 16 STC AUTO**
- 17 NAVIGATION RECEIVER INDICATOR**
- 18 WATER DEPTH READOUT**
- 19 STC INDICATOR**
- 20 POSITIONING DATA ERROR INDICATOR**
- 21 NAVIGATION RECEIVER INDICATOR**

Dual screen

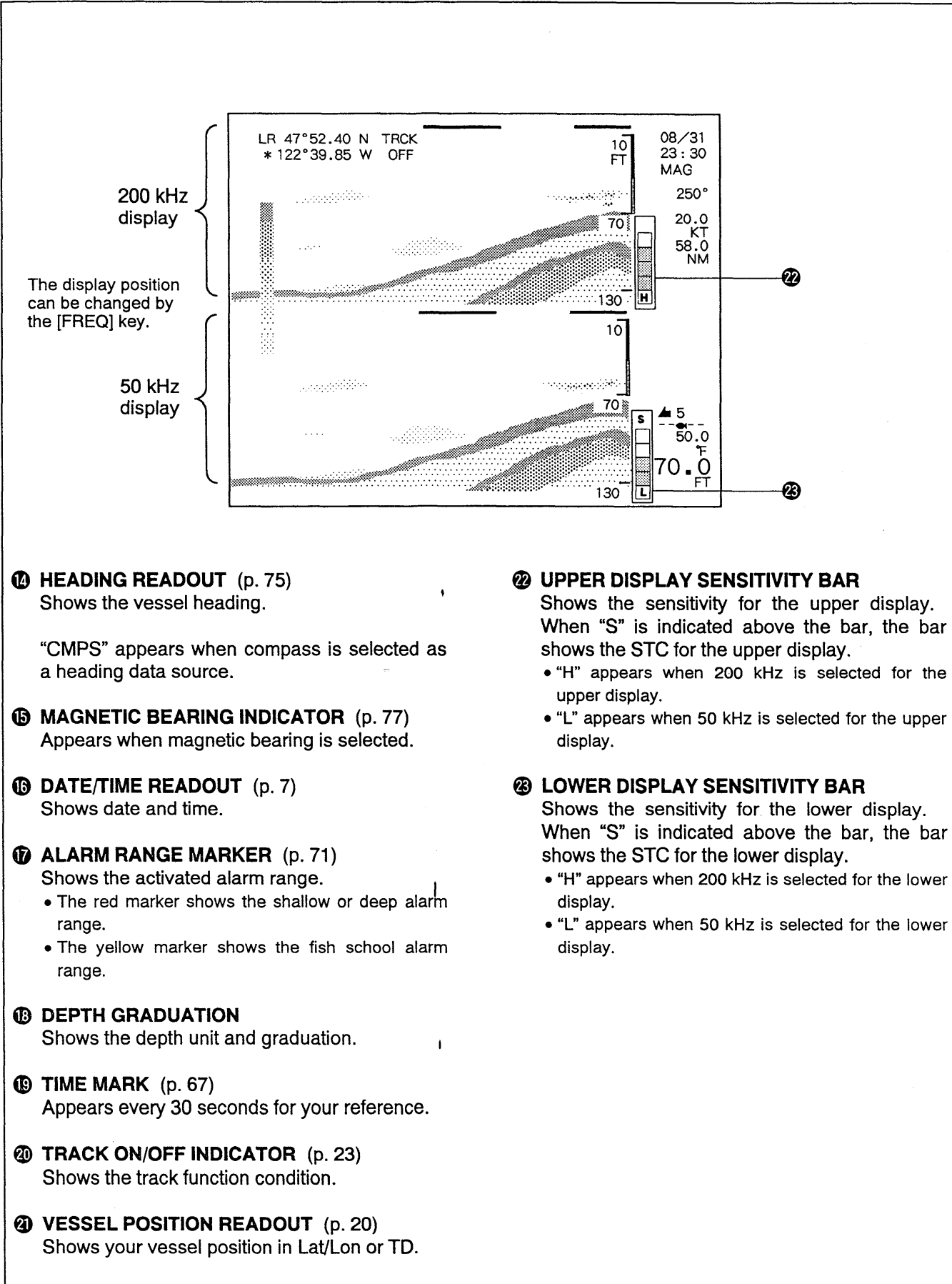

14 HEADING READOUT (p. 75)
Shows the vessel heading.

"CMPS" appears when compass is selected as a heading data source.

15 MAGNETIC BEARING INDICATOR (p. 77)
Appears when magnetic bearing is selected.

16 DATE/TIME READOUT (p. 7)
Shows date and time.

17 ALARM RANGE MARKER (p. 71)
Shows the activated alarm range.

- The red marker shows the shallow or deep alarm range.
- The yellow marker shows the fish school alarm range.

18 DEPTH GRADUATION
Shows the depth unit and graduation.

19 TIME MARK (p. 67)
Appears every 30 seconds for your reference.

20 TRACK ON/OFF INDICATOR (p. 23)
Shows the track function condition.

21 VESSEL POSITION READOUT (p. 20)
Shows your vessel position in Lat/Lon or TD.

22 UPPER DISPLAY SENSITIVITY BAR
Shows the sensitivity for the upper display. When "S" is indicated above the bar, the bar shows the STC for the upper display.

- "H" appears when 200 kHz is selected for the upper display.
- "L" appears when 50 kHz is selected for the upper display.

23 LOWER DISPLAY SENSITIVITY BAR
Shows the sensitivity for the lower display. When "S" is indicated above the bar, the bar shows the STC for the lower display.

- "H" appears when 200 kHz is selected for the lower display.
- "L" appears when 50 kHz is selected for the lower display.

SOUNDER

■ Basic + bottom lock screen

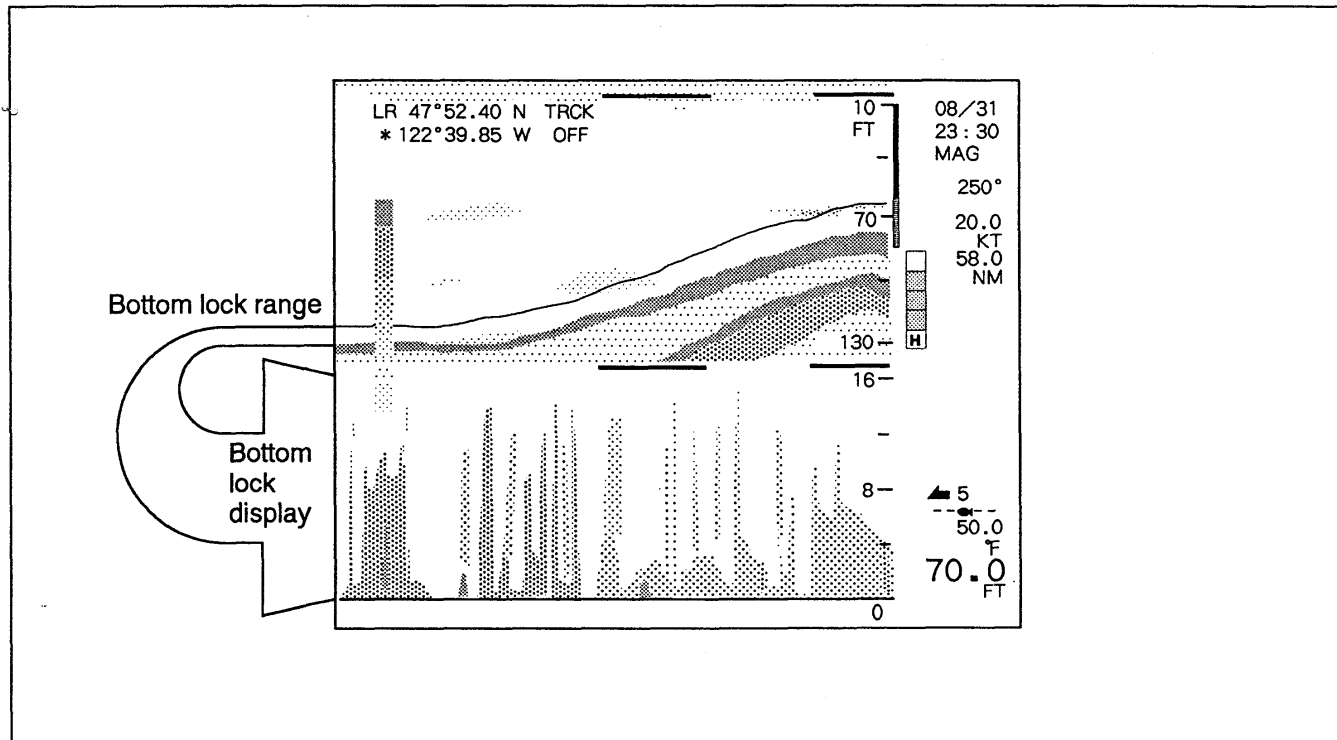

■ Basic + expansion screen

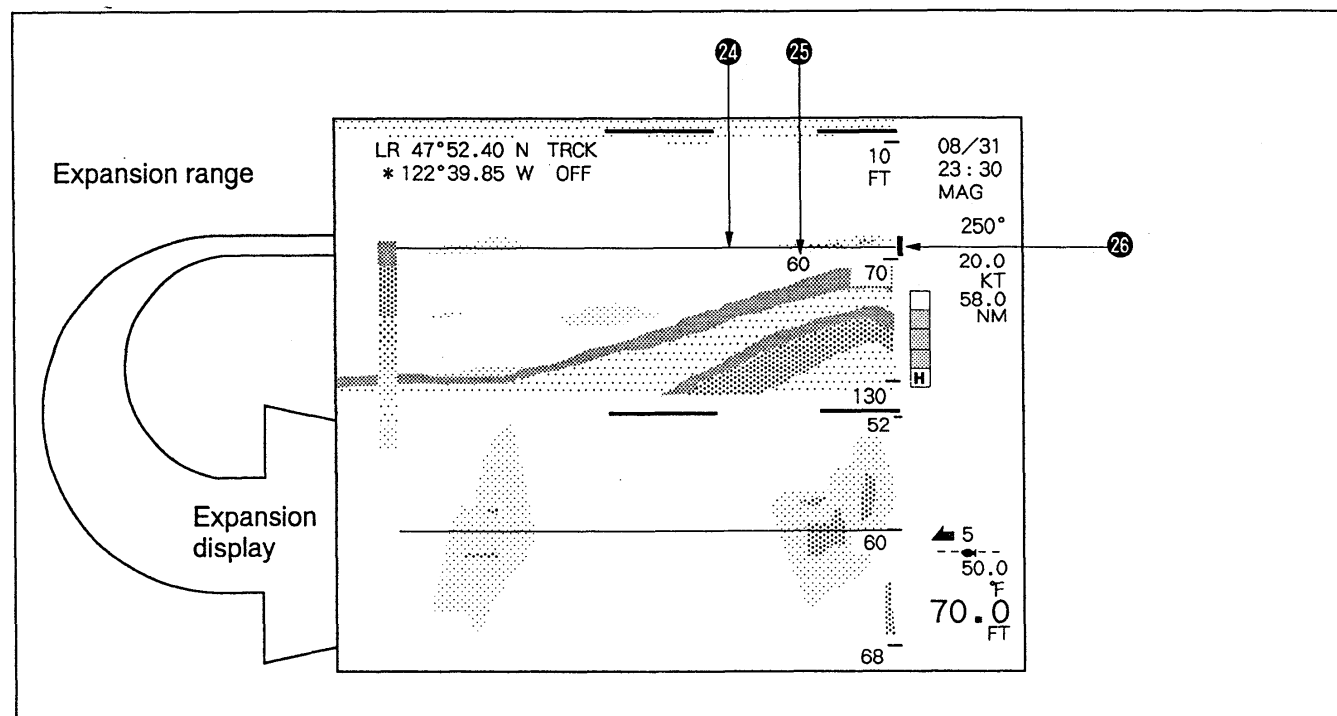

- 24 VARIABLE RANGE MARKER (VRM)** (p. 60)
 This marker determines the center of the expansion display.
 • Move the marker to your desired depth with the [VRM/ZOOM] key plus trackball or the [Δ]/[▽] keys.

- 25 VRM DEPTH** (p. 60)
 Shows the depth of the variable range marker.

- 26 EXPANSION RANGE MARKER** (p. 61)
 Shows the expansion range from the basic screen display.

SOUNDER

Basic + temperature graph screen

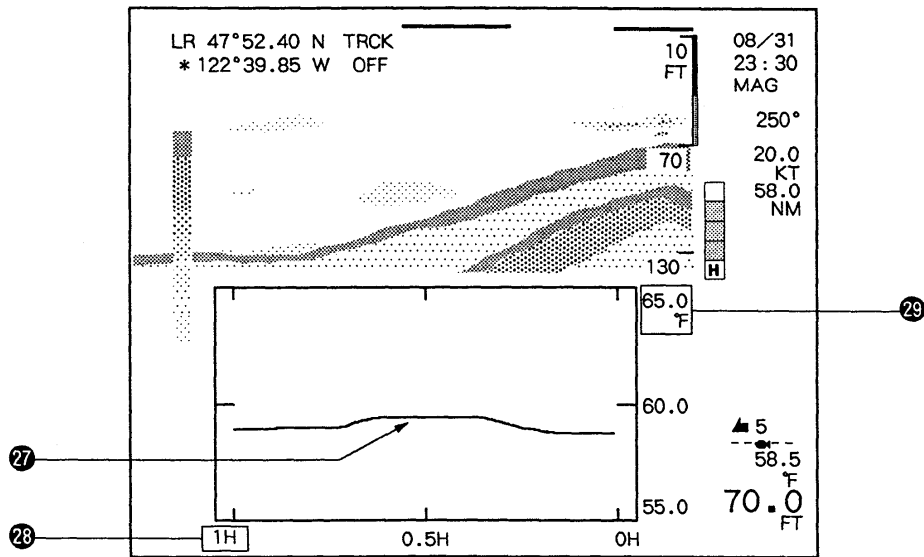

27 TEMPERATURE GRAPH

Shows the temperature fluctuation over time.

28 TIME PERIOD (p. 61)

Shows the amount of time passed on the graph.

- This value can be changed.

29 TEMPERATURE (p. 61)

Shows the temperature range of the graph.

- This value is automatically set, and cannot be set manually.

SOUNDER

4-2 Basic settings

■ Depth range setting

Depth range is the displayed water depth range on the CRT.

Set the depth range of the display properly.

- Too narrow a setting shows no bottom figure and too wide a setting shows a narrow water range.

- 1) Push [RANGE/SHIFT].
 - "RANGE" appears.
- 2) Rotate the trackball vertically to set the proper depth range.
 - Pushing [△]/[▽] also performs this function.
 - The depth graduation shifts.

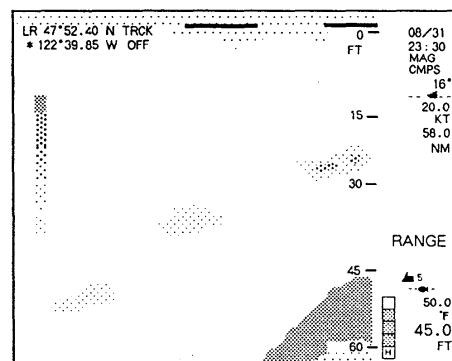

The following 3 units can be used: These units should be selected in the set mode. (p. 7)

- M (Meters)
- FT (Feet)
- FM (Fathoms)

■ Phase shift setting

Phase shift will shift the set depth range in a deeper direction. Set the phase shift at the point where the depth range of the display should begin.

If a 10 FT phase shift is set while 0 ~ 120 FT depth range has been set, the CRT screen shows a 10 ~ 130 FT depth range display.

When you want to observe the display from the outer layer (surface) to the bottom, set the phase shift to "0."

- 1) Push and hold [RANGE/SHIFT] for 3 sec.
 - "SHIFT" appears.
- 2) Rotate the trackball vertically to set the desired phase shift.
 - Pushing [△]/[▽] also performs this function.
 - The depth graduation shifts.
 - When the phase shift is set improperly, error message, "X" appears.

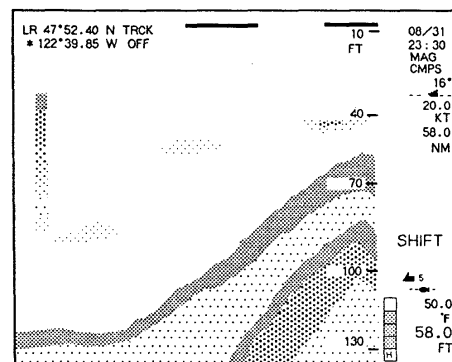

Sensitivity adjustment

Sensitivity is a very important factor in obtaining the best picture. Sensitivity is adjusted against the signal reflecting from the sea bottom. BE SURE to adjust the sensitivity.

- Sensitivities for the 200 kHz (high frequency) and 50 kHz (low frequency) ultrasonic waves are adjusted separately.

- 1) Push [GAIN/STC]
 - "GAIN" appears.
 - If the dual screen is selected, push [FREQ] to select the adjusting display: high or low.
- 2) Rotate the trackball vertically.
 - Pushing [Δ]/[▽] also performs this function.
 - Rotating the trackball upward or pushing [Δ] increases the sensitivity gain.
 - Rotating the trackball downward or pushing [▽] decreases the sensitivity gain.

Set the sensitivity so that the sea floor becomes reddish-brown and the sea noise (blue) is eliminated.

Adjustment by front panel controls

- 1) Push the [PUSH ON] switch in the hatch cover.
- 2) Rotate [HIGH] for adjustment of high frequency or [LOW] for adjustment of low frequency.

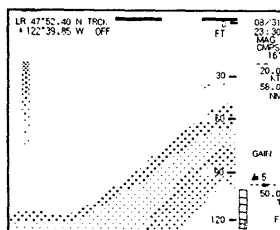

Too low

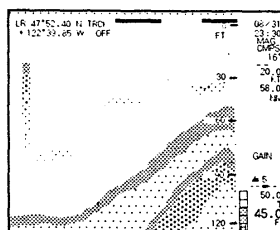

Correct

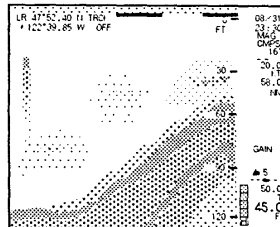

Too high

Sensitivity of outer layer adjustment

STC (Sensitivity Time Control) can erase the outer layer noise caused by bubbles. To remove noise and to obtain a clear picture, STC decreases the sensitivity of the outer layer.

- STCs for the 200 kHz (high frequency) and 50 kHz (low frequency) ultrasonic waves are adjusted separately.

- 1) Push and hold [GAIN/STC] for 3 sec.
 - "STC" appears.
 - If the dual screen is selected, push [FREQ] to select the adjusting display: high or low.
- 2) Rotate the trackball vertically to adjust the STC.
 - Pushing [Δ]/[▽] also performs this function.
 - [Δ] increases the STC gain.
 - [▽] decreases the STC gain.

NOTE: If STC is set at too high a gain, the sensitivity of a shallow sea bottom is affected. STC is not effective when the phase shift is set to more than 5 m.

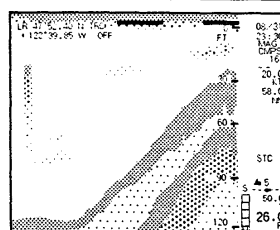

Too low

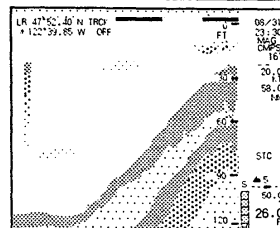

Correct

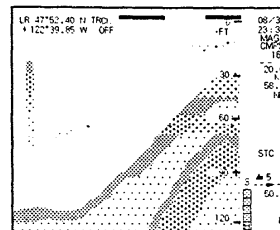

Too high

Frequency selection

The FP-100 has 2 ultrasonic wave emitting capabilities. Select a frequency of 50 kHz or 200 kHz, for your convenience.

Push [FREQ] to select the desired frequency.

- "H" appears when 200 kHz is selected. 200 kHz is suitable for finding fish school densities and fish on the sea bottom.
- "L" appears when 50 kHz is selected. 50 kHz is suitable for searching large areas and for examination of bottom geology.

NOTE: When the dual screen is selected, the [FREQ] key exchanges the position of the two pictures.

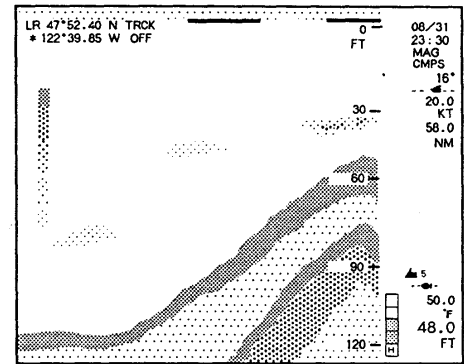

200 kHz of High frequency.

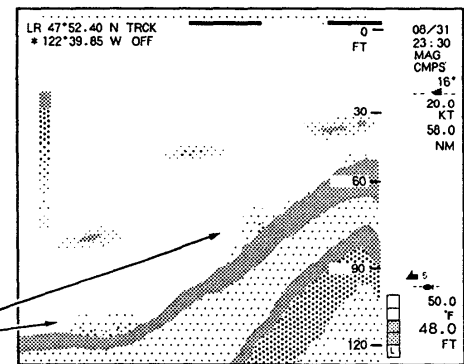

Fish schools on the bottom

50 kHz of Low frequency.

4-3 Advanced settings

■ Depth measuring (VRM)

Exact water depth of fish schools, sea bottom, etc. can be measured with the variable range marker on the CRT screen.

- 1) Push [VRM/ZOOM].
 - "VRM" and the variable range marker appears.
- 2) Rotate the trackball vertically to set the variable range marker.
 - Pushing [△]/[▽] also performs this function.
 - The digital depth indication shows the water depth of the variable range marker.
- 3) To turn OFF the variable range marker, push [VRM/ZOOM].
 - "VRM" and the variable range marker disappears.

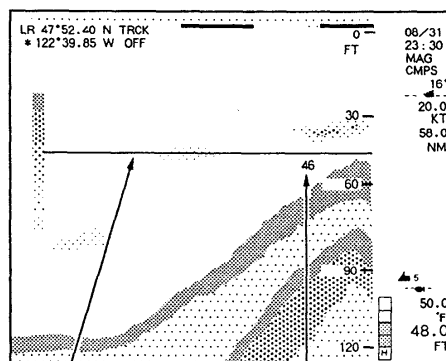

VRM (Variable Range Marker)

■ Range of bottom lock

The bottom lock function locks the bottom line horizontally and gives you bottom expansion display for easy observation near the sea bottom.

The range of the bottom expansion display can be adjusted through 6 steps.

- 1) Select the basic + bottom lock screen. (p. 50)
- 2) Push and hold [VRM/ZOOM] for 3 sec.
 - "ZOOM" appears.
- 3) Rotate the trackball vertically to set the range from the sea bottom for bottom expansion.
 - Pushing [△]/[▽] also performs this function.
 - The bottom lock depth graduation shifts.

NOTE: When the sea bottom line does not appear on the basic display because of, for example, incorrect phase shift setting, etc. the bottom expansion display does not appear.

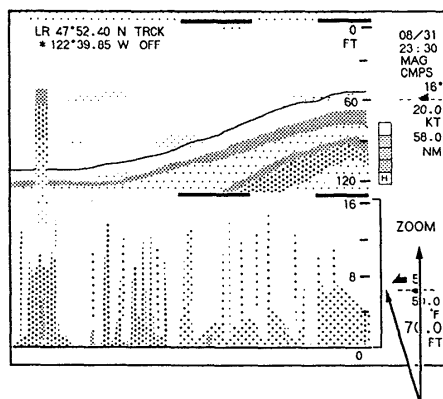

This range can be changed when "ZOOM" appears.

SOUNDER

Range of expansion

The expansion function provides expansion display around the variable range marker for detailed observation of underwater activity such as fish schools.

The display range of expansion can be adjusted through 6 steps.

- 1) Select the basic + expansion screen. (p. 50)
- 2) Set the variable range marker to the center of the desired expansion range:
 - Push [VRM/ZOOM], then set the marker with the trackball or [△]/[▽]. (p. 60)
- 3) Push and hold [VRM/ZOOM] for 3 sec.
 - "ZOOM" appears.
- 4) Select the desired expansion range by rotating the trackball vertically.
 - Pushing [△]/[▽] also performs this function.
 - The expansion scale shifts.
 - To move the variable range marker, push [VRM/ZOOM] to enter the VRM setting condition.

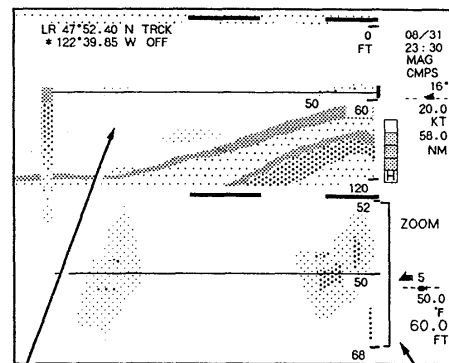

Set the VRM to the desired position when "VRM" appears.

This range can be changed when "ZOOM" appears.

Period of temperature graph

The display period of the temperature graph can be shifted.

- 1) Select the basic + temperature graph screen. (p. 50)
- 2) Push and hold [VRM/ZOOM] for 3 sec.
 - "ZOOM" appears.
- 3) Push [△]/[▽] several times or rotate the trackball horizontally to set the period.

To display temperature graph, a temperature sensor is necessary. Some transducers have the necessary sensor.

Icom offers the EX-1010 THROUGH-HULL TYPE TRANSDUCER and EX-983 SPEED/TEMPERATURE SENSOR as options.

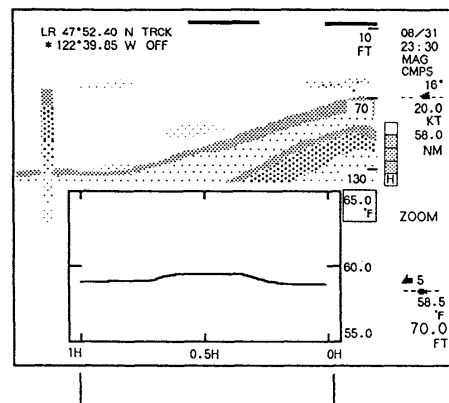

This range can be changed when "ZOOM" appears.

Auto function

The auto function controls depth range and sensitivity automatically.

When the auto function is activated, manual adjustment is not necessary for the depth range and sensitivity.

- 1) Make sure the sensitivity, STC, and depth range have suitable values.
 - Red "AUTO" appears.
- 2) Push [GAIN/STC] and [RANGE/SHIFT] simultaneously.
 - [GAIN], [RANGE] and [SHIFT] cannot be used when this function is activated. The front panel controls also cannot be used.
- 3) To cancel the function, push [GAIN/STC] and [RANGE/SHIFT] simultaneously again.
 - "AUTO" disappears.

NOTE: While the auto function has been activated, STC can be used to adjust the sensitivity of the outer layer. To use the STC, push and hold [GAIN/STC] until "STC" appears on the display.

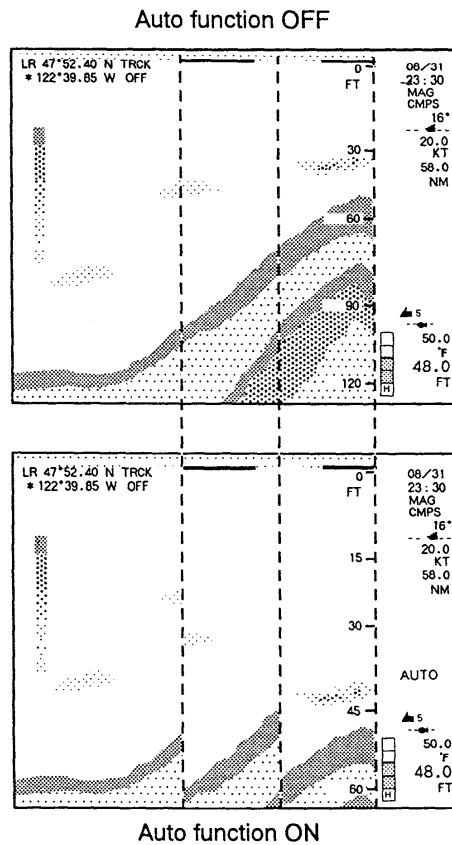

Pause function

The display movement can be paused (frozen) at a desired point. This is convenient for observing fish schools, sea bottom, etc.

Push [PAUSE] to pause the display movement when you desire. To resume the display movement, push [PAUSE] again.

NOTE: To stop (not pause) the display movement, set the display speed to "0." See p. 64 for details.

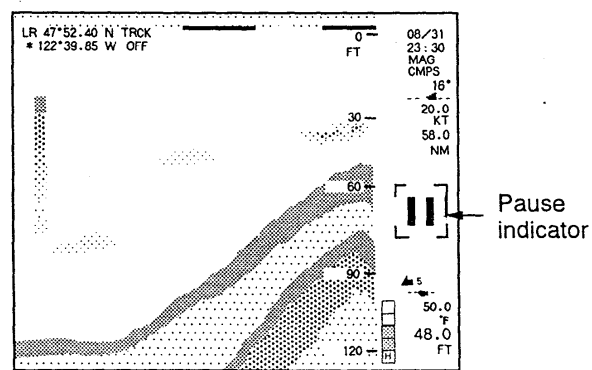

SOUNDER

4 SOUNDER OPERATION

4-4 Sounder menus

The FP-100 includes 8 advanced functions for the sounder as described on pgs 63 ~ 66.

■ Interference rejection

This function reduces the interference from other video sounders or from the generator of your ship. It can be turned ON or OFF for your convenience.

- 1) Push [MENU] to select the menu mode.
- 2) Select "VIDEO SOUNDER" by rotating the trackball vertically; then, push [SET].
 - Pushing [2] also performs this function.
 - Sounder menu window appears.
- 3) Select "I.R." (Interference Rejection) by rotating the trackball vertically; then, push [SET].
 - Pushing [1] also performs this function.
 - "I.R." turns green.
- 4) Rotate the trackball horizontally to select "ON" or "OFF".
- 5) Push [SET] to set the condition.
 - "I.R." turns yellow.

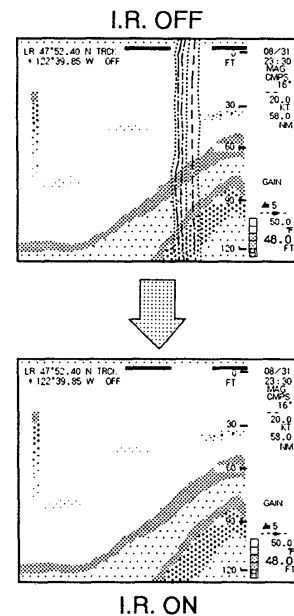

■ Noise reduction

This function suppresses background noise caused by dirty water, etc. Select the desired reduction level among levels 1 ~ 5 or OFF.

- 1) Push [MENU] to select the menu mode.
- 2) Select "VIDEO SOUNDER" by rotating the trackball vertically; then, push [SET].
 - Pushing [2] also performs this function.
 - Sounder menu window appears.
- 3) Select "N.R." (Noise Reduction) by rotating the trackball vertically; then, push [SET].
 - Pushing [2] also performs this function.
 - "N.R." turns green.
- 4) Rotate the trackball vertically or horizontally to select the desired level or OFF.
- 5) Push [SET] to set the condition.
 - "N.R." turns yellow.

Level	Description	Function
1	Min. noise reduction	Blue noise reduced.
2	}	Gray noise reduced.
3		Cyan noise reduced.
4		Green noise reduced.
5	Max. noise reduction	Light green noise reduced.

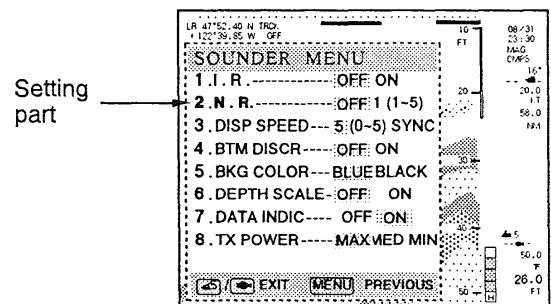

NOTE: If the noise reduction is set to level 4 or 5, small fish schools may not be displayed on the screen.

Display speed setting

The sweep speed of the display can be adjusted through 6 steps. Moreover, speed synchronization is possible.

- When high speed is selected, the display is expanded horizontally for easy analysis.
- When slow speed is selected, the display is reduced horizontally.

- 1) Push [MENU] to select the menu mode.
- 2) Select "VIDEO SOUNDER" by rotating the trackball vertically; then, push [SET].
 - Pushing [2] also performs this function.
 - Sounder menu window appears.
- 3) Select "DSP SPEED" by rotating the trackball vertically; then, push [SET].
 - Pushing [3] also performs this function.
 - "DSP SPEED" turns green.
- 4) Rotate the trackball vertically or horizontally to select the desired speed from 0 to 5 or select "SYNC" for synchronization.
 - The larger the number, the higher the speed.
- 5) Push [SET] to set the speed.
 - "DSP SPEED" turns yellow.

Level 2

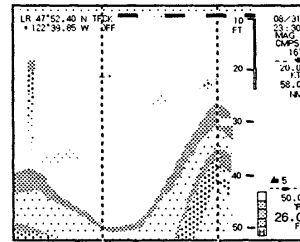

Level 4

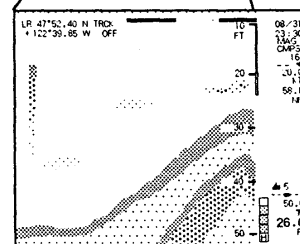

LEVEL	DISPLAY SWEEP SPEED
0	Freeze
1	Slow
2 ~ 4	Fast
5	Fast
SYNC	Synchronized to vessel speed

Bottom discrimination

The bottom discrimination function removes the color of the sea bottom (reddish brown, red and purple) for easy discrimination of fish schools. This function can be turned ON or OFF for your convenience.

- 1) Push [MENU] to select the menu mode.
- 2) Select "VIDEO SOUNDER" by rotating the trackball vertically; then, push [SET].
 - Pushing [2] also performs this function.
 - Sounder menu window appears.
- 3) Select "BTM DISCR" by rotating the trackball vertically; then, push [SET].
 - Pushing [4] also performs this function.
 - "BTM DISCR" turns green.
- 4) Rotate the trackball horizontally to select "ON" or "OFF."
- 5) Push [SET] to set the condition.
 - "BTM DISCR" turns yellow.

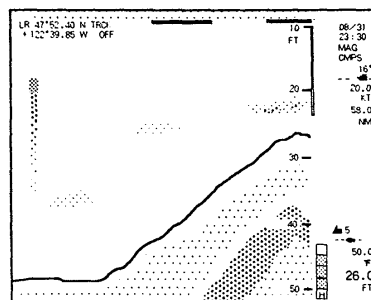

Bottom discrimination ON

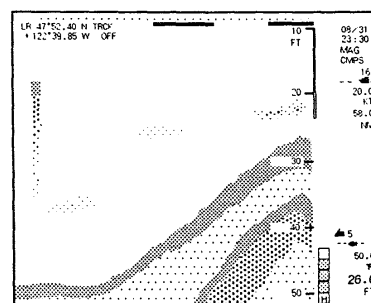

Bottom discrimination OFF

SOUNDER

4 SOUNDER OPERATION

■ Display background color

Dark blue or black can be selected as a background color.

- 1) Push [MENU] to select the menu mode.
- 2) Select "VIDEO SOUNDER" by rotating the trackball vertically; then, push [SET].
 - Pushing [2] also performs this function.
 - Sounder menu window appears.
- 3) Select "BKG COLOR" by rotating the trackball vertically; then, push [SET].
 - Pushing [5] also performs this function.
 - "BKG COLOR" turns green.
- 4) Rotate the trackball horizontally to select "BLUE" or "BLACK."
- 5) Push [SET] to set the color.
 - "BKG COL" turns yellow while the background color simultaneously changes color.

Setting part

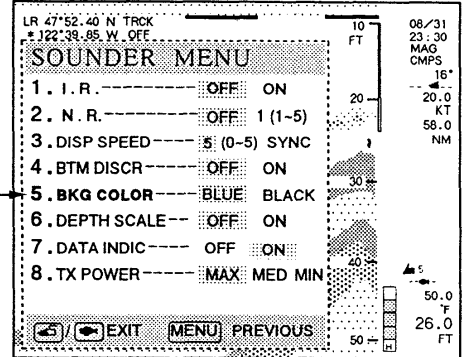

■ Depth scale

The depth scale indication can be turned ON and OFF. The depth scale is convenient for rough measurement of water depth.

- 1) Push [MENU] to select the menu mode.
- 2) Select "VIDEO SOUNDER" by rotating the trackball vertically; then, push [SET].
 - Pushing [2] also performs this function.
 - Sounder menu window appears.
- 3) Select "DEPTH SCALE" by rotating the trackball vertically; then, push [SET].
 - Pushing [6] also performs this function.
 - "DEPTH SCALE" turns green.
- 4) Rotate the trackball horizontal to select "ON" or "OFF."
- 5) Push [SET] to set the condition.
 - "DEPTH SCALE" turns yellow.

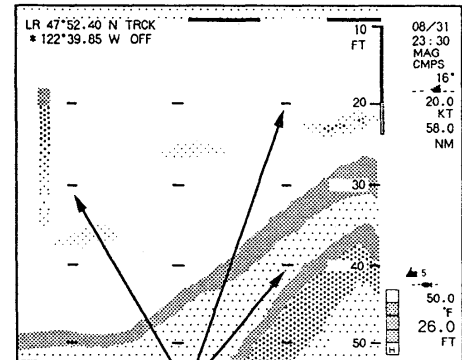

Depth scale

Setting part

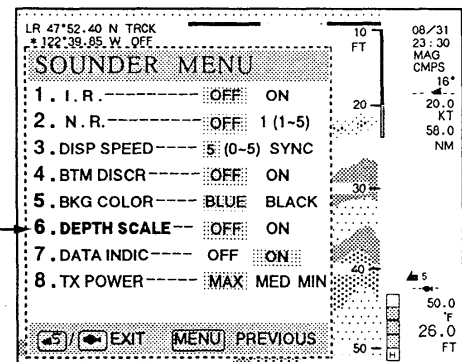

Data indication

The color bar and data indication can be turned ON and OFF.

- 1) Push [MENU] to select the menu mode.
- 2) Select "VIDEO SOUNDER" by rotating the trackball vertically; then, push [SET].
 - Pushing [2] also performs this function.
 - Sounder menu window appears.
- 3) Select "DATA INDIC" by rotating the trackball vertically; then, push [SET].
 - Pushing [7] also performs this function.
 - "DATA INDIC" turns green.
- 4) Rotate the trackball horizontally to select "ON" or "OFF."
- 5) Push [SET] to set the condition.
 - "DATA INDIC" turns yellow.

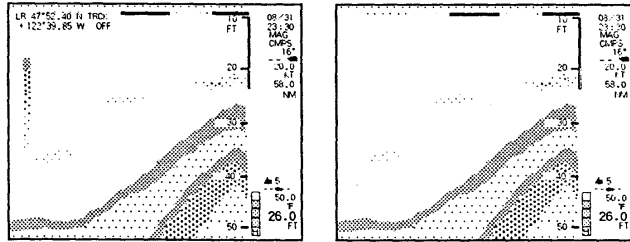

Data indication ON

Data indication OFF

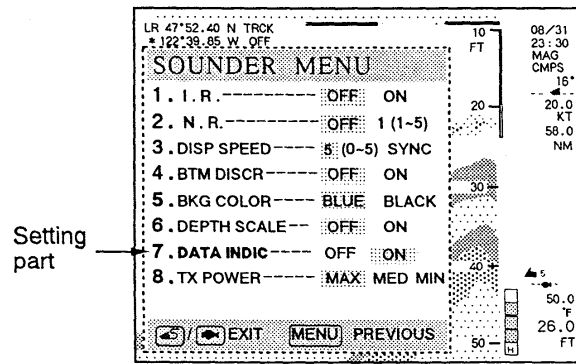

Setting part

Transmit power

Use "MAX" power when searching deep sea floors or for small fish. Use "MIN" power when searching shallow sea floors or for big fish.

- 1) Push [MENU] to select the menu mode.
- 2) Select "VIDEO SOUNDER" by rotating the trackball vertically; then, push [SET].
 - Pushing [2] also performs this function.
 - Sounder menu window appears.
- 2) Select "TX POWER" by rotating the trackball vertically; then, push [SET].
 - Pushing [8] also performs this function.
 - "TX POWER" turns green.
- 4) Rotate the track ball horizontally to select "MAX," "MED" or "MIN."
- 5) Push [SET] to set the power.
 - "TX POWER" turns yellow.

MIN	Minimum power
MED	Medium power
MAX	Maximum power

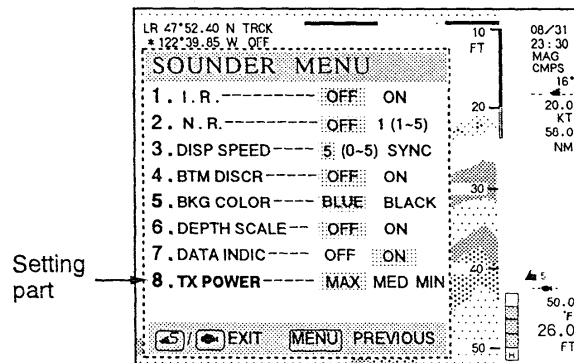

Setting part

SOUNDER

4-5 Display interpretation

■ Color bar and time mark

This section explains the displays which were not covered in the previous sections.

• **Color bar**

The FP-100 displays the intensity of the echo signal in 12 colors as in the following diagram.

- The color bar can be turned off in the menu mode. See p. 66 "Data indication" for details.
- The background color can be selected in dark blue or black. See p. 65 for details.

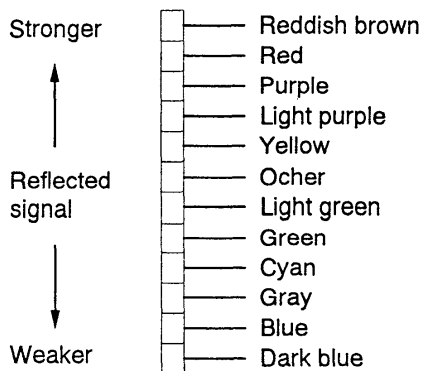

• **Time mark**

The time mark is displayed every 30 sec. on the upper part of the screen. The time mark indicates elapsed time.

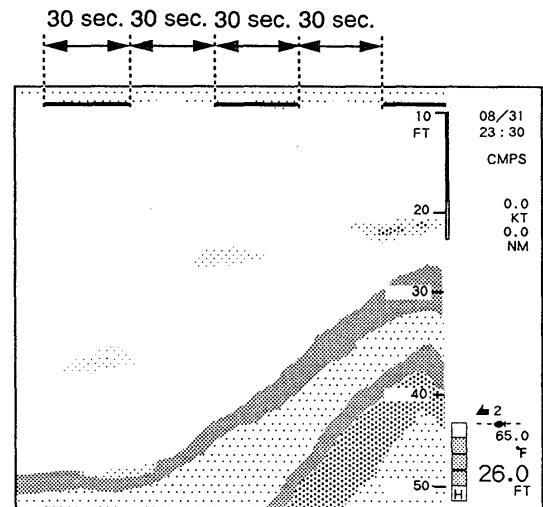

■ Echo from the sea bottom

Echoes from the sea floor are normally the strongest and are displayed in reddish brown, but the color and width will vary with bottom composition, water depth, frequency, sensitivity, etc.

The color and width of the bottom echo can be used to help determine the density of the bottom material (soft or hard). The harder the bottom, the wider the trace. If the gain is set to show only a single bottom echo on mud, a rocky bottom will show a second or third bottom return.

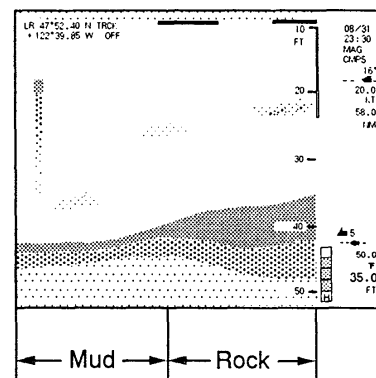
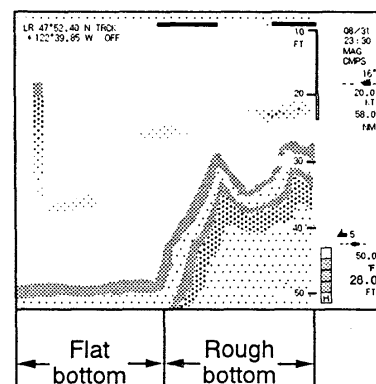

SOUNDER

■ Fish school echoes

Fish schools will generally be plotted between the surface and the sea bottom. Usually the fish school/fish echo is weaker than the bottom echo because the reflection surface and the reflection proper are much smaller compared to the bottom. The size of the fish school can be ascertained from the density of the display.

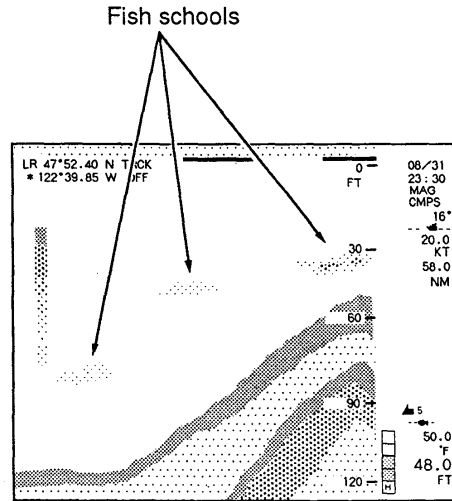

■ Second echo

At relatively shallow depths, a high gain setting and a strong bottom echo will cause a second or sometimes, a third or fourth echo, to be displayed in the same interval below the first echo trace. This is because the echo travels between the sea floor and surface two or more times in shallow depths.

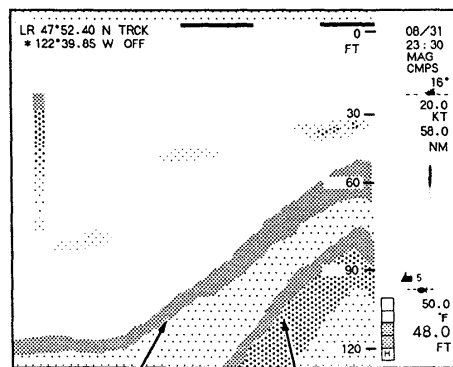

SOUNDER

Plankton and tidal current

A plankton layer is made up of masses of marine microbes which are displayed as cloud-like layers between the surface and the sea bottom and may cover a wide depth range.

Plankton are an important link in the food chain for most game fish and locating their position can be quite beneficial to productive fishing. Plankton are sensitive to light and, as a result, swim to deep water during daylight and rise to shallower depths at night.

The picture of the tidal current layer is similarly sloped to that of the plankton layer, however, unlike the plankton layer, it is not spread over a wide depth range.

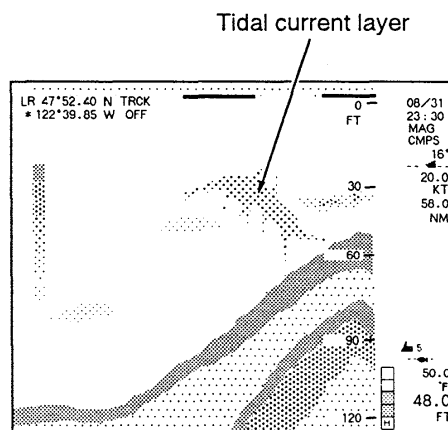
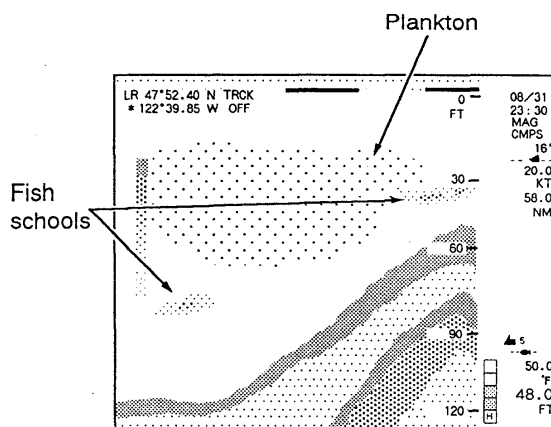

Thermoclines

Thermoclines are layers formed between areas of water at different temperatures. The temperature breakline will sometimes reflect an echo back to the transducer and will appear on the display as a very thin and weak line between the surface and the sea bottom.

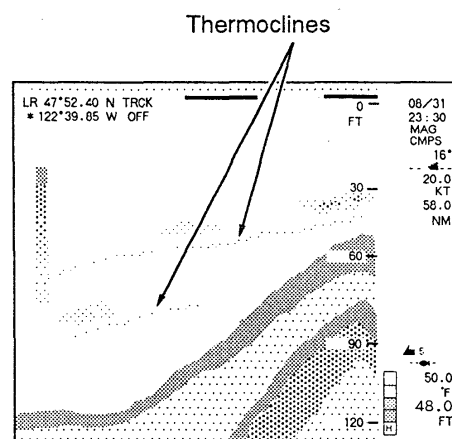

Aeration

When the vessel sails in its own wake as it goes astern or when it sails in waves of a rough sea, aerated water may cover the face of the transducer. The bottom line may not be displayed due to a reduction in transmission/reception sensitivity of the ultrasonic waves.

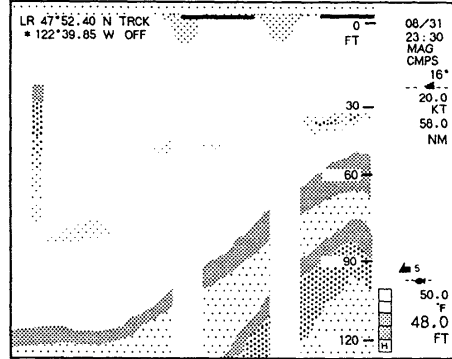
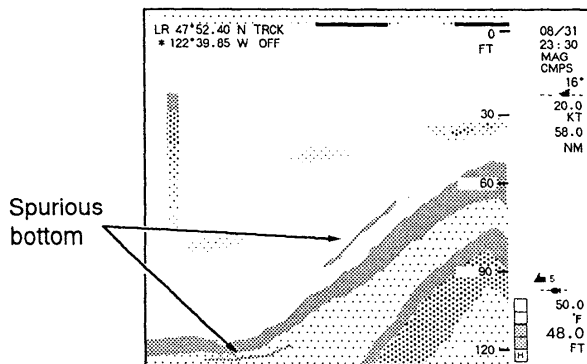
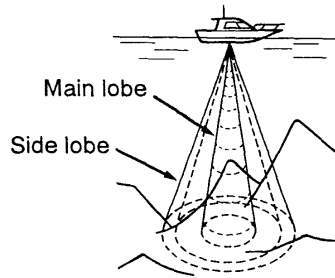

Image caused by aerated water

Spurious bottom lines by side lobes

Spurious bottom lines may appear because the transducer has side lobes.

They appear as weak lines above a rough bottom, or as weak lines beneath a floating bottom.



Spurious bottom

4-6 Sounder alarms

■ Alarm types

The FP-100 has 4 types of sounder alarms to suit your operating needs.

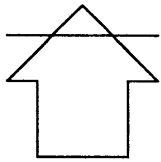
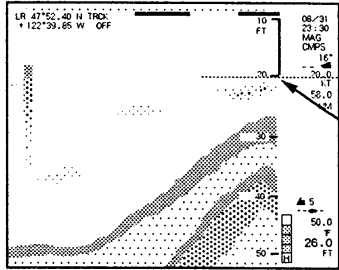
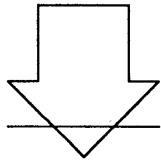
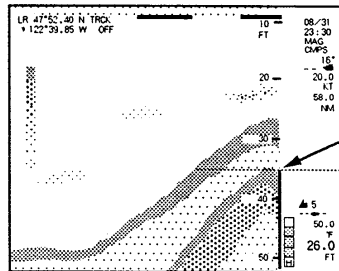
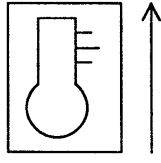
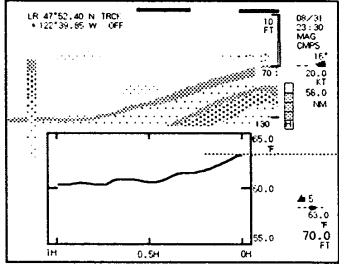
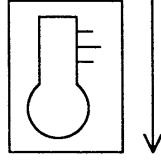
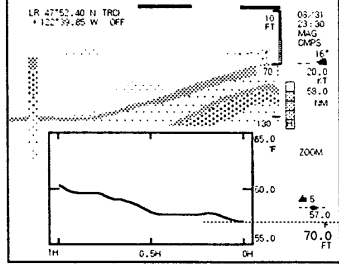
ALARM	INDICATION	FUNCTION	EXAMPLE
Shallow		The alarm sounds when the sea bottom appears shallower than the shallow alarm setting.	
Deep		The alarm sounds when the sea bottom appears deeper than the deep alarm setting.	
Temperature (up)		The alarm sounds when the water temperature goes above a pre-set high temperature.	
Temperature (down)		The alarm sounds when the water temperature goes below a pre-set low temperature.	

• Combination alarm

The fish school alarm consists of a shallow and a deep alarm.

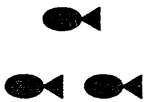
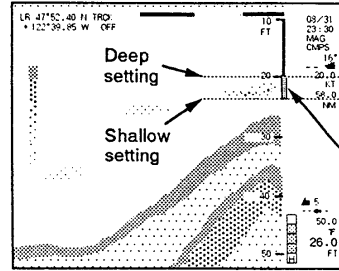
ALARM	INDICATION	FUNCTION	EXAMPLE
Fish school		The alarm sounds when a fish school appears in the watching range.	

SOUNDER

Alarm setting

Set the desired alarm. Multiple alarms can be activated simultaneously.

- 1) Push [MENU] to select MENU mode.
- 2) Rotate the trackball to select "ALARM," then push [SET].
 - Pushing [5] also performs this function.
 - The alarm menu window appears.
- 3) Rotate the trackball to select the desired alarm, then push [SET].
 - Digit keys can also be used to select an alarm.
 - Numbers 1 ~ 4 are plotter alarms.
- 4) Rotate the trackball horizontally to select the values (not "OFF"), then rotate it vertically to select the depth value or temperature.
 - To cancel the setting, select "OFF."
 - The units of depth and temperature can be changed in the set mode. (p. 7)
 - To set the fish school alarm, set the shallow alarm to deep and deep alarm to shallow. Both alarms must be set.
- 5) Push [SET] to set the alarm.
 - The alarm is activated.
- 6) When setting more than one alarm, repeat steps 3 ~ 5 above.
- 7) Push [←5] or [←] to exit the menu mode.

NOTE: The fish school alarm is activated with the shallow alarm simultaneously.

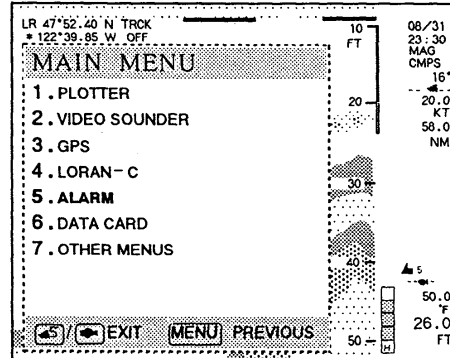

Sounder alarms

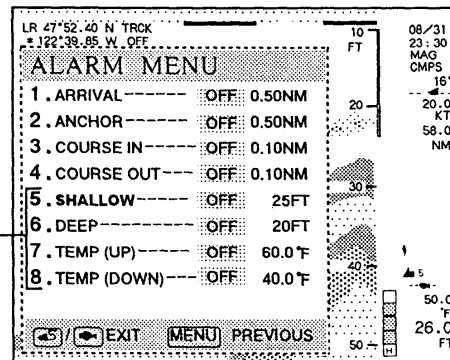

SOUNDER

Alarm operation

When the sea bottom or the temperature meets a pre-set condition, the alarm sounds.

To stop the alarm sound, push [CLR].

NOTE 1: If the sea bottom or the temperature meets a pre-set condition again, the alarm sounds again.

NOTE 2: The fish school alarm keeps sounding until the fish school disappears even if [CLR] is pushed.

To cancel the alarm setting, select "OFF" in step 4 of the above box.

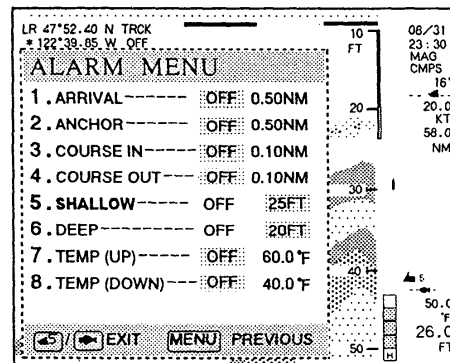

This example shows the fish school alarm is activated.

5 COMMON FUNCTIONS

Screen memory

Function description

The FP-100 includes 9 screen memories which memorize screen information and settings activated for both the plotter and sounder. The desired memory can easily be recalled at any time for your convenience.

The following contents will be memorized:

- Chart size
- Selected plotter screen
- Selected sounder screen
- Depth range setting
- Phase shift setting
- Sensitivity setting
- Selected frequency
- STC setting
- Expansion rate
- Auto function ON/OFF
- Combination display and rate

Calling up a memory

- 1) Push [MR] in any mode except for MENU mode.
 - "MR" and all memory numbers appear.
 - The red memory numbers have been programmed.
 - The white memory numbers have not been programmed.
- 2) Push the desired number key corresponding to the programmed memory (marked red).
 - The memorized contents are called up.
 - When a memory is called up in the plotter mode, your vessel is automatically displayed at the center of the screen.

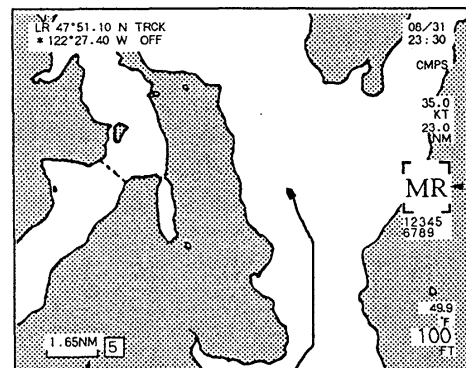

"MR" appears.

Programming a memory

The selected mode and all settings are memorized at present. If you want to change the settings, change them before programming a memory.

- 1) Push and hold [MR] for 3 sec. when "MR" is not displayed.
 - "MW" appears.
 - When "MR" is displayed, push [MR] to turn it OFF, then push and hold [MR] for 3 sec.
- 2) Push the desired number key corresponding to the memory number (marked white) to be programmed.
 - "MW" disappears and programming is complete.

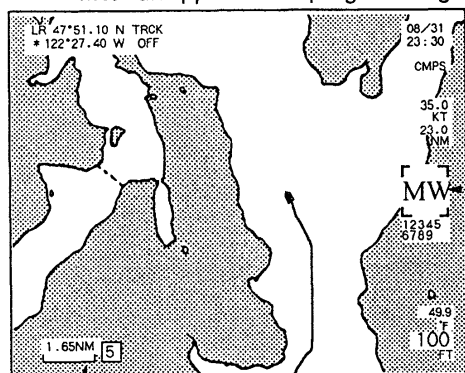

"MW" appears.

Erasing memory

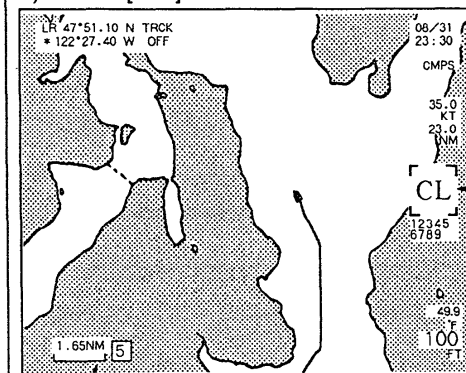

- 1) Push and hold [MR] for 3 sec. when "MR" is not displayed.
 - "MW" appears.
 - When "MR" is displayed, push [MR] to turn it OFF, then push and hold [MR] for 3 sec.
- 2) Push [Δ] or [∇].
 - "CL" appears.
- 3) Push the desired number key corresponding to the memory number (marked red) to be erased.
- 4) Push [MR] to turn OFF "CL."



"CL" appears.

Key illumination

The remote control key backlighting can be turned ON or OFF for your convenience.

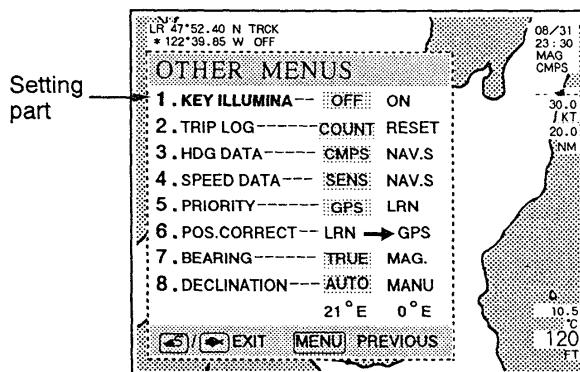

- 1) Push [MENU] to select the menu mode.
- 2) Select "OTHER MENU" by rotating the trackball vertically; then, push [SET].
 - Pushing [7] also performs this function.
 - The other menu window appears.
- 3) Select "KEY ILLUMINA" by rotating the trackball vertically; then, push [SET].
 - Pushing [1] also performs this function.
 - "KEY ILLUMINA" turns green.
- 4) Rotate the trackball to select "ON" or "OFF."
- 5) Push [SET] to set the condition.
- 6) Push [] or [] to exit the menu mode.



Trip log

The trip log can be used for measuring the distance between your present position and a future position.

This function can be performed at any time. When you want to start counting, proceed as follows:

- 1) Push [MENU] to select the menu mode.
- 2) Select "OTHER MENU" by rotating the trackball vertically; then, push [SET].
 - Pushing [7] also performs this function.
 - The other menu window appears.
- 3) Make sure that "SENS" is selected for the "4. SPEED DATA."
 - See p. 75 for selection details.
- 4) Select "TRIP LOG" by rotating the trackball vertically; then, push [SET].
 - Pushing [2] also performs this function.
 - "TRIP LOG" turns green.
- 5) Rotate the trackball to select "RESET."
 - "RESET" turns yellow.
- 6) Push [SET] to start counting.
 - "COUNT" turns yellow and counting starts.
- 7) Push [] or [] to exit the menu mode.

NOTE: A speed sensor is necessary for trip log indication. Icom offers an optional EX-983 SPEED/TEMPERATURE SENSOR.

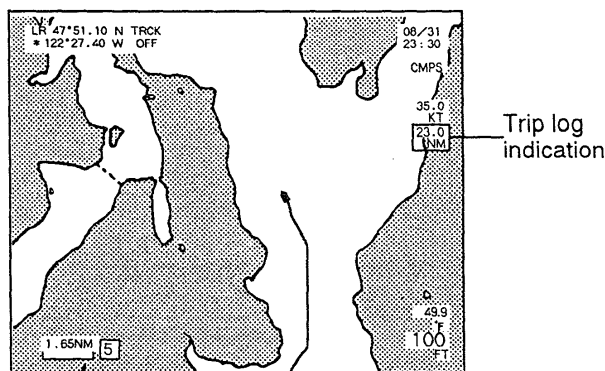

Unit of trip log	NM	km	MI
Unit of vessel speed	KT	km	MI
Variable range	0.0 ~ 54.0	0.0 ~ 99.9	0.0 ~ 62.0

When the trip log counts beyond the variable range, trip log returns to 0.0 and resumes counting.

Heading data

Data from either the compass or the navigation receiver can be designated for heading data.

- 1) Push [MENU] to select the menu mode.
- 2) Select "OTHER MENUS" by rotating the trackball vertically; then, push [SET].
 - Pushing [7] also performs this function.
 - The other menu window appears.
- 3) Select "HDG DATA" by rotating the trackball vertically; then, push [SET].
 - Pushing [3] also performs this function.
 - "HDG DATA" turns green.
- 4) Rotate the trackball to select "CMPS" for data from the compass or "NAV.S." for data from the navigation receiver.
- 5) Push [SET].
 - "HDG DATA" turns yellow.
- 6) Push [] or [] to exit the menu mode.

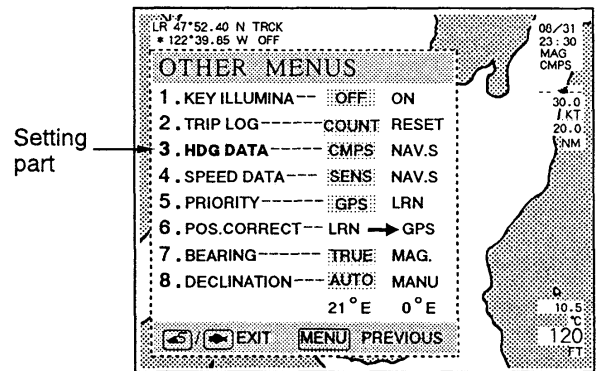

NOTE: When "CMPS" is selected, a compass with "N + 1" format is necessary for heading data indication.

Speed data

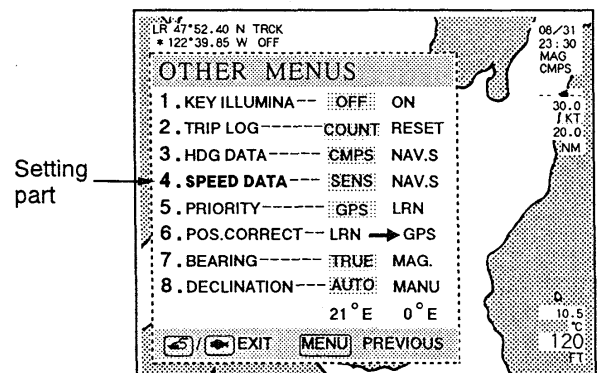

Data from either the speed sensor or the navigation receiver can be designated for speed data.

- 1) Push [MENU] to select the menu mode.
- 2) Select "OTHER MENUS" by rotating the trackball vertically; then, push [SET].
 - Pushing [7] also performs this function.
 - The other menu window appears.
- 3) Select "SPEED DATA" by rotating the trackball vertically; then, push [SET].
 - Pushing [4] also performs this function.
 - "SPEED DATA" turns green.
- 4) Rotate the trackball to select "SENS" for data from the speed sensor or "NAV.S." for data from the navigation receiver.
- 5) Push [SET].
 - "SPEED DATA" turns yellow.
- 6) Push [] or [] to exit the menu mode.



■ GPS/Loran-C priority

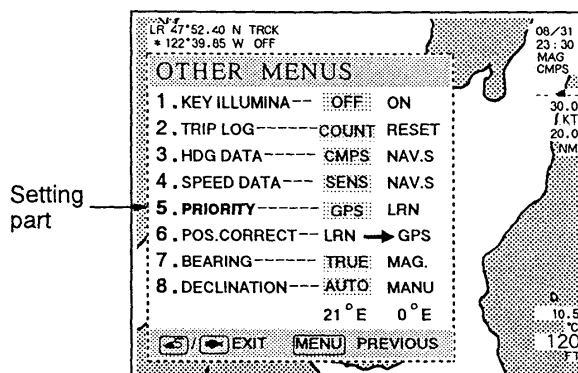

When both the RX-1203 LORAN-C RECEIVER UNIT and the GP-2000 GPS RECEIVER UNIT are connected, you can select the priority data.

- 1) Push [MENU] to select the menu mode.
- 2) Select "OTHER MENUS" by rotating the trackball vertically; then, push [SET].
 - Pushing [7] also performs this function.
 - The other menu window appears.
- 3) Select "PRIORITY" by rotating the trackball vertically; then, push [SET].
 - Pushing [5] also performs this function.
 - "PRIORITY" turns green.
- 4) Rotate the trackball to select "GPS" or "LRN."
- 5) Push [SET].
 - "PRIORITY" turns yellow.
- 6) Push [] or [] to exit the menu mode.



■ Positioning correction



When the receiving conditions are bad, the navigation receiver may send incorrect data to the FP-100. In this case, the positioning data can be adjusted to match more accurate data.

- 1) Push [MENU] to select the menu mode.
- 2) Select "OTHER MENUS" by rotating the trackball vertically; then, push [SET].
 - Pushing [7] also performs this function.
 - The other menu window appears.
- 3) Select "POS.CORRECT" by rotating the trackball vertically; then, push [SET].
 - Pushing [6] also performs this function.
 - "POS.CORRECT" turns green.
- 4) Rotate the trackball vertically to select the navigation receiver sending incorrect data to the left side of the arrow.
 - "GPS" shows the data from the GP-2000 GPS RECEIVER UNIT will be corrected.
 - "LRN" shows the data from the RX-1203 LORAN-C RECEIVER UNIT will be corrected.
- 5) Rotate the trackball horizontally to move the cursor to the right side of the arrow; then, select an accurate data source by rotating the trackball vertically.
 - "GPS" shows GP-2000 data is being used as the data source.
 - "LRN" shows RX-1203 data is being used as the data source.
 - "EXT" shows data from an external navigation receiver is being used as the data source.
 - "CUR" shows the cursor position is being used for data correction.
- 6) Push [SET].
 - If an error message appears with a beep, the settings in steps 5 or 6 are unsuitable. Or, a navigation receiver not connected to your FP-100 has been selected. Re-perform steps 5 and 6.
 - "POS.CORRECT" turns yellow.
- 7) Push [] or [] to exit the menu mode.

5 COMMON FUNCTIONS

True or magnetic bearing

The heading, waypoint bearing, cursor direction, etc. for display can be selected as the true bearing or magnetic bearing.

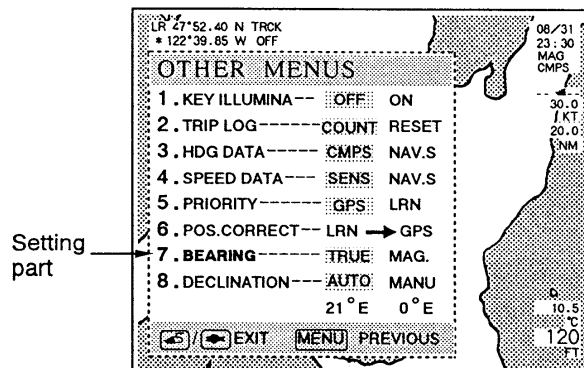

- 1) Push [MENU] to select the menu mode.
- 2) Select "OTHER MENUS" by rotating the trackball vertically; then, push [SET].
 - Pushing [7] also performs this function.
 - The other menu window appears.
- 3) Select "BEARING" by rotating the trackball vertically; then, push [SET].
 - Pushing [7] also performs this function.
 - "BEARING" turns green.
- 4) Rotate the trackball to select "TRUE" or "MAG."
- 5) Push [SET].
- 6) Push [] or [] to exit the menu mode.

When you use the FP-100 without a ROM card, declination must be set for magnetic bearing use.



Declination

Each digitalized chart in the ROM card has a declination value for magnetic bearing. When you use the FP-100 without a ROM card or if you wish to change the value, manual setting is necessary.



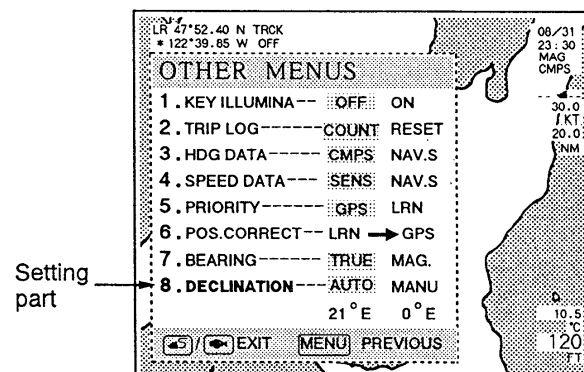



- 1) Push [MENU] to select the menu mode.
- 2) Select "OTHER MENUS" by rotating the trackball vertically; then, push [SET].
 - Pushing [7] also performs this function.
 - The other menu window appears.
- 3) Select "DECLINATION" by rotating the trackball vertically; then, push [SET].
 - Pushing [8] also performs this function.
 - "DECLINATION" turns green.
- 4) Rotate the trackball to select "AUTO" or "MANU."
 - Declination value under "AUTO" is fixed depending on the selected chart.
 - When selecting "MANU," set magnetic variation with the trackball.
- 5) Push [SET]
- 6) Push [] or [] to exit the menu mode.





Built-in simulator

The FP-100 includes a built-in simulator for operation training or checking functions. The simulator is activated on both the plotter and sounder modes.

• Activating the built-in simulator

- 1) Turn the power OFF.
- 2) While simultaneously pushing [] and [], push [POWER] to turn power ON; keep pushing [] and [] until a single beep sounds.
- 3) Release [] and [].
 - Opening display appears.

The sounder simulator is activated when steps 1 ~ 3 are completed. To activate simulated positioning data for the plotter, proceed with steps 4 ~ 6 below.

- 4) Push [SET].
 - One of "GP," "LR" or "EX" turns green.
- 5) Push [] or [] several times until "SL" appears.
 - The simulated positioning data is activated, and a simulated ship appears on the screen.
- 6) Push [SET] 3 times.

Once the power is turned OFF, the simulator is deactivated. If you want to activate the simulator again after the power is OFF, repeat steps 1 ~ 3 above.

NOTE: While the simulator is activated ("SL" is displayed), the data from the connected positioning receiver is ignored.

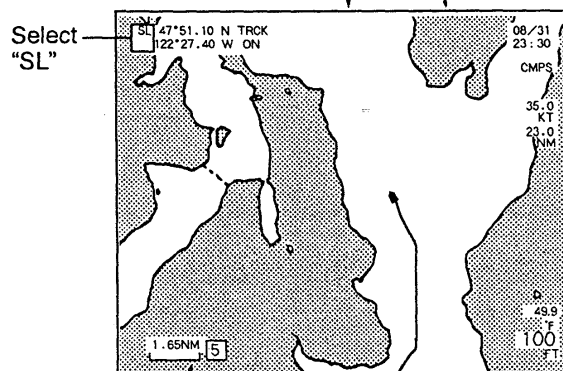
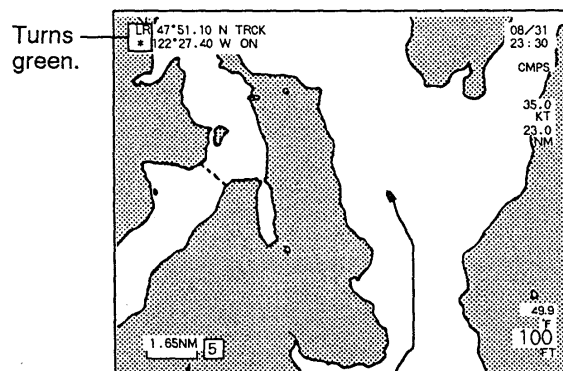
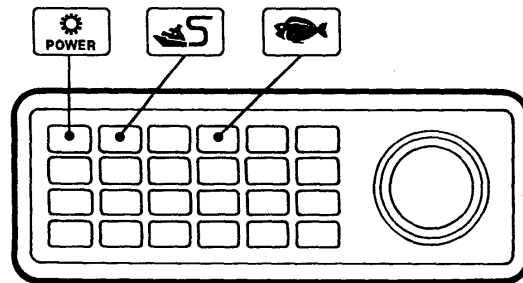



The simulated vessel moves in the direction of the trackball rotation.

CRT brightness

There are 24 brightness levels for the CRT. Select the desired intensity to suit your operating conditions.

NOTE: While the opening display appears after the power ON, CRT brightness can be adjusted without pushing [BRT].

- 1) Push [BRT] to select the CRT intensity setting condition.
 - "BRT" appears.
- 2) Rotate the trackball or push []/[] several times to select your desired level.
- 3) Push [BRT] to exit the CRT intensity setting condition.
 - "BRT" disappears.

6 INSTALLATION AND CONNECTIONS

System connections

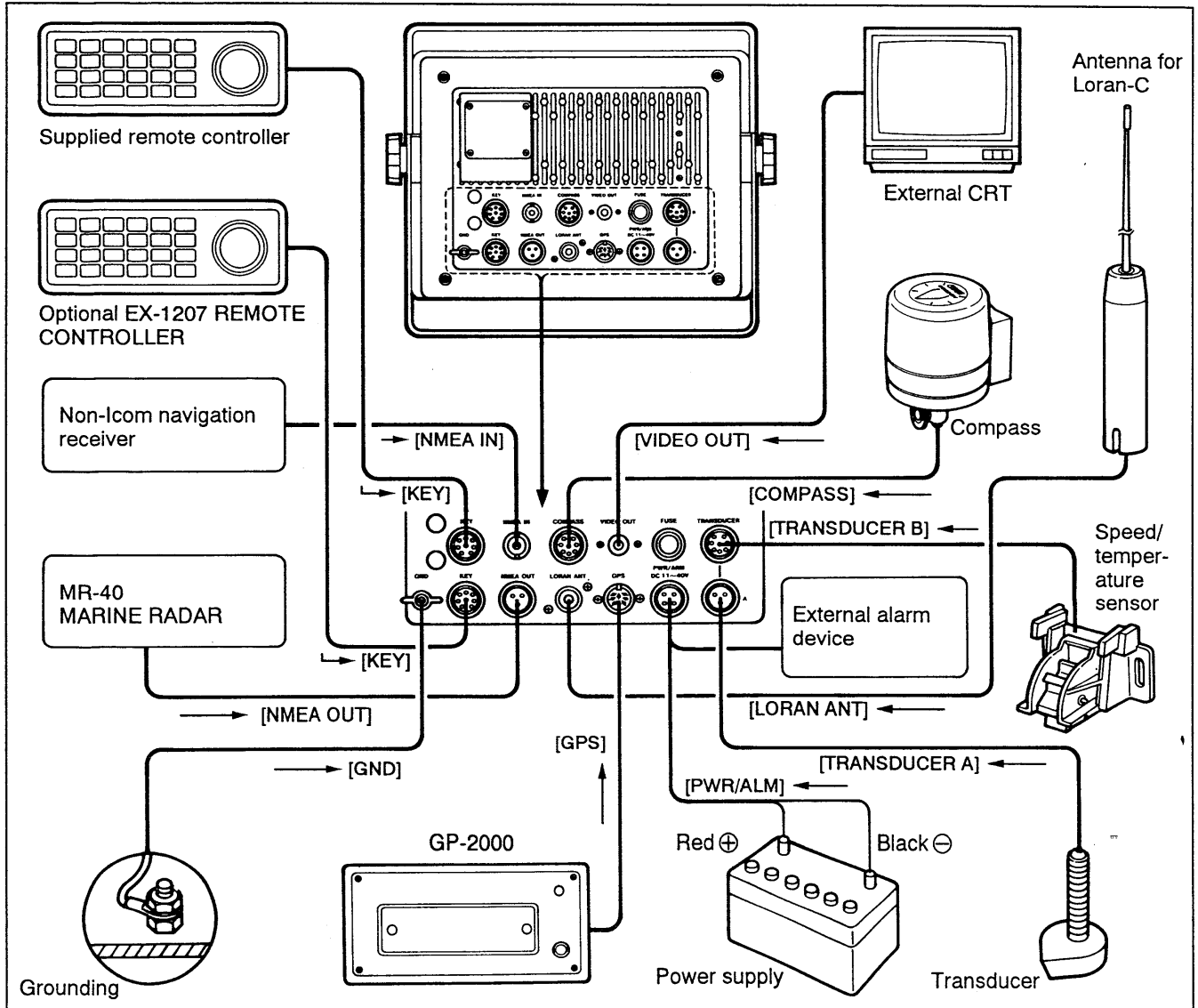

• Power cable

- 1) Connect the supplied power cable to the vessel's battery (11-40 V DC acceptable).
 - Red: ⊕ Black: ⊖
- 2) Connect the power cable connector to the [PWR/ARM] connector of the FP-100.
- 3) Ground the [GND] terminal with a short, heavy gauge wire.

POWER CONNECTOR

(Rear panel view)

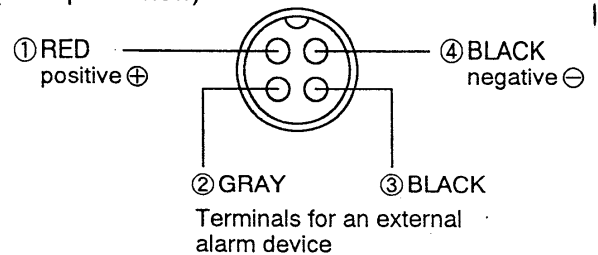

• Navigation receivers

- To use the GP-2000, connect the GP-2000, via the GPS cable (OPC-311; optional), to the [GPS] jack as shown in the diagram above.
- To use a non-Icom navigation receiver, connect the cable from the receiver to the [NMEA IN] jack with a BNC connector.

NOTE: When you use the GP-2000:

- Select RS-232C format (not RS-232C continuous output) in the GP-2000.
- DO NOT connect the DC power to the power terminals of the GP-2000 since the GPS cable controls receiver power.

• Transducer, speed sensor and temperature sensor

When using the separate transducer and speed/temperature sensor:

- Connect the cable from the transducer to the [TRANSDUCER A] jack.
- Connect the cable from the speed/temperature sensor to the [TRANSDUCER B] jack.

When using a transducer equipped with a speed/temperature sensor such as the EX-1010, connect the cable to the [TRANSDUCER B] jack.

WARNING: NEVER try to install a transducer by yourself. Drilling your vessel may be necessary for installation. If the transducer is installed incorrectly, the vessel will sink in the worst case scenario. **BE SURE** to ask your dealer to install the transducer.

• External CRT

Connect the [VIDEO OUT] jack on the FP-100 and the [VIDEO IN] jack on your CRT with a coaxial cable as shown in the diagram on the left page.

- The cable length must be less than 10 m. DO NOT use a relay connector.
- The output signal form the FP-100 adopts NTSC format. The CRT with PAL or SECAM format cannot be used.

When the characters near the screen edge are not displayed, adjust vertical and horizontal synchronization of your CRT.

VIDEO CONNECTOR INSTALLATION

- ① Strip the cable as shown in the diagram below.

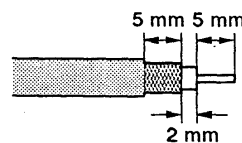

- ② Slide the connector body onto the cable and solder.

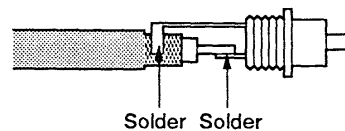

• External alarm device

An external alarm device can be connected to the [PWR/ARM] jack with the supplied power cable.

NOTE: The internal relay unit (Max. 1A) is connected to the [PWR/ARM] jack. The relay is turned ON when the alarm sounds.

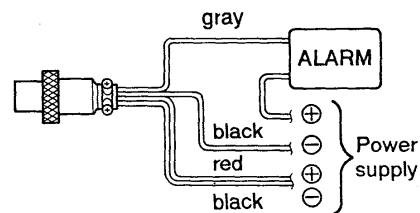

• NMEA output connector

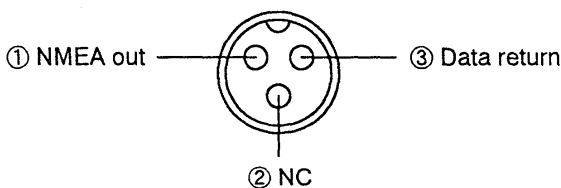

An optional OPC-285 NMEA CABLE is available to connect the FP-100 to the MR-40 MARINE RADAR.

• Compass connector

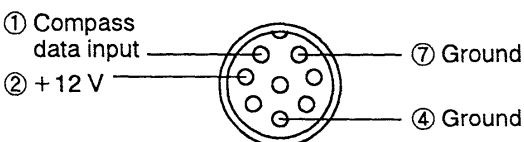

The input data format must be N + 1 format.

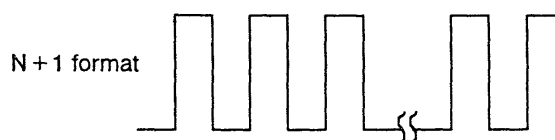

Installation

• Main body

Set the FP-100 main body in a desired location where viewing and controlling can be performed easily. The supplied universal bracket allows "dashboard," "overhead" or "Screen-up" mounting.

CAUTION: NEVER set the FP-100 in the following locations:

- Where salt or fresh water could spray on it.
- Where extreme heat, cold, vibration or a dry environment could damage it.
- Where the weight of the FP-100 cannot be supported.
- Where vessel operation could be hindered.
- Where the plotter could cause bodily injury.

- 1) Select the setting location by referring to "Main body size" below.
- 2) Drill 5 holes (diameter 4 mm; 3/16 in) for bracket attachment.
 - See "Main body size" below for hole locations.
- 3) Fix the bracket with the supplied bolts and washers.
- 4) Attach the supplied sponge to the rear side of the plotter bottom panel.
- 5) Attach the plotter to the bracket with the supplied mounting knobs and rubber washers.

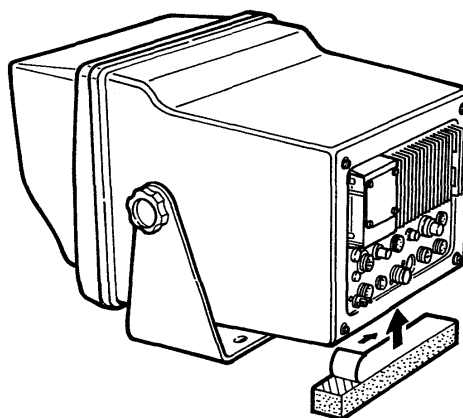
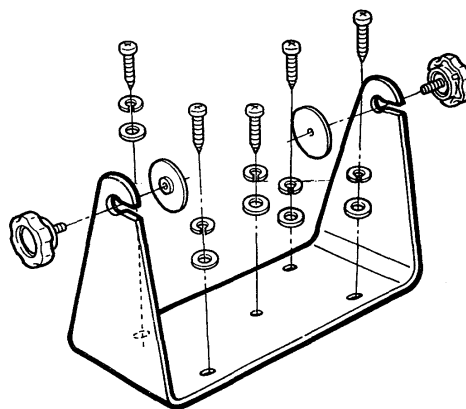

• Main body size

Unit : mm
(10 mm \approx 3/8 in)

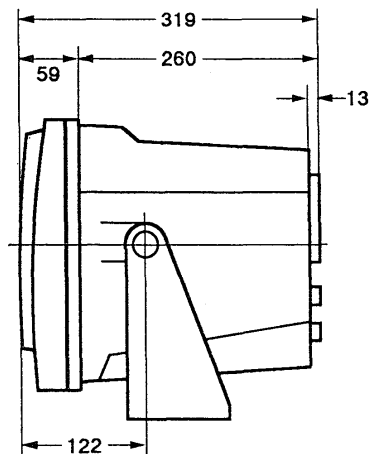
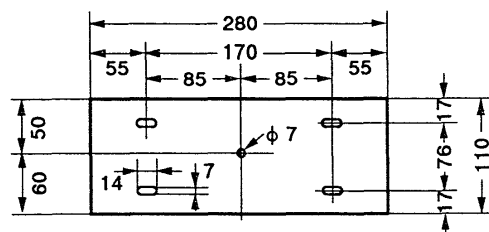
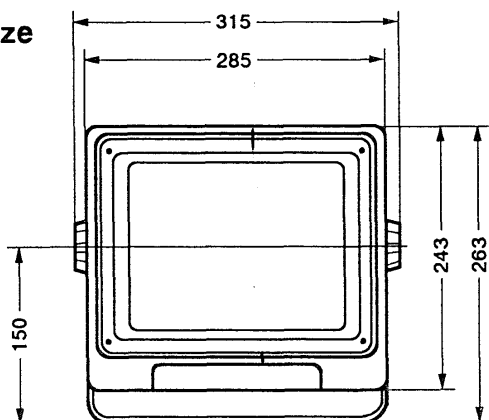

• **Viewing hood**

The supplied viewing hood is for daylight use of the FP-100.

- 1) Install the tabs.
- 2) Attach the hood tightly.
- 3) Push until you hear a 'click.'

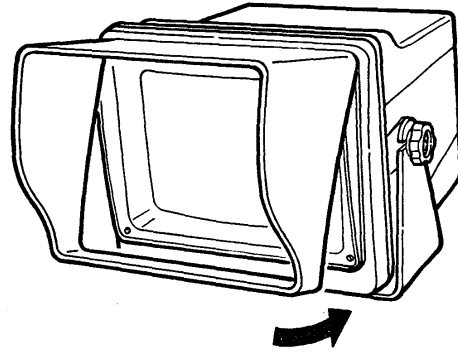

• **Remote controller**

Install the remote controller at your desired location.

- 1) Select the location.
- 2) Drill 3 holes (diameter 5 mm; 3/16 in) for installation and 1 hole (diameter 19 mm; 3/4 in) for the remote controller cable by referring to figure 1.
- 3) Fix the controller with the supplied wing nuts and washers by referring to figure 2.

(Rear panel view)

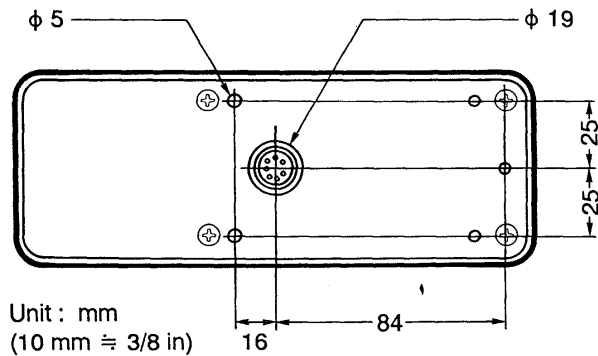

(Figure 1)

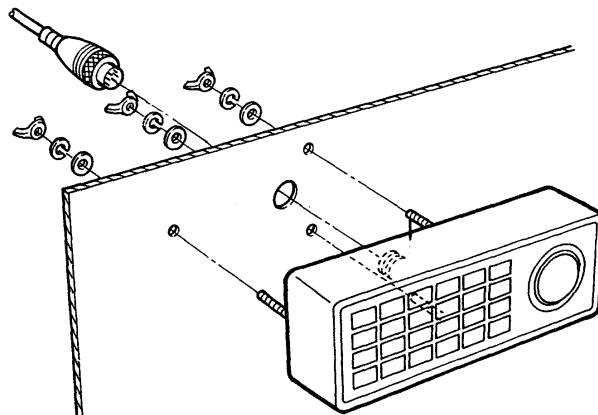

(Figure 2)

7 MAINTENANCE

■ Troubleshooting

PROBLEM	POSSIBLE CAUSE	SOLUTION	REF.
<ul style="list-style-type: none"> No power comes on. 	<ul style="list-style-type: none"> Power cable improperly connected. Blown fuse. 	<ul style="list-style-type: none"> Reconnect the cable observing the proper polarity. Check the cause, then replace the fuse with a spare one. 	<p>p. 79</p> <p>p. 84</p>
<ul style="list-style-type: none"> No screen appears even when power is ON. 	<ul style="list-style-type: none"> Dark intensity has been previously selected. 	<ul style="list-style-type: none"> Push [BRT], then rotate the trackball upwards. 	p. 78
<ul style="list-style-type: none"> Display's brightness keeps changing. 	<ul style="list-style-type: none"> Battery voltage is low. 	<ul style="list-style-type: none"> Charge the battery. 	—
<ul style="list-style-type: none"> The screen is distorted. 	<ul style="list-style-type: none"> Objects nearby with a strong magnetic field. 	<ul style="list-style-type: none"> Remove the objects. 	—
<ul style="list-style-type: none"> Remote controller does not operate. 	<ul style="list-style-type: none"> Remote controller is poorly connected. 	<ul style="list-style-type: none"> Check the remote controller cable connection. 	p. 79
<ul style="list-style-type: none"> No chart appears. 	<ul style="list-style-type: none"> ROM card is not inserted or is not inserted completely. Initial setting has not been performed. 	<ul style="list-style-type: none"> Insert the proper card completely. Perform required initial settings. 	<p>p. vi</p> <p>p. 8</p>
<ul style="list-style-type: none"> No ship appears on the chart. 	<ul style="list-style-type: none"> Initial setting has not been performed. Connected navigation receiver has not been selected. Navigation receiver has not been connected correctly. 	<ul style="list-style-type: none"> Perform required initial settings. Select the connected navigation receiver. Check the connection to the navigation receiver. 	<p>p. 8</p> <p>p. 20</p> <p>p. 79</p>
<ul style="list-style-type: none"> The displayed vessel position differs from the real position. 	<ul style="list-style-type: none"> Output from connected navigation receiver gives wrong position data. 	<ul style="list-style-type: none"> Correct the position data on the connected navigation receiver. 	pgs. 45-48
<ul style="list-style-type: none"> Track is not drawn on the screen. 	<ul style="list-style-type: none"> The track function has been turned OFF 	<ul style="list-style-type: none"> Turn the track function ON. 	p. 23
<ul style="list-style-type: none"> Heading is not displayed. 	<ul style="list-style-type: none"> Compass is selected as a heading data source and the compass is not connected. 	<ul style="list-style-type: none"> Select navigation data as a heading data source or connect the compass. 	p. 75
<ul style="list-style-type: none"> No echo or a weak echo display appears. 	<ul style="list-style-type: none"> Transducer cable has a poor contact. Sensitivity is set too low. 	<ul style="list-style-type: none"> Check the connection of the transducer cable. Check the set sensitivity value. 	<p>p. 79</p> <p>p. 58</p>
<ul style="list-style-type: none"> The sea bottom line does not appear on the screen. 	<ul style="list-style-type: none"> Depth range is set incorrectly. Phase shift is set incorrectly. The bottom discrimination function has been activated. 	<ul style="list-style-type: none"> Push [RANGE/SHIFT], then rotate the trackball vertically. Push and hold [RANGE/SHIFT] for 2 sec, then rotate the trackball vertically. Turn the function OFF. 	<p>p. 57</p> <p>p. 57</p> <p>p. 64</p>
<ul style="list-style-type: none"> Water depth is not indicated. Bottom lock screen is not displayed. The auto function cannot be activated. 	<ul style="list-style-type: none"> Sensitivity is set too low. 	<ul style="list-style-type: none"> Push [GAIN/STC], then rotate the trackball upwards. 	p. 58
<ul style="list-style-type: none"> Display does not advance across the sounder screen. 	<ul style="list-style-type: none"> The display speed is set at "0." The pause function is ON. 	<ul style="list-style-type: none"> Check the display speed setting. Push [PAUSE] to turn OFF pausing. 	p. 64
<ul style="list-style-type: none"> Water temperature is not indicated and the temperature graph is not drawn. 	<ul style="list-style-type: none"> Temperature sensor is not connected. 	<ul style="list-style-type: none"> Connect the optional EX-983 SPEED/TEMPERATURE SENSOR. 	p. 79
<ul style="list-style-type: none"> Trip log is not indicated. 	<ul style="list-style-type: none"> Navigation data from the receiver are selected as the speed data. Speed sensor is not connected. 	<ul style="list-style-type: none"> Select sensor data as the speed data. Connect the optional EX-983 SPEED/TEMPERATURE SENSOR. 	<p>p. 75</p> <p>p. 79</p>

■ Preventive maintenance

WARNING: To avoid an accidental electrical shock, make sure to turn the power OFF before carrying out the preventive maintenance procedures.

Preventive maintenance will keep the FP-100 in good operating condition, and may help reduce service time and expense.

- ① Clean and remove any dirt or dust from the unit cover and remote controller unit with a soft, damp cloth and a little soap.
- ② When cleaning the surface of the CRT and its cover, use a soft cloth (cotton or flannel) soaked with an antistatic substance or fresh water.

- ③ Inspect the connectors and the connection to the external equipment for cleanliness and tightness. Make sure the wiring is free from chafing and abrasions.
- ④ Check the cable connection to the vessel's ground for cleanliness. Tighten any loosened screws, bolts and nuts.
- ⑤ Check for evidence of any corrosion or marine growth on the transducer or its cable and connector. The transducer should be cleaned with a neutral detergent and a soft brush so that any foreign material is removed from the face of the transducer.

■ Fuse replacement

All circuits of the FP-100 are protected by fuses. If the power key is pushed ON, and the FP-100 will not operate, follow this procedure:

- 1) Remove the blown fuse from the fuse holder on the rear panel.
- 2) If possible, correct the problem, and replace with a new rated fuse.

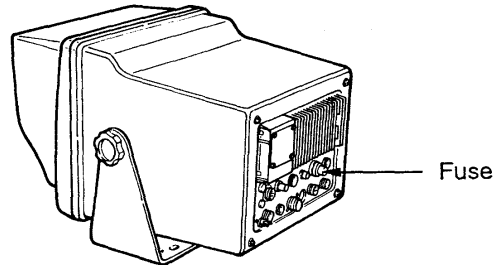

■ Incorrect display

If the screen shows an incorrect display, or any keys do not function, the internal CPU may be malfunctioning. Memory card connection, static electricity or other factors may cause such a malfunction.

If this problem occurs, turn the power OFF and then check the insertion of the memory card. Wait a few seconds, and then turn the power ON again. If the problem continues, the internal CPU should be reset with the following procedure:

While pushing [::], [CURSOR], [GAIN/STC] and [RANGE/SHIFT], turn the power ON. Hold the switches until a single beep sounds.

CAUTION: CPU resetting clears all memorized data such as event marks, waypoints, etc. However, the data programmed in a data card is saved.

■ Backup battery

The programmed data such as event marks, routes, tracks, etc. are memorized in the plotter. This data is retained by a lithium backup battery.

The usual life of the backup battery is approximately 5 years. Once the backup battery is exhausted, the plotter loses the programmed data.

WARNING: Backup battery replacement must be done by an authorized Icom Dealer or Service Center.

MENU MODE CHART

The window in the menu mode flows according to this chart.

To advance the window, select the item with the trackball or the [Δ]/[▽] keys; then, push the [SET] key.

To return to the previous window, push the [MENU] key.

To exit the menu mode, push the [5] or [] key.

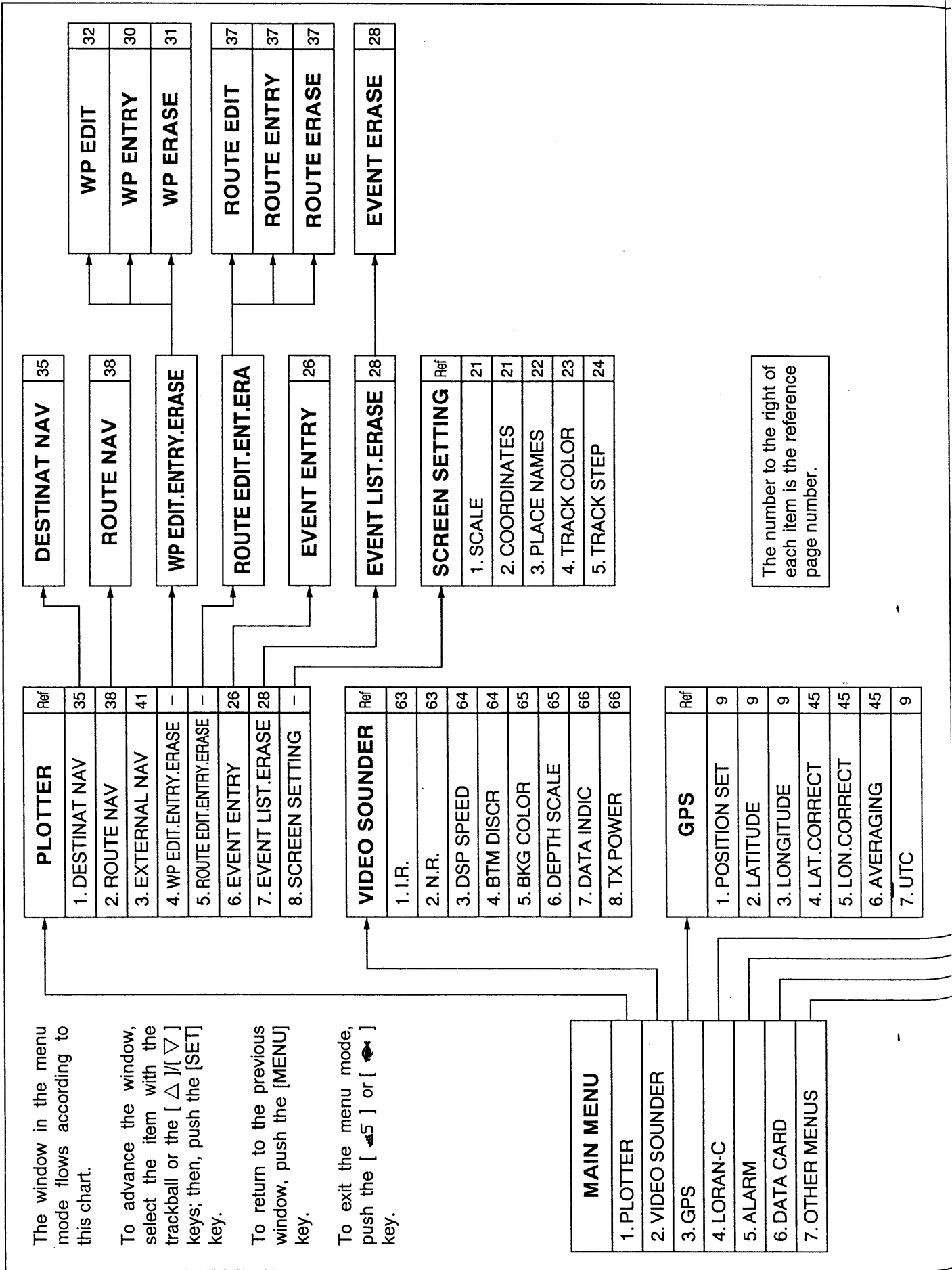

The number to the right of each item is the reference page number.

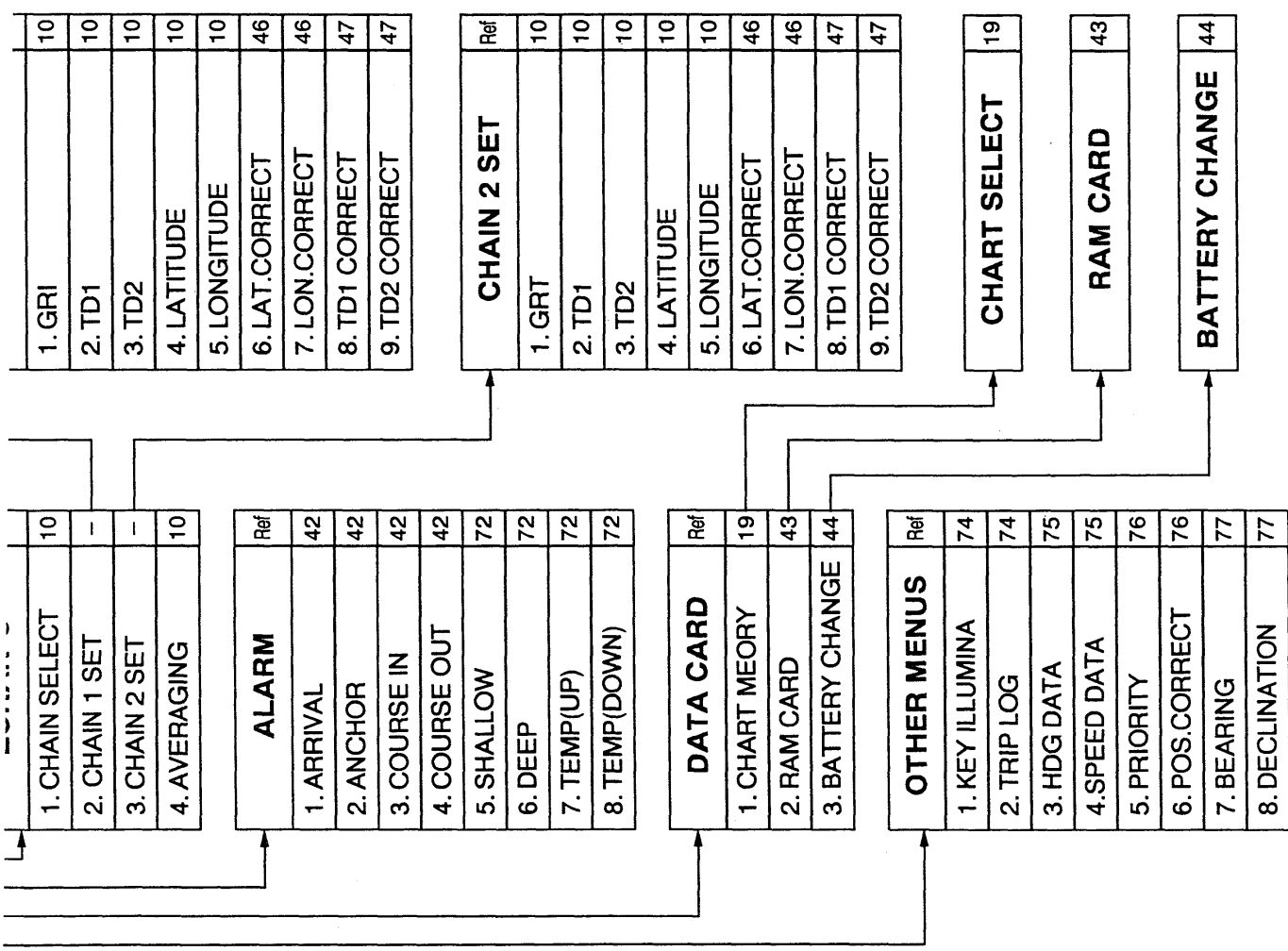

• Combination mode

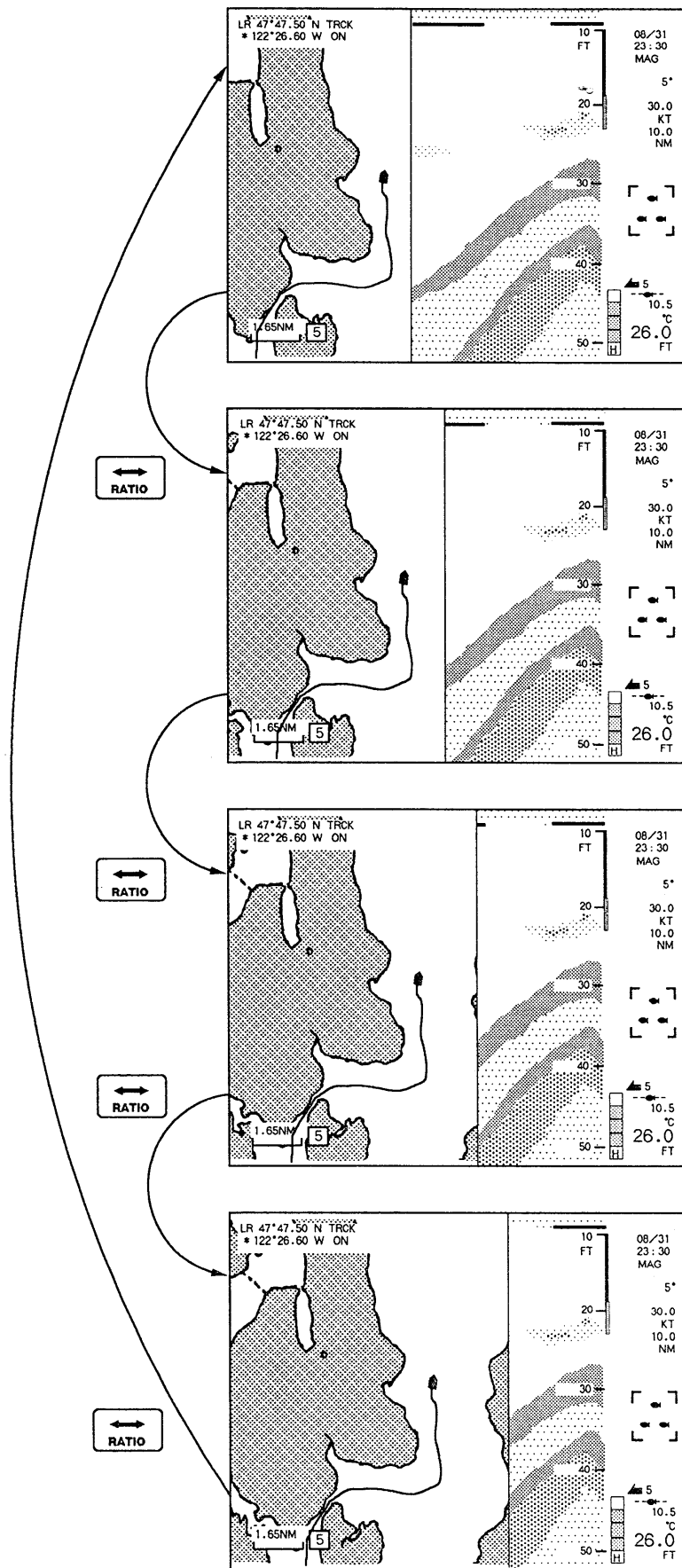

1:1 screen

NOTE: The rate of screen size can be changed only when a plot screen has been selected on the plotter side.

3:2 screen

2:1 screen

3:1 screen



3

• Loran-C chain list

CHAIN STATION	GRI	SLAVE STATION					
		W	X	Y	Z	V	
CENTRAL PACIFIC	4990			11	29		
SUEZ	4990*			10	24		
CANADIAN EAST COAST	5930			11	25	38	
COMMANDER LION	5970			11	31	42	
CANADIAN WEST COAST	5990			11	27	41	
SAUDI ARABIA (SOUTH)	7170			11	26	39	52
LABRADOR SEA	7930			11	26		
EASTERN U.S.S.R.	7950			11	30	46	61
GULF OF ALASKA	7960			11	28	44	
NORWEGIAN SEA	7970			28	11	46	60
SOUTH EAST U.S.	7980			11	23	43	59
MEDITERRANEAN	7990			11	29	47	
WESTERN U.S.S.R.	8000			10	25	50	65
WESTERN EUROPE	8940			14	33		
GREAT LAKES	8970			11	28	44	
SAUDI ARABIA (NORTH)	8990			25	40	56	69
U.S. WEST COAST	9940			11	27	40	
NORTHEAST U.S.	9960			11	25	39	54
NORTHWEST PACIFIC	9970			11	30	55	61
ICELAND	9980			11	30		
NORTH PACIFIC	9990			11	29	43	

*Use number 4991 as the chain number.

• Loran-C chain configurations

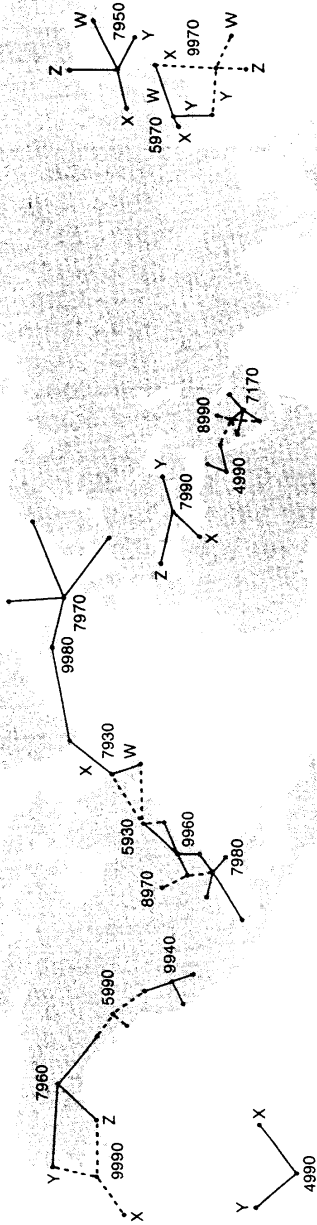

U.S./Canadian west coast

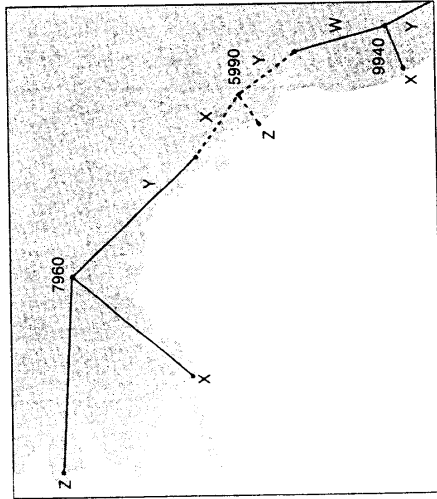

U.S./Canadian east coast

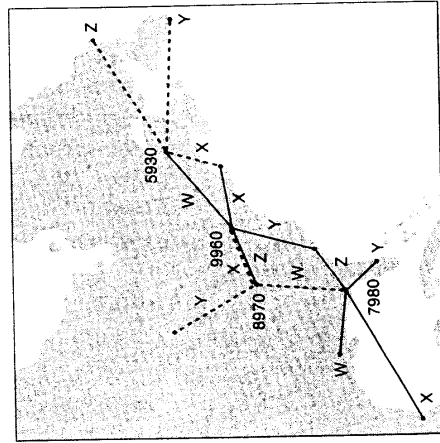

Norwegian sea

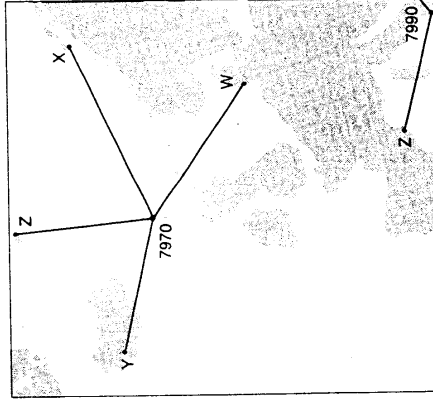

Saudi arabia

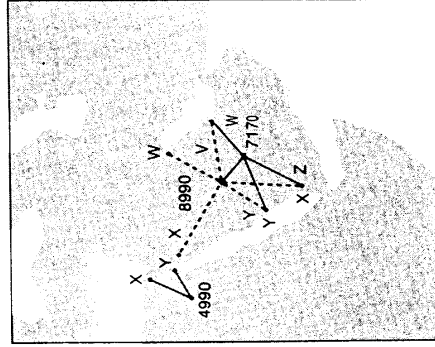

11 SPECIFICATIONS

GENERAL

• Display	: 10-inch color CRT	• Dimensions (FP-100)	: 285(W) x 243(H) x 319(D) mm
• Power supply requirement	: 11 ~ 40 V DC		11.2(W) x 9.6(H) x 12.6(D) in
• Power consumption	: 66 W (at 12 V)	(Controller)	: 191(W) x 70(H) x 40 (D) mm
• Usable temperature range	: 0°C ~ 50°C ; 32°F ~ 122°F		7.5(W) x 2.8(H) x 1.6(D) in
		• Weight	: 10 kg (controller included) 22 lb (controller included)

PLOTTER

• Chart scale	: 0 ~ 9 (10 levels)	• Navigation functions	: ① Destination navigation ② Route navigation ③ External navigation
• Number of track points	: 1200		
• Plotting intervals	: 5 sec. ~ 60 min. or 0.01 NM ~ 9.99 NM (selectable)	• Alarm	: ① Arrival alarm ② Anchor alarm ③ Course in alarm ④ Course out alarm
• Number of waypoints	: Present position + 99		
• Number of event marks	: 100 (with comment) 500 (without comment)		

SOUNDER

• Transmission frequency	: 50 kHz/200 kHz	• Basic range	: ① 0 ~ 5 m ② 0 ~ 10 m ③ 0 ~ 20 m ④ 0 ~ 40 m ⑤ 0 ~ 80 m ⑥ 0 ~ 160 m ⑦ 0 ~ 240 m ⑧ 0 ~ 320 m ⑨ 0 ~ 640 m (only for 600 W type)
• Output power	: 200 W (rms) (200 W type) 600 W (rms) (600 W type)	• Phase shift variable range:	0 ~ 320 m (200 W type) 0 ~ 640 m (600 W type)
• Picture advance speed	: 6 levels + synchronization		
• Alarm	: ① Shallow alarm ② Deep alarm ③ Temperature (up) alarm ④ Temperature (down) alarm ⑤ Fish school alarm	• Bottom lock/ expansion range	: ① 2 m ② 4 m ③ 10 m ④ 20 m ⑤ 40 m ⑥ 80 m
• Unit of water depth	: ① Meter (M) ② Feet (FT) ③ Fathoms (FM)		
• Unit of water temperature:	°C, °F		
• Measurable water temperature range	: 0 ~ 40 °C ; 32 ~ 104 °F		
• Color presentation	: 12 colors		

OTHERS

• Unit of speed and distance	: ① KT (NM) ② km/h (km) ③ MI/h (MI)	• Output data format	: ① NMEA0183 ② NTSC (video output)
• Range of trip log	: 0 ~ 999.9 NM	• NMEA0183 sentence format	: Input ** GLL, ** WPL, ** XTE (** means a wild card.) Output LCGLL, LCXTE, LCAAM, LCVTG, LCBOD, LCWPL
• CRT brightness	: 25 levels		
• External memory	: ROM card and RAM card		
• Input data format	: ① Icom GPS ② NMEA0182/0183 ③ N+1 format (heading data)		

All stated specifications are subject to change without notice or obligation.



NAVIGATION RECEIVER, CABLE, CONTROLLER

- **GP-2000 GPS RECEIVER UNIT**
External GPS receiver unit. Receiver settings and operations including power ON/OFF are controlled by the FP-100. See pgs. 9 and 15.
- **OPC-311 GPS CABLE**
Used to connect the GP-2000 and the FP-100. Length: 3 m.
- **RX-1203 LORAN-C RECEIVER UNIT**
Built-in Loran-C receiver unit. Operation and setting can be performed from the FP-100. Nine notch filters are pre-adjusted corresponding to your area. An optional AH-16 is required.
- **AH-16 LORAN-C WHIP ANTENNA**
Required option for the RX-1203. Length: 2.6 m; 8.5 ft
- **EX-1207 REMOTE CONTROLLER**
The same remote controller as supplied with the FP-100. Two remote controllers can be connected to the FP-100.
- **OPC-285 NMEA CABLE**
Used to connect the FP-100 and Icom MR-40 MARINE RADAR or other equipment with an NMEA0182 or NMEA0183 input terminal. Length: 3 m Connector: BNC type

DATA CARD

- **EX-1140 ROM CARD**
Contains read only digitized charts. Depending on the version, 1 ~ 2 charts are included. Your Icom Dealer can tell you which charts are available.
- **EX-1141 ROM CARD**
Contains read only digitized charts. Depending on the version, several charts are included. Your Icom Dealer can tell you which charts are available.
- **EX-1142 RAM CARD**
Stores 2 sets of user definable information. Each set includes 1200 track points, 600 event marks, 100 waypoints and 10 routes. Includes a CR2025 battery and a memory protection switch to prevent accidental data writing or erasing.

TRANSDUCER, SPEED/TEMPERATURE SENSOR, INNER-HULL KIT

- **EX-980 THROUGH-HULL TYPE TRANSDUCER**
For use with the 200 W type FP-100. When the EX-948 is installed, you need not drill into your vessel's hull.
Beam width: 30 ° (for 50 kHz), 13 ° (for 200 kHz)
Weight: 570 g; 1.3 lb
- **EX-981 TRANSOM TYPE TRANSDUCER**
For use with the 200 W type FP-100. Includes kit for stern mounting.
Beam width: 30 ° (for 50 kHz), 13 ° (for 200 kHz)
Weight: 550 g; 1.2 lb
- **EX-982 THROUGH-HULL TYPE TRANSDUCER**
For use with the 200 W type FP-100. For super-rugged applications.
Beam width: 30 ° (for 50 kHz), 13 ° (for 200 kHz)
Weight: 960 g; 2.1 lb
- **EX-1010 THROUGH-HULL TYPE TRANSDUCER**
For use with the 200 W and 600 W type FP-100. Has transducer capability plus vessel speed and water temperature measurement capabilities.
Beam width: 40 ° (for 50 kHz), 10 ° (for 200 kHz)
Weight: 2.2 kg; 4.9 lb
- **EX-948 INNER-HULL KIT**
Lets you install the EX-980 inside your vessel without drilling big holes.
Dimensions: 100(H) × 140(Φ) mm; 3.9(H) × 5.5(Φ) in. Weight 290 g; 10.2 oz
- **EX-983 SPEED/TEMPERATURE SENSOR**
Measures vessel speed and surface water temperature. Can be mounted on the stern. No need to drill holes into your vessel.
Speed range: 0.3 ~ 60 knots. Weight: 280 g; 9.9 oz

Count on us!

