

IC-1271A

1200MHz ALL-MODE TRANSCEIVER

INSTRUCTION MANUAL

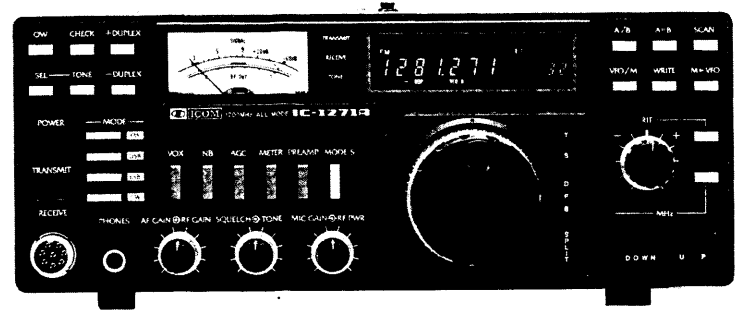

TABLE OF CONTENTS

SECTION	1	SPECIFICATIONS	1
SECTION	2	DESCRIPTION	2
SECTION	3	CONTROL FUNCTIONS.....	4
	3-1	FRONT PANEL	5
	3-2	FREQUENCY DISPLAY	10
	3-3	HATCH COVER	11
	3-4	REAR PANEL	12
SECTION	4	INSTALLATION	13
	4-1	UNPACKING	13
	4-2	INSTALLATION RECOMMENDATIONS	13
	4-3	ANTENNA	13
	4-4	MICROPHONE	14
	4-5	CW KEY.....	14
	4-6	POWER SUPPLY.....	15
	4-7	GROUND	15
	4-8	ACCESSORY SOCKET.....	15
SECTION	5	OPERATING INSTRUCTIONS.....	16
	5-1	SETTINGS.....	16
	5-2	BASIC OPERATION	16
	5-3	FM OPERATION.....	17
	5-4	SSB OPERATION	18
	5-5	CW OPERATION.....	20
	5-6	ATV OPERATION.....	21
	5-7	SPLIT (DUPLEX) OPERATION.....	22
	5-8	MEMORY CHANNEL OPERATION.....	23
	5-9	SCANNING OPERATION.....	25
	5-10	MICROPHONE UP/DOWN FUNCTION.....	27
	5-11	LITHIUM BATTERY (BACKUP BATTERY).....	27
SECTION	6	INSIDE VIEWS	28
	6-1	TOP VIEW	28
	6-2	BOTTOM VIEW.....	29
	6-3	PLL UNIT	29
SECTION	7	OPTION INSTALLATION.....	30
	7-1	IC-PS25 INTERNAL POWER SUPPLY	30
	7-2	IC-EX310 VOICE SYNTHESIZER UNIT	32
SECTION	8	TROUBLESHOOTING.....	33
SECTION	9	BLOCK DIAGRAM	34
SECTION	10	OPTIONAL UNITS	35
SECTION	11	SCHEMATIC DIAGRAM.....	SEPARATE

SECTION 1 SPECIFICATIONS

1 - 1 GENERAL

Frequency coverage	: 1240 ~ 1300MHz
Operating modes	: J3E (A3J) SSB (Upper and Lower Sideband) A1A (A1) CW F3E (F3) FM
Frequency resolution	: SSB, CW 100Hz FM 25kHz
Frequency control	: CPU based 100Hz step digital PLL synthesizer. Independent transmit/receive frequency available.
Frequency readout	: 7 digit, 1kHz display.
Usable temperature range	: $-10^{\circ}\text{C} \sim +60^{\circ}\text{C}$ ($+14^{\circ}\text{F} \sim +140^{\circ}\text{F}$)
Frequency stability	: Within $\pm 0.0003\%$ in the range of $0^{\circ}\text{C} \sim +50^{\circ}\text{C}$.
Memory channels	: 32 channels with any in-band frequency programmable.
Power supply requirements	: 13.8V DC $\pm 15\%$ (negative ground). Current drain 7.5A maximum.
Current drain (at 13.8V DC)	: Transmitting Approx. 7.5A Receiving At maximum audio output Approx. 1.5A Squelched Approx. 1.3A
Antenna impedance	: 50 ohms unbalanced.
Weight	: 7.1kg
Dimensions	: 111(127)mm(H) x 286(303)mm(W) x 276(348)mm(D) () Shows dimensions including projections.

1 - 2 TRANSMITTER

RF output power	: J3E (SSB) 10 watts PEP A1A (CW), F3E (FM) 10 watts Continuously adjustable output power from 1 to 10 watts.
Modulation system	: SSB: Balanced modulation. FM: Variable reactance frequency modulation.
Max. frequency deviation	: $\pm 5\text{kHz}$.
Spurious emissions	: More than 50dB below peak power output.
Carrier suppression	: More than 40dB below peak power output.
Unwanted sideband	: More than 40dB down with 1000Hz AF input.
Operating modes	: Simplex or semi-duplex.
Microphone	: 600 ohm electret condenser microphone with push-to-talk switch and scanning buttons.

1 - 3 RECEIVER

Receive system	: J3E (SSB), A1A (CW) : Double conversion superheterodyne. F3E (FM) : Triple conversion superheterodyne.
Intermediate frequencies	: SSB, CW 1st : 133.8600 ~ 133.8699MHz 2nd : 10.75MHz FM 1st : 133.860 ~ 133.869MHz 2nd : 10.75MHz 3rd : 455kHz
Sensitivity	: SSB, CW : Less than $0.16\mu\text{V}$ for 10dB S+N/N. FM : Less than $0.22\mu\text{V}$ for 12dB SINAD. Less than $0.32\mu\text{V}$ for 20dB noise quieting.
Selectivity	: SSB, CW : More than 2.4kHz at -6dB point. Less than 4.8kHz at -60dB point. FM : More than 15kHz at -6dB point. Less than 30kHz at -60dB point.
Audio output	: More than 2 watts at 10% distortion with 8 ohm load.
Audio output impedance	: 8 ohms

SECTION 2 DESCRIPTION

■ MICROWAVE TECHNOLOGY

The front end and transmitter circuits employ the latest microwave devices.

The RF amplifiers use low noise figure, high gain, disk type GaAs-FETs for microwave applications. Also, the power amplifiers are equipped with rugged power module which exhibit high gain characteristics at microwave frequencies, and are suitable for long duty cycles such as amateur television (ATV).

■ NEWLY DEVELOPED PLL CIRCUIT COVERS ENTIRE BAND

The PLL circuit newly developed by ICOM covers the entire band from 1240 to 1300MHz, a total of 60MHz. SSB, CW and FM modes may be used anywhere in the band, thus the IC-1271A/E is ideal for DX, local calls, mobile, satellite or moonbounce operation.

■ 1200MHz ALL-MODE TRANSCEIVER WITH MICROCOMPUTER TECHNOLOGY

CPU control with ICOM's original programs provides various operating capabilities, and the band edge detector and endless tuning system provides out-of-band protection. In addition, a no-backlash dial controls the unique rotary encoder tuning circuit, eliminating the need for variable capacitors or gears.

■ VARIOUS SCANNING FUNCTIONS

Memory Scan allows rapid monitoring of all different memory channels, whereas Programmed Scan provides scanning between any two programmed frequencies. Also, Mode Selective Scan automatically monitors only those memories which contain frequencies with a similar mode. The Auto-Stop feature functions when a signal is received in any mode. Scanning of frequencies and memories is possible from either the transceiver or the IC-HM12 scanning microphone.

■ EASY-TO-OPERATE, LIGHT-WEIGHT

The IC-1271A/E is the most compact and lightest all-mode 1200MHz transceiver currently available. It uses an advanced pulse power supply (optional) which contributes to the overall light weight. A 50mm diameter tuning control allows smooth and easy frequency changes, and an LED indicator clearly shows whether the transmit or receive mode is selected.

■ SUITABLE FOR BOTH FIXED AND PORTABLE STATIONS

The transceiver operates with either a 117/240 volt AC (optional) or 12 volt DC power supply. A convenient Dial Lock switch is included, helpful during mobile operation, as well as a comfortable carrying handle. The Noise Blanker effectively reduces interference when in areas with much pulse noise. The SM-8 or IC-SM6 quality desk microphones (optional) are well-suited for fixed station operation. Also, a powerful audio output, 2 watts into 8 ohms, allows easy listening even in a noisy environment.

■ OUTSTANDING PERFORMANCE

The RF amplifier and first mixer circuits incorporate GaAsFETs which, in conjunction with other circuits, provide excellent intermodulation and two-signal selectivity characteristics. The IC-1271A/E has high sensitivity specifications, especially important for mobile operation, plus it is highly stable and uses Crystal Filters with carefully designed shape factors and selectivity.

■ 32 MEMORIES

Programmable memories are provided to store the mode and frequency in 32 different channels. An internal backup battery maintains the contents of these memories for up to 5 years.

■ OPTIONS AVAILABLE

● TV-1200

This is an interface unit to allow amateur television (ATV) operation with only the addition of a video recorder and video camera for transmission, and a television for reception. A few simple interconnections will allow you to explore the field of video hamming.

● IC-EX310

When used with the IC-1271A/E, this unit orally announces your operating frequency with an electronically-generated voice.

● UT-15

This is a CTCSS (Continuous Tone Coded Squelch System) encoder/decoder interface which, when used with the TS-32 encoder/decoder, may be programmed with one of thirty-one subaudible tones. These tones are often required to access FM repeaters.

● IC-EX309

This is an interface unit which, when installed in the IC-1271A/E, allows connection of the transceiver to a personal computer.

● IC-PS25

The IC-PS25 is a 13.8 volt DC, 8 ampere internal AC power supply. It uses a newly developed switching regulator system, resulting in a light-weight, highly efficient power source.



IC-1271A

TV-1200

SECTION 3 CONTROL FUNCTIONS

⑤ See Section 3 - 2 for Frequency display.

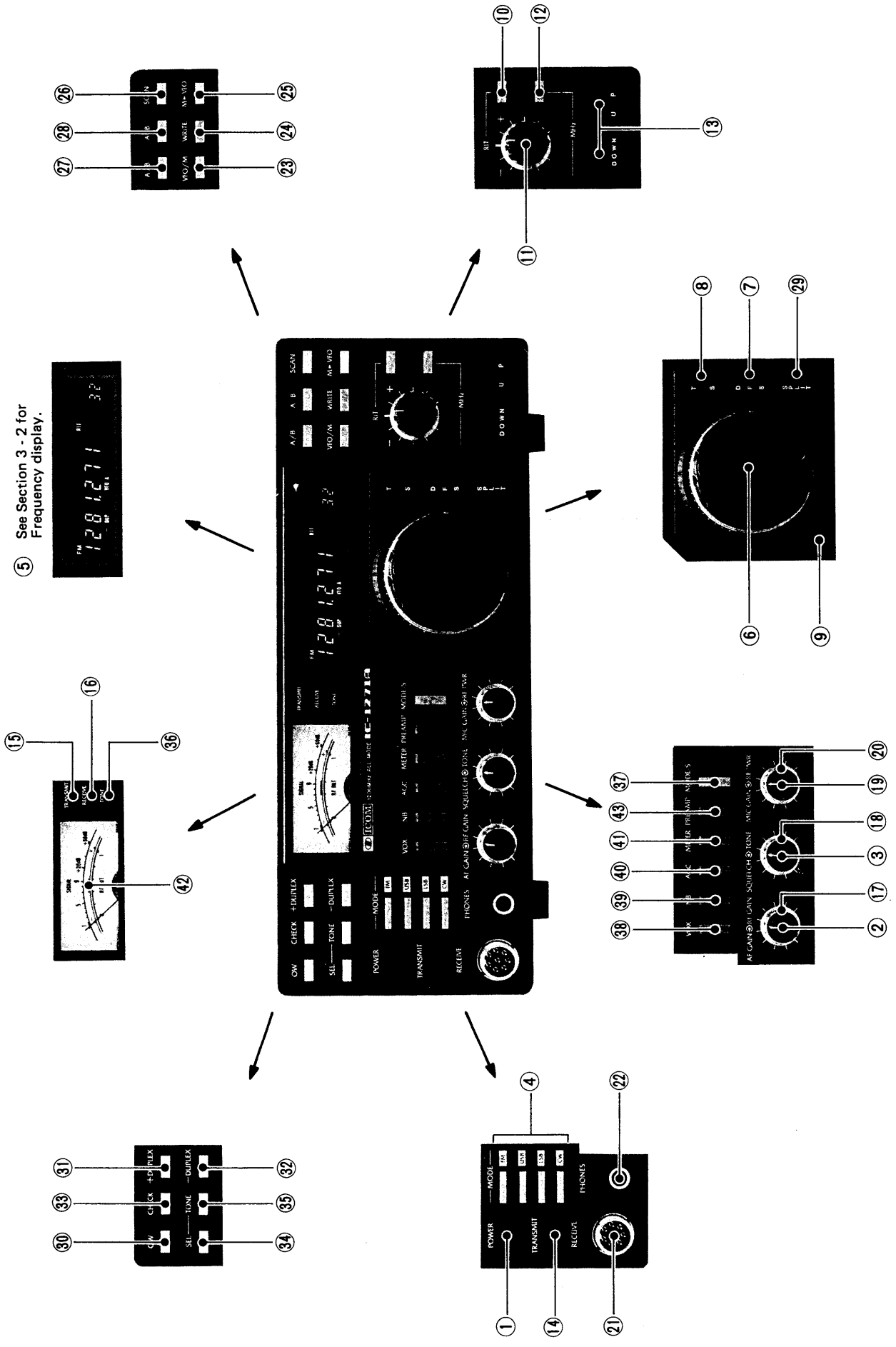

3-1 FRONT PANEL

① POWER SWITCH

This is a push-lock switch which controls the input DC power to the IC-1271A/E. When the IC-PS25 AC power supply is used, the switch also acts as the AC power supply switch. Power is supplied to the transceiver when the switch is pushed in and locked. Power to all circuits is cut (except to the PA unit when using an external DC power source) when the switch is pushed again and released.

② AF GAIN CONTROL

This control varies the audio output level in the receive mode. Clockwise rotation increases the level.

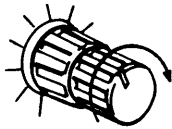

③ SQUELCH CONTROL

This control sets the squelch threshold level. To turn off the squelch function, rotate this control completely counterclockwise. To set the threshold level higher, rotate the control clockwise.

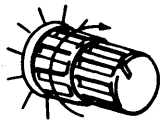

④ MODE SELECT SWITCHES

These switches select any one of four operating modes: FM, USB, LSB or CW. Push the appropriate switch for the mode desired.

⑤ FREQUENCY DISPLAY

See Section 3-2 for details of the FREQUENCY DISPLAY.

⑥ TUNING CONTROL

Rotate this control clockwise to increase, and counterclockwise to decrease the frequency or memory channel number. The frequency changes in 100Hz steps in USB, LSB and CW modes, and in 25kHz steps in the FM mode.

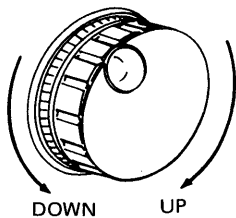

⑦ DFS (Dial Function Select) SWITCH

While using the VFO mode, push this switch IN to lock the displayed VFO operating frequency, and rotate the TUNING CONTROL to change the displayed memory channel number.

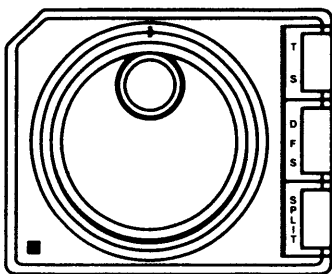

While using the MEMORY CHANNEL mode, push this switch IN to lock the displayed memory channel, and rotate the TUNING CONTROL to change the displayed frequency.

⑧ TS (Tuning Speed) SWITCH

Push this switch IN to alter the tuning rate as shown in the chart below.

MODE	TS OFF (OUT POSITION)	TS ON (IN POSITION)
FM	25kHz	1kHz
USB LSB CW	100Hz	1kHz

⑨ DIAL LOCK AND SPEECH SWITCH

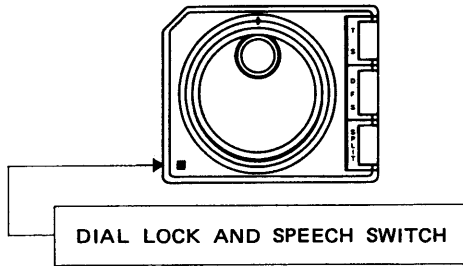

This switch electronically locks the display frequency, thus deactivating the TUNING CONTROL. This function is useful after the IC-1271A/E is set to a certain frequency for rag chewing, mobile operation, etc. Disengage the dial lock by pushing and releasing the button again.

In addition, this switch activates the optional speech synthesizer which announces the displayed frequency in English.

⑩ RIT SWITCH

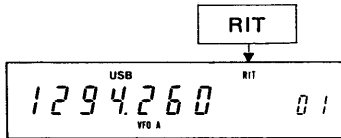

This switch turns the RIT circuit ON and OFF. "RIT" illuminates when the RIT function is activated.

⑪ RECEIVER INCREMENTAL TUNING

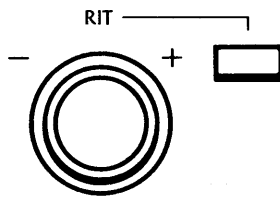

This control shifts the receiver frequency about ± 2.5 kHz.

⑫ MHz SWITCH



While holding this switch IN, rotate the TUNING CONTROL to increase or decrease the displayed frequency in 1MHz steps. Less significant digits do not change. When tuning upward past the upper limit of the band, the frequency automatically reverts to the lower limit. Likewise, when tuning downward beyond the lower limit, the frequency reverts to the upper limit.

⑬ MHz UP/DOWN SWITCHES

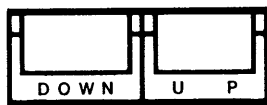

Each push of these switches increases or decreases the operating frequency in 1MHz steps. Less significant digits do not change. When tuning upward past the upper limit of the band, the frequency automatically reverts to the lower limit. Likewise, when tuning downward beyond the lower limit, the frequency reverts to the upper limit.

⑭ TRANSMIT/RECEIVE (T/R) SWITCH

This switch is for manually switching between transmit and receive. Set the switch to RECEIVE to select the receive mode, and TRANSMIT to select the transmit mode. When using the PTT switch on the microphone or the VOX system, the T/R SWITCH must be in the RECEIVE position.

⑮ TRANSMIT INDICATOR

Illuminates when the transceiver is in the transmit mode.

⑯ RECEIVE INDICATOR

Illuminates when the transceiver is in the receive mode.

⑰ RF GAIN CONTROL

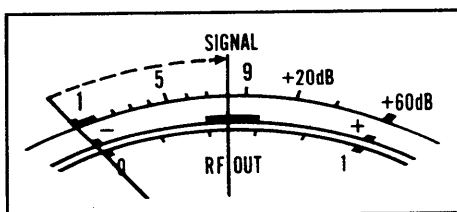

This control varies the gain of the RF stage when the transceiver is in the receive mode. Rotate the control fully clockwise for maximum gain. When tuning in the SSB or CW modes, as the control is rotated counterclockwise, the S-meter needle rises and only those signals stronger than the level indicated by the needle are heard. In the FM mode, the RF gain is fixed at the maximum value regardless of where this control is set.

18 TONE CONTROL

SQUELCH \leftrightarrow TONE

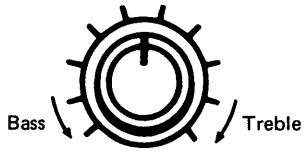

Controls the receiver audio tone. Adjust the control to provide the clearest, most pleasing audio.

19 MIC GAIN CONTROL

MIC GAIN \leftrightarrow RF PWR

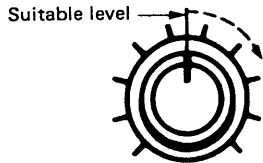

Adjust this control for a suitable modulation level while speaking into the microphone in a normal voice. Rotate the control clockwise to increase the gain.

20 RF POWER CONTROL

MIC GAIN \leftrightarrow RF PWR

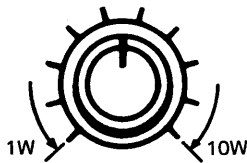

This control varies the RF output power from 1 watt to maximum. Rotate the control clockwise to increase the output power.

21 MIC CONNECTOR

Connect a suitable microphone to this jack. The supplied IC-HM12 hand microphone or the optional IC-SM6 or SM-8 desk microphone may be used. To use a different microphone, refer to the diagram in Section 4 - 4.

FRONT VIEW

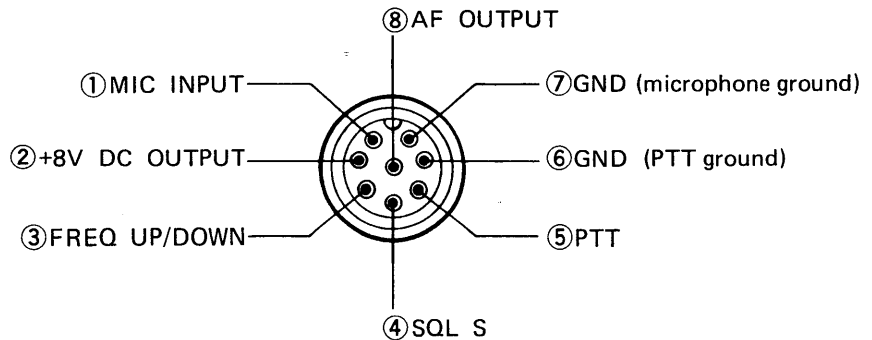

22 PHONES JACK

This jack accepts a standard 1/4 inch headphone plug from headphones with an impedance of 4 ~ 16 ohms. Stereo headphones may be used without modification.

23 VFO/MEMORY SWITCH

This switch selects the VFO or MEMORY CHANNEL mode for tuning purposes. Each push selects one of the two modes alternately.

The display for channels with no frequency stored is as shown in the diagram.

VFO MODE

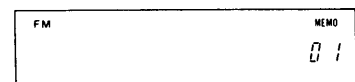
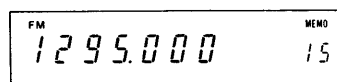
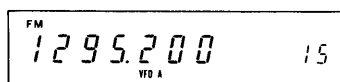

Push the VFO/M SWITCH.

②④ MEMORY WRITE SWITCH

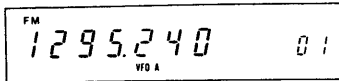

Push the MEMORY WRITE SWITCH to store the above frequency and mode in MEMORY CHANNEL 01.

Push this switch to store the displayed operating frequency, mode and simplex/duplex information in the memory channel indicated on the frequency display.

Memory writing is possible in either the VFO or MEMORY CHANNEL mode. See Section 5 - 8 for information on programming the memory channels.

②⑤ FREQUENCY TRANSFER SWITCH (M▶VFO)

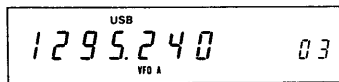
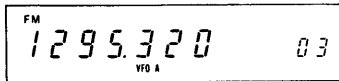

Stored information in MEMO CH 3 transfers to VFO A and is displayed when the M▶VFO SWITCH is pushed.

This switch operates differently depending on which mode the transceiver is in.

- 1) In the VFO mode, the frequency and mode stored in the memory channel displayed transfers to the selected VFO.
- 2) In the MEMORY CHANNEL mode, the displayed frequency and mode transfers to the VFO used immediately prior to changing to the MEMORY CHANNEL mode.

NOTE: When in the MEMORY CHANNEL mode, it is the displayed frequency which transfers to the VFO. This is not necessarily the MEMORY CHANNEL frequency since the TUNING CONTROL may have been used to shift the operating frequency. Information stored in the memory channel remains unchanged after using the M▶VFO function.

②⑥ SCAN START/STOP SWITCH

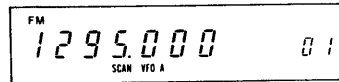

↑
The "SCAN" indicator lights when any scan function is activated.

This switch alternately starts/stops any of the scan functions. The scan restarts from the stopped frequency in the programmed scan mode, and from the highest memory channel in the memory channel or the mode selective scan. See Section 5 - 9 for a full description of the various scanning systems available on the IC-1271A/E.

②⑦ VFO SWITCH (A/B)

VFO A

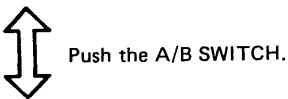
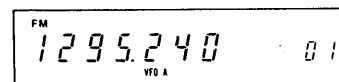

VFO B

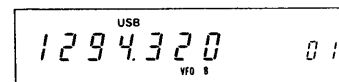

This switch selects VFO A or VFO B for tuning purposes. Each push of this switch alternately selects one of the two VFOs.

②⑧ VFO EQUALIZING SWITCH (A=B)

This switch instantly matches the frequency and mode of operation of the two VFOs.

This display does not change when the A=B switch is pushed, however confirmation of the equalizing process is possible by pushing the VFO switch to check the frequency and mode of the opposite VFO.

VFO A



Push the A=B SWITCH.

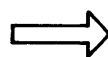

VFO B



29 SPLIT (DUPLEX) SWITCH

VFO A: 1295.000MHz/FM
VFO B: 1294.210MHz/USB
SPLIT SWITCH: ON (IN) POSITION

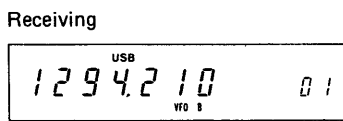

This switch selects the relationship of the two VFO frequencies. In the OFF (out) position, one VFO is for both receive and transmit. In the ON (in) position, one VFO is for receive while the other VFO is for transmit. Each push of this switch alternately chooses the simplex and duplex modes. See Section 5 - 7 for a full description of simplex/duplex operation.

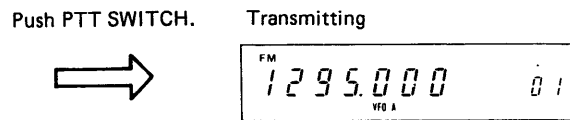

30 OFFSET WRITE SWITCH (OW)

Push the OW SWITCH.

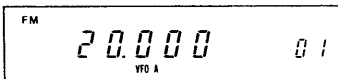

Push this switch to display the offset frequency on the front panel display. In the FM mode, while this switch is held down, the offset can be changed in 10Hz steps by rotating the TUNING CONTROL. See Section 5 - 7 for information on duplex operation.

31 +DUPLEX SWITCH

32 -DUPLEX SWITCH

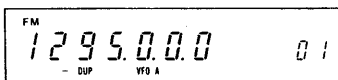

Either "DUP" or "-DUP" lights when the associated switch is pushed.

Push either the +DUPLEX or the -DUPLEX SWITCH to select the duplex mode. +DUPLEX shifts the transmit frequency above the receive frequency by an amount equal to the programmed offset per item 30. -DUPLEX shifts the transmit frequency below the receive frequency. Push either switch again to turn off the duplex mode.

33 CHECK SWITCH

The transmit and receive frequencies are reversed when in the duplex mode if this switch is held down. This function is useful for listening to repeater input frequencies.

**34 TONE SELECT SWITCH (SEL)
(U.S.A. version only)**

Push this switch to display the selected subaudible tone number on the FREQUENCY DISPLAY. The tone number can be changed by rotating the TUNING CONTROL. See Section 5 - 7 for the subaudible tone frequency table.

35 SUBAUDIBLE TONE SWITCH

U.S.A. version: Push to activate the built-in subaudible tone circuit. The "TONE" indicator also lights. Push again to deactivate the circuit.

Europe version: Push to activate and transmit the 1750Hz tone burst.

NOTE: The TS-32 encoder/decoder, which mounts on the UT-15, must be purchased separately.

Australia version: This switch has no function in this version of the IC-1271A. When the optional UT-15 CTCSS INTERFACE UNIT is installed, the switch will function.

36 SUBAUDIBLE TONE INDICATOR

Illuminates when the subaudible tone unit is turned ON. The tone is transmitted during each transmission while this indicator is lit.

37 MODE SELECTIVE SCAN SWITCH

Push this switch to engage the mode selective function. Only memory channels with the same operating mode as is displayed just prior to pushing this switch are selected when the TUNING CONTROL or the scan function is used.

See Section 5 - 9 for a full description of scanning.

38 VOX SWITCH

This switch turns the VOX circuit ON and OFF. The automatic T/R switching VOX circuit functions in the PHONE and CW modes when this switch is IN. In the CW mode, semi break-in operation is possible.

③⑨ NOISE BLANKER (NB) SWITCH

Push this switch IN to reduce pulse noise such as that generated by automobile ignition systems. The blanker circuit reduces background receive noise for more enjoyable operating. The blanker functions when using the SSB or CW mode only.

④⑩ AGC SWITCH
(AUTOMATIC GAIN CONTROL)

This switch changes the time constant of the AGC circuit. When the switch is OUT, the AGC voltage reduces slowly for SSB reception. When the switch is IN, the AGC voltage reduces quickly for either CW reception or for receiving signals with rapid fading.

④① METER SWITCH

Push this switch when using the FM mode to change the front panel meter to a center scale discriminator meter.

④② METER

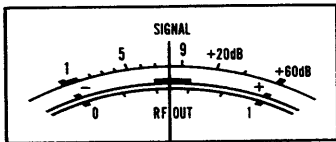

Functions as a relative RF output meter in the transmit mode, and as an S-meter (signal strength meter) in the receive mode. Also functions as a discriminator meter if the METER SWITCH is pushed IN.

④③ PREAMPLIFIER SWITCH

This switch turns the optional preamplifier ON and OFF when it is installed.

3-2 FREQUENCY DISPLAY

The frequency of the IC-1271A/E is displayed on a 7 digit luminescent display. The display indicates the operating frequency using a MHz decimal point when in any mode (FM, USB, LSB, CW).

Remember, the displayed frequency does not change when using the RIT function, although the actual receive frequency does change.

The FREQUENCY DISPLAY shows the mode and whether VFO A/B, -DUPLEX/+DUPLEX, a memory channel, a scan mode or the RIT function is selected, in addition to the operating frequency.

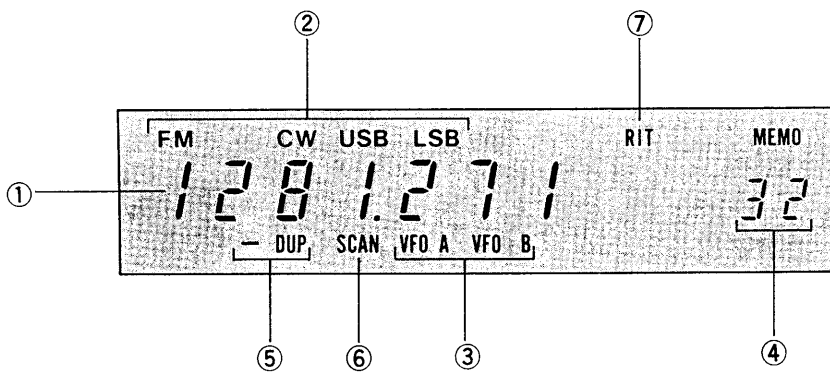

① FREQUENCY INDICATOR

Displays the operating frequency with 1kHz resolution using 7 digits although the transceiver actually functions to the nearest 100Hz.

② MODE INDICATOR

Displays the operating mode: either "FM", "USB", "LSB" or "CW".

③ VFO INDICATOR

Displays the selected VFO: either "VFO A" or "VFO B".

④ MEMORY INDICATOR

Displays the word "MEMO" when the memory channel mode is selected. The selected memory channel number is below the "MEMO" indicator.

⑤ **DUPLEX INDICATOR**

Displays "DUP" and "-DUP" when the +DUPLEX and -DUPLEX functions are selected, respectively.

⑥ **SCAN INDICATOR**

Displays the word "SCAN" while the transceiver is in the scan mode.

⑦ **RIT INDICATOR**

Displays the letters "RIT" when the receiver incremental tuning circuit is turned ON.

3 - 3 HATCH COVER

The following 5 controls were set at the factory, but you may prefer to adjust them to suit your own operating habits.

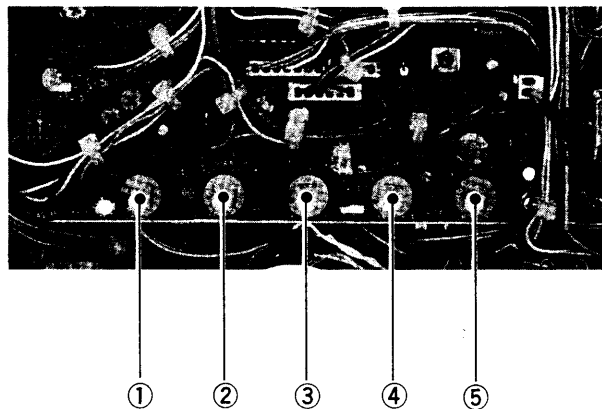

① **CW DELAY CONTROL**

When using CW, this controls the transmit/receive switching time. Set it to suit your keying speed.



Decreases delay time. Increases delay time.

It is possible to operate almost full break-in CW when the control is set fully counterclockwise.

② **VOX DELAY CONTROL (VOX time constant)**

When using the VOX function, this varies the transmit/receive switching time. Set it to prevent switching during normal pauses in your speech.



Decreases delay time. Increases delay time.

See Section 5 - 4 for a full description of VOX operation.

③ **VOX GAIN CONTROL**

This changes the sensitivity of the VOX circuit. Adjust the control for VOX circuit operation with a normal speech level.



Increases VOX gain.

See Section 5 - 4 for more information.

④ **ANTI-VOX CONTROL**

When using the VOX mode, speaker audio may sometimes activate the transmitter accidentally. Adjust the ANTI-VOX CONTROL in conjunction with the VOX GAIN to eliminate this undesired T/R switching.



Adjust to eliminate undesired T/R switching.

⑤ **CW MONITOR (MONI) CONTROL**

This adjusts the audio volume of the CW sidetone monitor while transmitting. Adjust it for a comfortable level.



Increases the monitor sound level.

3-4 REAR PANEL

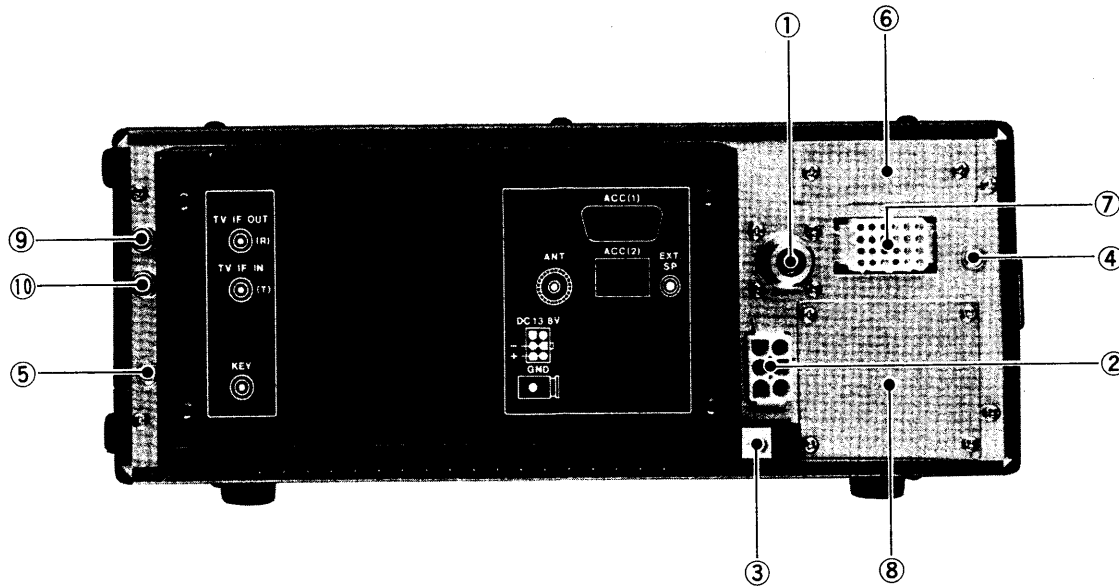

① ANTENNA (ANT) CONNECTOR

Connect a 50 ohm impedance antenna to this connector. The connector mates with a TYPE N plug. See Section 4 - 3 for installation instructions for the TYPE N plug.

**② DC POWER SOCKET
(13.8V DC INPUT)**

Connect the DC power cord from the IC-PS25 internal power supply or other suitable supply here. See Section 4 - 6 for information on power supply connections.

③ GROUND TERMINAL

To prevent electrical shock, TVI, BCI and other problems, be sure to ground the equipment through the GROUND TERMINAL. For best results, use the heaviest gauge wire or strap possible and make the connection as short as possible, even in mobile installations.

④ EXTERNAL SPEAKER JACK

Connect an external speaker to this jack, if required. Use a speaker with an impedance of 4 ~ 16 ohms and, remember, the built-in speaker does not function when using the EXTERNAL SPEAKER JACK.

⑤ KEY JACK

For CW operation, connect a CW key here using the supplied standard 1/8 inch, 2-conductor plug. The terminal voltage from external electronic keyers must be less than 0.4 volt DC.

**⑥ OPTIONAL INTERFACE UNIT
(IC-EX309) CONNECTOR POSITION**

This position is for the installation of the DP-25 connector from the optional interface unit IC-EX309.

⑦ ACCESSORY SOCKET

This connector provides signals such as T/R switching, receiver output, modulation output, etc. See Section 4 - 8 for detailed information.

**⑧ IC-PS25 (OPTIONAL) AC POWER
SUPPLY SOCKET POSITION**

This position is for the installation of the AC power socket plate for the optional IC-PS25 internal power supply.

⑨ TV IF OUTPUT (R) JACK

An output jack used for receiving amateur television signals. The output from this jack is an IF signal consisting of both video and audio components which the optional ATV converter TV-1200 processes before passing the signal to a television receiver. See Section 5 - 6 for instructions explaining how to connect the TV-1200.

⑩ TV IF INPUT (T) JACK

An input jack used for transmitting amateur television signals. This input accepts an IF signal from the TV-1200 which converts the signal from a conventional video camera or video recorder.

SECTION 4 INSTALLATION

4 - 1 UNPACKING

- ① Microphone (IC-HM12) 1
- ② DC Power Cord 1
- ③ Spare Fuses (10 amp). 2
- ④ External Speaker Plug 1
- ⑤ Key Plug 1

Carefully remove your transceiver from the packing carton and examine it for signs of shipping damage. Should any be apparent, notify the delivering carrier or dealer immediately, stating the full extent of the damage. It is recommended you keep the shipping cartons. They will be handy in the event storage, moving, or reshipment becomes necessary. Accessory cables, plugs, etc., are packed with the transceiver. Make sure you have not overlooked anything.

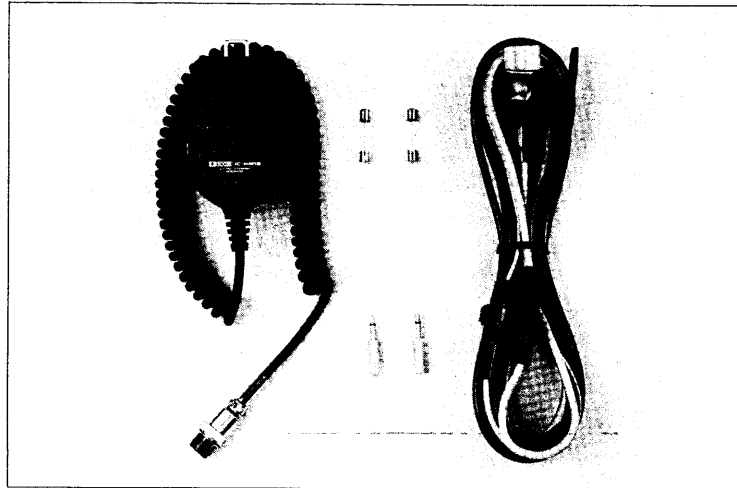

4 - 2 INSTALLATION RECOMMENDATIONS

1. Avoid placing the IC-1271A/E in direct sunlight, high temperatures and dusty or humid places.
2. The temperature of the transceiver usually becomes relatively high while transmitting. Place any accessory equipment at least 3 centimeters (1 inch) away from the unit so as to provide space for adequate ventilation. Be sure to keep the PA heatsink and the area around it clear of obstructions. Also, avoid locations near heater outlets, air conditioners, etc.
3. Place the unit so the controls and switches can easily be handled, and the frequency display and meter can be seen clearly.
4. For mobile installations, an optional mounting bracket is available. Select a location which can support the weight of the unit, and which does not interfere with the driver in any way.
5. Use the Ground Terminal!

4 - 3 ANTENNA

Antennas play a very important role in radio communication. If the antenna is inferior, your transceiver cannot give you the best performance. A well-matched 50 ohm antenna and feedline will provide the desired performance. Obtain a quality antenna, preferably one with high gain, which operates on the 1.2GHz band, and install it as high as possible. Be especially careful when installing the connectors since poor or loose connections greatly reduce the overall efficiency of the system. Connect the ground terminal of a mobile antenna, if used, to the body of the vehicle.

●TYPE N CONNECTOR INSTALLATION

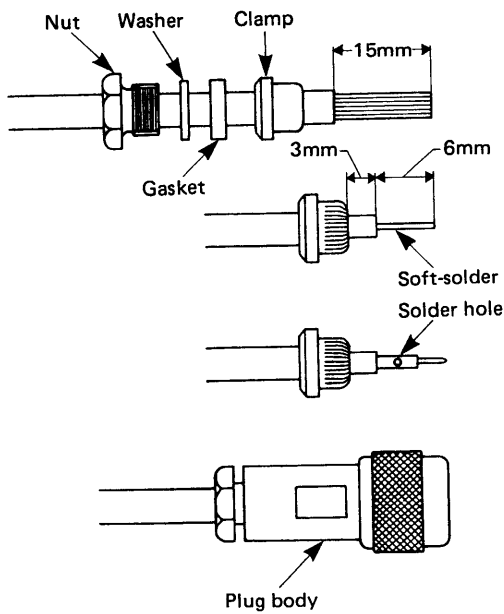

A TYPE N connector should be used on the feedline to minimize power loss at UHF frequencies. Follow the instructions below for best results when installing the connector.

1. Slide the nut, washer, gasket and clamp over the coaxial cable and cut the end of the cable even.
2. Cut and remove 15mm of the outer vinyl jacket, and fold the braid back over the clamp. The clamp end should be flush with the end of the vinyl jacket. Evenly trim the braid ends.

Cut and remove 6mm of the dielectric (center conductor insulation).

3. Soft-solder the center conductor. Install center conductor pin and solder.
4. Carefully slide the plug body into place aligning the center conductor pin on the cable with the hole in the insulator inside the plug body.

Complete the assembly by screwing the nut into the plug body.

4 - 4 MICROPHONE

The supplied IC-HM12 electret condenser hand microphone or optional SM-8 or IC-SM6 desk microphone may be used. Merely plug it into the MIC CONNECTOR on the front panel. If you wish to use a different microphone, make certain it has the proper output level. Particular care must be exercised when wiring a different microphone since the transceiver internal electrical switching system is dependent upon the correct connections. Refer to the schematics for the proper hookup.

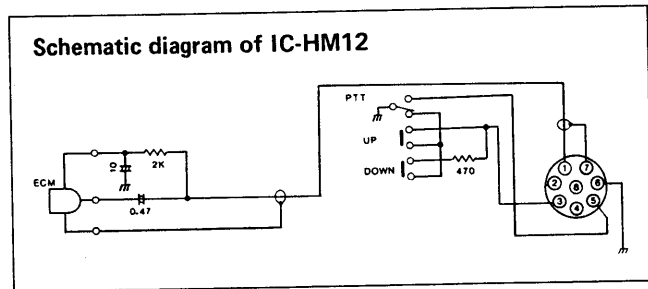

4 - 5 CW KEY

For CW operation, connect a CW key to the KEY JACK using the the supplied standard 1/8 inch, 2-conductor plug. See the diagram for connection details.

Observe the correct polarity of all leads when wiring. Note that the keyed voltage when switching with semiconductors or relays with resistors in the circuit must be less than 0.4 volt.

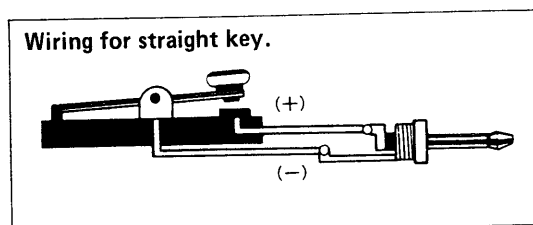

4 - 6 POWER SUPPLY

CAUTION: Voltages greater than 15 volts DC may damage this transceiver. Check the source voltage before connecting the power cord.

(1) IC-PS25 INSTALLATION

(2) USING A DC POWER SOURCE

CAUTION: Remember to install a FUSE in the DC cable when using a vehicle battery for power if the supplied DC cable is not used.

When powering the IC-1271A/E from your car battery or any other DC power source, be sure the voltage is 12 to 15 volts and the current capacity is at least 8 amperes.

When an AC power supply is required, use the IC-PS25 internal supply, or the IC-PS30 or IC-PS15 external supply.

See Section 7 OPTION INSTALLATION.

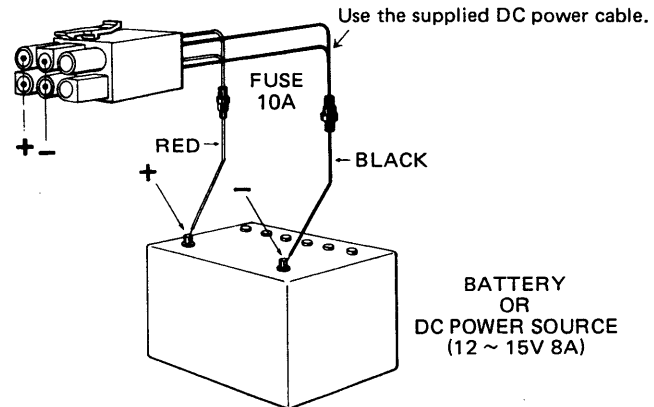

(3) USING OTHER MANUFACTURERS' AC POWER SUPPLIES

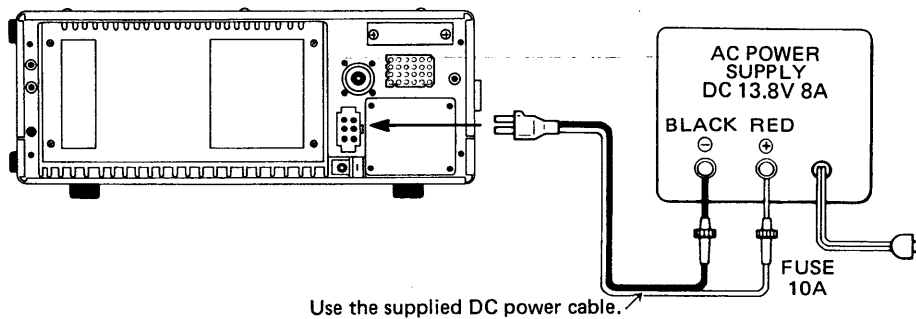

4 - 7 GROUND

To prevent electrical shocks, TVI, BCI and other problems, be sure to ground the equipment with the heaviest gauge wire or strap possible from a good earth point to the GROUND TERMINAL on the rear panel.

4 - 8 ACCESSORY SOCKET

This connector provides signals such as T/R switching, receiver output, modulation output, etc. The table states the function of each terminal.

ACC SOCKET CONNECTIONS

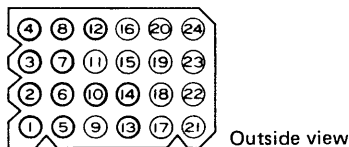

PIN No.	FUNCTION
1.	Output from the squelch control stage. (+6V when the RECEIVE INDICATOR lights.)
2.	13.8 volts DC interlocked with the power switch.
3.	Connected to the push-to-talk, T/R switch. When grounded, the transceiver changes to the transmit mode.
4.	Output from the receive detector stage. Fixed output regardless of AF output or AF gain.
5.	Output from the transmit MIC amplifier stage. (Input for the MIC gain control stage.)
6.	8 volts DC output while transmitting. (Maximum output current is 5mA)
7.	Input for external ALC voltage.
8.	Ground.
9.	No connection.
10.	Output of the meter voltage.
11.	No connection.
12.	Output for ATV-ALC.
13.	Input for external FM squelch control voltage.
14.	Input for external SSB squelch control voltage.
15. ~ 24.	No connection.

SECTION 5 OPERATING INSTRUCTIONS

5 - 1 SETTINGS

● FREQUENCY DISPLAY INDICATIONS

The FREQUENCY DISPLAY should appear as follows:

FREQUENCY : Any frequency acceptable.
 MODE : FM, USB, LSB or CW.
 VFO : VFO A or VFO B.
 MEMO : No MEMO indicator and any MEMO number.
 SCAN : No SCAN indicator.
 DUP : Neither +DUP nor -DUP indicator.
 RIT : No RIT indicator.

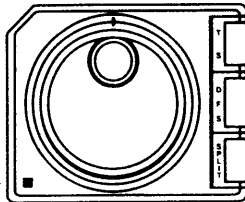

DIAL LOCK SWITCH →

If the display is different than indicated above, see SECTION 3 CONTROL FUNCTIONS.

5 - 2 BASIC OPERATION

(1) RECEIVING

- ① Power ON.

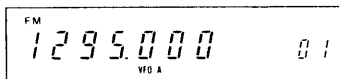

- ② Select MODE.
- ③ Adjust AF GAIN CONTROL.
- ④ Adjust SQUELCH CONTROL.

SQUELCH → TONE

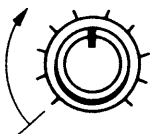

Turning this control clockwise sets the squelch threshold higher.

After all INSTALLATION instructions have been followed in SECTION 4, including connecting a 50 ohm antenna system, set the controls and switches as indicated below.

1. If a supply other than the IC-PS25, IC-PS30 or IC-PS15 is used, check that the AC power supply output voltage is 13.8 volts DC.
2. Check that the antenna connector on the feedline from the antenna is securely fastened to the ANTENNA CONNECTOR on the rear panel of the IC-1271A/E.
3. Check all connections between the IC-1271A/E and accessory equipment.

SWITCH/CONTROL	POSITION
POWER SWITCH	OFF (OUT)
AF GAIN CONTROL	10'CLOCK
RF GAIN CONTROL	MAXIMUM CLOCKWISE
SQUELCH CONTROL	MAXIMUM COUNTERCLOCKWISE
TONE CONTROL	CENTER
MIC GAIN CONTROL	CENTER
RF POWER CONTROL	MAXIMUM CLOCKWISE
VOX SWITCH	OFF (OUT)
NB SWITCH	OFF (OUT)
AGC SWITCH	OFF (OUT)
METER SWITCH	OUT
PREAMP SWITCH	OFF (OUT)
MODE-S SWITCH	OFF (OUT)
TS SWITCH	OFF (OUT)
DFS SWITCH	OFF (OUT)
SPLIT SWITCH	OFF (OUT)
DIAL LOCK SWITCH	OFF (OUT)
TRANSMIT/RECEIVE SWITCH	RECEIVE

This section explains basic receiving and transmitting. See SECTIONS 5 - 3, 5 - 4 and 5 - 5 for detailed explanations.

- ① Push the POWER SWITCH to turn ON the transceiver. The FREQUENCY DISPLAY lights after about 2 seconds and the transceiver is now ready for receiving. The frequency and mode displayed are the same as they were immediately prior to turning the transceiver OFF, whereas the VFO and MEMORY CHANNEL indicators show "VFO A" and "01", respectively.
- ② Select an operating mode by pushing one of the MODE SWITCHES.
- ③ Slowly rotate the AF GAIN CONTROL clockwise for a comfortable receive level.
- ④ If the squelch function is desired, rotate the SQUELCH CONTROL clockwise until the noise from the speaker just disappears. Perform this adjustment while receiving noise only (no signal).

- ⑤ Rotate TUNING CONTROL.

(2) TRANSMITTING

- ⑤ Rotate the tuning knob until a signal is received. The meter needle moves according to the signal strength, so tune for the highest meter reading and the clearest audio. If you cannot receive an understandable signal, you may be using the wrong mode. Check the MODE SWITCHES.

Before transmitting, listen in the receive mode to make sure your transmission will not interfere with other communications.

Set the MIC GAIN and RF POWER CONTROLS as in the table in SECTION 5 - 1 SETTINGS.

- ① Push the PTT SWITCH on the microphone or switch the TRANSMIT/RECEIVE SWITCH to TRANSMIT. The red TRANSMIT LED lights.
- ② Speak into the microphone, and note that the meter needle follows the modulation of your voice. You are now transmitting SSB signals.
- ③ If you wish to increase the output power, turn the RF POWER CONTROL clockwise for the desired power between 1 and 10 watts.

5 - 3 FM OPERATION

(1) RECEIVING

- ① Push the FM MODE SWITCH.
- ② Adjust the AF GAIN CONTROL for a comfortable level.
- ③ Set the SQUELCH CONTROL.

- ① For FM reception, push the FM MODE SWITCH IN. Set the other switches and knobs as shown in the table in SECTION 5 - 1 SETTINGS.
- ② Rotate the AF GAIN CONTROL clockwise for a comfortable audio level.
- ③ Locate a vacant frequency using the TUNING CONTROL, and rotate the SQUELCH CONTROL slowly clockwise until the noise from the speaker just stops. This is the threshold point. The receiver remains silent until there is a signal on your frequency. When a signal is received, the RECEIVE indicator also lights.

If the squelch is unstable due to the reception of weak signals or mobile stations, adjust the SQUELCH control further clockwise until the proper threshold is obtained.

- ④ Select the desired meter function.

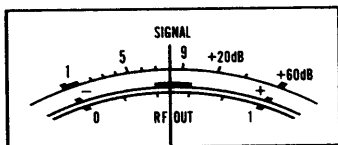

Push the METER SWITCH IN to select the center meter as shown above.

- ④ If the METER SWITCH is OUT, the meter functions as an S-meter, indicating the signal strength of incoming signals, and it is calibrated in S units and dB over S9.

If the METER SWITCH is IN, the meter functions as a zero-center discriminator meter, indicating the amount a receive signal is offset from your tuned frequency.

The noise blanker and AGC circuits do not operate in the FM mode.

(2) TRANSMITTING

- ① Set the MIC GAIN and RF POWER CONTROLS.

- ① Set the MIC GAIN and RF POWER CONTROLS as follows:

MIC GAIN CONTROL	CENTER (12 o'clock)
RF POWER CONTROL	Fully counterclockwise

Set the controls and switches the same as for RECEIVING.

- ② Place the T/R SWITCH at TRANSMIT, or push the PTT SWITCH.
- ③ Adjust the RF POWER CONTROL.
- ④ Speak into the microphone.
- ⑤ Push either the +DUPLEX or -DUPLEX SWITCH for duplex operation.

VERSION	OFFSET FREQUENCY (MHz)
IC-1271A U.S.A.	20
IC-1271A AUSTRALIA	12
IC-1271E EUROPE	35

⑥ IC-1271A:

Push the SEL SWITCH to select a tone number.

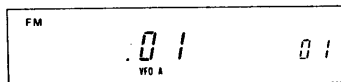

Push the TONE SWITCH.

IC-1271E:

Push the TONE SWITCH to transmit the tone burst.

- ② Place the T/R SWITCH at TRANSMIT or push the PTT (push-to-talk) switch on the microphone and the transceiver begins transmitting. Simultaneously, the red TRANSMIT LED lights, and the meter indicates the relative output power of the transmitter.
- ③ Rotate the RF POWER CONTROL while watching the meter needle to select the desired output power. The output power is adjustable between 1 and 10 watts.
- ④ Speak into the microphone in a normal voice. Note, the VOX function does not operate in this mode.
- ⑤ For DUPLEX (repeater) operation, push the -DUPLEX or +DUPLEX SWITCH according to the repeater's input/output frequency relationship. When the IC-1271A/E is first turned ON, the offset frequency is preset as shown in the table. This is the normal repeater input/output frequency separation. For more detailed information, see SECTION 5-7 SPLIT (DUPLEX) OPERATION.

If you desire to operate through a repeater that has a different transmit/receive frequency offset than shown in the table for your version, reset the offset frequency for your requirement by following the instructions in SECTION 5-7.

⑥ IC-1271A (U.S.A. version):

If a subaudible tone is required to access a repeater, push the SUBAUDIBLE TONE SWITCH to activate the tone encoder, and note that the SUBAUDIBLE TONE INDICATOR lights at the same time. Push and hold the TONE SELECT SWITCH, and rotate the TUNING CONTROL to choose a different tone number. The number appears on the FREQUENCY DISPLAY. See SECTION 5-7 for more information.

IC-1271A (Australia version):

No subaudible tone unit is installed.

IC-1271E (Europe version):

If a tone burst is required for initial access of a repeater, push the TONE SWITCH on the front panel for the required length of time. The TONE SELECT SWITCH (SEL) is not functional on this version.

5-4 SSB OPERATION

(1) RECEIVING

- ① Select either USB or LSB mode.

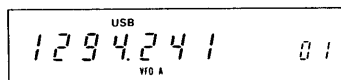

- ② Set the AF GAIN and TUNING CONTROLS.

- ③ Adjust the RF GAIN and TONE CONTROLS.

- ① Push the desired mode switch (USB or LSB), if the displayed mode is different than the desired one.

When operating SSB, there is a choice of USB (upper sideband) or LSB (lower sideband). Normally, USB is used for most communications.

- ② Turn the AF GAIN CONTROL clockwise for a comfortable level. Rotate the TUNING CONTROL until a signal is located, and adjust for a maximum reading on the meter and the clearest audio. If the signal is unintelligible, try changing to the opposite sideband (USB or LSB).

- ③ Adjust the RF GAIN CONTROL and TONE CONTROL for best reception.

- ④ Adjust the SQUELCH CONTROL.

●NOISE BLANKER

●RIT (RECEIVE INCREMENTAL TUNING)

RIT INDICATOR lights when the RIT function is activated.

●AGC (AUTOMATIC GAIN CONTROL)

●PREAMP SWITCH (When external preamp unit is installed)

(2) TRANSMITTING

- ① Set the MIC GAIN and RF POWER CONTROLS.
MIC GAIN CONTROL CENTER (12 o'clock)
RF POWER CONTROL Fully counterclockwise
- ② Push the PTT SWITCH to transmit.
- ③ Speak into the microphone using a normal voice.

- ④ If the squelch function is desired to cancel the noise when no signal is being received, rotate the SQUELCH CONTROL clockwise until the noise just disappears from the speaker.

Push the NB (NOISE BLANKER) SWITCH IN to attenuate pulse noise when it is present. A common source of this type of noise is automobile ignitions. The noise is suppressed, allowing easy reception of even weak signals. The noise blanker may not work as effectively when there is a strong signal on a nearby frequency, or when there is continuous (not pulse) noise present.

- ① By using the RIT circuit, you can shift the receive frequency $\pm 2.5\text{kHz}$ (maximum) on either side of the transmit frequency without moving the transmit frequency itself. Therefore, when a signal is received slightly off-frequency, or if the other station's transmitter drifts, you can tune your receiver for the best reception without altering your own transmit frequency.
- ② Push the RIT SWITCH to activate the RIT circuit and note that the RIT INDICATOR lights.
- ③ Rotating the control in the (+) direction raises the receive frequency, and in the (-) direction lowers the receive frequency.

Push the RIT SWITCH again to turn the RIT function and RIT INDICATOR OFF.

The IC-1271A/E has a fast attack/slow release AGC system which holds the peak voltage of the rectified IF signal from the IF amplifier circuit for a certain period of time, facilitating reading of the S-meter.

For normal SSB reception, set the AGC SWITCH OUT (slow). When tuning or receiving signals with short interval fading, set the AGC SWITCH IN (fast). In this case, the time constant of the AGC circuit is shortened.

Push the PREAMP SWITCH IN when receiving weak signals. An RF preamplifier is inserted into the receive antenna circuit, increasing sensitivity and allowing more enjoyable reception.

- ① Before, transmitting, listen in the receive mode to make sure your transmission will not interfere with other communications. If possible, use a dummy load for transmitter adjustments instead of your antenna. Set the MIC GAIN and RF POWER CONTROLS.
- ② Set the other controls and switches the same as for RECEIVING. Place the TRANSMIT/RECEIVE SWITCH to TRANSMIT, push the PTT SWITCH on the microphone to turn the transmitter ON. The red TRANSMIT INDICATOR lights.
- ③ Speak into the microphone and note that the meter needle follows the modulation of your voice. SSB signals are now being transmitted.

Hold the microphone about three inches from your mouth and speak in a normal voice. The supplied microphone is an electret condenser type, and it functions well with most voice levels. Speaking loudly into the microphone does not increase the RF output power, but may cause some distortion in the SSB signal.

- ④ Adjust the RF POWER CONTROL.
- ⑤ Release the PTT SWITCH to receive.

● **VOX OPERATION**

Controls under the HATCH COVER.

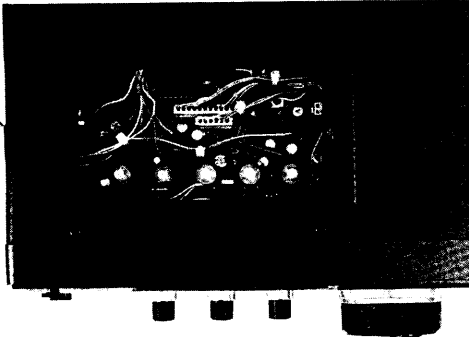

See page 11 for more information.

- ④ To increase the output power, rotate the RF POWER CONTROL clockwise for the desired output between 1 and 10 watts.
- ⑤ To return to the receive mode, place the TRANSMIT/RECEIVE SWITCH at RECEIVE, or release the microphone PTT SWITCH.

- ① The IC-1271A/E has a built-in VOX (voice operated relay) circuit which allows automatic T/R switching by voice signals picked up by the microphone. To use the VOX function, set the controls under the hatch cover on the top of the transceiver as follows:

VOX GAIN CONTROL Fully counterclockwise
 VOX DELAY CONTROL Fully clockwise
 ANTI-VOX CONTROL Fully counterclockwise

- ② Push the VOX SWITCH on the front panel IN. Speak into the microphone normally. While speaking, adjust the VOX GAIN CONTROL clockwise until the IC-1271A/E begins transmitting (red TRANSMIT LED lights). While performing this step, leave the TRANSMIT/RECEIVE SWITCH at RECEIVE and do not push the PTT SWITCH on the microphone.
- ③ The transmit release time (time delay before the set automatically returns to the receive mode after you finish speaking) is controlled by the VOX DELAY CONTROL. Turn the control counterclockwise to reduce the release time. Set it to allow for short pauses in normal speech without switching.
- ④ Adjust the ANTI-VOX CONTROL so the VOX circuit is not activated by sounds from the speaker. Perform this adjustment while receiving a signal at the normal volume.

5 - 5 CW OPERATION

(1) RECEIVING

- ① For CW reception, push the CW MODE SWITCH and note that the CW INDICATOR on the FREQUENCY DISPLAY lights. Set the other controls and switches the same as for SSB.
- ② Rotate the TUNING CONTROL until a CW signal is heard with approximately an 800Hz tone from the speaker or headphones.
- ③ Set the NOISE BLANKER, AGC, RF GAIN and TONE controls the same as for SSB.

(2) TRANSMITTING

- ① Insert the key plug into the KEY JACK on the rear panel of the transceiver, and set the controls and switches the same as for CW reception.
- ② Set the T/R SWITCH to TRANSMIT. The red TRANSMIT INDICATOR lights, and the transmitter is ready for a CW transmission.
- ③ As you begin sending with the key, the meter needle follows your sending, indicating your signal is being transmitted. To receive again, place the T/R SWITCH at RECEIVE.

● **WIRING FOR STRAIGHT KEY**

* Use the supplied key plug.

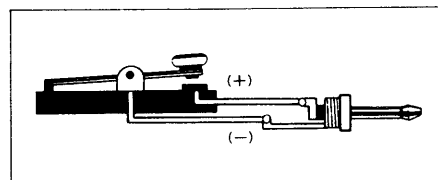

●CW MONITOR

When keying, the sidetone oscillator circuit is activated and an 800Hz tone is heard from the speaker or headphones. The loudness of this tone is adjusted by rotating the CW MONITOR CONTROL located under the hatch cover. Clockwise rotation increases the level of the tone. In the receive mode, the sidetone is also audible and may be used for Morse code practice or adjustment of the key. DO NOT transmit while performing these two activities!

●SEMI BREAK-IN OPERATION

The IC-1271A/E has semi break-in CW capability when using the VOX function. The action of keying alone causes the transmitter to switch on and transmit. When keying is stopped, the IC-1271A/E returns to the receive mode automatically after an adjustable transmit release time constant. Leave the T/R SWITCH at RECEIVE, and set the transmit release time constant with the CW DELAY CONTROL located under the hatch cover. Turn the control clockwise to increase the transmit release time. Adjust it to suit your keying speed.

5-6 ATV (AMATEUR TELEVISION) OPERATION

By connecting the optional TV-1200 ATV unit between your transceiver and a video tape recorder, you can easily join those who have discovered the fascination of amateur fast scan television.

●INTERCONNECTIONS

After connecting the cables as shown in the above diagram, you are ready to transmit and receive Amateur Television!

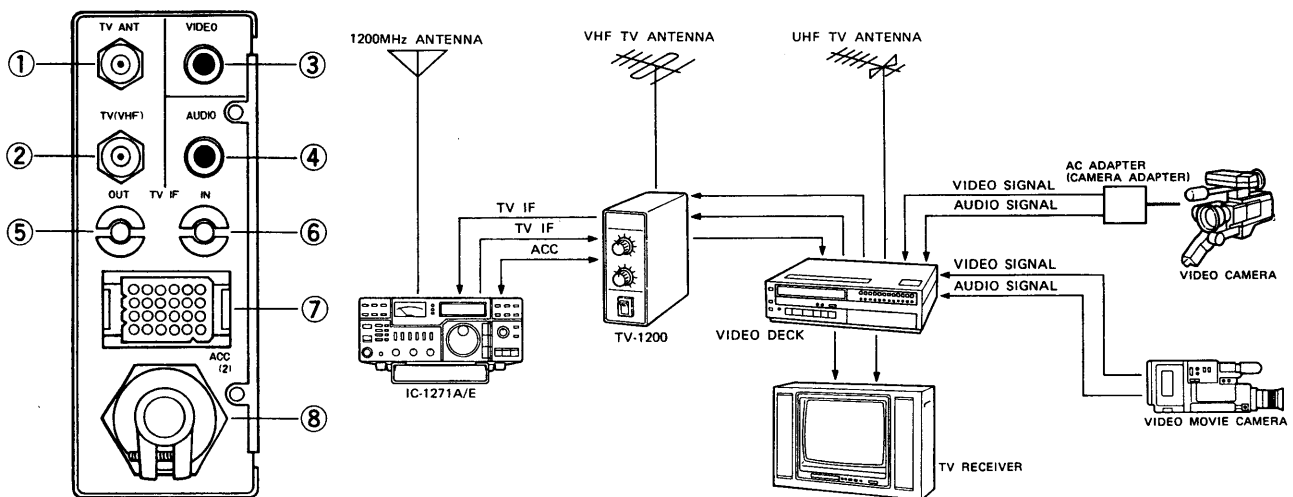

If you don't have a VTR and a camera, you can still receive ATV communications with the TV-1200 and an ordinary television set.

- ①TV ANT : This is an input jack which connects to a VHF antenna.
- ②TV (VHF) : This is an output jack which connects to the VHF input jack on a video recorder.
- ③VIDEO : This is an input jack which connects to the video output jack on a video recorder.
- ④AUDIO : This is an input jack which connects to the audio output jack on a video recorder.
- ⑤TV IF OUT : This is a cable which connects to the TV IF IN (T) JACK on the IC-1271A/E rear panel.
- ⑥TV IF IN : This is a cable which connects to the TV IF OUT (R) JACK on the IC-1271A/E rear panel.
- ⑦ACC : This is an extra ACC CONNECTOR which may be used for attaching other accessories to the IC-1271A/E.
- ⑧ACC (2) : This is a cable which connects to the ACC CONNECTOR on the IC-1271A/E rear panel.

5-7 SPLIT (DUPLEX) OPERATION

• +DUPLEX AND -DUPLEX SWITCHES

VERSION	OFFSET FREQUENCY (MHZ)
IC-1271A U.S.A.	20
IC-1271A AUSTRALIA	12
IC-1271E EUROPE	35

EXAMPLE (U.S.A. version):

- ① Select 1295.000MHz.



- ② Push the -DUPLEX SWITCH.

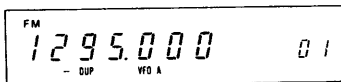

- ③ Transmit display.

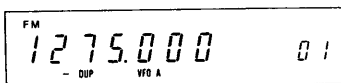

- ④ Push the CHECK SWITCH to receive on the repeater input frequency.

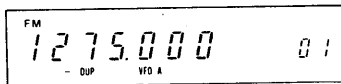

• RESET THE OFFSET FREQUENCY

EXAMPLE:

- ① Select VFO A and the FM mode.
② Push the OW SWITCH.



The purpose of the split function is to allow an operator the option of transmitting and receiving on two different frequencies. Push the +DUPLEX or -DUPLEX SWITCH to turn the function ON and OFF.

During split frequency operation, the letters "DUP" or "-DUP" light on the FREQUENCY DISPLAY.

When the +DUPLEX SWITCH is pushed, the transceiver enters the duplex mode, and the transmit frequency is set above the receive frequency by the amount shown in the table.

When the -DUPLEX SWITCH is pushed, the transceiver also enters the duplex mode, and the transmit frequency is set below the receive frequency by the amount shown in the table.

While in the duplex mode, you may push the CHECK SWITCH to reverse the transmit and receive frequencies temporarily (only while the switch is held in). This feature is useful to check the input frequency of a repeater to determine if your contacted station's signal is strong enough to allow moving to a simplex frequency.

- ① Select the frequency 1295.000MHz with the TUNING CONTROL.

- ② Push the -DUPLEX SWITCH. The FREQUENCY DISPLAY shows "1295.000" and the letters "-DUP" light.

- ③ You are now receiving on 1295.000MHz and transmitting on 1275.000MHz.

- ④ Push the CHECK SWITCH. The FREQUENCY DISPLAY shows "1275.000" and the receive frequency is 1275.000MHz (i.e. the repeater input frequency) as long as the switch is pushed. These functions are available when using either of the VFOs or any of the memory channels.

The offset frequency can be reset to any multiple of 25kHz.

In the FM mode, after pushing the OFFSET WRITE SWITCH, the FREQUENCY DISPLAY shows the 10MHz to 1kHz digits of the offset frequency instead of the operating frequency. If no offset frequencies have been reset since turning the transceiver power ON, "20.000" (U.S.A. version) is shown on the display.

NOTE: With the TUNING SPEED SWITCH OUT, the offset can only be changed when in the FM mode, in 25kHz steps. With the TUNING SPEED SWITCH IN, the offset can be changed in 1kHz steps in all modes.

- ① Select VFO A and the FM mode.

- ② Push the OFFSET WRITE (OW) SWITCH, and the FREQUENCY DISPLAY shows "20.000" on the U.S.A. version. Refer to the table for other versions.

- ③ Set the offset frequency to 35MHz.



- ④ Push the -DUPLEX SWITCH and transmit.



● **SUBAUDIBLE TONE**
(IC-1271A/U.S.A. only)

EXAMPLE:

- ① Push the TONE SWITCH.

- ② Push the SEL SWITCH.

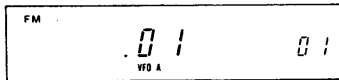

- ③ Select the tone frequency by rotating the TUNING CONTROL.

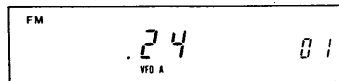

The transceiver is now ready to operate with the CTCSS function using an 88.5Hz encoder/decoder frequency.

- ③ While holding the OFFSET WRITE SWITCH, rotate the TUNING CONTROL clockwise until the display reads "35.000", then release the OFFSET WRITE SWITCH.

- ④ Push the -DUPLEX SWITCH. "-DUP" lights on the display. If, for example, the frequency 1295.000MHz is now selected as a receive frequency, the transmit frequency will be 1260.000MHz.

An optional UT-15 TONE ENCODER/CTCSS UNIT is available and may be installed in your IC-1271A. This is a complete subaudible tone encoder/decoder contained in one package.

- ① When the encoder/decoder is installed, push the TONE ENCODER (TONE) SWITCH and note that the TONE ENCODER INDICATOR illuminates. The encoder/decoder is now activated.

- ② Push the TONE SELECT (SEL) SWITCH to view the presently selected tone number on the FREQUENCY DISPLAY.

- ③ Choose the desired tone by rotating the TUNING CONTROL while pushing the TONE SELECT (SEL) SWITCH.

When the tone number selected is between 1 and 31, the encoder/decoder functions as a CTCSS (Continuous Tone Coded Squelch System), whereas the unit functions as a subaudible tone encoder when tones 32 through 63 are selected.

TONE NO.	FREQUENCY (Hz)		TONE NO.	FREQUENCY (Hz)		TONE NO.	FREQUENCY (Hz)	
	IC-1271A (original)	OPTIONAL UNIT		IC-1271A (original)	OPTIONAL UNIT		IC-1271A (original)	OPTIONAL UNIT
1	67.0	192.8*	22	141.3	94.8*	43	900.0	136.5
2	71.9	186.2*	23	146.2	91.5*	44	1000.0	131.8
3	74.4	179.9*	24	151.4	88.5*	45	1600.0	127.3
4	77.0	173.8*	25	156.7	85.4*	46	1700.0	123.0
5	79.7	167.9*	26	162.2	82.5*	47	1750.0	118.8
6	82.5	162.2*	27	167.9	79.7*	48	1800.0	114.8
7	85.4	156.7*	28	173.8	77.0*	49	1300.0	110.9
8	88.5	151.4*	29	179.9	74.4*	50	2000.0	107.2
9	91.5	146.2*	30	186.2	71.9*	51	2200.0	103.5
10	94.8	141.3*	31	192.8	67.0*	52	2975.0	100.0
11	97.4	136.5*	32	203.5	204.5	53	2550.0	97.4
12	100.0	131.8*	33	210.7	192.8	54	2295.0	94.8
13	103.5	127.3*	34	218.1	186.2	55	2125.0	91.5
14	107.2	123.0*	35	225.7	179.9	56	-----	88.5
15	110.9	118.8*	36	233.6	173.8	57	-----	85.4
16	114.8	114.8*	37	241.8	167.9	58	-----	82.5
17	118.8	110.9*	38	250.3	162.2	59	-----	79.7
18	123.0	107.2*	39	500.0	156.7	60	-----	77.0
19	127.3	103.5*	40	600.0	151.4	61	-----	74.4
20	131.8	100.0*	41	700.0	146.2	62	-----	71.9
21	136.5	97.4*	42	800.0	141.3	63	-----	67.0

*CTCSS

NOTE: The original subaudible tone encoder of the IC-1271A has frequencies as shown. When the optional encoder/decoder is installed in the IC-1271A, the original encoder is disconnected from the circuit and only the newly installed encoder/decoder is activated.

5 - 8 MEMORY CHANNEL OPERATION

(1) MEMORY CHANNEL SELECTION

There are thirty-two MEMORY CHANNELS numbered 1 through 32 available. One frequency and one associated mode may be assigned to each MEMORY CHANNEL whether the transceiver is in the VFO mode or the MEMORY CHANNEL mode.

- ① Turn the POWER SWITCH ON.
- ② Push the VFO/M SWITCH to select the MEMORY CHANNEL mode.

- ① Turn the POWER SWITCH ON. The transceiver automatically selects VFO A and memory channel number "01" is displayed.
- ② Push the VFO/MEMORY (VFO/M) SWITCH, and the transceiver switches to the MEMORY CHANNEL mode. The frequency, mode and simplex/duplex status stored in MEMORY CHANNEL 01 are displayed on the FREQUENCY DISPLAY.

- ③ Rotate the TUNING CONTROL to select your desired channel.

- ③ By rotating the TUNING CONTROL, memory channels can be selected. Turning clockwise increases the channel and counter-clockwise decreases the channel. Also, the respective frequency, mode and duplex status (if stored) are displayed for each channel.

NOTE: Random frequencies were stored in the memories at the factory for testing purposes.

When a memory channel is selected which has no frequency stored, only the MHz decimal point light. However, the transceiver continues to function with the frequency and mode of the previously selected memory channel or VFO.

Unprogrammed channel



● DIAL FUNCTION SELECT (DFS) SWITCH (Memory Channel Mode)

While in the MEMORY CHANNEL mode, pushing the DIAL FUNCTION SELECT (DFS) SWITCH locks the memory channel on which you are presently operating, and allows you to change the displayed frequency by rotating the TUNING CONTROL. This feature is convenient when you wish to store a new frequency, possibly only a little different from the previous one.

The following chart illustrates the operation of the VFO/M and DFS SWITCHES.

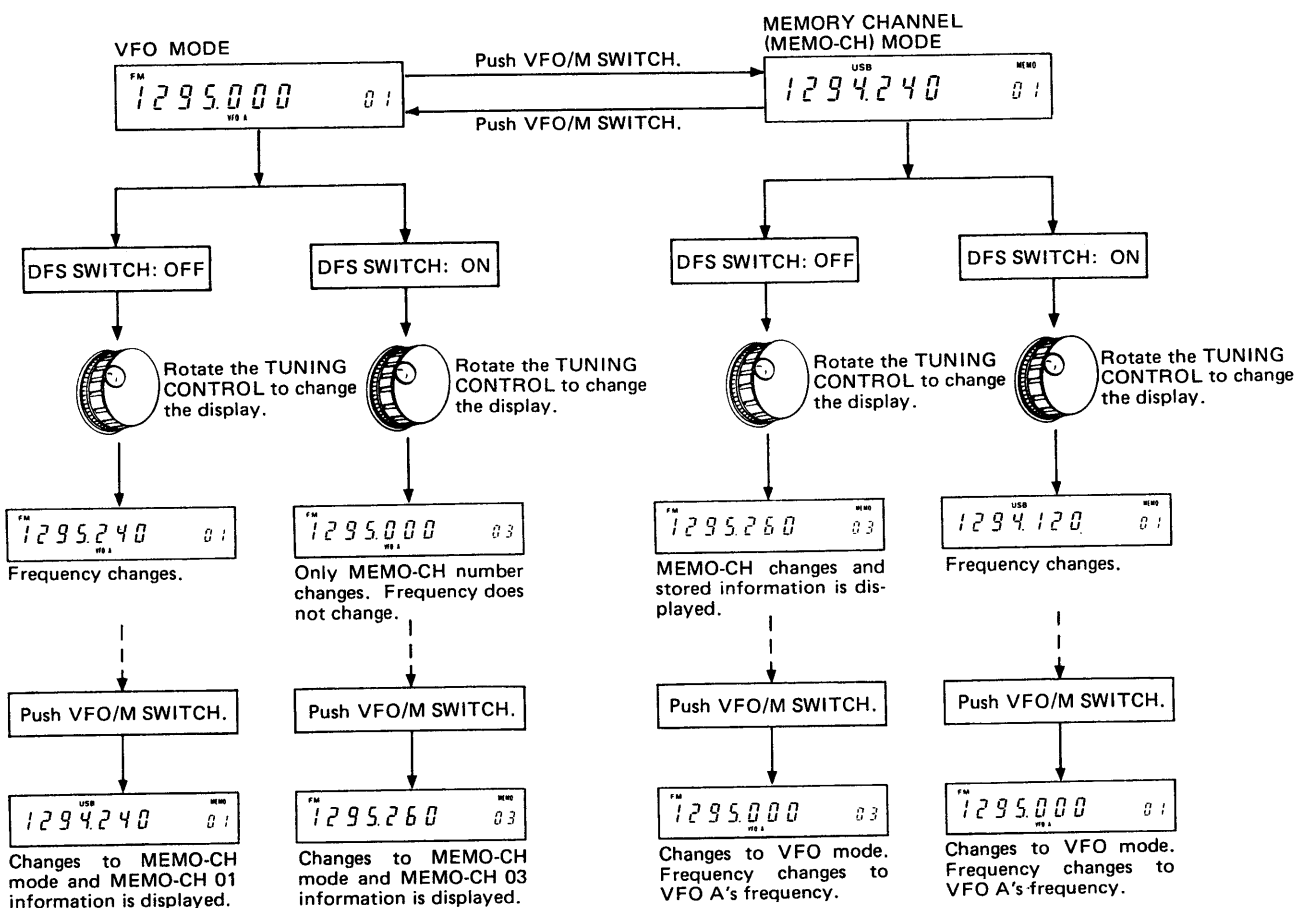

(2) PROGRAMMING THE MEMORY CHANNELS

EXAMPLE:

- ① Set the operating frequency, mode and duplex direction using VFO B.



- ② Push the DFS SWITCH IN to select MEMO-CH 10.



- ③ Push the VFO/M SWITCH to check the stored data in MEMO-CH 10.

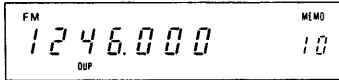

NOTE: When no frequency is memorized in a channel, only the MHz and kHz decimal points are displayed in place of the frequency.

- ④ Push the MEMORY WRITE SWITCH to store the information in MEMO-CH 10.



- ⑤ All information shown in step 1 is now stored in MEMO-CH 10.

Any operating frequency, mode, duplex direction and offset frequency (if desired), and subaudible tone number can be stored in a memory channel.

- ① Select the operating frequency, mode and duplex direction (if desired) with one of the VFOs. For example, select "1288.000 MHz", "FM" and "DUP" with a 20MHz offset using VFO B.

- ② Push the DFS SWITCH IN, then select a memory channel to be stored by rotating the TUNING CONTROL. For example, select memory channel 10.

- ③ To check the information stored in a memory channel, push the VFO/MEMORY SWITCH. The memory contents are displayed on the FREQUENCY DISPLAY. If you prefer not to erase this information, choose a channel with unneeded information, or an unprogrammed channel. Next, push the VFO/MEMORY SWITCH again to return to the VFO mode.

- ④ One push of the MEMORY WRITE SWITCH erases the previously memorized contents (if any) and stores the displayed frequency, mode and duplex direction including offset frequency in the selected memory channel (channel 10 in this example).

- ⑤ Memorize other desired frequencies into the memory channels in the same manner. Remember that memory channels 1 and 2 are also used for the PROGRAMMED SCAN function. See SECTION 5 - 9 SCANNING OPERATION for further information.

5 - 9 SCANNING OPERATION

(1) MEMORY SCAN

- ① Program the desired frequencies.

This is used to scan all programmed memory channels continuously.

- ① Program the desired frequencies into memory channels.

NOTE: Random frequencies were stored in the memory channels at the factory for testing purposes.

- ② Adjust the SQUELCH CONTROL.

- ② Adjust the SQUELCH CONTROL to mute the noise output from the speaker.

- ③ Push the SCAN START/STOP SWITCH.



- ③ Push the SCAN START/STOP SWITCH, and the IC-1271A/E begins scanning the programmed channels from the highest channel towards the lowest channel. The scan skips unprogrammed channels, if there are any.

- ④ Scan stops when a receive signal opens the squelch.

- ④ Provided the squelch is closed when the scan begins, the scan stops when a receive signal opens the squelch. After a fixed time, the scan resumes.

- ⑤ Push the SCAN SWITCH twice to resume scanning.

- ⑤ Push the SCAN SWITCH to stop the scanning function manually. Push the SCAN SWITCH again to resume scanning.

(2) MODE SELECTIVE SCAN

- ① Push the VFO/M SWITCH.

- ② Adjust the SQUELCH CONTROL.

- ③ Push the MODE-S SWITCH.

- ④ Push the SCAN SWITCH.

(3) PROGRAMMED SCAN

- ① Store the frequencies in memory channels 1 and 2.

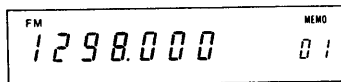

- ② Push the VFO/M SWITCH to select the VFO.

- ③ Adjust the SQUELCH CONTROL.

- ④ Push the SCAN SWITCH.

- ⑤ The squelch opens when a signal is received, and stops the scanning automatically.

The purpose of this scan is to selectively monitor those memory channels which contain frequencies programmed with the same mode; that is FM, USB, LSB or CW.

- ① Push the VFO/MEMORY (VFO/M) SWITCH to select the MEMORY CHANNEL mode.

The MODE SELECTIVE SCAN only stops on the channels which have the same mode as the channel from which the scan begins. Therefore, use the TUNING CONTROL to select a memory channel which has the same mode as you wish to scan. Or, when the transceiver is scanning in the normal memory scan mode push the MODE SELECTIVE SWITCH at the moment your desired mode appears on the FREQUENCY DISPLAY.

- ② Adjust the SQUELCH CONTROL to mute the noise output from the speaker.

- ③ Push the MODE SELECTIVE (MODE-S) SWITCH IN.

- ④ Push the SCAN START/STOP SWITCH.

The transceiver begins from the channel selected in step 1, and steps through each memory channel with the same mode, stopping only when a receive signal is detected.

The purpose of this scanning function is to monitor a particular section of the band. The frequency limits of the section of the band of interest must be programmed in memory channels 1 and 2.

- ① Store the frequencies of the high and low limits of the desired scanning range in memory channels 1 and 2. See SECTION 5 - 8 MEMORY CHANNEL OPERATION, if necessary, for instructions on how to write frequencies into memory channels. The scan begins from the high limit of the range regardless of which channel has the higher frequency stored.

- ② Push the VFO/MEMORY SWITCH to select the VFO you wish to use.

- ③ Adjust the SQUELCH CONTROL to mute the noise output from the speaker.

- ④ Push the SCAN SWITCH to start the scanning from the high limit towards the low limit. The scanning rate depends on the TUNING SPEED SWITCH status. Normally, the scanning steps are 100Hz on SSB and CW, and 25kHz on FM.

When the scan frequency reaches the low limit, the scan automatically returns to the high limit frequency and resumes downwards again in a continuous cycle.

- ⑤ The squelch opens when a signal is received, and stops the scanning automatically if the SQUELCH CONTROL has been set as explained above. After approximately 10 seconds, the scan resumes from the frequency that it stopped on in a downwards direction. If the RECEIVE INDICATOR remains ON, for example if the SQUELCH CONTROL is rotated fully counter-clockwise, the scan will not stop at any other signals.

- ⑥ Pushing the SCAN SWITCH while the scan is operating, or during the 10 seconds of monitoring, clears the scanning function and the VFO returns to normal operation. Transmitting or rotating the TUNING CONTROL also cancels the scanning function.
- ⑦ When the operating frequency is higher than the high limit and the SCAN START/STOP SWITCH is pushed, the scan starts from the operating frequency and scans downwards to the low limit, then returns to the stored high limit and continues the cycle. If the operating frequency is below the low limit, the scan jumps to the high limit frequency and starts downwards from there.

5 - 10 MICROPHONE UP/DOWN FUNCTION

(1) FREQUENCY CONTROL

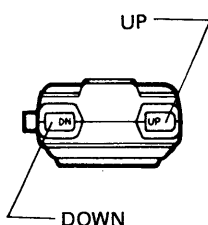

Each push of the UP or DN (down) SWITCH on the supplied microphone causes the operating frequency to shift one increment up or down, respectively. In the same way, holding each switch down continuously, changes the operating frequency up or down as if rotating the TUNING CONTROL. The tuning rate is dependent on the operating mode and setting of the TUNING SPEED SWITCH.

This function is effective in the VFO mode and when the DFS SWITCH is pushed IN to change the operating frequency in the MEMORY CHANNEL mode.

(2) SELECTING MEMORY CHANNELS

When in the MEMORY CHANNEL mode or when the DFS SWITCH is pushed IN, the displayed memory channel number changes by holding the UP or DN (down) SWITCH on the microphone down continuously. The operating memory channel or displayed channel number changes up or down every two seconds.

5 - 11 LITHIUM BATTERY (BACKUP BATTERY)

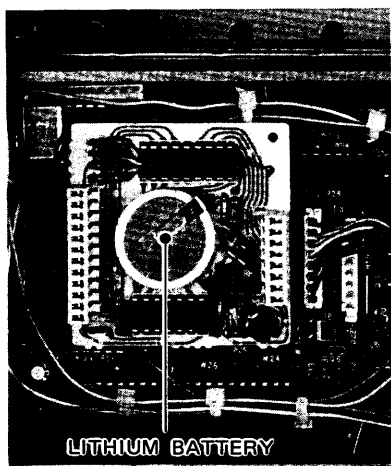

The IC-1271A/E uses an advanced, highly reliable RAM integrated circuit which is completely separate from the transceiver's main microprocessor. The purpose of the battery is to provide power to the RAM so it retains all memory information during power failures, or when the unit is unplugged or turned off.

The usual life of the lithium battery is approximately five years of use. It is advisable to monitor the lithium battery carefully and replace it if there are repeated cases of display malfunction.

NOTE: Battery replacement must be done by your nearest ICOM Authorized Dealer or ICOM Service Center.

The lithium battery location is shown in SECTION 6 - 2.

When the battery is removed, the FREQUENCY DISPLAY reads incorrectly.

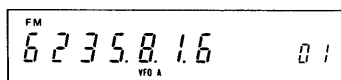

SECTION 6 INSIDE VIEWS

6-1 TOP VIEW
(MAIN, IF, RF UNIT)

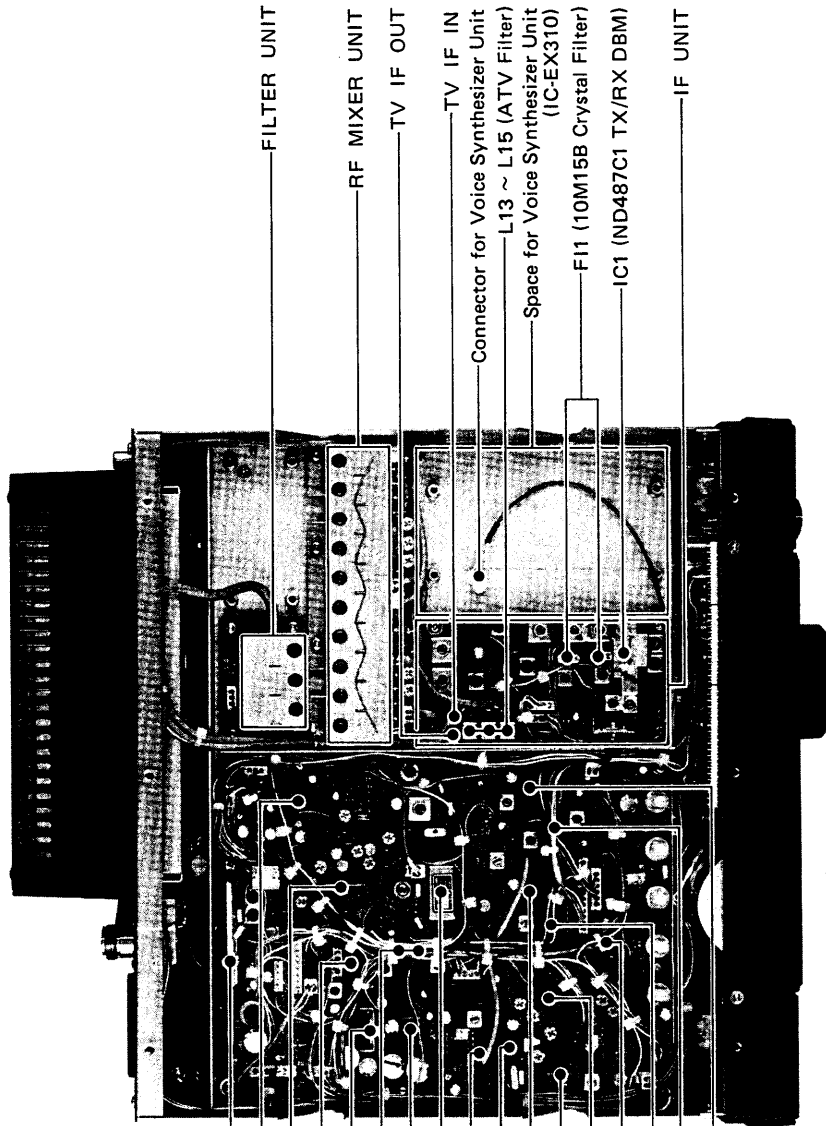

- IC15 (MB3756 Voltage Regulator IC)
- IC1 (NJM4558D Mic Amplifier)
- IC3 (μ PC1037H Modulator/Demodulator)
- Q17 (2SC945 AGC Amplifier)
- IC12 (μ PC2002 AF AMP)
- Q18, Q19 (3SK74 SSB IF Amplifier)
- IC13B (AN829 Squelch Control)
- F11 (10M24D4 SSB Crystal Filter)
- IC14 (MC3357P FM IF Circuit IC)
- F12 (CFW455E Ceramic Filter)
- IC4 (μ PC577H NB Amplifier)
- IC8 (μ PC577H FM Meter Amplifier)
- IC9 (NJM4558D SSB Meter, Squelch Amplifier)
- IC5 (NJM4558D FM Center Meter, VOX Control)
- IC6 (M5323P NB Gate Control)
- Q12 (3SK74M RX IF Amplifier)
- Q4 (3SK74K TX IF Amplifier)
- FILTER UNIT
- RF MIXER UNIT
- TV IF OUT
- TV IF IN
- Connector for Voice Synthesizer Unit
- L13 ~ L15 (ATV Filter)
- Space for Voice Synthesizer Unit (IC-EX310)
- F11 (10M15B Crystal Filter)
- IC1 (ND487C1 TX/RX DBM)
- IF UNIT

6-2 BOTTOM VIEW
(LOGIC UNIT)

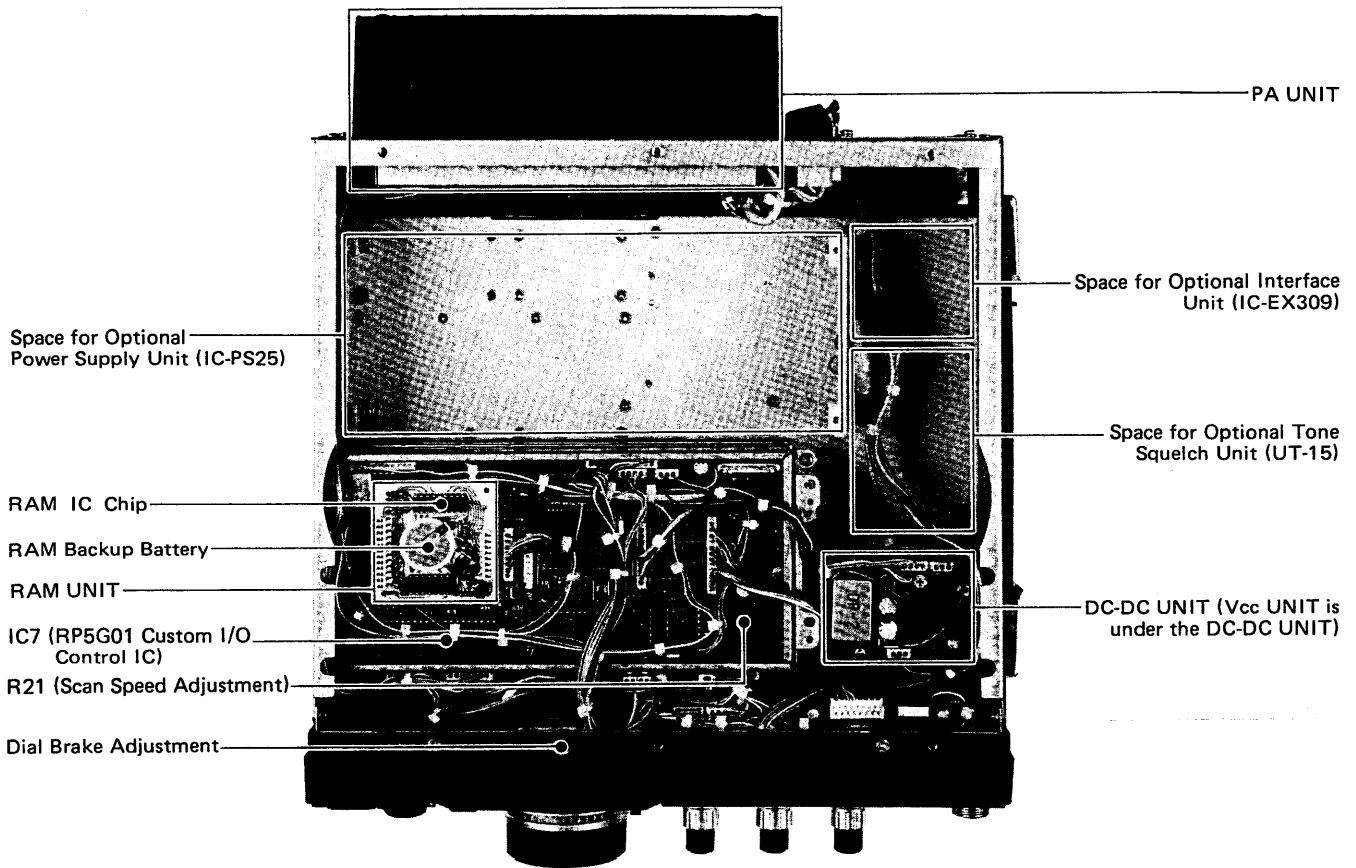

6-3 PLL UNIT

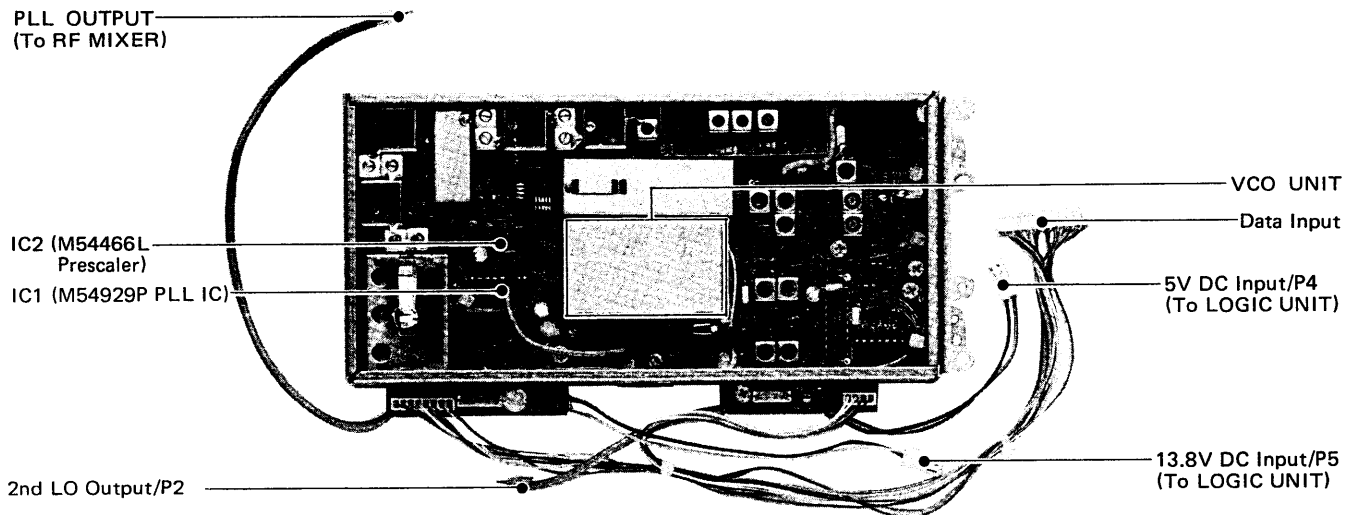

SECTION 7 OPTION INSTALLATION

Before performing any work on the transceiver, confirm the power cable is detached.

Unscrew the six screws from the top and bottom, and the two screws from each side of the transceiver. Remove the covers. Unplug the connector of the internally mounted speaker. Take care not to damage the speaker.

7-1 IC-PS25 INTERNAL POWER SUPPLY

(1) UNPACKING

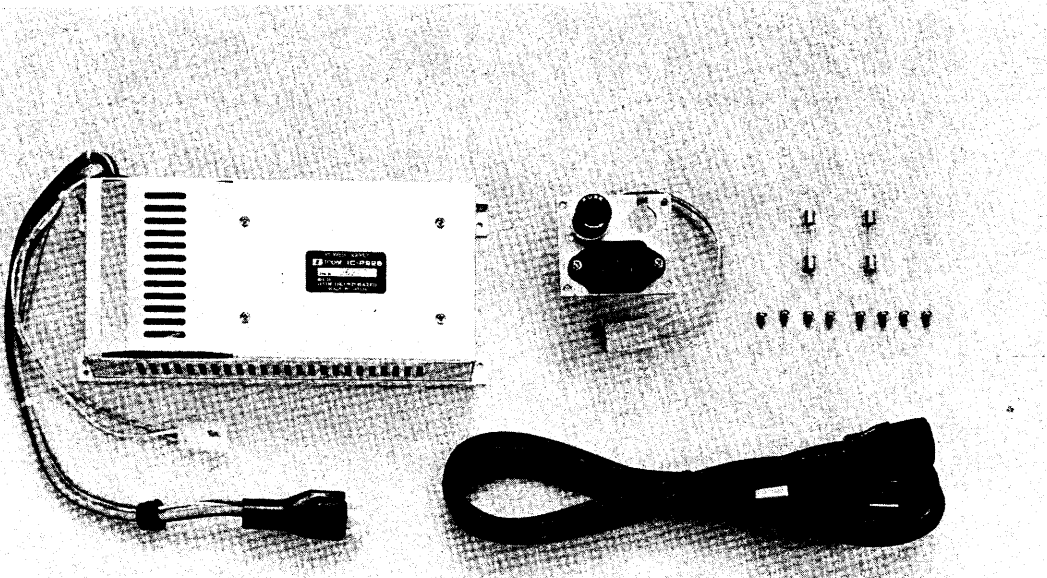

(2) ASSEMBLY PROCEDURE

- ① Turn the IC-1271A/E upside down. Remove PLATE (A) attached to the rear panel by unscrewing the four screws. Keep the screws for use later.

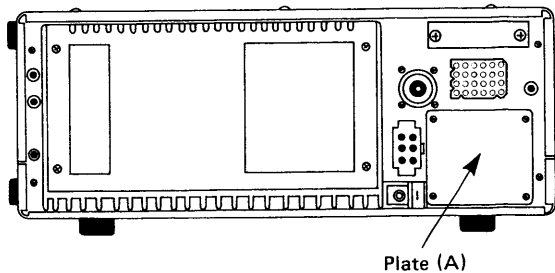
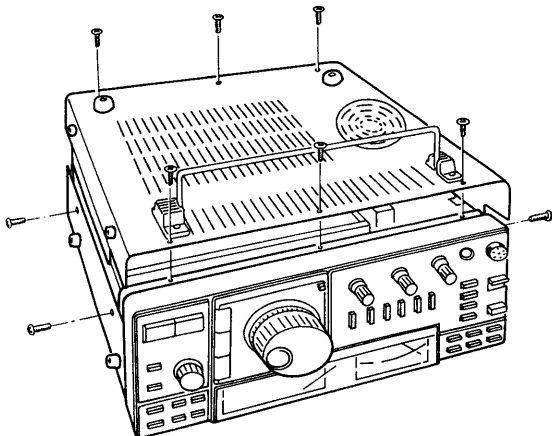

- ② Place the power supply unit into the transceiver so its cables are toward the rear as shown in the illustration, and attach it to the chassis with the supplied screws. Pass the DC power connector, P1, through the hole exposed by the removal of PLATE (A).

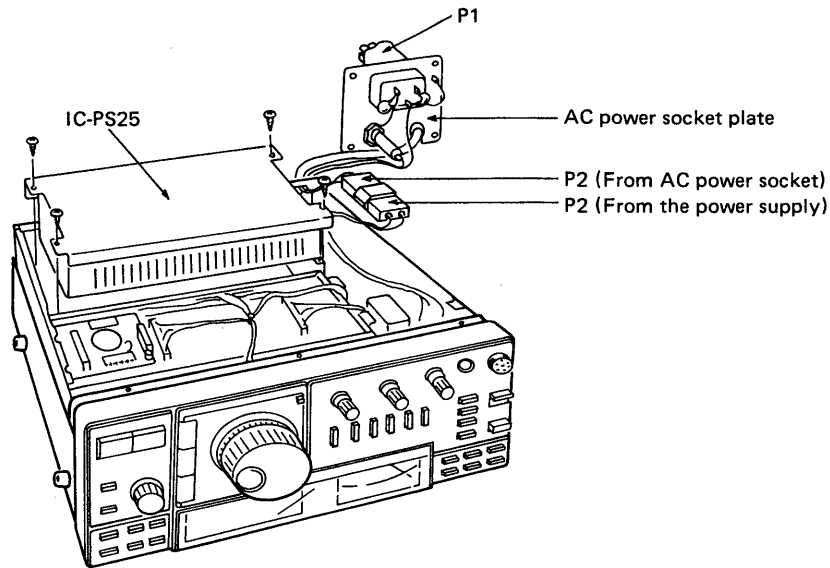

- ③ Pass the DC power cable attached to P1 through the hole of the AC power socket plate as shown in the illustration, then insert the bushing into the hole.

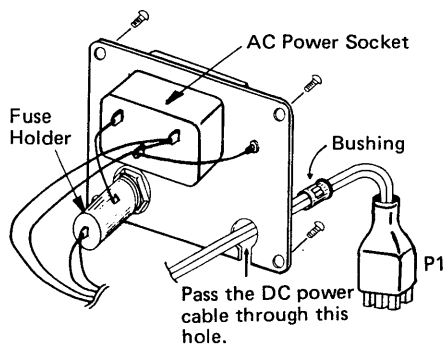

Attach the AC power socket plate to the position where PLATE (A) was attached before. Use the screws removed from PLATE (A), and mount the new plate so the AC socket is closest to the bottom of the radio.

- ④ Connect the P2 connector from the power supply to P2 from the power socket.
 ⑤ Connect the internal speaker connector and replace the bottom and top cabinet covers.

Plug P1 from the power supply into the DC power socket on the IC-1271A/E.

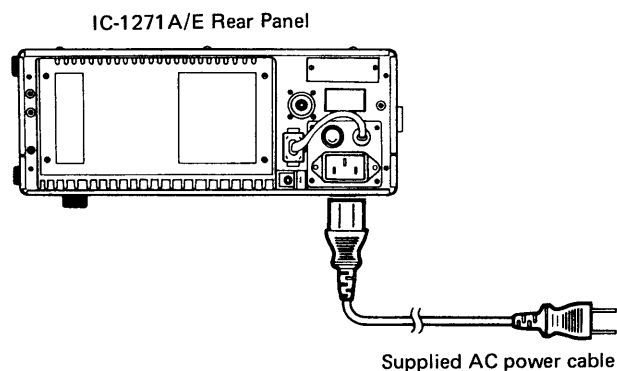
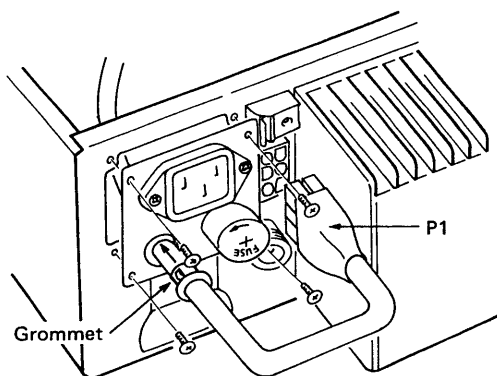

7-2 IC-EX310 VOICE SYNTHESIZER UNIT

(1) ASSEMBLY PROCEDURE

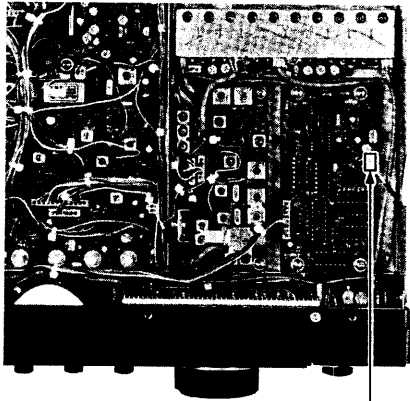

Insert 2 pin plug into J2.

- ① Insert the 2-conductor plug into J2 of the synthesizer unit as shown in the photo. Install the unit with the four supplied screws.
- ② Dress the cable with the 8-conductor plug from the synthesizer unit along the front panel, through the slot between the front panel and the chassis located around the meter hood, to the bottom side.

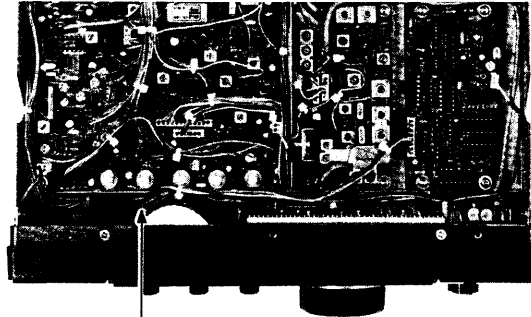

Pass the cord to bottom side.

- ③ Turn the transceiver upside down. Insert the 8-conductor plug into J10 of the LOGIC UNIT.

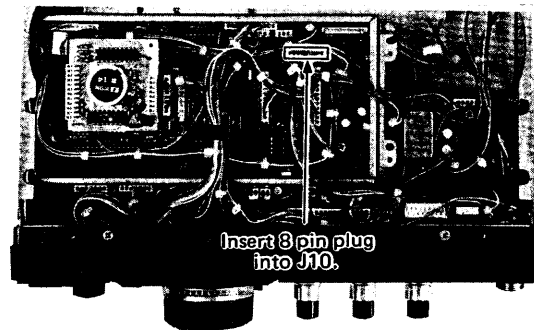

Insert 8 pin plug into J10.

- ④ Adjust the volume and speech speed if necessary (described later).
- ⑤ Connect the internal speaker connector, then replace the top and bottom cabinet covers.

(2) ADJUSTMENT

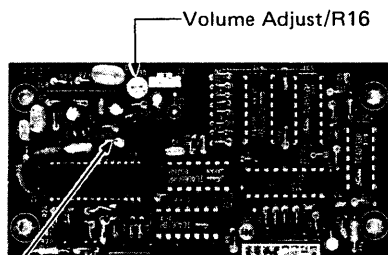

Speaking Speed Adjust
(Cut this for faster speech.)

- ① Adjust the volume of the speech and speech speed before the top and bottom covers are replaced, if necessary.
- ② Connect a power source and turn ON the power switch.
- ③ Push the DIAL LOCK AND SPEECH SWITCH to activate the unit. The displayed frequency is announced in English.
- ④ The loudness of the announcement is adjustable with R16 in the unit. Adjust for a comfortable level.
- ⑤ Cut jumper wire W1 to increase the speech speed.
- ⑥ When finished adjustments, replace the top and bottom covers of the transceiver.

SECTION 8 TROUBLESHOOTING

Your IC-1271A/E has been carefully adjusted at the factory prior to shipping. The chart below has been provided to help you correct problems which are not equipment malfunctions. If you are unable to locate the trouble, or correct the fault, please contact your dealer or the nearest ICOM Service Center.

PROBLEM	POSSIBLE CAUSE	SOLUTION
1. Power does not come on when the POWER SWITCH is pushed.	Power cable is improperly connected. Power cable is connected with the polarity reversed. Blown fuse.	Carefully reconnect power cable. Disconnect the power cable, replace the blown fuse, then reconnect the power cable observing proper polarity. Check for the cause, then replace the fuse with a spare one. If using an IC-PS15 or IC-PS30, also check its fuse.
2. No sound comes from the speaker.	AF GAIN CONTROL is completely counter-clockwise. The set is in the transmit mode, either by the T/R SWITCH or the PTT SWITCH on the microphone. The external speaker cable is connected to the set but not to the speaker. The internal speaker cable is not connected. The headphones are connected to the PHONES JACK.	Rotate the control clockwise to a suitable level. Place the set in the receive mode. Connect the cable to the speaker jack on the external speaker. Connect the internal speaker. Unplug the headphones.
3. Sensitivity is low and only strong signals are audible.	RF GAIN CONTROL is turned counter-clockwise. The antenna feedline is cut or shorted.	Rotate the RF GAIN CONTROL fully clockwise. Check the feedline and correct any improper condition.
4. During receive, the S-meter is higher than the "0" position even when there is no signal.	RF GAIN CONTROL is turned counter-clockwise. The METER SWITCH is pushed IN (in the FM mode).	Rotate the control fully clockwise. Push the METER SWITCH and release it.
5. Only unintelligible voices are heard during SSB reception.	Receiving the wrong sideband. Receiving FM signals.	Select the opposite sideband (USB or LSB). Push the FM MODE SWITCH.
6. No or low output power.	MIC GAIN is too low. CW mode selected but SSB operation is desired. PTT SWITCH is not functioning due to improper connection of the mic connector. The antenna feedline is cut or shorted.	Rotate the MIC GAIN CONTROL clockwise to the center (12 o'clock) position. Push the SSB MODE SWITCH (USB or LSB). Check the MIC CONNECTOR and correct any problems. Check the antenna feedline for any problems.
7. The receiver and transmitter work properly but you are unable to make any contacts: a) operating SIMPLEX. b) operating DUPLEX.	The SPLIT SWITCH is pushed IN. The receive frequency is offset from the transmit frequency by the RIT CONTROL. DUPLEX mode is selected. DUPLEX mode is not selected. Incorrect offset frequency for the repeater.	Set the SPLIT SWITCH to the OUT position. Turn OFF the RIT. Push the -DUP or +DUP SWITCH to clear the DUPLEX mode. Push the -DUP or +DUP SWITCH according to the repeater input/output frequencies. Set the correct offset frequency according to the repeater input/output frequencies.
8. The rear panel becomes hot.	The rear panel is for the heatsink of the PA unit and may become as hot as 40°C (104°F) above room temperature.	Make sure the area around the unit has as much ventilation as possible.
9. The frequency does not change by rotating the TUNING CONTROL.	DIAL LOCK is engaged. Improper DFS SWITCH setting.	Disengage the DIAL LOCK by pushing and releasing the DIAL LOCK SWITCH. Select the correct position for the DFS SWITCH.
10. An abnormal, out-of-band frequency is displayed on FREQUENCY DISPLAY.	The lithium memory backup battery on the RAM board is exhausted.	Contact your nearest ICOM Authorized Dealer or ICOM Service Center.

SECTION 9 BLOCK DIAGRAM

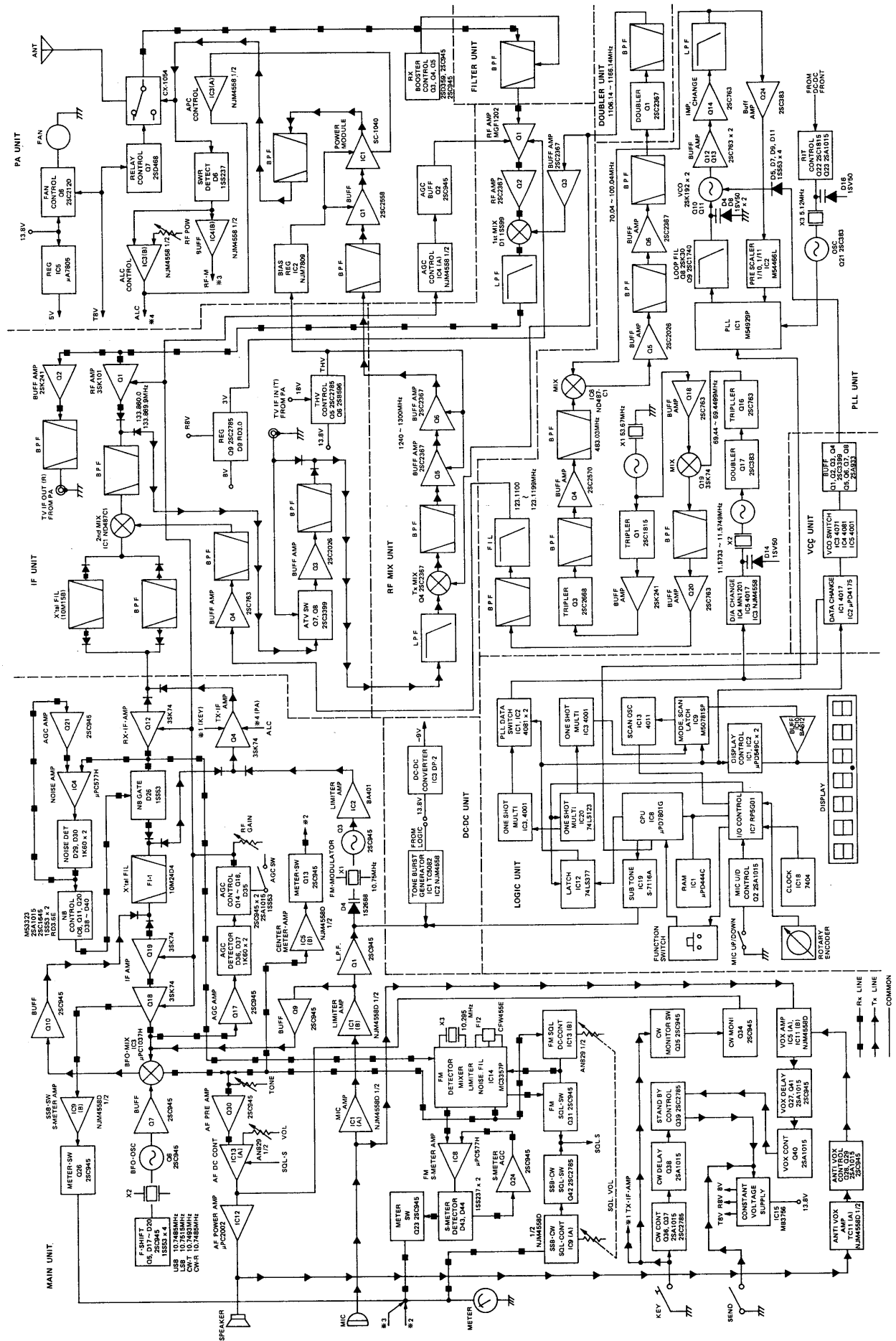

SECTION 10 OPTIONAL UNITS

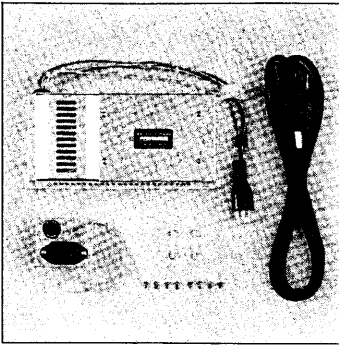

IC-PS25
INTERNAL
AC POWER SUPPLY

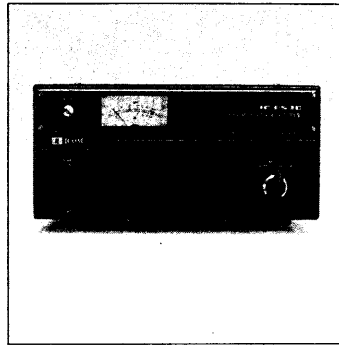

IC-PS30
AC POWER SUPPLY
13.8V, 25A

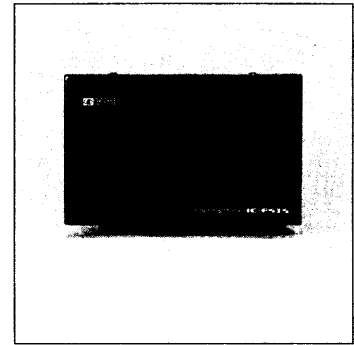

IC-PS15
AC POWER SUPPLY
13.8V, 20A

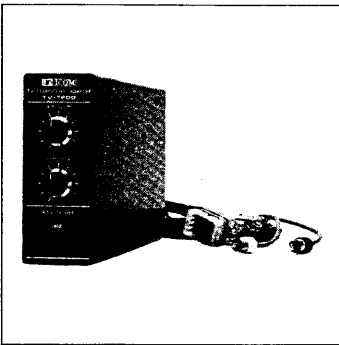

TV-1200
TV TRANSCEIVER ADAPTER
(ATV ADAPTER)

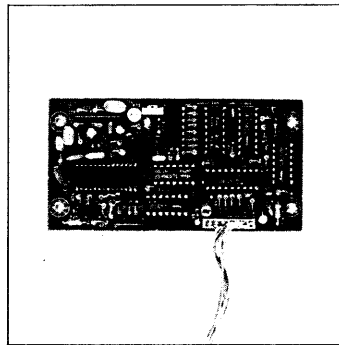

IC-EX310
VOICE SYNTHESIZER UNIT

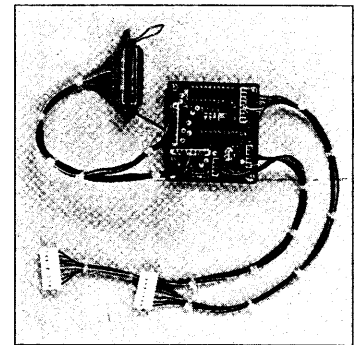

IC-EX309
INTERFACE UNIT

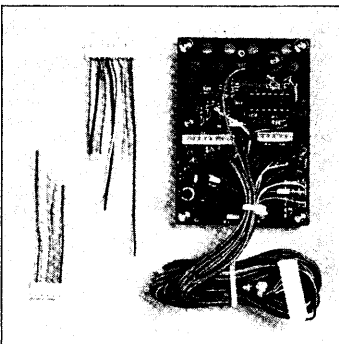

***UT-15**
CTCSS
INTERFACE UNIT

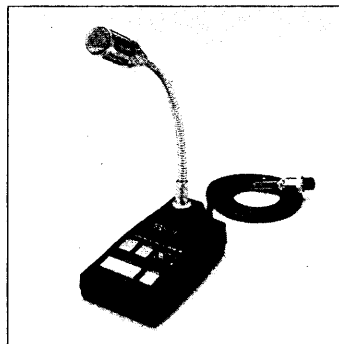

SM-8
DESK MICROPHONE



IC-HP1
COMMUNICATIONS
HEADPHONES

***NOTE:** The TS-32 ENCODER/DECODER UNIT, which mounts on the UT-15, must be purchased separately.



ICOM INCORPORATED

1-6-19, KAMIKURATSUKURI, HIRANO-KU,
OSAKA 547, JAPAN

A-0677
Printed in Japan