

ICOM



INSTRUCTION MANUAL

1200 MHz ALL MODE
TRANSCEIVER

IC-1275A
IC-1275E

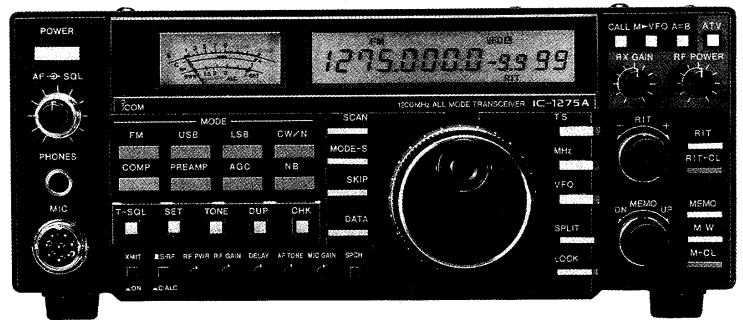

Icom Inc.

INTRODUCTION

Thank you for choosing this new Icom product.

Icom's advanced **IC-1275A/E 1200 MHz ALL MODE TRANSCEIVER** is designed to meet the increasing demand of today's amateur radio users for 1200 MHz band operation. The **IC-1275A/E** is equipped with Icom's advanced DDS (Direct Digital Synthesizer) System, CI-V (Icom Communication Interface-V) System, ATV (amateur television) capability and many other advanced features.

EXPLICIT DEFINITIONS

The following explicit definitions apply to this instruction manual.

WORD	DEFINITION
WARNING	Personal injury, life hazard or electric shock may occur.
CAUTION	Equipment damage may occur.
NOTE	If disregarded, inconvenience only. No personal injury, risk of fire or electric shock.

UNPACKING

Accessories included with the IC-1275A/E:

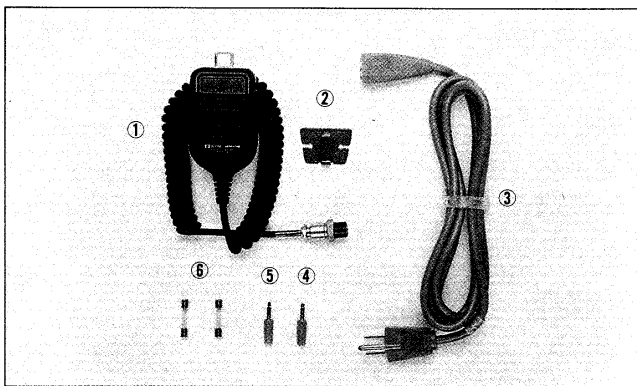

	Qty.
① Microphone (HM-12)	1
② Microphone Hanger	1
③ AC Power Cable	1
④ External Speaker Plug	1
⑤ Key Plug	1
⑥ Spare Fuses*	2

*5 A for the IC-1275A U.S.A. version
3 A for the IC-1275E Europe version

IMPORTANT

- (1) **READ THIS INSTRUCTION MANUAL CAREFULLY** before attempting operation. If you have any questions regarding the operation of the IC-1275A/E, feel free to contact your nearest Icom Dealer or Service Center.
- (2) **SAVE THIS INSTRUCTION MANUAL** – This instruction manual contains important safety and operating instructions for the IC-1275A/E.

PRECAUTIONS

- (1) Unplug the AC power cable from the AC outlet and wait a few minutes, then remove the transceiver cover.
- (2) **NEVER** let metal, wire or other objects touch any internal part of the transceiver. Risk of electric shock could occur.
- (3) **NEVER** place the transceiver within the reach of babies or children at any time.
- (4) **NEVER** expose the transceiver to rain, snow or any liquid.
- (5) **DO NOT** operate the transceiver when it is covered by objects which impede heat dispersal.
- (6) **AVOID** using the transceiver in temperatures below -10°C ($+14^{\circ}\text{F}$) or over $+60^{\circ}\text{C}$ ($+140^{\circ}\text{F}$). The transceiver may not function properly in extreme temperatures.
- (7) **AVOID** using the transceiver in excessively dusty environments.
- (8) **AVOID** placing the transceiver in direct sunlight.
- (9) **BE CAREFUL!** The heatsink may become hot when operating the transceiver continuously for long periods.
- (10) Keep interconnection cables as far away as possible from electronic instruments. This will prevent instrument malfunctions.

TABLE OF CONTENTS

INTRODUCTION.....	i	6 MEMORY OPERATION.....	18 ~ 19
EXPLICIT DEFINITIONS.....	i	6 - 1 Memory channel selection.....	18
UNPACKING.....	i	6 - 2 Memory programming.....	18
IMPORTANT.....	i	6 - 3 Memory data transferring.....	18
PRECAUTIONS.....	i	6 - 4 Memory clearing.....	19
TABLE OF CONTENTS.....	ii	6 - 5 Call channel operation.....	19
1 CONTROL FUNCTIONS.....	1 ~ 5	7 SCAN OPERATION.....	20 ~ 21
1 - 1 Front panel.....	1	7 - 1 Scan types.....	20
1 - 2 Function display.....	4	7 - 2 Programmed scan.....	20
1 - 3 Microphone.....	4	7 - 3 Memory scan.....	21
1 - 4 Rear panel.....	5	7 - 4 Selected mode memory scan.....	21
2 INSTALLATIONS.....	6	7 - 5 Skip function.....	21
2 - 1 Unpacking.....	6	8 MAINTENANCE AND ADJUSTMENT ...	22
2 - 2 Transceiver location.....	6	8 - 1 Fuse replacement.....	22
2 - 3 Antenna.....	6	8 - 2 Backup battery.....	22
2 - 4 Grounding.....	6	8 - 3 CPU resetting.....	22
2 - 5 Mobile installation.....	6	8 - 4 Cleaning.....	22
3 INTERCONNECTIONS.....	7 ~ 9	8 - 5 Brake adjustment.....	22
3 - 1 Rear panel connections.....	7	8 - 6 Display light dimmer adjustment.....	22
3 - 2 Power supply.....	8	8 - 7 Beep sound level adjustment.....	22
3 - 3 Mic connector information.....	8	9 OPTIONS INSTALLATIONS.....	23 ~ 24
3 - 4 ACC(1) socket information.....	9	9 - 1 Transceiver disassembly.....	23
3 - 5 AQS socket information.....	9	9 - 2 UT-34 installation.....	24
3 - 6 CI-V remote control jack information.....	9	9 - 3 FL-83 installation.....	24
4 GENERAL OPERATION.....	10 ~ 15	9 - 4 UT-36 installation.....	24
4 - 1 Initial settings.....	10	9 - 5 CR-263 installation.....	24
4 - 2 Frequency settings.....	10	10 INSIDE VIEWS.....	25
4 - 3 VFO A and VFO B selection.....	10	11 BLOCK DIAGRAM.....	26
4 - 4 Frequency equalizing operation.....	10	12 SPECIFICATIONS.....	27
4 - 5 FM operation.....	11	13 OPTIONS.....	28
4 - 6 SSB operation.....	13	SCHEMATIC DIAGRAM.....	SEPARATE
4 - 7 CW operation.....	14		
4 - 8 ATV operation.....	15		
5 FUNCTIONS OPERATION.....	16 ~ 17		
5 - 1 RIT operation.....	16		
5 - 2 Noise blanker operation.....	16		
5 - 3 AGC operation.....	16		
5 - 4 Speech compressor operation.....	16		
5 - 5 Split operation.....	16		
5 - 6 Data communication.....	17		
5 - 7 SWR reading.....	17		

1-1 Front panel

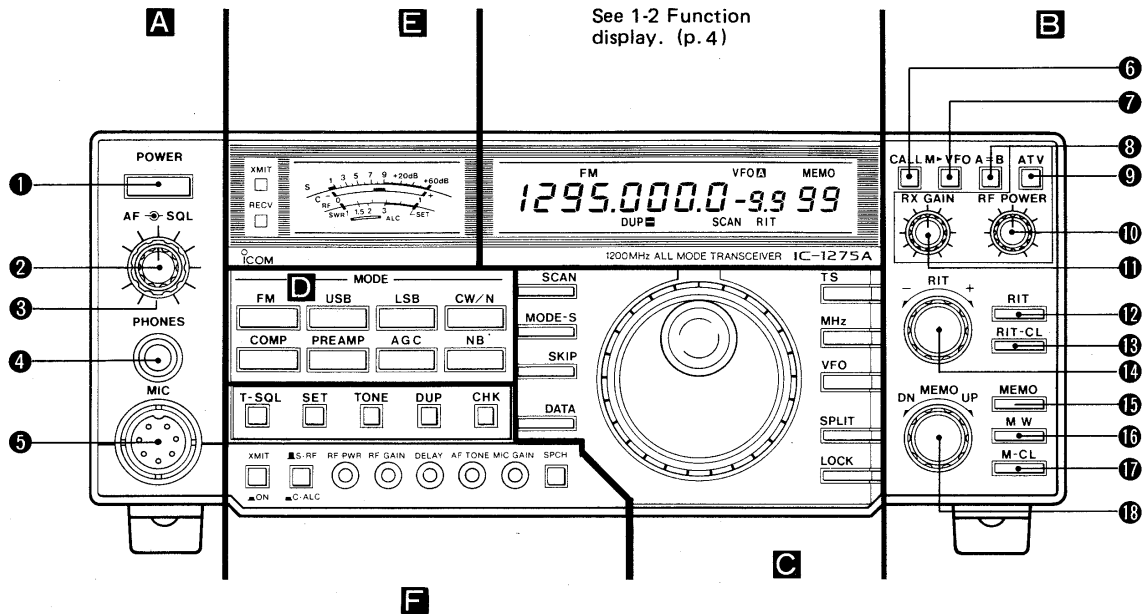
(1) Part **A** and **B**

- 1 POWER SWITCH [POWER]**
Turns the power ON and OFF.
- 2 AF GAIN CONTROL [AF]**
Adjusts audio output level.
- 3 SQUELCH CONTROL [SQL]**
Adjusts the squelch threshold level.
- 4 HEADPHONES JACK [PHONES]**
Accepts a standard 1/4 inch plug from 4 ~ 16 Ω monaural or stereo headphones.
- 5 MIC CONNECTOR [MIC]**
Accepts the supplied hand microphone or an Icom desktop microphone.
- 6 CALL CHANNEL SWITCH [CALL]** (p. 19)
Selects the call channel.
- 7 FREQUENCY TRANSFER SWITCH [M \blacktriangleright VFO]** (p. 18)
Transfers the contents of a memory channel into a VFO.
- 8 VFO EQUALIZING SWITCH [A=B]** (p. 10)
Equalizes the frequency and mode of the two VFOs.
- 9 ATV SWITCH [ATV]** (p. 15)
Turns the power of the optional TV-1275 ATV ADAPTER ON and OFF.
- 10 ATV RF POWER CONTROL [RF POWER]** (p. 15)
Adjusts RF output power during ATV operation.
- 11 ATV RX GAIN CONTROL [RX GAIN]** (p. 15)
Adjusts RF gain during ATV operation.
- 12 RIT SWITCH [RIT]** (p. 16)
Activates the RIT function.
- 13 RIT CLEAR SWITCH [RIT-CL]** (p. 16)
Clears the shift frequency of the RIT function.
- 14 RIT CONTROL [- RIT +]** (p. 16)
Shifts the receive frequency by up to ± 9.98 kHz when the RIT function is activated.
- 15 MEMORY READ SWITCH [MEMO]** (p. 18)
Selects MEMORY mode.
- 16 MEMORY WRITE SWITCH [M-W]** (p. 18)
Stores the displayed frequency and mode into the displayed memory channel.
- 17 MEMORY CLEAR SWITCH [M-CL]** (p. 19)
Clears displayed memory channel contents.
- 18 MEMORY CHANNEL SELECTOR [DN MEMO UP]** (p. 18)
Selects memory channels.

(2) Part C

(3) Part D

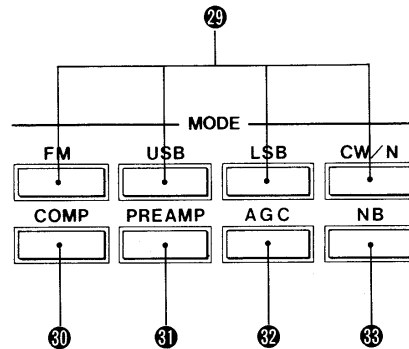
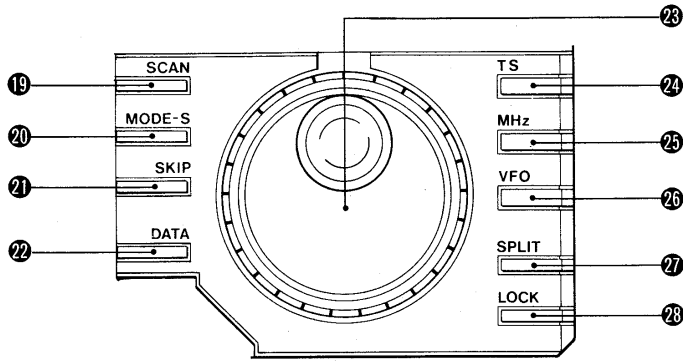

19 SCAN START/STOP SWITCH [SCAN] (pgs. 20, 21)
Starts and stops the scan function.

20 SELECTED MODE MEMORY SCAN SWITCH [MODE-S] (p. 21)
Selects the selected mode memory scan function.

21 SKIP SWITCH [SKIP] (p. 21)
Sets or cancels a skip channel for the memory scan.

22 DATA SWITCH [DATA] (p. 17)
Cuts OFF microphone input and ensures quick transmit and receive switching for data communications such as packet or AMTOR.

23 TUNING CONTROL
Changes the operating frequency.

24 TUNING STEP SELECTOR SWITCH [TS] (p. 10)
Sets the tuning step increment for 1 kHz.

POSITION	FM		SSB, CW
	U.S.A. version	Other versions	
OUT	10 kHz	25 kHz	20 Hz
IN	1 kHz	1 kHz	1 kHz

29 MODE SELECTOR SWITCHES [FM], [USB], [LSB], [CW/N]
Select the desired operating mode.

30 SPEECH COMPRESSOR SWITCH [COMP] (p. 16)
Activates the built-in speech compressor.

31 PREAMPLIFIER SWITCH [PREAMP]
Turns ON and OFF the optional AG-1200 WEATHER-PROOF 1200 MHz PREAMPLIFIER.
This switch does not operate when the full break-in function is used or [DATA] is ON.

32 AUTOMATIC GAIN CONTROL SWITCH [AGC] (p. 16)
Selects the time constant of the AGC circuit.

33 NOISE BLANKER SWITCH [NB] (p. 16)
Activates the noise blanker function.

(4) Part E

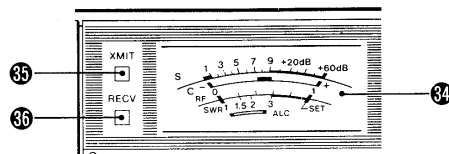

34 METER (pgs. 11, 13)
Functions as an S-meter or center meter during receiving, and as an RF meter, ALC meter or SWR meter during transmitting.

35 TRANSMIT INDICATOR [XMIT]
Lights up while transmitting.

36 RECEIVE INDICATOR [RECV]
Lights up while the squelch is open.

25 MHz TUNING STEP SWITCH [MHz] (p. 10)
Selects a 1 MHz tuning step increment.

26 VFO SWITCH [VFO] (p. 10)
Selects VFO A or VFO B.

27 SPLIT SWITCH [SPLIT] (p. 16)
Selects split operation.

28 TUNING CONTROL LOCK SWITCH [LOCK]
Deactivates the tuning control electronically.

1 CONTROL FUNCTIONS

(5) Part F

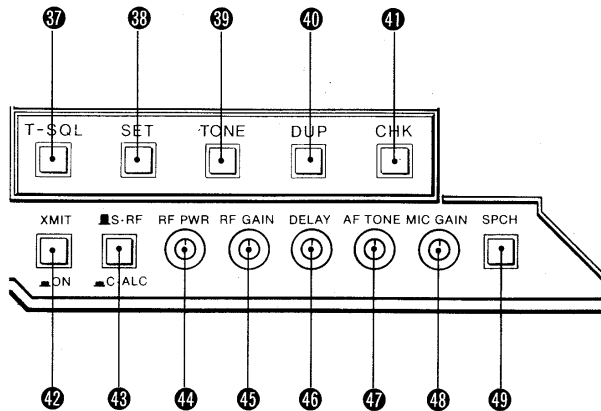

- 37 TONE SQUELCH SWITCH [T-SQL]**
Activates the optional UT-34 TONE SQUELCH UNIT.
- 38 TONE/OFFSET SET SWITCH [SET]** (p. 12)
Selects the subaudible tone frequency and offset frequency programming condition.
- 39 TONE SWITCH [TONE]** (p. 12)
- IC-1275A:
Activates the built-in subaudible tone encoder circuit.
- IC-1275E:
Transmits a 1750 Hz tone while pushed.
- 40 DUPLEX SWITCH [DUP]** (p. 12)
Selects semi-duplex or simplex operation.
- 41 DUPLEX CHECK SWITCH [CHK]** (p. 12)
Monitors the transmit frequency during repeater operation.
- 42 TRANSMIT/RECEIVE SWITCH [XMIT]**
Selects transmit or receive.

- 43 METER SWITCH [S-RF/C-ALC]** (pgs. 11, 13)
Selects the meter functions as follows:

SWITCH POSITION	RECEIVING	TRANSMITTING
S-RF (OUT)	Signal strength	Relative RF output power
C-ALC (IN)	FM : Frequency center SSB, CW : Signal strength	ALC level

- 44 RF POWER CONTROL [RF PWR]** (p. 11)
Adjusts RF output power.
 - 45 RF GAIN CONTROL [RF GAIN]**
In SSB and CW modes: Adjusts the RF gain.
In FM mode : Varies RF attenuator attenuation 0 ~ 40 dB.
- NOTE:** The transceiver receives only signals which are stronger than the level shown on the S-meter in SSB or CW mode.
- 46 CW DELAY CONTROL [DELAY]** (p. 14)
Adjusts the transmit to receive switching time during CW semi break-in operation.
 - 47 AF TONE CONTROL [AF TONE]**
Adjusts the receive audio response.
 - 48 MIC GAIN CONTROL [MIC GAIN]** (p. 11)
Adjusts microphone input gain.
 - 49 SPEECH SWITCH [SPCH]**
Activates the optional UT-36 VOICE SYNTHESIZER UNIT for announcing the displayed frequency.

1-2 Function display

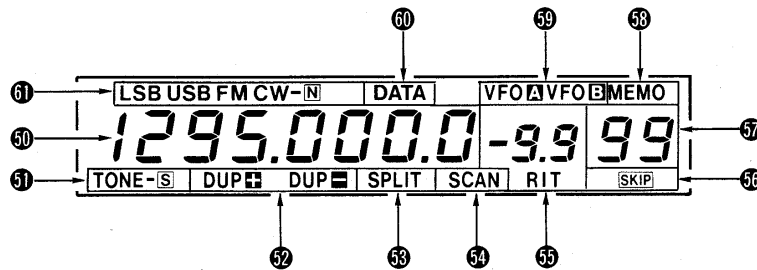

- 50 FREQUENCY READOUT**
Displays the operating frequency.
- 51 TONE SQUELCH INDICATOR** (p. 12)
- IC-1275A:
"TONE" appears when the subaudible tone encoder is activated.
- IC-1275E:
"TONE" appears when the 1750 Hz tone is transmitted.
- With an optional UT-34 TONE SQUELCH UNIT:
"TONE-S" appears when the tone squelch function is activated.
- 52 DUPLEX INDICATORS** (p. 12)
Either "DUP+" or "DUP-" appears during duplex operation.
- 53 SPLIT INDICATOR** (p. 16)
Appears during split operation.
- 54 SCAN INDICATOR** (p. 20)
Appears during scanning.
- 55 RIT/SHIFT FREQUENCY INDICATORS** (p. 16)
Appear when the RIT function is activated.
- 56 SKIP CHANNEL INDICATOR** (p. 21)
Appears when the displayed memory channel is programmed for a skip channel.
- 57 MEMORY CHANNEL INDICATOR**
Indicates memory channel numbers.
- 58 MEMORY MODE INDICATOR** (p. 18)
Appears when MEMORY mode is selected.
- 59 VFO INDICATORS**
Indicate which VFO is selected.
- 60 DATA INDICATOR** (p. 17)
Appears when [DATA] is pushed.
- 61 MODE INDICATORS**
Indicate the operating mode.

1-3 Microphone

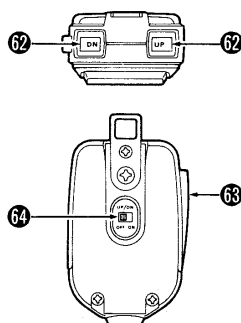

- 62 UP/DOWN SWITCHES [UP], [DN]**
Change the operating frequency or memory channel. Push and hold either of these switches to change the frequency or memory channel continuously.
- 63 PTT SWITCH**
Push to transmit.
- 64 UP/DOWN ON/OFF SWITCH**
Prevents accidental changes of [UP] and [DN].

1 CONTROL FUNCTIONS

1-4 Rear panel

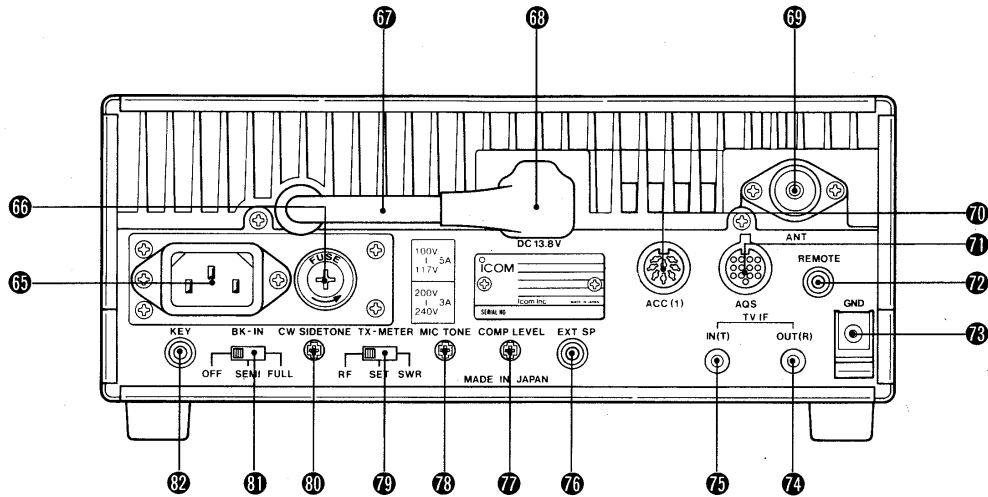

- 65 AC POWER SOCKET** (p. 8)
Connects the supplied AC power cable to an AC outlet.
- 66 FUSE HOLDER [FUSE]** (p. 22)
Holds either of the following fuses for the internal AC power supply (p. 22):
- IC-1275A : 5 A
- IC-1275E : 3 A
- 67 DC OUTPUT CABLE**
Connects 13.8 V DC from the internal DC power source to the DC power socket.
- 68 DC POWER SOCKET [DC 13.8 V]** (p. 8)
Accepts 13.8 V DC from the DC output cable, or an external DC power supply.
- 69 ANTENNA CONNECTOR [ANT]** (p. 6)
Connects a 50 Ω antenna with a Type-N connector.
- 70 ACC(1) SOCKET [ACC(1)]** (p. 9)
Input and output connections for external equipment.
- 71 AQS SOCKET [AQS]** (p. 9)
Input and output connections for external equipment.
- 72 CI-V REMOTE CONTROL JACK [REMOTE]** (p. 9)
Designed for use with a personal computer for remote operation of transceive functions.
- 73 GROUND TERMINAL [GND]** (p. 6)
To prevent electrical shocks and other problems, connect this terminal to ground.
- 74 TV IF OUTPUT(R) JACK [TV IF OUT(R)]** (p. 7)
Outputs an ATV IF signal to the optional TV-1275 ATV ADAPTER.

- 75 TV IF INPUT(T) JACK [TV IF IN(T)]** (p. 7)
Accepts an ATV IF signal from the optional TV-1275 ATV ADAPTER.
- 76 EXTERNAL SPEAKER JACK [EXT SP]** (p. 7)
Connect a 4 ~ 16 Ω speaker here, if required.
- 77 SPEECH COMPRESSOR LEVEL CONTROL [COMP LEVEL]** (p. 16)
Adjusts the compression level of the built-in speech compressor.
- 78 MIC TONE CONTROL [MIC TONE]**
Adjusts transmit audio response.
- 79 TX-METER SWITCH [TX-METER]** (p. 17)
Selects the measurement function during transmission.

SWITCH POSITION	MEASUREMENT
RF	Relative output power
SET	Meter setting for SWR measurement
SWR	SWR measurement

- 80 CW SIDETONE LEVEL CONTROL [CW SIDETONE]** (p. 14)
Adjusts the audio level of the CW sidetone.
- 81 CW BREAK-IN SWITCH [BK-IN]** (p. 14)
Selects CW break-in operation.

SWITCH POSITION	OPERATION
OFF	Non break-in operation
SEMI	Semi break-in operation
FULL	Full break-in operation

- 82 KEY JACK [KEY]** (p. 7)
Connects a CW key using the supplied key plug.

2-1 Unpacking

After unpacking, immediately describe any damage to the delivering carrier or Icom Dealer. Keep the shipping cartons. For a description and a diagram of accessory equipment included with the IC-1275A/E, see UNPACKING on the inside front cover.

2-2 Transceiver location

Select a location for the transceiver that allows good ventilation and access to the front and rear panels. Keep away from extreme heat, cold, vibrations, TV sets, radios and electro-magnetic sources.

2-3 Antenna

Select a well-matched, high-gain 1200 MHz band 50 Ω antenna. Install the antenna as high as possible. With a coaxial cable, the strength of 1200 MHz band signals diminishes. Be sure to use a coaxial cable as short and large in diameter as possible. VSWR should be less than 1.5:1.

Icom offers an optional AG-1200 WEATHERPROOF 1200 MHz PREAMPLIFIER to compensate for coaxial cable loss. (p. 28)

CAUTION: Protect your transceiver from lightning by using a lightning arrestor.

2-4 Grounding

To prevent electrical shocks and other problems, ground the transceiver through [GND] on the rear panel. (p. 7)

For the best results, connect a heavy gauge wire or strap to a long earth-sunk copper rod. Make the distance between [GND] and the ground as short as possible.

2-5 Mobile installation

An optional IC-MB5 MOBILE MOUNTING BRACKET is available for mobile installation of your IC-1275A/E. Select a location which can support the weight of the transceiver, and which does not interfere with the normal operation of the vehicle.

The optional OPC-025C DC POWER CABLE must be purchased separately for mobile operation.

For mobile installation, insert a rubber grommet to the DC power cable to prevent shorting.

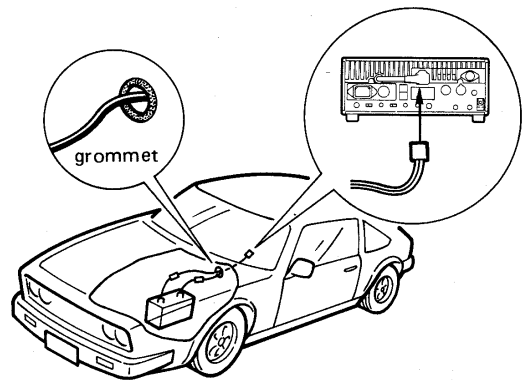

•Type-N connector installation

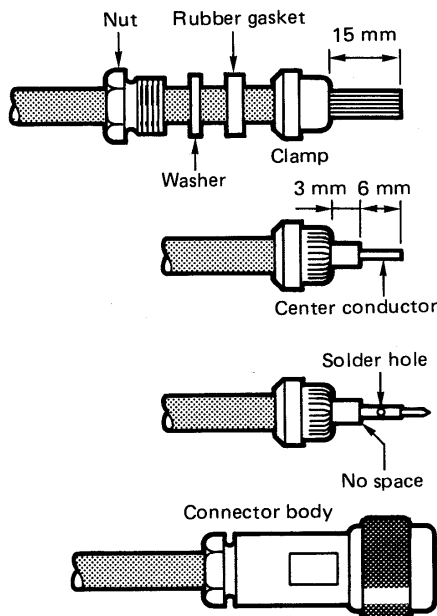

- 1) Slide the nut, washer, and rubber gasket over the coaxial cable and cut the end of the cable evenly.
- 2) Cut and remove 15 mm of the outer vinyl jacket, and fold the braid back over the clamp. The clamp end should be flush with the end of the vinyl jacket. Evenly trim the braid ends.
- 3) Cut and remove 6 mm of the shield conductor of the center conductor insulation.
- 4) Soft-solder the center conductor. Install a center conductor pin and solder it.
- 5) Carefully slide the connector into place, aligning the center conductor pin on the cable with the hole in the insulator inside the connector body.
- 6) Complete the assembly by screwing the nut into the connector body.

10 mm \approx 3/8

3

INTERCONNECTIONS

3-1 Rear panel connections

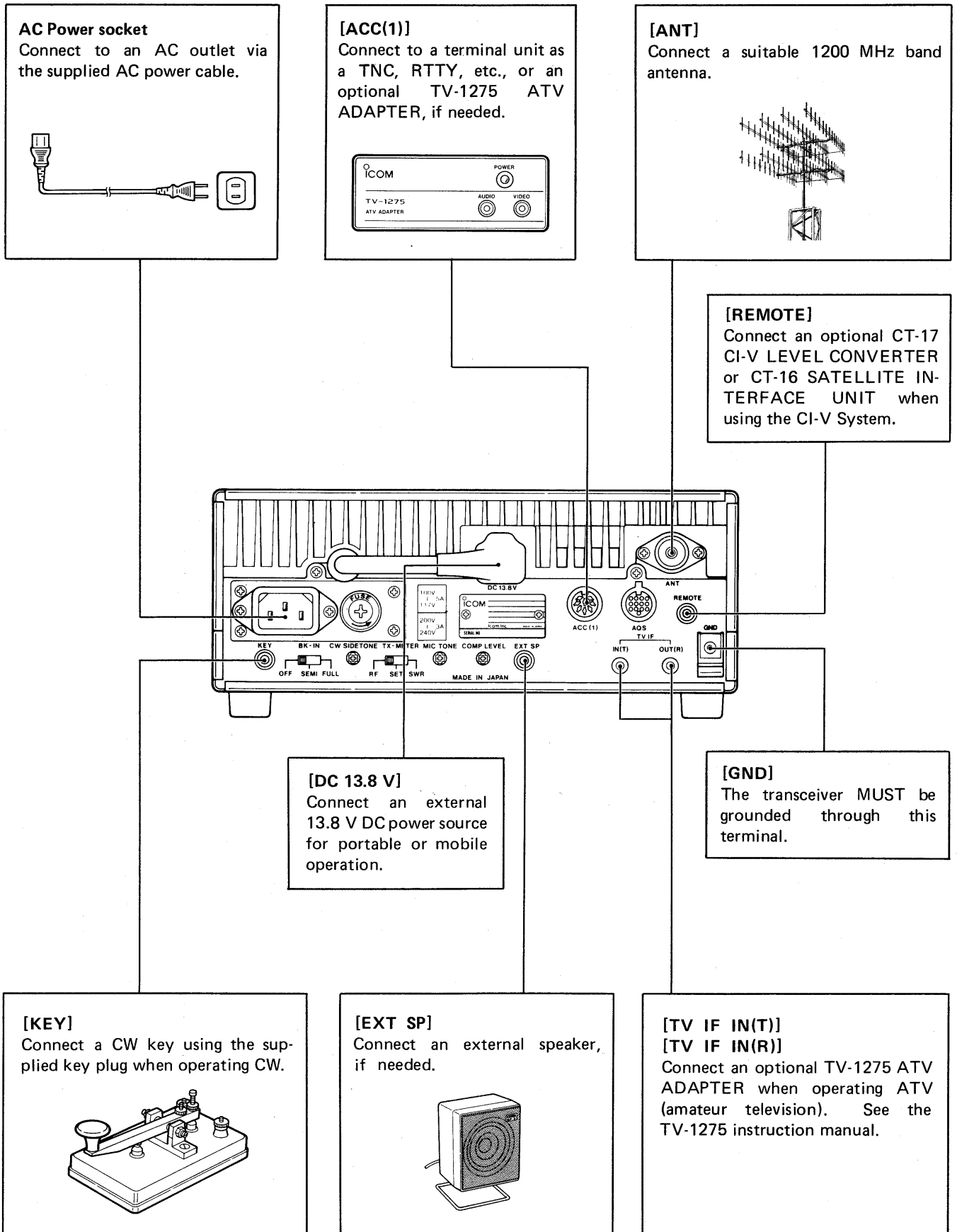

3-2 Power supply

(1) AC power operation

WARNING: Before connecting a non-I-com AC power cable to the socket, be sure to connect the AC power plug into the AC power socket with the LIVE and NEUTRAL sides of the plug in their proper positions.

Connect to an AC outlet via the supplied AC power cable.

(2) DC power operation

To provide power to the IC-1275A/E from a DC power source, use an optional OPC-025C DC POWER CABLE for portable or mobile operation. Be sure the output voltage of the DC power source is 12 ~ 15 V and current capacity is at least 6.5 A.

Use either an AC or DC power source.

When operating with an external DC power supply, make the shortest possible direct connection to the battery.

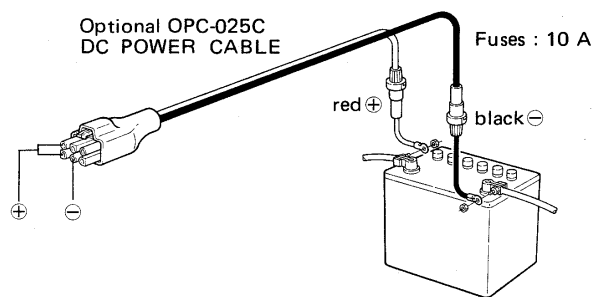
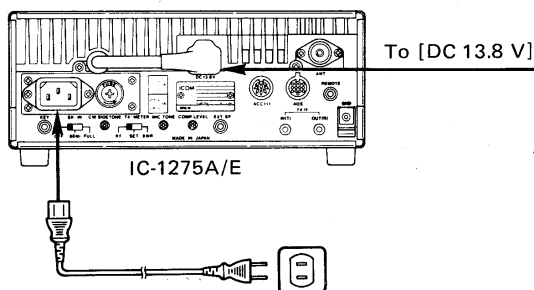

For safety purposes, remember to install fuses in the DC cable when connecting the IC-1275A/E to a vehicle battery. Locate the fuses as close to the vehicle battery as possible.

3-3 Mic connector information

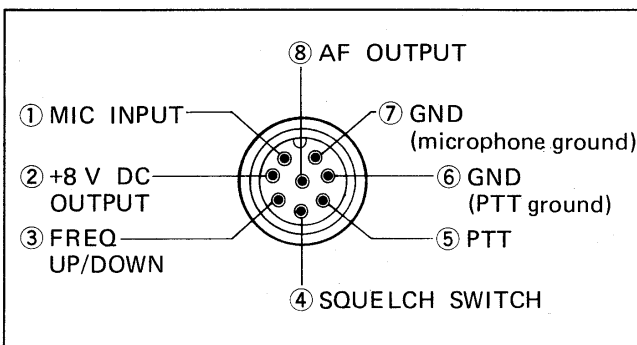

PIN NO.	FUNCTION	DESCRIPTION
②	+8V DC OUTPUT	Max. 10 mA
③	FREQ UP	Ground
	FREQ DOWN	Ground through 470 Ω
④	SQL OPEN	"LOW" level
	SQL CLOSED	"HIGH" level

CAUTION: DO NOT short pin 2 to ground as this can damage the internal 8 V regulator.

3 INTERCONNECTIONS

3-4 ACC(1) socket information

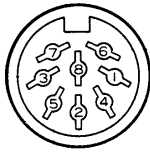

PIN NO.	PIN NAME	DESCRIPTION
①	NC	No connection.
②	GND	Ground.
③	SEND	The transceiver switches to transmit mode when this terminal is grounded. It is grounded when [XMIT] is placed in the IN position.
④	MOD	Connected in the modulator stage. The modulator amplification level can be changed by using the switch S1. See p. 25 for the location of this switch.
⑤	AF	Output from the receive detector stage. The output level can be changed by using the switch S2 on the MAIN UNIT. See p. 25 for the location of this switch.
⑥	SQLS	Squelch output. Goes to ground when squelch opens.
⑦	13.8 V	13.8 V DC output is switched by [POWER] on the front panel. Maximum current capacity is 1 A.
⑧	ALC	Input for external ALC voltage.

3-5 AQS socket information

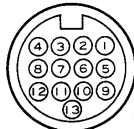

PIN NO.	PIN NAME	DESCRIPTION
①	TX E	Modulator ground.
②	TX MOD	Modulator input.
③	MUTE	MUTE line for audio output and microphone input. The terminal is "LOW" while muting.
④	CAC	Valid signal output for CAC (Channel Access) function. The terminal is "HIGH" when the CAC function is activated.
⑤	RX AF	Output from the receive detector stage.
⑥	PTT	Connected to the PTT circuit. The terminal is "LOW" when transmitting.
⑦	SEND	This is an input terminal that the transceiver switches to in transmit mode when the terminal is "LOW."
⑧	SEARCH	When searching an empty channel, the terminal is "LOW."
⑨	E	Demodulator ground.
⑩	CI-V	This is the CPU I/O terminal for setting the frequency and mode.
⑪	NC	No connection.
⑫	RECV	When receiving a signal, this terminal is "LOW."
⑬	13.8 V	This terminal outputs 13.8 V DC to an AQS adapter.

3-6 CI-V remote control jack information

The IC-1275A/E can be connected through an optional CT-17 CI-V LEVEL CONVERTER to a personal computer equipped with an RS-232C port. An Icom Communication Interface-V (CI-V) System controls frequency, mode, memory channel information, etc.

(1) CT-17 connection

Up to 4 Icom CI-V transceivers can be connected to a personal computer via the CT-17.

(2) CI-V condition (Switches S3 on the LOGIC UNIT)

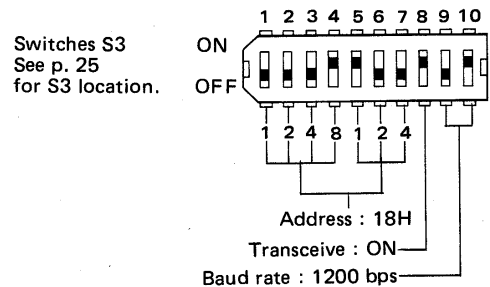

SWITCHES	DESCRIPTION	DEFAULT
S3-1 ~ 7	Transceiver address.	18H (24)
S3-8	Transceive function.	ON
S3-9 ~ 10	CI-V baud rate. See the table below.	1200 bps

BAUD RATE	S3-9	S3-10
9600	OFF	OFF
4800	ON	OFF
1200	OFF	ON
300	ON	ON

NOTE: The Icom standard CI-V baud rate is 1200 bps.

(3) CT-16 connection

The optional CT-16 SATELLITE INTERFACE UNIT allows you easy tuning for satellite communications between the IC-475A/E/H, IC-471A/E/H, or IC-R9000 using the CI-V System.

The optional UX-14 CI-IV/CI-V CONVERTER is necessary when operating with the IC-471A/E/H.

When using the CT-16, set switches as follows:

Transceiver flag switch : OFF (S3-3)
Baud rate switch : 1200 bps (S3-9: OFF, S3-10: ON)

4-1 Initial settings

NOTE: Follow all instructions in 4-1 INITIAL SETTINGS before operating the transceiver.

Turn power OFF before connecting the AC power cable to the AC power socket on the rear panel.

Set switches and controls as shown in the table below.

SWITCH	POSITION	SWITCH/CONTROL	POSITION
[POWER]	OFF (OUT)	[XMIT]	RECEIVE (OUT)
[COMP]	OFF (OUT)	[S·RF/ C·ALC]	S·RF (OUT)
[PREAMP]	OFF (OUT)	[RF PWR]	Max. CCW
[AGC]	SLOW (OUT)	[RF GAIN]	Max. CW
[NB]	OFF (OUT)	[DELAY]	Center
[ATV]	OFF (OUT)	[AF TONE]	Center
[TS]	OFF (OUT)	[MIC GAIN]	Center
[MHz]	OFF (OUT)	[AF]	Max. CCW
[LOCK]	OFF (OUT)	[SQL]	Max. CCW

CW : clockwise
CCW : counterclockwise

4-2 Frequency settings

NOTE: Make sure [LOCK] is in the OUT position before rotating the tuning control.

- (1) Tuning control:
Rotate the tuning control to set the frequency.

MODES		TUNING STEPS
SSB, CW		20 Hz
FM	U.S.A. version	10 kHz
	Other versions	25 kHz

- (2) Tuning step selector switch [TS]:
When [TS] is pushed IN, the tuning control changes the operating frequency in 1 kHz steps in any operating mode.
- (3) MHz tuning step switch [MHz]:
When [MHz] is pushed IN, the tuning control changes the operating frequency in 1 MHz steps in any operating mode.

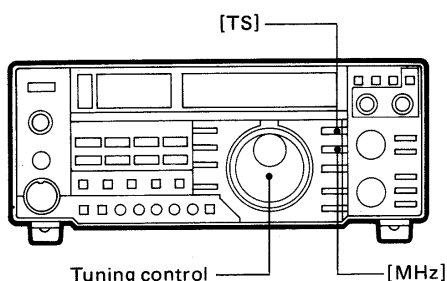

4-3 VFO A and B selection

The IC-1275A/E contains 2 VFOs. The VFOs are called VFO A and VFO B. This dual VFO system provides tremendous operating flexibility.

Pushing [VFO] each time selects VFO A or VFO B.

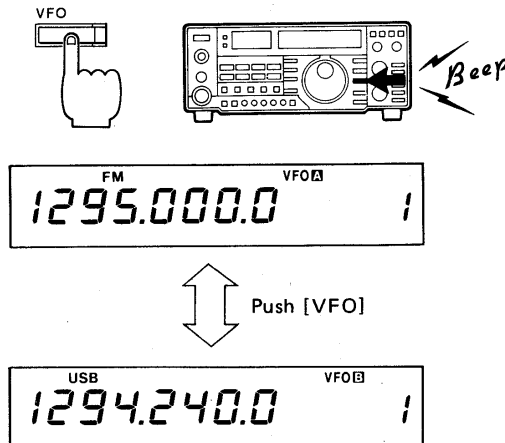

4-4 Frequency equalizing operation

This frequency instantly matches the frequency and mode of the 2 VFOs.

- 1) Push [VFO] to select VFO A or VFO B.
- 2) Push and hold [A=B] until the speaker emits 3 beep tones to make the undisplayed VFO contents the same as the displayed VFO.

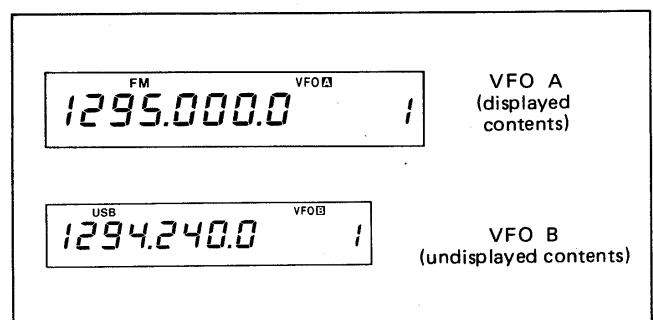

↓ Push [A=B]

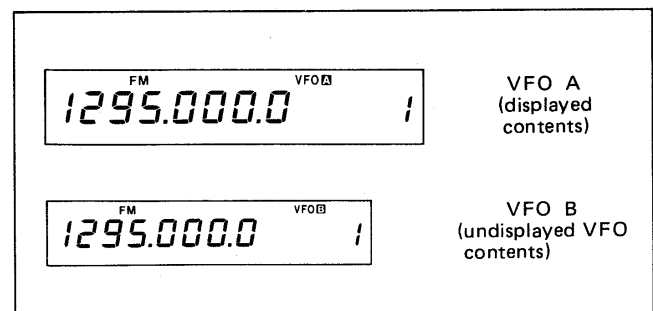

4 GENERAL OPERATION

4-5 FM operation

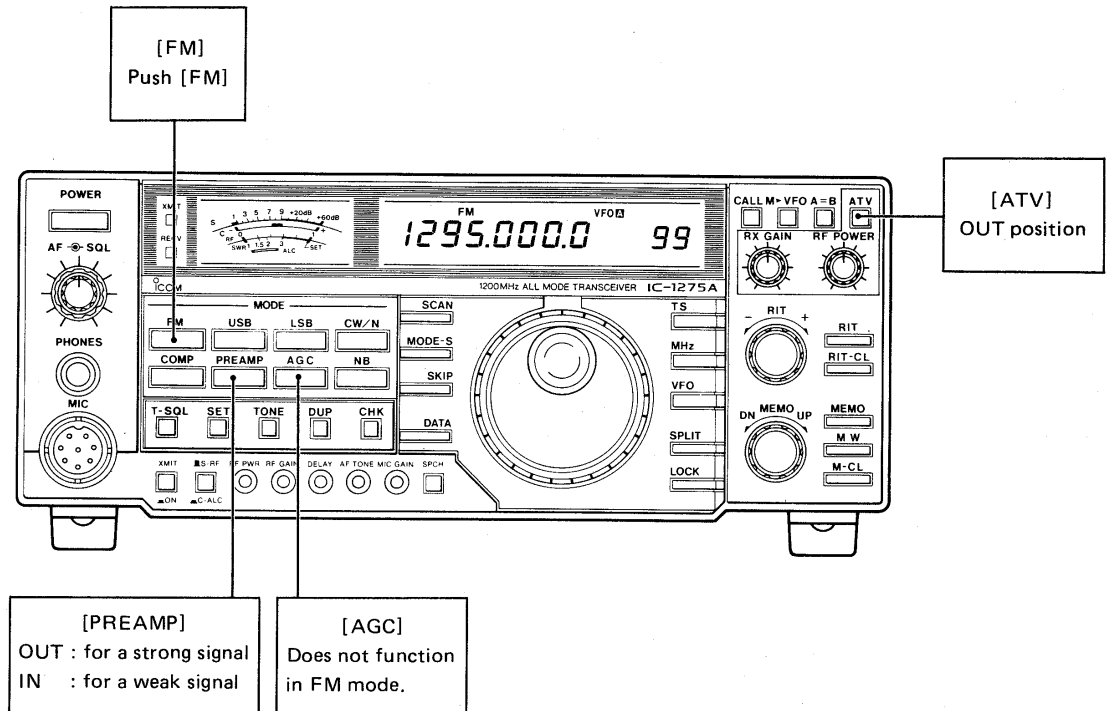

(1) FM receiving

- 1) Set controls and switches as described on p. 10.
- 2) Push [POWER] IN.
- 3) Push [FM].
- 4) Adjust [AF] as desired.
- 5) Rotate [SQL] until noise from the speaker is quieted.
- 6) Rotate the tuning control to set the operating frequency.
 - To select 1 kHz tuning steps, push [TS].
 - To select 1 MHz tuning steps, push [MHZ].
- 7) Adjust [RF GAIN] when required. [RF GAIN] functions as an attenuator in FM mode.
- 8) Select [S•RF/C•ALC] in either of the following positions.

S•RF : S-meter

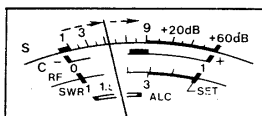

The meter shows signal strength.

C•ALC : Center meter

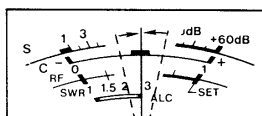

The meter shows signal deviation from the center.

(2) FM transmitting

- 1) Push the PTT switch on the microphone or push [XMIT] to the IN position to transmit.
- 2) Speak naturally into the microphone.
 - DO NOT hold the microphone too closely to your mouth or speak too loudly. This may distort the signal.
- 3) Adjust [RF PWR] for the desired output power.

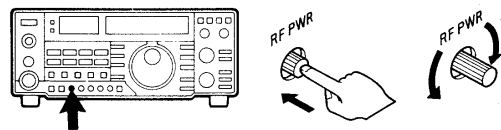

- 4) Adjust [MIC GAIN] when needed.

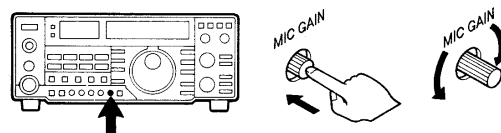

(3) Repeater operation

When operating with a station through a repeater, proceed with the following instructions.

- 1) See the following information.
 - Offset frequency. See item (4) at right.
 - Subaudible tone frequency. (IC-1275A only) See item (5) at right.
- 2) Rotate the tuning control to set the receive frequency (repeater output frequency).
- 3) Push [DUP] once to set -duplex or push again to set +duplex.
 - "DUP-" or "DUP+" appears.



- 4) When the repeater requires a subaudible or 1750 Hz tone, see below.
- 5) Push the PTT switch to access the repeater.
- 6) To check the transmit frequency (repeater input frequency), push [CHK].



■ Subaudible tone encoder (IC-1275A only)

Push [TONE] to turn ON the subaudible tone encoder.
• "TONE" appears.



■ 1750 Hz tone call function (IC-1275E only)

Push and hold [TONE] approx. 1 ~ 3 sec. to transmit a 1750 Hz tone.
• "TONE" appears while transmitting.



(4) Offset frequency setting

An offset frequency can be set according to a repeater.

- 1) Push [DUP] to set duplex mode.
 - "DUP-" or "DUP+" appears.



- 2) Push [SET].
 - "DUP+" or "DUP-" and an offset frequency appear.
 - When "TONE" appears, push [SET] again.



- 3) Rotate the tuning control to select the desired offset frequency.
 - To select 1 MHz tuning step increments, push [MHz].
- 4) Push [SET] again to return to the previous operating mode.

(5) Setting a subaudible tone frequency (IC-1275A only)

Select a subaudible tone frequency to access a repeater requiring a subaudible tone.

- 1) Push [TONE] to turn ON the subaudible tone encoder.
 - "TONE" appears.



- 2) Push [SET].

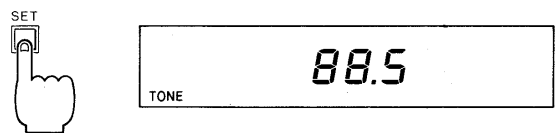

- 3) Rotate the tuning control to select the desired tone frequency.
- 4) Push [SET] to return to the previous operating mode.
 - When "DUP+" or "DUP-" and an offset frequency appear, push [SET] again.

4 GENERAL OPERATION

4-6 SSB operation

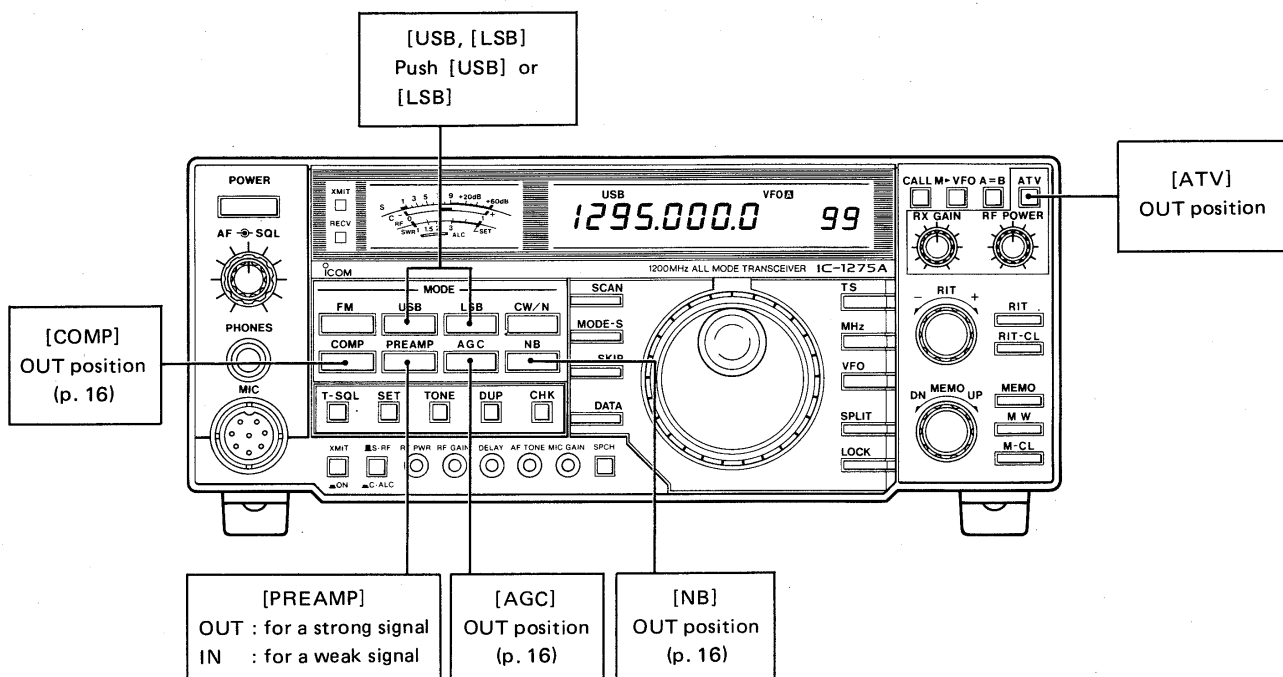

(1) SSB receiving

- 1) Set controls and switches as described on p. 10.
- 2) Push [POWER] IN.
- 3) Push [USB] or [LSB].
 - Normally USB is used for most SSB communications in the 1200 MHz band.
- 4) Adjust [AF] as desired.
- 5) Adjust [SQL] , if needed.

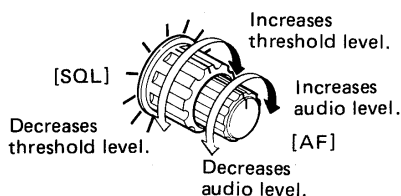

- 6) Rotate the tuning control to set the operating frequency.
 - To select 1 kHz tuning steps, push [TS].
 - To select 1 MHz tuning steps, push [MHZ].

(2) SSB transmitting

- 1) Push the PTT switch on the microphone or push [XMIT] to the IN position to transmit.
 - When you transmit a signal, the meter needle moves.
- 2) Speak naturally into the microphone.
- 3) Adjust [RF PWR] for the desired output power.

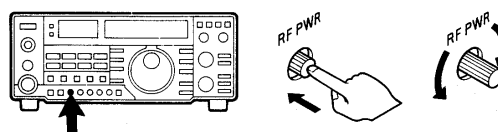

- 4) Set [S·RF/C·ALC] to IN "C·ALC" position.

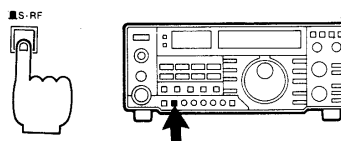

- 5) Adjust [MIC GAIN] for a meter reading within the ALC zone on voice peaks.

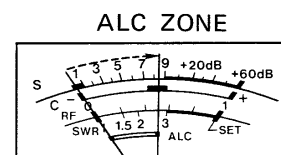

4-7 CW operation

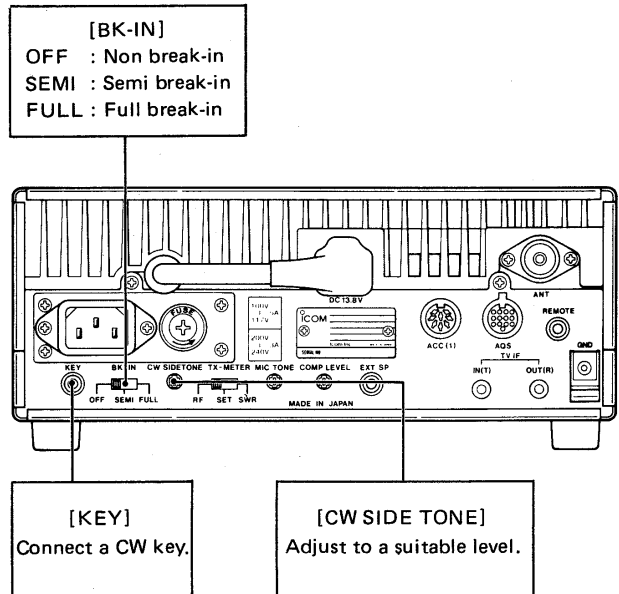
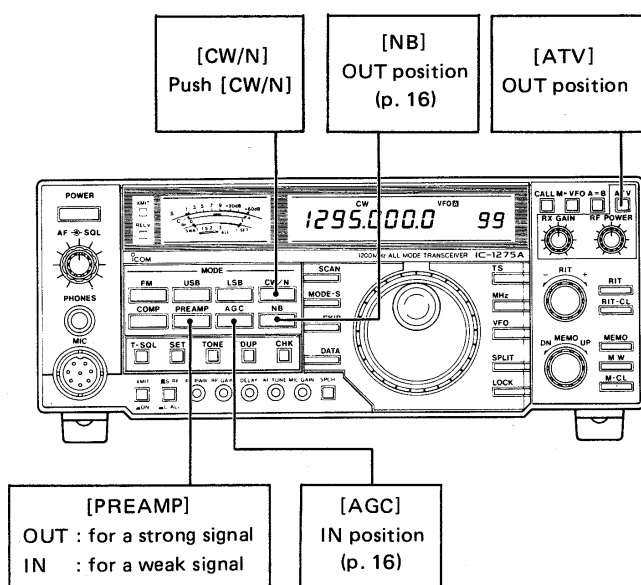

(1) CW receiving

- 1) Set controls and switches as described on p. 10.
- 2) Push [POWER] IN.
- 3) Push [CW/N].
 - When an optional FL-83 CW NARROW FILTER is installed, push [CW/N] again to select CW narrow mode.
- 4) Adjust [AF] as desired.
- 5) Adjust [SQL], if needed.
- 6) Rotate the tuning control to set the operating frequency.
 - To select 1 kHz tuning steps, push [TS].
 - To select 1 MHz tuning steps, push [MHz].

(2) CW transmitting

■ Non break-in operation

- 1) Set [BK-IN] on the rear panel in the "OFF" position.
- 2) Push IN [XMIT] to transmit.
- 3) Operate the CW key.
- 4) Adjust [RF PWR] to the desired output power level.
- 5) Push OUT [XMIT] to return to receive.

■ Break-in operation

- 1) Set [BK-IN] on the rear panel in the "SEMI" or "FULL" position.
 - "SEMI" : Semi break-in operation
 - "FULL" : Full break-in operation

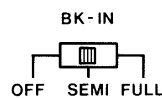

- 2) Operate the CW key.
 - Transmit/receive switching is automatic.
- 3) Adjust [DELAY] on the front panel.
 - Clockwise rotation increases the transmit release delay time.
 - When operating using full break-in, the delay time is fixed regardless of the [DELAY] position.
- 4) Adjust [RF PWR] to the desired output power.

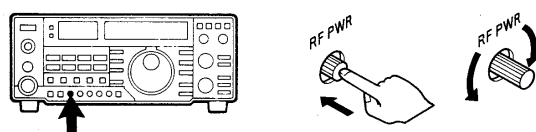

4 GENERAL OPERATION

4-8 ATV operation

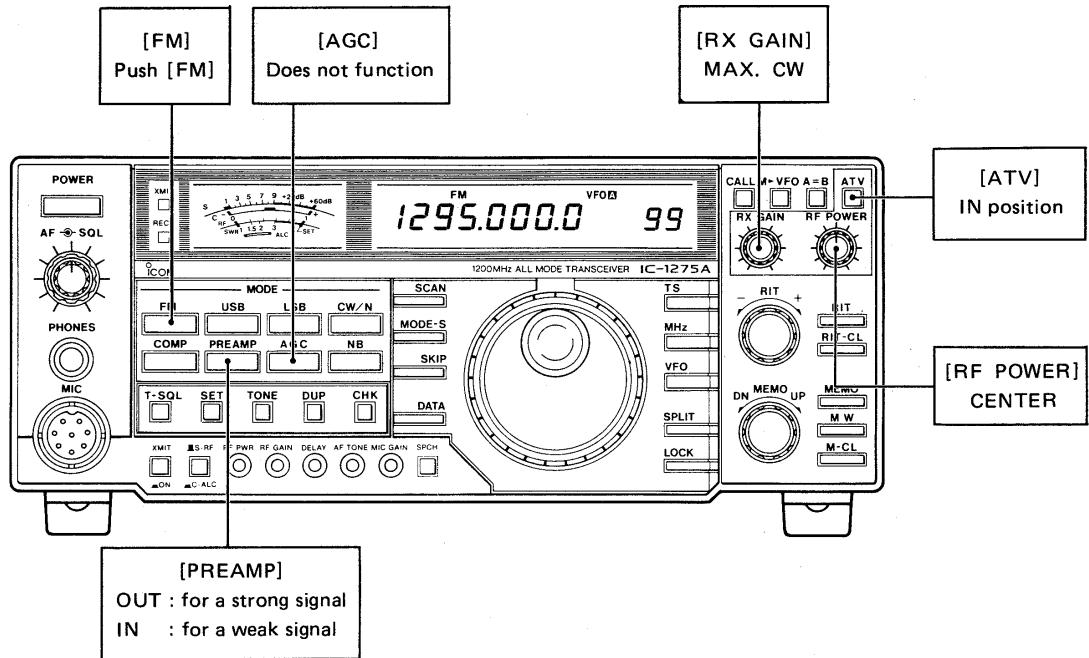

By connecting the optional TV-1275 ATV ADAPTER, you can easily join others who have discovered the fascinating world of ATV (amateur television). See the TV-1275 instruction manual for connections.

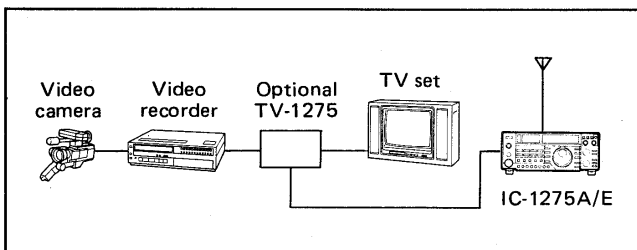

(1) ATV receiving

- 1) Connect an optional TV-1275 ATV ADAPTER, TV set, video recorder, etc. See the TV-1275 instruction manual for connection information.
- 2) Set controls and switches as above.
- 3) Push [POWER] IN.
- 4) Push [ATV] IN.
- 5) Push [FM].
- 6) Rotate the tuning control to set the operating frequency.
 - To select 1 kHz tuning steps, push [TS].
 - To select 1 MHz tuning steps, push [MHz].
- 7) When the received picture waves slowly, adjust [RX GAIN] to stabilize the picture.

- 8) Adjust the contrast, brightness and volume controls on the TV set.
- 9) When the video recorder is connected in your ATV system, the received signal can be recorded. (Except some video recorders.)

(2) ATV transmitting

- 1) Set the video camera and video recorder for proper operation.
- 2) Push [XMIT] IN to transmit.
 - The video camera microphone picks up voices or sound.
 - [MIC GAIN] does not function.
- 3) To transmit your voice with the IC-1275A/E microphone, push the PTT switch.
 - [MIC GAIN] functions.

NOTE: If you hear a whistling or howling sound, decrease the volume control of your TV set or use an earphone.

- 4) Adjust [RF POWER] to the desired output power.

5-1 RIT operation

RIT shifts only the receive frequency by up to ± 9.98 kHz in 20 Hz steps even when the function display changes in 100 Hz steps. This is useful for fine tuning and compensating for frequency drift of the transmitting station.

- 1) Push [RIT] to activate the RIT function.
 - "RIT" and the shift frequency appear.
- 2) To shift the receive frequency, rotate [- RIT +].

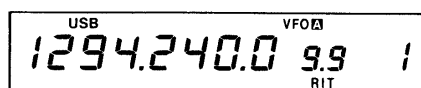

- 3) To turn OFF the RIT function, push [RIT] again.
 - "RIT" and the shift frequency disappear.
 - The last-displayed shift frequency is stored.
- 4) To clear the shift frequency, push [RIT-CL].
 - The shift frequency resets to "0.0."

5-2 Noise blanker operation

This operation effectively reduces unwanted pulse-type noise from outside sources such as ignition noise from vehicles.

Push [NB] to turn ON and OFF the function.

- The noise blanker may not work when strong signals are on nearby frequencies or when the noise is continuous rather than pulse-type.

5-3 AGC operation

The transceiver has a fast attack and slow release AGC system. The transceiver maintains peak voltage of a rectified IF signal from the IF amplifier circuit for a brief period of time.

This circuit prevents irritating background noise during short pauses in speech. The damping effect of the AGC therefore allows an accurate S-meter reading to be taken of peak IF signal strength.

Push [AGC] to select a time constant of the AGC circuit as below:

- AGC does not function in FM mode.

MODE	AGC SWITCH
SSB	SLOW (OUT)
CW SSB*	FAST (IN)

*with short interval fading

5-4 Speech compressor operation

The transceiver has a low distortion AF speech compressor circuit which provides greater talk power by improving the intelligibility of the transmitted signals over long distances.

- 1) Set the switches and controls as shown in the table below.

SWITCH/CONTROL	POSITION
[MIC GAIN]	Center (12 o'clock)
[RF POWER]	Max. CW
[COMP]	ON (IN)

CW : Clockwise

- 2) Push the PTT switch and speak into the microphone using your normal voice level.
- 3) Adjust the compressor gain by [COMP LEVEL] on the rear panel, if required.
 - Rotate the control clockwise to increase the gain.

5-5 Split operation

Split operation refers to transmitting and receiving on separate frequencies. Split operation is possible using the contents of VFO A and VFO B.

- 1) Push [VFO] to select VFO A and set a receive frequency.
- 2) Push [VFO] to select VFO B and set a transmit frequency.
- 3) Push [VFO] again to select VFO A.
- 4) Push [SPLIT] for split frequency operation.
 - "SPLIT" appears.

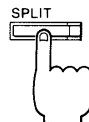

- 5) Push the PTT switch on the microphone.
 - VFO B frequency appears.

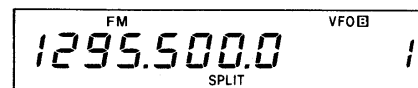

- 6) You are now receiving on VFO A frequency and transmitting on VFO B.
- 7) To receive on VFO B and transmit on VFO A, push [VFO] again.

5 FUNCTIONS OPERATION

5-6 Data communication

Packet and AMTOR operations require a rapid transmit and receive switching time since they are handshaking communications. When [DATA] is ON, transmit and receive switching time delay becomes faster by approx. 6 msec.

NOTE: When [DATA] is ON, voice signals from the microphone are muted except when the PTT switch is pushed. This function does not operate in CW mode.

- 1) Connect TNC, RTTY or another terminal unit as shown in the diagram below.
- 2) Set the switches and controls as described on p. 10.
- 3) Select the desired operating mode and push [DATA].
 - "DATA" appears.
- 4) To operate the IC-1275A/E for data communications, enter commands or data from your terminal unit.

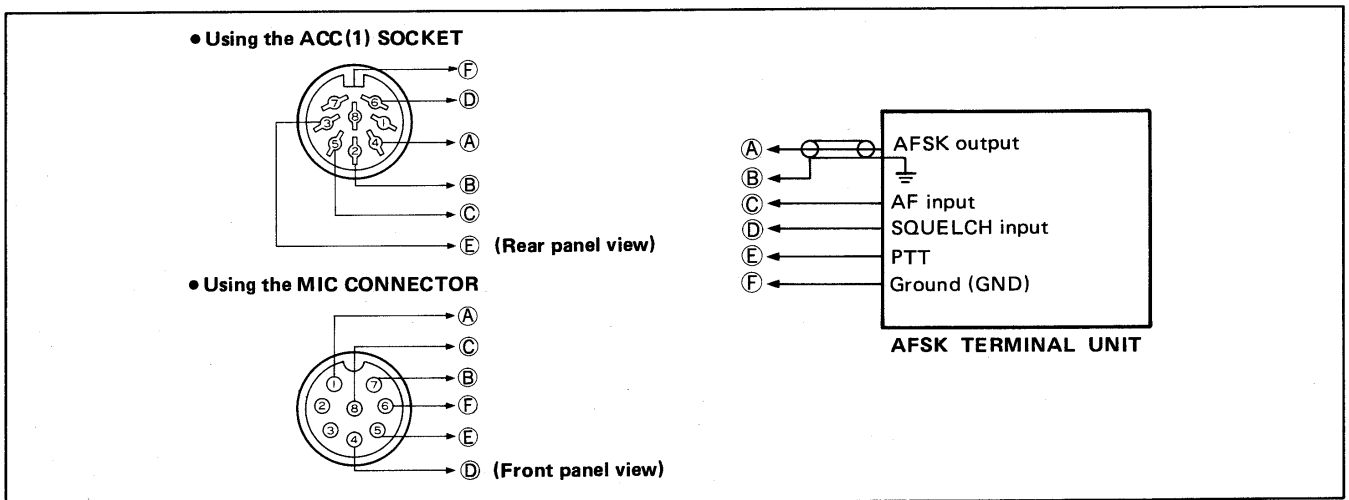

5-7 SWR reading

The transceiver has a built-in SWR meter to check the antenna matching condition, helping you avoid problems caused by high SWR.

- 1) Set the meter switch on the front panel to the "S·RF" position.
- 2) Set [TX-METER] on the rear panel to the "SET" position.
- 3) Push [FM] to select FM mode.
- 4) Rotate [MIC GAIN] fully counterclockwise.
- 5) Push [XMIT] to transmit.
- 6) Adjust [RF PWR] to move the meter needle to "SET" on the SWR scale.
- 7) Set [TX-METER] to the "SWR" position. Read the SWR from the SWR scale.
 - If the SWR is less than 1.5, the matching condition between the transceiver and your antenna is good.

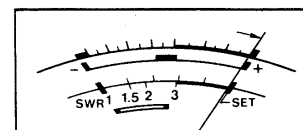
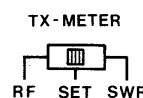
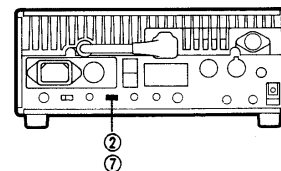
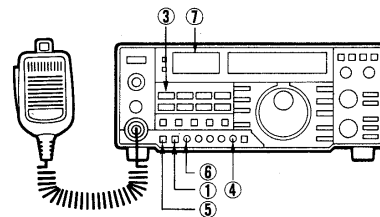

Adjust to "SET" position with [RF PWR].

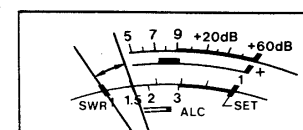
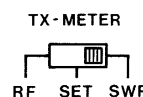

The SWR should be less than 1.5.

6-1 Memory channel selection

NOTE: When [MODE-S] is in the [IN] position, only memory channels with the same operating mode as displayed just prior to pushing [MODE-S] are selected.

- 1) Push [MEMO] to select MEMORY mode.
 - "MEMO" appears.



- 2) Rotate [DN MEMO UP] to select the desired memory channel.
 - When memory channels not yet programmed are selected, only decimal points appear.

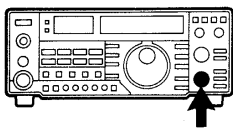

Rotate [DN MEMO UP]

- 3) Push [VFO] to return to VFO mode.

6-2 Memory programming

The operating frequency, mode, subaudible tone frequency or duplex condition can be memorized in any memory channel.

- 1) Select the desired operating frequency and mode.
 - Either VFO A or VFO B can be used.
- 2) Rotate [DN MEMO UP] to select the desired memory channel.
- 3) Push and hold [MW] until the speaker emits 3 beep tones.
 - The information is now programmed.

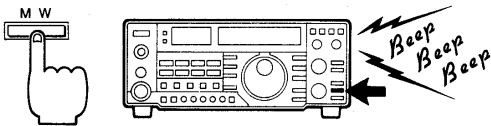

- 4) To check the memory channel contents, push [MEMO].
 - The contents of the selected memory channel are displayed.

6-3 Memory data transferring

- (1) In VFO mode:
The memory channel contents are transferred to the selected VFO.
- (2) In MEMORY mode:
The memory channel contents are transferred to the VFO used immediately before transferring to MEMORY mode.

NOTE: If the displayed memory channel has no information (blank status), this function will not be activated.

Push and hold [M▶VFO] until the speaker emits 3 beep tones.

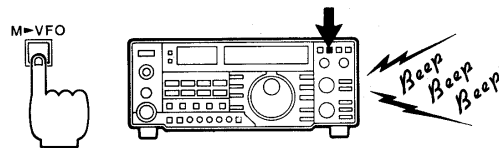

- In VFO mode

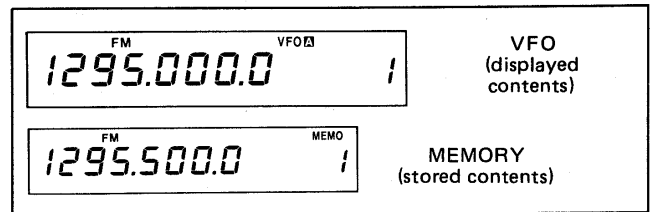

Push and hold [M▶VFO]

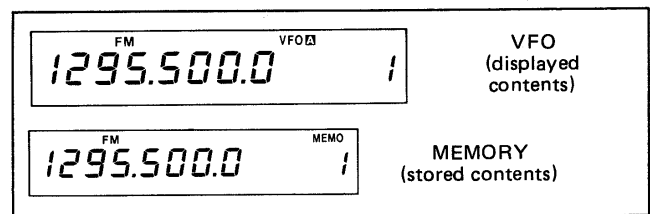

- In MEMORY mode.

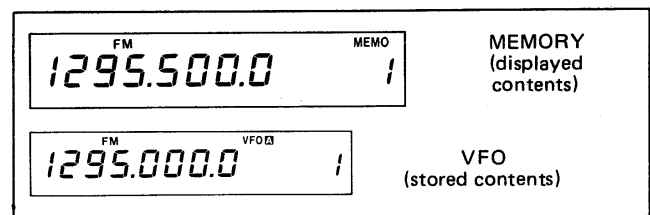

Push and hold [M▶VFO]

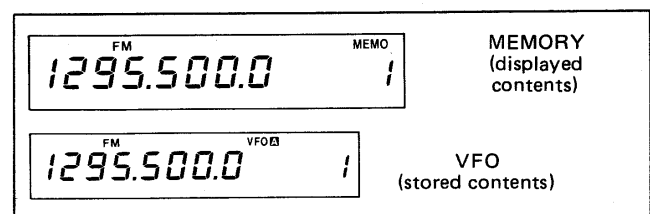

6 MEMORY OPERATION

6-4 Memory clearing

This function is used to clear the information in each memory channel.

- 1) Push [MEMO] to select MEMORY mode.

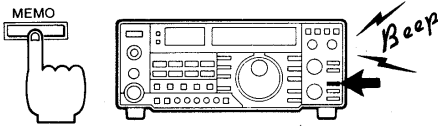

- 2) Rotate [DN MEMO UP] to select the memory channel to be cleared.

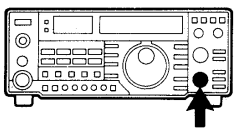

Rotate [MEMO]

- 3) Push and hold [M-CL] until the speaker emits 3 beep tones.

- The memory channel is now vacant.

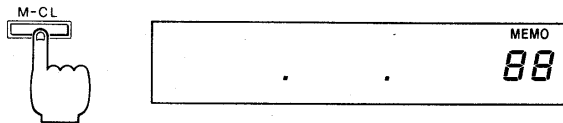

(2) Programming the call channel

- 1) Push and hold [CALL] until step 4.

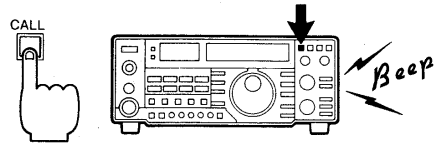

- 2) Set the desired information such as operating mode, subaudible tone frequency or duplex information, when required.

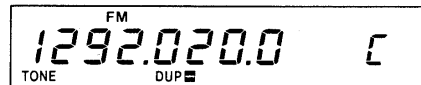

- 3) Rotate the tuning control to select the frequency as a call channel.

- 4) Release [CALL].

- 5) Push and hold [MW] until the speaker emits 3 beep tones.

- The selected frequency is programmed into the call channel.

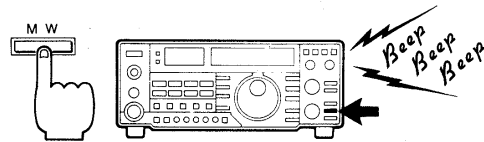

6-5 Call channel operation

The transceiver has an independent call channel to easily select your most-often-used frequency. A call channel can be selected from VFO and MEMORY modes.

(1) Recalling the call channel

- 1) Push [CALL] to recall a call channel.

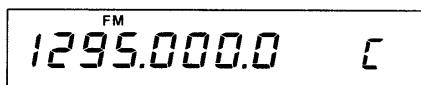
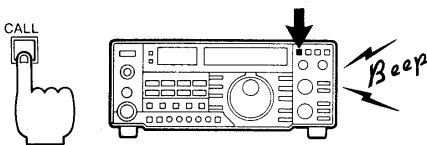

- 2) Push either [VFO] or [MEMO] to return to VFO or MEMORY mode.

7-1 Scan types

The transceiver comes equipped with 4 scan functions, providing tremendous scanning versatility at the touch of just a few switches.

SCAN NAMES	FUNCTION
Programmed scan	Repeatedly scans between 2 user-programmable scan edges (memory channels P1 and P2.)
Memory scan	Repeatedly scans all memory channels except blank or skip channels.
Selected mode scan	Repeatedly scans memory channels with the same selected operating mode.

NOTE: Before starting scanning operation, please read the following 3 points and preset the switches and controls as described on p. 10.

(1) Adjusting [SQL]

Adjust [SQL] to quiet the noise output from the speaker since the scan pauses when the squelch opens.

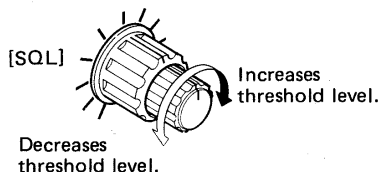

(2) Scan speed switch

Switches the scan speed in any scan mode. Slide the switch to the position for the desired speed. The switch is located on the LOGIC UNIT. See p. 25 for the scan speed switch (S1) location.

(3) Scan timer

When a signal is received, the scan pauses and then resumes after 3 or 10 sec. These times depend on the types of signal received.

RECEIVED SIGNAL	TIMER
A signal of short duration such as a pulse signal.	3 sec.
A signal of long duration such as a voice signal.	10 sec.

7-2 Programmed scan

NOTE: Programmed scan does not function when:

- P1 and P2 are programmed for the same frequencies.
- Either P1 or P2 is programmed with no frequency.
- Squelch opens.

Programmed scan repeatedly scans between 2 programmed frequencies.

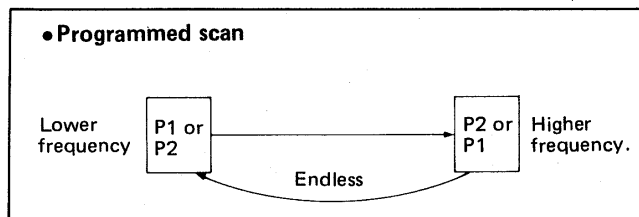

- 1) Store the frequencies of the higher and lower scan edges in memory channels P1 and P2. (p. 18)

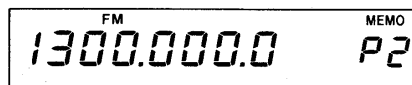
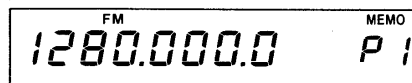

- 2) Push [VFO] to select VFO mode.
- 3) Select the desired operating mode.
- 4) Adjust [SQL] to the threshold point.
- 5) Push [SCAN] to start the scan.
 - "SCAN" appears.

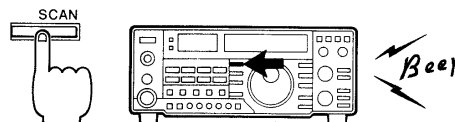

- 6) When receiving a signal, the scan pauses and resumes after a pre-selected time. See item (3) at left.
- 7) To cancel the scan, push [SCAN].
 - The tuning control and some other switches also cancel the scan.

7 SCAN OPERATION

7-3 Memory scan

This scan automatically scans all programmed memory channels except the channels with "skip" information.

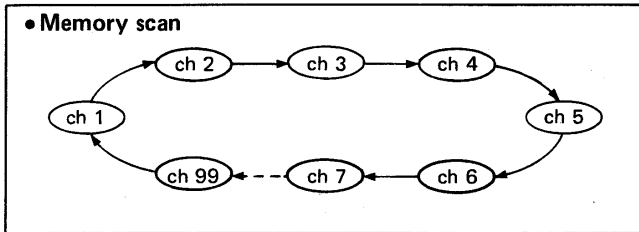

- 1) Push [MEMO] to select MEMORY mode.
- 2) Adjust [SQL] to the threshold point.
- 3) Push [SCAN] to start the scan.
 - "SCAN" appears.
 - Memory channels programmed as skip channels are skipped.

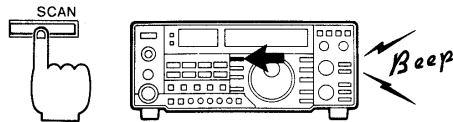

- 4) When receiving a signal, the scan pauses and resumes after a pre-selected time. (p. 20)
- 5) To cancel the scan, push [SCAN].
 - The tuning control and some other switches also cancel the scan.

7-4 Selected mode memory scan

This scan selectively monitors memory channels programmed with the same mode.

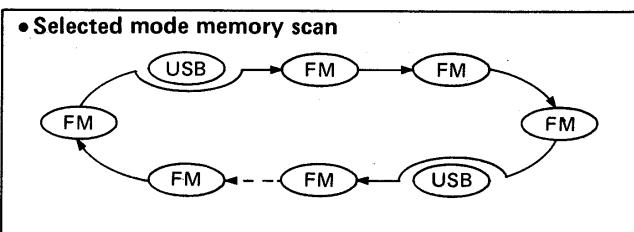

- 1) Push [MEMO] to select MEMORY mode.
- 2) Adjust [SQL] to the threshold point.
- 3) Select the desired operating mode.
- 4) Push [MODE-S] to set the selected mode memory scan.
- 5) Push [SCAN] to start the scan.
- 6) To cancel the scan, push [SCAN].
 - The tuning control and some other switches also cancel the scan.

7-5 Skip function

This function allows you to scan only the described memory channels.

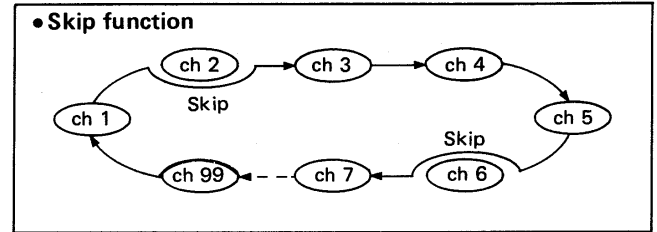

- 1) Push [MEMO] to select MEMORY mode.
- 2) Rotate [DN MEMO UP] to select the memory channel you wish to program as a skip channel.

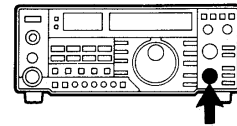

- 3) Push [SKIP] to program a selected memory channel as the skip or non-skip channel.
 - "SKIP" appears when the memory channel is programmed as a skip channel.

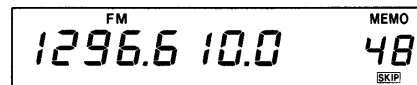
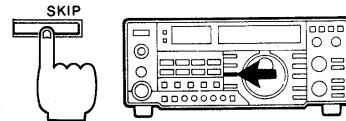

- 4) Repeat steps 2 and 3 to program another memory channel as a skip channel.

8-1 Fuse replacement

If the fuse blows or the transceiver stops functioning, track down the source of the problem if possible, and replace the damaged fuse with a new rated fuse.

- IC-1275A (U.S.A. version) : 5 A
- IC-1275E (Europe version) : 3 A

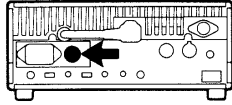

8-2 Backup battery

The IC-1275A/E has a lithium backup battery for retaining memory information.

The usual life of the backup battery is approx. 5 years. When the battery is exhausted, the transceiver transmits and receives normally but the transceiver cannot retain memory information.

NOTE: Battery replacement must be done by an authorized Icom Dealer or Service Center.

8-3 CPU resetting

The function display may occasionally display erroneous information, i.e., when first applying power. This may be caused externally by static electricity or other factors.

If this problem occurs, turn OFF power. Wait a few seconds, and then turn ON power again. If the problem continues, perform the following procedure.

NOTE: CPU resetting clears all memory information.

- 1) Turn OFF power.
- 2) Push and hold [M-CL].
- 3) Turn ON power.
- 4) Release [M-CL].
 - The IC-1275A/E is now reset.

8-4 Cleaning

When the transceiver becomes dusty or dirty, wipe it clean with a dry, soft cloth. **AVOID** the use of strong chemical agents such as benzine or alcohol as they may damage the surfaces.

8-5 Brake adjustment

The tension of the tuning control can be adjusted to suit your operating requirements.

- 1) Rotate the tuning control continuously and smoothly in one direction.
- 2) Turn the brake adjustment screw either clockwise for tighter tension, or counterclockwise for looser tension as desired.

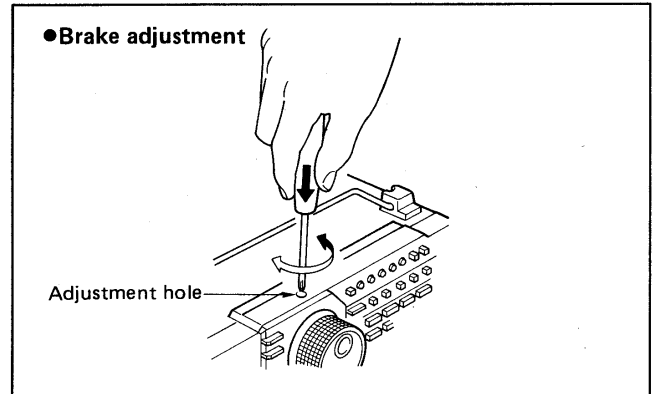

8-6 Display light dimmer adjustment

The light intensity of the frequency display can be varied to suit the ambient light conditions. Refer to the diagram below.

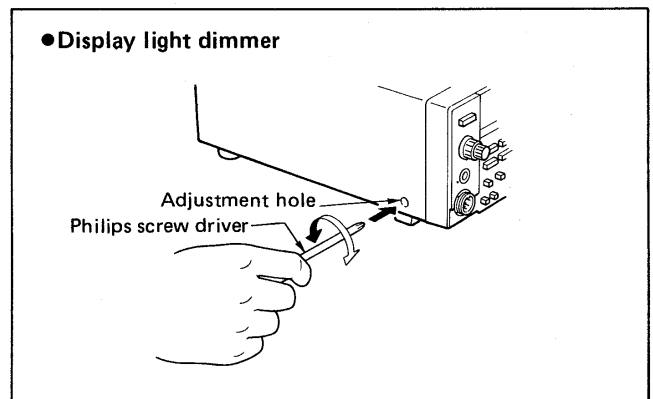

8-7 Beep sound level adjustment

The level of the beep sound emitted when the specified switches are pushed can be adjusted by R348 on the MAIN UNIT. (p. 25)

- Clockwise rotation of R348 increases the sound level.

9-1 Transceiver disassembly

1) To remove top and bottom covers, unscrew 17 screws. (Fig. 1)

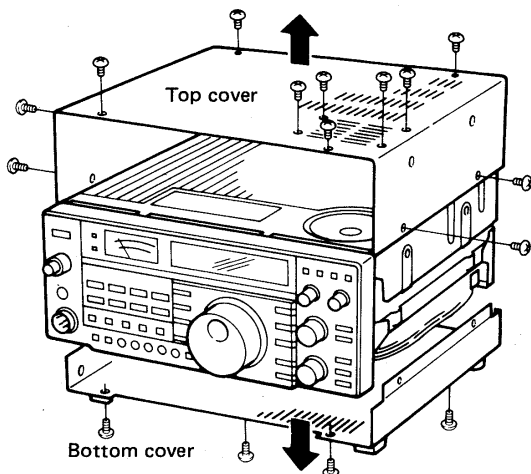

Fig. 1

2) Unscrew 4 screws. (Fig. 2)

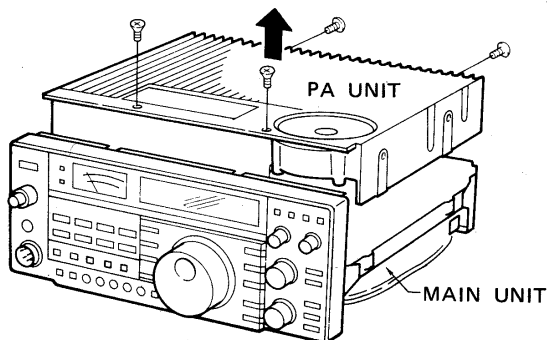

Fig. 2

3) Remove the PA UNIT. (Fig. 3)

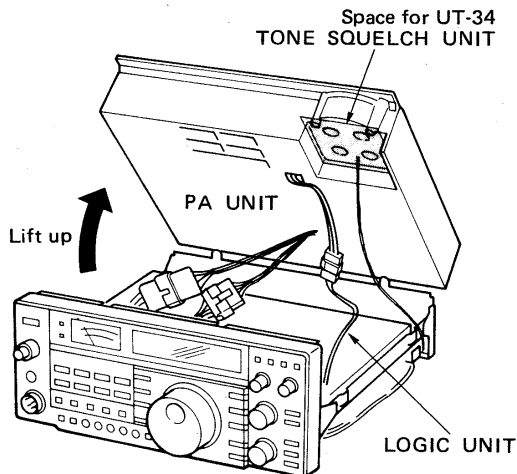
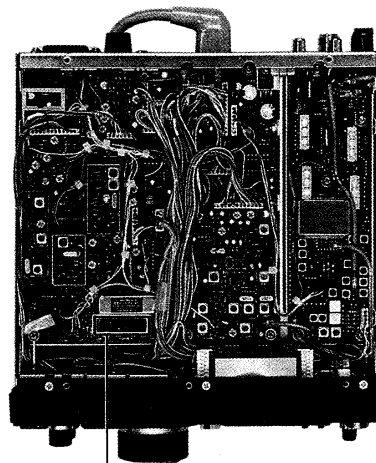

Fig. 3

■ Installation locations

● MAIN AND RF-YGR UNITS



Space for FL-83
CW NARROW FILTER

● PLL AND LOGIC UNITS

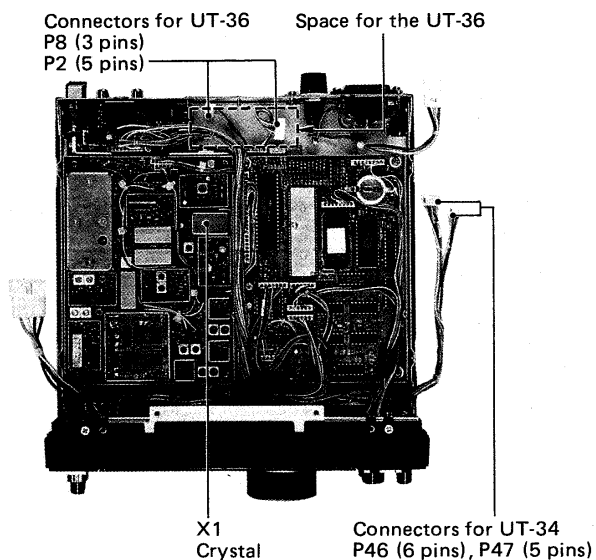

The IC-1275A/E in the photograph above already has an optional CR-263 HIGH-STABILITY CRYSTAL UNIT installed.

9-2 UT-34 installation

The optional UT-34 TONE SQUELCH UNIT allows you to contact specific stations that use a subaudible tone identical to the pre-programmed tone.

Refer to the UT-34 instruction sheet for operating instructions.

- 1) Remove both the top and bottom covers. (Fig. 1)
- 2) Remove the PA UNIT. (Fig. 1)
- 3) Install the UT-34 in the spot behind the internal speaker. (Fig. 2)
- 4) Connect P46 (6 pins) from the MAIN UNIT to J1 on the UT-34. (Fig. 2)
- 5) Connect P47 (5 pins) from the LOGIC and FRONT UNITS to J2 on the UT-34. (Fig. 2)
- 6) Replace the PA UNIT and covers.

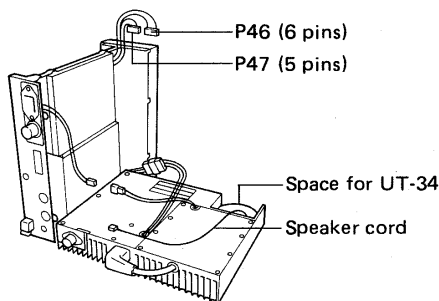

Fig. 1

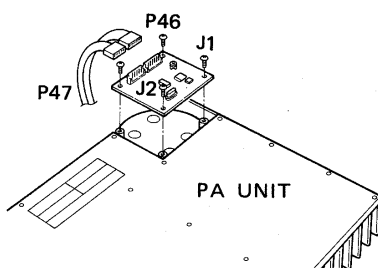

Fig. 2

9-3 FL-83 installation

This optional filter provides comfortable interference-free CW communications.

- Refer to Photo 2 of p. 23 for the installation location of the filter.
- The filter operates regardless of which direction it is installed in.

9-4 UT-36 installation

The UT-36 VOICE SYNTHESIZER UNIT announces the displayed frequency in English from the speaker when [SPCH] on the front panel is pushed.

- Refer to the UT-36 instruction sheet for operating instructions.
- Refer to Photo 2 on p. 23 for installation location of the unit.

- 1) Remove the top and bottom covers. (Fig. 1 on p. 23)
- 2) Remove the PA UNIT.
- 3) Remove the protective paper from the back of the UT-36 to expose the adhesive strip, and install the unit.
- 4) Connect P8 (3 pins) from the MAIN UNIT to J2 (3 pins) on the UT-36. (Fig. 4)
- 5) Connect P2 (5 pins) from the LOGIC UNIT to J1 (5 pins) on the UT-36. (Fig. 4)
- 6) Replace the PA UNIT and covers.

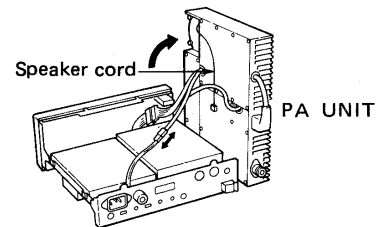

Fig. 3

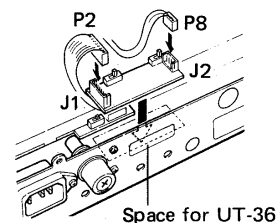

Fig. 4

9-5 CR-263 installation

By replacing the original crystal unit with the CR-263, the total frequency stability of the transceiver will be improved.

- 1) Remove the X1 (crystal) installed on the PLL UNIT and install the CR-263. (Photo 2 on p. 23)
- 2) Remove P1 of the DOUBLER UNIT from J2 on the RF-YGR UNIT and connect a frequency counter to P1. (Photo 2 on p. 23)
- 3) Set the operating frequency to 1270.0000 MHz and select FM mode, then adjust the J2 frequency to 1136.3700 MHz with L38 on the PLL UNIT.
- 4) Replug P1 and replace covers.

10 INSIDE VIEWS

The following adjustment points have been thoroughly adjusted prior to the transceiver leaving the factory. The following should be regarded as reference material. These pictures show the IC-1275A (U.S.A. version).

■ MAIN and RF-YGR UNITS side

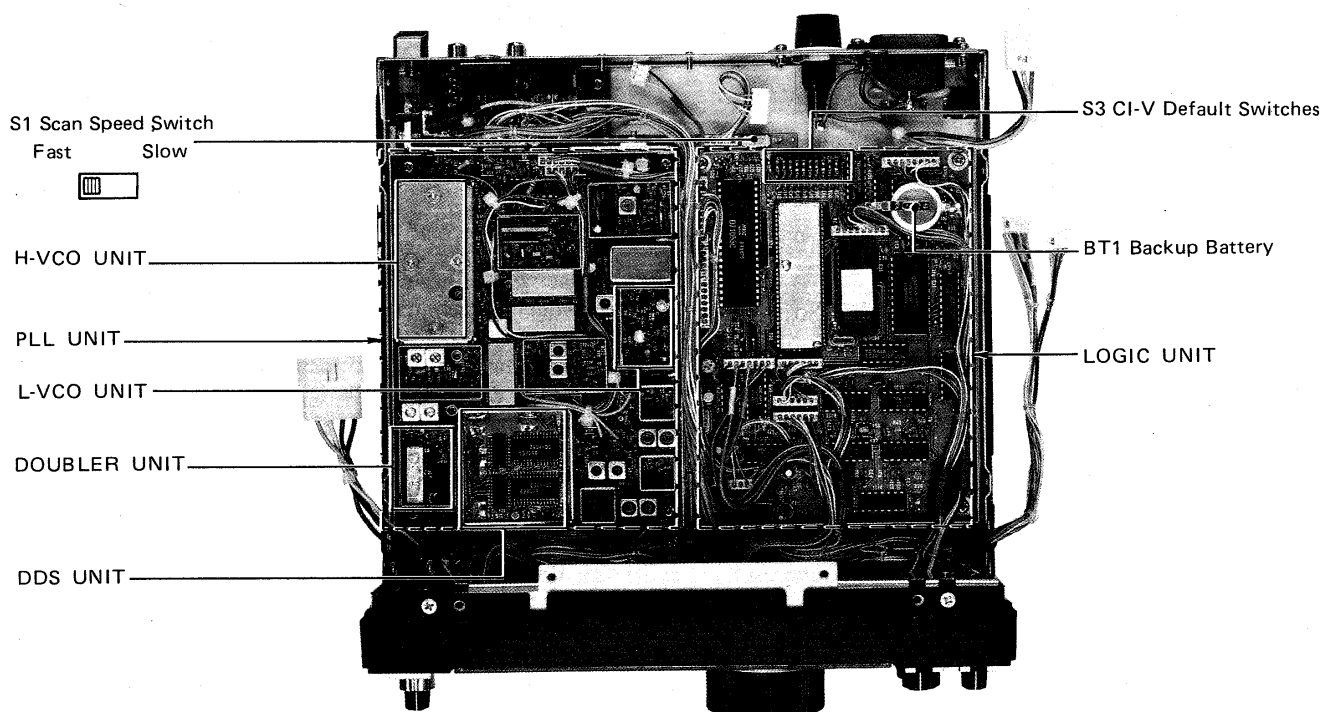
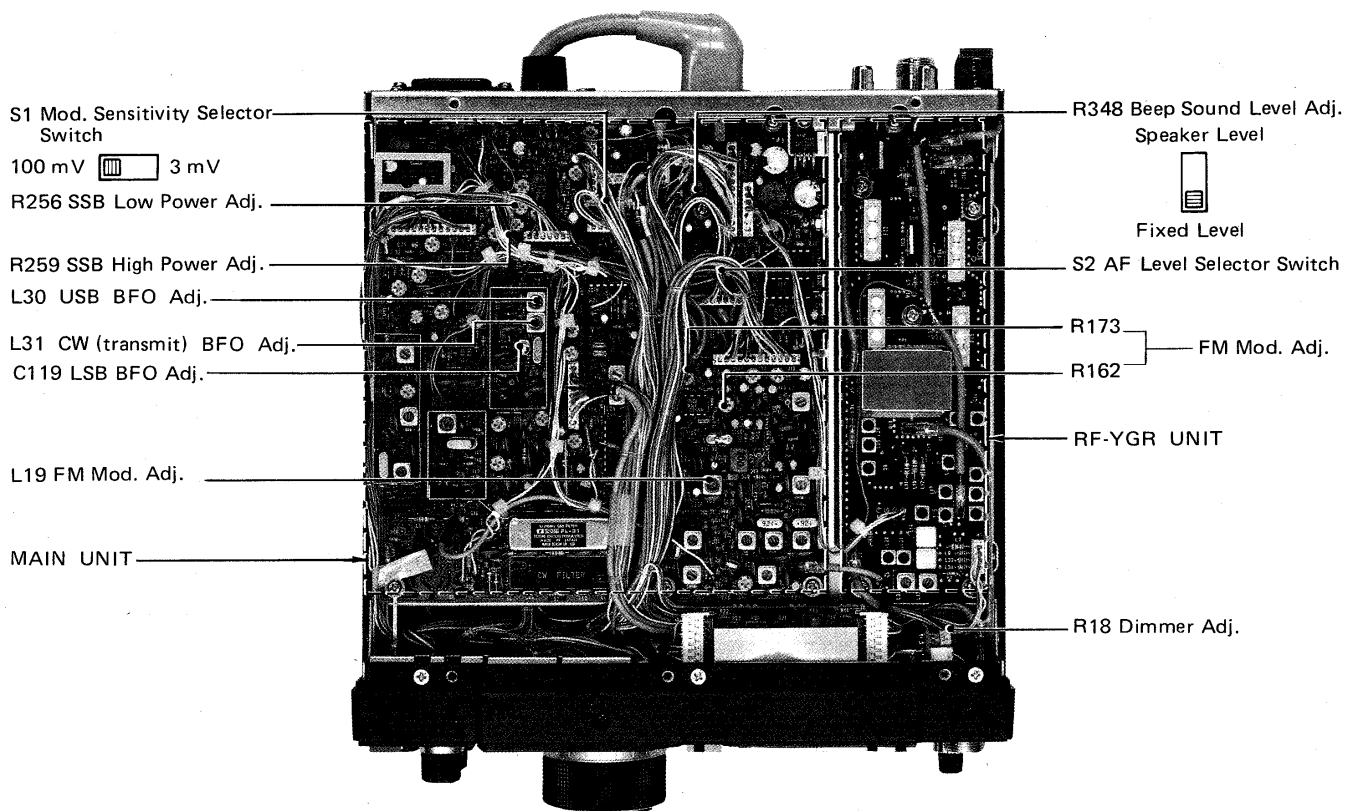

12 SPECIFICATIONS

■ GENERAL

- Frequency coverage :
1240.0000 ~ 1300.0000 MHz
- Number of memory channels :
99 plus P1, P2 and a Call Channel
- Mode :
SSB (A3J), CW (A1), FM (F3), ATV (A5 or A9 with the optional TV-1275)
- Antenna impedance :
50 Ω (unbalanced)
- Usable temperature range :
-10°C ~ +60°C (+14°F ~ +140°F)
- Frequency stability :
±3 ppm (0°C ~ +50°C; +32°F ~ +122°F)
±0.5 ppm (0°C ~ +50°C; +32°F ~ +122°F, with optional CR-263)
- Power supply requirement :
13.8 V DC ±15% (negative ground)
(power supply built-in)
- Current drain (at 13.8 V DC) :

Transmit	At 10 W	6.0 A
	At 1 W	3.5 A
Receive	Squelched	1.7 A
	Max. audio output	1.9 A

- Dimensions :
241(W) x 95(H) x 239(D) mm
9.5(W) x 3.7(H) x 9.4(D) in
(projections not included)
 - Weight :
6.2 kg (13.7 lb)
- ## ■ TRANSMITTER
- Output power :
1 ~ 10 W continuously adjustable
 - Modulation system :
SSB Balanced modulation
FM Variable reactance frequency modulation
 - Max. frequency deviation :
±5 kHz
 - Spurious emissions :
More than 50 dB below peak output power
 - Carrier suppression :
More than 40 dB below peak output power
 - Unwanted sideband :
More than 40 dB down with 1 kHz AF input
 - Microphone impedance :
600 Ω

■ RECEIVER

- Receive system :
SSB, CW Double-conversion superheterodyne
FM Triple-conversion superheterodyne

• Intermediate frequencies :

1st	133.6300 MHz (SSB, FM)	133.6291 MHz (CW)
2nd	10.7500 MHz (SSB, FM)	10.7491 MHz (CW)
3rd	455 kHz (FM)	—

- Sensitivity :
SSB, CW Less than 0.11 μV for 10 dB S/N
FM Less than 0.18 μV for 12 dB SINAD
- Squelch sensitivity :
SSB, CW Less than 0.56 μV
FM Less than 0.10 μV
- Selectivity :
SSB, CW More than 2.3 kHz/-6 dB
Less than 4.2 kHz/-60 dB
FM More than 15 kHz/-6 dB
Less than 30 kHz/-60 dB
- Spurious response rejection :
More than 50 dB
- Audio output power :
More than 2 W at 10% distortion with an 8 Ω load
- Audio output impedance :
8 Ω
- RIT variable range :
±9.98 kHz

All stated specifications are subject to change without notice or obligation.

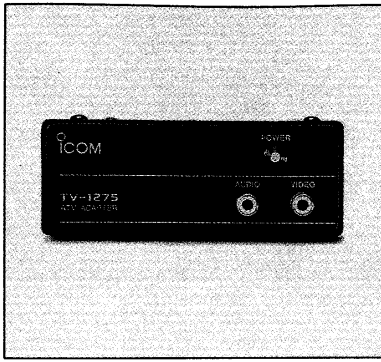

TV-1275
ATV ADAPTER



HP-2
COMMUNICATION
HEADPHONES

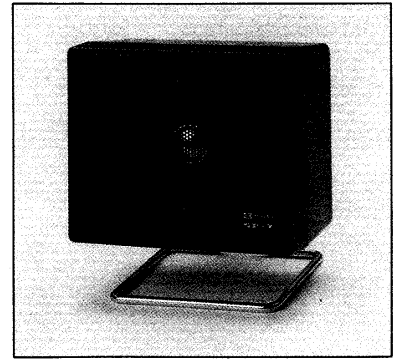

SP-7*
EXTERNAL SPEAKER

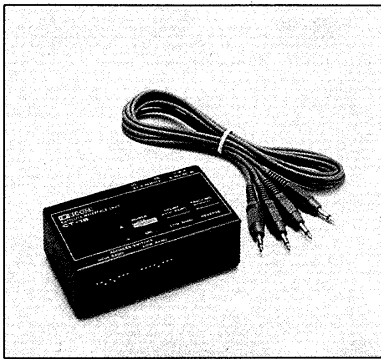

CT-16
SATELLITE INTERFACE UNIT

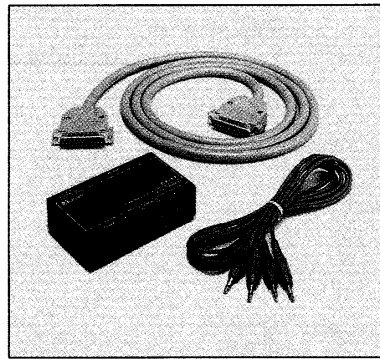

CT-17
CI-V LEVEL CONVERTER

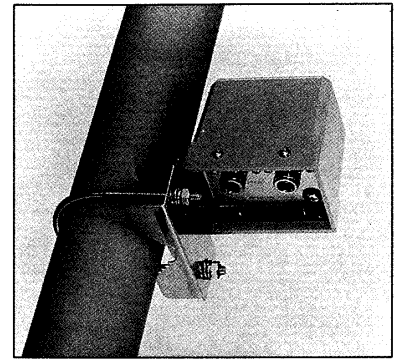

AG-1200
WEATHERPROOF 1200 MHz
PREAMPLIFIER

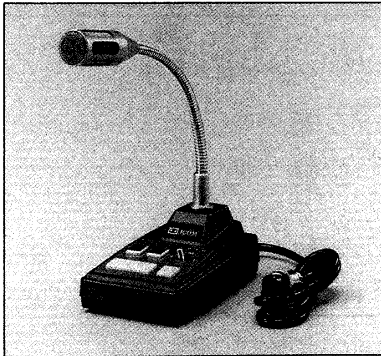

SM-8
DESK MICROPHONE

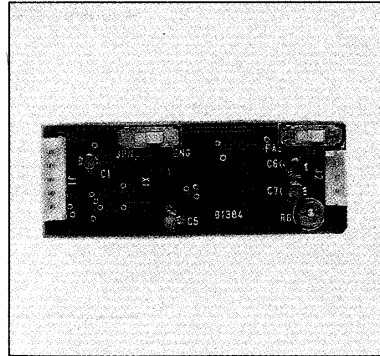

UT-36
VOICE SYNTHESIZER
UNIT

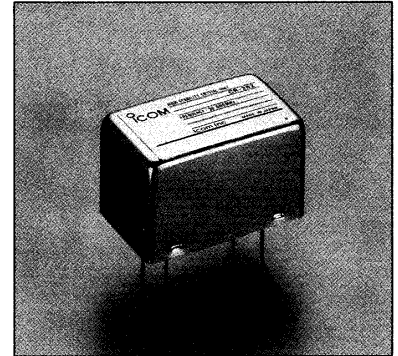

CR-263
HIGH-STABILITY
CRYSTAL UNIT

OPC-025C	DC POWER CABLE
UT-34	TONE SQUELCH UNIT
FL-83	CW NARROW FILTER (500 Hz/-6 dB)
IC-MB5	MOBILE MOUNTING BRACKET
MB-23	CARRYING HANDLE
IC-SP3	EXTERNAL SPEAKER

* Matching style and size with the IC-1275A/E.

Count on us!

