



IC-20

INSTRUCTION MANUAL

TABLE OF CONTENTS

I	SPECIFICATION	1
II	DISCRIPTION	2
III	INSTALLATION	2
IV	CONTROL FUNCTIONS	6
V	OPERATION	7
VI	THEORY OF OPERATION	10
VII	MAINTENANCE	14
VIII	BLOCK DIAGRAM	15
IX	ALIGNMENT CHART	16

SECTION I - SPECIFICATIONS

GENERAL:

Frequency coverage	144.00 to 148.00 MHz
Number of Transistors and Diodes	Transistors 33 FET 5 IC 1 Diodes 20
Modulation Type	F3
Power Voltage	DC 13.5V ±20% negative ground
Current Drain	Transmit: HI (10W) average 2.1 A LOW (1W) average 1.2 A Receive: average 150 mA
Antenna Input	50 ohms
Size	2 9/32" high x 6 1/8" wide x 8 1/2" depth.
Weight	4 1/2 lbs.
TRANSMITTER:	
RF Power Output	HI 10 W LOW 1 W
Frequency Control	Crystal (18 MHz) multiplied x 8
Maximum Frequency Deviation	Adjustable between 3 to 16 KHz
Audio Input	10 K ohms
Modulation System	Variable reactance phase modulation
Microphone	10K ohms - Dynamic microphone with push button switch
RECEIVER:	
Reception Frequencies	12 channels for 144 MHz band. Built-in crystal units for 3 channels.
Reception System	Double Superheterodyne
Intermediate Frequencies	1st intermediate: 10.7 MHz 2nd intermediate: 455 KHz
Sensitivity	a. Better than 0.4 u V 20 db quieting b. S + N/N at 1 u V input, 30 db or more
First IF	10.7 MHz
Second IF	455 KHz
Spurious Response	-60 db
Spurious Gain	-60 db, or less
Squelch	Adjustable 5 to -15 db
Band width	±15 KHz / -6 db point ±25 KHz / 50 db
Audio Output Power	1.5 W
Audio Output Impedance	8 ohms
Frequency Control	Crystal (14 MHz) multiplied x 9

ACCESSORIES

Make sure the following accessories for the model IC-20:

- (1) Microphone (dynamic type) 1
- (2) Microphone hook 1
- (3) Power cord 1
- (4) Spare fuses (5A) 2
- (5) Installing holder A 1
- (6) Installing holder B 1
- (7) Installing angle joint 1
- (8) Gimp nuts 4
- (9) Flat washers 4
- (10) Spare indicator 1
- (11) Dial lettering 1
- (12) Clip cord for calibration 1
- (13) Plug for speaker 1
- (14) Instruction manual 1
- (15) Silicon cloth 1

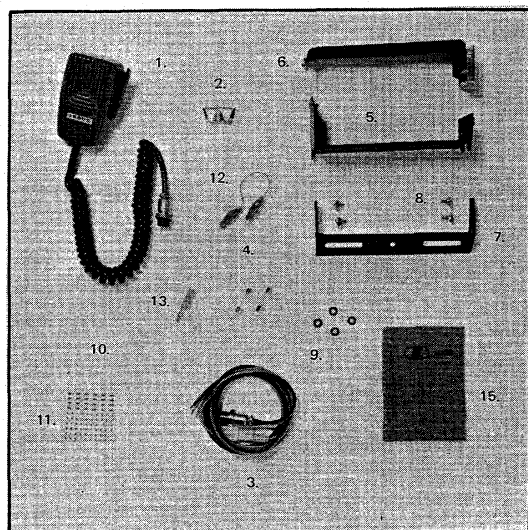

SECTION II - DESCRIPTION

This transceiver is an extremely rugged, completely solid state transceiver. State of the art devices such as Integrated Circuits, Field Effect Transistors, varactor and Zener diodes are engineered into tight knit straightforward electronic design throughout both transmitter, and receiver. Reliability, low current demand, compactness, unexcelled performance and ease of operation are the net result.

The dual conversion receiver with its FET front end and high-Q helicalized cavity resonators boasts low noise and sensitivity of 0.4 uV or less. Signal gain of 90 db or more is accomplished from the second mixer back by virtue of 6 stage of IF amplifier. The need for additional front end RF amplification is thus eliminated. Zener regulated crystal-controlled first and second local oscillators produce unmatched stability. Audio reproduction is of an unusually high order of distortionfree clarity.

The transmitter section will produce a minimum of 10 watts RF output. Again, a Zener regulated crystal oscillator is employed for initial frequency stability. Twelve crystal controlled channels are provided for operating convenience and versatility. High-Q and shielded stages provide minimum interstage spurious reaction. An encased low pass filter is placed at the output to further insure undesirable frequency products not being emitted. An ingenious final PA transistor protection device, (APC), is incorporated in the final output circuitry. A tiny VSWR bridge and four DC amplifiers constantly monitor the output for high VSWR, a shorted or absent antenna load or other difficulty that would cause irreparable final transistor damage. Should these difficulties occur, the APC instantaneously disables the driver and final PA without damage.

All circuitry is constructed in a series of modules which are easily removable for servicing. The modules are housed in a sturdy aluminium frame which is, in turn, housed in a rigid metal chassis, providing an extremely durable and rugged unit. Premium care has been taken to filter and regulate internal DC voltages. A DC input filter is provided to eliminate alternator or generator "whine" generated in the vehicle environment. Test points are brought up from all major circuits to facilitate maintenance checks and trouble shooting should the necessity arise.

Each unit comes complete with built-in speaker, a high-quality dynamic microphone, mobile mounting bracket, microphone clip, DC cabling and plug, external speaker plug, and operating manual.

A modern styled face plate, large S meter, small size and low profile design complete the unit's styling. A welcome addition to any dashboard or fixed station.

SECTION III - INSTALLATION

3.1 Unpacking:

Carefully remove your transceiver from the packing carton and examine it for signs of shipping damage. Should any shipping damage be apparent, notify the delivering carrier or dealer immediately, stating the full extent of the damage. It is recommended you keep the shipping cartons. In the event storage, moving, or reshipment becomes necessary, they come in handy. Accessory hardware, cables, etc., are packed with the transceiver. Make sure you have not overlooked anything.

3.2 Location:

Where you place the transceiver in your automobile is not critical and should be governed by convenience and accessibility entirely. Since the unit is so compact, many mobile possibilities present themselves. The non-smoker, for instance, will find the removal of the auto ashtray will provide a very handy place in most modern cars. In general, the mobile mounting bracket will provide you with some guide as to placement. Any place where it can be mounted with metal screws, bolts, or pop-rivets will work. For fixed station use, the IC-3P (or IC-3PA) AC power supply is so designed as to be a stand for the transceiver. The mated units occupy a space 6 1/4" x 6 1/4" x 7 1/2".

3.3 Power Requirements:

The transceiver is supplied ready to operate from any regulated 13.5 VDC, 2.5 ampere negative ground source. An automobile, 12 volt, negative ground, system is usually more than adequate. Some note must be taken, however, to the condition of the vehicle's electrical system. Items such as low battery, worn generator/alternator, poor voltage regulator, etc., will impair operation of your transceiver as well as the vehicle. High noise generation or low voltage delivery can be traced to these deficiencies. If an AC power supply other than the matching IC-3P is used with your transceiver, make certain it is adequately regulated for both voltage and current. Low voltage while under load will not produce satisfactory results from your transceiver. Receiver gain and transmitter output will be greatly impaired.

CAUTION: Excessive Voltage (above 15VDC) will cause damage to your transceiver. Be sure to check the source voltage before plugging in the power cord.

Included with your transceiver is a DC power cable with plug attached. The Red Wire is positive (+), the Blue, negative (-). If your mobile installation permits, it is best to connect these directly to the battery terminals. This arrangement eliminates random noise and transient spikes sometimes found springing from automotive accessory wiring. If such an arrangement is not possible, then any convenient B+ lead in the interior of the vehicle and the negative frame can be utilized. Your transceiver provides an internal DC filter that will take out the large amount of transient difficulties anyway. Remember, the unit operates on a negative ground system only - it cannot be used in a positive ground automobile. After making your connections, simply insert the plug into your transceiver (see Fig. 3) and tighten snugly with its threaded retaining ring.

When your transceiver is mated with its matching AC power supply, the IC-3P (or IC-3PA) the power cable from the IC-3P (or IC-3PA) is simply plugged in the same receptacle in the transceiver and the AC line cord into any convenient wall receptacle. In this case (only IC-3P), the power cable also carries the necessary wiring for the built-in discriminator meter.

3.4 Antenna:

The most important single item that will influence the performance of any communication system is the antenna. For that reason, a good, high-quality, gain antenna of 50 ohms impedance is recommended, fixed or mobile. In VHF as well as the low bands, every watt of ERP makes some difference. Therefore, 12 watts average output plus 3 db of gain antenna equals 24 watts ERP, presuming low VSWR of course. The few more dollars investment in a gain type antenna is well worth it.

When adjusting your antenna, whether mobile or fixed, by all means follow the manufacturer's instructions. There are some pitfalls to be aware of. For example, do not attempt to adjust an antenna for lowest VSWR when using a diode VSWR meter not engineered for VHF applications. Such readings will invariably have error of 40% or more. Rather, use an in line watt meter similar to the Drake WV-4 or Bird Model 23 with VHF cartridge. Further, when adjusting a mobile antenna, do so with the motor running preferably above normal idling speed. This will insure proper voltage level to the transceiver.

Do not become alarmed if your transceiver fails to transmit at times during the antenna tune up procedure. Remember, your transceiver has a built-in Automatic Protection Circuit (APC) that will disable the transmitter if excessive VSWR, a shorted coaxial line or connector, or other antenna deficiency is present. A quick check on a good 50 ohm dummy load will show the transceiver to be working. The difficulty will lie with the antenna or its transmission line.

The RF coaxial connector on the rear chassis mates with a standard PL-259 connector. Some models may have a metric thread. If this is the case, a matching metric PL-259 is provided. In any event, the RF connector will mate with almost any PL-259 connector if care is taken to seat them properly.

3.5 Microphone:

A high quality dynamic microphone is supplied with your transceiver. Merely plug it into the proper receptacle on the front panel. Should you wish to use a different microphone, make certain it is of the high impedance type; at least 10 K ohms or better. Particular care should be exercised in wiring also, as the internal electronic switching system is dependant upon it. See the schematic for the proper hook up. Under no circumstances use a "gain pre-amp" type microphone. The audio system in your transceiver is more than adequate and additional pre-amplification unnecessary. To use this class of microphone is to invite distortion and possible damage to the transceiver.

3.6 Crystals:

Your transceiver has twelve channels, both transmit and receive, or a total of 24 crystal positions. The channel selector switch selects one transmit and one receive channel in each of its twelve positions.

To order additional crystals from a manufacturer, the following correlation data is provided. Remember to specify high activity as prerequisite to your acceptance.

Crystal Data

Holder Type:	HC-25/u
Calibration Tolerance:	0.0025%
Load Capacitance:	20 pf
Effective Resistance:	15 ohms or less
Transmit Crystal:	Crystal Frequency <u>Desired Operating Frequency</u> 8
Receive Crystal:	Crystal Frequency <u>Desired Operating Frequency—10.7 MHz</u> 9

Trimmers have been placed on the crystal board to assist you in "tweaking" new crystals on frequency. Consult the trimmer location chart (Fig. 2) for their positions.

The amount of frequency spread between any two receiving or any two transmitting frequencies should not exceed 2 MHz. Since the receiver and transmitter are independent of each other, you may have any practical amount of frequency separation you wish here. Only two or more widely spaced frequencies for the receiver alone or for the transmitter alone need be considered under the 2 MHz limitation.

Fig. 2

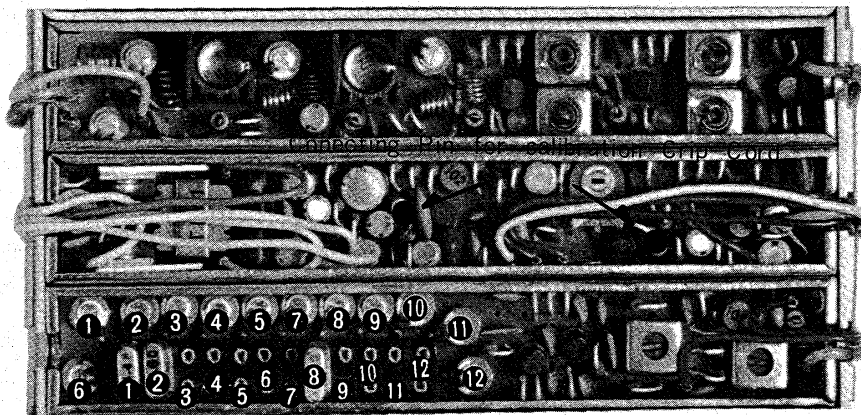

3. 7 External Speaker:

An external speaker jack and plug is supplied with your unit in the event another speaker is desirable. The external speaker impedance should be 8 ohms. The use of the external speaker jack will disable the internal speaker. An 8 ohm headset can be utilized as well. (See Fig. 3)

SECTION IV - CONTROL FUNCTIONS

4.1 Front Control and Jacks (Fig. 3A)

- 4.1.1 High-Off-Low Switch: opens or closes the 12 VDC source voltage to the transceiver. "In high" position, output power is 10 watts. "In low" position, output power is 1 watt.
- 4.1.2 Volume Control: controls audio output level of the receiver.
- 4.1.3 Squelch Control: controls the squelch threshold point of the receiver.
- 4.1.4 Microphone Jack: accepts 3 prong mike plug supplied on microphone.
- 4.1.5 S-RF Meter: reads S signal strength in receive mode and relative RF output in transmit mode. The meter face is illuminated with a white lamp when the transceiver is switched on in in-receive condition. In transmit condition a red lamp lights also.
- 4.1.6 Channel selector: selects one of twelve pairs of transmit receive crystals.

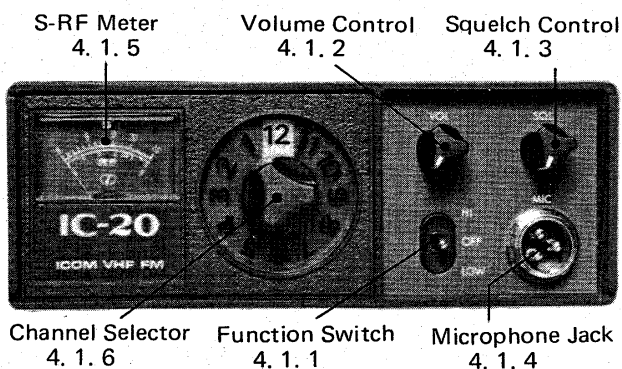
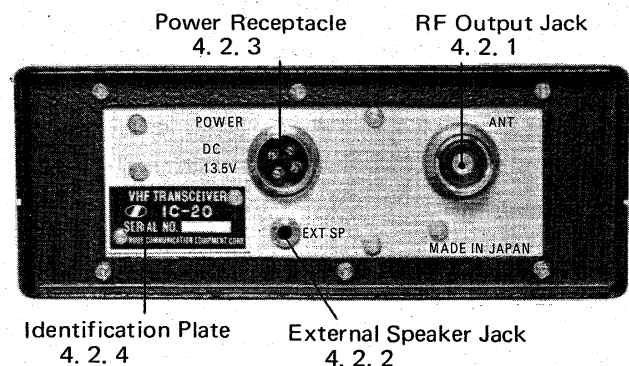

Fig. 3

A B



4.2 Rear Panel (Fig. 3B)

- 4.2.1 RF Output Jack: Accepts standard PL-259 coaxial connector. Note: Some transceivers may come with a metric threaded connector. If this is the case, a mating metric PL-259 is supplied also. Most PL-259 connectors will mate satisfactorily if care is taken to seat them properly. If you have difficulty, try a different make of PL-259.
- 4.2.2 External Speaker Jack: This jack mates with the plug supplied for external 8 ohm speaker or headset use. The use of this jack mutes the internal speaker.
- 4.2.3 Power Receptacle: Mates with DC cord plug or power cord of IC-3P AC power supply.
- 4.2.4 Identification Plate: States model, serial number and date of manufacture. Note: It would be well to make a separate record of the serial number of your unit for insurance purposes.

SECTION V - OPERATION

5.1 Initial Preparations:

- a. Connect the microphone to the microphone jack.
- b. Connect the antenna to the antenna coax connector. Make sure the coax line is of the correct impedance (50 ohms) and is neither shorted nor open circuited.
- c. Make sure the function switch is in the off position switch then connect the power supply cord to the power supply jack. The red lead should be connected to the positive side of the power source and the blue lead to the negative side. In the event that these leads are improperly connected the IC-20 will not function. No damage will be incurred since protection is provided in the IC-20 for this purpose.
- d. Turn the volume and squelch controls to the maximum counter clockwise position.

5.2 Operation:

- a. When the function switch is set to either the high or low position the set is switched on and the channel indicator window and meter will be illuminated.
- b. Switch the channel selector to the desired channel.

5.3 Reception:

- a. Adjust the volume control to a comfortable listening level of noise, if no signal is present.
- b. Carefully adjust the squelch control clockwise until the noise just disappears. This is the proper squelch threshold setting and must be done when no signal is present. Your transceiver will now remain silent until an in-coming signal is received which opens the squelch. If the squelch is unstable due to the reception of weak or unstable stations, adjust the squelch control further until the proper threshold is obtained.
- c. The S meter indicates the signal strength of the in-coming stations and is calibrated in S units, and db over S9, calibrated 5uv at S5, across the antenna terminals.

5.4 Transmitting:

- a. Push the PTT (push to talk) button on the microphone and the transceiver is set for transmitting. At the same time the meter will be illuminated red and will provide an indication of relative power output of the transmitter. The pointer will be on or near the red mark on the meter scale when on high power and just a little over one on low power.
- b. Hold the microphone about three inches from your mouth and speak in a normal voice. Shouting does not increase your communication range, but a good antenna does. The microphone is of the dynamic type and provides good pickup for all levels of the voice.
- c. To receive again, just release the PTT button. This will also switch off the red illumination of the meter.

5.5 Function Switch:

- a. You can select the proper output power according to the communication distance to be covered, or conditions. When using the IC-20 as a driver or exciter for a linear amplifier the function switch can be set to the low power position and the power output adjusted as described in the Power Supply section. This will provide the required amount of drive for the linear amplifier without wasting power in swamping resistors, etc. When the switch is set on HI the power output will be 10 watts and on LOW the output will be one watt.

Fig. 4

Transmitter

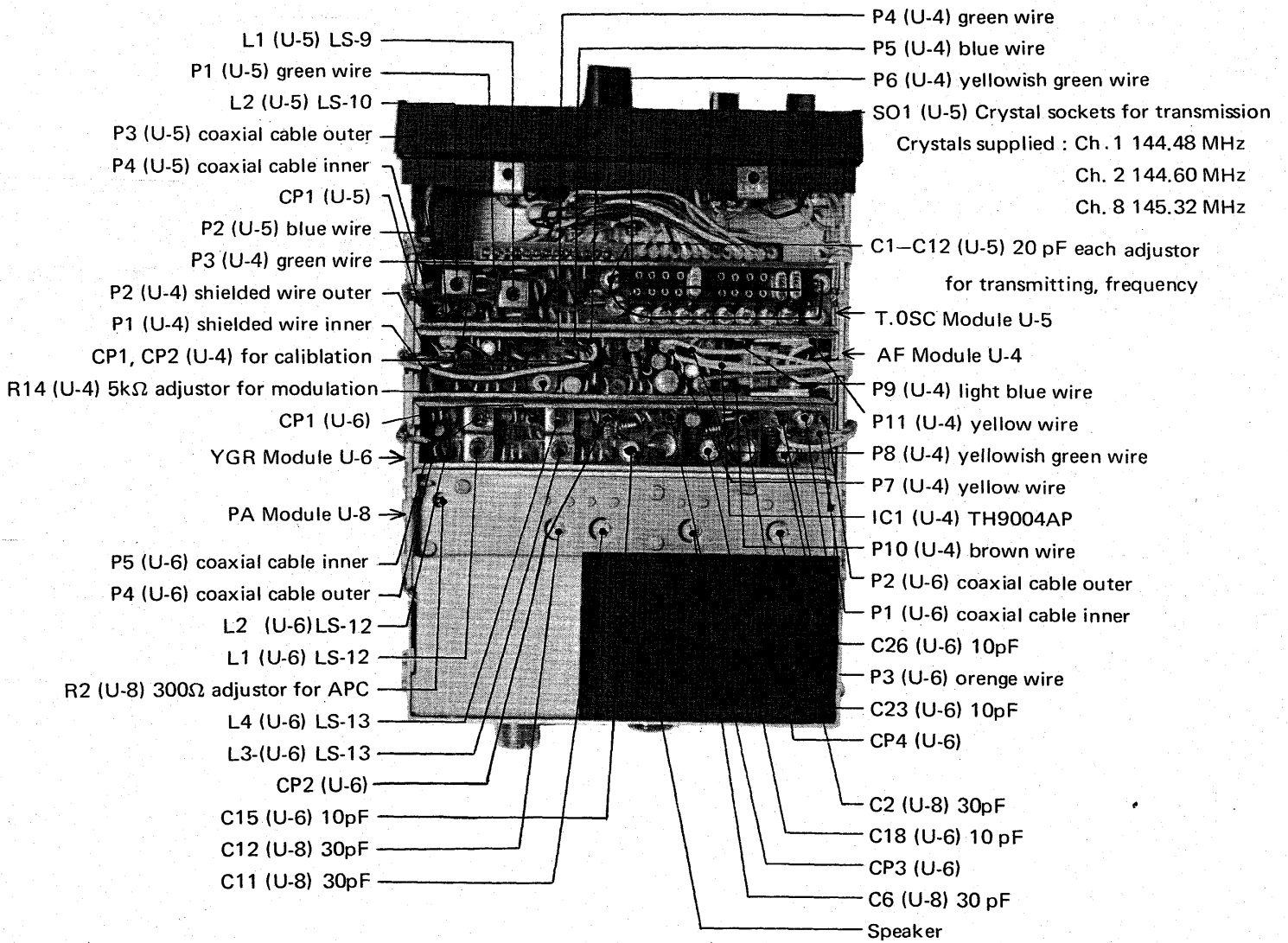
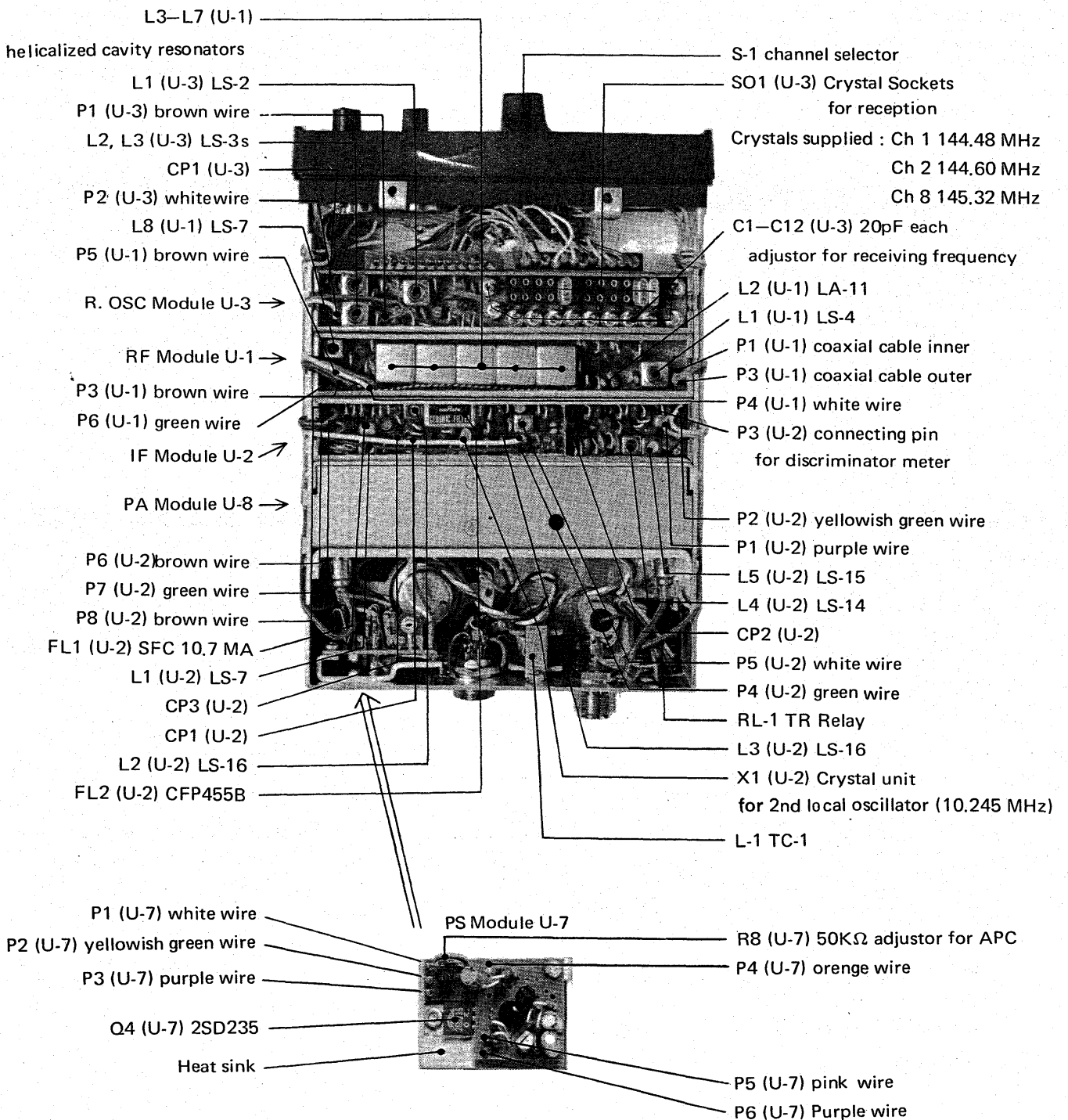

Fig. 4



SECTION VI - THEORY OF OPERATION

6. 1 Receiver RF Amplifier and First Mixer Module U-1 (B-006)

The input signal is amplified by the field effect cascade amplifier, Q1 and Q2 (2SK19s), and passed into the RF filter. This filter is a high Q helicalized resonators with excellent bandpass characteristics and shockproof construction. From the output of the helicalized resonators the signal is fed to the gate of the first mixer, Q3 (2SK19) where it is mixed with the output from the receiver crystal oscillator unit (U-3), which is fed into the source of Q3 to obtain the 10.7 MHz. IF signal. The output of the mixer is fed through the first ceramic filter FL 1 (SFC 10.7 MA) to the IF amplifier. All transistors in the receiver RF unit are field effect transistors, which have the highest possible sensitivity and signal to noise ratio and the lowest possible cross modulation.

6. 2 Receiver crystal Oscillator Module U-3 (B001)

This is a fundamental oscillator circuit at 14MHz. using Q1 (2SC372). The trimmers in series with the crystals make it possible to alter the crystal frequency several KHz. The output is taken from the emitter and tripled by Q2 (2SC372) and again tripled by Q3 (2SC784). The output signal is then fed into the First Mixer in the receiver RF unit. Q3 (U-1), (2SK19), giving the first IF of 10.7 MHz.

6. 3 Receiver 1st IF amplifier, 2nd Mixer, 2nd IF amplifier, Limiter and Discriminator Module U-2 (B009)

The 10.7 MHz. signal from the first ceramic filter in the RF unit is amplified by Q1 (2SC371) and fed to the gate of the 2nd Mixer Q2 (2SK19) through the 2nd ceramic filter FL 1 (SFC 10.7MA). The variable resistor in the emitter circuit of the First IF transistor Q1 adjusts the IF gain and S-meter sensitivity. The 2nd Oscillator Q9 (2SC371) is crystal controlled and operates on 10.245 MHz. The output is taken from the emitter of Q9 and fed into the gate of the 2nd Mixer Q2 (2SK19) to obtain the 455 KHz. IF signal, which is passed through the 3rd ceramic filter FL 2 (CFP 455 B) and amplified by Q3, Q4, Q5, Q6, Q7 and Q8 (2SC371s). The output of Q8 is then demodulated in the discriminator circuit, consisting of L4 (LS-14), L5 (LS-15), and D7 and D8 (1N60s).

6. 4 Receiver Audio Amplifier, Squelch and Speech Amplifier Module U-4 (B-008)

The output of the discriminator drives two circuits: the audio amplifier, and the squelch. The audio signal, after being adjusted by the volume control R-1, is then fed to IC 1 (TH9004AP), followed by the audio power amplifier stage Q8 and Q9 (2SD235s), which gives an audio output of 1.5 watts.

The squelch circuit is made up of Q5, Q6 (3SC371s), Diodes D3, D4 (1N60s), and Q7 (2SC373). In the absence of a signal, the noise component at the output of the discriminator is amplified by Q5 and A6 Diodes D3 and D4 rectify this amplified component Q7 and couple it via the 10 K ohm R-2 squelch control to the DC amplifier, Q7s putput is coupled directly to the base circuit of IC 1. When the squelch control is adjusted, the amount of DC required to cut off IC 1 is found, thus establishing the squelch threshold. When a signal is incoming via the discriminator, this bias is overcome, permitting the audio amplifier and driver to perform normally.

The signal from the microphone is amplified by Q1 and Q2 (2SC371s), fed to the deviation limiter, which consists of D1, and D2 (1N60s) and the active audio filter Q3 (2SC371) and further amplified by Q4 (2SK30) before being fed to the modulation circuit in the transmitter oscillator unit.

6. 5 Power Supply Circuit Module U-7 (B-007)

This circuit provides a source of regulated voltage for the receiver circuits and the control of output power during antenna mismatch conditions, as described above.

The receiver voltage is regulated to about 8 volts by the series pass transistor Q5 (2SC620) which has its base set at 9 volts by the zener diode D1 (1N757). Capacitor C5 acts to eliminate voltage transients and noise from the output of the regulator.

The action of transistors Q1, Q3 and Q4 is described in the APC circuit.

Resistor R-3 connected to the resistor network, consisting of resistors R1 and R2 is used to provide an adjustment in output power when the function switch is set in the low power position. Adjustment of this resistor controls the base drive to the regulator transistors Q2, Q3, and Q4. This adjustment in effect controls the actual voltage supplied to the driver transistor Q1 (U-8) and the power output transistor Q2 (U-8) when the function switch is in the low power position. The output power can be set to any value from tenths of a watt to a few watts. This feature is useful when using the transceiver as an exciter driving a linear amplifier.

6. 6 Transmitter Crystal Oscillator and Phase Modulator Module U-5 (B-002)

Transistor Q1 (2SC373) operates as a fundamental oscillator at a frequency of 18 MHz. The output of this oscillator, taken from its emitter, is fed to the base of transistor Q2 (2SC373) which operates as a buffer amplifier between the oscillator and phase modulator circuit. Trimmer capacitors are provided in series with each crystal which allows the frequency of the oscillator to be varied by several KHz. Thus the final output of the transmitter can be set precisely on the desired frequency.

The Phase modulator circuit consists of Varactor diode D2 (MV3047), L2 (LS-10), R9, R10, R11, R13, R14, C9, C10, and C12. Resistors R9 and R14 provide a bias voltage for the reverse biasing of the Varactor diode D2. An audio voltage is coupled into this same bias point through the 1 mh inductor. This audio voltage is derived from the speech amplifier circuit, U-4 (B-008).

6.7 Transmitter Multiplier and Pre-driver Module U-6 (B-004)

The modulated signal from diode D2 (U-5) is multiplied eight times to a final frequency of 144 MHz by transistors Q1, Q2 (2SC373s), and Q3 (2SC773). Each of these transistors act as frequency doublers. Double tuned circuits are used between stages to minimize spurious radiation and to achieve an even response over the 144 to 148 MHz range.

The 144 MHz signal is amplified by Q4 (2SC741) and Q5 (2SC730) to a power level of one watt. This signal is fed into the power amplifier.

6.8 Transmitter Power Amplifier and Transmitter Automatic Protection Circuit (APC) Module (U-8 (B-003) and (B-005))

The signal from the multiplier and pre-driver unit is amplified to 10 watts by transistors Q1 (2SC1011) and Q2 (2SC703). Transistor Q2 is the power output stage and is coupled to the antenna through the spurious filter consisting of L8, L9, and L10 and the Automatic Protection Circuit.

The APC acts to decrease the power output of Transistors Q1 and Q2 if the antenna is seriously mismatched. A reflected power detector is provided by L11 (V9T-02) and D2 (1N60). When the antenna is mismatched this circuit senses a high reflected power and provides base drive to transistor Q1 (U-7) in the Power Supply unit. This transistor will conduct sufficient base drive to reduce the base drive of transistor Q2 (U-7).

When transistor Q2 (U-7) begins to turn off it reduces the drive to the complementary transistor pair, consisting of Q3 (U-7) and Q4 (U-7). This pair acts as a series regulator for the voltage supplied to the driver transistor Q1 and the power output transistor Q2. When they begin to turn off, due to a lack of base drive, the voltage being supplied to Q1 and Q2 is reduced to about six or eight volts which reduces the power output to a safe value. This lower power prevents damage to Q1 and Q2 when the antenna is mismatched.

SECTION VII - MAINTENANCE

7.1 The necessity of completely realigning the unit is unlikely. The most common cause of breakdown is component failure. It is felt that the average owner would not have the necessary equipment and facilities to accomplish realignment in any case, if it did become necessary. If one did have such facilities and instruments it is highly likely he would be a FM technician and instructions for alignment would be unnecessary. All of the foregoing is to say that this transceiver is a complicated, and electronically speaking, delicate machine. Great care and precision are employed in its manufacture, and warranty service is provided to ensure it meets specifications. Adjustments not outlined herein should not be undertaken unless the owner is skilled as a technician.

7.2 Transmitter Alignment:

- a. Remove the two retaining screws on the top and bottom of the cabinet and the six self tapping screws at the rear of the cabinet. Separate the Chassis from the cabinet.
- b. Connect a dummy load (50 ohms) or a wattmeter to coax connector. (4-2-1 Fig. 3)
- c. Connect the power supply cord to the power jack (4-2-3 Fig. 3) and the microphone to the microphone jack. (4-1-4 Fig. 3)
- d. To align the transmitter on a desired frequency switch the channel control to the desired channel. Slowly adjust the trimmer capacitor for that channel until the desired frequency is achieved. Consult Fig. 2 for the location of the proper trimmer. These trimmers should be adjusted very slowly while the transmit frequency is observed on suitable measuring equipment. Another IC-20 equipped with a discriminator meter can serve well for this purpose. However it must be adapted.

This adaptation can be accomplished by installing a 50 microampere center 0 meter. Install the meter at P3 (U-2), and ground. With the IC-20, meter installed, in the receive mode on the channel desired, adjust the trimmer capacitor for the null point on the meter.

- e. The Multipliers, driver and Power output stages should be aligned on LOW power first then set the function switch on HIGH power. Align these stages according to the alignment chart provided. (See chart 1)

Be careful not to transmit for more than 5 Second during each alignment step. As damage could be caused to the transistors due to overload during this procedure.

7.3 Receiver Alignment:

- Remove the microphone from the transceiver to prevent accidental transmission during receiver alignment.
- Allow the test oscillator or generator to stabilize the output frequency drift.
- Connect the test oscillator or generator to the antenna coax connector. Set the test oscillator or generator to the desired frequency. Set the squelch control to the maximum counter clockwise position.
- Align the receiver according to the chart provided. (See chart 1).
- When setting the receiver to a desired frequency a discriminator meter should be connected to P3 (U-2) and the receiver trimmer capacitors adjusted to cause the S meter to read a maximum and the discriminator meter to read zero. Refer to Fig. 2 for the location of the proper trimmer corresponding to the channel to be used. Adjust these trimmers very slowly while observing the discriminator meter. Another IC-20 operating on the desired frequency can be used for this purpose also.

BLOCK DIAGRAM

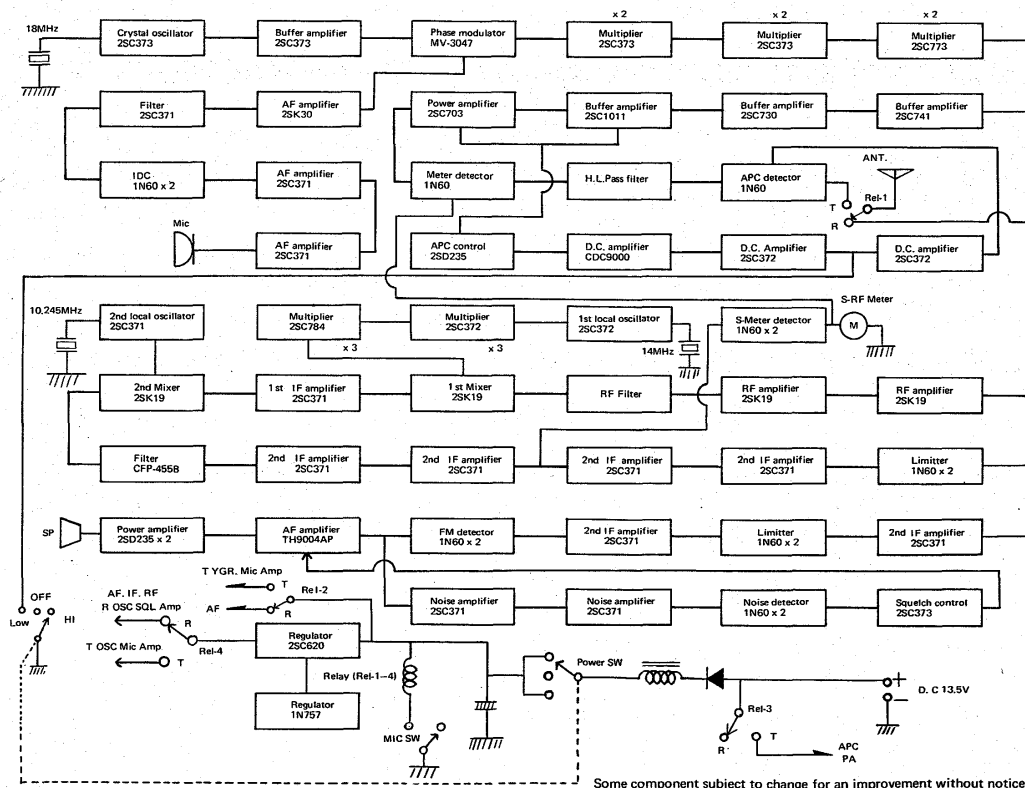

ALIGNMENT CHART (Chart 1)

IC-20 VOLTAGE CHART

UNIT NO.	NO.	NAME	BASE	EMITTER	COLLECT,	TEST POINT	ANY OTHERS
U-1	Q1	2SK19	0 (G)	0.15 (S)	7.6 (D)		FET
"	Q2	"	0 (G)	1.6 (S)	7.4 (D)		"
"	Q3	"	0 (G)	1.1 (S)	8.1 (D)		"
U-2	Q1	2SC371	2.2-3.2	1.5-2.5	4.0-8.0		R36
"	Q2	2SK19	0 (G)	1.3 (S)	8.0 (D)		
"	Q3	2SC371	0.7	0	2.4		
"	Q4	"	5.8	5.2	6.1		
"	Q5	"	0.7	0	1.0		
"	Q6	"	2.8	2.3	3.4		
"	Q7	"	5.2	4.9	6.0		
"	Q8	"	1.0	1.1	7.0		
"	Q9	"	2.4	2.0	7.6		
"	CP1					2.0	
"	CP2					3.4	
"	CP3					0	
U-3	Q1	2SC372	2.4	2.0	7.2		
"	Q2	"	0.7	0.7	7.7		
"	Q3	"	1.1	0.7	7.7		
"	CP1					0.02-0.4	OSC LEVEL
U-4	* Q1	2SC371	0.24	0.03	1.4		
"	* Q2	"	1.4	0.8	6.5		
"	* Q3	"	7.0	6.7	8.4		
"	* Q4	2SK30	0 (G)	0.8 (S)	4.0 (D)		FET
"	Q5	2SC371	1.2	0.6	8.0		
"	Q6	"	1.2	0.6	7.0		
"	Q7	2SC373	0.7	0	5.0-0		SQL, OFF-ON
"	Q8	2SD235	7.0	6.5	13.5		
"	Q9	"	0.7	0	6.5		
"	* CP1					8.4	
"	CP2					8.4	

UNIT NO.	NO.	NAME	1	2	3	4	5	6	7	ANY OTHERS
U-4	IC 1	TH9004AP	0.6-0	1.3-0	5.0-0	-	0	13.0	0.6-0	SQL, OFF-ON

U-5	* Q1	2SC373	2.5	2.0	8.0					
"	* Q2	"	2.4	1.9	8.0					
"	* CP1							0.1-0.2		
U-6	* Q1	2SC373	1.2	0.8	13					
"	* Q2	"	0.8	0.8	13					
"	* Q3	2SC773	0.7	1.3	13.2					
"	* Q4	2SC741	-	1.2	13.0					
"	* Q5	2SC730	-	0	13.5					
"	* CP1							0.8		
"	* CP2							1.3		
"	* CP3							1.2		
"	* CP4							-0.1~-0.3		DRIVE LEVEL
U-7	* Q1	2SC372	0-0.7	0	8.5-1.5					SWR REF,
"	* Q2	2SC372	8.5-1.5	7.8-1.0	12.8					APC ON-OFF
"	* Q3	CDC-9000	13.5	12.8	12.5-6.0					"
"	* Q4	2SD235	12.5-6.0	12.5-6.0	13.5					"
"	* Q5	2SC620	8.9	8.2	12.2					
U-8	* Q1	2SC1011	-	0	13-6					
"	* Q2	2SC703	-	0	13-6					

* Reading taken in the TRANSMIT

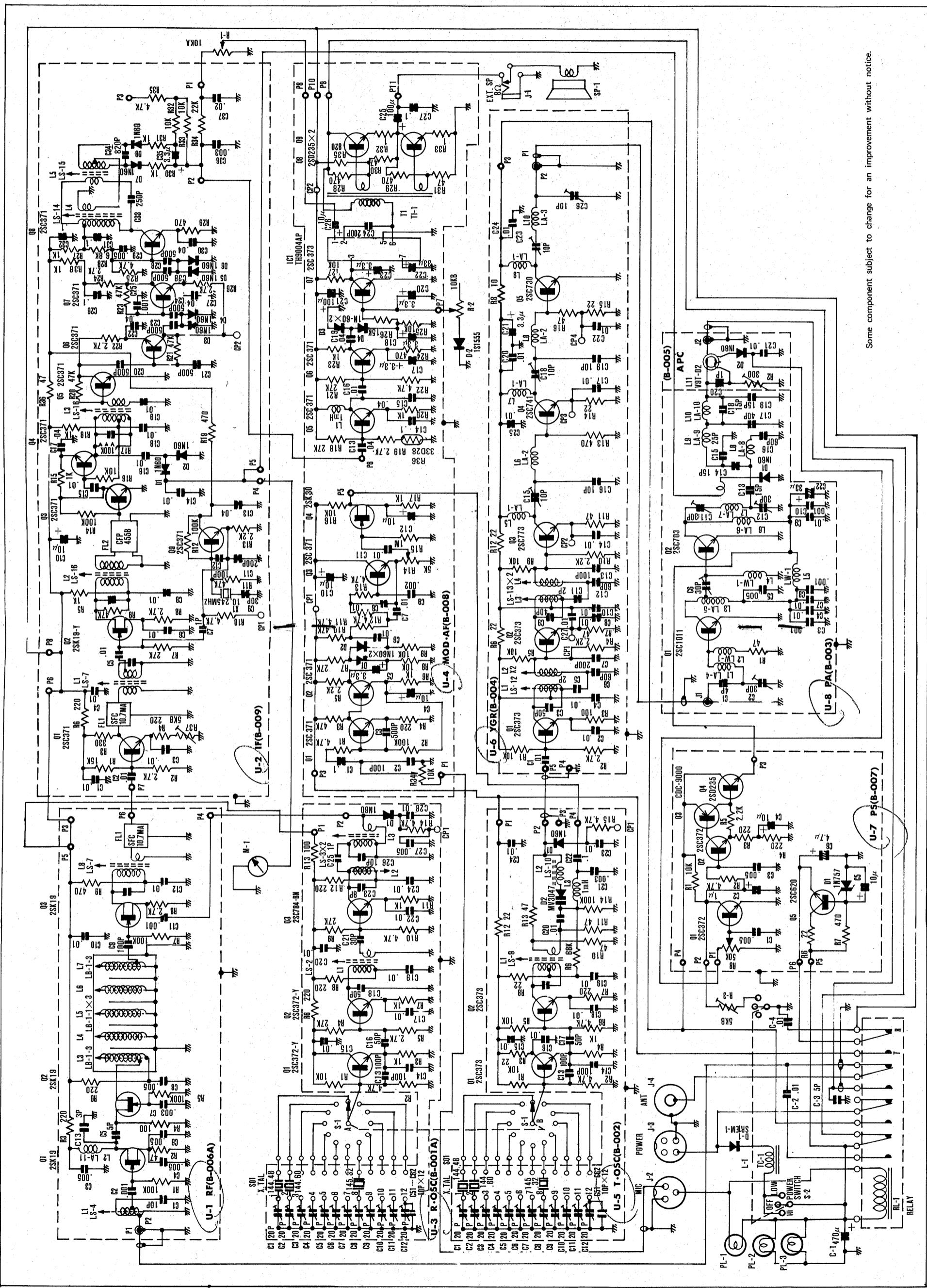

Some component subject to change for an improvement without notice.