

ICOM

INSTRUCTION MANUAL

144 MHz FM TRANSCEIVER

IC-2000
IC-2000H

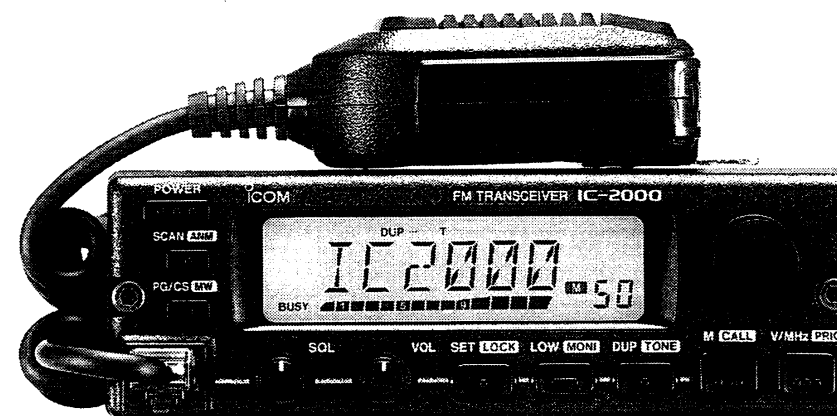

Icom Inc.



IMPORTANT

READ ALL INSTRUCTIONS carefully and completely before using the transceiver.

SAVE THIS INSTRUCTION MANUAL – This instruction manual contains important safety and operating instructions for the IC-2000 (10 W type) and IC-2000H (50 W type).

EXPLICIT DEFINITIONS

The explicit definitions described below apply to this instruction manual.

WORD	DEFINITION
WARNING	Personal injury, fire hazard or electric shock may occur.
CAUTION	Equipment damage may occur.
NOTE	If disregarded, inconvenience only. No risk of personal injury, fire or electric shock.

CAUTIONS

⚠ WARNING! NEVER connect the transceiver to an AC outlet. This may pose a fire hazard or result in an electric shock.

NEVER connect a power source of more than 16 V DC. This connection will ruin the transceiver.

NEVER cut the DC cable between the DC plug and fuse holder. If an incorrect connection is made after cutting, the transceiver might be damaged.

NEVER place the transceiver where normal operation of the vehicle may be hindered or where it could cause bodily injury.

NEVER allow children to touch the transceiver.

NEVER expose the transceiver to rain, snow or any liquids.

USE Icom's microphone only (supplied or optional). Other manufacturers microphones have different pin assignments and may damage the transceiver.

DO NOT connect the transceiver to a power source using reverse polarity. This connection will not only blow fuses but may also damage the transceiver.

DO NOT use or place the transceiver in areas with temperatures below -10°C ($+14^{\circ}\text{F}$) or over $+60^{\circ}\text{C}$ ($+140^{\circ}\text{F}$) or, in areas subject to direct sunlight, such as the dashboard.

AVOID placing the transceiver against walls or putting anything on top of the transceiver. This will obstruct heat dissipation.

AVOID the use of chemical agents such as benzene or alcohol when cleaning, as they can damage the transceiver surfaces.

BE CAREFUL! The transceiver will become hot when operating continuously for long periods.

UNPACKING

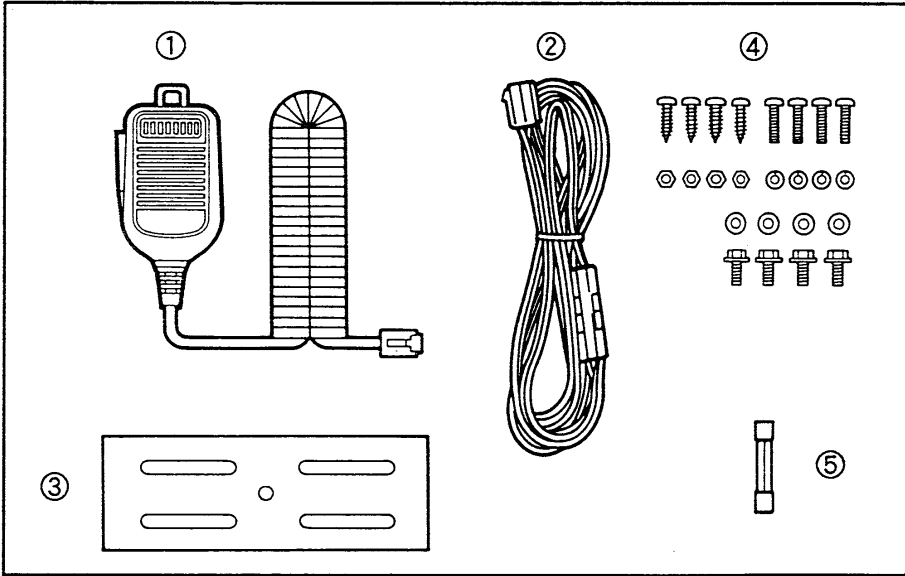

Accessories included with transceiver:	Qty.
① Microphone*	1
② DC power cable (OPC-346)	1
③ Mobile mounting bracket	1
④ Mounting screws, nuts, and washers	1 set
⑤ Fuse (20 A)	1

*U.S.A. version : HM-95 DTMF MICROPHONE
 Europe versions: HM-97 HAND MICROPHONE (with 1750 Hz encoder)
 Australia version: HM-96 HAND MICROPHONE

TABLE OF CONTENTS

IMPORTANT	i
EXPLICIT DEFINITIONS	i
CAUTIONS	i
UNPACKING	ii
TABLE OF CONTENTS	iii

1 PANEL DESCRIPTION	1-7
■ Front panel	1
■ Microphone	4
■ Function display	5
■ Rear panel	7

2 INSTALLATION	8
■ Location	8
■ Battery connection	8
◇ Notes for fixed station use	8

3 BASIC OPERATION	9-11
■ Mode selection	9
■ Lock function	9
■ Frequency setting via front panel	9
■ Frequency setting via microphone	10
■ Tuning step selection	10
■ Receive and transmit	11
◇ Monitor function	11
◇ Output power selection	11
◇ Other functions	11

4 SCRATCH PAD AND UP SWITCH REMOTE	12
■ Scratch pad memory	12
■ Up switch Remote	12

5 REPEATER OPERATION	13-14
■ Operation	13
■ Tone information	13
■ Subaudible tones	14
■ Offset frequency	14

6 MEMORY/CALL CHANNEL PROGRAMMING	15-18
■ General description	15
■ Programming during selection	15
■ Programming after selection	16
■ Moving a memory or call channel	16
■ Alphanumeric display	17
◇ Notes for display switching	17
■ Programming a note	18
■ Memory area setting	18

7 SCAN OPERATION	19-21
■ Scan types	19
■ Scan resume	19
■ Full scan and programmed scan	20
■ Memory scan	21
■ Memory skip	21

8 PRIORITY WATCH	22	◇ Message standby (receive)	31
■ General description	22	◇ Memory transmission	31
■ VFO/memory or VFO/call	22	◇ Manual transmission	31
■ VFO/memories	22		
9 DTMF REMOTE	23–24		
10 TONE SQUELCH AND POCKET BEEP	25	13 OTHER FUNCTIONS	32–35
■ General description	25	■ Display backlight	32
■ Pocket beep function	25	■ Beep tones	32
■ Tone squelch function	25	■ Auto-repeater	33
		■ Time-out timer	33
		■ Auto power-off	34
		■ Opening message	34
		■ Repeater lockout	35
		■ Demonstration display	35
11 PAGER AND CODE SQUELCH	26–29	14 OPTIONAL UNIT INSTALLATION	36
■ General description	26		
■ Code programming	27	15 MAINTENANCE	37–38
◇ Pre-operation	27	■ Troubleshooting	37
◇ Code channel information	27	■ Partial resetting	38
◇ Programming	27	■ Resetting the transceiver	38
■ Code squelch	28		
■ Pager function	29	 	
◇ Calling a specific station	29	16 MODE ARRANGEMENT	39–40
◇ Waiting for a call	29		
 		17 SPECIFICATIONS	41
12 MESSAGE TRANSMIT/RECEIVE	30–31	18 OPTIONS	42
■ General description	30		
■ Message programming	30		
■ Operation	31		

1. PANEL DESCRIPTION

■ Front panel

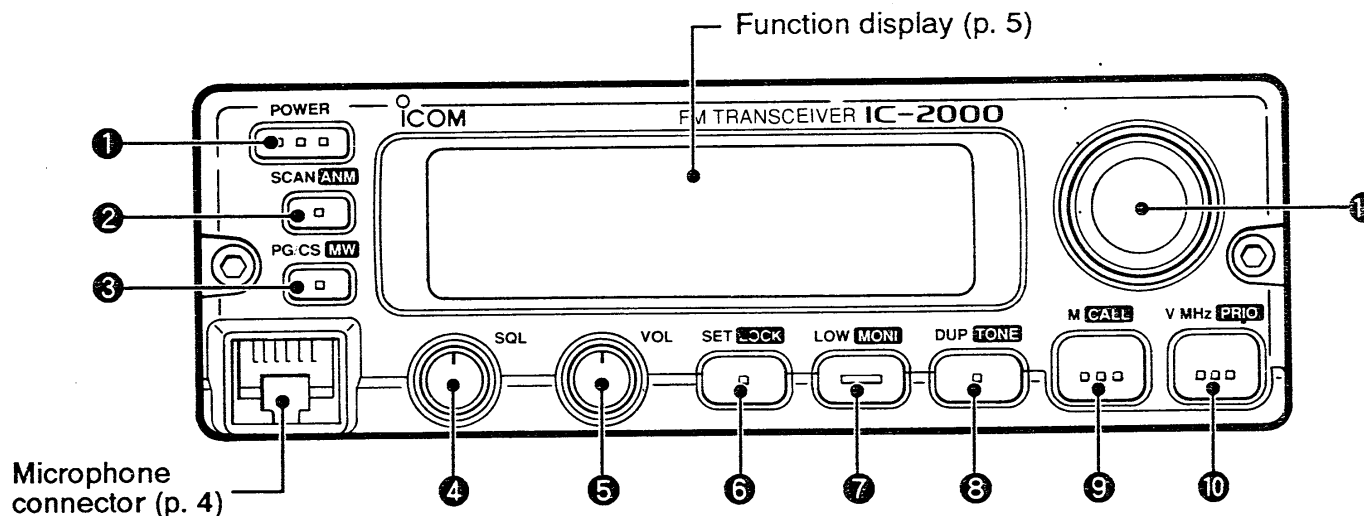

❶ POWER SWITCH [POWER]

- Push to turn power ON and OFF.
- Some settings can be performed at power ON when other switches are pushed simultaneously. (pgs. 12, 32, 35, 38)

❷ SCAN SWITCH [SCAN•ANM]

SCAN/ANM Starts and stops a scan. (pgs. 20, 21)



- Full scan, programmed scan and memory scan are available.
- Tone decode scan is also available when an optional tone squelch is in use. (p. 13)

- Toggles frequency display and alphanumeric display in memory mode or call channel. (p. 17)
- No function in VFO mode.
- Turn the message function ON and OFF for sending or receiving messages when the optional pager or code squelch function is in use. (pgs. 30, 31)

❸ PAGER/CODE SQUELCH SWITCH [PG/CS•MW]

PG/CS/MW Selects pager (p. 29), code squelch (p. 28) and



- “DTMF Remote” function (p. 23) in sequence.
- An optional UT-101 DTMF UNIT is necessary to use the above functions.

- PG/CS MW**  • Programs the selected contents such as frequency, etc. into a memory channel (or call channel/VFO) (p. 16).
- Push and hold*
- The memory channel number which you want to program can be changed if this switch is released after hearing one short and long beep. (p. 15)
 - In this case, push the switch again after channel selection.

4 SQUELCH CONTROL [SQL]

Varies the squelch threshold point for noise mute.

5 VOLUME CONTROL [VOL]

Varies the audio output level.

6 SET MODE SWITCH [SET•LOCK]

- SET LOCK**  • Enters set mode and advances the set mode display. ([LOW] reverses selection.) (p. 40)
- Push*
- Enters alphanumeric programming condition when an alphanumeric display is selected. Once entered, the switch moves the cursor to the left. (p. 18)
 - Enters pager code setting display when pager or code squelch is in use. Once entered, the switch moves the cursor to the left. (p. 27)

- SET LOCK**  • Activates the lock function to prevent accidental frequency change. (p. 9)
- Push and hold*
- Enters initial set mode when pushed and held at power ON. (p. 40)

7 LOW POWER SWITCH [LOW•MONI]

- LOW MONI**  • Selects low (5 W), middle (10 W) and high power (50W*) (p. 11).
- Push*
- LOW★ appears when selecting middle* power and no indicator appears for high power.
 - *Thailand version has no middle power and high power is 10 W.
 - Reverses the set mode display when entering set mode (p. 40) or moves cursor to the right when selecting an alphanumeric programming condition (p. 18) or pager setting display. (p. 27)

- LOW MONI**  Opens the squelch manually to check the operating frequency condition. (p. 11)
- Push and hold*
- Checks the transmit frequency simultaneously when selecting the duplex function.

1 PANEL DESCRIPTION

8 DUPLEX SWITCH [DUP-TONE]

DUP TONE Selects -duplex, +duplex or cancels duplex (simplex) in sequence. (p. 13)



Push - An auto-repeater function is available to activate duplex with/without tone encoder automatically when selecting a repeater frequency (U.S.A. version only). (p. 33)

DUP TONE • Turns the subaudible tone encoder ON and OFF. (p. 13)



Push and hold • Selects tone encoder, pocket beep, tone squelch, and non-tone operation in sequence when an optional UT-85 TONE SQUELCH UNIT is installed. (pgs. 13, 25)

9 MEMORY SWITCH [M-CALL]

M CALL Selects memory mode. (p. 9)



Push - 50 memory channels with alphanumeric display and channel area restriction are available. (p. 18)

M CALL Selects the call channel. (p. 9)



Push and hold - After selecting the call channel, a scratch pad memory can be called with the tuning dial (or [UP]/[DN] switch). The scratch pad memories retain transmitted frequencies for both simplex and duplex. (p. 12)

10 VFO SWITCH [V/MHz-PRIO]

V/MHz PRIO • Selects VFO mode. (p. 9)



Push • Selects the MHz steps for quick tuning when pushed again. (p. 9)
- Frequency below 100 kHz disappears at this time.

V/MHz PRIO Starts and stops the priority watch. (p. 22)



Push and hold - The priority watch checks the selected memory channel(s) or call channel once every 5 sec. during VFO operation.

11 TUNING DIAL

- Selects the operating frequency or memory channel in VFO or memory mode, respectively.
- Changes the contents of the selected item in set mode and initial set mode.
- Changes the alphanumeric contents when selecting the alphanumeric programming condition.

Microphone

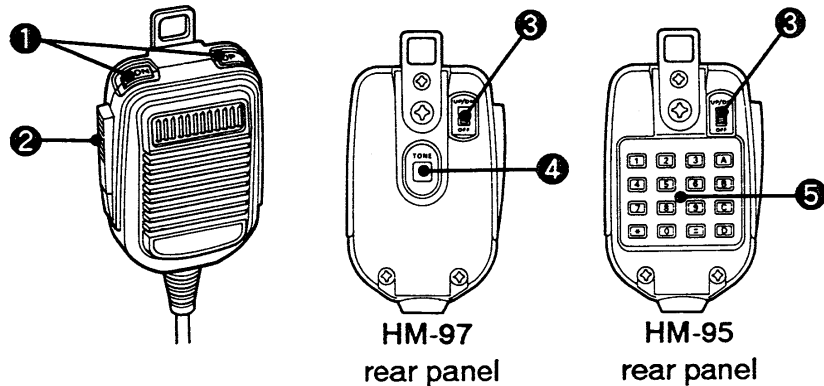

1 UP/DOWN SWITCHES [UP]/[DN]

- Change the frequency or memory channel in VFO or memory mode respectively.
 - Selects scratch pad memory when selecting the call channel.
 - [UP] for simplex and [DN] for duplex.
 - Starts and stops the scan function when pushed for 1 sec.
 - When the “Up switch Remote” is assigned, [UP] activates the programmed function and [DN] starts scan.
 - When the “DTMF Remote” is in standby*, [UP] activates the remote control function. (HM-95 only, since a DTMF encoder is necessary for control.)
- *An optional UT-101 DTMF UNIT is necessary.

2 PTT SWITCH

Push and hold to transmit; and release to receive.

3 LOCK SWITCH [UP/DN OFF]

Deactivates the [UP]/[DN] switch function to prevent accidental input.

4 TONE CALL SWITCH [TONE] (HM-97 only)

Push and hold to transmit a 1750 Hz tone burst signal for repeater access.

5 DTMF KEYPAD (HM-95 only)

Sends a DTMF code while pushing the PTT switch.

◇ Microphone connector (front panel view)

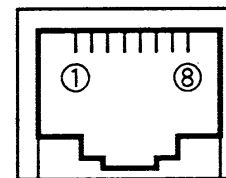

- ① + 8 V DC output
- ② Frequency up/down
- ③ AF detector output
- ④ PTT
- ⑤ GND (Microphone ground)
- ⑥ MIC (Microphone input)
- ⑦ GND
- ⑧ NC (No connection)

1 PANEL DESCRIPTION

■ Function display

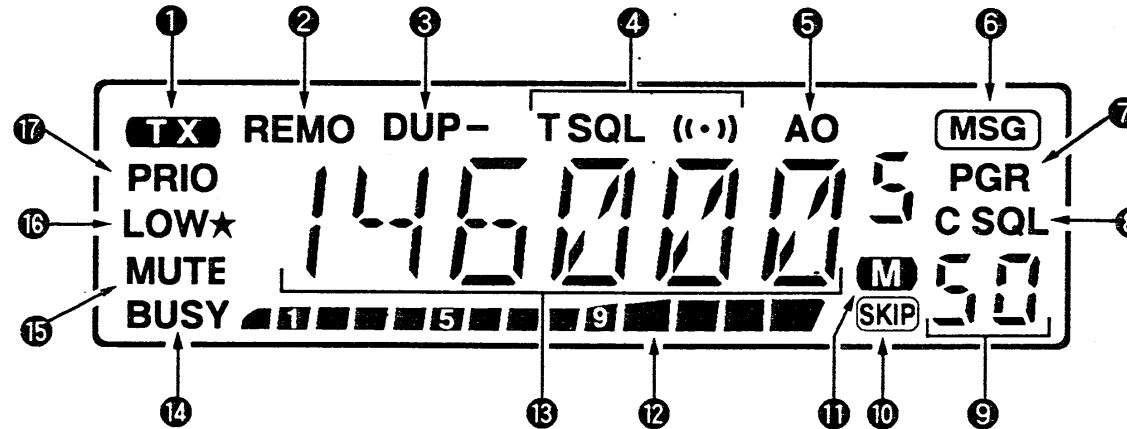

① TRANSMIT INDICATOR (p. 11)

Appears while transmitting.

② REMOTE INDICATOR (pgs 23, 24)

Appears while the "DTMF Remote" is in standby and flashes while the function is activated.

- "DTMF Remote" can be used when the optional UT-101 DTMF UNIT is installed.

③ DUPLEX INDICATOR (p. 13)

"DUP - " or "DUP" appears during semi-duplex operation (repeater operation).

④ TONE INDICATOR

- "T" appears while the subaudible tone encoder is in use. (p. 13)
- "TSQL" appears while the optional tone squelch function is in use. (p. 25)
- "TSQL ((·))" appears while the optional pocket beep function is in use. (p. 25)

⑤ AUTO POWER-OFF INDICATOR (p. 34)

Appears while the auto power-off function is in use.

⑥ MESSAGE FUNCTION INDICATOR (pgs. 30, 31)

Appears while the optional message function is in use.

7 PAGER INDICATOR (pgs. 26–29)

Appears while the optional pager function is in use.

8 CODE SQUELCH INDICATOR (pgs. 26–28)

Appears while the optional code squelch function is in use.

9 MEMORY CHANNEL READOUT

Shows the selected memory channel numbers (p. 15) or other information as below

 While the lock function is in use. (p. 9)

 When the call channel is selected. (p. 9)

 . When the scratch pad memory (simplex) is selected. (p. 12)

 . When the scratch pad memory (duplex) is selected. (p. 12)

 VFO mode is selected from the call channel.

10 SKIP INDICATOR (p. 21)

Appears when the displayed memory channel is specified as a skip channel.

11 MEMORY INDICATOR (p. 15)

Appears when memory mode is selected.

12 S/RF METER (p. 11)

- Shows the relative signal strength while receiving.
- Shows the output power selection while transmitting.

13 FREQUENCY READOUT

Shows the operating frequency, set mode contents, etc.

14 BUSY INDICATOR (p. 11)

Appears when a signal is received or the squelch is open.

15 AUDIO MUTE INDICATOR (p. 24)

Appears while the optional audio mute function is activated.

- Audio mute function can be used via the “DTMF Remote.”

16 LOW POWER INDICATOR (p. 11)

“LOW” appears while low power is selected, “LOW ★ ” appears while middle power is selected.

- Thailand version has no middle power.

17 PRIORITY INDICATOR (p. 22)

Appears while the priority function is in use.

1 PANEL DESCRIPTION

■ Rear panel

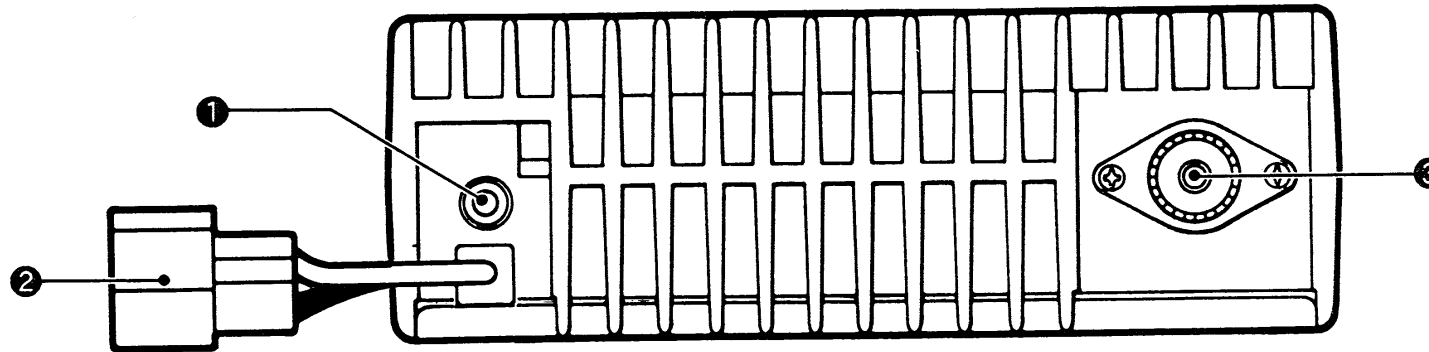

① EXTERNAL SPEAKER JACK [EXT SP]

Accepts a 4–8 Ω speaker, if required.
- Audio output power is more than 2.4 W.

② DC POWER RECEPTACLE [DC13.8V]

Accepts 13.8 V \pm 15% DC with the supplied DC power cable.
- 11 A or more current capacity is necessary.

NOTE: DO NOT use a cigarette lighter socket as a power source when mounting in a vehicle. The plug may cause voltage drops and ignition noise may be superimposed onto transmit or receive audio.

③ ANTENNA CONNECTOR [ANT]

Connect a 50 Ω antenna with a PL-259 connector and a 50 Ω coaxial cable.

ANTENNA INFORMATION

For radio communications, the antenna is of critical importance, along with output power and sensitivity. Select a good antenna and mounting location. The transceiver accepts a 50 Ω antenna and less than 1.5:1 of Voltage Standing Wave Ratio (VSWR). High SWR values not only may damage the transceiver but also lead to TVI or BCI problems.

■ Location (in case of a vehicle)

Select a location which can support the weight of the transceiver and does not interfere with driving in any way.

NEVER place the transceiver where normal operation of the vehicle may be hindered or where it could cause bodily injury.

NEVER place the transceiver where air bag operation may be obstructed.

DO NOT place the transceiver where hot or cold air blows directly onto it.

AVOID placing the transceiver in direct sunlight.

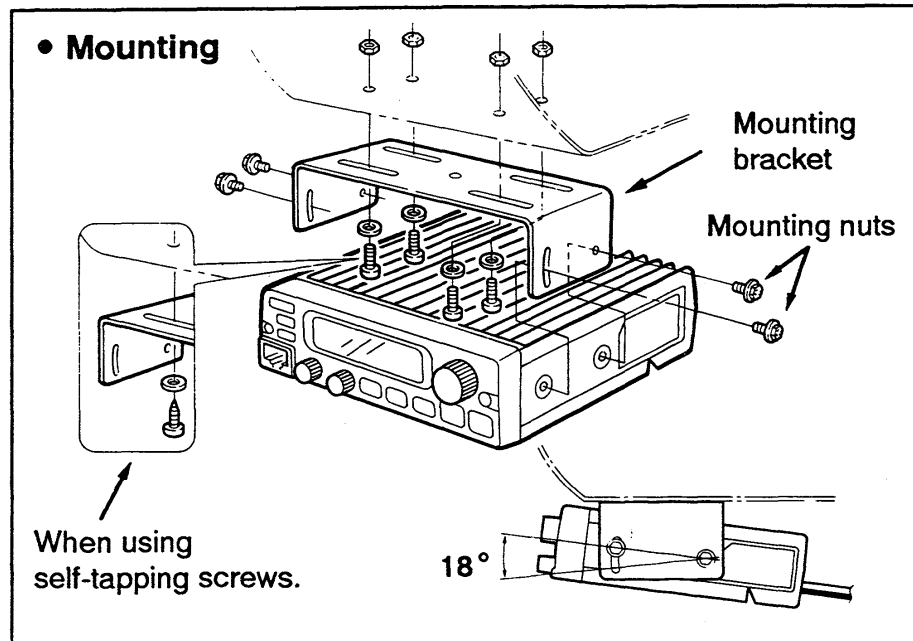

■ Battery connection

- **NEVER** connect the transceiver directly to a 24 V battery.
- Attach a rubber grommet when passing the DC power cable through a metal plate to prevent short circuits.

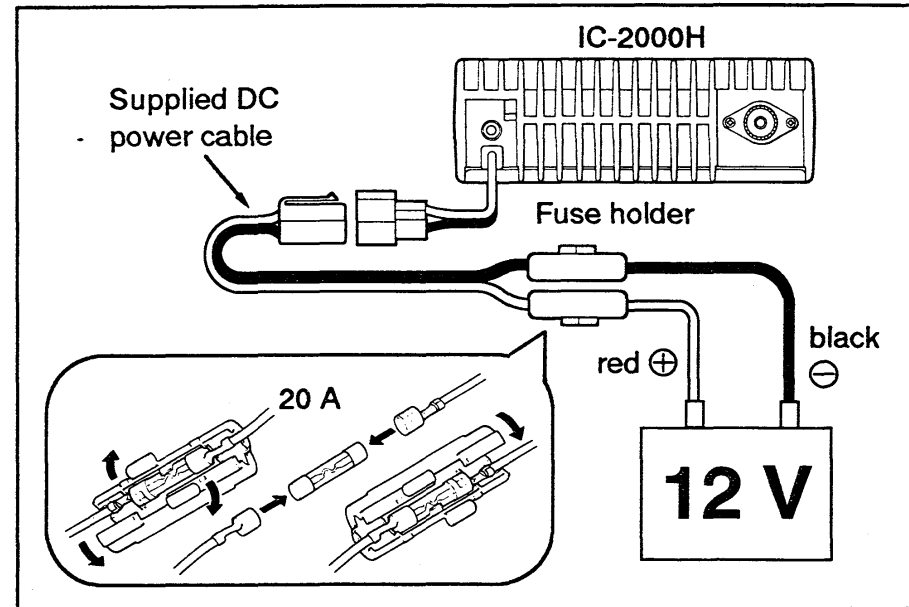

◆ Notes for fixed station use

- Use a regulated 13.8 V DC power supply with more than 11 A capability.
- Turn power OFF for both the transceiver and DC power supply when connecting or disconnecting the AC power cable to an AC outlet.

Mode selection

The transceiver has 3 major modes—① VFO, ② memory, and ③ call channel. These selections can be performed via large switches under the tuning dial.

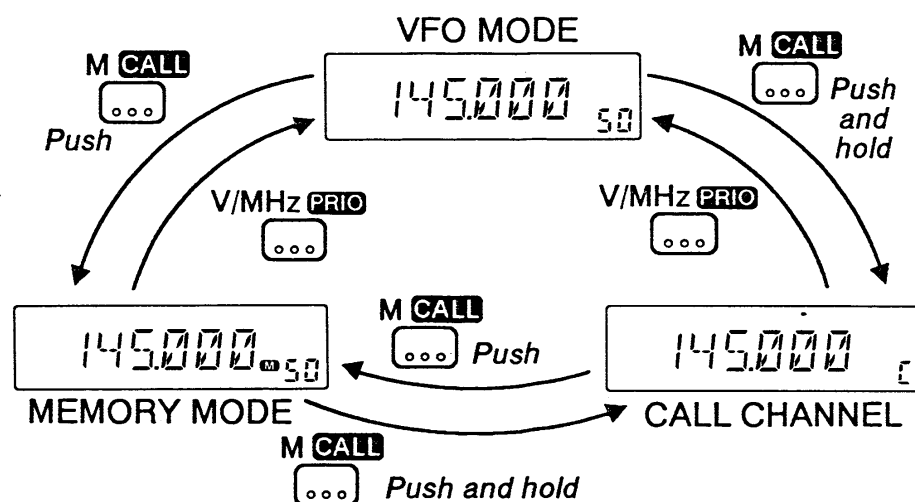

Lock function

To prevent accidental frequency or channel changes and unnecessary function access, use the lock function.

Push and hold [SET•LOCK] for 2 sec. to activate the lock function.

- [PTT], [MONI], [POWER], and [SET•LOCK] are not locked.

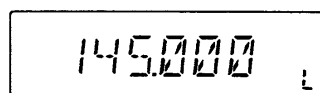

"L" shows that the Lock function is ON

SET LOCK

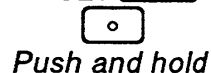

Push and hold

Frequency setting via front panel

The frequency can be set in VFO mode. The tuning dial acts as a channel selector in other modes. The transceiver has "MHz" steps and user-programmable tuning steps for convenient frequency setting.

- ① Push the [POWER] switch to turn power ON.
 - The opening message appears for 1 sec. at power ON. The message can be turned OFF (p. 34) and can be changed, if desired. (p. 30)
- ② Push [V/MHz] to select VFO mode.
 - When VFO mode has been selected already, the following "MHz" step display appears. In this case, push [V/MHz] again.
- ③ Rotate the tuning dial to set the frequency according the preset tuning step.
- ④ For 1 MHz tuning, push [V/MHz] again, then rotate the tuning dial.

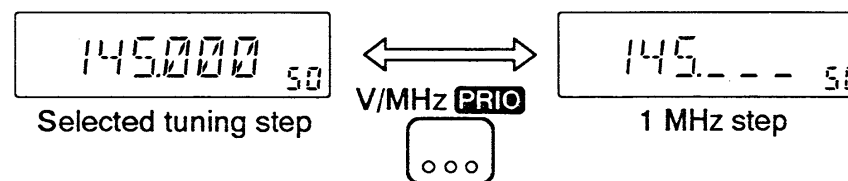

■ Frequency setting via microphone

The operating frequency or memory channel can be selected via the hand microphone. Push [UP] or [DN] to increment or decrement the frequency, according to the selected tuning steps, or the memory channel.

- Be sure [LOCK] on the microphone is set to OFF.
- Pushing [UP] or [DN] for more than 0.5 sec. will activate a scan.
- If a scan is started, push [UP] or [DN] again to stop it.

/// **NOTE:** When “Up switch Remote” (p. 12) is in use or “DTMF Remote” (p. 23) is in standby, [UP] or [DN] cannot be used for frequency setting.

“**Up Switch Remote**” can be used to assign a desired switch to the microphone’s [UP] switch. In this case, the [DN] switch activates scan function.

“**DTMF Remote**” allows keypad frequency entry, VFO/memory/call selection, etc. using a DTMF encoder. An optional HM-95 DTMF MICROPHONE* and UT-101 DTMF UNIT are necessary to use this function.

* Supplied for the U.S.A. version.

Note that the Thailand version has no “DTMF Remote” capability.

■ Tuning step selection

USING SET MODE

Tuning steps are the minimum frequency change increments when you rotate the tuning dial or push the [UP]/[DN] switches on the microphone. The following tuning steps are available.

- 5, 10, 12.5, 15, 20, 25, 30, 50 kHz

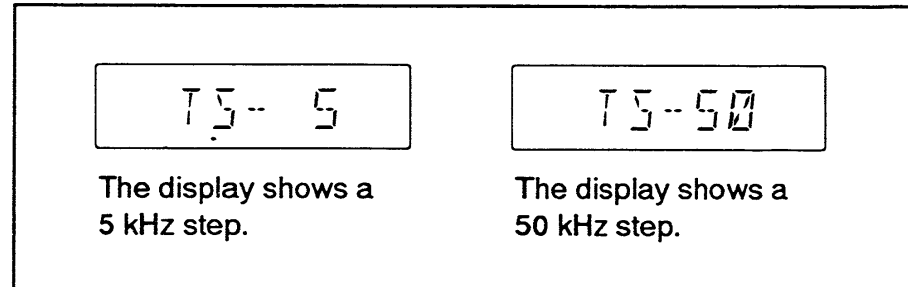

- ① Select VFO mode with the [V/MHz] switch.
- ② Push [SET] one or more times until “TS” appears as shown above.
 - Refer to page 40 for set mode arrangement if required.
 - Pushing [LOW] reverses the order of selection.
 - Cancel pager or code squelch in advance. (pgs. 28, 29)
- ③ Rotate the tuning dial to select the desired tuning step.
- ④ Push [DUP] to exit set mode.

/// **NOTE:** For convenience, select a tuning step that matches the frequency intervals of repeaters in your area.

3 BASIC OPERATION

Receive and transmit

CAUTION: Transmitting without an antenna may damage the transceiver.

NOTE: To prevent interference, listen on the frequency before transmitting by pushing [LOW•MONI].

- ① Push [POWER] to turn power ON.
- ② Set the squelch and audio levels.
 - Rotate [SQL] counterclockwise until noise is emitted. (Squelch opens.)
 - Rotate [VOL] to adjust the audio output level.
 - Rotate [SQL] clockwise until noise is muted.
- ③ Rotate the tuning dial to set the operating frequency.
- ④ When receiving a signal on the set frequency, squelch opens and the transceiver emits audio.
 - S/RF indicator shows the relative signal strength of the received signal.
- ⑤ To transmit, push and hold the PTT switch on the microphone, then speak into the microphone.
- ⑥ Release [PTT] to return to receive.

IMPORTANT: To maximize the readability of your transmit audio, pause a few sec. after pushing [PTT], hold the microphone 10 to 15 cm from your mouth, then speak into the microphone at your normal voice level.

◆ Monitor function

LOW MONI This function is used to listen to weak signals without disturbing the squelch setting or to open an optional squelch manually, such as tone squelch, pager, etc.



Push and hold

- Push and hold the [LOW•MONI] to open the squelch.
 - While duplex is in use, the repeater input frequency can be monitored simultaneously.

◆ Output power selection

LOW MONI The transceiver has 3 output power levels to suit your operating requirements. Low output power may reduce interference to other stations and reduces current consumption.

- Push [LOW•MONI] once or twice to select the output power.



Push

Selection	Indicator	S/RF meter	Output power
HIGH	nothing	■■■■■■■■■■■	50 W (10 W)
MIDDLE	LOW ★	■■■■■■■■■	10 W (N/A)
LOW	LOW	■■■■	5 W (5 W)

Bracketed values are for the Thailand version.

◆ Other functions

- Time-out timer (p. 33)
- Repeater lockout (p. 35)

■ Scratch pad memory.

The transceiver automatically memorizes operating frequencies, separate from regular memory channels, when transmitting in VFO mode. There are 2 scratch pad memories, one for simplex and the other for duplex.

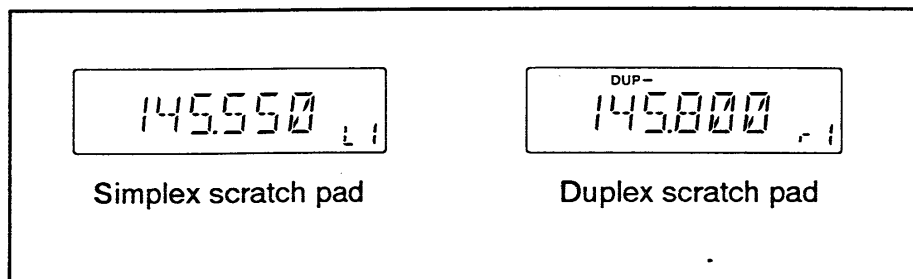

- ① Push and hold [M•CALL] to select the call channel.
- ② Rotate the tuning dial:
 - clockwise (up) for duplex scratch pad.
 - counterclockwise (down).... for simplex scratch pad.

- The microphone [UP]/[DOWN] switches may be useful for pad selection when no remote control is in use.
- ③ To exit the scratch pad memory, push [V/MHz] or [M•CALL].

■ Up switch Remote

The [UP] switch on the microphone can be programmed to control one of the switches on the front panel. By using this function, you can easily and quickly access an often-used switch without stretching to reach the transceiver front panel.

- ① Push [POWER] to turn power OFF.
- ② Be sure that the [LOCK] switch on the microphone is set to the OFF position.
- ③ While pushing [UP] on the microphone and the desired switch on the front panel, turn power ON.
 - The [UP] switch functions as the desired switch, including its secondary function (when pushing and holding [UP]).
- ④ To cancel this function, turn power OFF; then, while pushing [UP], turn power ON.

- This function cannot be activated when “DTMF Remote” is in standby. (pgs. 23, 24). Therefore, assignment of [PG/CS•MW] is not recommended when an optional UT-101 is installed.
- Once the [UP] switch is programmed, the [DN] switch functions as a scan start switch; and, the tuning dial changes the scanning direction.

■ Operation

A repeater amplifies received signals and re-transmits them at a different frequency. When using a repeater, the transmit frequency is shifted from the receive frequency by the offset frequency. (p. 14) It is convenient to program repeater information into a memory channel. (p. 15)

- ① Set the receive frequency (repeater output frequency).
- ② Push [DUP] one or more times to select -duplex or + duplex.
 - "DUP -" or "DUP" appears to indicate the transmit frequency as minus shift or plus shift, respectively.
 - When the auto-repeater function is turned ON (this function is available for the U.S.A. version only), steps ② and ③ are not necessary.
- ③ Push and hold [DUP•TONE] to activate the subaudible tone encoder, according to repeater requirements.
 - Refer to the page at right for tone frequency setting.
- ④ Push and hold [PTT] to transmit.
 - The displayed frequency automatically changes to the transmit frequency (repeater input frequency).
 - If "O.FF" appears, check the offset frequency. (p. 14)
- ⑤ Release [PTT] to receive.
- ⑥ Push and hold [LOW•MONI] to check the repeater input frequency and see whether the other station's transmit signal can be directly received or not.

■ Tone information

DTMF TONES (Autopatch operation; U.S.A. version only)
Some repeaters provide an autopatch service to connect to a telephone line. To use the autopatch service, DTMF tones may need to be transmitted at first.

While pushing the [PTT] switch, push the microphone's digit keys in sequence to transmit DTMF tones.

- The HM-95 is necessary for non-U.S.A. versions.
- An optional HM-77 is available to memorize the DTMF code, up to 22 digits × 14 channels.

1750 Hz TONE

(HM-97 supplied with Europe and Italy versions only)
Push and hold [TONE] on the microphone for 1-3 sec. to transmit a 1750 Hz tone signal for accessing a repeater.

TONE SCAN

(an optional UT-85 is necessary to use this function)
To decode the used tone frequency, the tone scan is available as an option.

To use the tone scan:

- ① Push and hold [DUP•TONE] several times to indicate "T SQL".
- ② Push [SCAN] to start the tone scan.

■ Subaudible tones USING SET MODE

50 different subaudible tone frequencies are available.

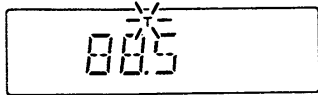

The display shows an 88.5 Hz subaudible tone frequency.

- ① Push [SET] one or more times until "T" and a tone frequency appear as shown above.
 - Pushing [LOW] reverses the order of selection.
 - During alphanumeric indication, push and hold [SCAN•ANM] to select the frequency in advance.
 - Cancel pager or code squelch with [PG/CS] if in use.
 - When no operation is performed for 30 sec., the transceiver exits set mode automatically
- ② Rotate the tuning dial to set the desired frequency.
 - The tone frequency is independently programmed into each mode or channel.
- ③ Push [DUP] to exit set mode.

• Subaudible tone frequency list

(Unit: Hz)

67.0	79.7	94.8	110.9	131.8	156.7	171.3	186.2	203.5	229.1
69.3	82.5	97.4	114.8	136.5	159.8	173.8	189.9	206.5	233.6
71.9	85.4	100.0	118.8	141.3	162.2	177.3	192.8	210.7	241.8
74.4	88.5	103.5	123.0	146.2	165.5	179.9	196.6	218.1	250.3
77.0	91.5	107.2	127.3	151.4	167.9	183.5	199.5	225.7	254.1

■ Offset frequency USING SET MODE

0.005 to 20.000 MHz offset frequencies are available.

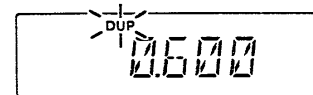

The display shows a 0.6 MHz (600 kHz) offset frequency.

- ① Push [SET] one or more times until "DUP" and an offset frequency appear on the display.
 - Refer to step ① at left for set mode notes.
- ② Rotate the tuning dial to set the desired offset frequency.
 - The offset frequency is independently programmed into each mode or channel.
 - Selectable step increment is the same as the preset tuning step. (p. 10)
 - Use [V/MHz] for quick MHz setting.
- ③ Push [DUP] to exit set mode.

OTHER CONVENIENT FUNCTIONS:

Auto-repeater function (U.S.A. version only) — Duplex with/without tone are selected automatically when the repeater frequency is selected (p. 33).

Repeater lockout — Transmit is inhibited when the frequency is busy and/or includes a tone (p. 35).

General description

The transceiver has 1 call channel and 50 regular memory channels plus 6 scan edge memory channels on each band; each of these can be individually programmed with the following data.

- Operating frequency
- Duplex direction (DUP or DUP-) and its offset frequency
- Subaudible tone encoder (or optional tone squelch) ON/OFF and its frequency
- Skip information (except for the scan edge memory channels)

◇ Memory channel notes

- The number of memory channels can be restricted in set mode (see p. 18).
- Memory channels cannot be erased.
- All memory channels are set as skip channels initially. However, the skip information is erased automatically when a new frequency is programmed.

Programming during selection

- ① Select VFO mode with the [V/MHz] switch.
- ② Set the desired frequency to be programmed into a memory channel (or call channel).
 - When programming repeater information, such as tone and offset frequencies separately, set them using set mode.
- ③ Push and hold [PG/CS·MW] until short and long beeps can be heard. (for approx. 0.5 sec.)
 - If more than 2 short beeps are heard and channel number flashing is stops, the displayed channel number is used for programming.
- ④ Rotate the tuning dial to select the desired memory channel to be programmed.
- ⑤ Push [PG/CS·MW] again to perform memory writing.
 - 2 short beeps are emitted.

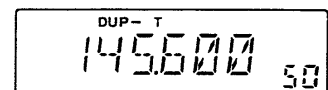
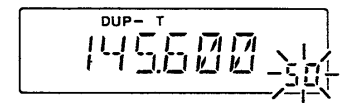
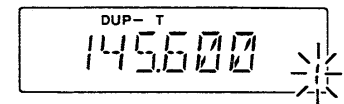
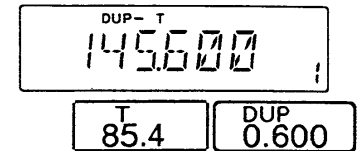

■ Programming after selection

Before overwriting a memory channel, content confirmation is useful. In such a case, program the memory channel in the following way.

- ① Select the memory channel (or call channel) to be programmed.

- Push [M•CALL], then rotate the tuning dial to select a memory channel (or push and hold [M•CALL] to select the call channel).

- If the desired number does not appear, memory channel area may be restricted. (p. 18)

- ② Push [V/MHz] to select VFO mode.

- ③ Set the frequency and repeater information etc. in VFO mode.

- ④ Push and hold [PG/CS•MW] until 2 short beeps sound (after 1 short and 1 long beep: total 4 beeps).

- The memory is programmed and skip information in the memory channel is canceled automatically.

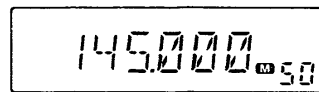

Push for memory mode
Push and hold for call channel

Select VFO mode

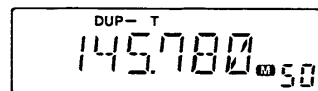
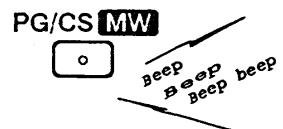
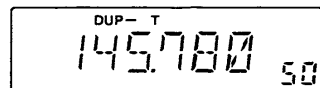

When a memory channel is selected.

■ Moving a memory or call channel

A programmed frequency in a memory or call channel can be moved to another channel or to VFO for editing convenience. Movement to restricted channels is also possible to hide frequencies.

- ① Select the desired memory channel (or call channel).

- ② Push and hold [PG/CS•MW] until short and long beeps can be heard. (for approx. 0.5 sec.)

- If more than 2 short beeps are heard and channel number flashing stops, the memory contents are transferred to the VFO.

- ③ Rotate the tuning dial to select the desired memory channel to move to.

- ④ Push [PG/CS•MW] again to perform memory writing.

 - 2 short beeps are emitted.

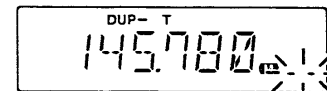
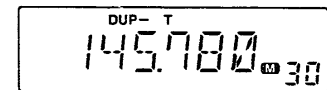

Memory channel number flashes.
"--" means VFO mode.

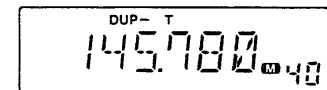
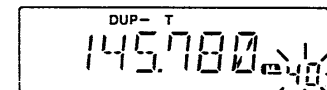

6 MEMORY/CALL CHANNEL PROGRAMMING

■ Alphanumeric display

Alphanumeric notes can be displayed instead of the operating frequency while in memory mode or on the call channel. The notes may be useful for holding repeater names, call signs, etc.

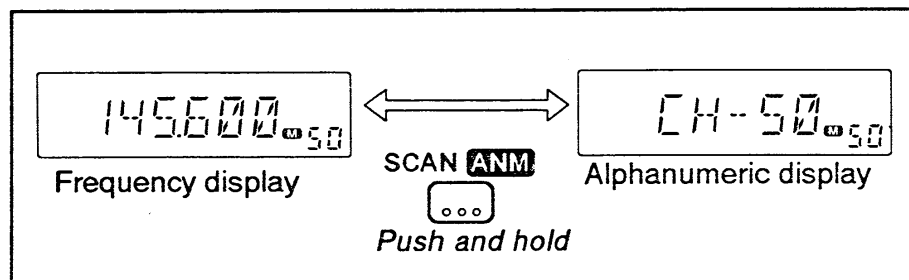

- ① Select the desired memory or call channel.
 - Push [M•CALL], then rotate the tuning dial to select the memory channel (or push and hold [M•CALL] to select the call channel).
 - Number of memory channels may be restricted if the desired number does not appear.
- ② Push and hold [SCAN•ANM] until the display changes as shown above.

◇ Notes for display switching

- When an optional pager or code squelch is in use, the [SCAN•ANM] switch turns the message transmit/receive function ON and OFF.
- Channel number is programmed for each channel note by default.
- It is not possible to switch all memory channels simultaneously.
- While using the monitor function, the display shows the frequency even when the alphanumeric display is selected.
- Scan edge channels cannot be selected with the alphanumeric display.

■ Programming a note

Up to 6 characters can be programmed in each alphanumeric display. The following characters can be used for notes.

- 0 to 9, A to Z (capitals only), (space), <, >, +, -, =, *, /, Δ, μ, Σ

- ① Select the desired memory or call channel.
- Cancel the pager or code squelch if in use.
- ② Push and hold [SCAN•ANM] until an alphanumeric display is selected.
- ③ Push [SET] to enter the programming condition.
- When no operation is performed for 30 sec., the transceiver exits the condition automatically.
- ④ Push [SET] or [LOW] to move the cursor (blinking digit) to the desired position.
- ⑤ Rotate the tuning dial to select the desired character.
- ⑥ Push [DUP] to exit the programming condition.

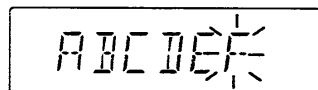
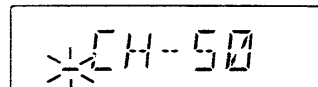
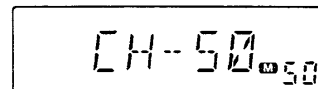
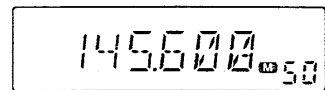

■ Memory area setting

- USING SET MODE

The range of usable memory channels can be specified. This function speeds up memory scan or memory channel selection. Memory area setting does not clear the memory contents.

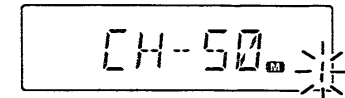
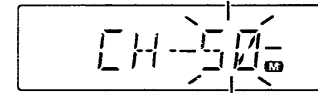

These displays show that memory channels 1 to 50 can be used.

- ① Push [SET] one or more times until "CH-50" or another number appears as shown above.
- Pushing [LOW] reverses the order of selection.
- When the display is alphanumeric, push and hold [SCAN•ANM] to select the frequency in advance.
- Cancel pager or code squelch with [PG/CS] if in use.
- When no operation is performed for 30 sec., the transceiver exits set mode automatically
- ② Rotate the tuning dial to set the desired number.
- ③ Push [SET]; then, rotate the tuning dial to set the other desired channel number.
- This sets the range of available memories.
- ④ Push [DUP] to exit set mode.

Scan types

The following scan types are available:

FULL SCAN

Repeatedly scans all frequencies over the entire band. Used as a simple default scan.

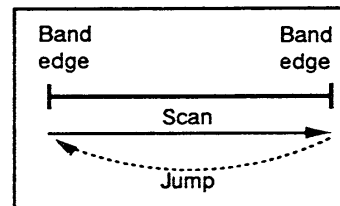

PROGRAMMED SCAN

Repeatedly scans between two user-programmed frequencies. Used for checking for frequencies within a specified range such as repeater output frequencies, etc. 3 pairs of scan edges are selectable for each band.

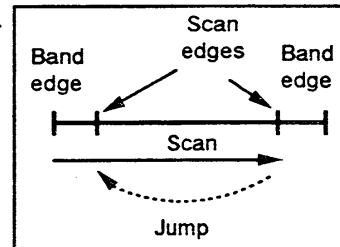

MEMORY SCAN

Repeatedly scans memory channels within the range of the selected memory area except skip channels. Used for checking often-called channels and bypassing normally busy channels such as repeater frequencies.

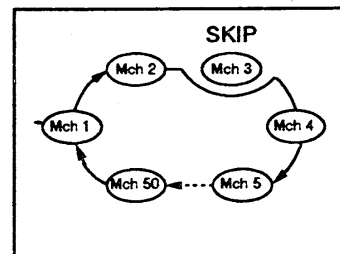

Scan resume

USING SET MODE

5 resume conditions are available: 3 timer scans, pause scan and empty scan. When receiving a signal, pause scan pauses until the signal disappears; timer scans pause for 5, 10 or 15 sec. Empty scan pauses until a signal appears.

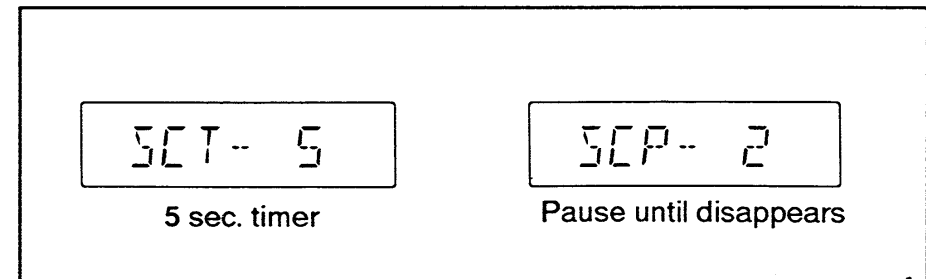

- ① Push [SET] one or more times until "SCT" or "SCP" appears on the display.
 - Refer to p. 40 for set mode notes.
- ② Rotate the tuning dial to set the desired condition.
 - SCT-5 : Scan pauses 5 sec. while receiving a signal.
 - SCT-10 : Scan pauses 10 sec. while receiving a signal.
 - SCT-15 : Scan pauses 15 sec. while receiving a signal.
 - SCP-2 : Scan pauses on a signal until it disappears and then resumes 2 sec. thereafter.
 - SCT-EP : Scan pauses on a non-busy frequency until a signal appears.
- ③ Push [DUP] to exit set mode.

Full scan and programmed scan

Programmed scan operates between frequencies pre-programmed scan into edge memory channels 1A/1b ... 3A/3b. Initially, band edge frequencies are programmed into these channels. Contents are changed in the same manner as memory programming. See pgs. 15, 16 for details.

- ① Select VFO mode with the [V/MHz] switch.
- ② Rotate the [SQL] to the threshold point.

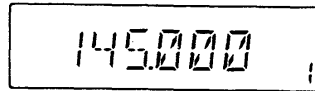

Skip steps ③ to ⑤ when already set.

- ③ Push [SET] once or more times to select the scan resume display and select the desired condition.

- See p. 19 for condition details.

- ④ Push [SET] once to select the desired scan edge pair or full scan range.

- ⑤ Push [DUP] to exit set mode.

USING SET MODE

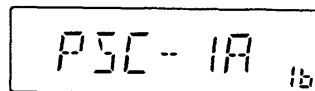
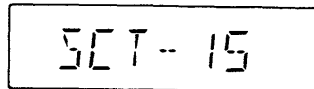

Programmed scan
(scan edge 1A/1b)

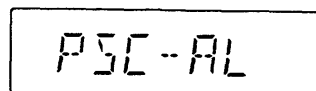

Full scan

- ⑥ Push and hold the microphone's [UP]/[DN] switch or push the transceiver's [SCAN] switch.

- When the optional tone squelch is in use, tone scan is started. (When not desired, turn tone squelch OFF in advance.)

- Memory channel readout shows the selected scan edges :

- P1: 1A/1b pair
- P2: 2A/2b pair
- P3: 3A/3b pair
- AL: full scan

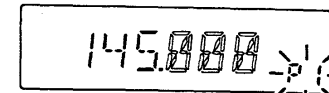
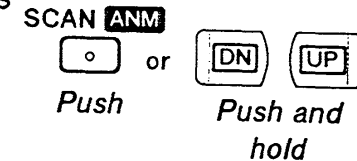

Programmed scan

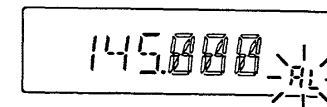

Full scan

- ⑦ To change the scanning direction, rotate the tuning dial in the desired direction.
- ⑧ To stop the scan, push [UP]/[DN] or [SCAN].

NOTE: When "Up Switch Remote" is in use, the [UP] switch on the microphone activates as programmed. In this case, the [DN] switch activates the scan.

7 SCAN OPERATION

Memory scan

Memory scan repeatedly scans memory channels within the range of the selected memory area (p. 18) except skip channels (described at right).

NOTE: All memory channels are set as skip channels by default. Program more than two memory channels (pgs 15, 16), skip information is canceled automatically in this case, or cancel the skip function for more than two memory channels in advance.

- ① Push [M•CALL] to select memory mode.
- ② Push and hold the microphone's [UP]/[DN] switch or push the transceiver's [SCAN] switch.
 - When the optional tone squelch is in use, tone scan is started. (When not desired, turn the tone squelch OFF in advance or start the scan on another channel.)
- ③ To change the scanning direction, rotate the tuning dial in the desired direction.
- ④ To stop the scan, push [UP]/[DN] or [SCAN].

Memory skip

USING SET MODE

The memory skip function speeds up the scan interval, checking only desired memory channels. Initially, all memory channels are specified as skip channels. Programming a memory channel automatically cancels its skip setting.

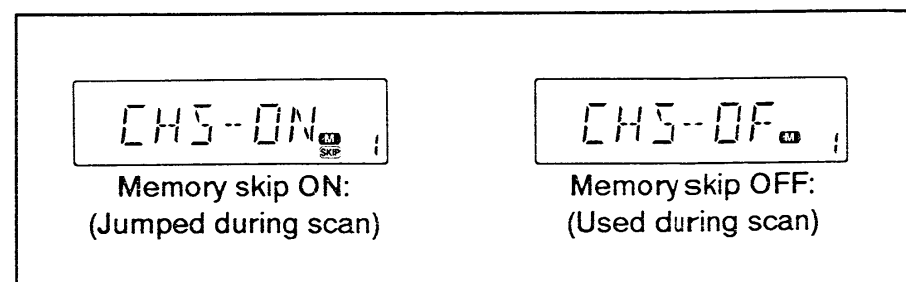

- ① Select the desired memory channel:
 - Push [M•CALL], then rotate the tuning dial to select.
- ② Push [SET] one or more times until "CHS" appears as shown above.
 - See p. 40 for set mode notes.
- ③ Rotate the tuning dial to turn the skip function ON or OFF on the selected channel as above.
- ④ Push [DUP] to exit set mode.

NOTE: The scan edge memory channels (1A–3b) cannot be specified as skip channels, however, they are skipped during memory scan, regardless.

■ General description

Every 5 sec. priority watch monitors a selected memory or call channel while you operate on a VFO frequency. The watch resumes according to the selected scan resume condition.

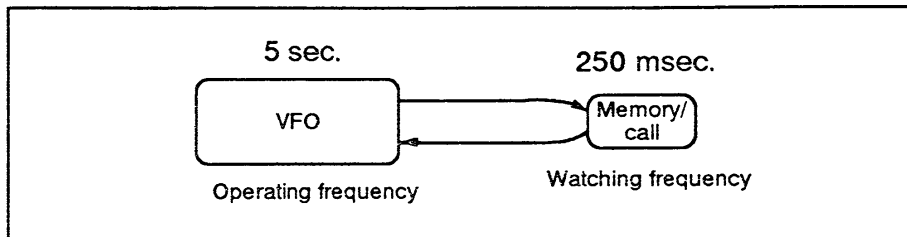

■ VFO/memory or VFO/call

- ① Set the desired operating frequency in VFO mode.
- ② Select a memory channel or call channel to be watched.
- ③ Push and hold [V/MHz•PRIO] to start the priority watch.
- ④ When a signal is received on the watching frequency (memory or call channel), the priority watch pauses.
 - Priority watch resume condition (the same as for scan) can be selected in set mode. See p. 19 for setting details.
- ⑤ To cancel the priority watch, push and hold [V/MHz•PRIO] again when the VFO frequency appears.
 - When performing while memory or call channel appears, the priority watch resumes.
 - [M•CALL] also cancels the priority watch, however memory mode is selected simultaneously.

■ VFO/memories

Priority watch can also monitor each memory channel consecutively at approx. 5 sec intervals. The memory skip function may be useful for faster scanning intervals.

- ① Select the desired operating frequency in VFO mode.
- ② Push [M•CALL] to select memory mode.
- ③ Push [SCAN] or push and hold the microphone's [UP]/[DN] switch to start the memory scan.
- ④ Push and hold [V/MHz•PRIO] to start the priority watch.
 - The displayed memory channel number changes to indicate which channel is being monitored.
- ⑤ When a signal is received on the watching frequency (memory channel), priority watch pauses.
 - Priority watch resume condition (the same as for scan) can be selected in set mode. See page 19 for setting details.
- ⑥ To cancel the priority watch, push and hold [V/MHz•PRIO] again when the VFO frequency appears.
 - When performing while memory or call channel appears, the priority watch resumes.
 - [M•CALL] also cancels the priority watch, however memory mode is selected simultaneously.

The transceiver allows frequency control from the keypad on the HM-95 DTMF MICROPHONE.* This may be helpful for mode selection such as VFO/memory/call or direct frequency entry from the keypad. To operate DTMF Remote, an optional UT-101 DTMF UNIT is necessary.

*HM-95 is optional for non-U.S.A. versions. The HM-77 HAND MICROPHONE WITH DTMF MEMORY is also available for convenient remote control.

- ① Push [DTMF] 3 times to select the remote control standby.

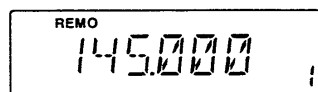

- "REMO" appears.

- ② Push [UP] on the microphone to activate "DTMF Remote".

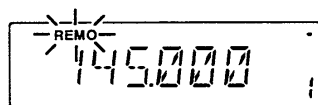

- [LOCK] on the microphone must be set OFF.

- "REMO" flashes.

- ③ While pushing [PTT], push the desired key on the microphone as described on the page at right.

- ④ Push [UP] again to cancel the function.

- "REMO" stops flashing. The transceiver enters the standby condition for remote control.

- ⑤ Push [DTMF] to cancel standby for the remote control.

- "REMO" disappears.

⚡ This function is not available for the Thailand version.

- "Up switch Remote" (described on p. 12) cannot be activated while "REMO" appears or flashes.
- The tuning dial and all switches including the PTT switch (for transmission) are locked while "REMO" flashes.
- Scan cannot operate while "REMO" flashes. [DN] starts scanning when "REMO" appears.
- The optional HM-77 has DTMF memory channels that may be useful for programming an often-performed function.

[EXAMPLE]:

Setting the operating frequency to 145.850 MHz.

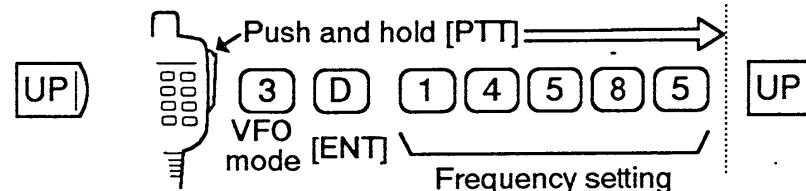

[EXAMPLE]:

Setting the operating memory channel to 5.

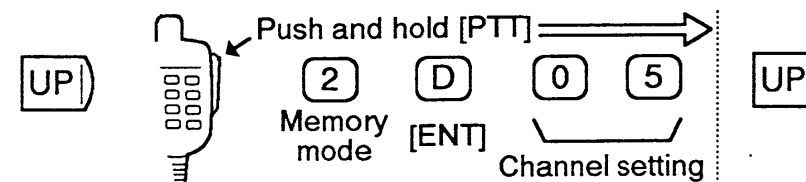

CALL	MEMO	VFO	CLEAR
[1]	[2]	[3]	[A]
[4]	[5]	HIGH	[B]
MONI	[8]	LOW	[C]
[7]	[0]	UP	ENTER
DOWN	[*]	[#]	[D]

KEY	DESCRIPTION
[1] (CALL)	Selects the call channel.
[2] (MEMORY)	Selects memory mode.
[3] (VFO)	Selects VFO mode.
[6] (HIGH)	Selects high power.
[7] (MONITOR)	Toggles the monitor function ON and OFF. The transmit frequency will be monitored while using duplex.
[9] (LOW)	Selects low power.
[0] (MUTE)	Toggles audio output mute and mute cancel.
[#] (UP)	Increases the operating frequency in preset tuning steps or the memory channel.
[*] (DOWN)	Decreases the operating frequency in preset tuning steps or the memory channel.
[A] (CLEAR)	Clears input digits and retrieves the previous key input.
[D] (ENTER)	Erases the frequency and sets the digit standby condition. Enters a frequency of 5 digits or a memory channel number of 2 digits.
[0]–[9] (after pushing [D])	Enters a frequency from the 100 MHz to 10 kHz digits or enters memory channels.

 The PTT switch must be held while using the functions at right.
 When an optional HM-77 DTMF MEMORY MICROPHONE is used, this is not necessary.

10 TONE SQUELCH AND POCKET BEEP

UT-85 is required.

General description

The *pocket beep* alerts you to a call when the same subaudible tone signal that is programmed into your transceiver is received. The *tone squelch* rejects signals that do not contain the same tone frequency for silent standby. An optional UT-85 TONE SQUELCH UNIT is required for operating these functions.

Pocket beep function

- ① Select the desired subaudible tone frequency in set mode. (See p. 14 for setting details).
 - Select the same tone frequency in your group.
- ② Push and hold [DUP•TONE] twice to activate the pocket beep.
- ③ When receiving a signal with the same tone, the transceiver emits beep tones and “(••)” flashes.
 - Beeps stop after 30 sec. and “(••)” flashes until you push any switch.
- ④ Push [PTT] to answer the calling station.
 - The pocket beep changes to tone squelch automatically.
- ⑤ To cancel the function, push and hold [DUP•TONE] once or twice until “T SQL” disappears.

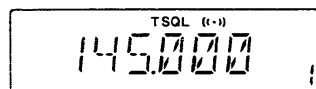

Pocket beep in standby

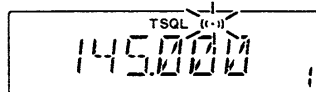

When detecting a tone

Tone squelch function

- ① Select the desired subaudible tone frequency in set mode. (See p. 14 for setting details).
 - Select the same tone frequency in your group.
- ② Push and hold [DUP•TONE] 3 times to activate the tone squelch.
 - “T SQL” appears when the function is ON.
- ③ Operate the transceiver in the normal way.
 - The transceiver does not receive signals which contain none or different tone signals.
 - To receive such signals, push and hold [LOW•MONI].
- ④ To cancel the tone squelch, push and hold [DUP•TONE] once.
 - “T SQL” disappears when the function is OFF.

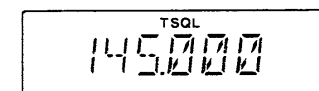

NOTE: The UT-85 has 50 tone frequencies and consequently their spacing is narrow compared with units having 38 tones. Therefore, some tone frequencies may receive interference from adjacent tone frequencies.

CONVENIENT: Each memory channel and call channel stores a subaudible tone frequency and tone squelch ON/OFF settings independently (cannot store pocket beep ON). Simply recall a memory or call channel.

General description

◇ Pager function

This function uses DTMF codes for paging and can be used as a "message pager" to inform you of a caller's identity even if you leave the transceiver temporarily unattended.

Personal calls and group calls are available with the pager function. Personal calls use the receiving parties' ID code for calling. The receiving parties' display shows your ID code and other stations in the party know that you called. You can also call all stations in your group using the group call.

To use the pager function in your group, all stations need the pager function.

◇ Code squelch

Code squelch operation provides communication with silent standby since you will only receive calls from stations which know your ID or group code.

The code squelch function transmits a 3-digit code prior to voice transmission in order to open the receiving station's code squelch.

/// These functions are not available for the Thailand version.

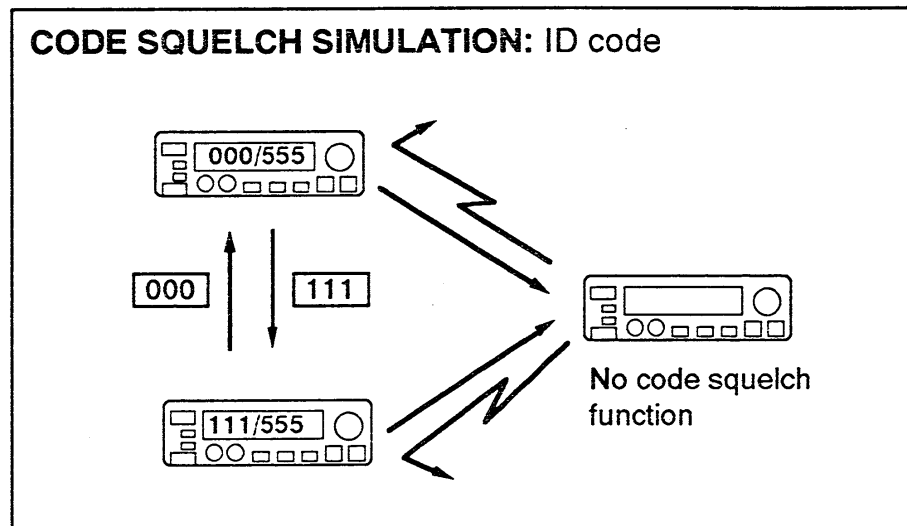
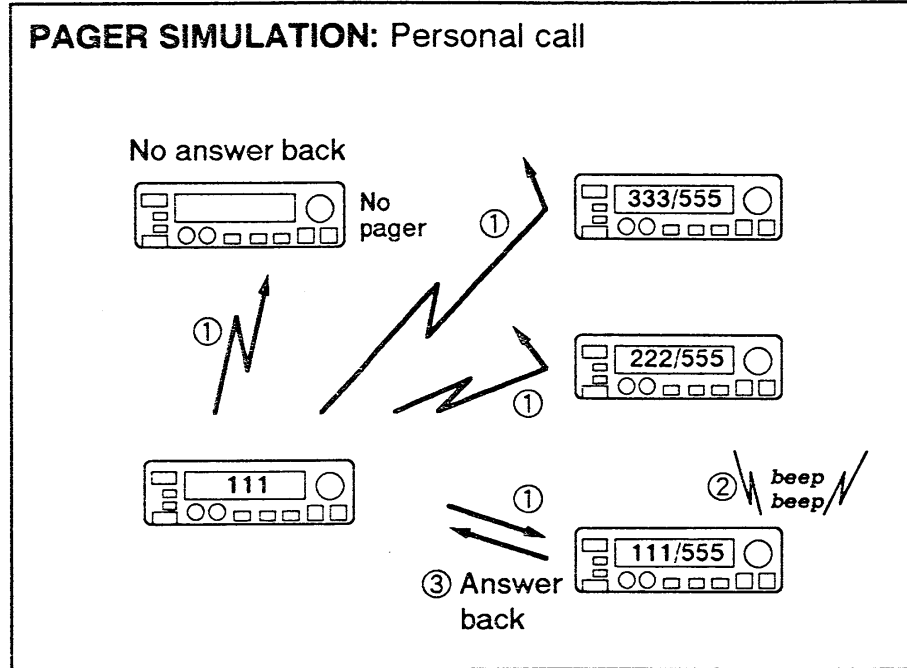

◇ Programming

/// **NOTE:** Setting in each step must be performed within 30 sec., otherwise the transceiver automatically exits the setting display.

- ① Push [PG/CS] to activate pager or code squelch.

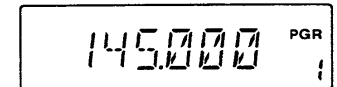

- ② Push [SET] to select the code programming display.



- ③ Rotate the tuning dial to select the desired code channel, C0 to C5.

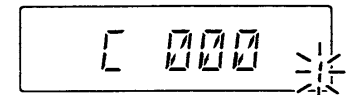

- ④ Push [SET] to select the digit to be changed.

- The [LOW] switch moves the cursor to the right.

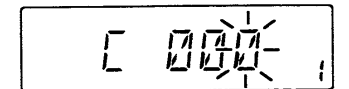

- ⑤ Rotate the tuning dial to set the digit.

- Using steps ④ and ⑤, set the 3 digits.

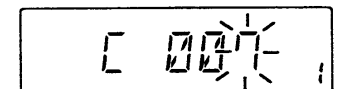

- ⑥ When selecting a transmit code (other stations' ID codes), push [PG/CS•MW] to set the channel as an "Inhibit" channel.

- Push [PG/CS] again to cancel.
- C0 cannot be set to "Inhibit".

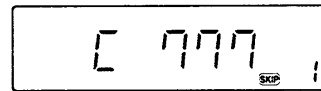

Receive inhibit

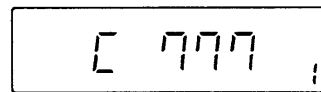

Receive accept

- ⑦ Push [DUP] to exit from the setting display or repeat steps ② to ⑥ to set other code channels.

• **Receive accept and receive inhibit**

The code channels C1 to C5 can store the transmit codes for personal calls with other parties and the group codes for group calls.

The transmit codes should be programmed as "receive inhibit" (**SKIP** appears), otherwise the transceiver accepts calls to other members — this is not a selective calling system.

The group code should be programmed as "receive accept" (**SKIP** disappears), because all members should receive group calls.

■ Code squelch

- ① Program the needed code channel in advance. (See left for programming information)

- ② Set the operating frequency.

- ③ Push [PG/CS] twice to activate the code squelch.

- "C SQL" appears.

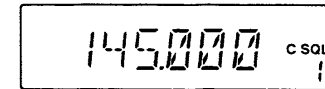

- ④ Select the desired transmit code.

- Push [SET] to indicate the code channel.

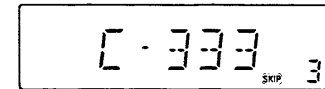

- Rotate the tuning dial to select the desired code channel.

- ⑤ Operate the transceiver in the normal way.

- Prior to voice transmission, a 3-digit transmit code is sent each time [PTT] is pushed in order to open the receiving station's code squelch.

- The transceiver does not receive signals which contain none or different code signals.

- To receive such signals, push and hold [LOW•MONI].

- ⑥ To cancel the code squelch, push [PG/CS] twice.

/// **CONVENIENT:** The optional tone squelch function can be used together with the code squelch for strong protection from interference.

11 PAGER AND CODE SQUELCH

■ Pager function

◇ Calling a specific station

- ① Program the needed code channel in advance. (See pgs. 27, 28 for programming information.)
- ② Set the operating frequency.
- ③ Push [PG/CS] once to activate the pager function.
- "PGR" appears.
- ④ Select the desired transmit code.
- Push [SET] to indicate the code channel.
- Rotate the tuning dial to select the desired code channel.
- ⑤ Push [PTT] to transmit the pager code.
- The display returns to the operating frequency simultaneously.
- ⑥ Wait for an answer back call.
- When the transceiver receives an answer back code, the display shows the other station's ID or group code.
- ⑦ After confirming the contact, push [DUP] to return to the normal display, then push [PG/CS] one or 3 times to select code squelch or non-coded operation to continue the contact with the answering station.

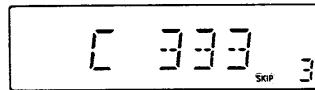
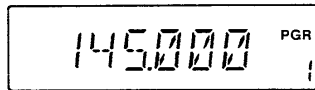

◇ Waiting for a call

- ① Program the needed code channel in advance. (See pgs. 27, 28 for programming information.)
- ② Set the operating frequency.
- ③ Push [PG/CS] once to activate the pager function.
- "PGR" appears.
- ④ Wait for a call.
- When receiving a call, the caller's ID or group code appears. "(••)" and the channel number flash simultaneously.
- ⑤ Push [PTT] to send an answer back.
- The display returns to the operating frequency simultaneously.
- ⑥ Push [PG/CS] one or 3 times to select code squelch or non-coded operation to continue the contact with the station.

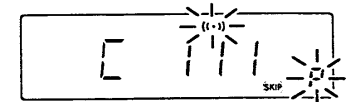

When receiving a personal call

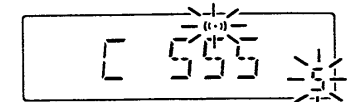

When receiving a group call (when group code is programmed in ch 5)

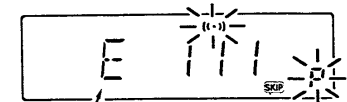

When receiving an incomplete signal

■ General description

6-digit alphanumeric “messages” can be transmitted or received together with the pager or code squelch function. This function may be useful when there is no answer back from the desired station and you want leave a message.

The transceiver has 5 message memories each for receive and transmit, to memorise and send messages respectively. There are two methods to transmit a message, manual transmission from a message memory and from a DTMF microphone.

/// This function is not available for the Thailand version.

◇ Message construction

0 : [0]	A : [2]+[A]	K : [5]+[B]	U : [8]+[B]	+ : [0]+[C]
1 : [1]	B : [2]+[B]	L : [5]+[C]	V : [8]+[C]	- : [1]+[D]
2 : [2]	C : [2]+[C]	M : [6]+[A]	W : [9]+[A]	= : [2]+[D]
3 : [3]	D : [3]+[A]	N : [6]+[B]	X : [9]+[B]	* : [3]+[D]
4 : [4]	E : [3]+[B]	O : [6]+[C]	Y : [9]+[C]	/ : [4]+[D]
5 : [5]	F : [3]+[C]	P : [7]+[A]	Z : [1]+[B]	Δ : [5]+[D]
6 : [6]	G : [4]+[A]	Q : [1]+[A]	(Space)	μ : [6]+[D]
7 : [7]	H : [4]+[B]	R : [7]+[B]	: [1]+[C]	Σ : [7]+[D]
8 : [8]	I : [4]+[C]	S : [7]+[C]	< : [0]+[A]	:: [8]+[D]
9 : [9]	J : [5]+[A]	T : [8]+[A]	> : [0]+[B]	

■ Message programming

- ① Push [PG/CS] to activate the pager or code squelch function.
- ② Push and hold [SCAN•ANM] to activate the message function.
- [MSG] appears on the display.

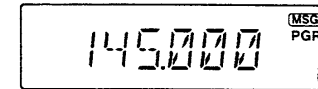

- ③ Push [SET] to enter the message programming display.

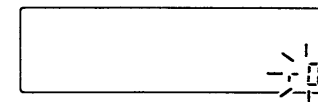

- ④ Rotate the tuning dial to select the desired message memory channel.

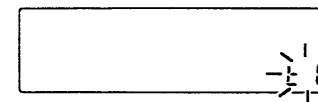

- “t” is used for transmission (programmable), “r” is used for receive (non-programmable).

- ⑤ Input a message using [SET], [LOW], and the tuning dial.

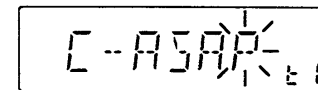

- [SET] : moves cursor left
- [LOW] : moves cursor right
- Tuning dial : changes character

- ⑥ Push [DUP] to exit the message programming display.

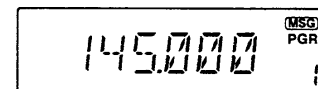

/// **NOTE:** Message memory channel t0 is used for the opening message at power ON and “ICOM” is programmed as the default setting.

12 MESSAGE TRANSMIT/RECEIVE

■ Operation

◇ Message standby (receive)

- ① Push [PG/CS] to activate the pager or code squelch.
 - Remember that ID code programming etc. for each transceiver in the group is necessary. (see. p. 27)

- ② Push and hold [SCAN•ANM] to turn the message function ON.

- ③ When receiving a message call, the message programmed into the message memory channel r0 is shown on the display.

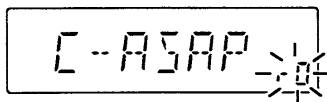

⋮

- Previous message is moved to channel r1, then r2 and so on. When more than 5 messages are received, the oldest message is cleared automatically.

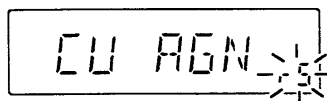

- ④ Rotate the tuning dial to select other message memory channels to check other messages.
- ⑤ Push [DUP] to exit the message display.

◇ Memory transmission

- ① Push [PG/CS] to activate the pager or code squelch.
 - Remember that ID code programming etc. for each transceiver in the group is necessary. (see. p. 27)

- ② Push and hold [SCAN•ANM] to turn the message function ON.

- ③ Push [SET] to call up the message memory display, then rotate the tuning dial to select the desired message.

- Select a transmit memory, "t" channel, although a receive, "r" channel can be selected.

- ④ Push [PTT] to transmit the message signal after a pager or code squelch signal.

◇ Manual transmission

A non-memorized message can be transmitted with manual keypad entry. Use this for instant transmit of simple messages, such as "number only" message.

- ① Push [PG/CS] to activate the pager or code squelch.

- Be sure the message function is turned OFF.

- ② Push and hold [PTT] to transmit a pager or code squelch signal, continuously holding [PTT].

- ③ While pushing [PTT], push [#], then push the corresponding digit keys for the message.

- Refer to the table on p. 30.

- ④ Push [#] again as an ending code.

[EXAMPLE] : To send "CU_AGN"

(#) (2)(C) (8)(B) (1)(C) (2)(A) (4)(A) (6)(B) (#)
C U Space A G N

■ Display backlight USING SET MODE

4 levels of display backlighting are selectable to suit ambient lighting.

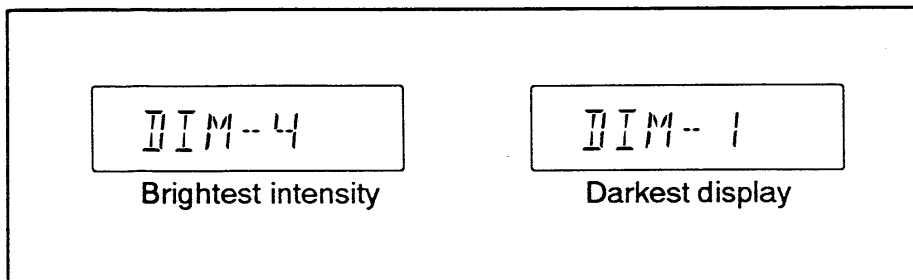

- ① Push [SET] one or more times until "DIM" appears on the display.
 - Pushing [LOW] reverses the order of selection.
 - When the display is alphanumeric, push and hold [SCAN•ANM] to select the frequency in advance.
 - Cancel pager or code squelch with [PG/CS] if in use.
 - When no operation is performed for 30 sec., the transceiver exits set mode automatically
- ② Rotate the tuning dial to set the desired intensity.
- ③ Push [DUP] to exit set mode.

■ Beep tones USING INITIAL SET MODE

A beep sounds each time a switch is pushed. The beep can be turned OFF for silent operation.

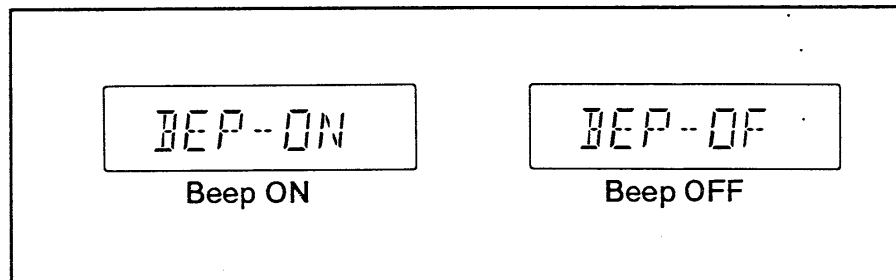

- ① Push [POWER] to turn power OFF.
- ② While pushing [SET], turn power ON to enter initial set mode.
 - The above display appears.
 - If another display appears, push [SET] or [LOW] one or more times until the above display appears.
- ③ Rotate the tuning dial to select a condition as above.
- ④ Turn power OFF to exit initial set mode.

13 OTHER FUNCTIONS

■ Auto-repeater

USING INITIAL SET MODE

When the operating frequency is within the U.S. repeater frequency range, duplex with/without subaudible tone is turned ON automatically.

This function is available for the U.S.A. versions only.

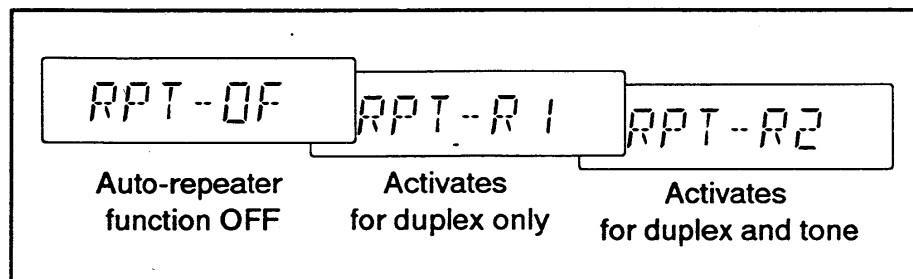

- ① Push [POWER] to turn power OFF.
- ② While pushing [SET], turn power ON to enter initial set mode.
 - "BEP" appears.
- ③ Push [SET] several times to select the auto-repeater display as shown above.
 - Pushing [LOW] reverses the order of selection.
- ④ Rotate the tuning dial to select the desired condition as above.
- ⑤ Turn power OFF to exit initial set mode.

/// AUTOMATIC SELECTION RANGE:

/// "DUP - " : 145.200-145.495, 146.610-146.995 MHz
/// "DUP" : 147.000-147.395 MHz

■ Time-out timer

USING INITIAL SET MODE

To prevent prolonged continuous transmission, the transceiver has a time-out timer. When using the timer, beeps sound 10 sec. before the transmission ends.

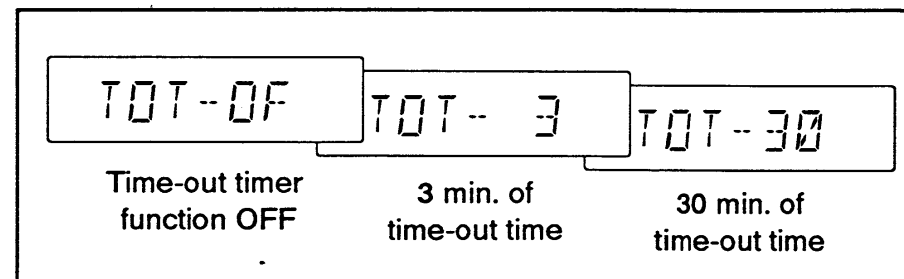

- ① Push [POWER] to turn power OFF.
- ② While pushing [SET], turn power ON to enter initial set mode.
- ③ Push [SET] several times to select the time-out timer display as shown above.
 - Pushing [LOW] reverses the order of selection.
- ④ Rotate the tuning dial to select the desired time-out time.
 - OFF, 3, 5, 15, 30 min. are available.
- ⑤ Turn power OFF to exit initial set mode.

■ Auto power-off

USING INITIAL SET MODE

The auto power-off function conveniently turns the transceiver power OFF after a preset period in which no operations are performed. When using the function, beeps sound 10 sec. before power is turned OFF.

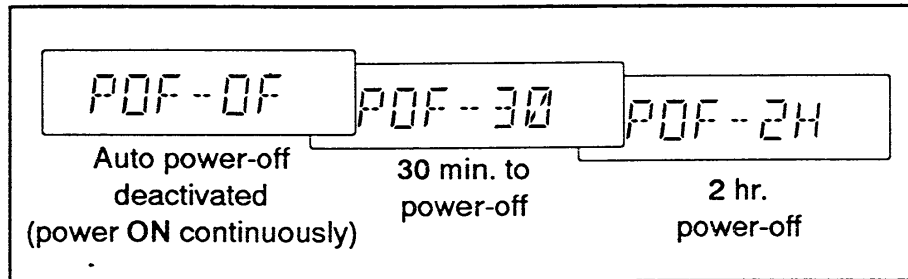

- ① Push [POWER] to turn power OFF.
- ② While pushing [SET], turn power ON to enter initial set mode.
- ③ Push [SET] several times to select auto power-off display as shown above.
 - Pushing [LOW] reverses the order of selection.
- ④ Rotate the tuning dial to select the desired power-off period.
 - OFF, 30 min., 1 hr., 2 hr. are available.
- ⑤ Turn power OFF to exit initial set mode.

■ Opening message

USING INITIAL SET MODE

When turning power ON a message appears for 1 sec. This message can be turned OFF if desired. The opening message uses message memory "t0" which can be overwritten when an optional UT-101 is installed.

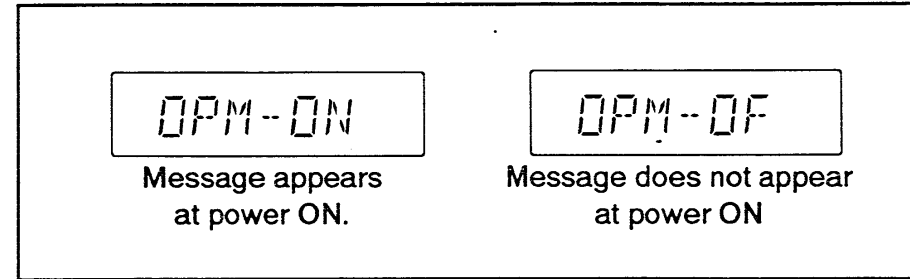

- ① Push [POWER] to turn power OFF.
- ② While pushing [SET], turn power ON to enter initial set mode.
- ③ Push [SET] several times to select the opening message display as shown above.
 - Pushing [LOW] reverses the order of selection.
- ④ Rotate the tuning dial to turn the function ON or OFF.
- ⑤ Turn power OFF to exit initial set mode.

/// **NOTE:** Although an optional UT-101 DTMF UNIT is necessary to overwrite the opening message, once overwritten, the message is retained even if the UT-101 is removed. See p. 30 for message programming details.

13 OTHER FUNCTIONS

■ Repeater lockout

USING INITIAL SET MODE

This function helps prevent interference to other stations by inhibiting your transmission when a signal is received. The transceiver has two inhibiting conditions, repeater and busy.

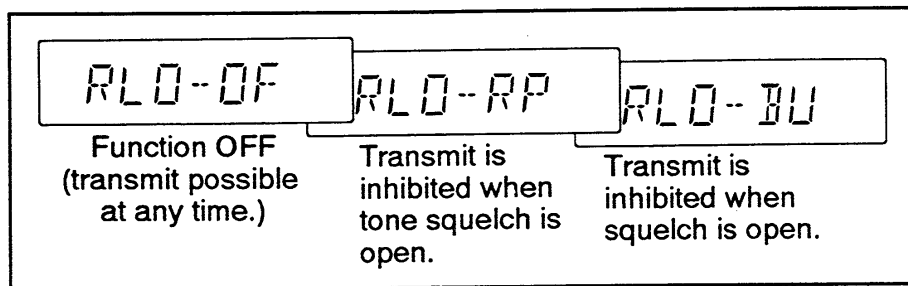

- ① Push [POWER] to turn power OFF.
- ② While pushing [SET], turn power ON to enter initial set mode.
- ③ Push [SET] several times to select the repeater lockout display as shown above.
 - Pushing [LOW] reverses the order of selection.
- ④ Rotate the tuning dial to select the desired inhibit condition.
 - "OFF" : No restriction for transmit.
 - "RP" (repeater) : Transmit is inhibited when an optional tone squelch is closed. (The same as "OFF" when no optional tone squelch unit is installed.)
 - "BU" (busy) : Transmit is inhibited when any signal is received. (When squelch is open.)
- ⑤ Turn power OFF to exit initial set mode.

■ Demonstration display

A demonstration function is available at power ON. This function gives you a quick visual introduction to the function display indicators.

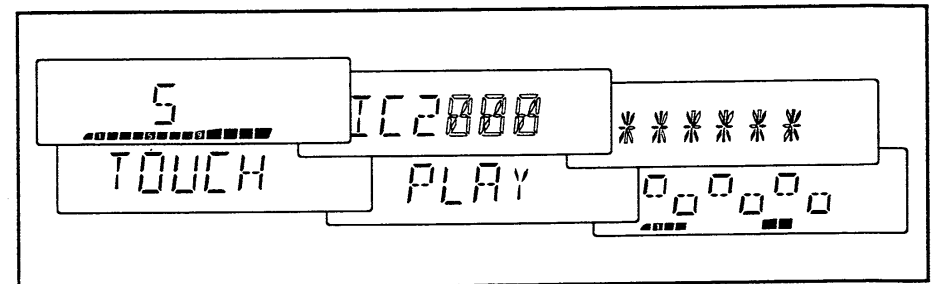

- ① While pushing [SET] and [LOW], push [POWER] to turn power ON.
 - The transceiver cycles through a visual tour of the function display indicators.
- ② Push any switch to exit demonstration mode and enter the normal operating condition temporarily.

NOTE: The transceiver automatically returns to demonstration mode after 2 min. in which no operations are performed. To deactivate the demonstration display, perform step ① again.

Optional unit installation

There are 2 types of optional internal units available.

- **UT-85 TONE SQUELCH UNIT** (p. 25)

Provides *pocket beep* and *tone squelch* functions. Also provides the *tone scan* for decoding the subaudible tone frequency of a received signal.

- **UT-101 DTMF UNIT** (pgs. 23, 26, 30)

Provides *pager* and *code squelch* functions for selective call and silent standby. The *message* transmit and receive functions are also available for character communication. In addition, the "DTMF Remote" can be used together with a DTMF microphone for direct frequency entry, memory/VFO/call selection, etc.

/// The UT-101 is not available for the Thailand version.

◇ Installation

- ① Turn power OFF, then disconnect the DC power cable.
- ② Set the transceiver upside down.
- ③ Removes the screw in the center of the bottom cover, then remove the cover.
- ④ Install the optional unit as shown in the diagram below.
- ⑤ Replace the bottom cover and screw, then connect the DC power cable.

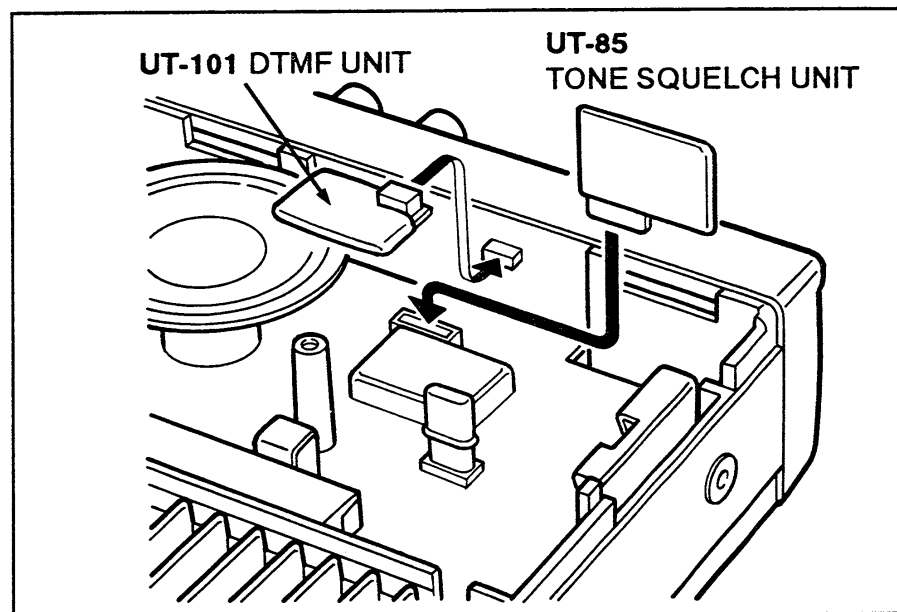

/// **NOTE:** When both the UT-85 and UT-101 are being installed, install the UT-101 before the UT-85. Otherwise the UT-101 cannot be installed.

15 MAINTENANCE

■ Troubleshooting

If your transceiver seems to be malfunctioning, please check the following points before sending it to a service center.

PROBLEM	POSSIBLE CAUSE	SOLUTION	REF.
<ul style="list-style-type: none"> No power comes on. 	<ul style="list-style-type: none"> Polarity of the power connection is reversed. Blown fuse. 	<ul style="list-style-type: none"> Reconnect the power cable observing the proper polarity. Replace the fuse, if damaged. Check the cause, then replace the fuse. 	<p>p. 8</p> <p>p. 8</p>
<ul style="list-style-type: none"> No sound comes from the speaker. 	<ul style="list-style-type: none"> The optional pager, code squelch, pocket beep or tone squelch is in use. 	<ul style="list-style-type: none"> Turn the appropriate function OFF. 	<p>pgs. 25–29</p>
<ul style="list-style-type: none"> Sensitivity is low and only strong signals are audible. 	<ul style="list-style-type: none"> Antenna feedline or the antenna connector solder has a poor contact or is short circuited. 	<ul style="list-style-type: none"> Check, and if necessary, replace the feedline or solder the antenna connector again. 	<p>—</p>
<ul style="list-style-type: none"> Transmitting is not possible. 	<ul style="list-style-type: none"> A signal is being received when the repeater lockout is in use. An optional "DTMF Remote" is in standby. 	<ul style="list-style-type: none"> Turn OFF the repeater lockout function or wait until the channel is clear. Push the microphone's [UP] switch to exit the standby condition. 	<p>p. 35</p> <p>p. 23</p>
<ul style="list-style-type: none"> Transmission is automatically cut off. 	<ul style="list-style-type: none"> Time-out timer is activated. 	<ul style="list-style-type: none"> Set the timer to OFF in initial set mode. 	<p>p. 33</p>
<ul style="list-style-type: none"> Repeater cannot be accessed. 	<ul style="list-style-type: none"> Wrong offset frequency is programmed. Wrong subaudible tone frequency is programmed. 	<ul style="list-style-type: none"> Correct the offset frequency in set mode. Correct the subaudible tone frequency in set mode. 	<p>p. 14</p> <p>p. 14</p>
<ul style="list-style-type: none"> Frequency cannot be set. 	<ul style="list-style-type: none"> The frequency lock function is activated. Priority watch is paused on the watching frequency. 	<ul style="list-style-type: none"> Push and hold [SET•LOCK] to turn the function OFF. Push and hold [V/MHz•PRIO] to resume the watch. 	<p>p. 9</p> <p>p. 22</p>
<ul style="list-style-type: none"> Some memory channels cannot be selected. 	<ul style="list-style-type: none"> The memory channel is outside of the selected memory area. 	<ul style="list-style-type: none"> Reset the memory area in set mode. 	<p>p. 18</p>
<ul style="list-style-type: none"> Memory scan does not function. 	<ul style="list-style-type: none"> All memory channels are set as skip channels. (default setting) 	<ul style="list-style-type: none"> Cancel the skip setting for more than 2 channels. (memory writing cancels a skip channel automatically) 	<p>p. 21</p>

■ Partial resetting

If you want to initialize the operating conditions (VFO frequency, VFO settings, set mode settings, etc.) without clearing the memory contents or initial set mode settings, a partial reset function is available for the transceiver.

- ① Push [POWER] to turn power OFF.
- ② While pushing [PG/CS·MW], turn power ON to partially reset the transceiver.
 - The following contents are cleared or retained and the transceiver displays its initial VFO frequency display.

Reset contents

- VFO frequency
- Tuning step
- Offset freq. for VFO
- Tone freq. for VFO
- Memory area setting

Retained contents

- Memory channels
- Call channel
- Offset freq. in memory/call
- Tone freq. in memory/call
- Alphanumeric display contents
- Message memory contents ("t0"–"t5", "r0"–"r5" incl. opening message)
- Pager code setting
- Setting in initial set mode

■ Resetting the transceiver

The function display may occasionally display erroneous information, (e.g., when first applying power). This may be caused externally by static electricity or other factors.

If this problem occurs, turn power OFF. After waiting a few seconds, turn power ON again. If the problem persists, perform the following procedure.

Partial resetting is alternatively available. See left for details.

/// **NOTE:** Resetting the CPU **CLEARs** all memory information, and initializes all settings in the transceiver.

- ① Push [POWER] to turn power OFF.
- ② While pushing [SET] and [PG/CS·MW], turn power ON.
 - All LCD segments appear momentarily, the initial display appears and the transceiver's CPU is reset.

/// **MEMORY BACKUP:**

All memories are backed up by an EEPROM (Electrically-Erasable Programmable Read-Only Memory) which retains VFO and all channel contents. There is no internal lithium battery.

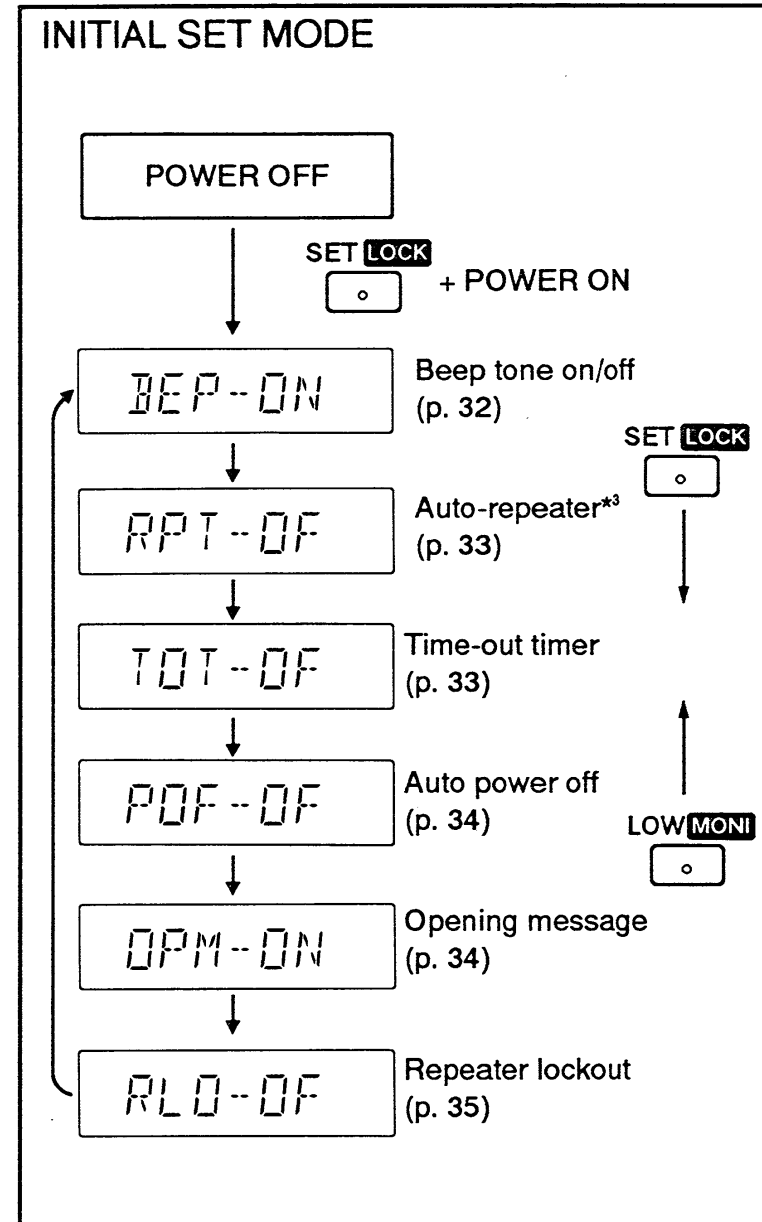
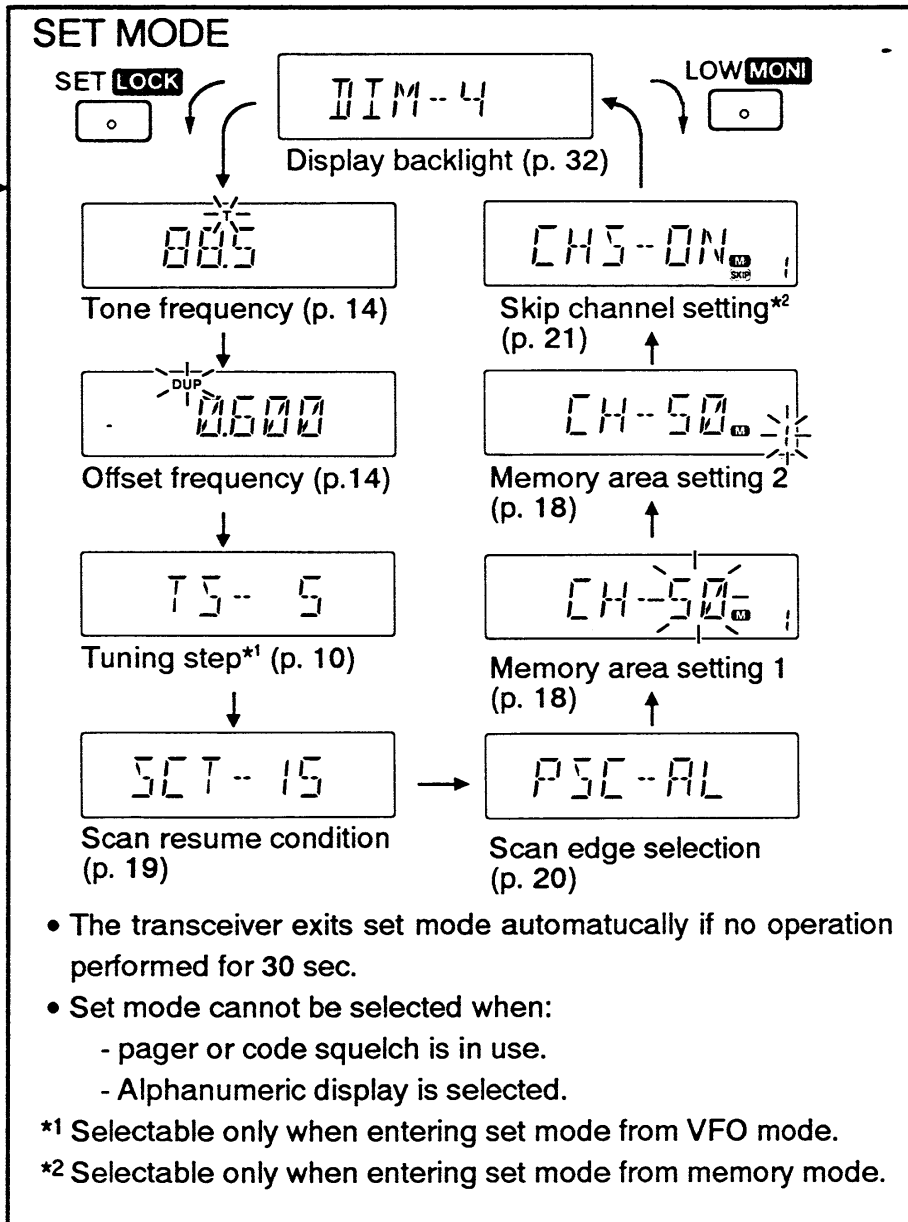

17 SPECIFICATIONS

◇ General

- Frequency coverage (Unit: MHz)

Version	Receive	Transmit
U.S.A. version	118.000–174.000*	144.000–148.00
Europe version	144.000–146.000	144.000–146.00
Asia version	136.000–174.000*	144.000–148.00
Australia version	144.000–148.000	144.000–148.00
Italy version	136.000–174.000*	144.000–148.00
Korea version	144.000–146.000	144.000–146.00
Thailand version	144.000–146.000	144.000–146.00

*Specifications guaranteed 144–148 MHz

- Mode : FM
- Antenna impedance : 50 Ω (nominal)
- Power supply requirement : 13.8 V DC \pm 15% (negative ground)
- Usable temperature range : -10°C to $+60^{\circ}\text{C}$
($+14^{\circ}\text{F}$ to $+140^{\circ}\text{F}$)
- Dimensions : 150(W) \times 50(H) \times 151(D) mm
5.9(W) \times 2.0(H) \times 5.9(D) in
- Weight : 1.2 kg 2.6 lb
- Current drain
 - Transmit : 10.5 A (50 W), 5.5 A (10 W)
4.0 A (5 W)
(Thailand version has no 50 W Tx)
 - Receive : 1.0 A (max. audio output)
0.8 A (squelched)

◇ Transmitter

- Output power : 50 W (high),
10 W (middle), 5 W (low)
(Thailand version: 10 W/5 W)
- Modulation system : Variable reactance frequency modulation
- Max. frequency deviation : ± 5.0 kHz
- Spurious emissions : Less than -60 dB
(For Thailand version: -55 dB)
- Microphone impedance : 600 Ω

◇ Receiver

- Sensitivity : Less than 0.18 μV for 12 dB SINAD
- Squelch sensitivity : 0.13 μV at threshold
- Receive system : Double-conversion superheterodyne
- Intermediate frequency: 1st 17.2 MHz 2nd 455 kHz
- Selectivity : More than 15 kHz/ -6 dB
Less than 30 kHz/ -60 dB
- Spurious response : More than 60 dB rejection
- Audio output power : More than 2.4 W at 10% distortion with an 8 Ω load

All stated specifications are subject to change without notice or obligation.

SP-7
EXTERNAL SPEAKER

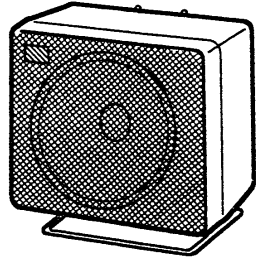

Cable length: 1.0 m; 3.3 ft

SP-10
EXTERNAL SPEAKER

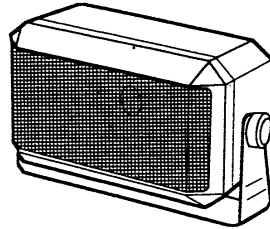

Cable length: 1.5 m; 4.9 ft

SP-12
EXTERNAL SPEAKER

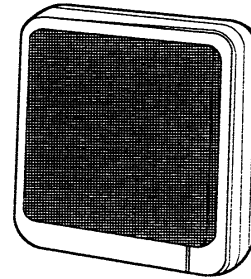

Cable length: 2.0 m; 6.6 ft

IC-PS30
DC POWER SUPPLY

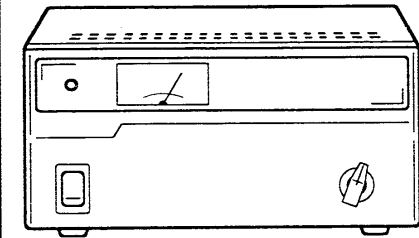

13.5 V / 25 A
3 extra output plugs.

HM-77
DTMF MICROPHONE*

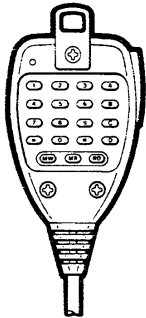

Equipped with 14 DTMF memory channels for auto dialing. Also the DTMF memory may be useful for additional message memory and DTMF remote used together with the UT-101.

HM-78, HM-79
HAND MICROPHONE

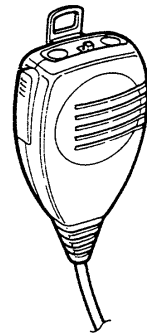

Streamlined microphone provides a comfortable grip. The HM-79 has a 1750 Hz tone burst function.

HM-95 DTMF MICROPHONE*

Same as supplied with the U.S.A. and Korea versions.

HM-96 HAND MICROPHONE

Same as the supplied with the Australia, Asia, Thailand versions.

HM-97 HAND MICROPHONE

Same as the supplied with the Europe and Italy versions. Has 1750 Hz tone burst function.

OPC-346 DC POWER CABLE

Same as supplied with the transceiver. (20 A, 3 m; 9.8 ft)

OPC-347 DC POWER CABLE

Has 20 A capacity and a length of 7.0 m (23.0 ft).

UT-85 TONE SQUELCH UNIT

Provides pocket beep, tone squelch and tone scan functions.

UT-101 DTMF UNIT*

Provides pager and code squelch functions. Also "DTMF Remote" for controlling the transceiver via a DTMF microphone and message transmit/receive functions are available.

*These options are not available for the Thailand version.

Count on us!



A-5329S-1EX
Printed in Japan
Copyright © 1994 by Icom Inc.

Icom Inc.
6-9-16, Kamihigashi, Hirano-ku, Osaka 547, Japan