

IC-202S

2 METER BAND
SSB TRANSCEIVER

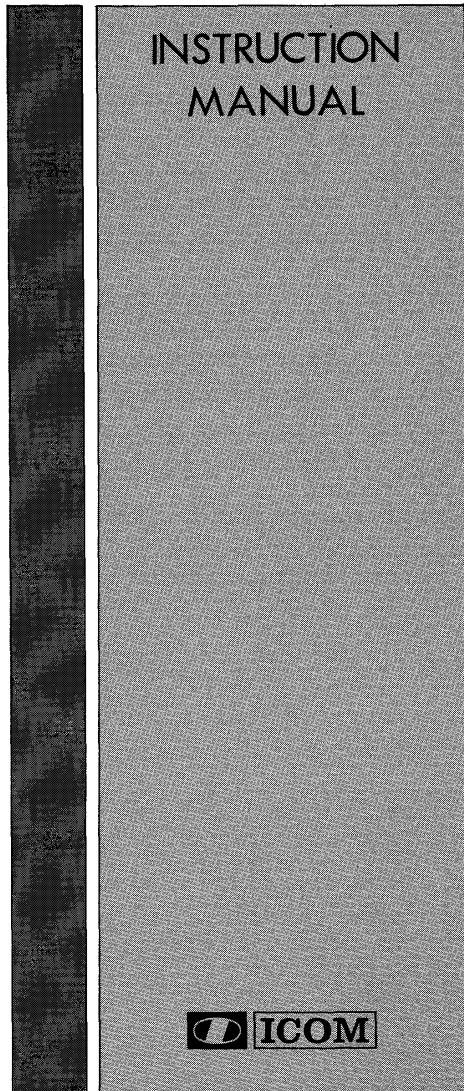

INSTRUCTION
MANUAL



TABLE OF CONTENTS

I. Introduction	1
II. Specifications	2
III. Accessories	3
IV. Pre-Operation	4
V. Description of Controls and Connections	8
VI. Operation	11
VII. Theory	13
VIII. Maintenance and Adjustment	17
IX. Inside View	22
X. Block Diagram	23
XI. Parts List	24
XII. Board Layout	29
XIII. Voltage Chart	30
XIV. Options	31

SECTION I INTRODUCTION

Congratulations on the purchase of the IC-202S portable 2 meter SSB transceiver. The IC-202S was designed to be operable anywhere like most portables, but we also included features found in most base sets like a very effective noise blanker, RIT, S&RF meter, CW monitor, and a full 3 watts output on either USB or LSB. Two built-in crystals in the stable VXO allow operation between 144.00 and 144.40MHz. If you wish to expand the range of the IC-202S, we have also provided 2 spare crystal sockets for your convenience. With a slight retuning of the IC-202S, and installation of a special crystal, you may also work through OSCAR in USB for up-link (for mode A of AMSAT OSCAR 7 and 8, and for mode J of AMSAT OSCAR 8) and in LSB for down-link (for mode B of AMSAT OSCAR 7).



The aluminum die cast frame provides a very strong yet light housing for the 2 circuit boards, and the aluminum sides snap off easily if service is ever necessary or to change batteries.

The IC-202S operates on 9 inexpensive C cell batteries, or an external 13.8V DC source. The IC-202S will also operate on nicad batteries, contained in the BC-20/BC-15 nicad battery/charger kit. For AC operation, we recommend the IC-3PS which not only provides power for the IC-202S, but also doubles as a stand and holder for the IC-20L 10 watt linear amplifier.

You can use the built-in whip antenna for portable use, or a flexible antenna such as the IC-FA1. An external antenna connects to the antenna connector on the back of the IC-202S.

We are sure that you will have years of lasting enjoyment from your IC-202S, manufactured by the leader in communication equipment: Inoue Communication Equipment Corporation.

SECTION II SPECIFICATIONS

General:

Number of Semi-conductors	Transistors 19 FET 7 IC 7 Diodes 36
Frequency Coverage	144–146MHz
Frequency Stability	Less than 200Hz per hour at +25°C
Antenna Impedance	50 ohms unbalanced
Power Supply Requirements	DC 13.8V±15% Negative Ground 800mA max
Current Drain	Transmitting: A3J Approx. 540mA A1 Approx. 750mA Receiving: At max audio approx 250mA With no signal approx 90mA Dial Light: Approx 40mA
Dimensions	183mm (H) x 61mm (W) x 162mm (D)
Net Weight	2.0kg including batteries.

Transmitter:

Emission Mode	A3J (USB, LSB) and A1
RF Power Output	A3J 3W (PEP) A1 3W
Carrier Suppression	More than 40dB below peak power
Unwanted Sideband Suppression	More than 40dB down at 1000Hz AF input
Spurious Radiation	More than 60dB below peak power
Microphone	Impedance: 600 ohms Input level: 10mV typical Dynamic or optional Electret condenser microphone
CW Monitor	Built-in. Audio level adjustable by VOL knob.

Receiver:

Receiving System	Single Conversion Superheterodyne
Intermediate Frequency	10.7MHz
Receiving Mode	A3J (USB, LSB) and A1
Spurious Response Rejection Ratio	More than 60dB
Sensitivity	Less than 0.5μV for 10dB S+N/N
Selectivity	±1.2KHz at –6dB ±2.4KHz at –60dB
Audio Output	More than 1W
Audio Output Impedance	8 ohms

144.00–144.40MHz built-in (2 crystals). Each crystal gives 200KHz continuous coverage. Two spare crystal sockets are provided for additional frequency ranges between 144.40–146.00MHz.

SECTION III ACCESSORIES

Various accessories are packed with your transceiver. Be sure not to overlook anything. Also it's a good idea to keep packing cartons in case of moving or if return for service is necessary.

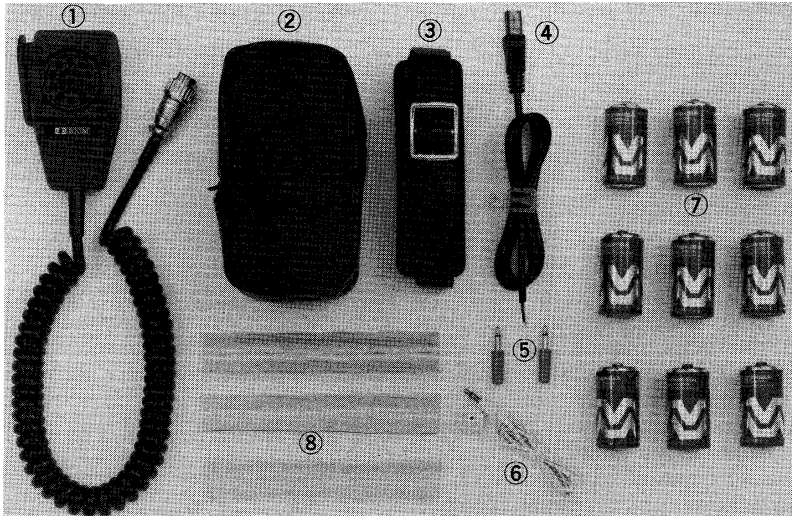

- | | | | |
|-----------------------|---|--------------------------------|---|
| 1. Dynamic Microphone | 1 | 5. Ext. Speaker Plug, Key Plug | 2 |
| 2. Microphone Case | 1 | 6. Earphone | 1 |
| 3. Shoulder Strap | 1 | 7. Dry Cells Type "C" | 9 |
| 4. Power Cord | 1 | 8. Battery Tubes | 3 |

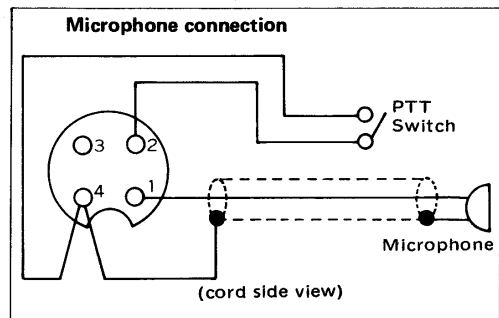
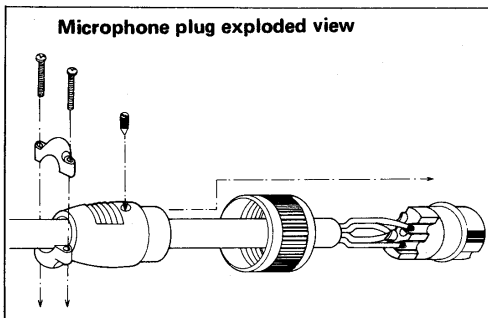
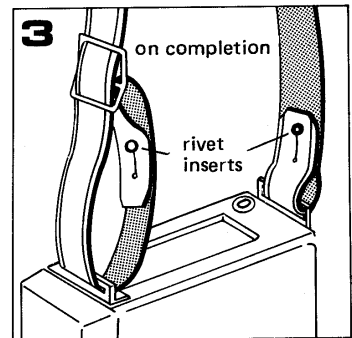
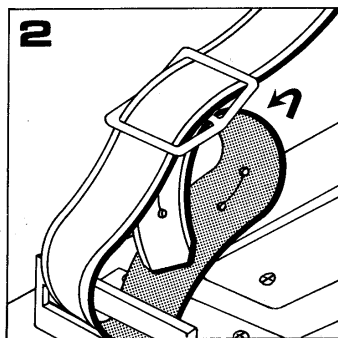
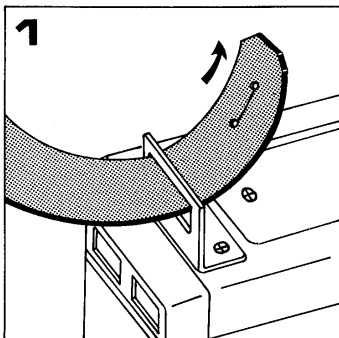

SECTION IV PRE-OPERATION

BATTERY INSTALLATION

Dry Batteries:

Place the mode switch in the OFF position. Remove the side that covers the battery case and speaker. Install the batteries into the battery tubes (three in each) taking care to observe the same direction (polarity).

Carefully install the battery tubes in the manner shown in photograph 1, placing the last three batteries in the inner column. Again take care to observe polarity, and place the battery tubes on top of the ribbon so when the batteries need to be removed, a simple pull on the ribbon will make removal easier. With the batteries properly in place, carefully replace the side cover.

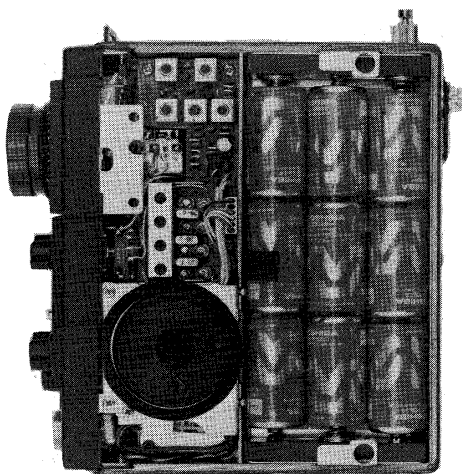
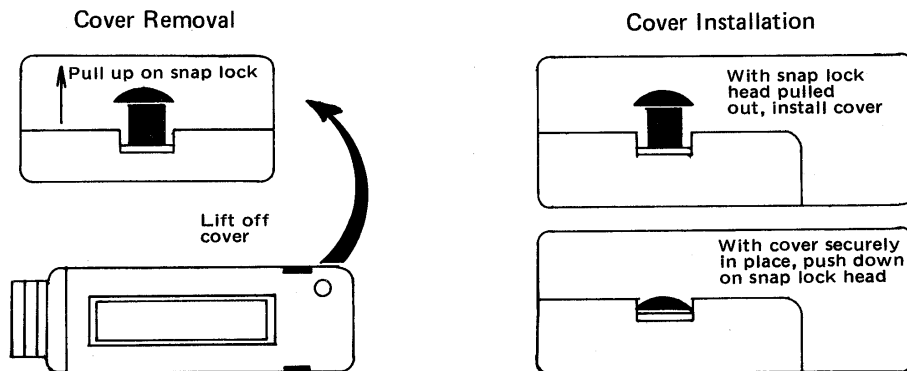

Photograph 1
Dry Batteries Installation

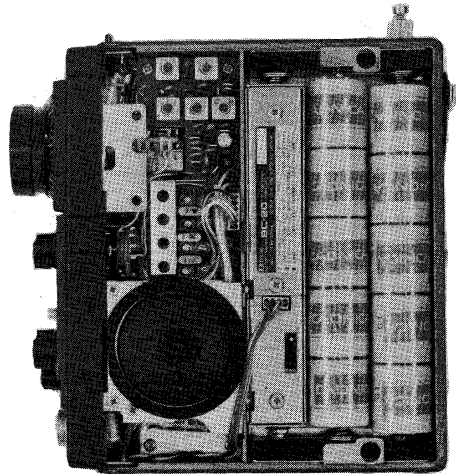

Photograph 2
Nickel-Cadmium Batteries
and Charger (BC-20) Installation

Nickel-Cadmium Batteries and Charger: BC-20

First, install the charger in the battery case (the speaker side) of the transceiver housing as shown in photograph 2. The polarity of the switch end of the charger must be positive and on the case side, negative. Accordingly the negative polarity must be connected to the spring side of the battery case.

Next, install five nickel-cadmium batteries in the battery tubes in the same direction. Make certain the (-) minus side is next to the spring. After installation of the charger and batteries in the case, connect the connector from the transceiver housing to the socket of the charger. Make sure the switch of the charger is ON, then install the side cover as before.

AC BATTERY CHARGER : BC-15

The BC-15 consists of an 117/220 Volt AC charger, 10 900mAh nickel-cadmium batteries, and a fuse box.

To install the BC-15 in the IC-202S, first put the Fuse Box into position, and then install the nickel-cadmium batteries in accordance with Photograph 3. After installation is completed, connect the output plug of the AC Adaptor to the External Power Supply Jack on the back of the IC-202S. For recharging, refer to the manual instructions for the AC adaptor.

After charging is completed, the batteries can be used in the same manner as dry cells. However, the voltage of nickel-cadmium batteries drops rapidly just before they are exhausted, so when the Power Indicator LED of the transceiver goes out, be sure to immediately stop using it, and charge the batteries again.

For use of the other sections, please refer to the charger instruction manual.

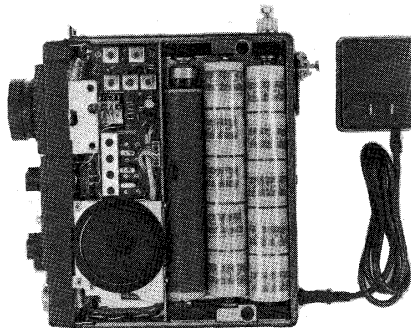

Photograph 3
Nickel-Cadmium Batteries
and Charger (BC-15) Installation

WHEN TO REPLACE BATTERIES

When the Power Indicator LED does not light up with the power switch ON, or when it lights up during reception and goes out during transmission, the batteries are exhausted. Use batteries of the same type, for mixed types might cause leakage. Replace worn batteries with a complete new set. If used with old batteries, the life of new ones might be shortened. Battery life is shortened more by transmitting than by receiving, since several times more current is drawn in transmit. To prolong battery life, therefore, practice as follows:

- * Try to minimize the transmit period.
- * Reduce volume during reception.
- * Be sure to cut off power source when set is not used.

More working hours are available if high-performance batteries such as Alkaline type are employed.

EXTERNAL POWER PLUG CONNECTION

External Power Source

For use at home or in the car, please use the external power source which assures you of stable communication without concern about battery consumption.

1. Use either a regulated power supply or car battery of 13.8V DC and of over 1A current capability. (Though this transceiver may work at 11 to 15V DC, use it preferably at the rated voltage.)
2. Correctly connect the external supply as shown in the figure. If polarity is reversed, source power is cut off by the protection circuit and the unit will not operate.
3. When the transceiver is kept out of use for a prolonged period, the unit is operated for extended periods by external power only, or when the batteries are exhausted, etc., remove the batteries to protect the unit from possible damage by battery leakage.

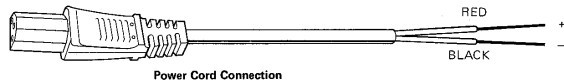
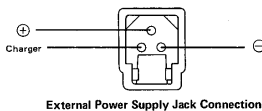

FOR OUTDOOR USE

1. Insert the supplied batteries. (Refer to "BATTERY INSTALLATION")
2. Attach the supplied shoulder strap through the fixture of the body (as shown in the drawings on page 3).
3. Fully extend the whip antenna for operation, or install the flexible antenna. Keep the collapsible antenna depressed when the set is not in use so that it will not be damaged.

FOR USE IN THE CAR

1. Avoid using the unit near the outlet of heaters, air-conditioners, etc.
2. Install the unit in a convenient place to avoid disrupting safe driving.
3. For the best power source, connect to the car battery through a fuse (1A-2A).
4. Firmly ground to the car body a mobile antenna (e.g. whip antenna) that requires it.

Cable Connection

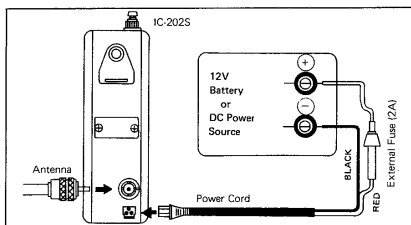

Connection using IC-20L

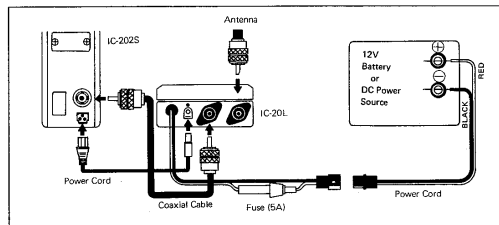

FOR FIXED USE

1. Avoid installing the unit in places exposed to rain, water splash, direct sunshine, dust, vibration, or heat.
2. An external antenna should be used for indoor operation, The use of the whip or flexible antenna indoors may cause TVI, BCI, Hi-Fi interference, malfunction of stabilized DC power supply, etc. When using an external antenna, be sure to collapse the telescoping antenna into the body or remove the flexible antenna.
3. For fixed use, an external power supply is more economical than batteries.
4. Use of the linear amplifier IC-20L and AC power supply IC-3PS give excellent performance for fixed use.

HOW TO USE EXTERNAL ANTENNA

Select a high performance antenna (a multi-element beam or gain antenna) and set it up in the highest possible position. Tightly connect the antenna so that performance will not be affected by weather or vibration. The matching impedance is designed to be 50 ohms.

FOR SATELLITE COMMUNICATION USE

At present there are two active satellites for amateur radio use, AMSAT OSCAR 7 was launched in November, 1974 and AMSAT OSCAR 8 was launched in March, 1978. Satellite communications can be made by using an IC-202S for transmitting and an IC-701 (HF SSB/CW transceiver) for receiving in Mode A, and by using an IC-202S for receiving/transmitting and an IC-402 (70 cm SSB/CW transceiver) for transmitting/receiving in Mode B and Mode J. For frequency information refer to the chart below. Further information on communicating through satellites can be found in various amateur radio books and periodicals.

FREQUENCY CHART

SATELLITE	MODE	UPLINK (Transmitting) FREQUENCY	DOWNLINK (Receiving) FREQUENCY	BEACON
AMSAT OSCAR 7 (AO-7)	A	145.85MHz~145.95MHz (USB/CW)	29.4MHz~29.5MHz (USB/CW)	29.502MHz 435.100MHz
	B	432.125MHz~432.175MHz (USB/CW)	145.975MHz~145.925MHz (LSB/CW)	145.972MHz
AMSAT OSCAR 8 (AO-8)	A	145.85MHz~145.95MHz (USB/CW)	29.4MHz~29.5MHz (USB/CW)	29.402MHz
	J	145.90MHz~146.00MHz (USB/CW)	435.2MHz~435.1MHz (LSB/CW)	435.097MHz

SECTION V DESCRIPTION OF CONTROLS AND CONNECTIONS

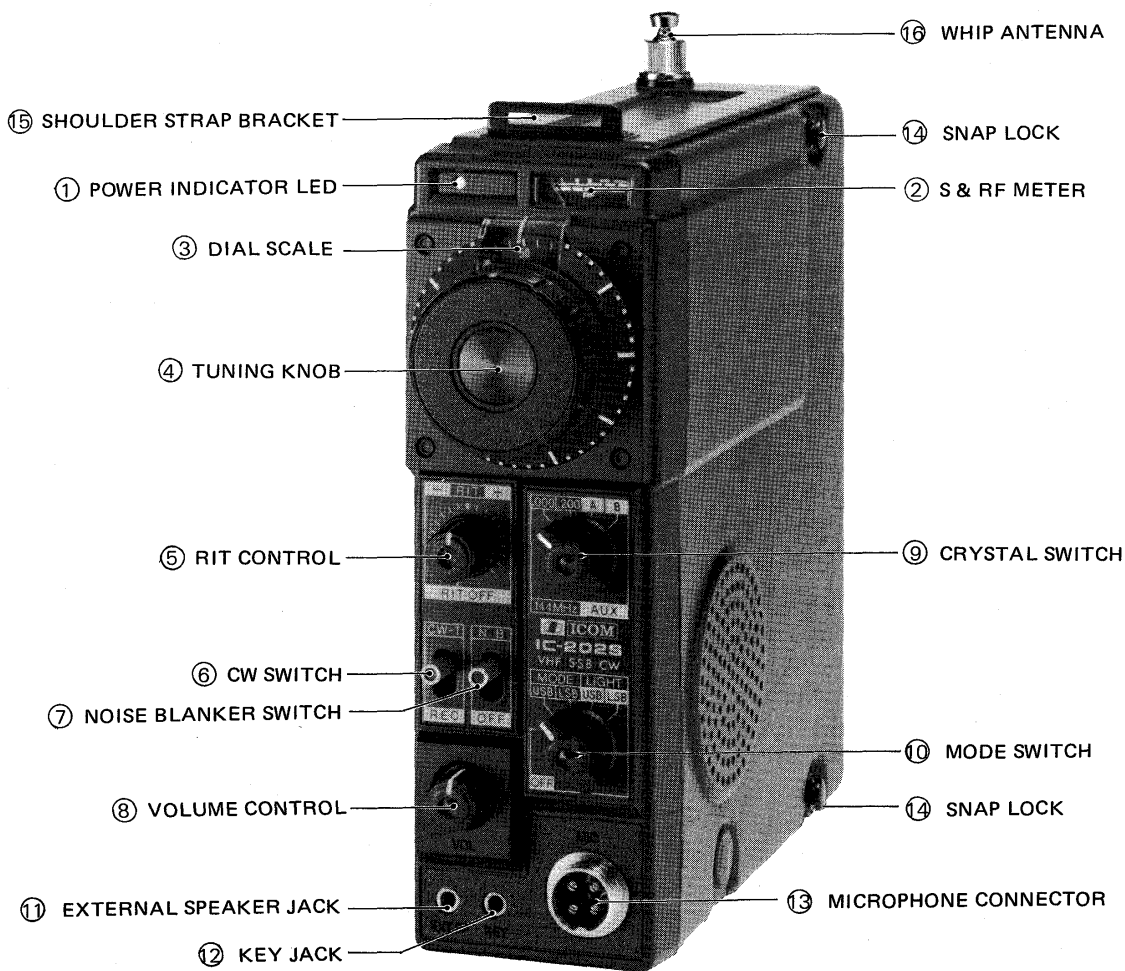

1. POWER INDICATOR LED

Shows when power is applied to the IC-202S. (also indicates battery condition)

2. S & RF METER

Indicates the relative signal strength of incoming signals and output power of transmitted signals.

3. **DIAL SCALE**
The dial is divided into 10KHz increments with a total coverage of 200KHz. The operating frequency is read by adding the frequency shown on the dial to that shown on the crystal switch, or in the case of the spare crystals, by adding the dial reading to the lowest range frequency of the crystal installed. (see page 12.)
4. **TUNING KNOB**
Tunes the frequency.
5. **RIT CONTROL**
Independently swings the receiver frequency ± 3 KHz so that signals that are slightly off frequency may be tuned for clarity without affecting the transmitting frequency. For switching OFF the RIT to make the receiving and transmitting frequencies the same, turn the RIT control knob counterclockwise to the RIT OFF position.
6. **CW SWITCH**
Be sure to set the MODE SWITCH at the USB position, or else your CW signal will not be transmitted. A CW MONITOR is built in, and the audio level can be adjusted with the VOLUME CONTROL.
7. **NOISE BLANKER SWITCH**
In the NB position, the noise blanker is put into the circuit and noise pulses will be reduced.
8. **VOLUME CONTROL**
Controls the audio output level. Controls the side-tone audio level in the CW transmit mode.
9. **CRYSTAL SWITCH**
Selects the crystal to be used in the VXO, and therefore also selects the frequency range.
10. **MODE SWITCH**
Selects a desired sideband (USB or LSB) in the MODE position. To turn on the meter light, set the switch to USB or LSB in the LIGHT position. The brightness of the light may be slightly dimmer in the USB mode than in the LSB mode. For CW operation, set at the USB mode.
11. **EXTERNAL SPEAKER JACK**
An external speaker can be connected here. The impedance of the speaker should be 8 ohms. With the external speaker connected, the built-in speaker will be disabled.
12. **KEY JACK**
Accepts a CW key for CW operation.
13. **MICROPHONE CONNECTOR**
A 600 ohm microphone is connected here.

14. SNAP LOCKS

Convenient snap-locks hold the sides in place. To remove them for any service or to replace the batteries, simply pull out on the center of the snap-locks and the cover can easily be removed. When replacing the covers be sure that you have placed the covers properly in the grooves provided, then push down on the center of the snap-lock (see page 4).

Note: when the sides are placed in the grooves, the snap-lock center must be pulled out.

15. SHOULDER STRAP BRACKET

Connect the shoulder strap here for easy carrying (see page 3).

16. WHIP ANTENNA

When not in use, the antenna should be fully collapsed. Extend completely for operation. Use care when expanding or compressing the antenna.

17. FLEXIBLE ANTENNA (see page 31)

A flexible antenna, such as the IC-FA1, can be used. Unscrew the whip antenna from the set and install the flexible antenna in its place.

18. MICROPHONE HANGER

When not in use, the mike can be hung out of the way.

19. EXTERNAL ANTENNA CONNECTOR

Any well regulated power supply with an output of 13.8 volts can be connected here, instead of using the batteries installed. Inserting the power plug into the jack disables the internal battery source. When the BC-20 nicad battery pack is used, the external power source will charge the batteries.

20. EXTERNAL ANTENNA RECEPTACLE

An external antenna of 50 ohms impedance can be connected here. If an external antenna is used, the built-in whip antenna should be completely collapsed or the flexible antenna should be disconnected.

21. IDENTIFICATION PLATE

States model number and serial number.

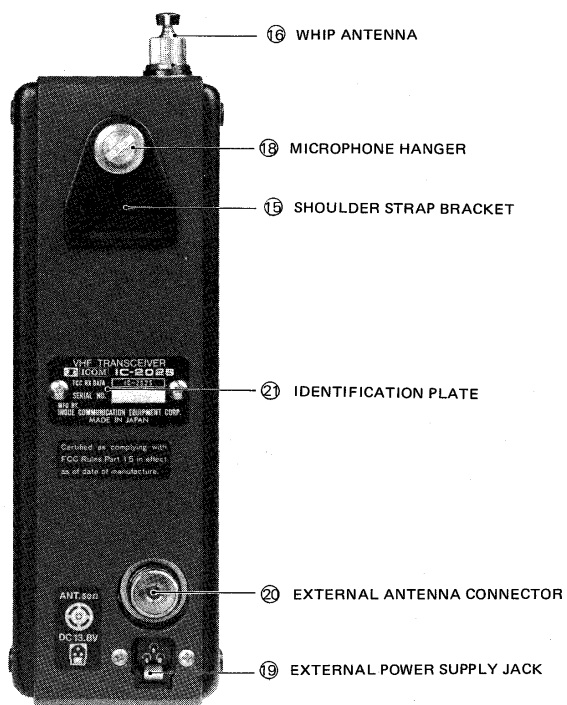

SECTION VI OPERATION

1. After the batteries have been installed, or the IC-202S is connected to an external power source, turn the **MODE** switch to the desired sideband in the **MODE** position. If the surrounding light is too dim to see the **S&RF** meter or frequency, turn the switch to the desired sideband in the **LIGHT** position, and the meter and dial will be illuminated.
2. Extend the whip antenna its full length, or if you wish to use an external antenna, connect the cable to the **EXTERNAL ANTENNA CONNECTOR** on the back of the IC-202S.
3. Connect the microphone to the **MICROPHONE CONNECTOR** on the front panel.
4. If you wish to use the **CW** mode of transmission, connect a key to the **KEY JACK** on the front panel. You do not have to disconnect the microphone for **CW** operation.

Key Wiring Diagram

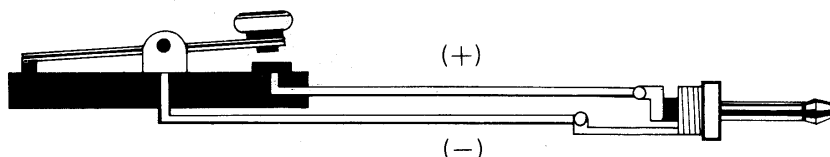

5. Place the **CRYSTAL** switch in the proper position for the portion of the 2 meter band you wish to operate in, whether it be **CW** or **SSB**. If you wish to operate outside of the 144.00–144.40MHz portion of the band, it will be necessary for you to install an additional crystal in one of the spare crystal sockets provided for this purpose. See page 12 for an explanation of how this is done. Crystals can be ordered from your authorized **ICOM** distributor or dealer.
6. Turn the tuning knob until you reach the desired frequency or a signal is heard. Adjust the volume control for a comfortable level of listening. You may wish to place the **Noise Blanker** switch in the **NB** position. This activates the noise blanking circuit which will suppress noise pulses. After selecting the operating frequency, if the received signal seems to drift, adjust the **RIT** control until the signal is again clear.
7. For **SSB** operation, hold the microphone close to your mouth, push the **PTT** switch on the microphone, and speak in a clear, normal tone of voice. For **CW** operation, after connecting your key and setting the **MODE** switch to the **USB** position, place the **CW** switch in the **CW-T** position and the IC-202S will transmit when the key contacts are closed. To receive, place the switch back in the **REC** position.

A/B POSITION SPARE CRYSTALS

The IC-202S comes with 2 crystals installed in the **VXO** for operation between 144.00–144.40MHz with each crystal covering 200KHz. If you wish to work another part of the

band, all that is needed is to install the proper frequency crystal in either the A or B spare crystal socket, tweak it, and you are ready for operation. Also a crystal can be installed to work the 145.80–146.00MHz portion of the band if you want to use OSCAR.

INSTRUCTIONS FOR INSTALLATION

Crystals 36-1 and 36-2 are already installed in the crystal sockets. These are for 144.00–144.20 (36-1) and 144.20–144.40MHz (36-2). Installing additional crystals in the spare crystal sockets in some positions and/or combinations may cause the output level of the operating crystal to decrease. This is due to absorption of some of the energy by the adjacent crystal.

BE SURE TO FOLLOW THE CHART EXACTLY AS TO POSITION AND COMBINATION OF THE SPARE CRYSTALS TO OBTAIN THE OPTIMUM PERFORMANCE.

	SPARE SOCKET	
	A	B
COMBINATION OF CRYSTALS	36-3	X
	36-5	X
	36-6	X
	X	36-4
	X	36-5
	X	36-6
	36-3	36-4
	36-3	36-6
	36-5	36-4
	36-6	36-4

For combinations of crystals other than those listed, a slight modification or realignment will probably be required. For communication through OSCAR (145.80–146.00MHz) realignment of various parts besides the readjustment of the oscillator frequency will be necessary.

Xtal No.	Center Freq.	Range	Type	Actual Xtal Freq.
36-1	144.100MHz	144.000–144.200MHz	HC-18/U	14848.83KHz*
36-2	144.300	144.200–144.400	HC-18/U	14871.06*
36-3	144.500	144.400–144.600	HC-25/U	14893.28
36-4	144.700	144.600–144.800	HC-25/U	14915.50
36-5	144.900	144.800–145.000	HC-25/U	14937.72
36-6	145.900MHz	145.800–146.000MHz	HC-25/U	15048.83KHz**

* Supplied in the transceiver

** For OSCAR use.

Note: a. Crystal load capacitance is 20pF.

b. The frequency of the crystal unit (actual crystal frequency) does not correspond to the oscillation frequency in the circuit.

CIRCUITS

Section X shows a block diagram of the IC-202S.

The receiving section is a single conversion superheterodyne, employing a wide band variable crystal oscillator (VXO) as the local oscillator. The transmitting section is a single conversion system which employs a filter-type SSB generator using a 10.7MHz crystal filter and the same local oscillator as the receiving section. A double-balanced mixer is used for the transmitting mixer to minimize spurious radiation. Although a portable unit, the IC-202S also features built-in circuits such as RIT, AGC, ALC, and a noise blanker.

RECEIVING CIRCUIT

The signal from the whip antenna or antenna terminal passes through the harmonic filter, through the T/R switching diode D26 (MI301), is amplified by RF amplifier Q2 (3SK40), and is then fed to the gate of mixer Q3 (2SK49). The switching diode D26 is turned ON with forward bias voltage by T/R control Q1 (2SA750), thus directing the input signal to Q2.

During transmission, the Receiver section +9V goes to zero to turn OFF Q1, and forward bias voltage is not applied to D26. At the same time, the transmit output is switched around Q2 to the antenna system. D26 is turned OFF as reverse bias is generated when the transmit signal is present. The 133MHz local oscillator output from the VXO is injected into mixer Q3 source through switching diode D28 (1SS53). The resultant conversion is an IF Frequency of 10.7MHz.

The IF signal passes through diode switch D1 (1SS53), which serves as both transmit-receive switch and noise blanker gate. IF selectivity is obtained by the 10.7MHz crystal filter, then the signal passes switching diode D3 (1SS53) and is amplified up to a suitable level by the IF amplifiers consisting of Q6 (MEM616), Q7 (MEM616) and IC1 (LA1221). The output of IC1 is applied to the demodulation and AGC circuits.

The detector circuit is a ring demodulator composed of D7 to D10 (1N60's) which uses the 10.6985MHz (USB), 10.7015MHz (LSB) from the BFO to generate the resultant audio signal. Higher audio frequencies of the demodulated signal are cut off by a low-pass filter consisting of C39, L11 and C40. The volume control (R-2) adjusts this output level which is fed to AF amplifier IC2 (μ PC575C2) providing 1 watt of audio.

The network R32 and D11 (1S1555) provides positive bias to IC2 for muting audio during transmit and silent transmit-receive switching.

NOISE BLANKER

A part of the IF signal is picked up at the drain of mixer Q3, amplified by IC3 and IC4 (LA1221's), and detected by D12 (1N60). This detected output is separated into signal audio components, and pulse components (noise). The signal component is amplified by Q4 (2SC945) and provides AGC control to IC3.

The noise pulse component turns ON Q5 (2SC945), and as long as noise exists, turns OFF noise blanker gate diode D1 by grounding its anode, thus the noise is not transferred to the crystal filter.

AGC CIRCUIT

A part of the IF signal is picked up from IF amplifier IC1 and passes through C76 and R57 to be detected by D15 (1N60), D16 and D17 (1S2473's). When no signal is received, bias voltage is applied to the base of AGC control Q10 (2SC945) through R56, D15 and D16, and the potential at the emitter of Q10 goes to nearly zero.

In the presence of a signal, C74 which is connected to Q10's base is first negatively charged because D16 is turned ON, and so Q10 is turned OFF. Also, C72 which is connected to Q10's emitter is negatively charged through D17 up to a voltage determined by the loop gain of each RF and IF amplifier, and C72 is kept at the achieved voltage due to the absence of a discharge circuit.

When the signal diminishes, the negative voltage charged in C75 is gradually discharged through R56 and drops down to a voltage where Q10 is turned ON. Then the negative voltage charged in C72 is rapidly discharged through Q10, thus the AGC time constant of fast attack and slow release is effected.

TRANSMITTING CIRCUIT

The small signal from the microphone is adjusted by the mike gain adjustment R17. Higher or lower frequencies outside desirable communication frequency range are attenuated by R68, C84 and C85, and the remaining frequencies are amplified by AF amplifier IC5 (μ PC566H).

This AF signal and BFO output (10.6985MHz USB, 10.6995MHz CW, 10.7015MHz LSB) are fed to the balanced modulator IC6 (SN76514N). The resulting carrier suppressed double sideband signal is amplified by IF amplifier Q15 (2SK19). The unwanted side band is then removed by the 10.7MHz crystal filter where it passes through the diode switch D2 (1SS53) to become a 10.7MHz SSB signal.

This 10.7MHz signal passes the diode switch D4 (1SS53) to the transmit mixer IC7 (SN76514N). The 133MHz L.O. signal from the VXO unit is then combined to become an SSB signal of 144MHz. The transmit mixer IC7 is a double-balanced mixer, which minimizes spurious radiation.

In addition, the output circuits of IC7 and the 144MHz amplifier Q16 (3SK37) provides band-pass filtering which further minimizes spurious radiation. This 144MHz SSB signal is linearly amplified by Q17 (2SC383), Q18 (2SC998), and Q19 (2SC1947) respectively. Higher harmonics are suppressed by the low-pass filter composed of L31, L32 and C148 to C152. The resultant output power is 3 Watts PEP. PA Q19 idling current is adjusted by R98. It is preset at 30mA.

ALC CIRCUIT

The ALC (Automatic Level Control) circuit picks out a part of the drive stage Q18 output, rectifies it by D23 (1S2473) and D24 (1N60), and applies the obtained negative voltage to the transmit IF amplifier Q15's gate to control circuit gain.

CW TRANSMISSION

For CW transmission, the voltage exerted on AF amplifier IC5 is reduced. At the same time the voltage to BFO frequency shift switch D13 (1SS53) is applied to turn it ON so that L15 is grounded as a part of the BFO crystal oscillator to shift the frequency about 1 KHz upward, which is within the crystal filter passband. Also, at the same time, the 5th Pin of the balanced modulator, IC6, is supplied with a voltage, which unbalances the modulator, so that the BFO frequency appears unsuppressed at the output. Consequently, these signals are amplified by the transmit IF amplifier Q15 and pass through the crystal filter, transmit mixer IC7 and forward as in the SSB mode. Keying is done at Q16's source and Q17's emitter. The 800Hz signal is oscillated by the CR phase oscillator Q3 (2SC945) for CW MONITOR and fed to the AF amplifier IC2 through the Volume Control.

COMMON CIRCUITS

BFO CIRCUIT

The BFO consists of a Colpitts crystal-oscillator Q8 (2SC945) and switching circuit D13 and D14. The crystal unit has only load capacitors C64 and 65 which are grounded through D14 and R46 in the LSB mode and operates at 10.7015MHz. In the USB mode, D14 is turned OFF, so that L15 and L16 are in series between C65 and the ground, and the circuit oscillates at 10.6985MHz. In CW transmit mode, D13 is turned ON and 10.6995MHz is oscillated with L16 and C65.

METER CIRCUIT

This circuit permits use of a single meter as an S-meter during reception and as an output level meter during transmission.

A bridge circuit composed of R53 and R54 is connected to the power source, stabilized by Zener diode D16 (WZ056), and the IF amplifier Q7 source. AGC voltage is generated by input signals reducing Q7's source voltage, thus unbalancing the bridge causing an upscale meter reading.

The S-meter is adjusted for its zero point by R53, and for its full scale point by R55.

For the output level meter, the output detection diode D27 (1N60) is coupled with L30 to partly rectify the RF output, thus giving an upscale relative output indication.

The extent of the meter indication can be adjusted by changing the degree of coupling of D27 and L30.

POWER SOURCE AND TRANSMIT/RECEIVE CHANGE-OVER CIRCUIT

The power source voltage (13.8V) is supplied from either the built-in batteries or external power source is connected to J10.

This voltage is directly applied to the AF power amplifier IC2 in the receiver section as well as to the collector of Q17, Q18 and Q19 in the power amplifier section.

Other circuits are fed with voltage from the voltage regulator circuits. The voltage regulator circuit for the VFO unit BFO and AGC circuits is derived from 13.8V to the Zener

diode D21 (XZ076) and POWER INDICATOR LED D-2 (light-emitting diode TLR-102), resulting in stabilized voltage of about 9.6V which becomes a reference level at D21's cathode. This voltage is applied to Q14's (2SC1209) base, and a regulated voltage of about 8.7V is available at its emitter.

The brightness of POWER INDICATOR LED varies according to the power voltage. When the power voltage drops to a level under about 10V, the current to D19 and D-2 stops, turning OFF D-2. Thus the power voltage fluctuation and battery condition can be judged from the D-2 Display. For the receiving section's regulated voltage supply the reference voltage of D19's cathode is applied to Q11's (2SD355) base through D18 (1S2473), and a regulated voltage of about 9.2V is obtained at its emitter.

When transmitting, R60 is grounded by the microphone PTT switch or CW switch (in the case of CW-T), to make Q11's base voltage zero and output voltage also zero.

Likewise, for the transmit section regulated voltage, the reference voltage of D19 cathode is applied to Q13's (2SD355) base through D19 (1S2473), and a regulated voltage of about 9.2V is obtained at its emitter.

During reception, since the PTT switch is not grounded, positive voltage is applied to the base of transmit/receive change-over control Q12 (2SC945) through R61 to turn it ON, while Q13's base is grounded through R62 and Q12, thus making the power voltage zero. When transmitting, the PTT switch is grounded and Q12's base is also grounded through D19 (1N60) to turn Q12 OFF and applies the reference voltage to Q13's base, and so a proper voltage is obtained. Also, the rise time for transmit/receive change-over is delayed by C11 and C78 respectively to prevent transmission signals from entering the receiving section during the change-over operation.

VXO UNIT

RIT CIRCUIT

During reception, when the RIT switch is turned ON, positive voltage is supplied to the base of Q1 (2SC945) through R1 and Q2's (2SC945) base through R4 to turn them ON. Varying the voltage supplied to D1 (MV201) by rotating the RIT control (R-1) varies the oscillating frequency of the VXO. When the RIT switch is in the OFF position or during transmission, both Q1 and Q2 are turned OFF and only the voltage divided by R2 and R3 is supplied, so that transmission can be made at dial-set frequencies irrespective of the position of RIT control. When the RIT is OFF, the receiving frequency is the same as the transmitting frequency.

VXO CIRCUIT

The oscillator Q4 (2SC1815), in series with a crystal and variable capacitor, varies its frequency by changing the capacity of the variable capacitor.

Resistors R13 to R16 are damping resistors to prevent abnormal oscillation. Capacitors C13 to C16 are linearity-adjusted for non-linearity frequency changes caused by any errors of the crystal unit and variable capacitor. L1 to L4 and C17 to C20 adjust the oscillation frequency and band width.

In this oscillator, a 14MHz signal is oscillated fundamentally, tripled by Q5 (2SC1815), tripled again by Q7 (2SC763) to a 133MHz signal with the level of 300mV as the first local oscillator. The band-pass filter composed of L7 to L9 minimizes spurious radiation.

Though the regulated voltage for the oscillator is supplied at a level of about 9 volts from Q14 of the main unit, it is further stabilized by the constant current circuit using Q6 (2SK19) and Zener diode D2 (WZ061). This voltage is supplied to Q4, Q5 and RIT circuit to further ensure sufficient frequency stability.

In the RIT circuit, the capacity of D1 is changed by voltage from R-1, RIT control, given through R17. C22 and C23 are connected in series, which keeps the RIT shift to approx. 2.5KHz.

SECTION VIII MAINTENANCE AND ADJUSTMENT

ADJUSTMENT OF VARIOUS SECTIONS

This set is completely adjusted and checked so that it functions correctly. During prolonged use, however, the preadjusted condition might be affected by wear of parts, etc. If it is necessary to make adjustments at some time to regain specified performance, the following procedures may be followed.

Remember that changes in capacitor or coils will be very small, if any. Adjustments should not be attempted without adequate test equipment.

VXO UNIT ADJUSTMENT

1. Measuring Instruments for Adjustment:
 - * RF voltmeter (with over 1V full scale capability at 150MHz)
 - * Frequency counter (capable of measuring 150MHz)
 - * Multimeter (20Kohm per volt)
2. Frequency Adjustment:
 - a. Connect the frequency counter to J7 of the VXO unit, with ground connected to J8.
 - b. Place the RIT at the OFF position. Set the crystal switch to the position of the crystal to be aligned.
 - c. Set the tuning dial to "100", and adjust the appropriate coil until the frequency shown in the chart on page 18 is obtained.
 - d. Next set the dial to "200" and adjust trimmer (a) for the proper frequency according to the chart.
 - e. Set the dial now to "0" and adjust trimmer (b) for the proper frequency.
 - f. Repeat the adjustment above till no further adjustment is necessary to get the proper frequencies at all three points.

Crystal No.	Dial		
	0	100	200
36-1	133.3015 MHz	133.4015 MHz	133.5015 MHz
36-2	133.5015	133.6015	133.7015
36-3	133.7015	133.8015	133.9015
36-4	133.9015	134.0015	134.1015
36-5	134.1015	134.2015	134.3015
36-6	135.1015	135.2015	135.3015

Note: Refer to page 12 for crystal data.

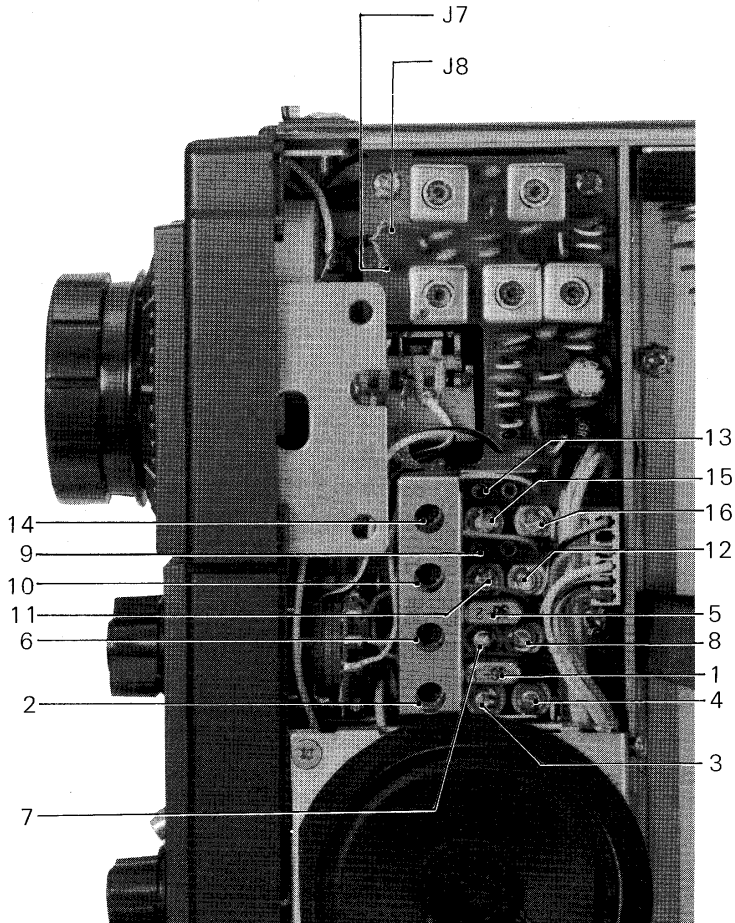

1. Crystal for 144.0MHz band
2. Coil for 144.0MHz band
3. Trimmer (a) for 144.0MHz band
4. Trimmer (b) for 144.0MHz band
5. Crystal for 144.2MHz band
6. Coil for 144.2MHz band
7. Trimmer (a) for 144.2MHz band
8. Trimmer (b) for 144.2MHz band

9. Additional Crystal Socket "A"
10. Coil for the "A" band
11. Trimmer (a) for the "A" band
12. Trimmer (b) for the "A" band
13. Additional Crystal Socket "B"
14. Coil for the "B" band
15. Trimmer (a) for the "B" band
16. Trimmer (b) for the "B" band

ADJUSTMENTS OF MULTIPLIER STAGES

For receiving, set the crystal selector to "144.2" and the tuning knob to the "200" position (the receiving frequency is 144.4MHz), connect a multimeter (3 volt range) to check point R27 and tune L5 and L6 for maximum indication. Connect the probe of an RF voltmeter to the output terminal J7 of VXO and tune L7 ~ L9 for maximum indication. Further, readjust L5 and L6 and repeat this procedure to obtain the maximum indication on the RF voltmeter (250 – 300mV).

RIT ADJUSTMENT

In the receive mode connect the frequency counter to J7, set the RIT knob to the center and record the frequency (the dial scale may be set at any position but do not change it during the adjustment).

Next, turn the CW switch to "CW-T" without connecting the key to the key jack, then check the frequency again. If it differs from the previously recorded frequency, adjust R2 to equalize both frequencies.

Repeat above adjustments to reduce the frequency difference between reception and transmission to under 10Hz.

TRANSMITTING SECTION ADJUSTMENT

a. Measuring Instruments for Adjustment

- * Terminal wattmeter (for about 10W full scale with 50 ohm impedance)
- * Frequency counter
- * RF voltmeter
- * AF oscillator
- * AF millivoltmeter
- * Multimeter (20Kohm per volt)

b. Final Stage Idle Current Adjustment

Turn the CW switch to "CW-T" without connecting the key to the key jack. Remove the solder of C144 and W25, and connect the multimeter, which is set at 100mA range, between these points. Adjust R98 so that the current becomes 30mA. After the adjustment, resolder the leads of C144 and W25.

c. Coil Adjustment

Connect the wattmeter to the external antenna socket, and set the transmit/receive frequency at "144.4MHz". With the CW switch set to "CW-T", connect the key to the key jack and hold down the key. Connect the RF voltmeter probe to check point CP3 and adjust the cores of L18 to L21 alternately for a maximum voltmeter reading.

d. Driver and Final Stage Adjustments

Make sure that the power voltage is 13.8V under the same condition as in (c). Turn the R99 rotor toward ground (to panel face) and adjust C125, C126, C133, C134, C146 and C147 so that the wattmeter indicates maximum (over 3W). After this, adjust R99 so that the wattmeter indicates exactly 3W. Set the multimeter to the 1 volt range and connect to check point CP4. Readjust L18 to L21 for maximum indication.

e. **RF Meter Adjustment**

Move D27 with respect to L30 (coupling) so that the meter indicates about 90% of full scale when the output is 3W at the completion of adjustment (d).

f. **Carrier Frequency Adjustment**

When in receive and with the mode switch in the LSB position, connect a frequency counter to check point CP5 and adjust C64 for 10.7015MHz. Change the mode switch to the USB position, set the CW switch to the CW-T and adjust L16 for 10.6995MHz. Then set the CW switch to the REC position and adjust L15 for 10.6985MHz. Turn the MODE switch to LSB and connect the AF oscillator to check point, CP2. Ground the Microphone connector pin No. 2 for SSB transmission, and set the AF oscillator frequency at 1.5KHz. Adjust the RF output level to 2.0W. Keeping the output level of the AF oscillator unchanged, alternately change the audio oscillator frequency from 300Hz to 3KHz, and fine adjust C64 to balance the RF output.

Place the MODE switch to USB and adjust L15 the same as the adjustments done in LSB. Repeat adjustments in LSB and USB until no difference is present.

g. **Mic Gain Adjustment**

Connect the AF oscillator between the Microphone connector pins No.1 and No.4 (ground). Set its frequency at 1.5KHz and output level at 2mV.

Ground the Microphone connector pin No. 2 and connect the AF millivoltmeter (300mV range) to check point CP2 and adjust R67 so that the meter reads 100mV. This adjustment can be slightly changed according to the use of microphone, strength of voice, condition, etc. Observation of the output carrier on a high frequency oscilloscope would be helpful while using normal microphone procedures in order to achieve optimum waveform and quality.

RECEIVING SECTION ADJUSTMENT

a. **Measuring Instruments for Adjustment**

- * Standard signal generator (for 144MHz band)
- * AF millivoltmeter
- * Multimeter

b. **Sensitivity Adjustment**

With the receiving frequency set at 144.4MHz and MODE switch in the LSB or USB position and the volume control knob set to a reasonable volume position, connect the standard signal generator to the external antenna connector and the AF millivoltmeter (1V range) to the AF output terminals J4 and J5 (ground).

(Never transmit during this adjustment because it may damage the signal generator attenuators.)

Keeping the signal generator unmodulated, set the output level at about 30dB (μ V) and adjust the generator frequency to the receiving frequency. As a beat is heard from the speaker, fine-adjust the signal generator frequency or receiving frequency

so that the beat becomes about 1000Hz. Try to keep the beat at this frequency during the adjustment.

Next, adjust L1-L10 cores successively to maximize the AF millivoltmeter indication, and if the AF millivoltmeter becomes full-scale, lower the signal generator output level without converting the meter range or turning the volume control knob, etc. Repeat the adjustment until the AF millivoltmeter indicates over 800mV with the volume control knob at maximum and S+N/N becomes over 10dB when the signal generator output level is -10dB (μ V).

c. **S-Meter Adjustment**

Adjust R53 so that the S-meter indicates zero with no signal. Next, with the signal generator output level set at 90dB (μ V), adjust the frequency to the receiving frequency, and adjust R55 so that the S-meter indicates full scale. After this adjustment is finished, lower the signal generator output level, and make sure that the signal generator output is within a range of 0dB \pm 3dB when the S-meter indicates S5.

d. **Noise Blanker Adjustment**

Set the signal generator output level at about 30dB (μ V), and adjust to the receiving frequency. Making sure that the beat is generated from the speaker, connect the multimeter (0.3V range) to check point CP1, and gradually lower the signal generator output level and adjust L12 to a point where the indication is maximum.

SECTION IX INSIDE VIEW

MAIN BOARD SIDE

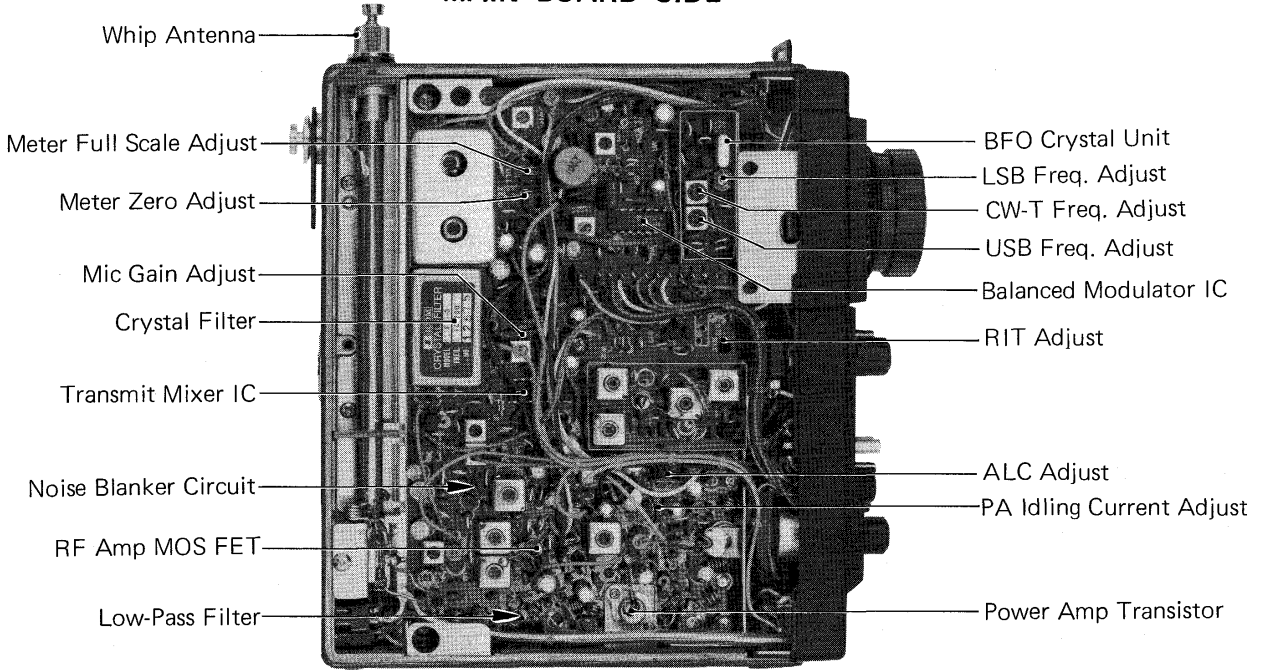

SPEAKER SIDE

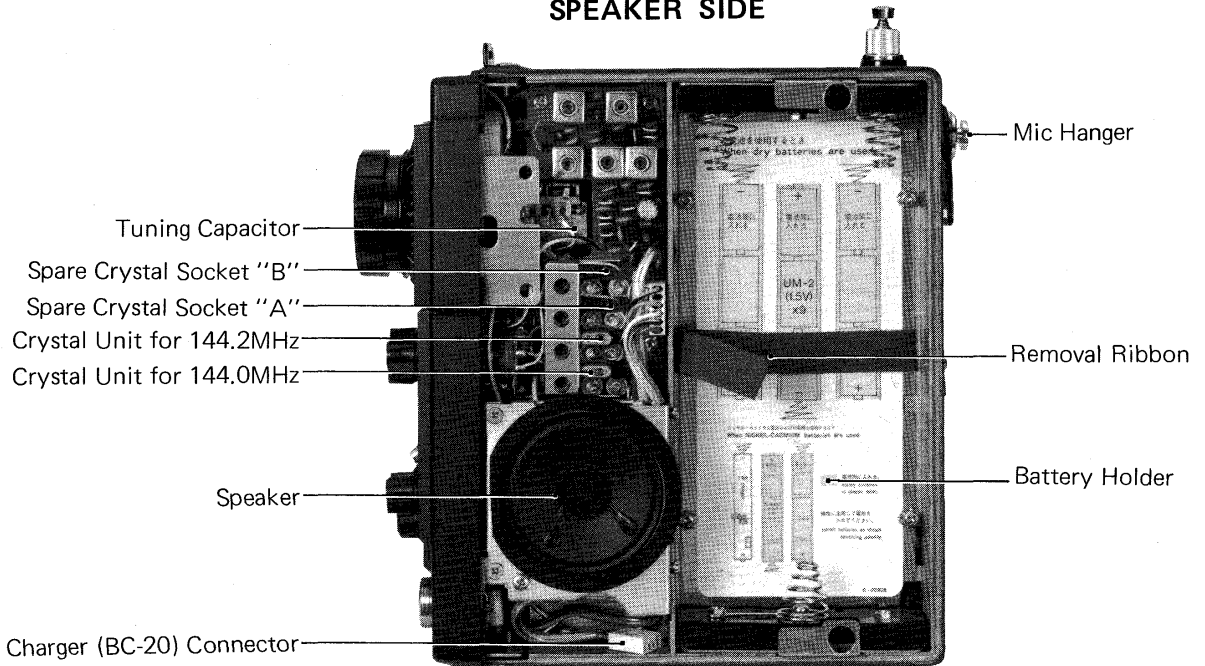

SECTION X BLOCK DIAGRAM

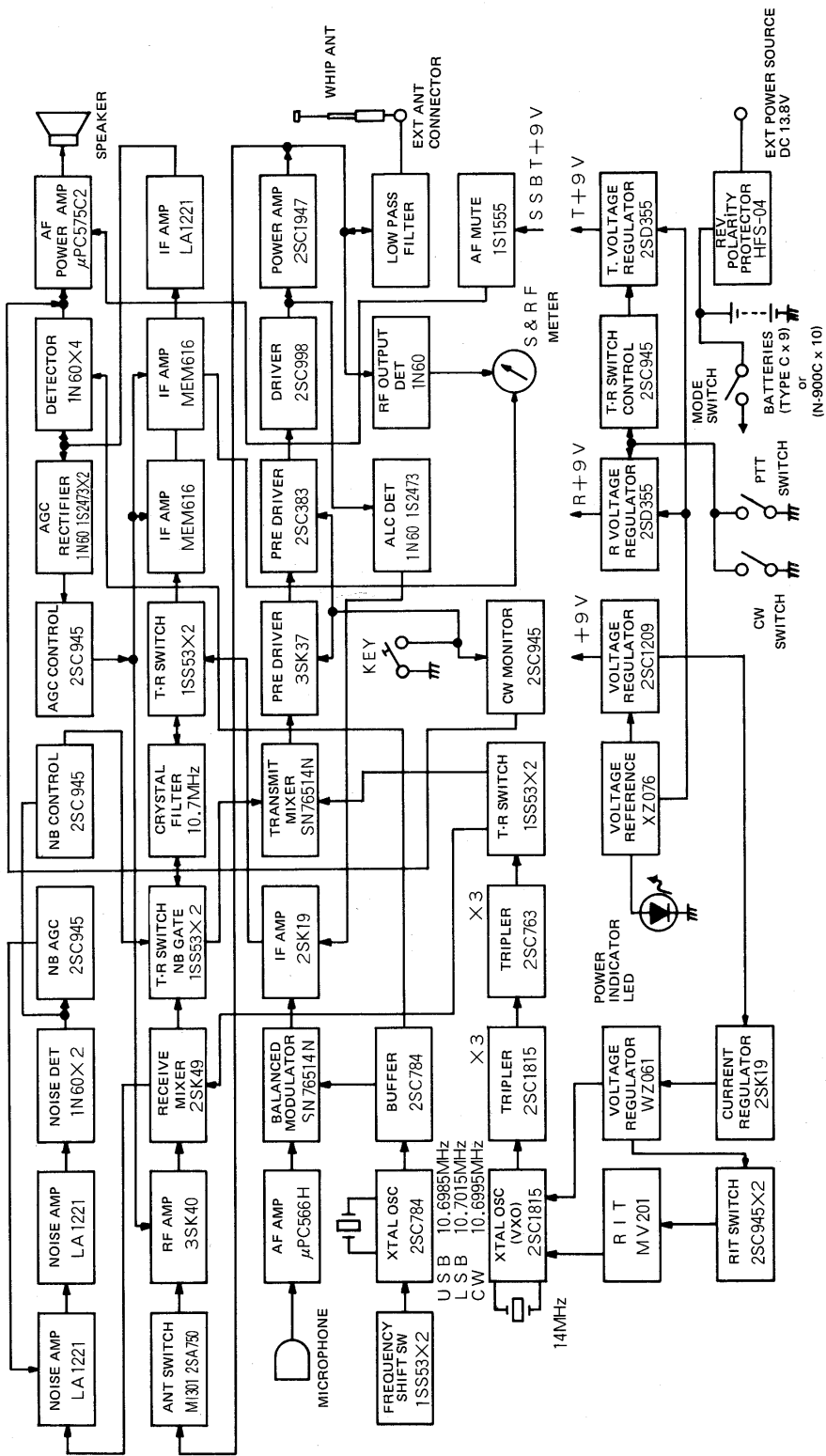

SECTION XI PARTS LIST

MAIN UNIT			Board Location
Ref. No.	Description	Part No.	Board Location
Q1	Transistor	2SA750(1)	I4
Q2	FET	3SK40-M	I3
Q3	FET	2SK49-H2	H2
Q4	Transistor	2SC945-P	G1
Q5	Transistor	2SC945-P	F1
Q6	FET	MEM616-Y	C1
Q7	FET	MEM616-B	B2
Q8	Transistor	2SC784-BN	A6
Q9	Transistor	2SC784-BN	B5
Q10	Transistor	2SC945-R	A5
Q11	Transistor	2SD355-E	E5
Q12	Transistor	2SC945-P	D5
Q13	Transistor	2SD355-E	D3
Q14	Transistor	2SC1209-E	E5
Q15	FET	2SK19-GR	C3
Q16	FET	3SK37-3	F5
Q17	Transistor	2SC383	G6
Q18	Transistor	2SC998	I6
Q19	Transistor	2SC1947	J4
IC1	IC	LA1221	B3
IC2	IC	μ PC575C2	Q3
IC3	IC	LA1221	H1
IC4	IC	LA1221	H1
IC5	IC	μ PC566H	D2
IC6	IC	SN76514N	C5
IC7	IC	SN76514N	F3
D1	Diode	1SS53	F2
D2	Diode	1SS53	F2
D3	Diode	1SS53	C2
D4	Diode	1SS53	C2
D5	Diode	1N60	C2
D6	Diode	WZ056	B1
D7	Diode	1N60	B4
D8	Diode	1N60	B4
D9	Diode	1N60	B4
D10	Diode	1N60	B4
D11	Diode	1S1555	A5
D12	Diode	1N60	I1
D13	Diode	1SS53	C6
D14	Diode	1SS53	C6
D15	Diode	1N60	A4
D16	Diode	1S2473	A5
D17	Diode	1S2473	A5
D18	Diode	1S2473	E4
D19	Diode	1N60	D5
D20	Diode	1S2473	E4
D21	Diode	XZ076	E4
D22	Diode	1S1555	H6
D23	Diode	1S2473	I5
D24	Diode	1N60	I5
D25	Diode	1S1555	I4
D26	Diode	MI301	J3

MAIN UNIT				Board Location
Ref. No.	Description	Part No.	Board Location	Board Location
D27	Diode	1N60		J3
D28	Diode	1SS53		Q2
D29	Diode	1SS53		Q3
FL1	Xtal Filter	FEC-103-1 10.7MHz		E1
X1	Xtal	HC-18/U 10.7015MHz		B6
L1	Coil	LS-4		I4
L2	Coil	LS-3A		I2
L3	Coil	LS-3A		I2
L4	Coil	LS-3A		H2
L5	Coil	LS-7		G2
L6	Coil	LS-7		G2
L7	Coil	LS-66A		C1
L8	Coil	LS-66A		B1
L9	Coil	LS-66A		A2
L10	Coil	LS-68		B4
L11	Choke Coil	RFC 104 (100mH)		B3
L12	Coil	LS-7		I1
L13	Choke Coil	RFC 101 (100 μ H)		I1
L14	Choke Coil	RFC 101 (100 μ H)		I1
L15	Coil	LS-111		C5
L16	Coil	LS-111		C5
L17	Choke Coil	RFC 101 (100 μ H)		A3
L18	Coil	LS-67		C4
L19	Coil	LS-67		E2
L20	Coil	LS-3A		F4
L21	Coil	LS-3A		G4
L22	Coil	LS-3A		F5
L23	Coil	LS-3A		F6
L24	Coil	LA-96		G6
L25	Coil	LA-71		H6
L26	Coil	LA-2		I6
L27	Coil	LA-9		J6
L28	Coil	LA-97		J5
L29	Coil	LA-9		J4
L30	Coil	LA-2		J3
L31	Coil	LA-71		J2
L32	Coil	LA-71		J1
L33	Choke Coil	RFC 100 (10 μ H)		I5
L34	Choke Coil	RFC 101 (100 μ H)		A4
R1	Resistor	470 ohm	ELR25	I3
R2	Resistor	4.7K ohm	ELR25	I4
R3	Resistor	100K ohm	ELR25	I3
R4	Resistor	100K ohm	ELR25	H3
R5	Resistor	100K ohm	ELR25	I3
R6	Resistor	47 ohm	ELR25	H3
R7	Resistor	22 ohm	ELR25	I2
R8	Resistor	4.7K ohm	ELR25	H1
R9	Resistor	1K ohm	ELR25	H2
R10	Resistor	220 ohm	ELR25	G1
R11	Resistor	4.7K ohm	ELR25	G1
R12	Resistor	10K ohm	ELR25	F1

MAIN UNIT				Board
Ref. No.	Description	Part No.	Location	
R13	Resistor	12K ohm ELR25	F2	
R14	Resistor	39K ohm ELR25	F2	
R15	Resistor	10K ohm ELR25	D2	
R16	Resistor	10K ohm ELR25	D1	
R17	Resistor	100K ohm ELR25	C1	
R18	Resistor	10K ohm R25	C1	
R19	Resistor	22K ohm ELR25	C1	
R20	Resistor	100K ohm ELR25	C1	
R21	Resistor	100 ohm ELR25	B2	
R22	Resistor	220 ohm ELR25	B1	
R23	Resistor	6.8K ohm ELR25	B1	
R24	Resistor	470 ohm ELR25	A1	
R25	Resistor	220 ohm ELR25	B2	
R26	Resistor	4.7K ohm ELR25	A2	
R27	Resistor	220 ohm ELR25	A2	
R28	Resistor	470 ohm R25	B4	
R29	Resistor	470 ohm ELR25	B4	
R30	Resistor	820 ohm ELR25	B4	
R31	Resistor	39K ohm ELR25	B3	
R32	Resistor	4.7K ohm ELR25	A6	
R33	Resistor	270 ohm ELR25	G3	
R34	Resistor	47K ohm ELR25	H3	
R35	Resistor	150K ohm ELR25	H3	
R36	Resistor	120K ohm ELR25	H4	
R37	Resistor	2.2K ohm ELR25	G1	
R38	Resistor	1K ohm ELR25	H1	
R39	Resistor	10K ohm ELR25	G1	
R40	Resistor	22K ohm R25	F1	
R41	Resistor	27K ohm ELR25	F1	
R42	Resistor	100K ohm R25	D5	
R43	Resistor	6.8K ohm ELR25	C5	
R44	Resistor	680 ohm ELR25	C6	
R45	Resistor	2.2K ohm ELR25	C6	
R46	Resistor	220 ohm R25	D6	
R47	Resistor	100K ohm ELR25	C6	
R48	Resistor	100K ohm ELR25	A6	
R49	Resistor	47K ohm ELR25	A5	
R50	Resistor	2.2K ohm ELR25	B6	
R51	Resistor	4.7K ohm ELR25	B6	
R52	Resistor	2.2K ohm ELR25	B5	
R53	Trimmer	1K ohm FR-10	C3	
R54	Resistor	2.2K ohm ELR25	B2	
R55	Trimmer	5K ohm FR-10	B3	
R56	Resistor	1.8M ohm ELR25	A5	
R57	Resistor	100 ohm ELR25	A4	
R58	Resistor	10 ohm ELR25	E4	
R59	Resistor	4.7K ohm ELR25	E4	
R60	Resistor	22 ohm ELR25	E5	
R61	Resistor	22K ohm ELR25	D4	
R62	Resistor	22 ohm ELR25	D4	
R63	Resistor	4.7K ohm ELR25	D4	
R64	Resistor	22 ohm ELR25	D4	
R65	Resistor	470 ohm ELR25	E5	
R66	Resistor	22 ohm ELR25	E5	

MAIN UNIT				Board
Ref. No.	Description	Part No.	Location	
R67	Trimmer	500 ohm FR-10	E3	
R68	Resistor	2.2K ohm ELR25	E2	
R69	Resistor	150K ohm ELR25	D2	
R70	Resistor	56K ohm ELR25	D3	
R71	Resistor	560 ohm ELR25	D3	
R72	Resistor	15K ohm ELR25	E3	
R73	Resistor	330 ohm ELR25	D3	
R74	Resistor	2.7K ohm ELR25	D5	
R75	Resistor	100 ohm ELR25	D4	
R76	Resistor	100 ohm ELR25	C2	
R77	Resistor	150 ohm ELR25	C2	
R78	Resistor	220 ohm ELR25	C3	
R79	Resistor	10K ohm ELR25	E3	
R80	Resistor	4.7K ohm ELR25	G3	
R81	Resistor	47 ohm ELR25	E3	
R82	Resistor	100K ohm ELR25	F4	
R83	Resistor	100 ohm ELR25	F5	
R84	Resistor	100K ohm ELR25	F5	
R85	Resistor	100 ohm ELR25	G5	
R86	Resistor	470 ohm R25	F6	
R87	Resistor	2.7K ohm ELR25	G6	
R88	Resistor	47 ohm R25	F6	
R89	Resistor	2.2K ohm R25	G6	
R90	Resistor	47 ohm ELR25	G6	
R91	Resistor	1.8K ohm ELR25	H6	
R92	Resistor	10 ohm R25	H6	
R93	Resistor	680 ohm ELR25	H5	
R94	Resistor	47K ohm R25	C3	
R95	Resistor	4.7 ohm R25	J5	
R96	Resistor	220 ohm ELR25	J5	
R97	Resistor	220 ohm ELR25	I5	
R98	Trimmer	500 ohm FR-10	H5	
R99	Trimmer	5K ohm FR-10	H5	
R100	Resistor	2.2K ohm ELR25	B3	
R101	Resistor	470 ohm R50	J3	
R102	Resistor	220 ohm ELR25	G5	
R103	Resistor	4.7K ohm ELR25	G2	
R104	Resistor	68 ohm ELR25	G3	
C1	Ceramic	0.01 μ F 50V	I4	
C2	Ceramic	10pF 50V	H4	
C3	Ceramic	0.001 μ F 50V	H3	
C4	Ceramic	0.01 μ F 50V	I3	
C5	Ceramic	0.001 μ F 50V	I4	
C6	Ceramic	0.01 μ F 50V	H3	
C7	Ceramic	0.01 μ F 50V	I3	
C8	Ceramic	0.01 μ F 50V	I3	
C9	Ceramic	0.01 μ F 50V	I3	
C10	Ceramic	7pF 50V	I2	
C11	Ceramic	0.35pF 50V	I2	
C12	Ceramic	6pF 50V	H2	
C13	Ceramic	0.35pF 50V	H2	
C14	Ceramic	7pF 50V	H2	
C15	Ceramic	0.01 μ F 50V	H2	

MAIN UNIT				Board Location
Ref. No.	Description	Part No.		
C16	Ceramic	1pF	50V	H1
C17	Ceramic	0.01 μ F	50V	H2
C18	Ceramic	4pF	50V	G1
C19	Ceramic	470pF	50V	F2
C20	Ceramic	0.01 μ F	50V	H1
C21	Ceramic	0.01 μ F	50V	F2
C22	Ceramic	0.01 μ F	50V	D2
C23	Ceramic	0.01 μ F	50V	D1
C24	Ceramic	0.01 μ F	50V	C1
C25	Ceramic	0.01 μ F	50V	C2
C26	Ceramic	0.001 μ F	50V	C1
C27	Ceramic	0.01 μ F	50V	C1
C28	Ceramic	0.01 μ F	50V	C2
C29	Ceramic	0.01 μ F	50V	B2
C30	Ceramic	0.001 μ F	50V	B2
C31	Ceramic	0.01 μ F	50V	B1
C32	Ceramic	0.01 μ F	50V	B2
C33	Ceramic	0.01 μ F	50V	B2
C34	Ceramic	0.01 μ F	50V	A2
C35	Ceramic	10pF	50V	B3
C36	Ceramic	0.01 μ F	50V	B3
C37	Ceramic	120pF	50V	B4
C38	Ceramic	0.01 μ F	50V	B4
C39	Mylar	0.056 μ F	50V	C4
C40	Mylar	0.056 μ F	50V	C4
C41	Semi-conductive	0.2 μ F	12V	B4
C42	Electrolytic	1 μ F	50V	H3
C43	Electrolytic	470pF	50V	G3
C44	Electrolytic	4.7 μ F	25V	H4
C45	Electrolytic	47 μ F	16V	H4
C46	Electrolytic	10 μ F	16V	G3
C47	Ceramic	470pF	50V	G3
C48	Electrolytic	47 μ F	16V	G3
C49	Ceramic	0.001 μ F	50V	H3
C50	Electrolytic	100 μ F	10V	G4
C51	Semi-conductive	0.2 μ F	12V	G4
C52	Ceramic	0.01 μ F	50V	G1
C53	Electrolytic	1 μ F	50V	G1
C54	Ceramic	0.001 μ F	50V	H1
C55	Ceramic	0.01 μ F	50V	H1
C56	Ceramic	0.01 μ F	50V	H1
C57	Ceramic	0.001 μ F	50V	I1
C58	Ceramic	47pF	50V	I1
C59	Ceramic	47pF	50V	I2
C60	Ceramic	0.001 μ F	50V	F1
C61	Ceramic	0.01 μ F	50V	G1
C62	Ceramic	0.0047 μ F	50V	C6
C63	Ceramic	0.0047 μ F	50V	C6
C64	Trimmer	18pF (CV05D180)		B6
C65	Ceramic	15pF	50V	B6
C66	Ceramic	0.0047 μ F	50V	C6
C67	Styrene	220pF (CTC-1H-221J)		A6
C68	Styrene	100pF (STC-1H-101J)		B6
C69	Ceramic	0.0047 μ F	50V	B5

MAIN UNIT				Board Location
Ref. No.	Description	Part No.		
C70	Ceramic	56pF	50V	B5
C71	Ceramic	56pF	50V	B5
C72	Electrolytic	56pF	50V	A4
C73	Ceramic	0.01 μ F	50V	B5
C74	Electrolytic	4.7 μ F25V (Bi polar)		A5
C75	Ceramic	0.01 μ F	50V	B5
C76	Ceramic	0.001 μ F	50V	A4
C77	Electrolytic	10 μ F	16V	E5
C78	Electrolytic	10 μ F	16V	E3
C79	Ceramic	0.01 μ F	50V	E4
C80	Ceramic	0.01 μ F	50V	D3
C81	Ceramic	0.04 μ F	50V	E4
C82	Electrolytic	10 μ F	16V	E5
C83	Ceramic	0.01 μ F	50V	E5
C84	Ceramic	0.01 μ F	50V	E2
C85	Mylar	0.0022 μ F	50V	D2
C86	Ceramic	470pF	50V	D3
C87	Electrolytic	10 μ F	16V	D2
C88	Electrolytic	47 μ F	10V	D2
C89	Electrolytic	4.7 μ F25V (Bi polar)		D3
C90	Electrolytic	10 μ F	16V	C5
C91	Ceramic	0.01 μ F	50V	B5
C92	Ceramic	0.01 μ F	50V	C5
C93	Ceramic	0.01 μ F	50V	C5
C94	Ceramic	0.01 μ F	50V	C4
C95	Electrolytic	10 μ F	16V	C4
C96	Ceramic	47pF	50V	C4
C97	Ceramic	0.01 μ F	50V	C3
C98	Electrolytic	10 μ F	16V	D3
C99	Ceramic	0.01 μ F	50V	C2
C100	Ceramic	0.01 μ F	50V	C3
C101	Ceramic	0.01 μ F	50V	E3
C102	Ceramic	47pF	50V	F2
C103	Ceramic	0.01 μ F	50V	F3
C104	Ceramic	0.01 μ F	50V	F2
C105	Ceramic	0.01 μ F	50V	F3
C106	Ceramic	0.01 μ F	50V	G3
C107	Ceramic	0.01 μ F	50V	F3
C108	Electrolytic	10 μ F	16V	F3
C109	Ceramic	0.01 μ F	50V	E3
C110	Ceramic	7pF	50V	F4
C111	Ceramic	8pF	50V	F4
C112	Ceramic	6pF	50V	G4
C113	Ceramic	0.01 μ F	50V	E5
C114	Ceramic	0.01 μ F	50V	G5
C115	Ceramic	0.01 μ F	50V	F5
C116	Ceramic	0.01 μ F	50V	G5
C117	Ceramic	6pF	50V	F5
C118	Ceramic	0.01 μ F	50V	G5
C119	Ceramic	6pF	50V	F6
C120	Ceramic	8pF	50V	F6
C121	Ceramic	120pF	50V	F6
C122	Ceramic	0.01 μ F	50V	G6
C123	Ceramic	0.01 μ F	50V	G5

MAIN UNIT				
Ref. No.	Description	Part No.		Board Location
C124	Ceramic	0.01 μ F	50V	G6
C125	Trimmer	12pF (CV05C120)		H6
C126	Trimmer	18pF (CV05D180)		H6
C127	Electrolytic	10 μ F	16V	H6
C128	Ceramic	0.01 μ F	50V	H5
C129	Ceramic	0.01 μ F	50V	I5
C130	Electrolytic	10 μ F	50V	I6
C131	Feed Through	0.001 μ F	50V	I6
C132	Ceramic	0.01 μ F	50V	I5
C133	Trimmer	12pF (CV05C120)		I6
C134	Trimmer	50pF (CVE50-11)		J6
C135	Ceramic	15pF	50V	I5
C136	Ceramic	10pF	50V	I5
C137	Ceramic	0.01 μ F	50V	H5
C138	Electrolytic	4.7 μ F	16V	H5
C139	Ceramic	0.01 μ F	50V	I5
C140	Electrolytic	10 μ F	16V	I5
C141	Ceramic	0.01 μ F	50V	I5
C142	Ceramic	0.01 μ F	50V	I4
C143	Electrolytic	10 μ F	16V	J4
C144	Feed Through	0.001 μ F	50V	I4
C145	Ceramic	10pF	50V	J4
C146	Trimmer	18pF (CV05D 180)		J4
C147	Trimmer	50pF (CVE50-11)		J3
C148	Ceramic	15pF	50V	J2
C149	Ceramic	6pF	50V	J2
C150	Ceramic	33pF	50V	J2
C151	Ceramic	2pF	50V	J2
C152	Ceramic	22pF	50V	J1
C153	Ceramic	0.01 μ F	50V	J3
C154	Electrolytic	33 μ F	10V	I3
C155	Ceramic	0.01 μ F	50V	G2
C156	Ceramic	0.01 μ F	50V	B1
C157	Ceramic	0.001 μ F	50V	G3
J1	Pincontact	171255-1		B2
J2	Pincontact	171255-1		B3
J3	Pincontact	171255-1		C3
J4	Pincontact	171255-1		H4
J5	Pincontact	171255-1		H5
J6	Pincontact	171255-1		H4
J7	Pincontact	171255-1		H4
J8	Pincontact	171255-1		I1
J9	Pincontact	171255-1		B3
J10	Pin connector	1281210181P		D4~6
J11	Pincontact	171255-1		E2
J12	Pincontact	171255-1		E2
J13	Pincontact	171255-1		A6
J14	Eyelet	2 x 3		J1
J15	Eyelet	2 x 3		J1
J16	Pincontact	171255-1		G2
J17	Pincontact	171255-1		G2

VXO UNIT				
Ref. No.	Description	Part No.		Board Location
Q1	Transistor	2SC945-P		D2
Q2	Transistor	2SC945-P		D2
Q3	Transistor	2SC945-P		D1
Q4	Transistor	2SC1815-Y		B2
Q5	Transistor	2SC1815-Y		B2
Q6	FET	2SK19-GR		B2
Q7	Transistor	2SC763-C		A2
D1	Diode	MV201		C1
D2	Diode	WZ061		B2
X1	Xtal	36-1 HC-18/U		C2
X2	Xtal	36-2 HC-18/U		C2
L1	Coil	LB-28B		C1
L2	Coil	LB-28B		C1
L3	Coil	LB-28B		C1
L4	Coil	LB-28B		B1
L5	Coil	LS-2		A2
L6	Coil	LS-2		A2
L7	Coil	LS-3A		A2
L8	Coil	LS-3A		A1
L9	Coil	LS-3A		A1
R1	Resistor	100K ohm	ELR25	D2
R2	Trimmer	50K ohm	RGP102	C2
R3	Resistor	33K ohm	ELR25	D2
R4	Resistor	10K ohm	ELR25	D2
R5	Resistor	2.2K ohm	ELR25	D2
R6	Resistor	4.7K ohm	ELR25	D2
R7	Resistor	4.7K ohm	ELR25	D1
R8	Resistor	4.7K ohm	ELR25	D1
R9	Resistor	1M ohm	ELR25	D1
R10	Resistor	4.7K ohm	ELR25	D1
R11	Resistor	22K ohm	ELR25	D1
R12	Resistor	22K ohm	ELR25	D1
R13	Resistor	100K ohm	ELR25	D2
R14	Resistor	100K ohm	ELR25	C2
R15	Resistor	100K ohm	ELR25	C2
R16	Resistor	100K ohm	ELR25	B2
R17	Resistor	220K ohm	ELR25	C1
R18	Resistor	10K ohm	ELR25	B2
R19	Resistor	22K ohm	ELR25	B2
R20	Resistor	470 ohm	ELR25	B2
R21	Resistor	22K ohm	ELR25	B2
R22	Resistor	10K ohm	ELR25	B2
R23	Resistor	330 ohm	ELR25	B2
R24	Resistor	220 ohm	ELR25	B2
R25	Resistor	3.9K ohm	ELR25	A2
R26	Resistor	15K ohm	ELR25	A2
R27	Resistor	330 ohm	R25	A1
R28	Resistor	220 ohm	ELR25	A2
C1	Ceramic	0.001 μ F	50V	D2

MAIN UNIT				Board Location
Ref. No.	Description	Part No.		
C2	Ceramic	0.001 μ F	50V	D2
C3	Ceramic	0.001 μ F	50V	D2
C4	Ceramic	0.001 μ F	50V	D2
C5	Ceramic	0.001 μ F	50V	D2
C6	Ceramic	0.001 μ F	50V	D2
C7	Mylar	0.01 μ F	50V	D1
C8	Mylar	0.01 μ F	50V	D1
C9	Mylar	0.01 μ F	50V	D1
C10	Ceramic	470pF	50V	D2
C11	Mylar	0.0033 μ F	50V	D1
C12	Mylar	0.01 μ F	50V	D1
C13	Trimmer	5pF (CV05A050)		D2
C14	Trimmer	5pF (CV05A050)		C2
C15	Trimmer	5pF (CV05A050)		C2
C16	Trimmer	5pF (CV05A050)		C2
C17	Trimmer	12pF (CV05C120)		D1
C18	Trimmer	12pF (CV05C120)		C1
C19	Trimmer	12pF (CV05C120)		C1
C20	Trimmer	12pF (CV05C120)		C1
C21	Ceramic	0.01 μ F	50V	D1
C22	Ceramic	10pF(CH)	50V	C1
C23	Ceramic	3pF(CH)	50V	C1
C24	Ceramic	5pF(CH)	50V	C1
C25	Electrolytic	33 μ F	10V	B2
C26	Ceramic	0.01 μ F	50V	B2
C27	Ceramic	0.01 μ F	50V	B2
C28	Ceramic	100pF (YL)		B2
C29	Ceramic	10pF (CH)		B2
C30	Ceramic	200pF (XL)		B2
C31	Ceramic	200pF (XL)		B2
C32	Ceramic	200pF (XL)		B2
C33	Ceramic	0.01 μ F	50V	B2
C34	Ceramic	0.01 μ F	50V	B2
C35	Ceramic	39pF (PH)		A2
C36	Ceramic	1pF	50V	A2
C37	Ceramic	47pF (PH)	50V	A2
C38	Ceramic	0.01 μ F	50V	B2
C39	Ceramic	47pF	50V	A2
C40	Ceramic	0.01 μ F	50V	A2
C41	Ceramic	8pF	50V	A2
C42	Ceramic	0.01 μ F	50V	A2
C43	Ceramic	6pF	50V	A1
C44	Ceramic	8pF	50V	A1
C45	Ceramic	0.35pF	50V	A1
C46	Ceramic	8pF	50V	A1
J1	Connector	5045-06A		C2
J2	Eyelet	2 x 3		D2
J3	Eyelet	2 x 3		D1
J4	Eyelet	2 x 3		D1
J5	Eyelet	2 x 3		C1
J6	Eyelet	2 x 3		B1
J7	Pincontact	171255-1		A1
J8	Pincontact	171255-1		A1

S1	Xtal Socket Rotary switch (CRYSTAL)	380-598-2 ESR-E134K20Z		
FRONT PANEL AND FRAME				
Ref. No.	Description	Part No.		
D1	Diode (LED)	TLR-102		
D2	Diode	1N60		
D3	Diode	1SS53		
D4	Diode	HFS-04		
D5	Diode	1N60		
L1	Choke Coil	RFC 102 (1mH)		
L2	Coil	LA-2		
C1	Electrolytic	1000 μ F	16V/T	
C2	Ceramic	0.001 μ F	50V	
C3	Ceramic	0.001 μ F	50V	
C4	Electrolytic	4.7 μ F	25V	
C5	Electrolytic	10 μ F	16V	
C6	Variable (TUNE)	C321A		
C7	Ceramic	47pF	50V	
C8	Ceramic	0.001 μ F	50V	
C9	Ceramic	0.001 μ F	50V	
R1	Variable (RIT)	10K ohm PR123S6515K		
R2	Variable (VOL)	10K ohm PR-18-15K		
R3	Resistor	22 ohm	R50	
R4	Resistor	4.7K ohm	R25	
R5	Resistor	470 ohm	R25	
M1	Meter	YN30-1		
SP1	Speaker	6S03		
PL1	Lamp	BQ054-322522A		
S1	Switch (CW SW)	SLC-22C		
S2	Switch (NB SW)	SLC-22C		
S3	Rotary switch (MODE SW)	ESR-E125K20Z		
J1	Connector (ANT)	MRB		
J2	4P Base (MIC)	4P-B		
J3	3P Connector (POWER)	S-16942		
J4	Phone Jack (EXT SPK)	SJ-0296		
J5	Phone Jack (KEY)	SJ-296		
P1	Connector	1281210281S		
P2	Connector	3021-06N		
P3	Connector	3021-04N		
	PC Board	B-159 (LED)		
	PC Board	B-249 (MIC)		
	Tuning Knob	N-16A (40811)		
	RIT Knob	N-33 (41408)		
	VOL Knob	N-33 (41408)		
	CRYSTAL SW Knob	N-32 (41407)		
	MODE SW Knob	N-32 (41407)		

SECTION XIII VOLTAGE CHART

Unit	Q No.	Mode	Transistor			FET				Remarks
			(B)	(C)	(E)	(G1)	(G2)	(D)	(S)	
Main Unit	Q1	R	8.2	8.9	8.9					NB-ON NB-ON
	Q1	T	0	0	0					
	Q2	R				0	4.0	8.8	0.25	
	Q3	R				0		9.1	0.76	
	Q4	R	0	2.0	GND					
	Q5	R	0	6.5	GND					
	Q6	R				0	4.2	8.8	0.35	
	Q7	R				0	5.4	8.8	0.65	
	Q8	R	2.9	5.1	2.3					
	Q9	R	2.4	5.1	2.6					
	Q10	R	0.05	GND	0					
	Q10	T	0.05	GND	0					
	Q11	R	9.9	12.2	9.2					
	Q11	T	0	13.0	0					
	Q12	R	0.65	0	GND					
	Q12	T	0.23	9.8	GND					
	Q13	R	0	13.2	0					
	Q13	T	9.8	11.3	9.2					
	Q14	R	9.3	12.2	8.7					
Q15	T				0					
Q16	T				0	4.1	7.2	1.0		
Q17	T	1.5	12.0	0.6			8.9	0.45		
Q17	R	0	13.2	0						
Q18	T	0.72	13.2	GND						
Q18	R	0	13.2	GND						
Q19	T	0.75	13.2	GND						
Q19	R	0	13.2	GND						
VXO Unit	Q1	R	6.4	5.8	5.8					RIT-ON RIT-ON
	Q2	R	0.67	0	GND					
	Q3	T	0.55	5.1	GND					
	Q4	R&T	1.8	5.8	1.0					
	Q5	R&T	1.6	8.0	1.1					
	Q6					5.8		8.7	5.8	
	Q7		1.55	7.7	1.6					

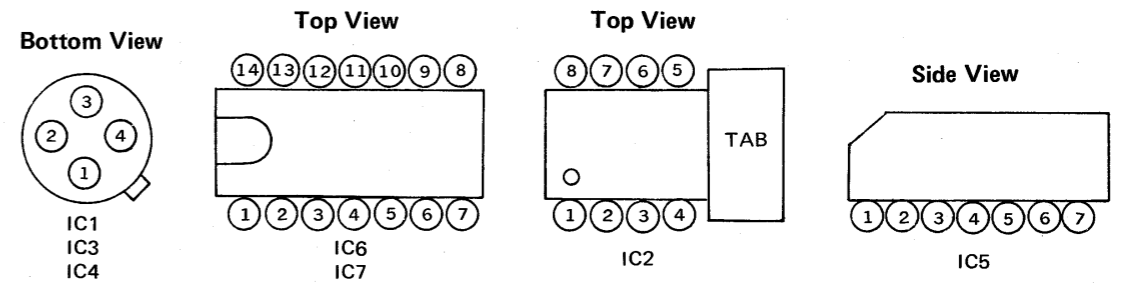

Unit	IC No.	Mode	Pin No.														Remarks
			1	2	3	4	5	6	7	8	9	10	11	12	13	14	
Main Unit	IC1	R	9.3	9.3	2.0	GND											
	IC2	R	1.6	13.0	12.0	7.3	6.1	13.0	0.21	1.7							
	IC2	T	1.7	13.0	12.8	0	0.55	13.0	0	4.9							
	IC3	R	6.8	8.2	2.05	GND											
	IC4	R	9.1	9.2	2.05	GND											
	IC5	T	1.5	0.6	0.12	GND	0.77	5.0	9.3								
	IC6	T	0	9.0	8.2	4.5	2.5	GND	GND	GND	2.5	4.3	4.5	4.5	8.2	GND	CW-T
IC6	T	0	8.5	6.0	5.8	4.9	GND	GND	GND	4.7	5.4	5.5	5.5	6.0	GND		
IC7	T	E	9.0	7.8	4.5	2.8	GND	GND	GND	2.8	4.4	6.1	6.1	8.0	GND		

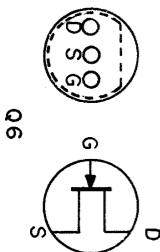
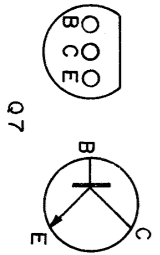
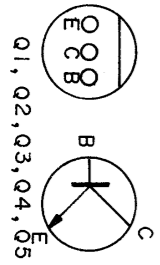
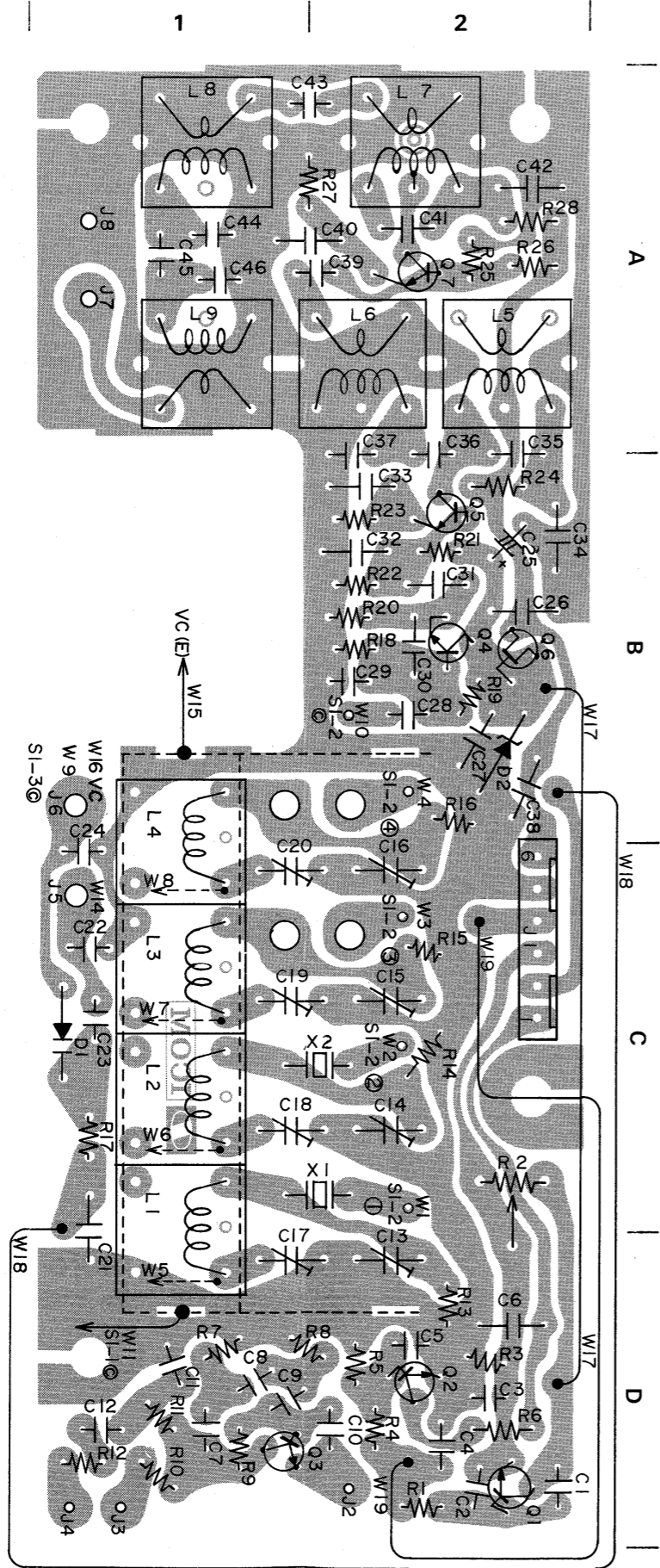

BOARD LAYOUT

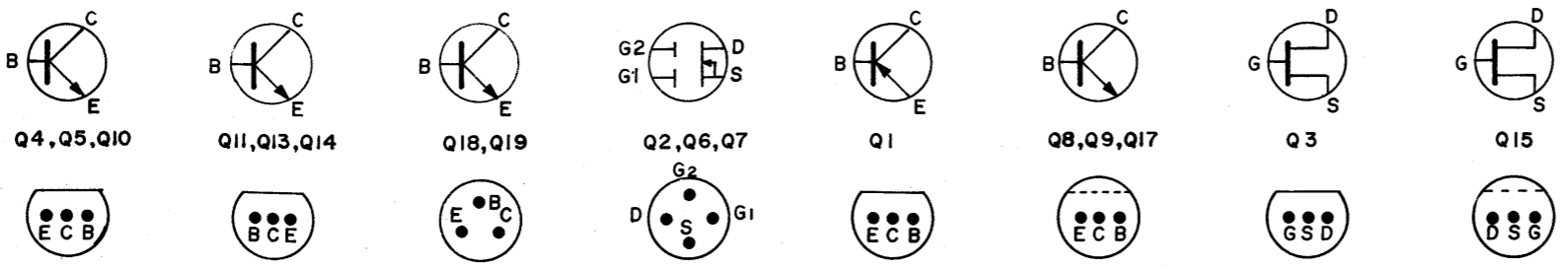
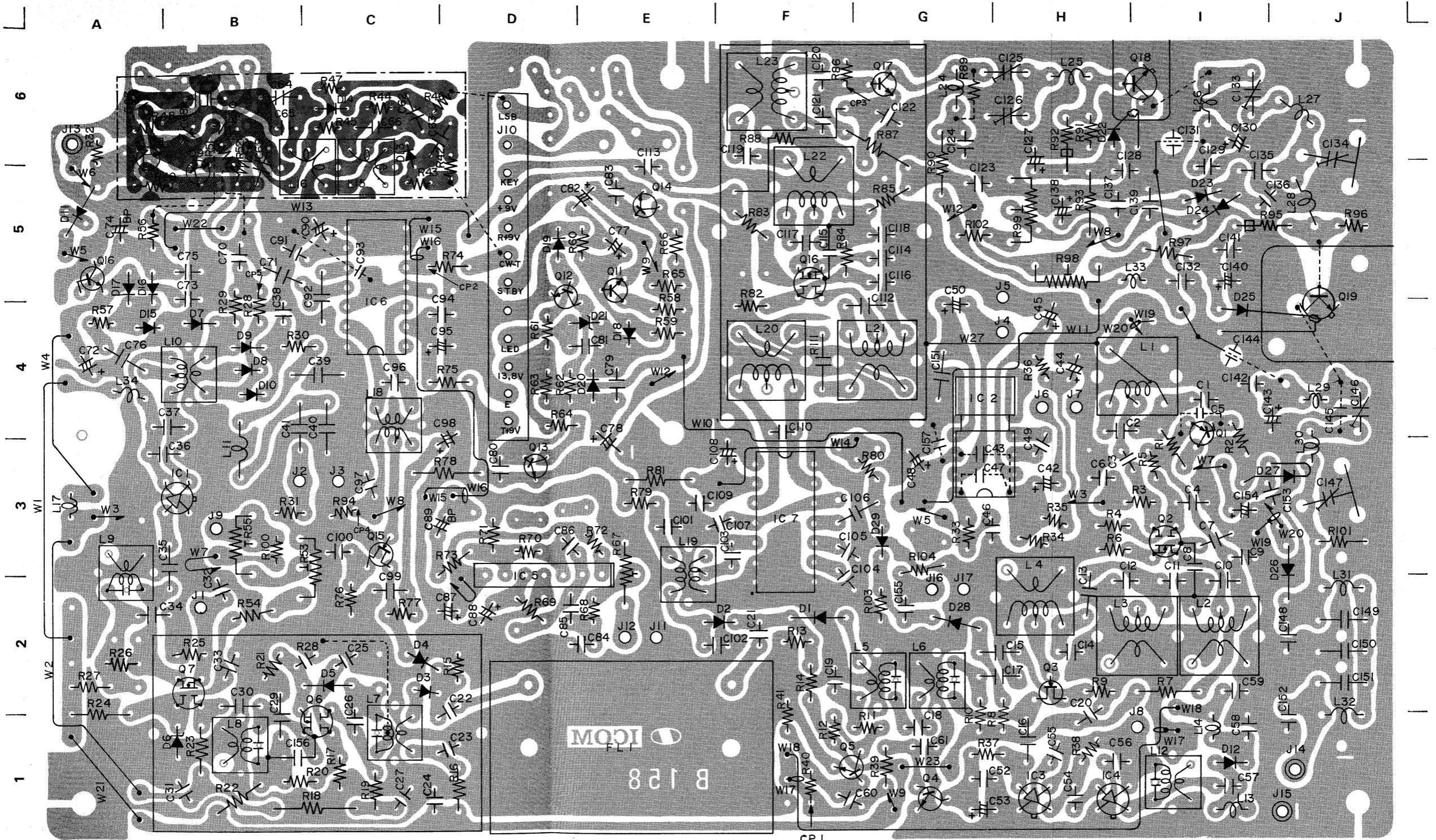

SECTION XIV OPTIONS

We have prepared a variety of options for the portable transceiver IC-202S in order to enlarge its use as a portable, mobile and fixed set.

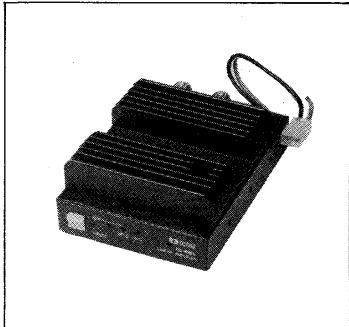

**IC-20L
LINEAR AMPLIFIER
144MHz 10W**

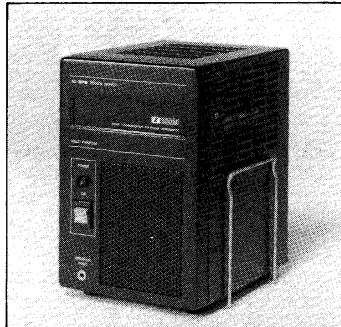

**IC-3PS
POWER SUPPLY
13.8V 3A**

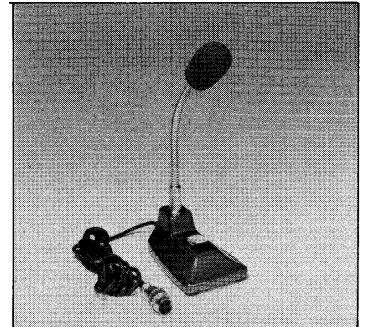

**IC-SM2
DESK MICROPHONE
ELECTRET CONDENSER
TYPE**

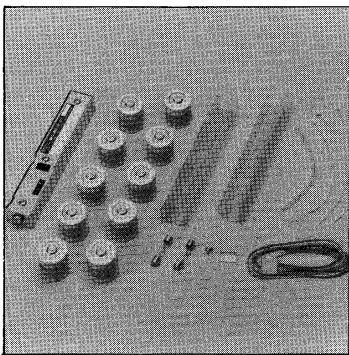

**RECHARGEABLE
BATTERY PACK
BATTERY CHARGER BC-20
BATTERY N-900 x 10
(900 mAh)**

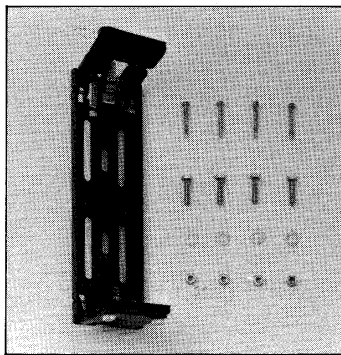

**MOBILE MOUNTING
BRACKET (B)
FOR IC-202S**

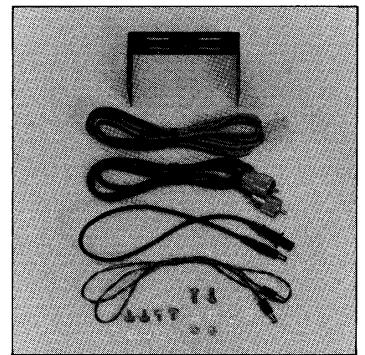

**MOBILE MOUNTING
KIT FOR IC-20L**

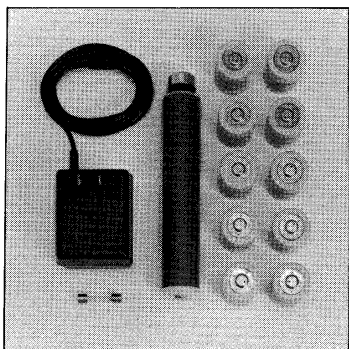

**RECHARGEABLE
BATTERY PACK
AC BATTERY CHARGER
BC-15
BATTERY N-900 C x 10
(900 mAh)**

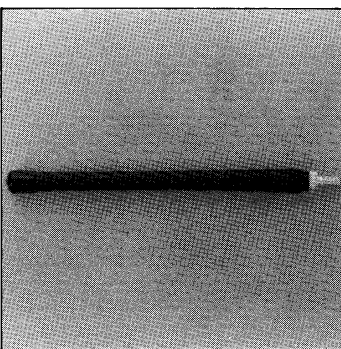

**IC-FA1
FLEXIBLE
ANTENNA**

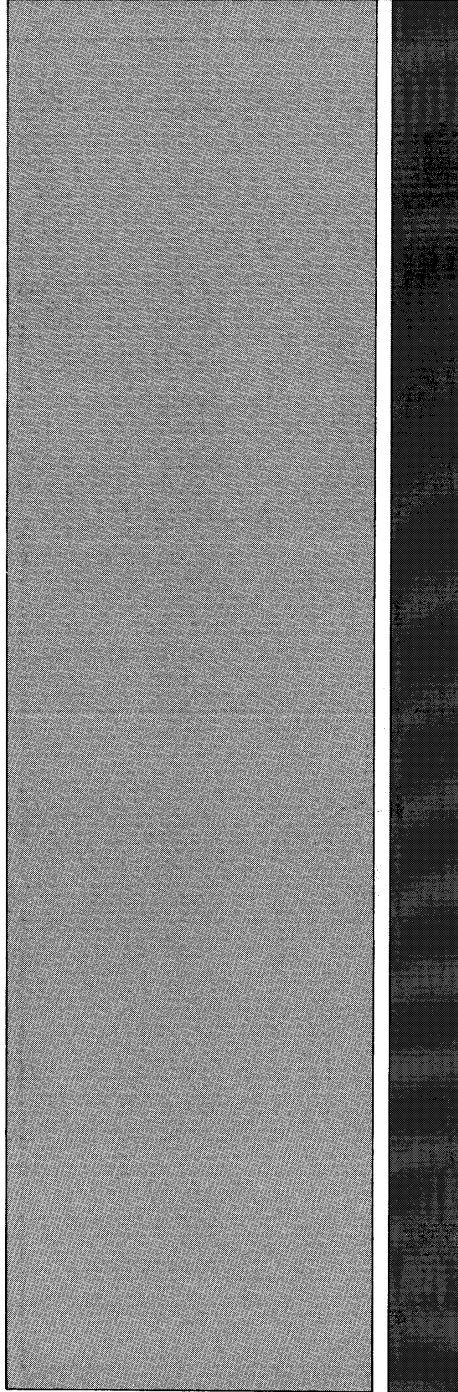

ICOM INCORPORATED

**1-6-19, KAMI KURATSUKURI, HIRANO-KU,
OSAKA JAPAN**

