



INSTRUCTION MANUAL

144 MHz FM TRANSCEIVER
IC-2100H

This device complies with Part 15 of the FCC rules. Operation is subject to the following two conditions: (1) This device may not cause harmful interference, and (2) this device must accept any interference received, including interference that may cause undesired operation.

Icom Inc.

KB2LJJ Radio Mods Database

FOREWORD

Thank you for purchasing this Icom product. The IC-2100H/-T 144 MHz FM TRANSCEIVER is designed and built with Icom's superior technology and craftsmanship. With proper care this product should provide you with years of trouble-free operation.

IMPORTANT

READ ALL INSTRUCTIONS carefully and completely before using the transceiver.

SAVE THIS INSTRUCTION MANUAL—This instruction manual contains important operating instructions for the IC-2100H/-T.

EXPLICIT DEFINITIONS

WORD	DEFINITION
⚠ WARNING	Personal injury, fire hazard or electric shock may occur.
CAUTION	Equipment damage may occur.
NOTE	If disregarded, inconvenience only. No risk of personal injury, fire or electric shock.

CAUTIONS

⚠ WARNING! NEVER connect the transceiver to an AC outlet. This may pose a fire hazard or result in an electric shock.

⚠ WARNING! NEVER operate the transceiver while driving a vehicle. Safe driving requires your full attention—anything less may result in an accident.

NEVER connect the transceiver to a power source of more than 16 V DC. This will ruin the transceiver.

NEVER connect the transceiver to a power source using reverse polarity. This will ruin the transceiver.

NEVER cut the DC power cable between the DC plug and fuse holder. If an incorrect connection is made after cutting, the transceiver may be damaged.

NEVER place the transceiver where normal operation of the vehicle may be hindered or where it could cause bodily injury.

NEVER let objects impede the operation of the cooling fan on the rear panel.

DO NOT push the PTT when not actually desiring to transmit.

DO NOT allow children to play with any radio equipment containing a transmitter.

SUPPLIED ACCESSORIES

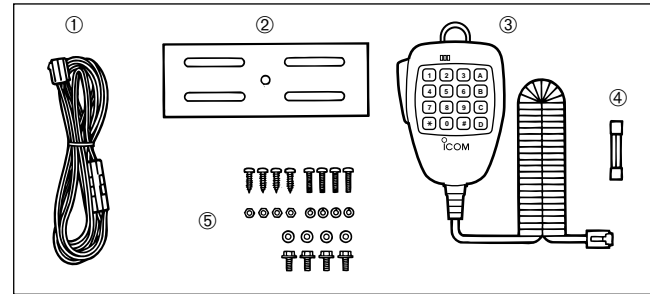

- ① DC power cable 1
- ② Mobile mounting bracket 1
- ③ Microphone (HM-118T*) 1
- ④ Fuse (20 A) 1
- ⑤ Mounting screws, nuts and washers 1 set
- ⑥ Mic hanger (depending on version) 1

*The microphone illustrated above is the HM-118T.

- HM-97 Europe versions
- HM-98S USA, Taiwan versions
- HM-118 Asia, Australia versions
- HM-118T Thailand, Latin America, Korea versions
- HM-118TA some USA versions

During mobile operation, **DO NOT** operate the transceiver without running the vehicle's engine. When transceiver power is ON and your vehicle's engine is OFF, the vehicle's battery will soon become exhausted.

BE CAREFUL! The transceiver will become hot when operating it continuously for long periods.

AVOID using or placing the transceiver in direct sunlight or in areas with temperatures below -10°C ($+14^{\circ}\text{F}$) or above $+60^{\circ}\text{C}$ ($+140^{\circ}\text{F}$).

AVOID the use of chemical agents such as benzine or alcohol when cleaning, as they can damage the transceiver's surfaces.

USE Icom microphones only (supplied or optional). Other manufacturer's microphones have different pin assignments and may damage the transceiver if attached.

For U.S.A. only

Caution: Changes or modifications to this transceiver, not expressly approved by Icom Inc., could void your authority to operate this transceiver under FCC regulations.

TABLE OF CONTENTS

FOREWORD	ii	4 BASIC OPERATION	17–19
IMPORTANT	ii	■ Receiving	17
EXPLICIT DEFINITIONS	ii	■ Monitor function	17
CAUTIONS	ii	■ Audio mute function	17
SUPPLIED ACCESSORIES	iii	■ Transmitting	18
TABLE OF CONTENTS	iv	■ Selecting output power	18
		■ One-touch PTT function	19
1 PANEL DESCRIPTION	1–8	5 REPEATER OPERATION	20–24
■ Front panel	1	■ Accessing a repeater	20
■ Function display	3	■ Subaudible tones	22
■ Rear panel	5	■ Offset frequency	23
■ Microphone	6	■ Auto repeater	24
■ Microphone keypad	7	■ Repeater lockout	24
2 INSTALLATION	9–11	6 MEMORY OPERATION	25–30
■ Location	9	■ General description	25
■ Using the mounting bracket	9	■ Memory channel selection	25
■ Battery connection	10	■ Programming a memory channel	26
■ DC power supply connection	10	■ Programming a memory channel via the microphone	27
■ Antenna installation	11	■ Transferring memory contents	28
		■ Clearing a memory	29
		■ Alphanumeric display	30
3 SETTING A FREQUENCY	12–16	7 CALL CHANNEL OPERATION	32–33
■ Preparation	12	■ Calling up the call channel	32
■ Lock functions	13	■ Transferring call channel contents	32
■ Using the tuning dial	14	■ Programming the call channel	33
■ Using the [▲]/[▼] keys	14		
■ Tuning step selection	15		
■ Using the keypad	16		

8 SCRATCH PAD MEMORY	34–35		
■ What is scratch pad memory?	34		
■ Calling up a scratch pad memory	34		
■ Transferring scratch pad memory contents	35		
9 SCAN OPERATION	36–41		
■ Scan types	36		
■ Scan start/stop	37		
■ Programming scan edges	38		
■ Programming scan edges via the microphone	39		
■ Skip channel setting	40		
■ Scan resume condition	41		
10 PRIORITY WATCH	42–43		
■ Priority watch types	42		
■ Priority watch operation	43		
11 DTMF MEMORY ENCODER	44–45		
■ Programming a DTMF code	44		
■ Transmitting a DTMF code	45		
■ DTMF speed	45		
12 POCKET BEEP AND TONE SQUELCH	46–48		
■ Pocket beep operation	46		
■ Tone operation	47		
■ Tone scan	48		
13 WIRELESS OPERATION	49–54		
■ Connection	49		
		■ HM-90 WIRELESS MICROPHONE	49
		■ EX-1759 installation	50
		■ HM-90 switches	51
		■ Microphone address	54
14 OTHER FUNCTIONS	55–59		
■ Beep tones ON/OFF	55		
■ Time-out timer	55		
■ Auto power-off	56		
■ Squelch delay	56		
■ Microphone [F-1]/[F-2] keys	57		
■ Demonstration display	57		
■ Display color	58		
■ Display dimmer	58		
■ FM narrow mode	58		
■ Data cloning	59		
15 MAINTENANCE	60–62		
■ Troubleshooting	60		
■ Fuse replacement	62		
■ Partial CPU resetting	62		
■ Resetting the CPU	62		
16 SPECIFICATIONS	63		
17 OPTIONS	64–65		
18 MODE ARRANGEMENT	66–67		

1

PANEL DESCRIPTION

■ Front panel

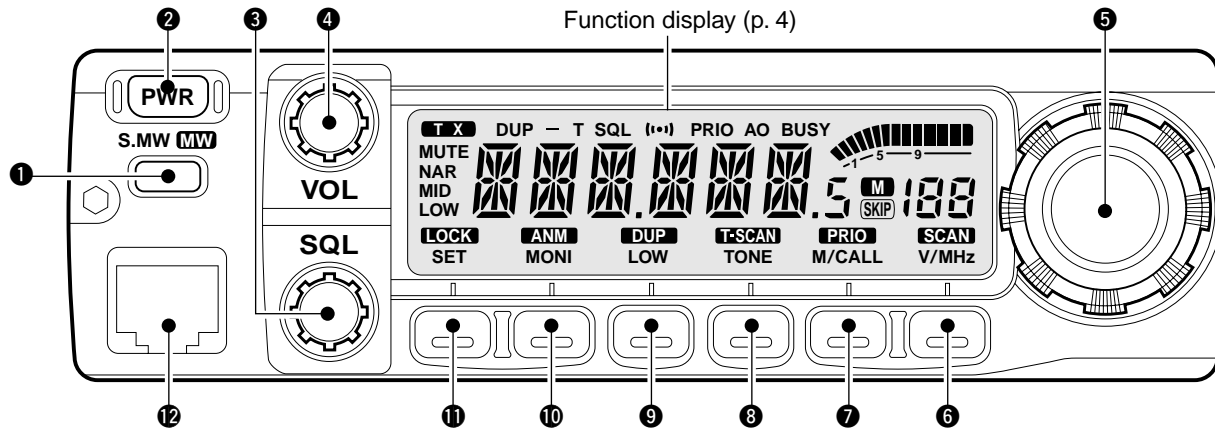

1 SELECT MEMORY/MEMORY WRITE SWITCH [S.MW(MW)]

- Selects a memory channel for programming. (p. 26)
- Programs selected memory when pushed and held. (p. 27)

2 POWER SWITCH [PWR]

Turns power ON and OFF when pushed momentarily.

3 SQUELCH CONTROL [SQL]

Varies the squelch level. (p. 18)

- The RF attenuator activates and increases the attenuation when rotated clockwise to the center position and further.

4 VOLUME CONTROL [VOL]

Adjusts the audio level. (p. 18)

5 TUNING DIAL

Selects the operating frequency (p. 15), the memory channel (p. 26), the contents of the set mode display and the scanning direction (p. 37).

6 VFO/MHz SWITCH [V/MHz(SCAN)]

- Selects and toggles VFO mode and the 1 MHz/10 MHz/TS tuning display. (p. 15)
- Starts a scan when pushed and held for 1 sec. (p. 37)

7 MEMORY/CALL CHANNEL SWITCH [M/CALL(PRIO)]

- ➔ Selects and toggles memory mode or the call channel. (pgs. 26, 32)
- ➔ Activates the priority watch function when pushed and held. (p. 42)

8 TONE/TONE SCAN SWITCH [TONE(T-SCAN)]

- ➔ Each push selects a tone function. (p. 46)
 - Tone encoder, pocket beep, tone squelch or tone function OFF can be selected.
- ➔ Push and hold to start/stop the tone scan function. (p. 48)

9 OUTPUT POWER/DUPLEX SWITCH [LOW(DUP)]

- ➔ Each push changes the output power selection. (p. 19)
 - There are 3 output powers available: low, mid and high (the IC-2100-T Thailand and IC-2100H Taiwan versions have only 2 output powers).
- ➔ Push and hold to select a duplex setting. (p. 21)
 - There are 3 duplex settings available: minus duplex (“DUP-” appears), plus duplex (“DUP” appears) and simplex (no indicator appears).

10 MONITOR/ALPHANUMERIC SWITCH [MONI(ANM)]

- ➔ Toggles squelch opened and closed when pushed. (p. 18)
- ➔ In memory and call channel mode, toggles the alphanumeric channel indication ON and OFF. (p. 31)

11 SET/LOCK SWITCH [SET(LOCK)]

- ➔ Selects set mode when pushed.
- ➔ Toggles the lock function ON and OFF when pushed and held. (p. 14)

12 MICROPHONE CONNECTOR

Connects the supplied microphone. (p. 7)

◇ **Microphone connector (front panel view)**

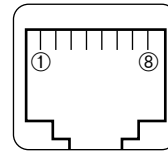

- ① +8 V DC output
- ② Frequency up/down
- ③ NC (no connection)
- ④ PTT
- ⑤ GND (microphone ground)
- ⑥ MIC (microphone input)
- ⑦ GND
- ⑧ NC (no connection)

1 PANEL DESCRIPTION

■ Function display

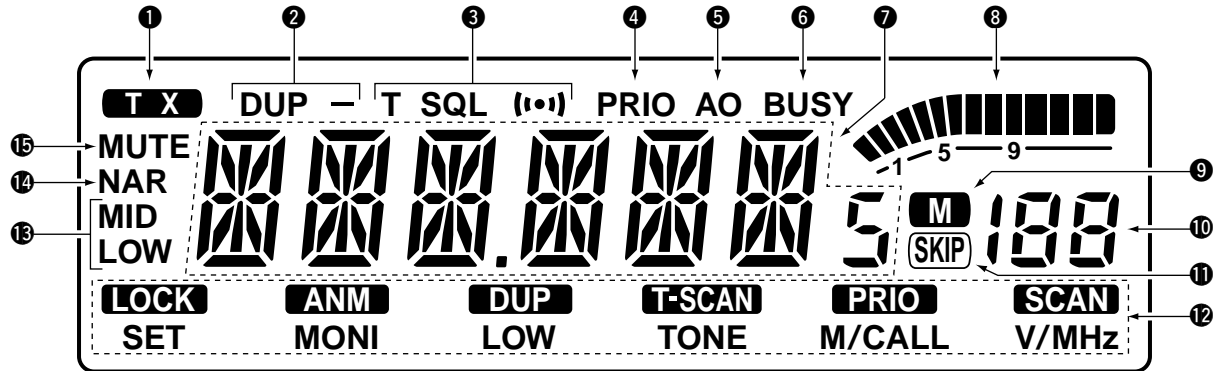

1 TRANSMIT INDICATOR

- Appears while transmitting. (p. 19)
- Flashes while transmitting with the one-touch PTT function. (p.20)

2 DUPLEX INDICATORS (p. 21)

- “DUP-” or “DUP” appears during semi-duplex operation (repeater operation).

3 TONE INDICATORS

- “T” appears while the subaudible tone encoder is in use. (p. 21)
- “T SQL” appears while the tone squelch function is in use. (p.47)
- “T SQL (••)” appears while the pocket beep function is

in use. (p. 46)

4 PRIORITY WATCH INDICATOR (p. 42)

- Appears while the priority watch is activated; flashes while the watch is paused.

5 AUTO POWER-OFF INDICATOR (p. 56)

- Appears while the auto power-off function is in use.

6 BUSY INDICATOR (p. 18)

- Appears when a signal is being received or the squelch is open ([MONI] is pushed).

7 FREQUENCY READOUT

- Shows the operating frequency, alphanumeric names, set mode contents, etc.
 - Frequency decimal point flashes while scanning. (p. 37)

- “d” appears in place of the 100 MHz digit while the DTMF memory function is in use. (p. 44)

8 S/R F INDICATORS

- ➔ Show the relative signal strength while receiving signals. (p. 18)
- ➔ Show the output power while transmitting. (p. 19)

9 MEMORY INDICATOR (p.26)

Appears when memory mode is selected.

10 MEMORY CHANNEL READOUTS

- ➔ Show the selected memory channel numbers.
- ➔ A capital “L” appears while the frequency lock function is in use. (p. 14)
- ➔ “C” appears while the call channel is selected. (p. 32)
- ➔ One of “L1” to “L3” appears when a simplex scratch pad memory is selected. (p. 34)
- ➔ One of “r1” to “r3” appears when a duplex scratch pad memory is selected. (p. 34)
- ➔ A small “c” appears when VFO mode is selected from the call channel or a scratch pad memory.

11 SKIP INDICATOR

Appears when the displayed memory channel is specified as a skip channel. (p. 40)

12 SWITCH INDICATORS

Indicate the function(s) of the front panel switches directly below the function display.

13 OUTPUT POWER INDICATORS (p. 19)

- ➔ “MID” appears when mid output power is selected.
 - The IC-2100T Thailand and IC-2100H Taiwan versions have no mid output power.
- ➔ “LOW” appears when low output power is selected
- ➔ Neither indicator appears when high output power is selected.

14 NARROW FM MODE INDICATOR

Appears when narrow FM mode is selected (available with the Europe version only; p. 58).

15 AUDIO MUTE INDICATOR

- Appears when the audio mute function is activated via microphone control.
- This function is cancelled when any switch or control is operated.

1 PANEL DESCRIPTION

■ Rear panel

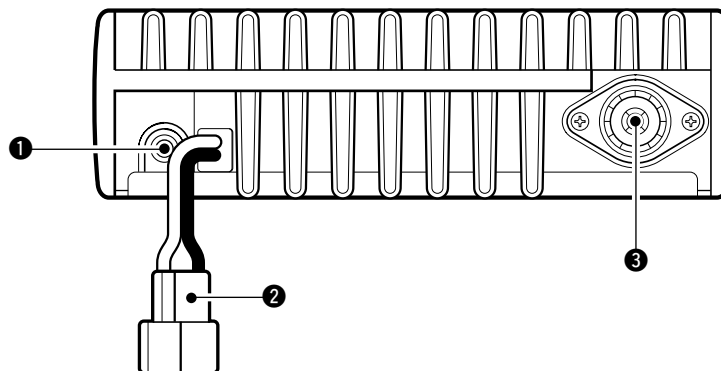

❶ SPEAKER JACK [SP]

Accepts an 8 Ω speaker.

- Audio output power is more than 2.4 W.

❷ POWER RECEPTACLE [DC13.8V]

Accepts 13.8 V DC $\pm 15\%$ with the supplied DC power cable.

- Current of 12 A or greater is required.

☞ **NOTE: DO NOT** use a cigarette lighter socket as a power source when operating in a vehicle. The plug may cause voltage drops and ignition noise may be superimposed onto transmit or receive audio.

❸ ANTENNA CONNECTOR [ANT]

Connects a 50 Ω antenna with a PL-259 connector and a 50 Ω coaxial cable.

■ Microphone (HM-98S*)

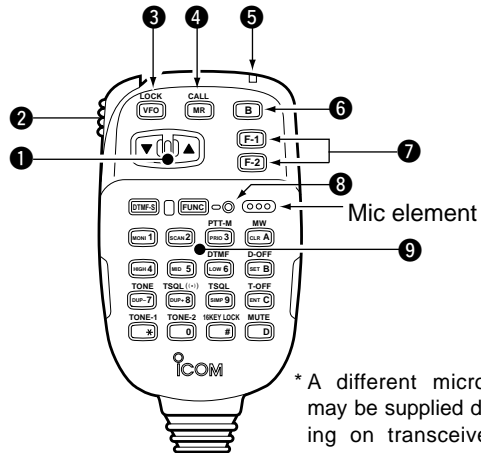

* A different microphone may be supplied depending on transceiver ver-

1 UP/DOWN SWITCHES [▲]/[▼]

- ➔ Push either switch to change operating frequency, memory channel, set mode contents, etc. (pgs. 15, 26)
- ➔ Push and hold either switch to start scanning. (p. 37)

2 PTT SWITCH

- ➔ Push and hold to transmit; release to receive.
- ➔ Toggles between transmitting and receiving while the one-touch PTT function is in use. (p. 20)

3 VFO SWITCH [VFO(LOCK)]

- ➔ Push to select VFO mode.
- ➔ Push and hold to toggle the lock function ON and OFF. (p. 14)

4 MEMORY SWITCH [MR(CALL)]

- ➔ Push to select memory mode. (p. 26)
- ➔ Push and hold to select the call channel. (p. 32)

5 ACTIVITY INDICATOR

- ➔ Lights red while any key is pushed (except [FUNC] or [DTMF-S]).
- ➔ Lights red while transmitting.
- ➔ Lights green while the one-touch PTT function is in use.

6 NULL SWITCH [B]

No function.

7 FUNCTION SWITCHES [F-1]/[F-2] (p. 57)

Assign your desired key function from the front panel switches.

- Default settings are [LOW] for [F-1] ([DUP] when pushed and held) and [TONE] for [F-2] ([T-SCAN] when pushed and held).

8 FUNCTION INDICATOR













- ➔ Lights orange while [FUNC] is activated—indicates the secondary function of switches can be accessed.
- ➔ Lights green when [DTMF-S] is activated—DTMF signals can be transmitted with the keypad.









9 KEYPAD

Used for controlling the transceiver, transmitting DTMF signals, etc. See the following 2 pages for details.

1 PANEL DESCRIPTION

■ Microphone keypad

KEY	FUNCTION	SECONDARY FUNCTION (after )	OTHER FUNCTIONS
	Toggles between opening and closing the squelch.	No secondary function.	After  : Transmit the appropriate DTMF code or push [0] to [9], [A] to [D] to transmit the DTMF memory contents when the DTMF memory encoder is activated. (p. 22)
	Starts and stops scanning. (p. 37)	No secondary function.	
	Starts and stops priority watch. (p. 42)	Turns the one-touch PTT function ON and OFF. (p. 20)	
	Selects high output power. (p. 19)	No secondary function.	
	Selects mid output power. (p. 19)	No secondary function.	
	Selects low output power (p. 19)	Turns the DTMF memory encoder function ON. (p. 44)	
	Selects –duplex. (p. 21)	Turns the subaudible tone encoder ON. (p. 21)	
	Selects + duplex. (p. 21)	Turns the pocket beep function ON. (p. 46)	
	Selects simplex. (p. 21)	Turns the tone squelch function ON. (p. 46)	
	No primary function.	While being pushed, transmits a 1750 Hz tone. (p. 22)	

KEY	FUNCTION	SECONDARY FUNCTION (after )	OTHER FUNCTIONS
	<ul style="list-style-type: none"> ➤ Clears a digit before entry. (p. 17) ➤ Cancels the scan, priority watch or DTMF memory function. (pgs. 16, 37, 43) 	<ul style="list-style-type: none"> ➤ Writes VFO contents into the memory or call channel. (p. 29) ➤ Advances the memory channel number when continuously pushed after programming is completed. (p. 28) 	[A] to [D] transmit DTMF memories. (p. 44)
	Enters set mode and advances the set mode selection.	DTMF memory OFF.	
	<ul style="list-style-type: none"> ➤ Sets the keypad for numeral input (p. 17) ➤ Decreases the set mode selection order after entering set mode. 	Turns the subaudible tone encoder, pocket beep or tone squelch OFF.(pgs. 21, 47, 46)	
	No primary function.	Mutes the audio. (p. 18) • Mute function is released when any operation is performed.	
	No primary function.	Locks the digit keys on the keypad (including the A to D, # and * keys. (p. 14)	After  : Transmit the appropriate DTMF code. (p. 45)
	No primary function.	Sends a 1750 Hz tone signal for 0.5 sec. (p. 22)	

■ Location

Select a location which can support the weight of the transceiver and does not interfere with driving in any way. We recommend the locations shown in the diagram below.

NEVER place the transceiver where normal operation of the vehicle may be hindered or where it could cause bodily injury.

NEVER place the transceiver where air bag deployment may be obstructed.

DO NOT place the transceiver where hot or cold air blows directly onto it.

AVOID placing the transceiver in direct sunlight.

• EXAMPLE INSTALLATION LOCATIONS

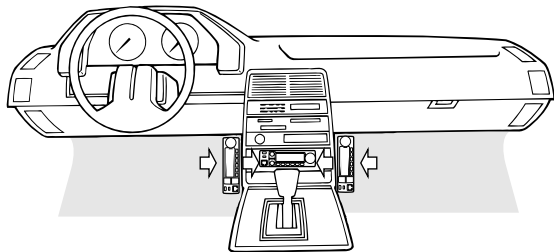

■ Using the mounting bracket

- ① Drill 4 holes where the mounting bracket is to be installed.
 - Approx. 5.5–6 mm ($\frac{3}{16}$ ") when using nuts; approx. 2–3 mm ($\frac{1}{16}$ ") when using self-tapping screws.
- ② Insert the supplied screws, nuts and washers through the mounting bracket and tighten.
- ③ Adjust the angle for the clearest view of the function display.

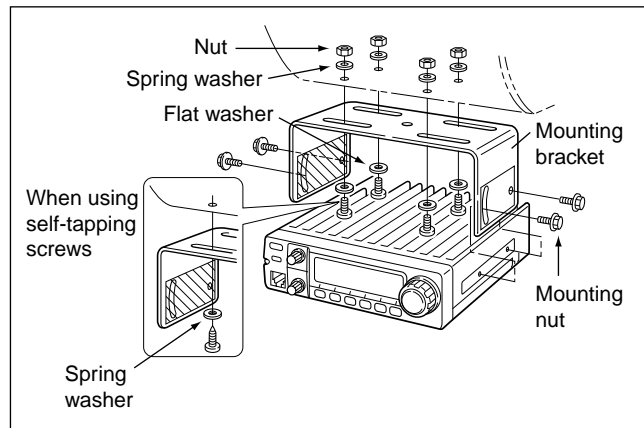

■ Battery connection

- ⚡ **NEVER** connect the transceiver directly to a 24 V battery.
- ⚡ **DO NOT** use the cigarette lighter socket for power connections.

Attach a rubber grommet when passing the DC power cable

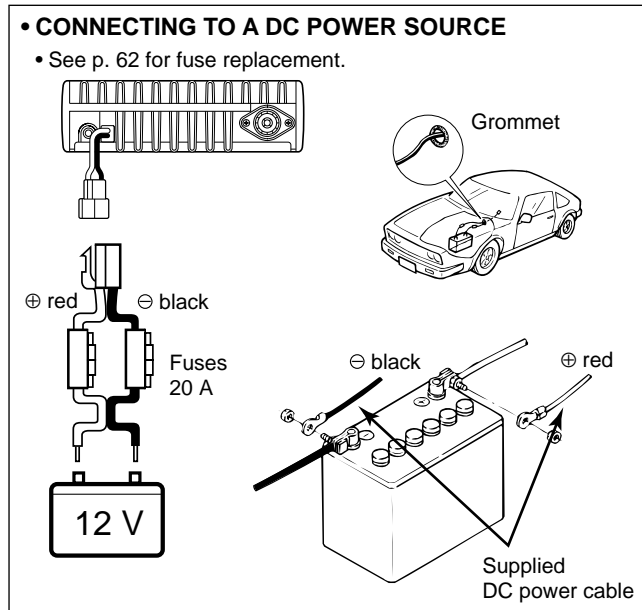

■ DC power supply connection

Use a 13.8 V DC power supply with more than 12 A capacity.

Make sure the ground terminal of the DC power supply is grounded.

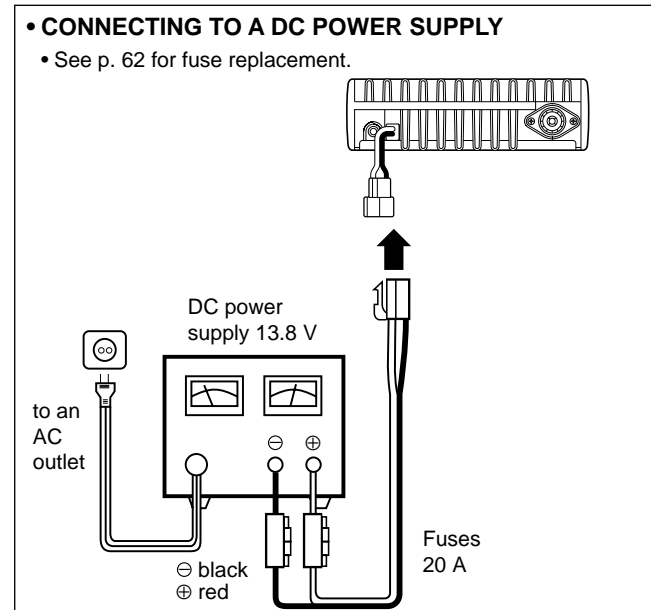

2 INSTALLATION

■ Antenna installation

◇ Antenna location

To obtain maximum performance from the transceiver, select a high-quality antenna and mount it in a good location. A non-radial antenna should be used when using a magnetic mount.

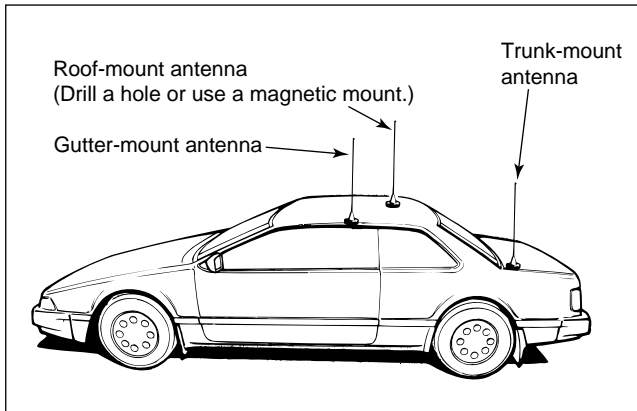

◇ Antenna connector

The antenna uses a PL-259 connector.

• PL-259 CONNECTOR

- ① Slide the coupling ring down. Strip the cable jacket and soft solder.

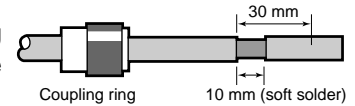

- ② Strip the cable as shown at right. Soft solder the center conductor.

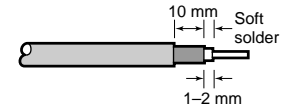

- ③ Slide the connector body on and solder it.

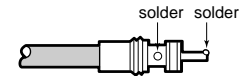

- ④ Screw the coupling ring onto the connector body.

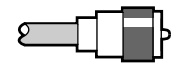

■ Preparation

◇ Turning power ON/OFF

☞ **NOTE:** Before operating the transceiver for the first time it's a good idea to reset the transceiver's CPU. This will ensure that all transceiver settings are at their defaults. See p. 62 for CPU resetting details.

Push [PWR] for 1 sec. to turn power ON or OFF.

Push [PWR] for 1 sec.

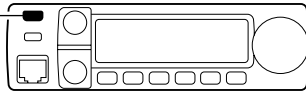

◇ VFO and memory modes

The transceiver has 2 basic operating modes: VFO mode and memory mode.

Push [V/MHz] to select VFO mode when the transceiver is not in VFO mode.

- If VFO mode is already selected, the digits below 100* kHz disappear. In this case, push [V/MHz] again (or push twice or 3 times depending on version).

*The digits below 1 or 10 MHz disappear for some versions.

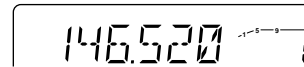

VFO mode is selected.

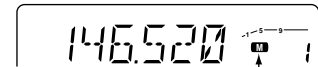

Appears when memory mode is selected.



Push [VFO] to select VFO mode.



Note that in this manual, sections beginning with a microphone icon (as above), designate operation via the HM-98S microphone.

3 SETTING A FREQUENCY

■ Lock functions

To prevent accidental frequency changes and unnecessary function access, use the lock function. The transceiver has 2 different lock functions.

◇ Frequency lock

This function locks the tuning dial and switches electronically and can be used together with the microphone lock function.

Push and hold [(SET)LOCK] until “L” appears in the memory channel readout to activate the function.

- To cancel the function, push and hold [LOCK] until “L” disappears.
- [PTT], [MONI], [VOL] and [SQL] can be used while the frequency lock function is in use. Also, TONE-1, TONE-2, DTMF tones or DTMF memory contents can be transmitted from the microphone.

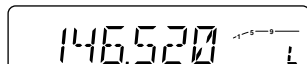

“L” appears while the frequency lock function is in use.



Push and hold [(VFO)LOCK] for 1 sec. to toggle the function ON and OFF.

◇ Microphone keypad lock

This function locks the microphone keypad.



Push [FUNC] then [16KEYLOCK] to toggle the microphone keypad lock function ON and OFF.

- [PTT] and the 7 keys on the upper half of the microphone can be used.
- All switches on the transceiver can be used.
- The keypad lock function is released when the power is turned OFF then ON again.

■ Using the tuning dial

- ① Rotate the tuning dial to set the frequency.
 - If VFO mode is not selected, push [V/MHz] to select VFO mode.
 - The frequency changes according to the selected tuning steps. (p. 16)
- ② To change the frequency in 1 MHz (10 MHz for some versions) steps, push [V/MHz], then rotate the tuning dial.
 - Pushing [V/MHz] for 1 sec. starts a scan function. If this happens, push [V/MHz] again to stop the scan.



The display shows that the 1 MHz tuning step is selected.

■ Using the [▲]/[▼] keys

- Push [▲] or [▼] to select the desired frequency.

 - If VFO mode is not selected, push [VFO] to select it.
 - The frequency changes according to the selected tuning steps. (p. 16)
 - Pushing [▲] or [▼] for more than 0.5 sec. activates a scan. If this happens, push [▲] or [▼] again to cancel the scan.

👉 **NOTE:** 1 MHz steps cannot be used via the [▲]/[▼] keys.

3 SETTING A FREQUENCY

■ Tuning step selection USING SET MODE

Tuning steps are the minimum frequency change increments when you rotate the tuning dial or push the [▲]/[▼] keys on the microphone. The following tuning steps are available:

- 5 kHz
- 10 kHz
- 12.5 kHz
- 15 kHz
- 20 kHz
- 25 kHz
- 30 kHz
- 50 kHz

☞ **NOTE:** For convenience, select a tuning step that matches the frequency intervals of repeaters in your area.

- ① Push [V/MHz] to select VFO mode, if necessary.
- ② Push [SET] one or more times until “TS” appears as shown below.
 - Pushing [MONI] reverses the order of selection.
 - Cancel the DTMF memory function in advance, if necessary.
- ③ Rotate the tuning dial to select the tuning step.
- ④ Push [V/MHz] to exit set mode.

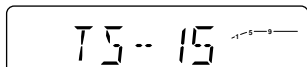

15 kHz tuning step

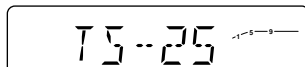

25 kHz tuning step



- ① Push [VFO] to select VFO mode, if necessary.
- ② Push [®SET] one or more times until “TS” appears as shown below left.
 - Push [ENT] to reverse the order of selection.
 - Cancel the DTMF memory function in advance, if necessary. (p. 44)
- ③ Push [▲] or [▼] to select the tuning step.
- ④ Push [CLR] to exit set mode.

■ Using the keypad



The frequency can be directly set via numeral keys on the microphone.

- 1 Push [VFO] to select VFO mode, if necessary.
- 2 Push [ENT] to activate the keypad for digit input.

- 3 Push 6 keys to input a frequency.
 - When a digit is mistakenly input, push [ENT] to clear the input, then repeat input from the 1st digit.
 - Pushing [CLR] clears input digits and retrieves the frequency.
- 4 Push [▲] or [▼] to make adjustments below the 10 kHz digit, if desired.

[EXAMPLE]: Setting the frequency to 145.3625 MHz.

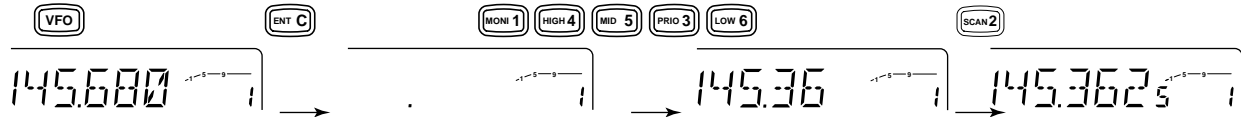

■ Receiving

- ① Push [PWR] for 1 sec. to turn power ON.
- ② Set the audio level.
 - ➔ Push [MONI] to open the squelch.
 - ➔ Rotate the [VOL] control to adjust the audio output level.
 - ➔ Push [MONI] again to close the squelch.
- ③ Set the squelch level.
 - ➔ Rotate [SQL] fully counterclockwise in advance.
 - ➔ Rotate [SQL] clockwise until the noise just disappears.
 - ➔ When interference is received, rotate [SQL] clockwise again for attenuator operation.
- ④ Set the operating frequency. (p. 15)
- ⑤ When receiving a signal on the set frequency, squelch opens and the transceiver emits audio.
 - “BUSY” appears and the S/RF indicator shows the relative signal strength for the received signal.

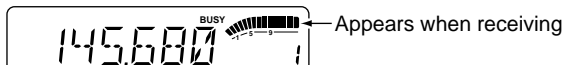

✓ CONVENIENT

RF attenuator: The transceiver has an RF attenuator related to the [SQL] setting. The attenuator is automatically activated when [SQL] is rotated clockwise past the 12 o'clock position. Approx. 10 dB attenuation is obtained at full rotation.

■ Monitor function

This function is used to listen to weak signals without disturbing the squelch setting or to open the squelch manually even when mute functions such as the tone squelch are in use.

Push [MONI] to open the squelch.

- Push [MONI] again to cancel the function.
- While duplex is ON for repeater operation, the transmitting frequency can be monitored with [MONI].



Push [①MONI] to open the squelch.

- Push [②MONI] again to cancel the function.

■ Audio mute function

This function temporarily mutes the audio without disturbing the volume setting.



① Push [FUNC] then [①MUTE] to mute audio signals.

- “MUTE” appears.

② Push [ⒶCLR] (or any other key) to cancel the function.

- “MUTE” disappears.

■ Transmitting

▼CAUTION: Transmitting without an antenna will damage the transceiver.

☞ **NOTE:** To prevent interference, listen on the frequency before transmitting by pushing [MONI] or [①MONI] on the microphone.

- ① Set the operating frequency. (pgs. 15, 17)
 - Select output power if desired. See section at right for details.
- ② Push and hold [PTT] to transmit.
 - “TX” appears.
 - The S/R/F indicator shows the output power selection.
 - The operating frequency, etc. is automatically programmed into a scratch pad memory. See p. 34 for details.
 - A one-touch PTT function is available. See p. 20 for details.
- ③ Speak into the microphone using your normal voice level.
 - DO NOT hold the microphone too close to your mouth or speak too loudly. This may distort the signal.
- ④ Release [PTT] to return to receive.

■ Selecting output power

The transceiver has 3* output power levels to suit your operating requirements. Low output powers during short-distance communications may reduce the possibility of interference to other stations and will reduce current consumption.

*The Thailand and Taiwan versions have only 2 levels.

Push [LOW] one or more times to select the output power.

- The output power can be changed while transmitting.

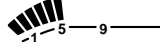
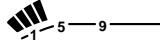
	POWER OUTPUT	
	Thailand	Taiwan
	55 W	25 W
	10 W	—
	5 W	5 W

The microphone can also be used to select output power.



Push [④HIGH] for high output power; [⑤MID] for mid-range output power; and [⑥LOW] for low output power.



- The output power CANNOT be changed via the microphone while transmitting.



4 BASIC OPERATION

■ One-touch PTT function



The PTT switch can be operated as a one-touch PTT switch (each push toggles transmit/receive). Using this function you can transmit without pushing and holding the PTT switch.

To prevent accidental, continuous transmissions with this function, the transceiver has a time-out timer. See p. 55 for details.

- ① Push [FUNC] then [③PTT-M] to turn the one-touch PTT function ON.
 - The activity indicator lights green.
- ② Push [PTT] to transmit and push again to receive.
 - Two beeps sound when transmission is started and a long beep sounds when returning to receive.
 - "TX" flashes when transmitting with the one-touch PTT function.
- ③ Push [FUNC] then [③PTT-M] to turn the one-touch PTT function OFF.
 - The activity indicator goes out.

■ Accessing a repeater

- ① Set the receive frequency (repeater output frequency). (pgs. 15–17)
 - ② Push and hold [(LOW)DUP] for 1 sec., one or more times, to select minus duplex or plus duplex.
 - “DUP –” or “DUP” appears to indicate the transmit frequency for minus shift or plus shift, respectively.
 - When the auto repeater function is turned ON (available for the USA version only), steps ② and ③ are not necessary. (p. 25)
-
- ③ Push [TONE] one or more times to turn ON the subaudible tone encoder, according to repeater requirements.
 - Refer to p. 23 for tone frequency settings.
 - When the repeater requires a different tone system, see the next page.
 - ④ Push and hold [PTT] to transmit.
 - The displayed frequency automatically changes to the transmit frequency (repeater input frequency).
 - The operating condition is automatically programmed into a scratch pad memory. See p. 34 for details.
 - If “OFF” appears, confirm that the offset frequency (p. 34) is set correctly.
 - ⑤ Release [PTT] to receive.
 - ⑥ Push [MONI] to check whether the other station’s transmit

signal can be received directly.

- ⑦ To return to simplex operation, push [(LOW)DUP] for 1 sec., once or twice, to clear the “DUP” indicator.
- ⑧ To turn OFF the subaudible tone encoder, push [TONE] one or more times until no tone indicators appear.



① Set the receive frequency (repeater output frequency). (p. 15)

② Push [⑦DUP–] to select – duplex; push [⑧DUP+] for + duplex.

③ Push [FUNC] then [⑦TONE] to turn ON the subaudible tone encoder according to repeater requirements.

- Refer to p. 23 for tone frequency setting.
- When the repeater requires a different tone system, see next page.

④ Push and hold [PTT] to transmit.

⑤ Push and hold [①MONI] to check whether the other station’s signal can be received directly.

⑥ Release [PTT] to receive.

⑦ To return to simplex operation, push [⑨SIMP].

⑧ To turn OFF the subaudible tone encoder, push [FUNC], then [⑩T-OFF].



5 REPEATER OPERATION

◇ DTMF tones



Push [DTMF-S], then push the keys of the desired DTMF digits.

- The function indicator lights green.
- 0–9, A–D, * (E) and # (F) are available.
- Cancel the DTMF memory encoder function in advance, if necessary. (p. 45)
- Push [DTMF-S] again to return the keypad to normal function control.
- The transceiver has 14 DTMF memory channels for autopatch operation. See p. 44 for details.

◇ 1750 Hz tone



A 1750 Hz tone is required to access most European repeaters. The microphone has 1750 Hz tone capability.

- 1 Push [FUNC].
 - The mode indicator lights orange.
- 2 Push [TONE-1] to transmit a 1750 Hz tone call signal for 0.5 sec.; push and hold [TONE-2] to transmit a 1750 Hz tone call signal for an arbitrary period.



- The mode indicator goes out automatically.
- The optional HM-90 also has 1750 Hz tone capability.

■ Subaudible tone (encoder function)

USING SET MODE

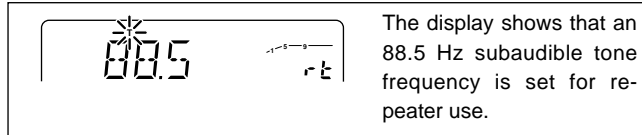

The display shows that an 88.5 Hz subaudible tone frequency is set for repeater use.

- ① Select the mode/channel you wish to set the subaudible tone encoder frequency to, such as VFO mode or memory/call channel.
- ② Push [SET] one or more times until “T” and “rT” appears for repeater use; or until “T SQL” and “CT” appears for tone squelch or pocket beep use.
 - Push [MONI] to reverse the order of selection.
 - Cancel the DTMF memory encoder function in advance, if necessary. (p. 45)
- ③ Rotate the tuning dial to select and set the desired frequency.
- ④ Push [V/MHz] to exit set mode.

👉 **NOTE:** The subaudible tone encoder frequency can be set in a memory channel temporarily. However, the set contents are cleared once the memory/call mode is selected. To store the tone frequency permanently, overwrite the channel information.

SET
B

- ① Set the mode/channel you wish to set the subaudible tone encoder frequency to, such as VFO mode, memory/call channel or scratch pad memory.
 - The subaudible tone frequency is independently programmed into each mode or channel.
- ② Push [ⓂSET] one or more times until “T” and “rT” appears for repeater use; or until “T SQL” and “CT” appears for tone squelch or pocket beep use.
 - Pushing [ⓂENT] reverses the order of selection.
 - Cancel the DTMF memory encoder function in advance, if necessary. (p. 45)
- ③ Push [▲] or [▼] to select and set the desired frequency.
 - Pushing and holding [▲] or [▼] changes the frequency continuously.
- ④ Push [ⓂCLR] to exit set mode.

• Subaudible tone frequency list

(unit: Hz)

67.0	79.7	94.8	110.9	131.8	156.7	171.3	186.2	203.5	229.1
69.3	82.5	97.4	114.8	136.5	159.8	173.8	189.9	206.5	233.6
71.9	85.4	100.0	118.8	141.3	162.2	177.3	192.8	210.7	241.8
74.4	88.5	103.5	123.0	146.2	165.5	179.9	196.6	218.1	250.3
77.0	91.5	107.2	127.3	151.4	167.9	183.5	199.5	225.7	254.1

5 REPEATER OPERATION

■ Offset frequency

USING SET MODE

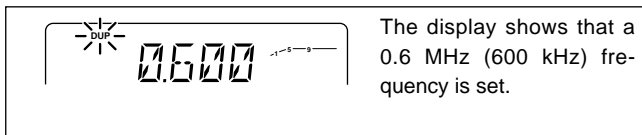

- ① Select the mode/channel you wish to set the subaudible tone frequency to, such as VFO mode or memory/call channel.
 - The offset frequency can be individually programmed into each mode or channel.
- ② Push [SET] one or more times until “DUP” appears and flashes as shown above.
 - Push [MONI] to reverse the order of selection.
 - Cancel the DTMF memory encoder function in advance, if necessary. (p. 45)
- ③ Rotate the tuning dial to select and set the desired frequency.
 - Selectable step increment is the same as the preset tuning step. (p. 16)
 - Use [V/MHz] for quick MHz tuning.
- ④ Push [LOW], [TONE], [M/CALL] or [PTT] to exit set mode.

SET
B

- ① Set the mode/channel you wish to set the offset frequency to, such as VFO mode, memory/call channel or scratch pad memory.
 - The offset frequency can be independently programmed into each mode or channel.
- ② Push [ⓈSET] one or more times until “DUP” appears as shown at left.
 - Pushing [ⓈENT] reverses the order of selection.
 - Cancel the DTMF memory encoder function in advance, if necessary. (p. 44)
- ③ Push [▲] or [▼] to select and set the desired frequency.
 - Selectable step increment is the same as the preset tuning step. (p. 16)
 - Pushing and holding [▲] or [▼] changes the frequency continuously.
- ④ Push [ⓈCLR] to exit set mode.

☞ **NOTE:** The offset frequency can be set in a memory channel temporarily. However, the set contents are cleared once the memory/call mode is selected. To store the offset frequency permanently, overwrite the channel information.

■ Auto repeater USING INITIAL SET MODE (USA version)

The USA version automatically activates the repeater settings (DUP or – DUP and tone encoder ON/OFF) when the operating frequency falls within the general repeater output frequency range and deactivates them when outside of the range.

◇ Setting the auto repeater function ON/OFF

- ① Push [PWR] to turn power OFF.
- ② While pushing [SET] (far left switch), turn power ON to enter initial set mode.
- ③ Push [SET] one or more times until the “Rpt” display appears as shown below.

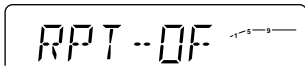

Auto repeater function is turned OFF

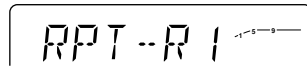

Auto repeater function is ON, tone encoder is OFF

- ④ Rotate the tuning dial to turn the auto repeater function to “R1,” “R2” or OFF.
 - “R1”: auto repeater is ON, tone encoder is OFF.
 - “R2”: auto repeater is ON, tone encoder is ON.
- ⑤ Push [PWR] to exit initial set mode.

◇ Frequency range and offset direction

FREQUENCY RANGE	DUPLEX DIRECTION
145.200–145.495 MHz 146.610–146.995 MHz	“DUP –” appears
147.000–147.395 MHz	“DUP” appears

■ Repeater lockout USING INITIAL SET MODE

This function helps prevent interference to other stations by inhibiting your transmission when a signal is received. The transceiver has two inhibiting conditions, repeater and busy.

- ① Push [PWR] to turn power OFF.
- ② While pushing [SET] (far left switch), turn power ON to enter initial set mode.
- ③ Push [SET] one or more times until the “RLO” display appears as shown below.

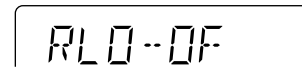

Repeater lockout function is turned OFF

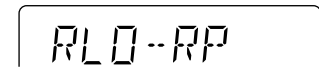

Transmit is inhibited when the tone squelch is closed

- ④ Rotate the tuning dial to turn the repeater lockout function to “RP,” “BU” or OFF.
 - “RP”: Transmit is inhibited when the tone squelch is closed.
 - “BU”: Transmit is inhibited when a signal is received.
- ⑤ Push [PWR] to exit initial set mode.

■ General description

The transceiver has 107 memory channels including 6 scan edge memory channels (3 pairs), and 1 call channel. In addition, 6 scratch pad memories are available (see p. 34). Each of these channels can be individually programmed with the following data.

- Operating frequency (pgs. 13)
- Duplex direction and offset (pgs. 21, 24)
- Subaudible tone encoder or tone squelch and its tone frequency (pgs. 21, 47)
- Skip information* (p. 40\)

*Except for scan edge memory channels.

■ Memory channel selection

◇ Using the tuning dial

- ① Push [M/CALL] once or twice to display “**M**”.
- ② Rotate the tuning dial to select the desired memory channel.
 - Only programmed memory channels can be selected.

◇ Using the [▲]/[▼] keys



- ① Push [MR] to select memory mode.



- ② Push [▲] or [▼] to select and set the desired memory channel.
 - Pushing [▲] or [▼] for more than 0.5 sec. activates a scan.
 - If a scan is activated, push [▲] or [▼] again to stop it.

◇ Using the keypad



- ① Push [MR] to select memory mode.



- ② Push [©ENT] to activate the keypad for numeral input.
- ③ Push 3 appropriate digit keys to input a channel number.
 - When inputting non-programmed channel numbers, the previous memory channel appears.
 - To select scan edge channels, “*” and “#” can be used for A and b respectively.

■ Programming a memory channel

VFO mode settings, including the set mode contents such as subaudible tone frequency, etc., can be programmed into a memory channel.

- ① Set the desired frequency in VFO mode:
 - ➔ Push [V/MHz] to select VFO mode.
 - ➔ Set the frequency using the tuning dial.
 - ➔ Set other data (e.g. tone frequency, etc.) if required.
- ② Push [S.MW] momentarily.
 - “**M**” and the memory channel number flash.
- ③ Rotate the tuning dial to select the memory channel to be

programmed.

- Memory channels not yet programmed are blank.
- ④ Push [S.MW] for 1 sec. to program.
 - 3 beeps may sound.
 - Memory channel number automatically advances when continuing to push [S.MW] after programming.

✓ CONVENIENT

Memory programming can be performed in versatile ways e.g. memory channel to the same (or different) memory channel, memory channel to the call channel, etc.

[EXAMPLE]: Programming 145.870 MHz into memory channel 20 via the front panel.

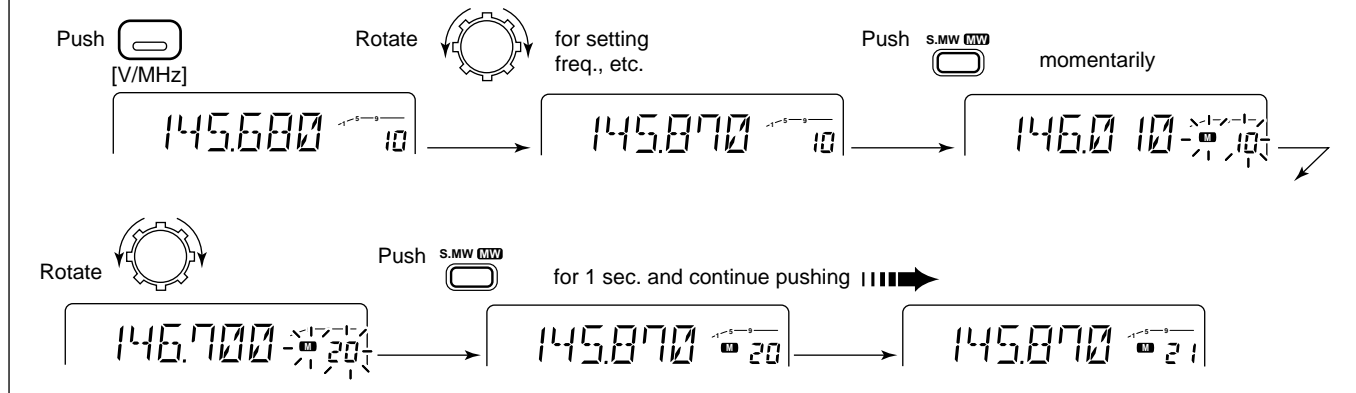

6 MEMORY OPERATION

■ Programming a memory channel via the microphone



The microphone can also be used to program memory channels.

① Set the desired frequency in VFO mode:

- ➔ Push [VFO] to select VFO mode.
- ➔ Set the frequency using the keypad.
- ➔ Set other data (e.g. offset frequency, duplex direction, subaudible tone encoder ON/OFF and its frequency), if necessary.

② Push [FUNC], then [Ⓜ] momentarily.

③ Select the memory channel to be programmed.

- ➔ Push [▲] or [▼] to select the memory channel (direct numerical input cannot be used).

④ Push [FUNC] then [Ⓜ] for 1 sec. to program.

- ➔ 3 beeps may sound and the VFO contents (including the subaudible tone frequency, etc.) are programmed.
- ➔ Memory channel number advances when continuing to push [MW] after programming.

[EXAMPLE]: Programming 145.870 MHz into memory channel 20 via the microphone.

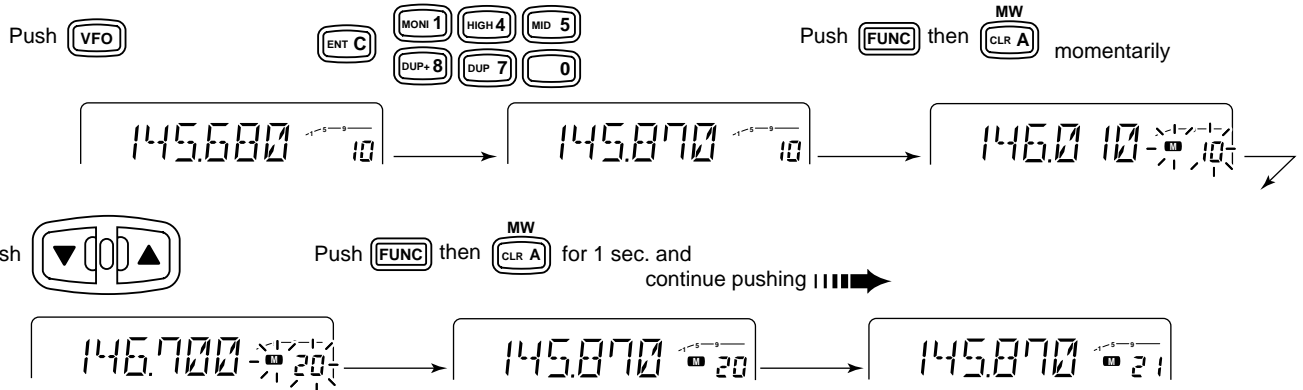

■ Transferring memory contents

This function transfers a memory channel's contents to VFO (or another memory/call channel). This is useful when searching for signals around a memory channel frequency and for recalling the offset frequency, subaudible tone frequency, etc.

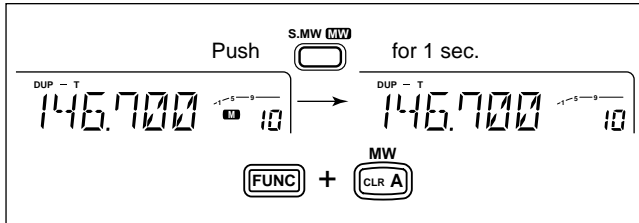

- ① Select the memory channel to be programmed.
 - ➔ Select memory mode by pushing [M/CALL] once or twice (“M” appears).
 - ➔ Rotate the tuning dial to select the memory channel.
- ② Push [S.MW] momentarily, then rotate the tuning dial to select another memory channel to transfer.
 - To transfer to the VFO, push and hold [(S.MW)MW] instead of pushing momentarily.
- ③ Push and hold [(S.MW)MW] to transfer when a momentary push was used in the previous step.

MW

- ① Set the memory channel to be transferred:
 - ➔ Push [MR] to select memory mode.
 - ➔ Push [▲] or [▼] to select the memory channel; or push [©ENT] then push the desired memory channel number (3 digits) to select the memory channel directly.
- ② Push [FUNC] then [ⒶMW] momentarily, then push [▲] or [▼] to select another memory channel to transfer.
 - To transfer to the VFO, push [FUNC] then push and hold [ⒶMW] instead of pushing momentarily.
- ③ Push [FUNC] then [ⒶMW] for 1 sec. to transfer.

6 MEMORY OPERATION

■ Memory clearing

Contents of programmed memories can be cleared (blanked), if desired.

➡ **NOTE:** Be careful—the contents of cleared memories **CANNOT** be recalled.

- ① Push [S.MW] momentarily.
- ② Select the memory channel to be cleared with the tuning dial.
- ③ Push [S.MW] briefly, then a second time for 1 sec.
 - 3 beeps sound, then the frequency is cleared.
 - “**M**” flashes continuously.
 - Scan edges 1A/1b and the call channel cannot be cleared.
- ④ Push any switch to stop the flashing.

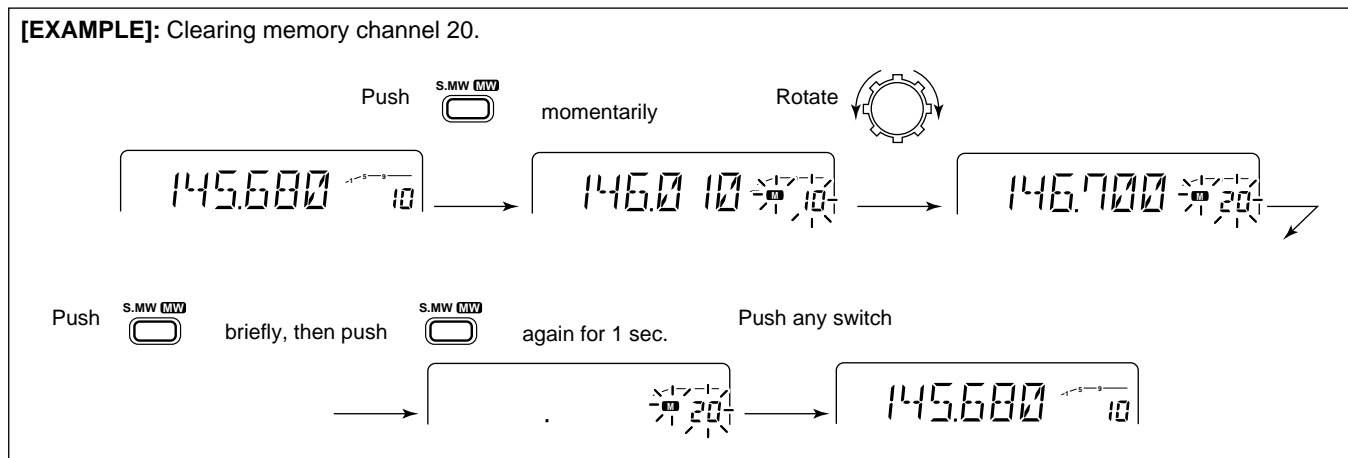

■ Alphanumeric display

Each memory channel and the call channel can be programmed with an alphanumeric name such as a repeater name, club name, etc., for easy recognition. Names can be a maximum of 6 characters—see the table below for available characters.

☞ **NOTE:** Scan edge channels and scratch pad memories CANNOT be programmed with alphanumeric names.

1	2	3	4	5	6	7	8	9	10
A	B	C	D	D	E	F	G	H	I
J	K	L	M	N	O	P	Q	R	S
T	U	V	W	X	Y	Z	+	-	*
/	=	_	<	>	()	,	:	space

- ① Push [M/CALL] to select memory mode (or call mode) if necessary.
- ② Rotate the tuning dial to select the desired memory channel.

[EXAMPLE]: Programming “CLUB” into memory channel 1.

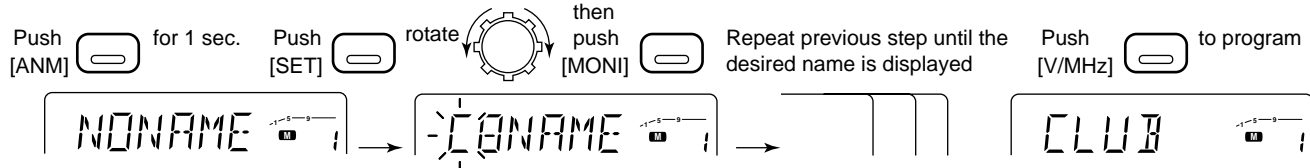

- ③ Push [(MONI)ANM] for 2 sec. to select alphanumeric indication.
 - “NONAME” appears when a name has not yet been programmed into the channel.
- ④ Push [SET] to enter programming mode.
 - The first character of the name flashes.
- ⑤ Rotate the tuning dial to select the desired character.
 - See the table at left for a list of available characters.
- ⑥ Push [SET] to advance to the next character.
 - Push [MONI] to select the previous character.
- ⑦ Push [V/MHz] to program the name and exit programming mode.
- ⑧ Push [(SET)ANM] for 2 sec. to return to frequency indication if desired.

■ Calling up the call channel

Use the call channel to store a most-often-used frequency for quick recall.

- ① Push [M/CALL] one or twice to display a large “C” in the memory channel readout.
- ② Push [V/MHz] or [M/CALL] to exit the call channel.

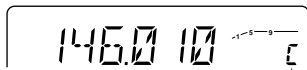

Large “C” shows the call channel is selected.

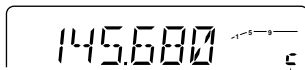

Small “c” shows VFO mode was selected from the call channel.



Push [(MR)CALL] for 1 sec. to select the call channel.

■ Transferring call channel contents

- ① Select the call channel by pushing [M/CALL] one or twice.
 - A large “C” appears.
- ② Push [S.MW] momentarily, then rotate the tuning dial to select a memory channel to transfer the contents to.
 - To transfer to the VFO, push and hold [(S.MW)MW] instead of pushing momentarily.
- ③ Push and hold [(S.MW)MW] to transfer when a momentary push was used in the previous step.
 - If a name (p. 31) has been programmed into the call channel, the name is also transferred.



- ① Push [(MR)CALL] for 1 sec. to select the call channel.
- ② Push [FUNC], then [ⒶMW] momentarily.
 - To transfer to the VFO, push [FUNC] then push and hold [ⒶMW] for 1 sec. instead of pushing [ⒶMW] momentarily.
- ③ Push [FUNC] then [ⒶMW] for 1 sec. to transfer when momentarily pushing [ⒶMW] in step ②.
 - If a name (p. 31) has been programmed into the call channel, the name is also transferred.

■ Programming the call channel

In addition to an operating frequency, duplex information, sub-audible tone information (tone encoder or tone squelch ON/OFF and its frequency) and an alphanumeric name can be programmed into the call channel.

- ① Push [M/CALL] one or twice to display a large “C” in the memory channel readout.
- ② Set the desired frequency in VFO mode:
 - ➔ Push [VFO] to select VFO mode.
 - ➔ Set the frequency using the tuning dial.
 - ➔ Set other data as desired.
- ③ Push [(S.MW)MW] for 1 sec. to program.

✓ CONVENIENT

The call channel can also be programmed from the VFO directly (similar to memory programming).

MW
A

- ① Push [(MR)CALL] for 1 sec. to select the call channel.
- ② Set the desired frequency in VFO mode:
 - ➔ Push [VFO] to select VFO mode.
 - ➔ Push the desired frequency using the keypad.
 - ➔ Set other data as desired.
- ③ Push [FUNC], then [ⓂMW] for 1 sec. to program.

[EXAMPLE]: Programming 145.120 MHz into the call channel via the microphone.

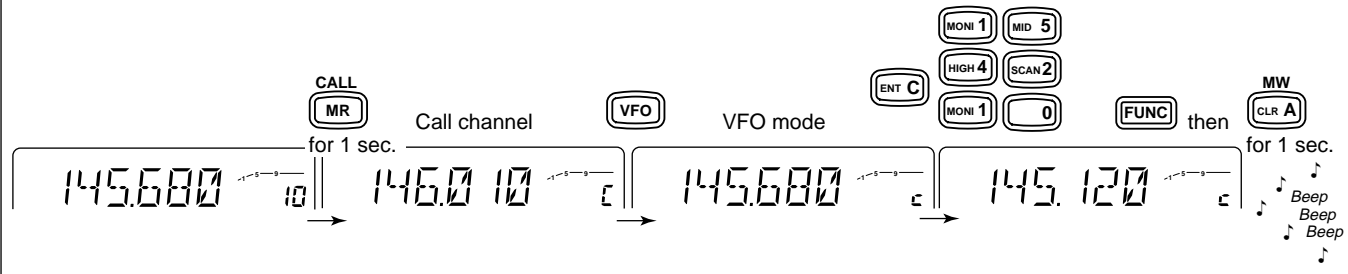

■ What is scratch pad memory?

During VFO operation, the transceiver automatically memorizes operating frequency information when transmitting on a new frequency. There are 2 types of scratch pad memories, those for simplex operation, L1–L3, and those for duplex (repeater) operation, r1–r3. These memories can be conveniently recalled.

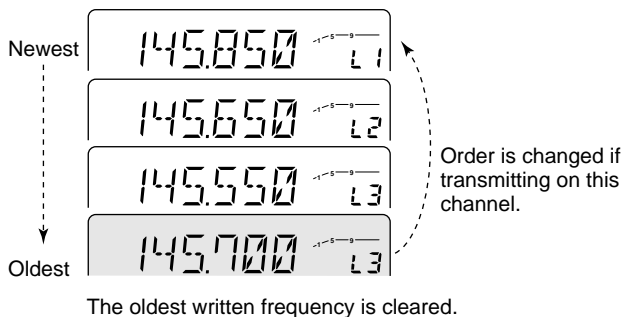

☞ **NOTE:** When memory mode is selected, the frequency is not programmed into a scratch pad.

■ Calling up a scratch pad memory

- ① Select the call channel by pushing [M/CALL] once or twice to display a large “C” in the memory channel display.
- ② Rotate the tuning dial to select a scratch pad memory.
 - Previously transmitted frequency and one of “L1”–“L3” or “r1”–“r3” appears.
 - When first applying power or after CPU resetting, scratch pad memories contain no data and therefore cannot be selected.
- ③ Push [V/MHz] or [M/CALL] to exit the scratch pad memory.

☞ NOTES:

- ◆ The 3rd scratch pad memory (L3 or r3) will be cleared when transmitting on a new frequency. If the transmit frequency is already stored in a scratch pad memory, the scratch pad memory is not cleared but the order is changed.
- ◆ When transmitting on a scratch pad memory, the scratch pad memory becomes the 1st scratch pad memory (L1 or r1) and the order is changed.



- ① Push and hold [(MR)CALL] for 1 sec. to select the call channel.
- ② Push [▲] one or more times to select a duplex scratch pad memory; push [▼] one or more times to select a simplex scratch pad memory.
- ③ Push [MR] or [VFO] to exit the scratch pad memory.

■ Transferring scratch pad memory contents

Transferring scratch pad memory contents to the VFO is done similarly to transferring memory/call contents.

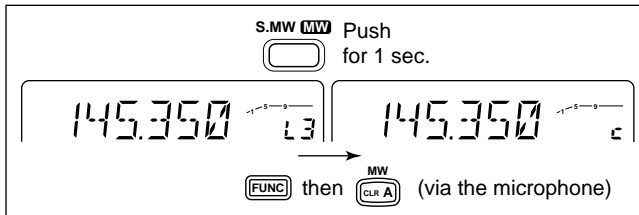

- ① Select the call channel by pushing [M/CALL] once or twice.
 - A large "C" appears.
- ② Rotate the tuning dial to select the desired scratch pad memory.
 - One of "L1" to "L3" or "r1" to "r3" appears.
- ③ Push [(S.MW)MW] momentarily.
 - "M--" flashes to indicate VFO as the transferring channel.
- ④ Rotate the tuning dial to select the desired memory channel.
- ⑤ Push and hold [(S.MW)MW] to transfer.



- ① Push and hold [(MR)CALL] for 1 sec. to select the call channel.
- ② Push [▲] one or more times to select a duplex scratch pad memory; push [▼] one or more times to select a simplex scratch pad memory.
- ③ Push [FUNC] then [▲MW] momentarily.
 - "M--" flashes to indicate VFO as the transferring channel.
- ④ Push [▲] or [▼] to select the desired memory channel.
- ④ Push [FUNC] then [▲MW] for 1 sec. to transfer.

■ Scan types

Scanning searches for signals automatically and makes it easier to locate new stations for contact or listening purposes.

FULL SCAN (p. 37)

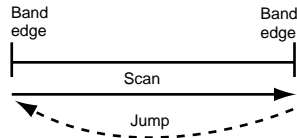

Repeatedly scans all frequencies over the entire band. Used as the simplest scan without any preliminary settings necessary.

PROGRAMMED SCAN (p. 37)

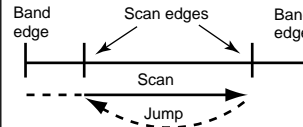

Repeatedly scans between two user-programmed frequencies. Used for checking for frequencies within a specified range such as repeater output frequencies, etc. 3 pairs of scan edges are available.

MEMORY SCAN (p. 37)

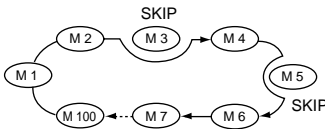

Repeatedly scans memory channels except those set as skip channels. Used for often-called channels and for bypassing normally busy channels such as repeater frequencies.

SCAN RESUME CONDITION (p. 41)

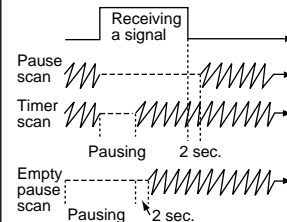

5 resume conditions are available: 3 timer scans, pause scan and empty scan. When receiving a signal, pause scan pauses until the signal disappears; timer scans pause for 5, 10 or 15 sec. Empty pause scan pauses until a signal appears.

☞ **NOTE:** A tone scan function is available to search for sub-audible tones (e.g. when you want to find a subaudible

tone frequency necessary to open a repeater). See p. 48 for details.

■ Scan start/stop

◇ Preparation

- Common setting: scan resume condition (p. 41)
- For programmed scan: program the scan edges (p. 38)
- For memory scan: program 2 or more memory channels; set memory skip settings, if desired (p. 40)

◇ Operation

- ① Select VFO mode for full/programmed scan with [V/MHz]; or memory mode for memory scan with [M/CALL].
- ② Set the squelch to the point where noise is just muted.
- ③ Push [(V/MHz)SCAN] for 1 sec. to start the scan.
 - To change the scanning direction, rotate the tuning dial.
 - The memory channel readout indicates the scan type as follows:



During full scan

Push [SET] to select full scan or programmed scan in sequence.



During programmed scan

Indicates scan edge channels.

- P1 stands for 1A/1b.
- P1 to P3 are available when they are programmed.

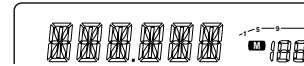

During memory scan

- ④ To toggle between full and programmed scan, push [SET].
- ⑤ To stop the scan, push [(V/MHz)SCAN].



① Push [VFO] to select VFO mode for full/programmed scan; or push [MR] to select memory mode for memory scan.

② Set the squelch to the point where noise is just muted.

③ Push [②SCAN] to start the scan.

• [▲]/[▼] also start the scan when pushed and held.



④ Push [SET] to toggle between full and programmed scan.

⑤ To stop the scan push [③SCAN].

9 SCAN OPERATION

■ Programming scan edges

Scan edges can be programmed in the same manner as memory channels. Scan edges are programmed into scan edges, 1A/1b to 3A/3b, in memory channels.

- ① Set the desired frequency in VFO mode:
 - Set the frequency using the tuning dial.
 - Set other data (e.g. offset frequency, etc.) if desired.
- ② Push [S.MW] momentarily.
 - “M” and the memory channel number flash.
- ③ Rotate the tuning dial to select a scan edge channel.
- ④ Push [(S.MW)MW] for 1 sec. to program.
 - 3 beeps may sound and the frequency is programmed.
 - Scan edge 1b is automatically selected when continuing to push [(S.MW)MW] after programming.
- ⑤ To program a frequency for the other pair of scan edges, 1b to 3b, repeat steps ③ and ④.
 - If the same frequency is programmed into a pair of scan edges, programmed scan will not function.

[EXAMPLE]: Programming 145.30 MHz and 145.80 MHz into scan edges 1A and 1b, respectively.

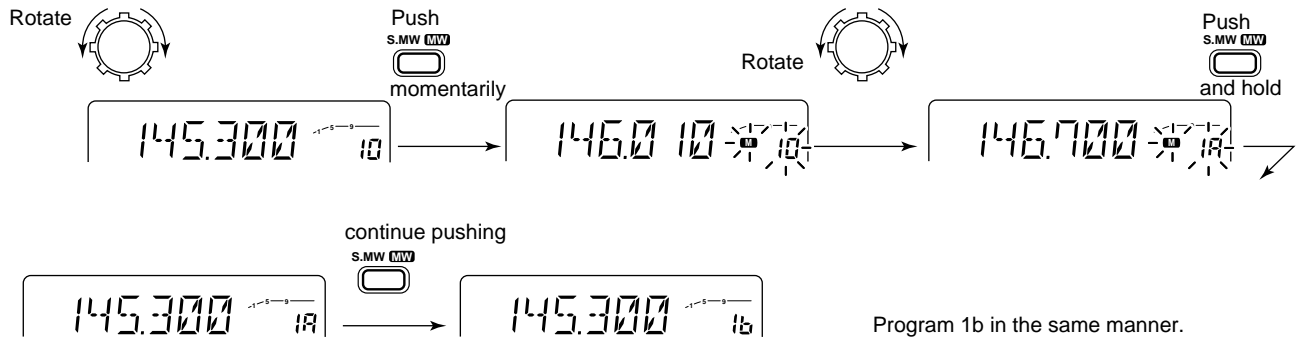

■ Programming scan edges via the microphone

MW
A

- ① Set the desired frequency in VFO mode.
 - ➔ Push [VFO] to select VFO mode.
 - ➔ Set the frequency using the keypad.
- ② Push [FUNC] then [A MW] momentarily.
- ③ Push [▲] or [▼] to select scan edge channels.
- ④ Push [FUNC] then [A MW] for 1 sec. to program.
 - ➔ 3 beeps may sound and the VFO contents (including the subaudible tone frequency, etc.) are programmed.

➔ Memory channel number advances to the next scan edge channel (1b to 3b) when continuing to push [A MW] after programming.

- ⑤ To program a frequency for the other scan edge channel, repeat steps ① and ④.

[EXAMPLE]: Programming 145.30 MHz and 145.80 MHz into scan edges 1A and 1b, respectively.

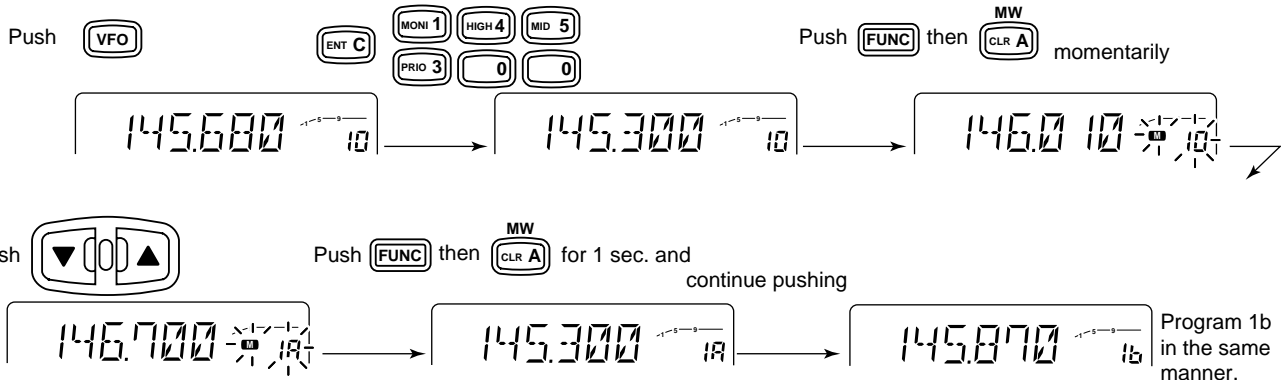

9 SCAN OPERATION

■ Skip channel setting

USING SET MODE

The memory skip function speeds up scanning by checking only those memory channels not set as skip channels. Set skip channels as follows.

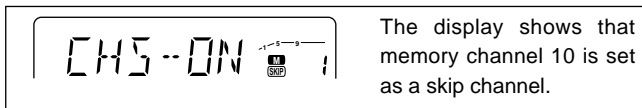

- ① Select a memory channel:
 - Select memory mode by pushing [M/CALL] once or twice.
 - Rotate the tuning dial to select the memory channel.
- ② Push [SET] one or more times until “CHS” appears as shown above.
- ③ Rotate the tuning dial to turn the skip function ON or OFF for the selected channel.
 - “SKIP” appears : The memory channel is skipped during (CHS-ON) memory scan.
 - “SKIP” disappears : The memory channel is scanned during (CHS-OFF) memory scan.
- ④ Push [V/MHz] to exit set mode.



- ① Select a memory channel.
 - Select memory mode by pushing [MR].
 - Push [▲] or [▼] to select a memory channel.
- ② Push [ⓂSET] one or more times until “CHS” appears as shown at left.
- ③ Push [▲] or [▼] to set or cancel the skip setting.
 - See item ③ at left for skip indicator details.
- ④ Push [ⓂCLR] to exit set mode.

☞ NOTES:

Even though scan edge channels cannot be set as skip channels, they ARE skipped during memory scan.

Memory channels programmed with memory names cannot be set as skip channels. To set them as skip channels, first push and hold [ANM] for 1 sec., then set as described above.

■ Scan resume condition

USING SET MODE

The scan resume condition can be selected as timer, pause or empty pause scan. The empty pause scan is useful for finding unused frequencies. The selected resume condition is also used for priority watch. (p. 42)

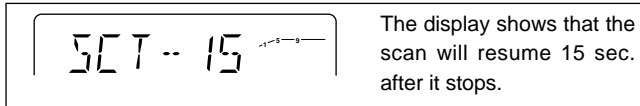

- ① Push [SET] one or more times until “SCT” or “SCP” appears as shown above.
 - Cancel the DTMF memory encoder in advance, if necessary. (p. 44)
- ② Rotate the tuning dial to set the desired timer:
 - “SCT-15” : Scan pauses 15 sec. while receiving a signal.
 - “SCT-10” : Scan pauses 10 sec. while receiving a signal.
 - “SCT-5” : Scan pauses 5 sec. while receiving a signal.
 - “SCP-2” : Scan pauses until the signal disappears and then resumes 2 sec. later.
 - “SCT-EP” : Scan pauses on a frequency that is not busy and resumes 2 sec. after a signal appears.
- ③ Push [V/MHz] to exit set mode.

SET
B

- ① Push [BSET] one or more times until “SCT” or “SCP” appears as shown at left.
 - Cancel the DTMF memory encoder in advance, if necessary. (p. 44)
- ② Push [▲] or [▼] to select the scan resume condition.
 - See item ② at left for scan resume condition details.
- ③ Push [A CLR] to exit set mode.

☞ NOTE:

SET mode cannot be accessed when memory channel names are displayed. To set the scan resume condition, first push [ANM] for 1 sec. to select frequency indication.

10 PRIORITY WATCH

■ Priority watch types

Priority watch checks for signals on a memory or call channel every 5 sec. while operating on a VFO frequency. The transceiver has 3 priority watch types to suit your needs. You can transmit on the VFO frequency while the priority watch operates.

The watch resumes according to the selected scan resume condition. See previous page for details.

☞ NOTES:

- ▶ Priority watch cannot be started from a scratch pad memory.
- ▶ If the DTMF memory encoder is activated, it is automatically cancelled when priority watch starts.
- ▶ If the pocket beep function is activated, the transceiver automatically selects the tone squelch function when priority watch starts.
- ▶ When "SCT-EP" is selected for the scan resume condition, the priority watch pauses on a no-signal channel. (p. 41)

MEMORY CHANNEL WATCH

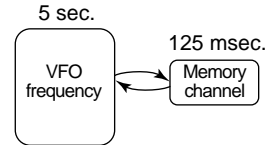

While operating on a VFO frequency, priority watch checks for a signal on the selected memory channel every 5 sec.

- A memory channel with skip information can be watched.

MEMORY SCAN WATCH

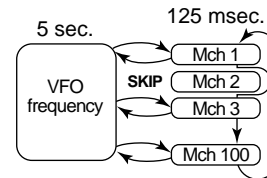

While operating on a VFO frequency, priority watch checks for signals on each memory channel in sequence.

- The memory skip function is useful to speed up the scan.

CALL CHANNEL WATCH

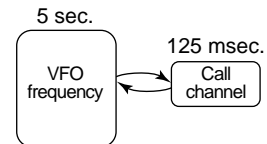

While operating on a VFO frequency, priority watch checks for a signal on the call channel every 5 sec.

■ Priority watch operation

- ① Select VFO mode; then, set an operating frequency.
- ② Set the watching channel(s).

For memory channel watch:

Select the desired memory channel.

For memory scan watch:

Select memory mode; then, push [(V/MHz)SCAN] for 1 sec. to start memory scan.

For call channel watch:

Select the call channel by pushing [M/CALL] once or twice.

- ③ Push [(M/CALL)PRIO] for 1 sec. to start the watch.
 - The transceiver checks the memory or call channel frequency every 5 sec.
 - The watch resumes according to the selected scan resume condition. (p. 41)
 - While the watch is pausing, pushing [M/CALL] resumes the watch manually.
- ④ Push [M/CALL] while the display shows the VFO frequency to stop the watch.

While pausing on the memory or call channel "PRIO" flashes.



- ① Select VFO mode; then, set an operating frequency.
- ② Set the watching channel(s).

For memory channel watch:

Push [MR] then [▲] or [▼] to select the desired memory channel.

For memory scan watch:

Push [MR] then [②SCAN] to start the memory scan.

For call channel watch:

Push and hold [(MR)CALL] to select the call channel.

- ③ Push [③PRIO] to start the watch.
 - The transceiver checks the memory or call channel frequency every 5 sec.
 - The watch resumes according to the selected scan resume condition. (p. 41)
 - To resume the watch manually when paused, push [③PRIO] or [ⒶCLR].
- ④ To stop the watch, push [ⒶCLR] once (or twice while watch is paused).

11 DTMF MEMORY ENCODER

■ Programming a DTMF code

DTMF codes are used for autopatching, accessing repeaters, controlling other equipment, etc. The transceiver has 14 DTMF memory channels (d0–d9, dA–dd) for storage of often-used DTMF codes of up to 16 digits.



- 1 Push [FUNC] then [DTMF LOW 6] to turn the DTMF memory function ON.
 - “d” appears in place of the 100 MHz digit.
- 2 Push [SET B] to enter the programming condition.
- 3 Push [▲] or [▼] to select the desired channel.

- 4 Push the desired digit keys.

- When the first digit is input, previous memory contents are cleared automatically.
- “E” stands for “*” and “F” stands for “#.”
- Push [▲] and repeat this step when making a mistake.
- The S/R/F indicator shows the digit group. The indication increases every 6 digits.

- 5 Push [VFO] to exit the programming condition.

- The [CLR A] key cannot be used to exit. If pushed, “A” is input and the previously programmed data is erased. Reprogram in such a case.

[EXAMPLE]: Programming “5428AB453” into DTMF memory channel “d4.”

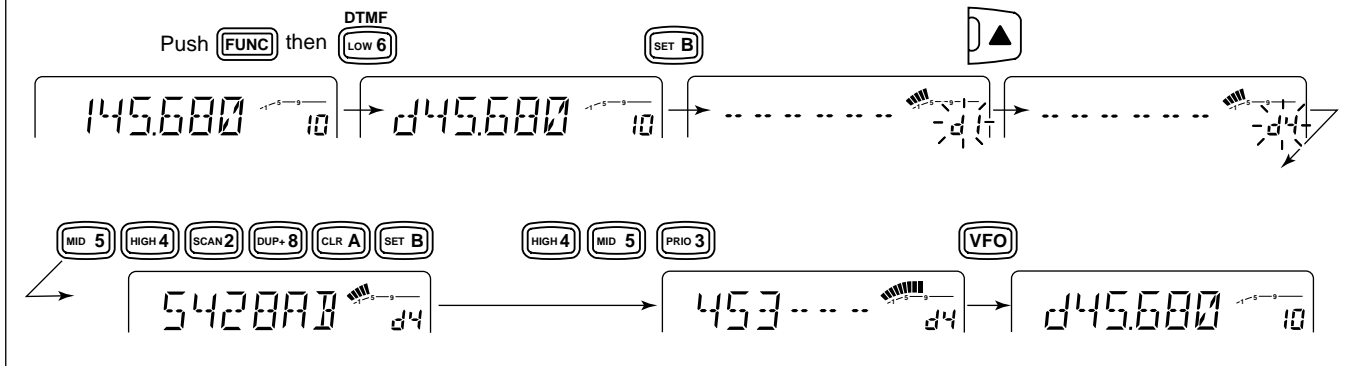

■ Transmitting a DTMF code

◇ Automatic transmission (DTMF memory)



- ① Push [FUNC] then [ⓄDTMF] to turn the DTMF memory function ON.
 - “d” appears in place of the 100 MHz digit.
- ② Push [ⓄSET] to enter the programming condition.
- ③ Push [▲] or [▼] to select the desired channel.
- ④ Push [PTT] to transmit the selected memory.
 - Each push of [PTT] transmits the DTMF code.
- ⑤ Push [ⓄCLR] to cancel the function.

◇ Transmitting a DTMF memory directly



- ① Push [FUNC] then [ⓄDTMF] to turn the DTMF memory encoder ON.
 - “d” appears in place of the 100 MHz digit.
- ② Push [DTMF-S], then push the desired DTMF channel number.
 - “0” to “9” and “A” to “D” are available for channel numbers.
- ③ Push [DTMF-S] again to deactivate the DTMF setting.
- ④ Push [ⓄCLR] to turn the DTMF memory encoder OFF.
 - When the DTMF memory encoder is turned ON continuously, each push of the PTT transmits the previously selected DTMF code.

■ DTMF speed

USING INITIAL SET MODE

The rate at which DTMF memories send individual DTMF characters can be set to accommodate operating needs.

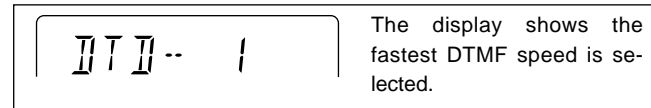

- ① Push [PWR] to turn power OFF.
- ② While pushing [SET] (far left switch), push [PWR] for 1 sec. to turn power ON and enter initial set mode.
- ③ Push [SET] or [MONI] to select the “DTD” display as shown above.
- ④ Rotate the tuning dial to select the desired speed as shown in the table below.
- ⑤ Push [PWR] to exit initial set mode.

DISPLAY	INTERVAL	SPEED
DTD-- 1	100 msec.	5.0 cps
DTD-- 2	200 msec.	2.5 cps
DTD-- 3	300 msec.	1.6 cps
DTD-- 5	500 msec.	1.0 cps

cps=characters/sec

12 POCKET BEEP AND TONE SQUELCH

■ Pocket beep operation

This function uses subaudible tones for calling and can be used as a “common pager” to inform you that someone has called while you were away from the transceiver.

◇ Waiting for a call from a specific station

- ① Set the operating frequency.
- ② Program the subaudible tone frequency in set mode.
 - See p. 23 for programming details.
- ③ Push [TONE] one or more times to indicate “T SQL ((•))” in the function display.
- ④ When a signal with the correct tone is received, the transceiver emits beep tones and flashes “((•))”.
 - Beep tones sound for 30 sec and “((•))” flashes. To stop the beeps and flashing manually, push any key. When the beep tones are not stopped manually, “((•))” continues flashing until step ⑤.
- ⑤ Push [PTT] to answer.
- ⑥ Push [TONE] once or twice to cancel the function.



- ① Set the operating frequency.
- ② Program the subaudible tone frequency in set mode.
 - See p. 23 for programming details.
- ③ Push [FUNC] then [Ⓜ SQL ((•))] to turn the pocket beep ON.
- ④ When a signal with the correct tone is received, the transceiver emits beep tones for 30 sec. and flashes “((•))”.
- ⑤ Push [PTT] to answer or push [Ⓜ CLR] to stop the beeps and flashing.
 - Tone squelch is automatically selected.
 - Pushing [FUNC] then [Ⓜ TSQL] also selects the tone squelch.
- ⑥ To cancel the function, push [FUNC] then [Ⓜ T-OFF].



◇ Calling a waiting station using pocket beep

A subaudible tone matched with the station’s frequency is necessary. Use the tone squelch on the next page or a subaudible tone encoder (pgs. 23, 47)

■ Tone squelch operation

The tone squelch opens only when receiving a signal with the same pre-programmed subaudible tone.

- ① Set the operating frequency.
- ② Program the subaudible tone frequency in set mode.
 - See p. 23 for programming details.
- ③ Push [TONE] one or more times to indicate “T SQL” appears in the function display.
- ④ When a signal with the correct tone is received, the squelch opens and the signal can be heard.
 - When the received signal includes an unmatched tone, the squelch does not open. However, the S/Rf indicator shows the received signal strength.
 - To open the squelch manually, push [MONI].
- ⑤ Operate the transceiver in the normal way (push [PTT] to transmit; release [PTT] to receive).
- ⑥ To cancel the tone squelch, push [TONE].
 - “T SQL” disappears from the function display.



- ① Set the operating frequency.
- ② Program the subaudible tone frequency in set mode.
 - See p. 23 for programming details.
- ③ Push [FUNC] then [9T SQL] to turn the tone squelch ON.
- ④ When a signal with the correct tone is received, the squelch opens and the signal can be heard.
 - When the received signal includes an incorrect tone, the squelch does not open. However, the S/Rf indicator shows the received signal strength.
 - To open the squelch manually, push [MONI].
- ⑤ Operate the transceiver in the normal way (push [PTT] to transmit; release [PTT] to receive).
- ⑥ To cancel the tone squelch, push [FUNC] then [9T-OFF].



12 POCKET BEEP AND TONE SQUELCH

■ Tone scan

By monitoring a signal that is being transmitted on a repeater input frequency, you can determine the tone frequency necessary to open a repeater.

- ① Set the frequency to be checked for a tone frequency e.g. a repeater input frequency.
- ② Push [(TONE)T-SCAN] for 1 sec. to start the tone scan.
 - To change the scanning direction, rotate the tuning dial.
- ③ When the tone frequency is matched, the squelch opens and the tone frequency is temporarily programmed into the selected mode such as VFO, memory/call channel or scratch pad memory.
 - The tone scan pauses when a tone frequency is detected.
 - The decoded tone frequency is used for the tone encoder or tone encoder/decoder depending on the tone squelch ON/OFF setting.
- ④ Push [V/MHz] to stop the scan.

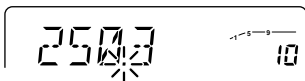

- ① Set the frequency to be checked for a tone frequency e.g. repeater input frequency.
- ② Push [F-2] for 1 sec. to start the tone scan.
- ③ When the tone frequency is matched, the squelch opens and the tone frequency is programmed into the selected mode such as VFO, memory/call channel or scratch pad memory.
- ④ Push [ⓂCLR] to stop the scan.

☞ **NOTE:** The decoded tone frequency is programmed temporarily when a memory or call channel is selected. However, this will be cleared when overwriting the memory/call channel.

■ Connection

Wireless remote control is available when the following options are used.

- ◆ HM-90 WIRELESS MICROPHONE
- ◆ EX-1759 INFRARED RECEIVER

The BC-96 MICROPHONE HOLDER is additionally recommended for use with the HM-90, since the HM-90's internal battery requires charging.

◇ Recommended connection

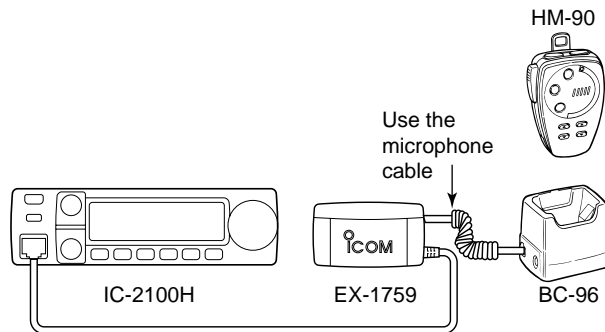

■ HM-90 WIRELESS MICROPHONE

The HM-90's internal battery should be charged when the microphone is not being held.

Charging period: 1.5 hr. with timer

(or 8 hr. when battery is exhausted)

Operating period: 12 hr. (operation:standby=1:4)

◇ Charging method

Choose one of the following methods:

- ➔ Connect the cable from the HM-90 to the EX-1759.
- ➔ Connect the BC-96 and EX-1759; then put the HM-90 into the BC-96 (refer to the diagram at left).
- ➔ Place the HM-90 into the BC-96 (with no connection to the EX-1759).
 - Use the CP-13/L or OPC-288/L to connect the BC-96 to a cigarette lighter socket or a DC power supply, respectively.

◇ Turning the wireless remote ON/OFF

When you use the HM-90 as a wired microphone, the wireless remote control circuit can be turned OFF.

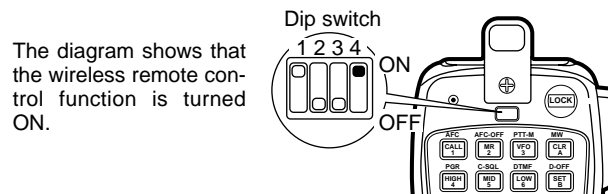

The diagram shows that the wireless remote control function is turned OFF.

13 WIRELESS OPERATION

■ EX-1759 installation

The EX-1759 INFRARED RECEIVER can be installed for 2 different purposes depending on the HM-90 charger. This is because the EX-1759 has both an infrared receiver and a microphone connector which contains microphone charging capabilities.

When using the BC-96 with external DC input

Attach the EX-1759 to a suitable location for receiving infrared signals, e.g. sunvisor, etc.

When using the connector for a microphone charger

Attach the EX-1759 to a suitable location for receiving infrared signals and where it can be connected to cable, e.g. the console, etc.

☞ **NOTE:** DO NOT attach the EX-1759 where it will be subject to direct sunlight as it cannot detect infrared signals under such conditions.

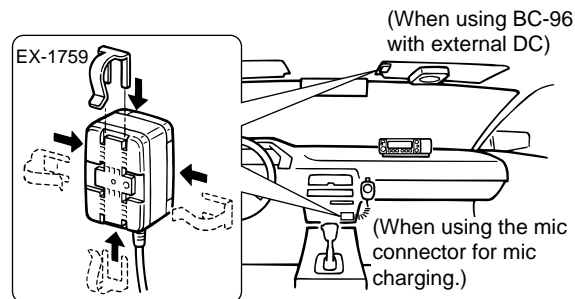

The installation clip can be oriented in 1 of 4 ways.

Optional infrared sub receiver

An optional EX-1513 INFRARED SUB RECEIVER is available to increase the remote control reliability and extend the controllable area. Connect the EX-1513 to the inside connector of the EX-1759.

☞ **NOTE:** The HM-98S can be connected and used with the EX-1759, however, the optional wireless microphone cannot be used in such a case.

■ HM-90 switches

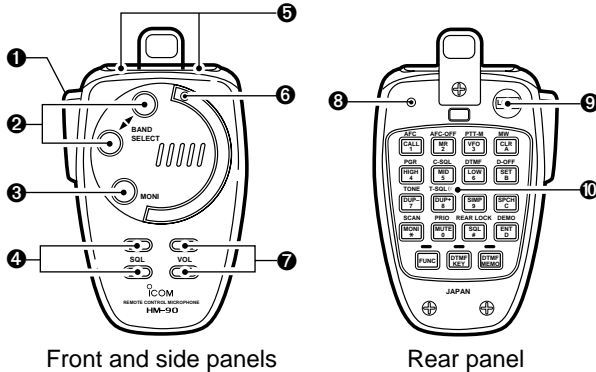

Front and side panels

Rear panel

① PTT SWITCH

- ➔ Push and hold to transmit; release to receive.
- ➔ Toggles between transmitting and receiving while the one-touch PTT function is in use.

② BAND SWITCHES [BAND SELECT ▲, ▼]

No function.

③ MONITOR SWITCH [MONI]

Toggles between opening and closing the squelch.

④ SQUELCH LEVEL UP/DOWN SWITCHES

[▲SQL], [▼SQL]

No function.

⑤ FREQUENCY UP/DOWN SWITCHES [UP], [DN]

- ➔ Push either switch to change the operating frequency, memory channel, set mode contents, etc.
- ➔ Push and hold either switch to start scanning.

⑥ ACTIVITY INDICATOR

Lights red while a key is pushed; lights green while the one-touch PTT function is in use.

⑦ AUDIO VOLUME UP/DOWN SWITCHES

[▲VOL], [▼VOL]

No function.

⑧ MODE INDICATOR

Indicates the microphone condition.

- Lights red when [FUNC] is pushed.
- Lights green when [DTMF KEY] is pushed.
- Lights orange when [DTMF MEMO] is pushed.















⑨ LOCK SWITCH [LOCK]









Locks all switches and keys on the microphone except for the PTT switch.

⑩ KEYPAD

Used for controlling the transceiver, transmitting a DTMF memory channel, etc.

13 WIRELESS OPERATION

KEY	FUNCTION	SECONDARY FUNCTION (after )	OTHER FUNCTIONS
	Selects the call channel.	No secondary function.	<ul style="list-style-type: none"> • After  : Input the appropriate digit for frequency or memory channel selection. • After  : Transmit the appropriate DTMF code. • After  : Transmit the appropriate DTMF memory contents. [0] to [9], [A] to [D] can be used for DTMF memory.
	Selects memory mode.	No secondary function.	
	Selects VFO mode.	Turns the one-touch PTT function ON and OFF.	
	Selects high output power.	No secondary function.	
	Selects mid output power.	No secondary function.	
	Selects low output power.	Turns the DTMF memory function ON.	
	Selects -duplex.	Turns the subaudible tone encoder ON.	
	Selects +duplex.	Turns the pocket beep function ON.	
	Selects simplex.	Turns the tone squelch function ON.	
	Mutes audio signals.	Starts and stops a priority watch.	

KEY	FUNCTION	SECONDARY FUNCTION (after )	OTHER FUNCTIONS
	Clears a digit before entry. Cancels the scan, priority watch, or DTMF memory function.	Writes the VFO contents into the memory channel or call channel. Advances the memory channel number when continuously pushed after programming is completed.	<ul style="list-style-type: none"> After  : Transmit the appropriate DTMF code. [*MONI] Transmits a 1750 Hz tone call signal for 0.5 sec.
	Enters set mode and advances the set mode selection order.	Turns the DTMF memory function OFF.	
	Decreases the set mode selection order after entering set mode. NOTE: The IC-2100H has no voice synthesizer function.	Turns the subaudible tone encoder, pocket beep or tone squelch OFF.	
	Sets the keypad for numeral input.	Enters and exits demonstration mode.	
	Toggles between opening and closing the squelch.	Starts and stops scanning.	
	No function.	Locks all the keys on the microphone's rear panel.	

[#SQL]
Transmits a 1750 Hz tone call signal while pushing.

13 WIRELESS OPERATION

■ Microphone address

USING INITIAL SET MODE

The transceiver has 8 possible microphone addresses (including OFF) to help prevent interference from other HM-90 wireless microphones. Set both the microphone address and microphone dip switch to the same value as follows.

☞ **NOTE:** When the supplied microphone is connected, the transceiver rejects control signals from the HM-90 even when the microphone address is matched.

◇ Microphone address

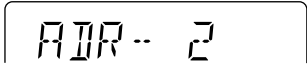
- ① Push [PWR] to turn power OFF.
- ② While pushing [SET], turn power ON to enter initial set mode.
- ③ Push [SET] one or more times to select the “ADR” display as shown at right.  The display shows the address is set to 2.
- ④ Rotate the tuning dial to set the microphone address to 0–7 or to turn the microphone control OFF.
 - When “ADR--OF” is selected, the transceiver rejects all control signals from the HM-90.
- ⑤ Push [PWR] to turn power OFF and exit initial set mode.

◇ Microphone dip switch

- ① Remove the switch cover from the microphone panel.
- ② Set the microphone dip switch and the microphone address to the same value as shown below.
- ③ Replace the switch cover.

MICROPHONE ADDRESS	DIP SWITCH		
	S1-1	S1-2	S1-3
ADR-0	OFF	OFF	OFF
ADR-1 (default)	ON	OFF	OFF
ADR-2	OFF	ON	OFF
ADR-3	ON	ON	OFF
ADR-4	OFF	OFF	ON
ADR-5	ON	OFF	ON
ADR-6	OFF	ON	ON
ADR-7	ON	ON	ON

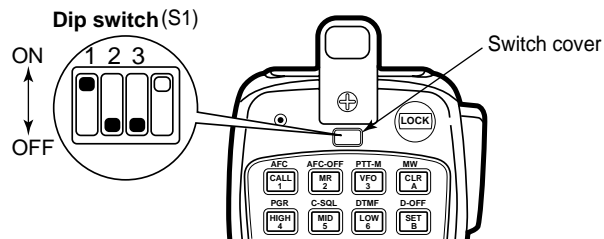

■ Beep tones on/off

USING INITIAL SET MODE

You can select silent operation by turning beep tones OFF or you can select to have confirmation beeps sound at the push of a switch by turning beep tones ON.

- ① Push [PWR] to turn power OFF.
- ② While pushing [SET], turn power ON to enter initial set mode.
- ③ Push [SET] one or more times until "BEP" appears.
 - Pushing [MONI] reverses the order of selection.
- ④ Rotate the tuning dial to select the condition.

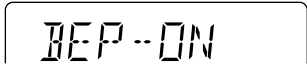

 - "BEP--OF": Beep tones are turned OFF.
 - "BEP--ON": Beep tones are turned ON.

The display shows that beep tones are turned ON.
- ⑤ Push [PWR] to exit initial set mode.

■ Time-out timer

USING INITIAL SET MODE

To prevent accidental prolonged transmission with the one-touch PTT function, etc., the transceiver has a time-out timer. This timer cuts a transmission OFF after 3, 5, 15 or 30 min. of continuous transmission. This timer can be cancelled (default).

Approx. 10 sec. before the time-out timer is activated, the transceiver emits a beep tone as a warning.

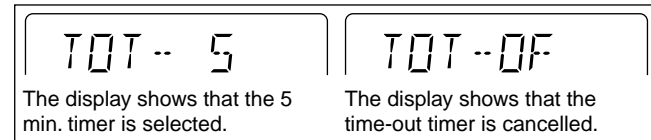

- ① Push [PWR] to turn power OFF.
- ② While pushing [SET], turn power ON to enter initial set mode.
- ③ Push [SET] one or more times until "TOT" appears.
 - Pushing [MONI] reverses the order of selection.
- ④ Rotate the tuning dial to select the desired time-out time or turn the timer OFF ("OF").
- ⑤ Push [PWR] to exit initial set mode.

14 OTHER FUNCTIONS

■ Auto power-off USING INITIAL SET MODE

The auto power-off function conveniently turns the transceiver power OFF after a preset time in which no operations are performed. In this way, if you forget to turn power OFF, the transceiver automatically turns itself OFF.

The time can be set to 30 min., 1 hr., 2 hr. or turned OFF. The selected time is retained even when the transceiver is turned OFF via the auto power-off function. To cancel the function, select "OF" in step ④ below.

- ① Push [PWR] to turn power OFF.
- ② While pushing [SET], turn power ON to enter initial set mode.
- ③ Push [SET] one or more times until "POF" appears.
 - Pushing [MONI] reverses the order of selection.
- ④ Rotate the tuning dial to select the desired auto power-off time or turn the timer OFF ("OF").
 - "AO" appears when an auto power-off time is set.
- ⑤ Push [PWR] to exit initial set mode.

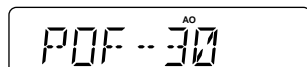

The display shows that the 30 min. timer is selected.

■ Squelch delay USING INITIAL SET MODE

During operation, received signal strength often fluctuates. This can result in annoying repeated opening and closing of the squelch during reception of the same signal. The IC-2100H has a built-in squelch delay function which helps prevent this. When both stations are operating from a fixed location e.g. during packet operation, this function should be set to "short."

- ① Push [PWR] to turn power OFF.
- ② While pushing [SET], turn power ON to enter initial set mode.
- ③ Push [SET] one or more times until "SQT" appears.
 - Pushing [MONI] reverses the order of selection.
- ④ Rotate the tuning dial to set the squelch delay to "L" (long) or "S" (short).
- ⑤ Push [PWR] to exit initial set mode.

■ Microphone [F-1]/[F-2] keys

Switches on the transceiver's front panel can be assigned to the microphone's [F-1] and [F-2] keys.

- ① Turn power OFF.
- ② While pushing the desired switch on the transceiver and [F-1] or [F-2] on the microphone, turn power ON.
 - The function is programmed into the key ([F-1] or [F-2]).

• Default setting

The following functions are assigned to the [F-1]/[F-2] keys when first applying power or after CPU resetting.

[F-1]: selects output power; push and hold to select duplex setting

[F-2]: selects a tone function or none at all; push and hold to start tone scan, push again to stop tone scan.

☞ **NOTE:** [F-1] and [F-2] key assignment is available for the HM-98S HAND MICROPHONE only.

■ Demonstration display

AT POWER ON

A demonstration function is available at power ON. This function gives you a quick visual introduction to the function display indicators.

- ① While pushing [T-SCAN] (3rd switch from right), push [PWR] to turn power ON.
 - The transceiver cycles through a visual tour of the function display indicators.
- ② Push any switch to exit demonstration mode and enter the normal operating condition temporarily.

☞ **NOTE:** The transceiver automatically returns to demonstration mode after 2 min. in which no operations are performed. To deactivate the demonstration display permanently, turn power OFF, then while pushing [T-SCAN], turn power ON again.

14 OTHER FUNCTIONS

■ Display color

USING SET MODE

The display color can be set to amber or green.

- ① Push [SET] one or more times until “COL” appears.
 - Pushing [MONI] reverses the order of selection.

- ② Rotate the tuning dial to set the desired color.

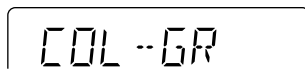

- ③ Push [V/MHz] to return to normal operation.

The display shows that green is selected for the color.

■ Display dimmer

USING SET MODE

Adjust to suit lighting conditions and personal preferences.

- ① Push [SET] one or more times until “DIM” appears.
 - Pushing [MONI] reverses the order of selection.

- ② Rotate the tuning dial to set the desired intensity.

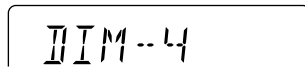

- Intensity can be set from “1” (dark) to “4” (bright).

The display shows backlighting set to the brightest.

- ③ Push [V/MHz] to return to normal operation.

■ FM narrow mode

USING SET MODE

FM narrow mode is only available for the Europe version.

- ① Push [SET] one or more times until “W/N” appears.
 - Pushing [MONI] reverses the order of selection.

- ② Rotate the tuning dial to set operation to wide or narrow.

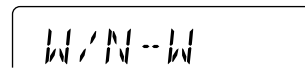

- ③ Push [V/MHz] to return to normal operation.

The display shows that wide operation is selected.



The Europe version of the IC-2100H comply with European regulations regarding narrow FM bandwidth operation on amateur transceivers. Wide and narrow FM operation differ in the following specifications:

	WIDE	NARROW
TX: Max. deviation	±5 kHz	±2.5 kHz
RX: Selectivity	12 kHz/−6 dB 28 kHz/−60 dB	6 kHz/−6 dB 18 kHz/−60 dB

■ Data cloning

AT POWER ON

Cloning allows you to quickly and easily transfer the programmed contents from one transceiver to another; or, data from a PC to a transceiver using the optional CS-2100 CLONING SOFTWARE.

- ① Connect the OPC-474 cloning cable with adapter plugs to the [SP] jack of the master and slave transceivers.
 - The master transceiver is used to send data to the slave transceiver.
- ② While pushing [M/CALL] (second switch from right)x, turn power ON to enter cloning mode (master transceiver only—power on only for slave transceiver).
 - “CLONE” appears and the transceivers enter the clone standby condition. 
- ③ Push [S.MW] on the master transceiver.
 - “CLOUT” appears in the master transceiver’s display and the S/RF indicator shows that data is being transferred to the slave transceiver. 
 - “CL IN” appears automatically in the slave transceiver’s display and the S/RF indicator shows that data is being received from the master transceiver. 
- ④ When cloning is finished, turn power OFF, then ON to exit cloning mode.

◇ Cloning using a PC

Data can be cloned to and from a PC (IBM compatible) using the optional CS-2100 CLONING SOFTWARE and the optional OPC-478 CLONING CABLE. Consult the CS-2100 CLONING SOFTWARE HELP file for details.

◇ Cloning error

☞ **NOTE:** DO NOT push any key on the slave transceiver during cloning. This will cause a cloning error.

When the display at right appears, a cloning error has occurred.



In such a case, both transceivers automatically return to the clone standby condition and cloning must be repeated.

15 MAINTENANCE

■ Troubleshooting

If your transceiver seems to be malfunctioning, please check the following points before sending it to a service center.

PROBLEM	POSSIBLE CAUSE	SOLUTION	REF.
No power comes on.	<ul style="list-style-type: none"> • Power connector has a poor contact. • Polarity of the power connection is reversed. • Blown fuse. 	<ul style="list-style-type: none"> • Check the connector pins. • Reconnect the power cable observing the proper polarity. Replace the fuse if damaged. • Check the cause, then replace the fuse. 	— pgs. 11, 62 p. 62
No sound comes from the speaker.	<ul style="list-style-type: none"> • Volume is too low. • The audio mute function is activated. • Squelch is set too tight. • A selective call or squelch function is activated such as pocket beep or tone squelch. 	<ul style="list-style-type: none"> • Rotate [VOL] clockwise. • Push any switch or key to deactivate it. • Set the squelch level to the threshold. • Turn the appropriate function OFF. 	p. 18 p. 18 p. 18 pgs. 21
Sensitivity is low and only strong signals are audible.	<ul style="list-style-type: none"> • Antenna feedline or the antenna connector solder has a poor contact or is short circuited. 	<ul style="list-style-type: none"> • Check, and if necessary, replace the feedline or solder the antenna connector again. 	46, 47 p. 12
No contact possible with another station.	<ul style="list-style-type: none"> • The transceiver is set to semi-duplex. • The other station is using tone squelch. 	<ul style="list-style-type: none"> • Set to simplex. • Turn the tone squelch function ON. 	p. 21 p. 47
Repeater cannot be accessed.	<ul style="list-style-type: none"> • Wrong offset frequency is programmed. • Wrong subaudible tone frequency is programmed. 	<ul style="list-style-type: none"> • Correct the offset frequency. • Correct the subaudible tone frequency. 	p. 24 p. 23
Frequency cannot be set.	<ul style="list-style-type: none"> • The frequency lock function is activated. • Priority watch is paused on the watching frequency. 	<ul style="list-style-type: none"> • Turn the function OFF. • Push [(M/CALL)PRIO] to resume the watch. 	p. 14 p. 42
Frequency cannot be set via the microphone.	<ul style="list-style-type: none"> • The frequency lock function is activated. • The microphone keypad lock function is activated. • Priority watch is paused on the watching frequency. 	<ul style="list-style-type: none"> • Push and hold [LOCK] to deactivate the frequency lock function. • Push [FUNC] then [#16KEYLOCK] to deactivate the microphone keypad lock function. • Push [(M/CALL)PRIO] to resume the watch. 	p. 14 p. 14

PROBLEM	POSSIBLE CAUSE	SOLUTION	REF.
Some memory channels cannot be selected via the microphone keypad.	<ul style="list-style-type: none"> • The input channel number has not yet been programmed. 	<ul style="list-style-type: none"> • Rotate the tuning dial to check whether the channel has been programmed or not. 	—
Scan does not operate.	<ul style="list-style-type: none"> • The squelch is open. • The selected scan edge memory channels (e.g. 1A and 1b) have the same frequencies (for programmed scan). • Only 1 memory channel is programmed or other channels are set as skip channels. • Priority watch is activated. 	<ul style="list-style-type: none"> • Set the squelch to the threshold point. • Reset the scan edges. • Program other memory channels or cancel the memory skip function in the desired channels. • Turn the function OFF. 	<p>p. 18 p. 38</p> <p>pgs. 38, 40 p. 42</p>
Transmission is automatically cut off.	<ul style="list-style-type: none"> • Time-out timer is activated. 	<ul style="list-style-type: none"> • Set the timer to OFF. 	p. 55
Transmission continues even when the PTT is released.	<ul style="list-style-type: none"> • One-touch PTT function is activated. 	<ul style="list-style-type: none"> • Turn the function OFF. 	p. 20
The function display shows erroneous informa-	<ul style="list-style-type: none"> • The CPU is malfunctioning. 	<ul style="list-style-type: none"> • Reset the CPU. 	p. 62

■ Fuse replacement

If the fuse blows or the transceiver stops functioning, find the source of the problem if possible, and replace the damaged fuse with a new, rated one (FGB 20 A) as shown below.

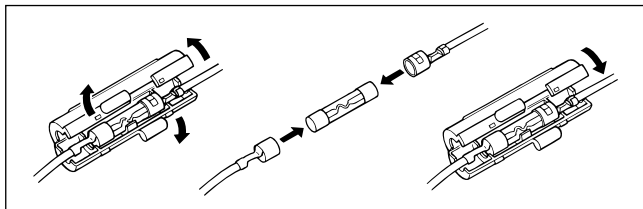

■ Partial CPU resetting AT POWER ON

If you want to initialize the operating conditions without clearing the memory contents, etc., a partial reset function is available for the transceiver.

While pushing [V/MHz] (far right switch) + [PWR], turn power ON.

- ▶ *Initialized settings:* VFO frequency, SET mode settings.
- ▶ *Retained settings:* Memory channels, call channel, scratch pad memories, DTMF memories, memory names, initial SET mode settings.

■ Resetting the CPU AT POWER ON

The function display may occasionally display erroneous information (e.g. when first applying power). This may be caused externally by static electricity or by other factors.

If this problem occurs, turn power OFF. After waiting a few seconds, turn power ON again. If the problem persists, perform the following procedure.

- Partial resetting is also available. See previous section for details.

▼CAUTION: Resetting the transceiver CLEARS all memory information and initializes all values in the transceiver.

While pushing [SET] (far left switch) + [S.MW], turn power ON.

- “CLEAR” appears and the transceiver is reset.

SPECIFICATIONS 16

General

- Frequency coverage : (unit: MHz)

VERSION	TRANSMIT	RECEIVE
USA	144–148 MHz	136–174 MHz*
Europe	144–146 MHz	144–146 MHz
Australia	144–148 MHz	144–148 MHz
Taiwan	144–146 MHz	144–146 MHz*
Asia	144–148 MHz	136–174 MHz*
IC-2100-T (Thailand)	144–146 MHz	144–146 MHz

*Guaranteed 144–148 MHz only.

- Mode : FM
- No. of memory channels : 113 (including 3 scan edge pairs, 6 scratch pad memories and 1 call)
- Frequency resolution : 5, 10, 12.5, 15, 20, 25, 30, 50 kHz
- Frequency stability : ± 10 ppm (-10°C to $+60^{\circ}\text{C}$)
- Power supply requirement : 13.8 V DC $\pm 15\%$
- Current drain (at 13.8 V DC) :
 - Receive Standby 0.8 A
 - Max. audio 1.0 A
- Antenna connector : SO-239 (50 Ω)
- Usable temperature range : -10°C to $+60^{\circ}\text{C}$; -14°F to $+140^{\circ}\text{F}$
- Dimensions : 140(W) \times 40(H) \times 180(D) mm
(projections not included) $5\frac{1}{2}$ (W) \times $1\frac{9}{16}$ (H) \times $7\frac{3}{32}$ (D) in
- Weight : 1.2 kg; 2 lb 10 oz

Transmitter

- Modulation system : Variable reactance frequency
- Output power : High 55 W (Thailand version: 10 W
Taiwan version: 25 W
Mid 10 W (approx.)
Low 5 W (approx.))
- Current drain (at 13.8 V DC) :
 - Transmit Max. power 12.0 A (less than 5.5 A for the Thailand version)
- Spurious emissions : -60 dB (Thailand version: -55 dB)
- Microphone connector : 8-pin modular (600 Ω)

Receiver

- Receive system : Double-conversion
superheterodyne
- Intermediate frequencies : 1st 15.65 MHz
2nd 450 kHz
- Sensitivity (at 12 dB SINAD) : Less than 0.18 μV
- Squelch sensitivity (threshold) : Less than 0.13 μV
- Selectivity : More than 12 kHz/ -6 dB
Less than 28 kHz/ -60 dB
(6 kHz/ -6 dB, 18 kHz/ -60 dB; FM narrow mode)
- Spurious response rejection ratio : More than 60 dB
- Audio output power : More than 2.4 W at 10%
distortion with an 8 Ω load
- Ext. speaker connector : 2-conductor 3.5 (d) mm ($\frac{1}{8}$ "
/ 8 Ω)

17 OPTIONS

Some of the following options may not be available due to variations in local electrical standards, etc. If you have any questions regarding options please consult your Icom dealer.

◇ Speakers

SP-10 EXTERNAL SPEAKER

Compact design. Cable length: 1.5 m; 4.9 ft.

SP-12 EXTERNAL SPEAKER

Slim dimensions. Cable length: 2.0 m; 6.6 ft.

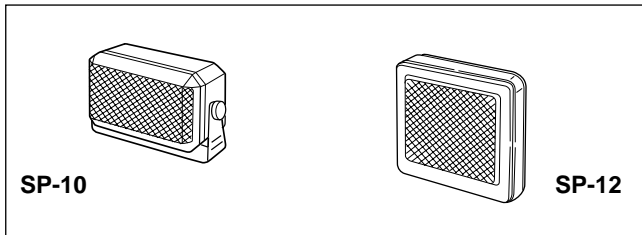

◇ Wireless remote accessories

HM-90 WIRELESS MICROPHONE

Infrared, full remote control microphone. Wired remote control is also possible.

EX-1759 INFRARED RECEIVER

Used to receive control signals from the HM-90.

EX-1513 INFRARED SUB RECEIVER

Used with the EX-1759 to increase remote control reliability and extend the controllable area.

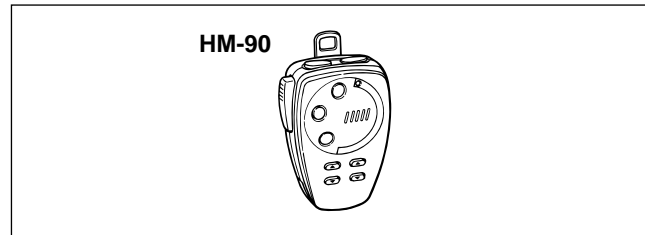

◇ **Hand microphones**

HM-77/A

DTMF microphone with DTMF memory function.

HM-78, HM-96, HM-118

Regular hand microphones.

HM-79, HM-97

Equipped with a tone call function.

HM-95

DTMF microphone.

HM-98S

Remote control microphone with keypad backlighting.

HM-118T/TA

DTMF microphones with keypad backlighting.

◇ **Other accessories**

HS-62 FLEXIBLE MOBILE MICROPHONE

+ **HS-15B SWITCH BOX** + **OPC-589 ADAPTER CABLE**

For all-around mobile operation.

CS-2100 CLONING SOFTWARE

+ **OPC-478 CLONING CABLE**

For quick and easy programming of memories, etc.

OPC-440/OPC-647 MIC EXTENSION CABLES

OPC-440: 5.0 m; 16.4 ft OPC-647: 2.5 m; 8.2 ft.

OPC-441 SPEAKER EXTENSION CABLE

5.0 m; 16.4 ft.

OPC-346/OPC-347 DC POWER CABLES

OPC-346: 3.0 m; 9.8 ft OPC-347: 7.0 m; 23.0 ft.

OPC-474 CLONING CABLE

For transceiver to transceiver cloning.

MB-17A MOBILE MOUNTING BRACKET

One-touch bracket. Transceiver is easily attached and removed.

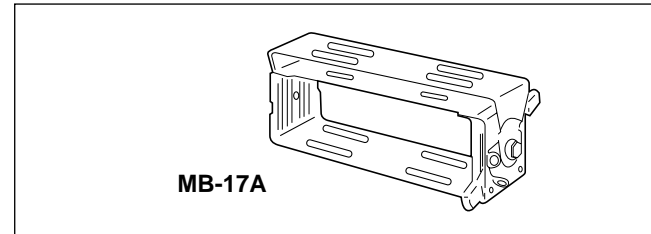

MB-17A

18 MODE ARRANGEMENT

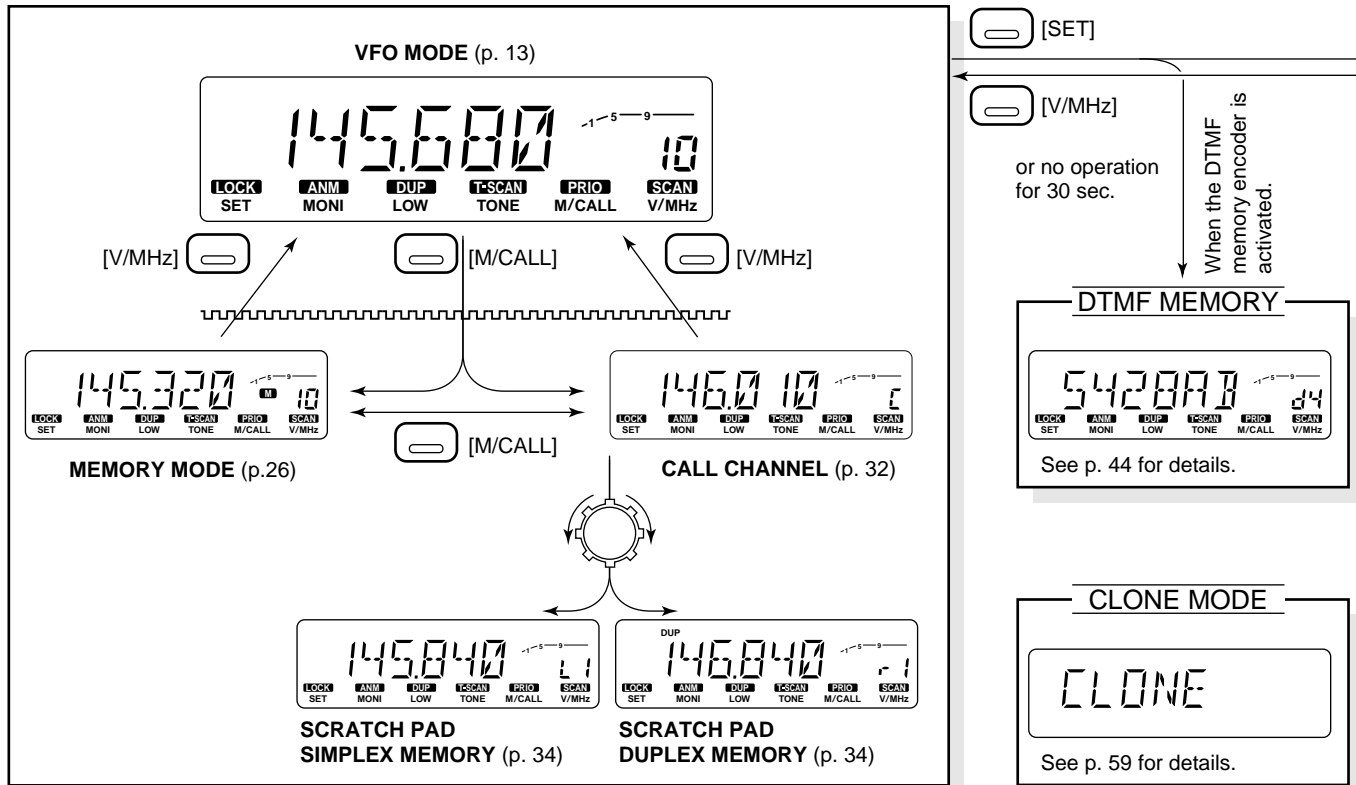

SET MODE

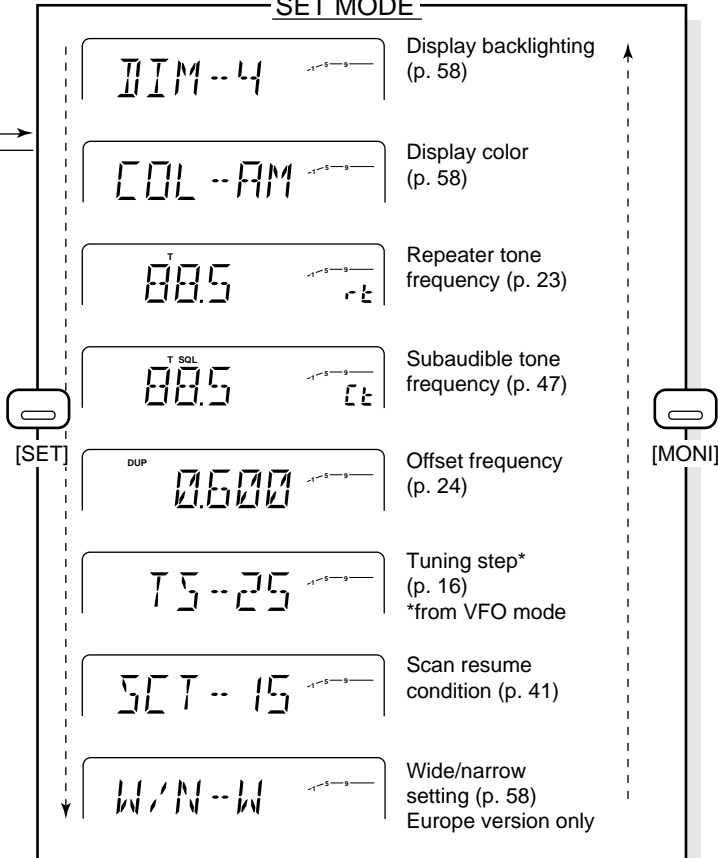

INITIAL SET MODE

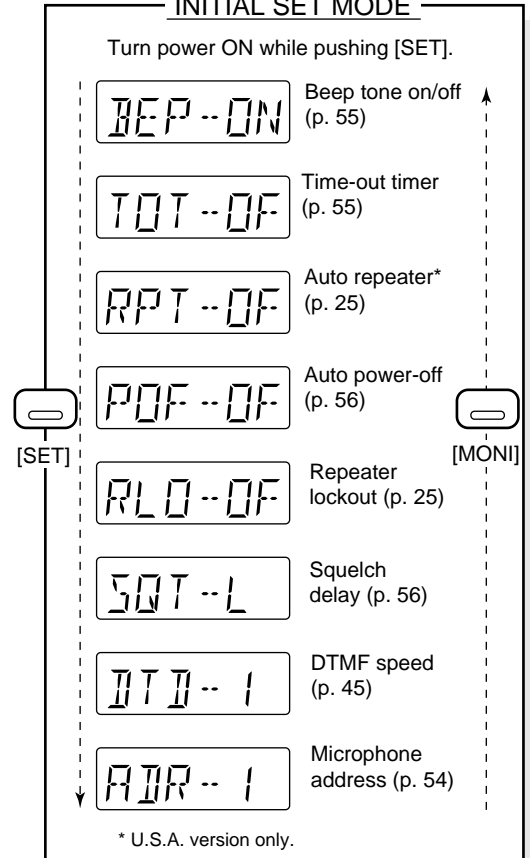

Count on us!

A-5492H-1EX-④
Printed in Japan
Copyright 1997 Icom Inc.

Icom Inc.
1-1-32 Kamiminami, Hirano-ku, Osaka 547-0003 Japan