

ICOM



INSTRUCTION MANUAL

GPS RECEIVER
GP-22



Icom Inc.

Thank you for purchasing the Icom GP-22 Handheld GPS Receiver. This unit has been designed to provide you with many years of exceptional performance.

You may use this GPS receiver in the following situations.

On Land



When you go mountain-climbing or skiing,

you can find your exact position even if you get lost in the middle of nowhere.

Enter the position of a mountain hut or some other landmark you would like to locate.

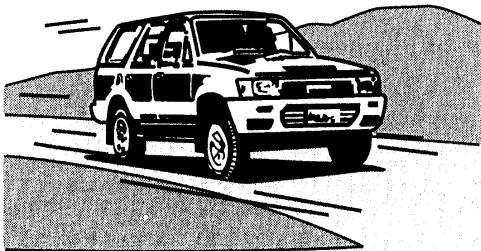

When you travel by car or bicycle,

you can find the exact position, bearing and range to your destination.



When you find a beautiful spot you would like to return to,

you can find the latitude and longitude and save the data for future use.

IMPORTANT

READ ALL INSTRUCTIONS carefully and completely before using the receiver.

SAVE THIS INSTRUCTION MANUAL — This instruction manual contains important safety and operating instructions for the GP-22.

At Sea

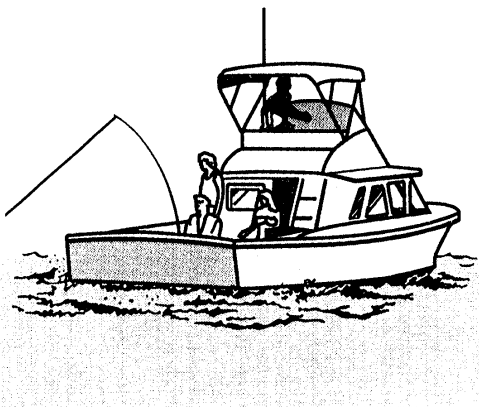

When you find a great fishing spot,

you can find and save the latitude and longitude of this point.

When you return to this location, an arrival tone sounds to let you know.

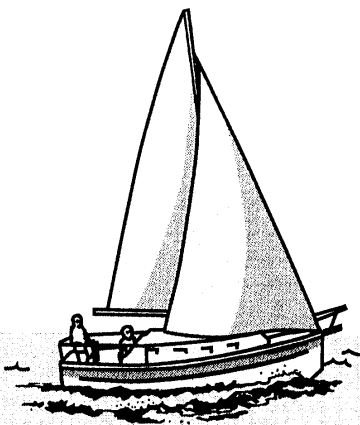

When you are sailing,

you can navigate while confirming your present position.

The position of a lighthouse or harbor can be saved in the GPS receiver beforehand.

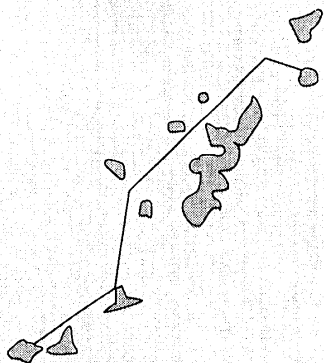

When you sail along a pre-planned route,

you can find the cross track error from the route and revise the heading.

IMPORTANT

This device is designed as an aid to navigation only.

The performance of this device can be affected by many factors, such as but not limited to, environmental conditions, improper handling, satellite signal availability, etc. It is the user's responsibility to follow good navigational practices and to utilize common sense at all times. Use of this device does not relieve the user of these responsibilities.

Accessories

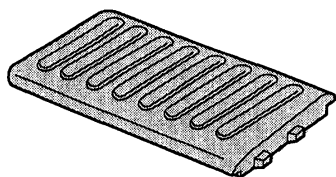

Rechargeable Nickel Metal
Hydride Battery Pack 1

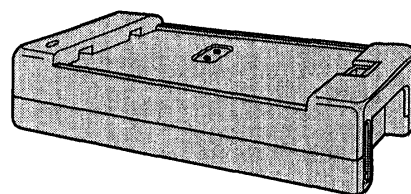

Battery Charger..... 1

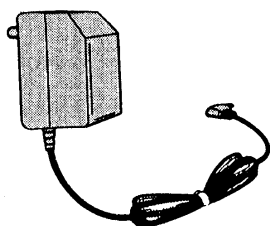

AC Adaptor
(For Battery Charger) 1

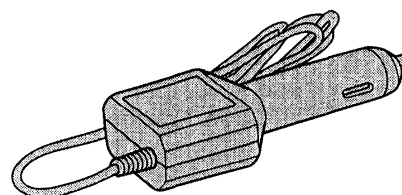

Cigarette Lighter Cable
(For Battery Charger) 1

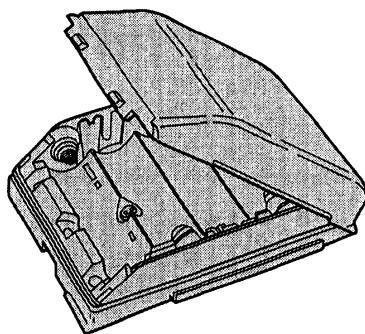

Battery Case for AA (R6)
Batteries 1
(Batteries not included)

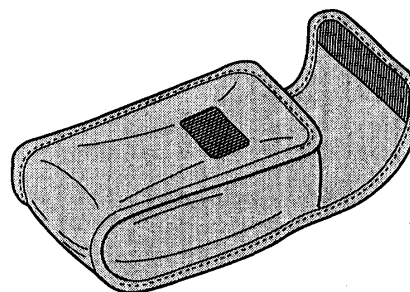

Carrying Case 1

Set Up	1
Pre-operation	2
The Four Function Modes	Position 3
	Navigation 4
	Confirmation 5
	Program 6
Appendices	7

Table of Contents

	Page
Precautions	8
GPS Technology	10
1 Set Up	
Location of Controls	12
Installing the Rechargeable Battery	15
Installing Alkaline Batteries	19
Instructions for Battery Use	22
2 Pre-operation	
Turning Power On	27
Adjusting Datum to Regional Standards	28
Adjusting to Local Time	30
Programming Continuous or Single Calculation Mode	32
Changing Units of Latitude/Longitude	34
Changing Units of Altitude	36
Changing Units of Distance and Speed	38
Collecting an Almanac	40
 THE FOUR FUNCTION MODES	
3 Position Mode	
Displaying Date and Time	44
Calculating Current Position	45
Determining Altitude	46
Waypoints and Latitude/Longitude	47
Entering Current Position into a Waypoint	48
Bearing and Range to a Destination	50
Displaying Bearing and Range to a Destination	51
4 Navigation Mode	
Displaying Bearing and Range to a Waypoint	53
Displaying Heading/Speed	54
Displaying Cross Track Error	55
Displaying Estimated Time of Arrival/Enroute	58
Using Waypoint Zero (From-To)	60

	Page	
5 Confirmation Mode		1
Confirming an Entered Waypoint's Latitude/Longitude.....	63	
Confirming Waypoint Numbers Entered in a Route.....	64	
Displaying Bearing/Range Between Any Two Waypoints	66	2
6 Programming Mode		
Entering Latitude/Longitude of a Waypoint	70	
Changing Entered Latitude/Longitude	72	3
Clearing Entered Latitude/Longitude.....	74	
Route Planning	76	
Creating a Route	78	
Selecting a Route	80	
Clearing a Route.....	82	4
7 Appendices		
Function Summary Chart.....	84	
Display Characters.....	86	
World Time Difference Table	88	5
Explanation of Terms.....	89	
World Datum List	95	
Conserving Battery Power	102	
Saving Latitude/Longitude.....	102	
Maintenance.....	103	6
Troubleshooting Guide.....	104	
Specifications	105	
Accessory Order Information	106	
Product Service.....	107	7

Precautions

Do not leave the GP-22 in the following places.

- In extremely dusty and humid environments.
(May cause the receiver to malfunction.)

- In areas subject to intense shocks and/or vibrations.
(May cause the receiver to malfunction.)

- In direct sunlight for long periods of time.
(May cause the receiver to malfunction and may damage the LCD or case.)
- Inside a parked car which is exposed to direct sunlight.
(May cause the receiver to malfunction and may damage the receiver.)
- In areas where the temperature is below -10°C (14°F) ; above 50°C (122°F).
- In severely cold places for long periods of time.
(May cause the receiver to malfunction and may affect the LCD.)

Handling Instructions

● Do not disassemble the receiver or battery charger. (May cause them to malfunction.)

● Do not cut the battery charger cord. (May cause an electric shock.)

● Do not drop or treat the receiver roughly. (May cause the receiver to malfunction.)

● Do not short-circuit the rechargeable battery. (May result in a fire hazard.)

● Do not immerse the receiver in water. (May cause the receiver to malfunction.)

Important Notice

This device is designed as an aid to navigation only.

The performance of this device can be affected by many factors, such as but not limited to, environmental conditions, improper handling, satellite signal availability, etc. It is the user's responsibility to follow good navigational practices and to utilize common sense at all times. Use of this device does not relieve the user of these responsibilities.

GPS Satellites

GPS is an abbreviation of Global Positioning System. GPS satellites orbit the earth at an altitude of 12,539 miles (20,180 km). These satellites are launched and maintained by the U.S. Department of Defense.

GPS is a system where receivers on land, sea, or in the air can receive signals from 3–4 satellites to calculate an accurate position (latitude, longitude and altitude).

Once all 24 of the satellites have been launched and configured in 6 orbits (each orbit having 4 satellites) the system will be fully implemented. Today, measurements may not be possible at all times as the system does not yet have all of the satellites in place. As of January 1993, 21 of the 24 satellites are in place and are in operation. The scheduled completion of the system is set for mid-1993.

Depending on the configuration and completion of the GPS Constellation, the accuracy of a position fix may vary. (Altitude differences may differ by as much as ± 0.1 mile; 150 m).

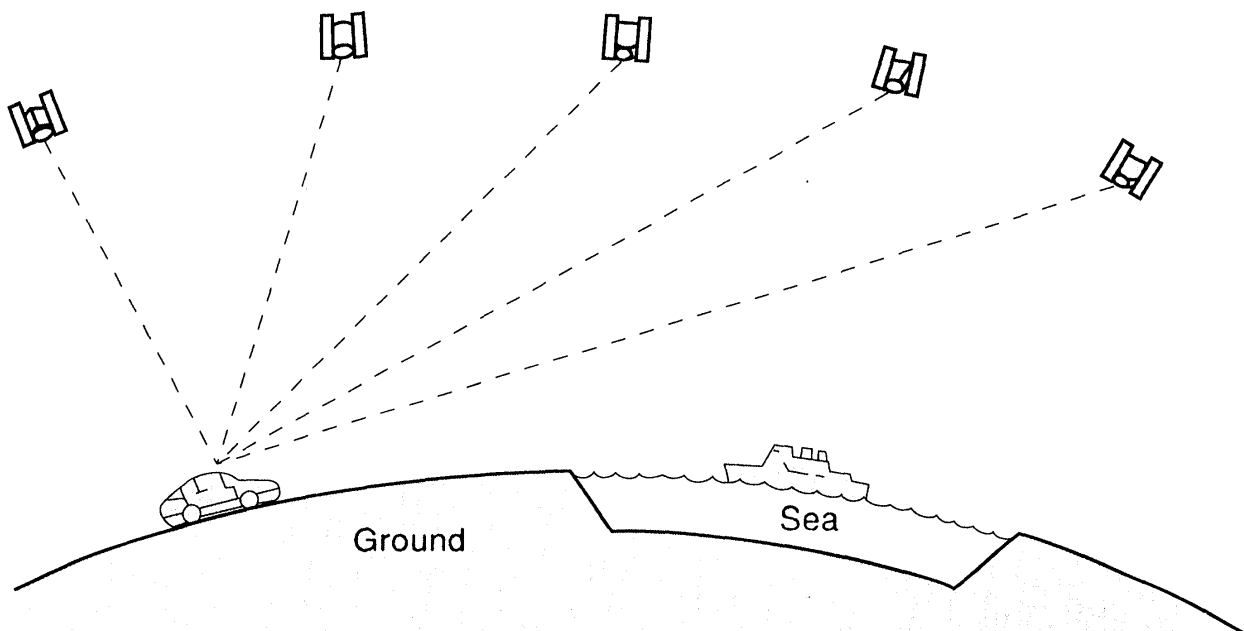

Measurement

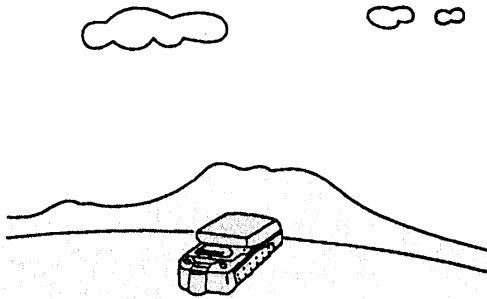

A good place for measurement

An open space where you have a clear view of the sky with no obstacles in the way. (Measurements CANNOT be taken indoors or where there are strong electric fields such as near a broadcasting antenna.)

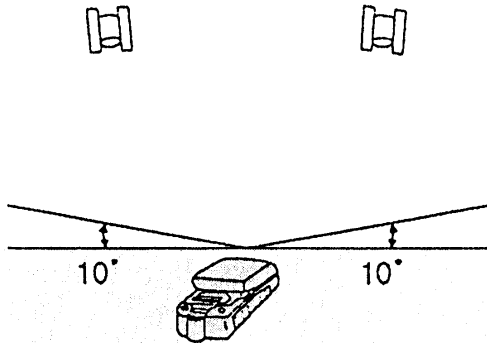

Antenna direction

Position the receiver so that the antenna is horizontal. Satellite signals above an angle of 10 degrees from horizontal can be received.

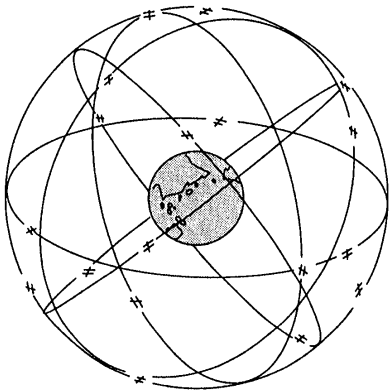

Notice of satellite availability

Each day there will be periods of time when acquiring a fix will be difficult or impossible. This time varies from day to day and from location to location due to the orbiting nature of the satellites. This condition will soon be corrected once all 24 of the GPS satellites have been launched and the system declared fully operational by the U.S. Department of Defense.

Location of Controls

Operation

Antenna —————
Receives the GPS signals from the satellites.

[POWER] Key —————
Turns the power ON and OFF.

Liquid Crystal Display —————

[SELECT] Key —————
Selects the display in the selected mode.

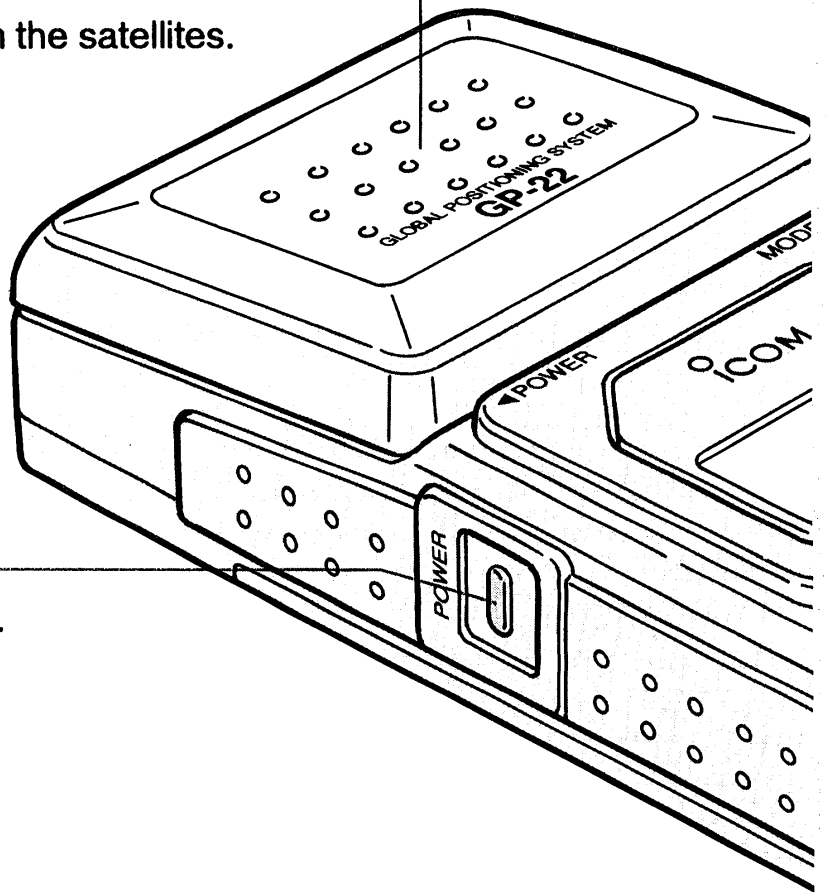

[MODE•SEL.] Key

Each press changes the operation mode as follows. (page 42)

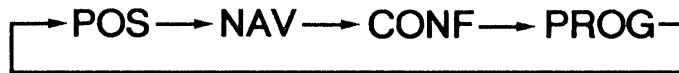
**[LIGHT/SET] Key**

Turns the LCD light ON and OFF. Also used to save a numerical value. (page 71)

[START/▲] Key

Starts calculation of your current position (page 45) or enters a numerical value of longitude/latitude. (page 70)

[MEMO/▶] Key

Enters the calculated data of latitude and longitude (page 48) or selects a field for a numerical value.

[W. Point] Key

Selects WP (waypoint) for storing latitude/longitude data.

Display Screen

Waypoint (WP) Number Display

Displays WP number which stores latitude/longitude.

MODE Indicator

“▲” indicates the selected operation mode.

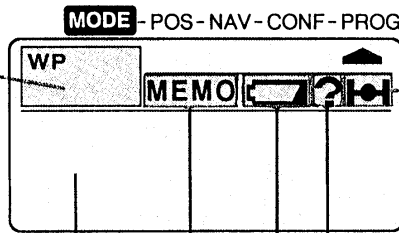
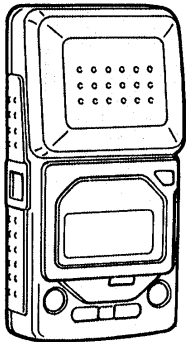

Satellite Indicator

Flashes while receiving or trying to receive signals from GPS satellites.

Low Accuracy Alarm Indicator

Appears when accuracy of calculated data is low.

Displays the calculated numerical value.

Low Battery Alarm Indicator

Flashes when the batteries are depleted.

Memory Indicator

Appears when calculated latitude/longitude are stored.

Installing the Rechargeable Battery

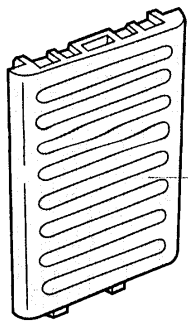

Rechargeable Battery

- Before use, charge the rechargeable battery using the supplied battery charger.
- With a complete charge, the GP-22 will function for approx. 80 minutes. (continuous use, screen light off, ambient temperature +20 °C; +68 °F).
- The rechargeable battery is made of Nickel Metal Hydride.

Charging the Rechargeable Battery

Charge the battery for approx. 10 hours at an ambient temperature of +10 °C to +35 °C (+50 °F to +95 °F).

To prevent overcharging, the battery charge indicator will go out after approx. 15 hours and charging will stop.

With AC Adaptor

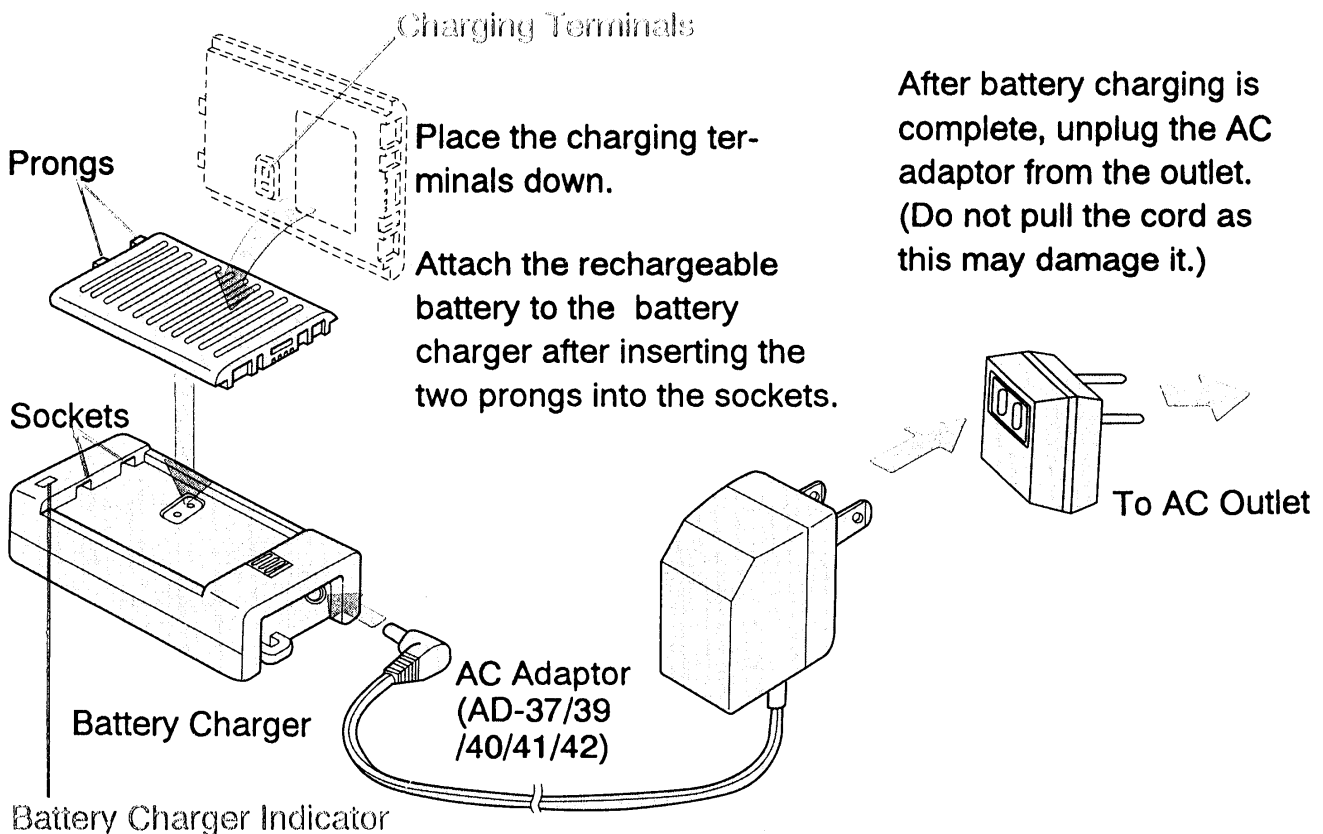

- Use the supplied AC adaptor.
- Using a different AC adaptor may damage the battery charger.

Installing the Rechargeable Battery (cont.)

1
Set Up

With Cigarette Lighter Cable

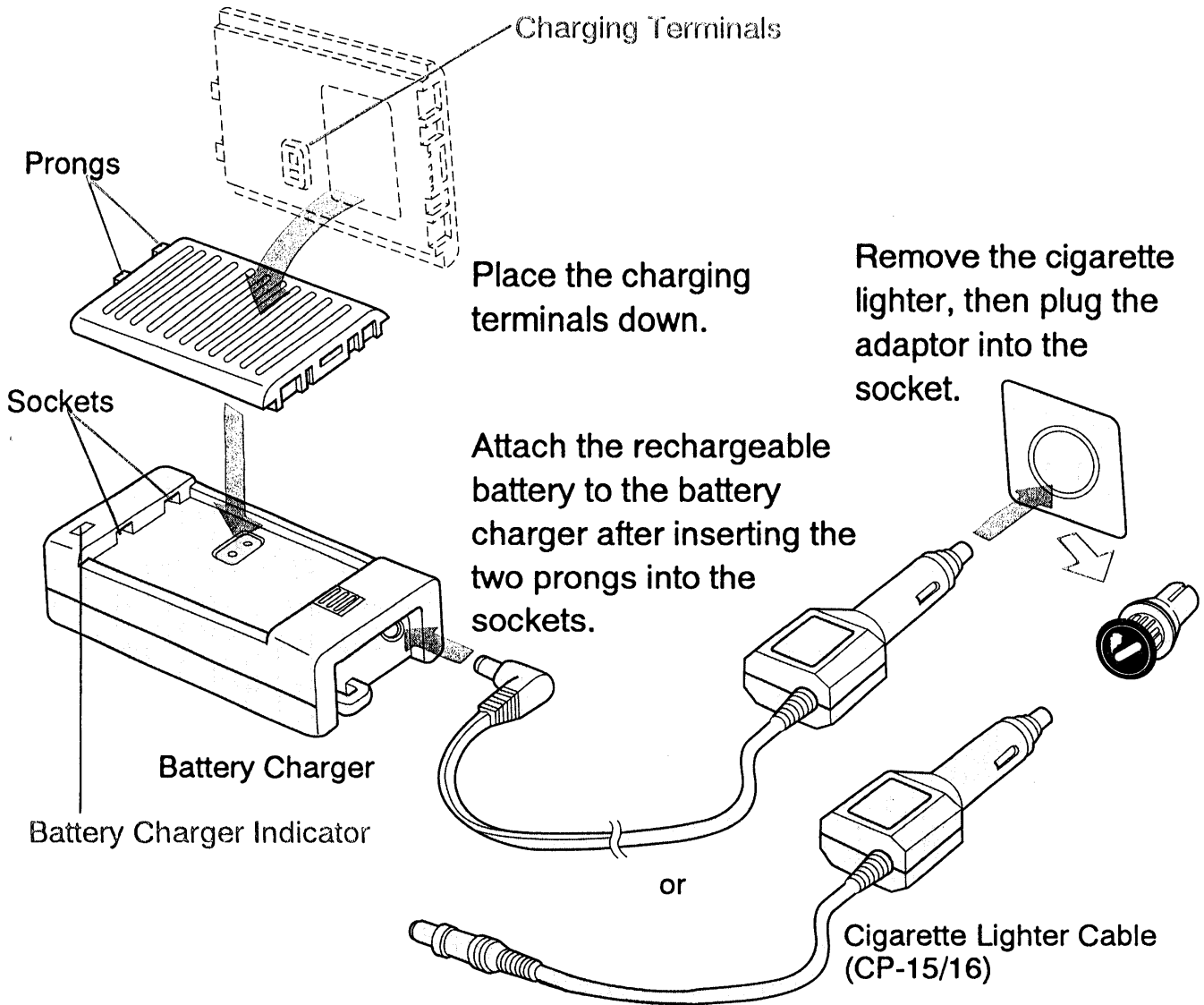

Charge with an external 13.8 V (11.7 to 16.6 V) DC power source.

Fuse Replacement

If the in-line fuse of the Cigarette Lighter Cable has blown, change it with a new one.

If it blows again, have your Cigarette Lighter Cable checked.

● To remove the fuse:

Push and hold clips (A); then turn end (B) as shown below.

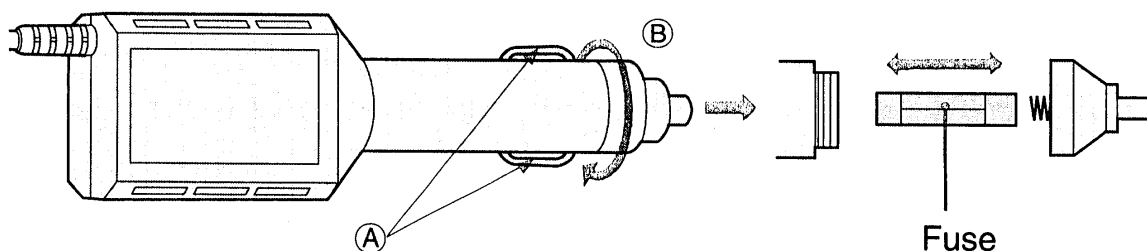

● To install the fuse:

Reverse the above procedure.

Use a 125 V, 2 A fuse.

Note:

- Remove the cable from the cigarette lighter socket when not in use.
- Because of the variety of cigarette lighter sockets on the market, this cable may not fit into some types of cigarette lighter sockets.

Remove Rechargeable Battery from Battery Charger

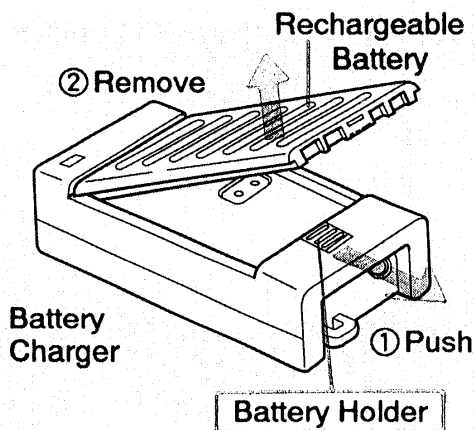

- 1 Release the rechargeable battery by pushing the battery holder in the direction of the arrow (1).
- 2 Remove the rechargeable battery from the battery charger (2).

Attach Rechargeable Battery to Receiver

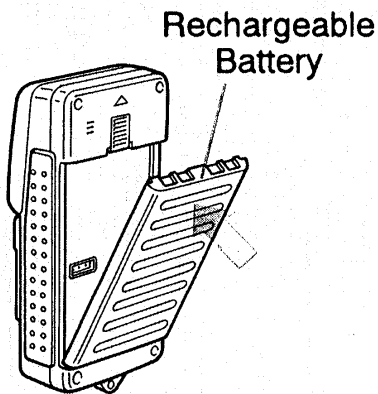

- 1 Place the rechargeable battery into the receiver.
- 2 Push the rechargeable battery until a click is heard.

Remove Rechargeable Battery from Receiver

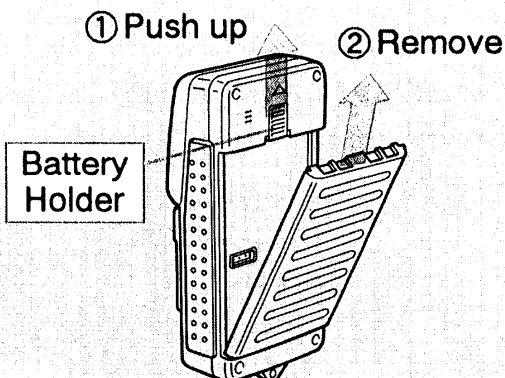

- 1 Push the battery holder UP to release the rechargeable battery.
- 2 Grasp the rechargeable battery and lift it from the receiver.

Installing Alkaline Batteries

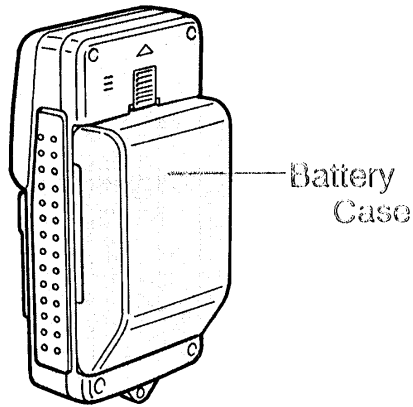

- The GP-22 will operate for approx. 5 hours using 5 AA alkaline batteries. (continuous use, display backlight off, ambient temperature +20 °C; +68 °F)
 - We recommend the use of alkaline batteries. (AA size, LR6, 1.5 V)
- The GP-22 will operate for approx. 2 hours using conventional manganese batteries. (continuous use, screen light off, ambient temperature +20 °C; +68 °F)

Installing Alkaline Batteries into the Battery Case

1

- Loosen the screw on the back side of the battery case.

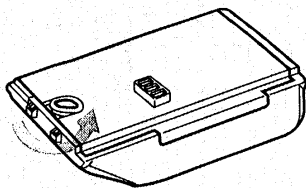

2

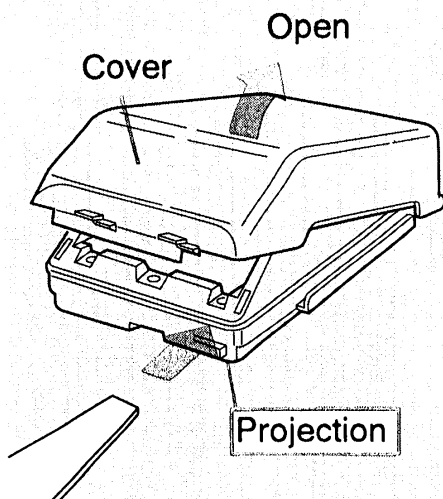

- 1 Open the cover of the battery case by gently prying at the projection with a flat object such as a screwdriver or nail file.
- 2 Lift the cover, as shown, to open.

Installing Alkaline Batteries (cont.)

1
Set Up

3

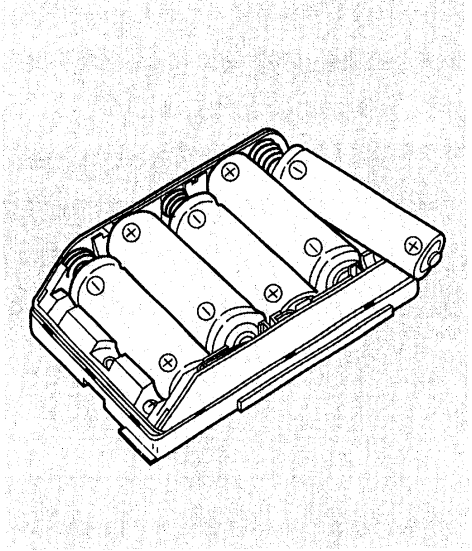

● Install the batteries, being sure to observe the correct polarity indication on the battery case.

4

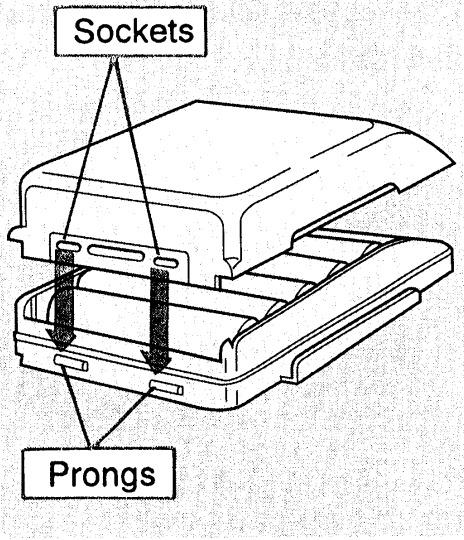

● Place the cover on the battery case by putting the prongs into the sockets.

5

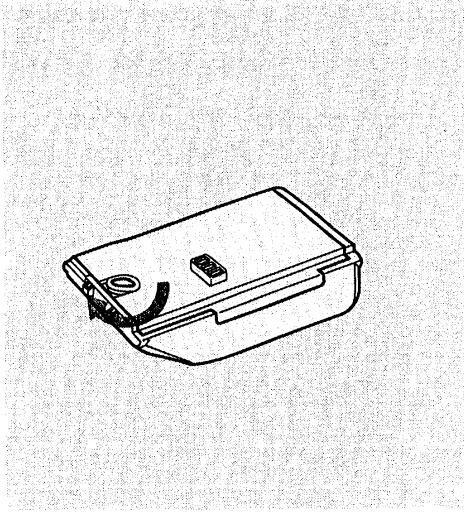

● Tighten the screw on the back side of the battery case.

Attach the Battery Case to the Receiver

1

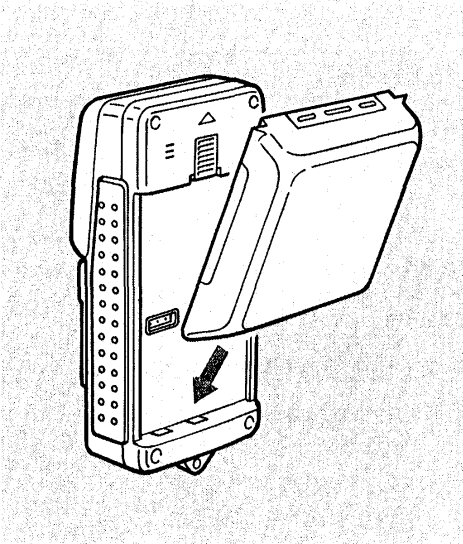

● Attach the battery case to the receiver.

2

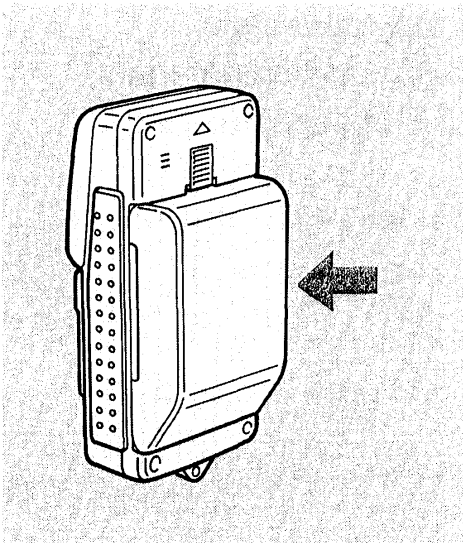

● Push the battery case until a click is heard.

1

Set Up

Instructions for Battery Use

1
Set Up

Rechargeable Battery

Charging the Battery

- Charge at an ambient temperature between +10 °C to +35 °C (+50 °F to +95 °F).
- Charge at least once every 6 months, even when not in use.
- If the battery is not used for a long period of time (more than 6 months), its life will be shortened.
- **Do not** charge a fully charged battery. This may cause overcharging and shorten the life of the battery.

Storage

- **Do not** leave batteries in locations subject to direct sunlight or near heat sources. This may cause an electric discharge (battery capacity will diminish naturally even when not in use) and shorten the battery life. Store in a cool, dry place.
- Remove the rechargeable battery from the receiver when it is not being used for long periods.

Handling Instructions

- **NEVER** perform the following:
 - Discarding the battery into a fire.
 - Opening the battery pack.
 - Short-circuiting the terminals.
 - Using a battery charger other than the supplied one.

Battery Life

- You can charge the NiMH battery repeatedly approx. 360 times. When the time between charges becomes extremely short even after fully charging (approx. 10 hours), replace it with a new one.

Alkaline Battery

Using alkaline batteries improperly may cause leakage or corrosion.

Please observe the rules listed below.

- **Do not** mix old batteries with new ones.
- **Do not** mix different types of batteries. Similar looking batteries may have different voltages.
- **Do not** short-circuit, disassemble, heat or discard batteries into a fire.
- Install batteries correctly as indicated.
- Remove batteries from the receiver when not in use for long periods of time.
- Remove and dispose of batteries when they are depleted.
- Thoroughly clean up any battery leakage that occurs.

Caution:

To reduce the risk of fire and/or personal injury, read and follow these instructions.

1. Use only recommended battery(ies).
2. **Do not** dispose of battery(ies) into a fire. This may cause an explosion. Check with local authorities for possible special disposal instructions.
3. **Do not** open or mutilate the battery(ies). Released electrolyte is corrosive and may cause damage to the eyes or skin. It may be toxic if swallowed.
4. Exercise care in handling batteries in order not to short them with conducting materials such as rings, bracelets and keys. The battery or conductor may overheat and cause burns.
5. **Do not** attempt to rejuvenate the battery(ies) by heating them. Sudden release of battery electrolyte may occur causing burns or irritation to eyes and skin.

Instructions for Battery Use (cont.)

1

Set Up

6. **Do not** attempt to charge the battery(ies). They may leak corrosive electrolyte or explode.
7. When replacing batteries, all batteries should be replaced at the same time. Mixing fresh and discharged batteries could increase internal cell pressure and rupture the discharged battery(ies).
8. When inserting batteries into the receiver, the proper polarity or direction must be observed. Incorrect insertion of batteries can cause charging, which may result in leakage or explosion.
9. Remove the batteries from the receiver when not in use for long periods of time (several months or more) since, during this time, the batteries could leak.
10. Discard "dead" batteries as soon as possible since "dead" batteries are more likely to leak.
11. **Do not** store the batteries in high-temperature areas. Batteries that are stored in a freezer or refrigerator for the purpose of extending shelf life should be protected from condensation during storage and defrosting. Batteries should be stabilized at room temperature prior to use after cold storage.

This equipment has been tested and found to comply with the limits for a class B digital device, pursuant to Part 15 of the FCC Rules. These limits are designed to provide reasonable protection against harmful interference in a residential installation. This equipment generates, uses, and can radiate radio frequency energy and, if not installed and used in accordance with the instructions, may cause harmful interference to radio communications. However, there is no guarantee that interference will not occur in a particular installation. If this equipment does cause harmful interference to radio or television reception, which can be determined by turning the equipment off and on, the user is encouraged to try to correct the interference by one or more of the following measures:

- Reorient or relocate the receiving antenna.
- Increase the separation between affected equipment and receiver.
- Consult your Icom dealer or an experienced radio/TV technician for help.

Pre-operation

GPS Receiver Setup

2

Pre-operation

1. Turning Power On
2. Adjusting Datum to Regional Standards
(Func 1)
3. Adjusting to Local Time (Func 2)
4. Programming Continuous or Single Calculation Mode (Func 3)
5. Changing Units:
 - 1) Latitude/Longitude
 - 2) Altitude
 - 3) Distance and Speed
6. Collecting an Almanac

Turning Power On

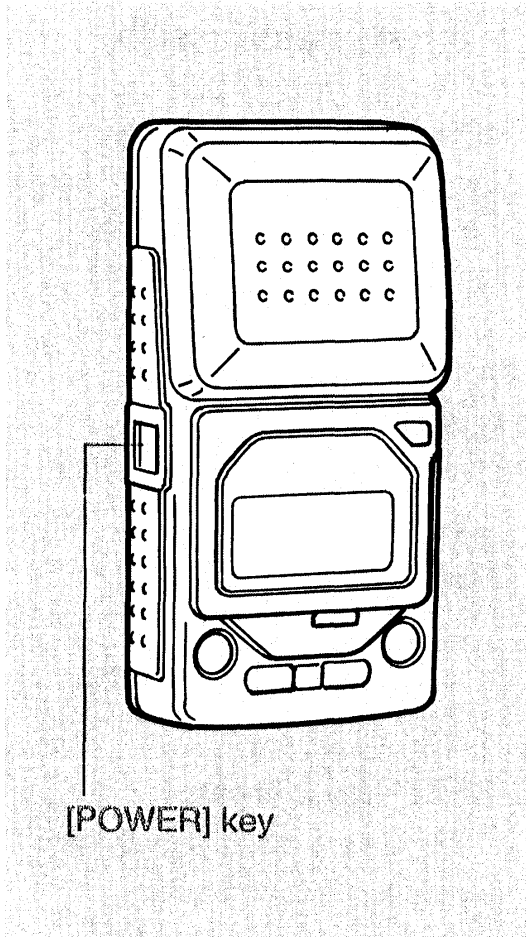

Press the [POWER] key to turn the receiver on.

- A long beep is heard and POS mode is accessed.

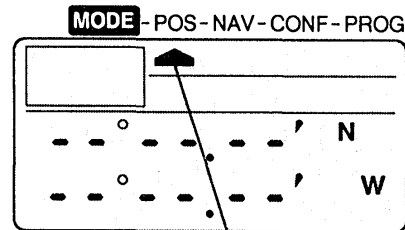

(Initial display)

Indicator

Press the [POWER] key to turn the receiver off.

- When you turn the power on after one calculation, the first display shown is in POS mode.

Using the display backlight

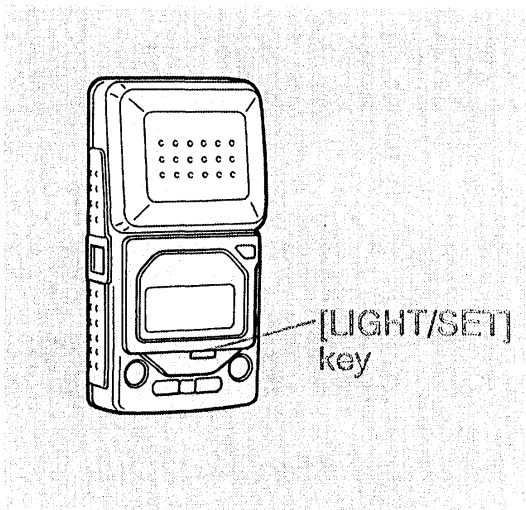

Pressing the [LIGHT/SET] key after pressing the [POWER] key turns the display backlight on. Pressing the [LIGHT/SET] key again turns the screen light off.

- When the backlight is on:
 - The rechargeable battery will last for approx. 65 minutes. (continuous use, at +20 °C ; +68 °F)
 - The alkaline batteries will last for approx. 220 minutes. (continuous use, at +20 °C ; +68 °F)

Adjusting Datum to Regional Standards

Sea charts or maps are drawn by different standards in every country. These standards are different from the standards used by the GPS satellites.

When using this unit in a particular country, the datum number for that specific region should be selected to get a more accurate numerical value.

Pre-operation

2

1

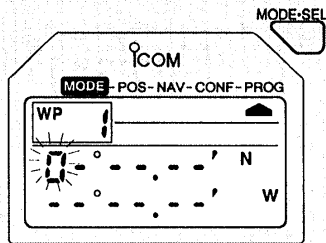

Press the [MODE•SEL.] key until the PROG mode is accessed.

- Each press advances the mode as follows.



2

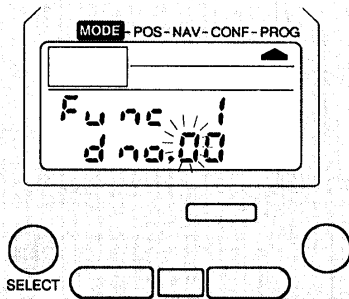

Press the [SELECT] key 4 times.

- "Func 1" (Func 1) is displayed and the ten digit of the datum number flashes.
- **d no.** (dno.) Datum Number (page 95)

[Default is 00 (WGS84)]

3

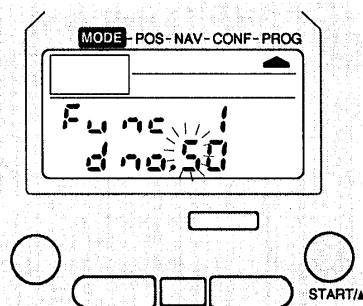

Press the [START/▲] key to select the ten digit.

- Each press advances the number as follows.

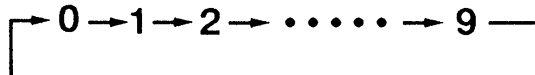

4

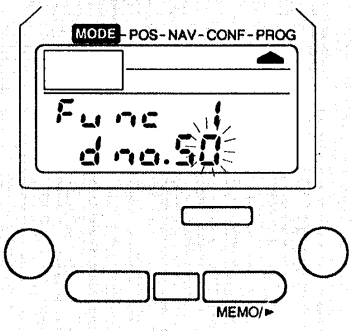

Press the [MEMO/▶] key.

- The ten digit stops flashing.
- The one digit of the datum number begins to flash.

5

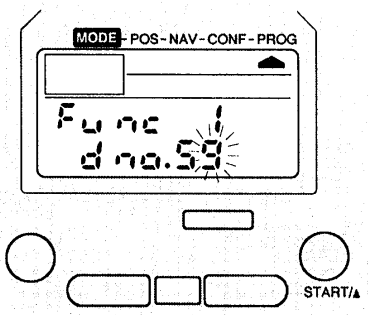

Press the [START/▲] key to select the number in the flashing field.

- Each press advances the number as follows.

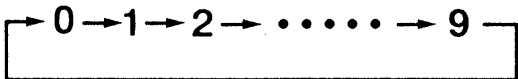

- Datum numbers are 00–93.

6

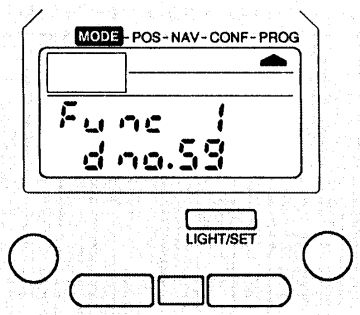

Press the [LIGHT/SET] key.

- Entry completion beep sounds.
- Flashing stops.

Note

● **Datum Number**

Refer to page 95 “World Datum List” for a datum number for a specific region. Please select your local datum number. 00 (WGS 84) is the default setting for the GP-22.

Adjusting to Local Time

Local time may be displayed by entering the time difference between UTC (Universal Time Coordinated), also known as GMT (Greenwich Mean Time), and local standard time.

Pre-operation 2

1

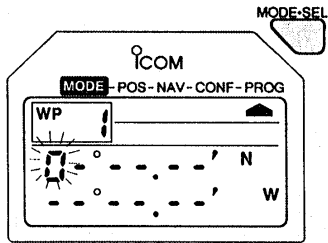

Press the [MODE•SEL.] key until the PROG mode is accessed.

2

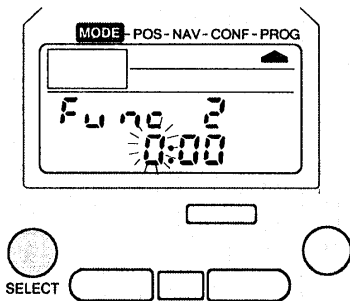

Press the [SELECT] key until "Func 2" (Func 2) is displayed.

- The number in the hours field flashes. (page 88)

3

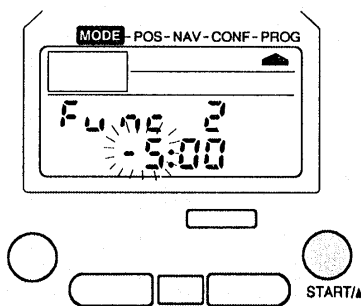

Press the [START/▲] key until the desired offset from UTC appears.

- Each press advances the number as follows.

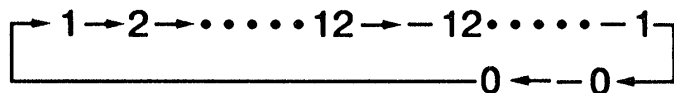

4

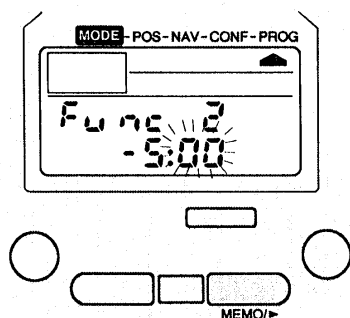

Press the [MEMO/▶] key.

- The number in the hours field is displayed and the number in the minutes field flashes.

5

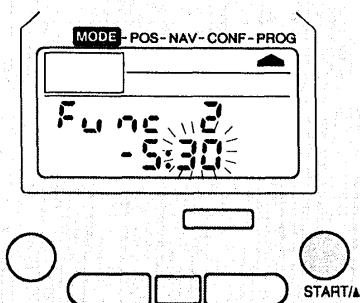

Press the [START/▲] key to select the number in the minutes field.

- Each press advances the number as follows.

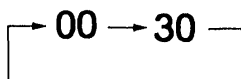

6

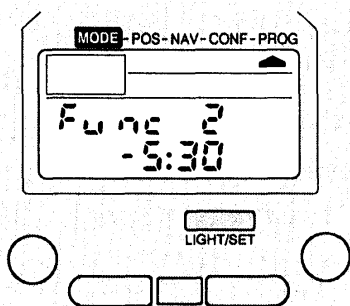

Press the [LIGHT/SET] key.

- Entry completion beep sounds.
- Flashing stops.

Note

- 0:00 (UTC) is the default setting.
Enter the time difference from UTC to the Local Time Zone.
- Refer to page 88 “World Time Difference Table” to get the time difference from UTC.

2

Pre-operation

Programming Continuous or Single Calculation Mode

Either Continuous or Single Calculation may be selected. The Single Calculation Mode affords greater battery life. When the single calculation mode is accessed, you have to press the [START] key each time you want the GP-22 to calculate. Continuous calculation is the default setting.

2
Pre-operation

1

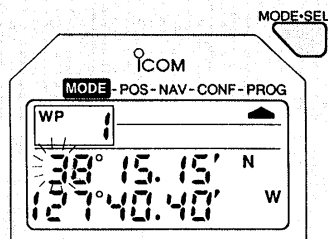

Press the [MODE-SEL.] key until the PROG mode is accessed.

2

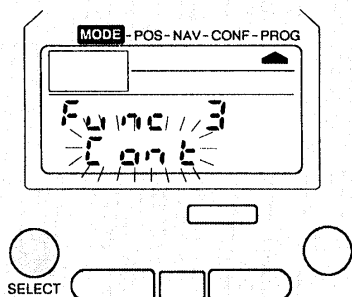

Press the [SELECT] key until "Func 3" (Func3) is displayed.

- The present setting flashes.
"Cont" (Cont): Continuous Calculation
"Once" (Once): Single Calculation

3

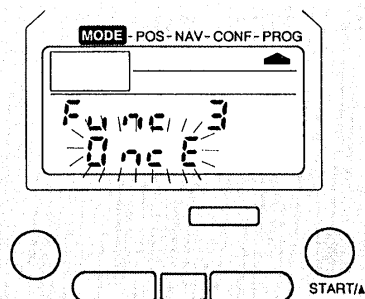

Press the [START/▲] key to select "Once."

- Toggles between "Cont" and "Once."

4

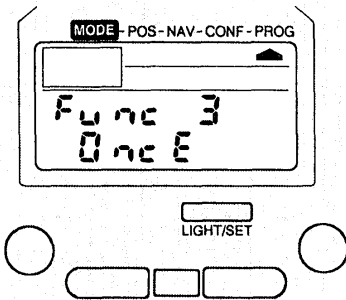

Press the [LIGHT/SET] key.

- Entry completion beep sounds. Flashing stops.

2

Pre-operation

Note

● **Continuous Calculation**

Once a calculation is started by pressing the [START] key, the result of the calculation is automatically displayed approx. every 3 seconds, and the data is updated with the latest calculation.

● **Single Calculation**

Press the [START] key every time you want a calculation. The power is automatically turned off when no key is pressed for two minutes after a calculation is displayed.

- COG, SOG, ETA and ETE are not activated when using this unit in "Single Calculation."

Changing Units of Latitude/Longitude

The units of latitude and longitude can be changed.

“ ° . ’ ” (Degrees, Minutes, Hundredths of Minutes)

“ ° ’ ” (Degrees, Minutes, Seconds)

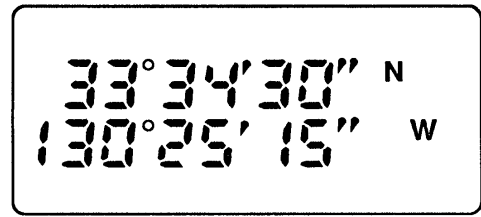
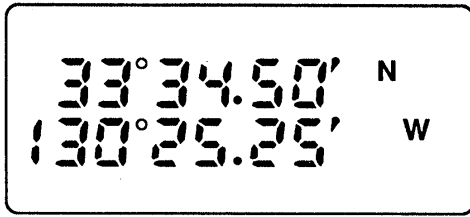

Pre-operation

1

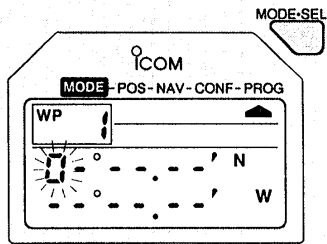

Press the [MODE•SEL.] key until the PROG mode is accessed.

2

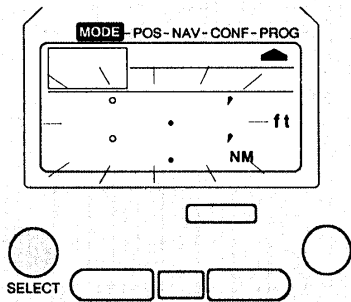

Press the [SELECT] key until the display at the left appears.

- The latitude and longitude unit figures which are currently selected flash.
- Distance units may differ from those shown here. (ft, NM)

3

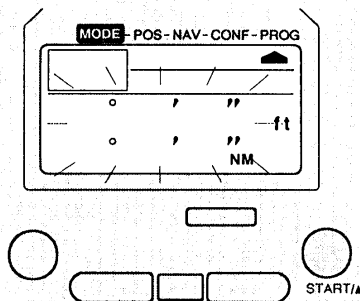

Press the [START/▲] key to toggle the units of latitude and longitude.

4

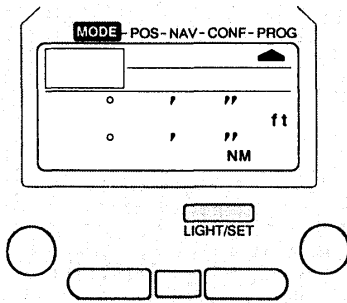

Press the [LIGHT/SET] key.

- Entry completion beep sounds.
- Flashing stops.

Note

● **When you change units:**

The result of the calculation for latitude and longitude entered in a Waypoint is automatically displayed in the new units.

● **To discontinue this operation:**

Press the [MODE•SEL.] key to access the POS mode.

Changing Units of Altitude

You can select "m" (meters) or "ft" (feet) as the units of altitude.

Pre-operation

1

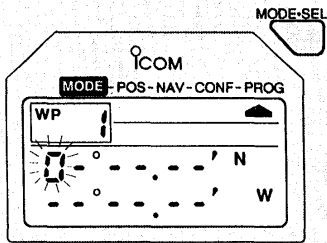

Press the [MODE•SEL.] key until the PROG mode is accessed.

2

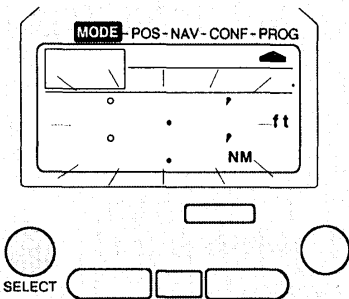

Press the [SELECT] key until the display at the left appears.

- The latitude and longitude figures which are currently selected flash.

3

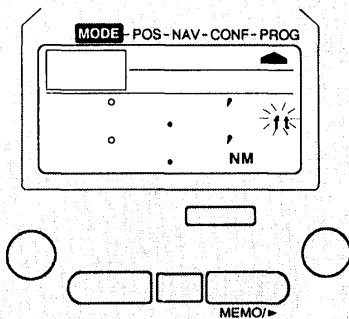

Press the [MEMO/▶] key.

- The altitude unit (ft or m) which is currently selected flashes.

4

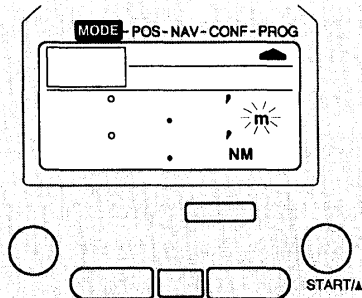

Press the [START/▲] key to toggle the unit between feet (ft) and meters (m).

5

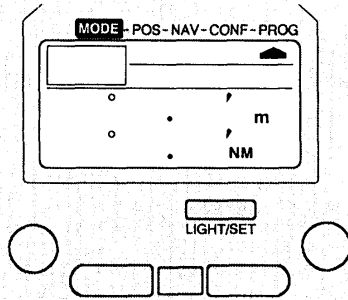

Press the [LIGHT/SET] key.

- Entry completion beep sounds. Flashing stops.

2

Pre-operation

Note

● **When you change units:**

The result of the calculation is automatically changed and displayed in the new units.

● **To discontinue this operation:**

Press the [MODE•SEL.] key to access the POS mode.

Changing Units of Distance and Speed

You can select “km” (kilometers) or “NM” (Nautical Miles) or “M” (Miles) as the units of distance and speed.

1

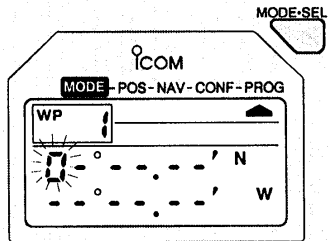

Press the [MODE•SEL.] key until the PROG mode is accessed.

2

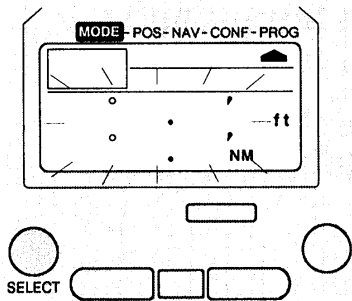

Press the [SELECT] key until the display at the left appears.

- The latitude and longitude figures which are currently selected flash.

3

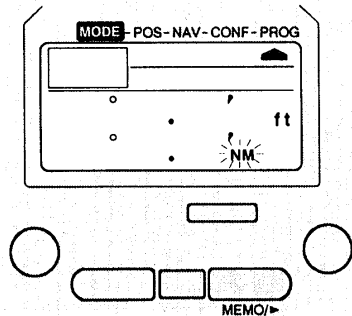

Press the [MEMO/▶] key twice.

- The distance and speed figures which are currently selected flash.

4

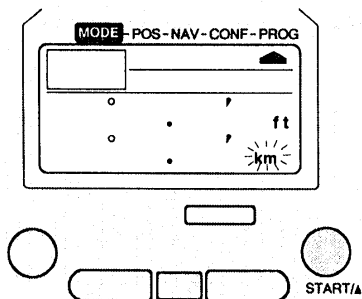

Press the [START/▲] key to change the units for distance and speed.

- Each press changes the units as follows.

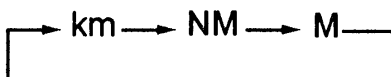

5

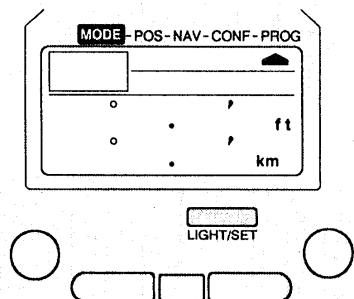

Press the [LIGHT/SET] key.

- Entry completion beep sounds.
- Flashing stops.

Note

● **When you change units:**

A distance to the destination or a speed is automatically changed and displayed in the new units.

● **To discontinue this operation:**

Press the [MODE•SEL.] key to access the POS mode.

2

Pre-operation

Collecting an Almanac

The time needed for calculation of a current position will be reduced to about 1–3 minutes from 10 minutes after Almanac information is stored. The Almanac data is automatically updated with the latest data every time a calculation is made. GPS receivers store satellite locations and information about the GPS constellation. This data is updated periodically by the satellites. You should occasionally collect an updated almanac using the following method.

2

Pre-operation

1

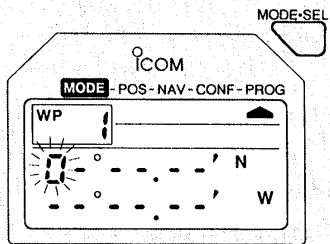

Press the [MODE•SEL.] key until the PROG mode is accessed.

2

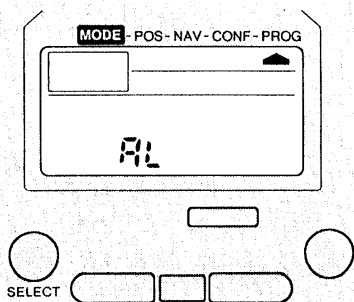

Press the [SELECT] key until the display at the left appears.

- “AL” (AL) is displayed.

The receiver must be out-of-doors and in an open space, clear of obstructions.

3

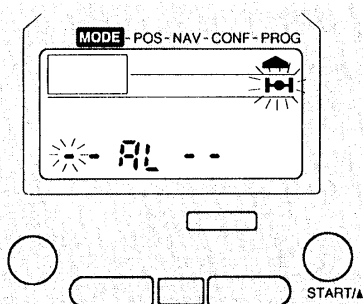

Press the [START/▲] key.

- “Almanac Receiving” starts and the satellite indicator flashes.
- The flashing “—” moves to the right side of the display as the receiver stores Almanac data.

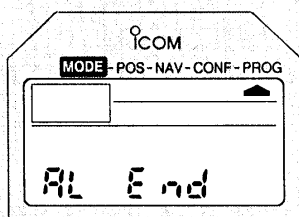

Almanac Receiving is completed in about 15 minutes.

- A completion beep sounds.

Important

- When Almanac Receiving is not completed after 20 minutes or when an error message is displayed, try to receive an Almanac at a different location and time.

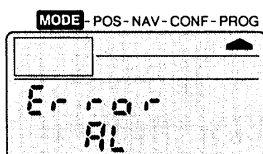

Note

- **With continued use of the GP-22:**
An Almanac of GPS satellites is automatically updated with the latest data.
- **When not using the GP-22 for periods of 6 months or more:**
It is necessary to collect an updated Almanac.

The Four Function Modes

Position (POS) Mode

1. Date and Time
2. Calculating Current Position
3. Determining Altitude
4. Waypoints and Latitude/Longitude
5. Entering Current Position into a Waypoint
6. Bearing and Range

Navigation (NAV) Mode

1. Bearing and Range to a Waypoint
2. Heading and Speed
3. Cross Track Error
4. Estimated Time of Arrival/Enroute
5. Using Waypoint Zero (WP 0)

Confirmation (CONF) Mode

1. Confirming an Entered Waypoint's Latitude/Longitude
2. Confirming Waypoint Numbers Entered in a Route
3. Displaying Bearing and Range Between Any Two Waypoints

Programming (PROG) Mode

1. Entering Latitude/Longitude of a Waypoint
2. Changing Entered Latitude/Longitude
3. Clearing Entered Latitude/Longitude
4. Route Planning
5. Creating a Route
6. Selecting a Route
7. Clearing a Route

Position (POS) Mode

1. Date and Time
2. Calculating Current Position
3. Determining Altitude
4. Waypoints and Latitude/Longitude
5. Entering Current Position into a Waypoint
6. Bearing and Range

Displaying Date and Time

The internal clock in the GP-22 is updated to present UTC after calculation of a position. Signals received from the GPS satellites provide UTC time and date information.

1

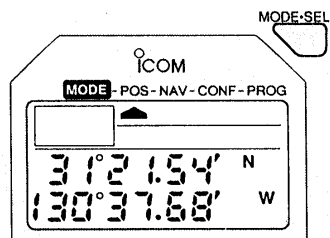

Press the [MODE•SEL.] key until the POS mode is accessed.

3

2

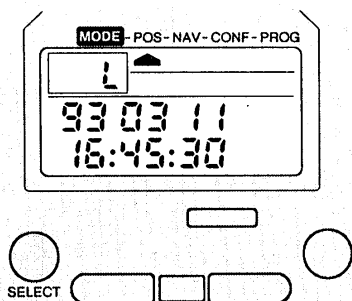

Press the [SELECT] key until the present date and time appears.

Important

● Date/Time Display

An accurate time is automatically displayed when the first calculation is done after purchasing the GP-22.

- "L" Local Time
- "U" UTC

Calculating Current Position

Your present latitude, longitude and altitude can be calculated.

1

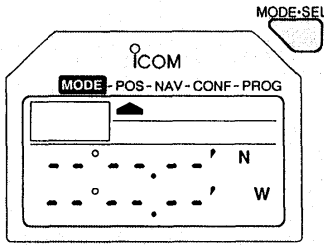

Press the [MOD-SEL.] key until the POS mode is accessed.

- “▲” is displayed under the characters “POS.”
- When the letters (N or S, W or E) are not displayed in the right side of the display, press the [SELECT] key until they are.

2

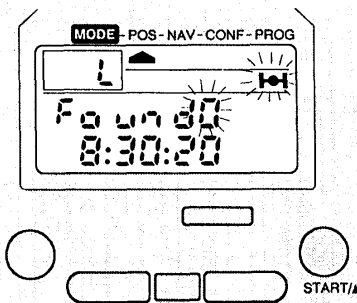

Press the [START/▲] key.

- The GPS receiver starts to acquire signals from satellites. “▲” and “0” flash and “Found” lights. The number next to “Found” indicates the number of received satellites.
- The current time is displayed. “L” is displayed when using local time, “U” is displayed in the upper left side of the display when using UTC.

3

Position

“1” flashes when the signals from the first satellite are received.

- Each time signals from a new satellite are received, the number of satellites is increased by 1.
- The new number flashes.

When enough satellites (usually 4) for a position fix are received, the present latitude and longitude are displayed.

- The calculation completion beep sounds twice.
- N ... North Latitude S ... South Latitude
 W ... West Longitude E ... East Longitude

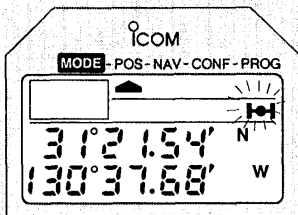
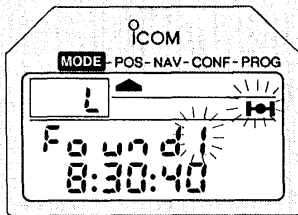

Determining Altitude

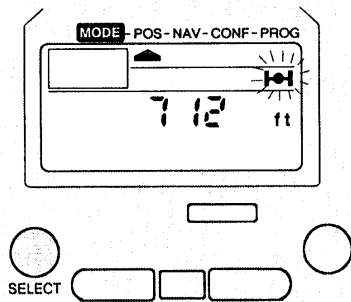

While the present latitude and longitude are displayed (page 45), press the [SELECT] key.

- The present altitude is displayed.
ft feet m meters
- While the present altitude is displayed:
 - Pressing the [SELECT] key twice returns you to date and time.
 - Pressing the [SELECT] key 3 times returns you to latitude and longitude.

Important

● Displaying outcome of calculation

You can display altitude after acquisition of 4 satellites. However, it is possible to determine a latitude/longitude fix from only 3.

● Displaying the present time

The GPS receiver's internal clock is automatically synchronized with the atomic clock aboard the satellite upon acquisition of the first position fix. It is re-synchronized upon subsequent fixes.

Note

● Calculating time

The GP-22 is programmed to finish calculation in about 10 minutes when no Almanac has been collected. Whenever a measurement is done, Almanac information from the GPS satellites is acquired. When the Almanac is complete, the calculating time will be reduced to 1 to 3 minutes. However, it may take longer depending on the satellites' constellation or other circumstances. We recommend that you collect an Almanac to shorten calculating times when the receiver is not used frequently. (page 40)

Waypoints and Latitude/Longitude

The GP-22 has the ability to store up to 99 Waypoints (destination or intermediate points on a route).

Each Waypoint is assigned its own number (1–99) for easy recall.

A destination Waypoint must be entered to calculate the navigation functions described in this section.

Entering

Enter the calculated latitude and longitude in PROG mode. (page 48)

Enter the destination latitude/longitude coordinates from a map or a chart. (page 70)

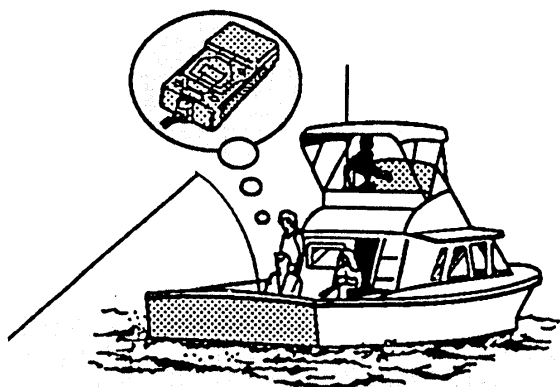

You can save the coordinates of a good fishing spot, etc.

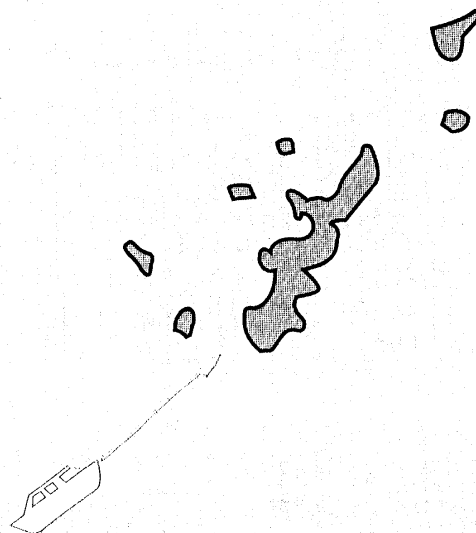

3

Position

Entering Current Position into a Waypoint

Once you enter the calculated latitude/longitude, you can check the position on a chart. The calculated latitude/longitude is saved in a WP number (1–99).

1

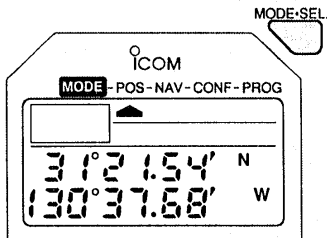

Press the [MODE•SEL.] key until the POS mode is accessed.

2

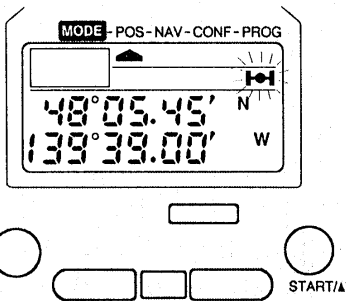

Press the [START/▲] key to calculate your current position (latitude/longitude).

- After calculation, a completion beep sounds twice and your current latitude and longitude are displayed.

3

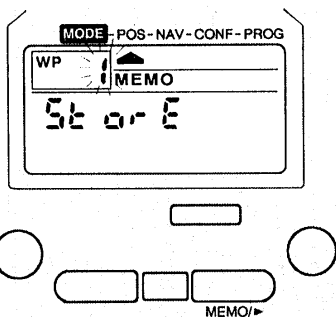

Press the [MEMO/▶] key while latitude and longitude are displayed.

- “Store” and “MEMO” light and the WP number flashes.

Important

- You can only store the calculated latitude/longitude when you press the [MEMO/▶] key while latitude and longitude are displayed.
- Altitude cannot be stored.

3

Position

4

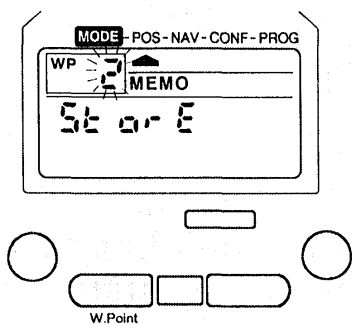

Press the [W.Point] key to select the WP number where latitude and longitude coordinates are to be stored.

- By pressing the [W.Point] key, the number advances as follows.

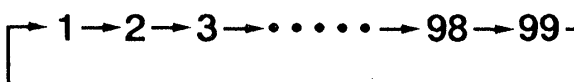

- Continue pressing [W.Point] to step through the WP numbers automatically.

5

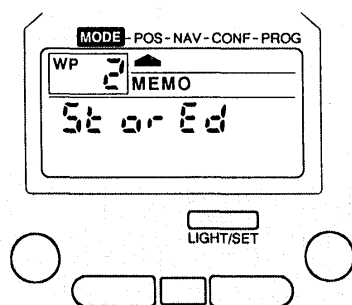

Press the [LIGHT/SET] key.

- Entry completion beep sounds once, and the WP number is entered.
- About 2 seconds later, the display returns to the entered latitude and longitude.

Important

- **When “Full” is displayed:**
All WP numbers have been used. Clear any unnecessary WP number(s) and enter again. (page 74)

Note

- **Displaying empty WP number(s)**
By pressing the [MEMO/▶] and then the [W.Point] key, the empty WP number(s) are displayed.

Bearing and Range to a Destination

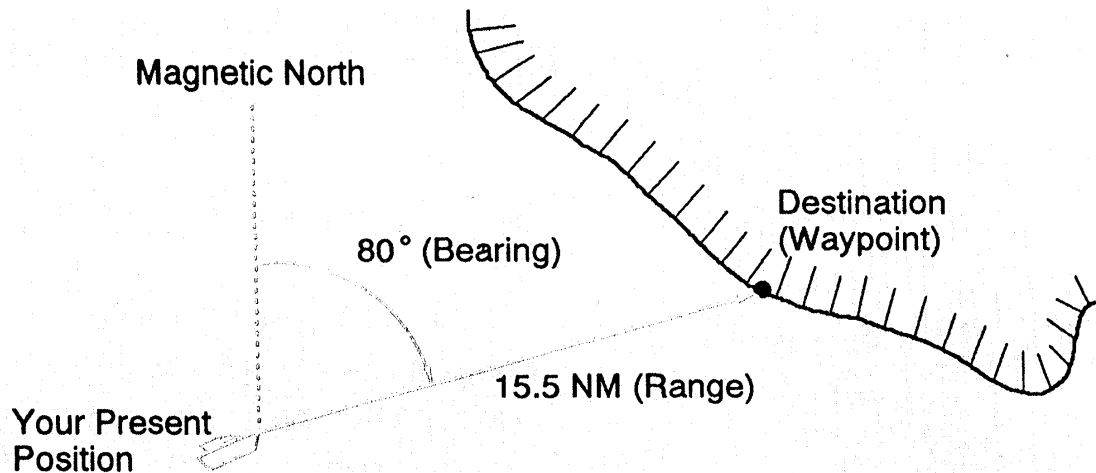

Once a Waypoint has been entered as a destination, all the navigation functions are available and can be accessed.

Bearing and Range to a destination is shown below as an example.

3

Position

Bearing/Range to a Destination

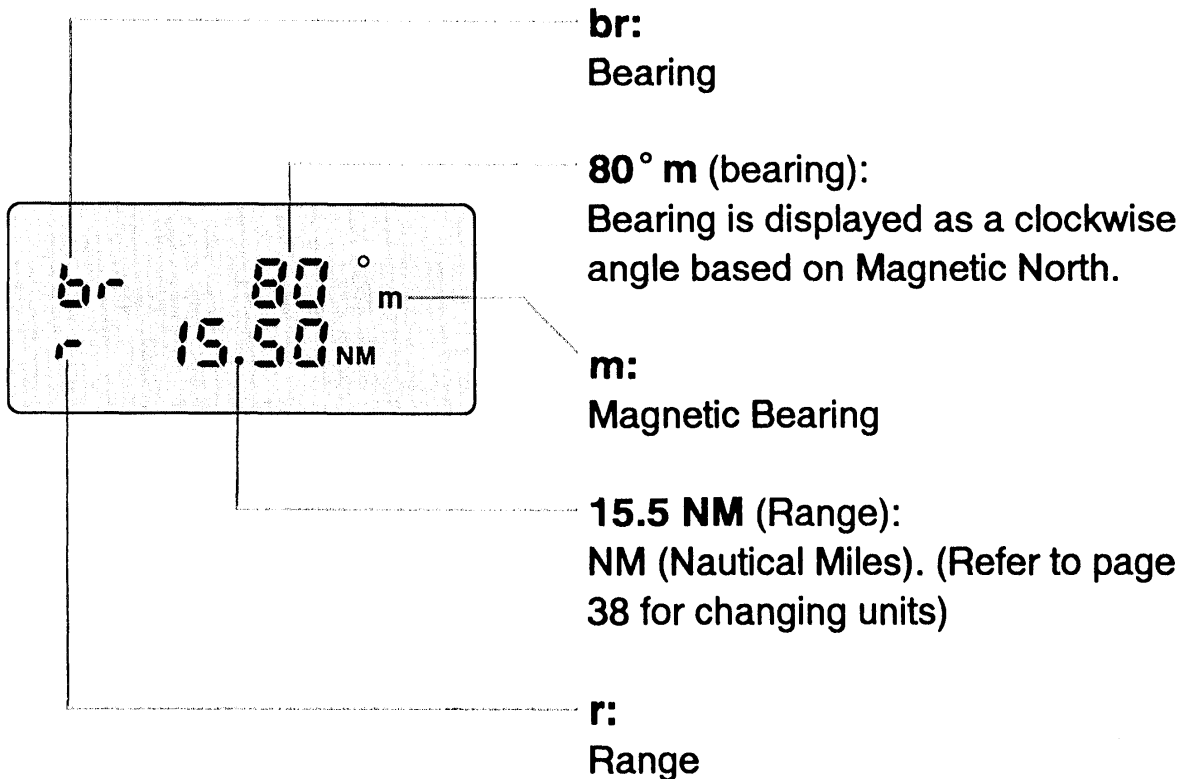

Displaying Bearing/Range to a Destination

The bearing and range from your present position to your destination (the position you saved in the WP) is displayed. You can advance to your destination while confirming the bearing.

1 Press the [MODE•SEL.] key until the POS mode is accessed.

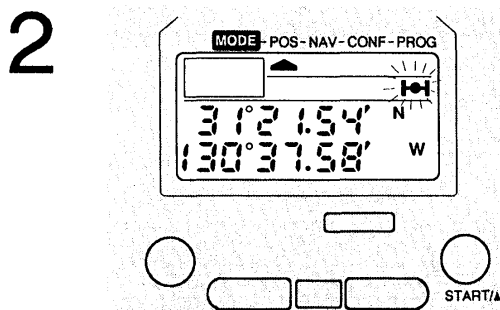

Press the [START/▲] key to calculate your present position.

- When calculation is complete, the calculation completion beep sounds twice.
- The latitude and longitude of your current position are displayed.

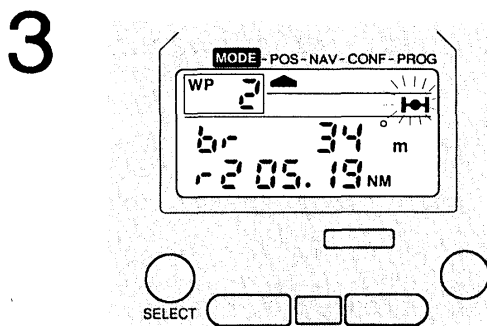

Press the [SELECT] key twice while latitude and longitude are displayed.

- The entered WP number and the bearing and range to that point are displayed.
- “br” Bearing
“r” Range
“m” Magnetic Bearing

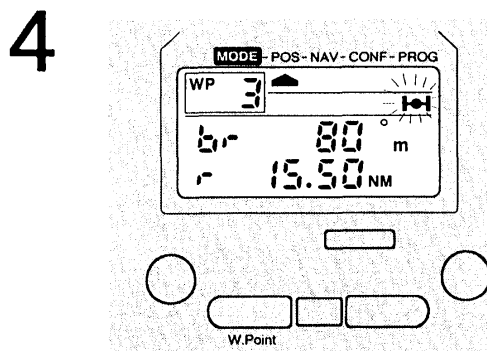

Press the [W.Point] key to select the desired WP number.

- Each press changes the WP number.
- The bearing and range to each point are displayed.
- Empty WP numbers are not displayed.

3

Position

Navigation (NAV) Mode

You can navigate by selecting one route from among any entered routes. See page 80.

1. Bearing and Range to a Waypoint
2. Heading and Speed
3. Cross Track Error
4. Estimated Time of Arrival/Enroute
5. Using Waypoint Zero (WP 0)

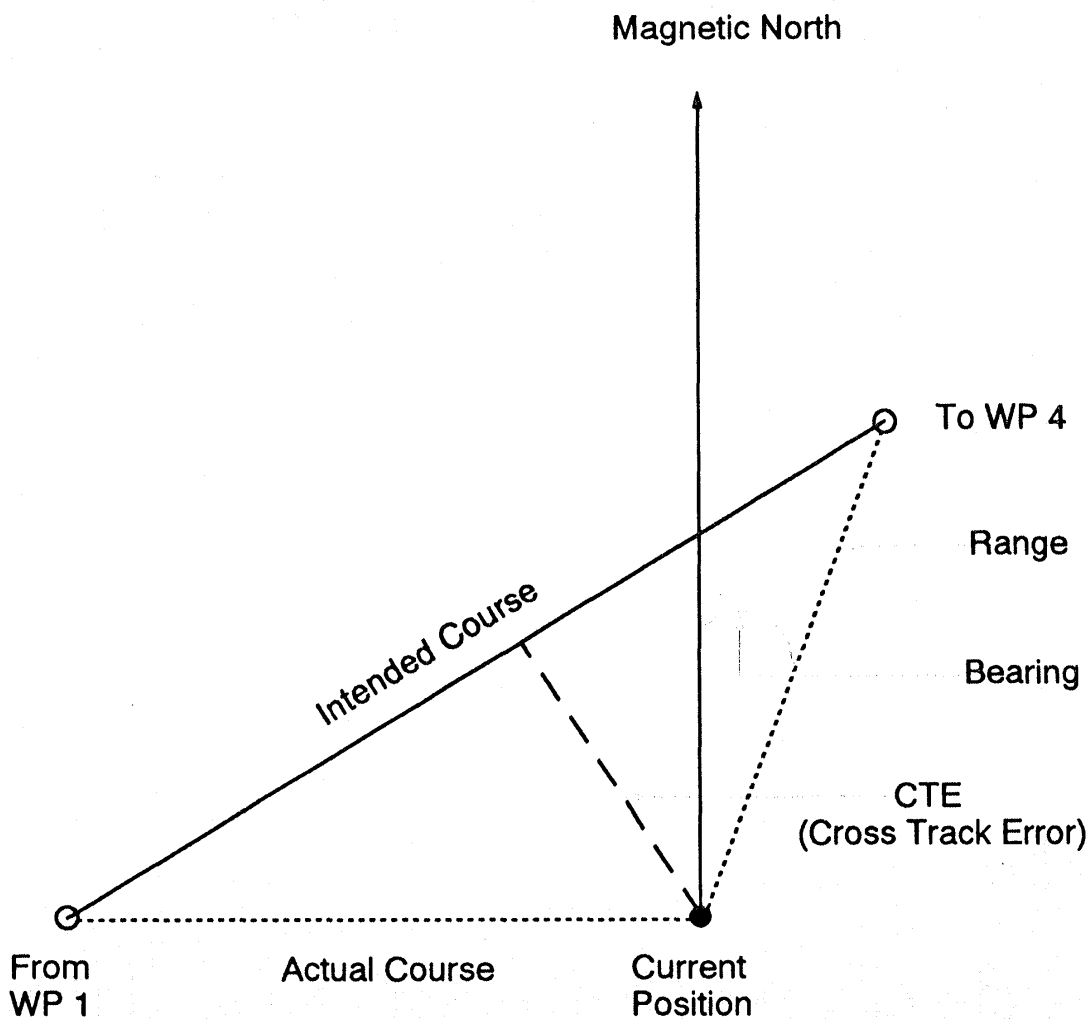

Displaying Bearing and Range to a Waypoint

The bearing and range to a Waypoint from your present position can be confirmed.

1 Press the [MODE•SEL.] key until the NAV mode is accessed.

2

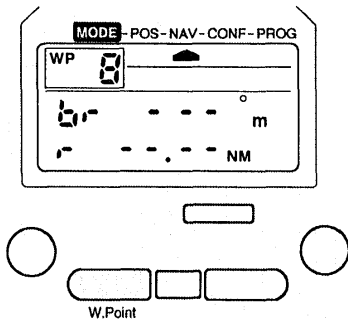

Press the [W.Point] key to select the WP number assigned to the desired destination.

- WP numbers in the selected route can be selected.

3

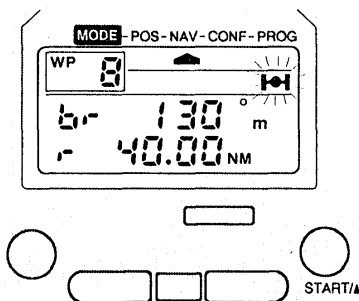

Press the [START/▲] key when the satellite indicator is not flashing.

- The bearing and range to the position of the WP number you selected are displayed.

Note

- The WP number which appears first is the one which was displayed on the previous display screen.
- If you press the [W.Point] key while the WP number assigned to the last point is displayed, the WP number assigned to the first Waypoint is displayed.
- In the NAV mode only, pressing the [SELECT] key displays "COG/SOG," "Cross Track Error," "ETA" and "ETE," sequentially.

4

Navigation

Displaying Heading/Speed

Heading (COG)/Speed (SOG) cannot be displayed while in Single Calculation. Set the receiver to Continuous Calculation. (page 32)

1

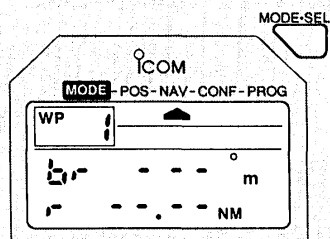

Press the [MODE•SEL.] key until the NAV mode is accessed.

2

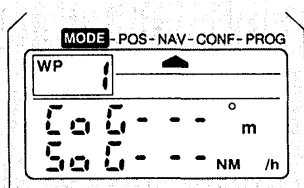

Press the [SELECT] key.

- COG and SOG are displayed.
COG (Course Over Ground) ... Heading
SOG (Speed Over Ground) ... Speed

4



3

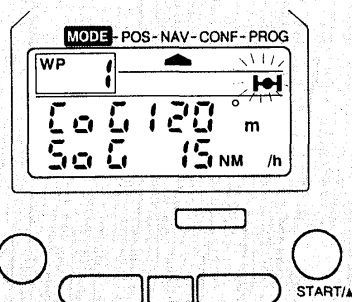

Press the [START/▲] key when the satellite indicator is not flashing.

- The current COG and SOG are displayed.
- NM/h Nautical miles per hour (knots)
M/h Miles per hour
km/h Kilometers per hour

Note

- When changing the units of distance (page 38), the SOG units are automatically changed and displayed.
- As your speed increases, a more accurate figure for COG and SOG are displayed.
- Because of Continuous Calculation, the displayed SOG might not be 0 even when you are stationary.

Navigation

Displaying Cross Track Error

The deviation (error) from the current position to the route which connects two Waypoints is displayed.

Display Screen

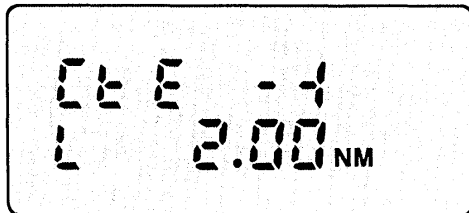

CTE (CTE) Cross Track Error

R (Right) Your current position has deviated to the RIGHT from the intended course.

L "**L**" indicates that you have to change direction to the left.

L (Left) Your current position has deviated to the LEFT from the intended course.

R "**R**" indicates that you have to change direction to the right.

Displaying Cross Track Error (cont.)

1

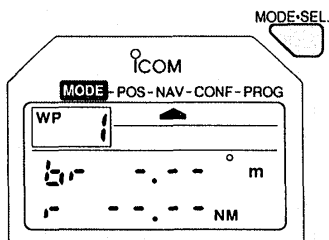

Press the [MODE•SEL.] key until the NAV mode is accessed.

2

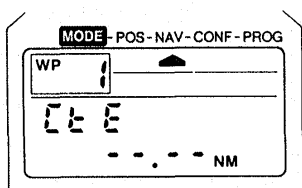

Press the [SELECT] key twice.

- CTE (CTE) Cross Track Error

4



3

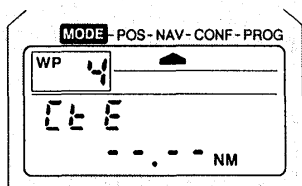

Press the [W.Point] key to select the desired WP number.

- WP numbers in the selected route can be selected (page 80).

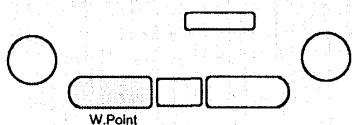

Navigation

4

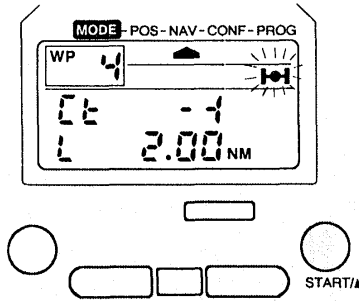

Press the [START/▲] key when the satellite indicator is not flashing.

- The deviation from the intended course is displayed.
- **r** (r) Change direction to the left.
- **L** (L) Change direction to the right.
- Up to 99.99 (km, M, NM) can be displayed.

Important

- Cross Track Error is not be displayed when moving to the first Waypoint in a route.

Displaying Estimated Time of Arrival/Enroute

You can confirm the estimated time of arrival/enroute to the next Waypoint when you are moving to your destination at a specified speed. ETA and ETE are displayed only when using the receiver in Continuous Calculation.

1 Press the [MODE•SEL.] key until the NAV mode is accessed.

2

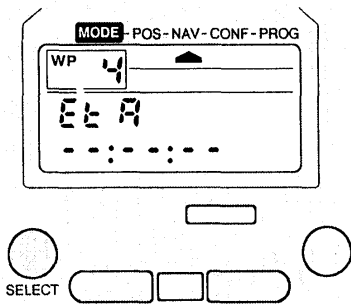

Press the [SELECT] key 3 times.

- "ETA" is displayed.
- ETA means Estimated Time of Arrival.

4

3

Press the W.Point key to select the desired WP number, if necessary.

- WP numbers in the selected route can be selected.

4

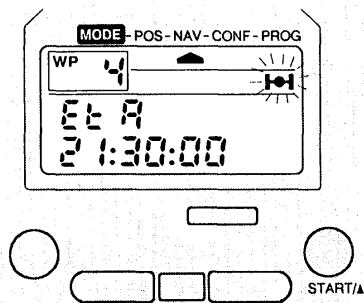

Press the [START/▲] key when the satellite indicator is not flashing.

- ETA to the desired Waypoint is displayed.

Navigation

5

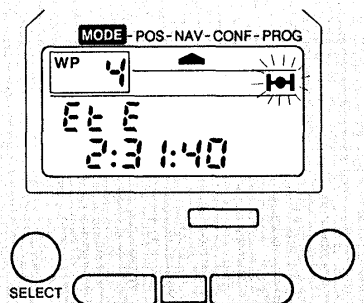

Press the [SELECT] key while the ETA is displayed.

- "ETE" is displayed.
- ETE means Estimated Time Enroute.

Note

● ETA Display

A time from the present to 23 hours 59 minutes later is displayed as ETA. “--:--:--” is displayed when the time is over 24 hours and, in the following three cases.

1. Calculation of a current position is impossible.
2. Single Calculation is selected.
3. Moving backward along your route.

● ETE Display

A time of up to 99 hours 59 minutes and 59 seconds is displayed as ETE. “99:59:59” is displayed when the time is over 100 hours. “--:--:--” is displayed in the above 3 cases (1. to 3.).

● Arrival Confirmation Tone

When you come within a radius of 0.1 NM of your destination, the arrival confirmation tone sounds 8 times.

Also, when you pass a straight line which makes a right angle with the route, an arrival confirmation tone sounds.

The straight line which makes a right angle with a route.

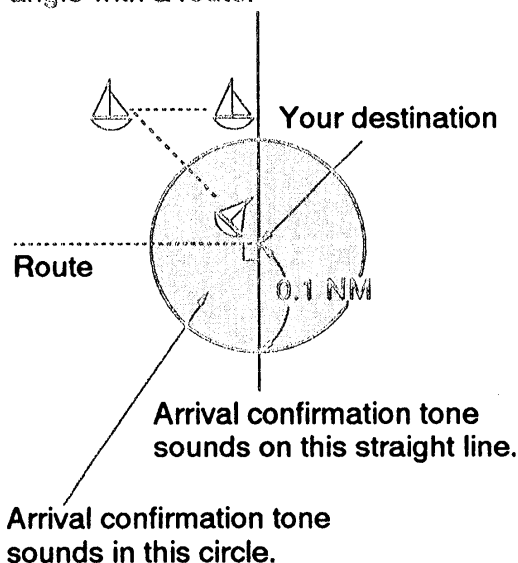

After an arrival confirmation tone sounds, the receiver is automatically set for the next Waypoint. (Manual setting is required when in Single Calculation mode.)

Using Waypoint Zero (From-To)

Waypoint Zero is your Present Position. Calculation of Bearing and Range to a known Waypoint is possible. Also, Waypoint Zero has a special use as a starting point when you have drifted off course and wish to re-plot a course to your destination without returning to your original course. Waypoint Zero resets Cross Track Error to zero at the new starting point the moment it is entered.

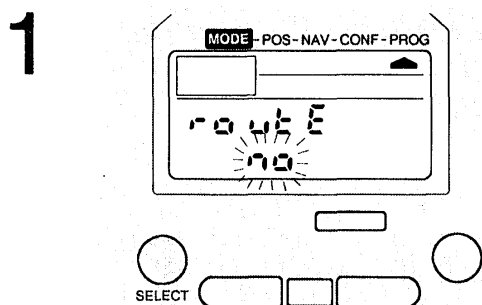

Set "00" route by referring to "Selecting a Route" (page 80).

or

If you have drifted off course and wish to re-plot a course, skip this step.

4
2
Navigation
3

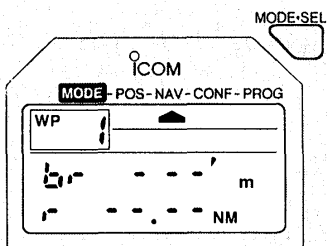

Press the [MODE•SEL.] key until the NAV mode is accessed.

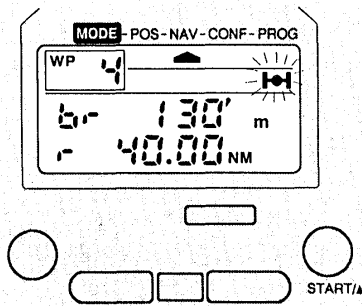

Press the [START/▲] key to calculate your current position.

4

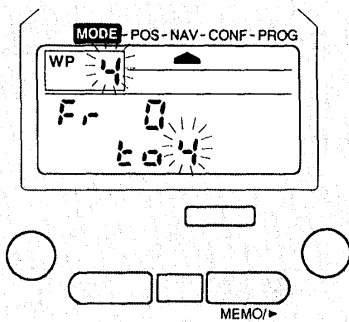

Press the [MEMO/▶] key while bearing and range are displayed.

- “Fr 0” (From 0: Present position) and “to 4” (To WP 4: number of the destination) appear and the destination numbers flash.

5

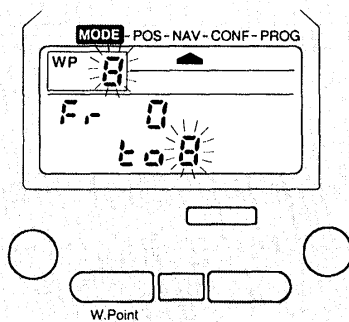

Press the [W.Point] key to select the desired WP number of the destination.

- If you have set a route number (except route “no”), you can select an entered WP number of the route.
- If you have set “route no,” you can select any WP number.

6

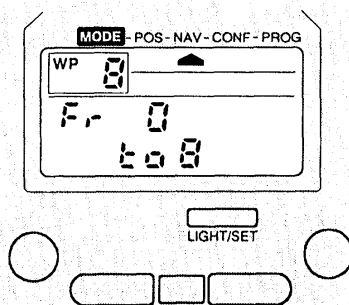

Press the [LIGHT/SET] key.

- Entry completion beep sounds, and a new route from the present position (WP 0) to the destination (Ex. WP 8) is set.
- About 2 seconds later, the bearing and range to the destination are displayed.

4

Navigation

Confirmation (CONF) Mode

- 1. Confirming an Entered Waypoint's Latitude/Longitude**
- 2. Confirming Waypoint Numbers Entered in a Route**
- 3. Displaying Bearing and Range Between Any Two Waypoints**

Confirming an Entered Waypoint's Latitude/Longitude

You can confirm the latitude and longitude entered into each Waypoint.

1

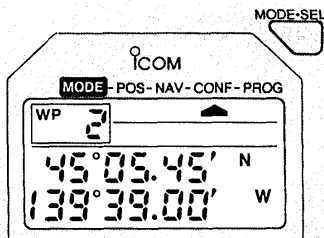

Press the [MODE•SEL.] key until the CONF mode is accessed.

2

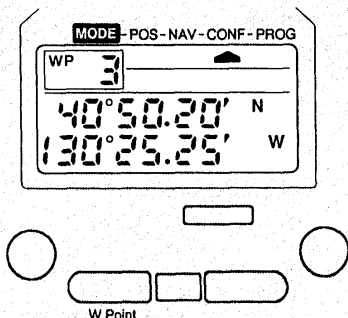

Press the [W.Point] key to select the WP number you wish to confirm.

- The latitude and longitude of the WP number you have selected is displayed.
- Only the WP numbers in which a latitude and longitude are stored are displayed.

Important

- In the CONF mode, it is not possible to change latitude and longitude. If you want to change these, refer to page 72, "Changing Entered Latitude/Longitude."

5

Confirmation

Confirming Waypoint Numbers Entered in a Route

You can confirm which WP numbers were entered into which route.

1

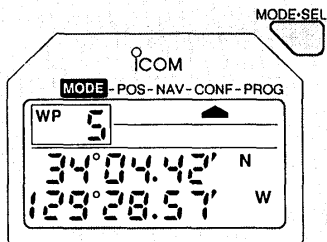

Press the [MODE•SEL.] key until the CONF mode is accessed.

2

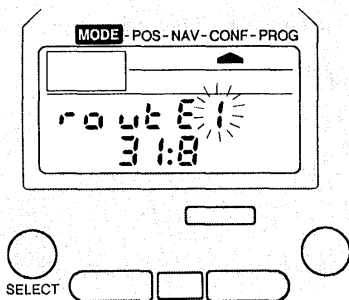

Press the [SELECT] key.

- "route 1" (Route) is displayed, and route number "1" flashes.

3

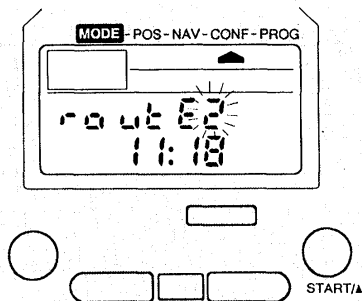

Press the [START/▲] key to select the desired route number.

- Each press advances the route number as follows.

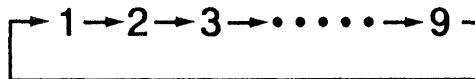

Confirmation 5

4

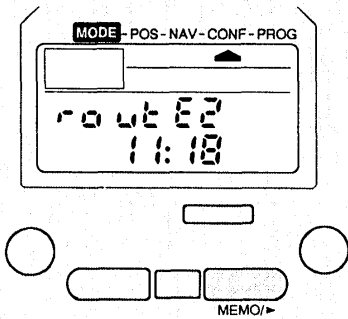

Press the [MEMO/▶] key.

- Flashing of the selected route number stops.

5

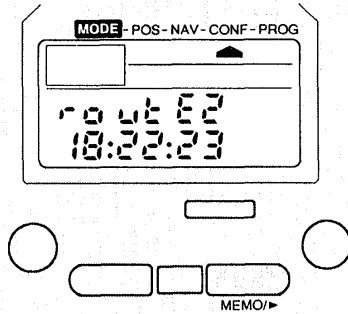

Press the [MEMO/▶] key.

- Each press advances the WP number sequentially.

Note

- To confirm the latitude and longitude of the entered Waypoint, refer to “Confirming an Entered Waypoint’s Latitude/Longitude” on page 63.
- When the right WP number field is blank or “--,” the last WP number is displayed.

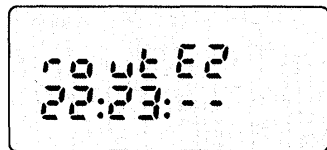

blank or “--”

the last WP number

Displaying Bearing/Range Between Any Two Waypoints

The bearing and range between any two Waypoints of which latitude and longitude are stored in memory can be calculated. This information is useful for trip planning.

1

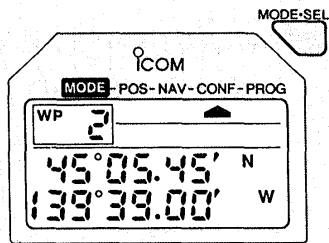

Press the [MODE•SEL.] key until the CONF mode is accessed.

2

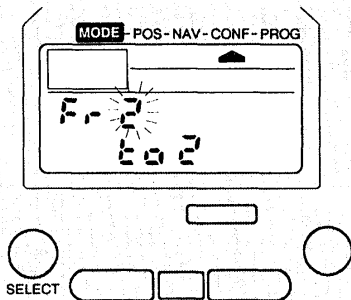

Press the [SELECT] key twice.

3

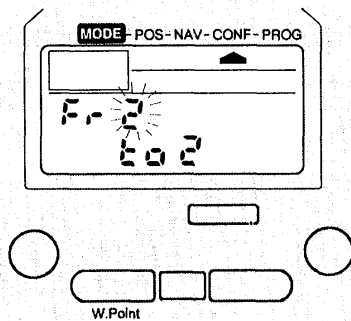

Press the [W.Point] key to select a WP number.

- Each press advances the WP number as follows.

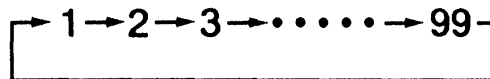

5

Confirmation

4

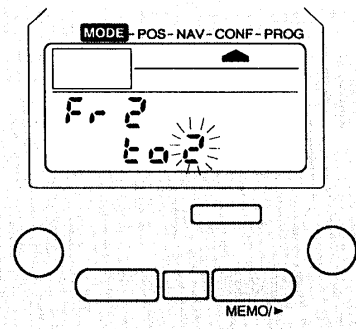

Press the [MEMO/▶] key.

- The “to” Waypoint is activated.

5

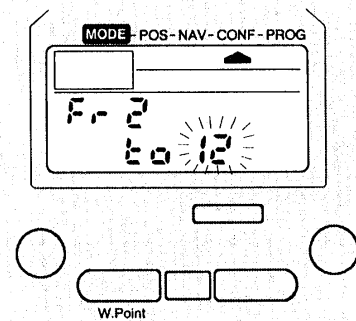

Press the [W.Point] key to select the next WP number

- Each press advances the WP number as follows.

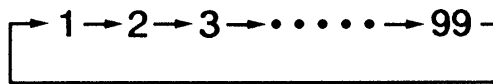

6

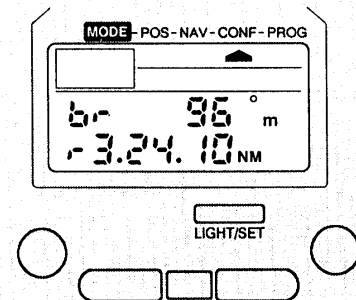

Press the [LIGHT/SET] key.

- The bearing and range between the two selected Waypoints is displayed.
- About 2 seconds later, the display returns to Step 3.
- Each press of the [LIGHT/SET] key displays the bearing and range for about 2 seconds.

Note

- Only Waypoints with latitude /longitude stored in them can be selected.

5

Confirmation

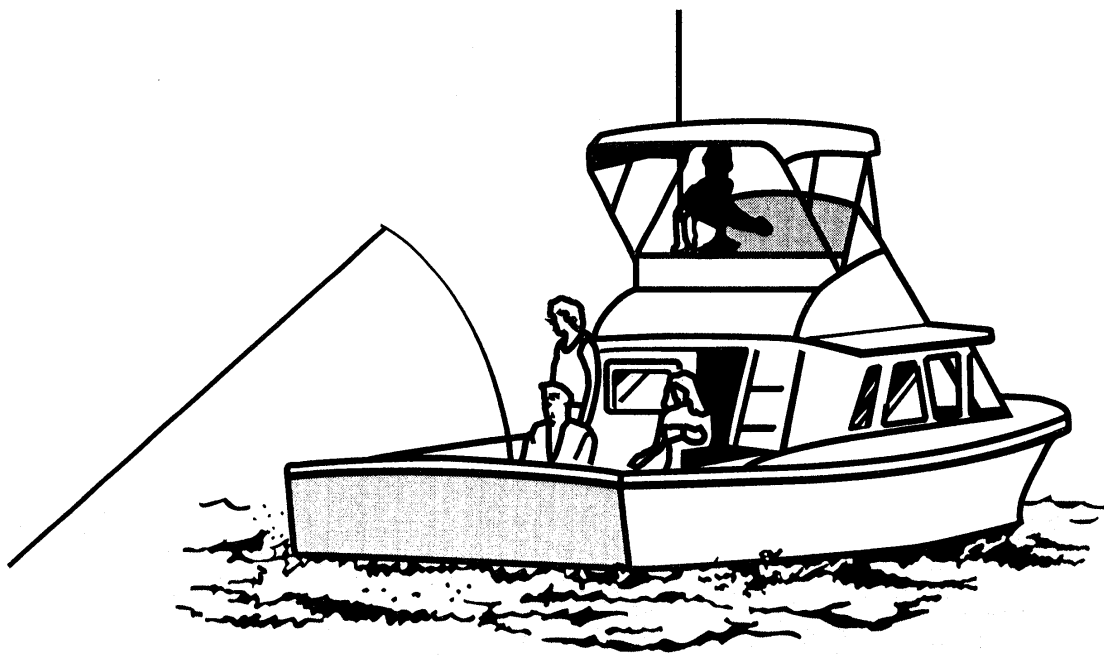
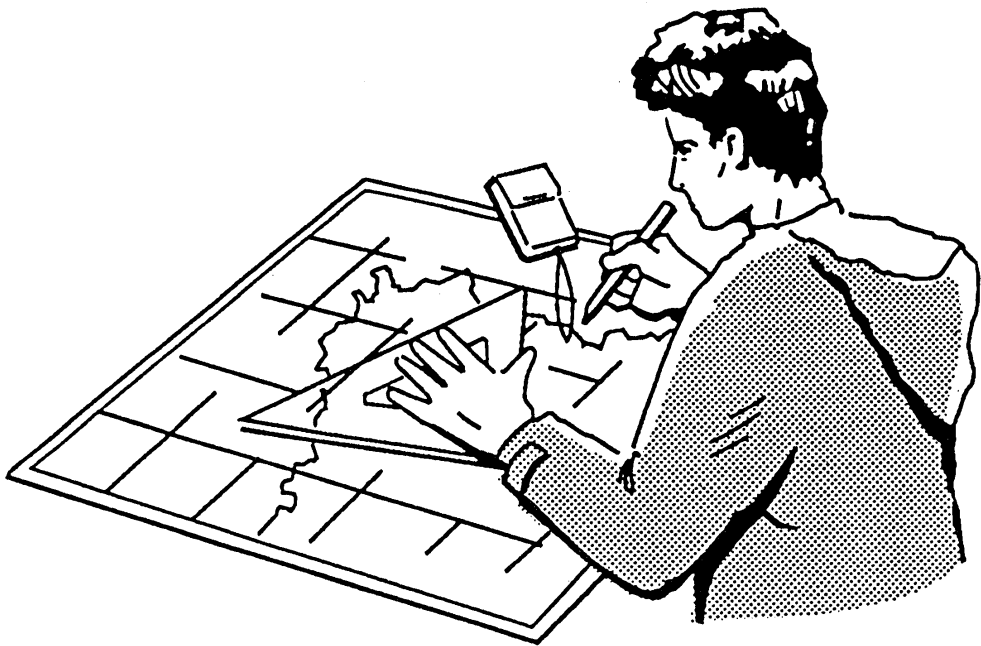

Programming (PROG) Mode

1. Entering Latitude/Longitude of a Waypoint
2. Changing Entered Latitude/Longitude
3. Clearing Entered Latitude/Longitude
4. Route Planning
5. Creating a Route
6. Selecting a Route
7. Clearing a Route

Entering Latitude/Longitude of a Waypoint

After pinpointing the latitude and longitude of a Waypoint on a chart, you can enter it into a WP number (1–99).

1

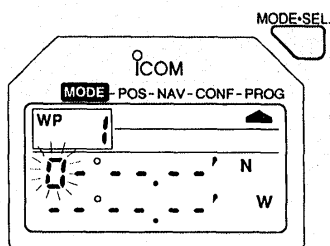

Press the [MODE•SEL.] key until the PROG mode is accessed.

- N North Latitude
- W West Longitude
- The PROG mode indicator is displayed and the first digit of the degrees of latitude flashes.

2

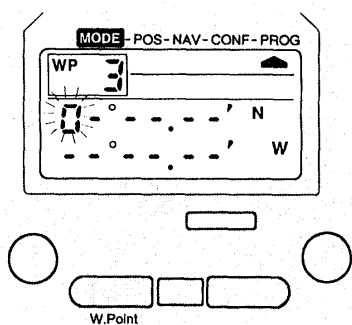

Press the [W.Point] key until the desired WP number appears.

- Each press advances the WP number as follows.

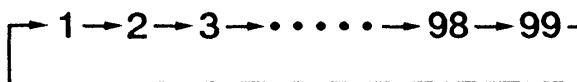

3

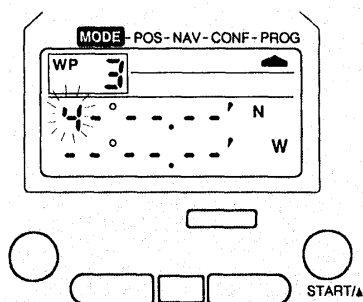

Press the [START/▲] key to select the number for the first digit of the degrees of latitude.

- Each press advances the number as follows.

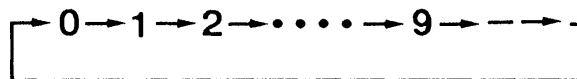

Note

- Entered latitude and longitude to Confirm Refer to page 63
- to Change Refer to page 72
- to Clear Refer to page 74

4

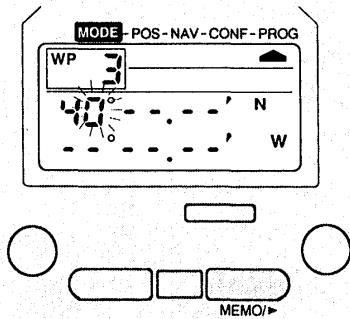

Press the [MEMO/▶] key to select the second digit.

- A flashing number is displayed and the flashing moves to the next digit position.

5

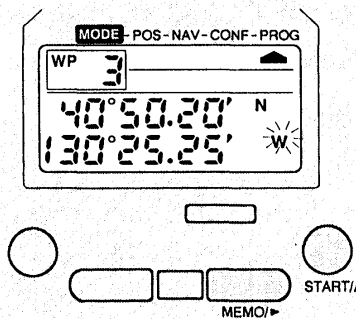

Repeat the same operation as in Steps 3 and 4 to enter the degrees, minutes and seconds (or hundredths) of the latitude and longitude.

- "W" flashes.
- "N" or "S," "E" or "W" can be selected by pressing the [START/▲] key.

6

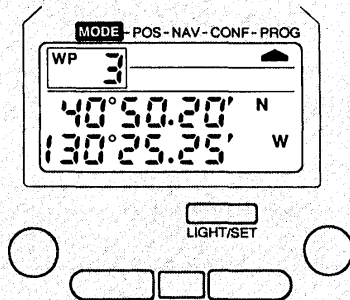

Press the [LIGHT/SET] key.

- Entry completion beep sounds. Flashing stops.

Note

- Entering latitude and longitude "N" or "S" flashes and can be toggled by pressing the [START/▲] key while flashing. Also, "E" or "W" flash in turn and can be selected.

Changing Entered Latitude/Longitude

You can change the latitude and longitude of a Waypoint you have entered in memory. The PROG mode is used for this purpose.

1

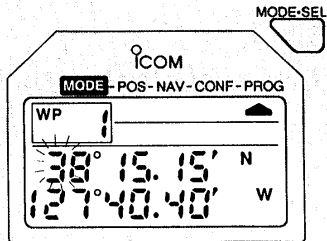

Press the [MODE•SEL.] key until the PROG mode is accessed.

- The first digit of the latitude degrees flashes.

2

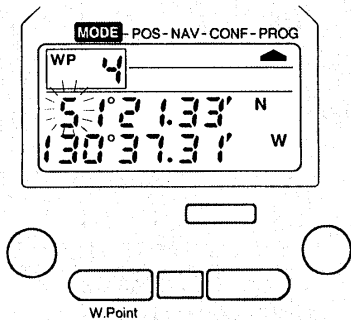

Press the [W.Point] key to select the WP number that you wish to change.

3

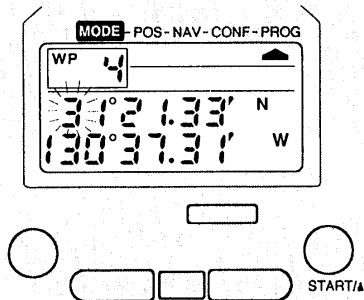

Press the [START/▲] key to select the number.

- Each press advances the number as follows.

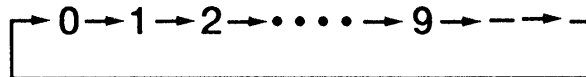

6

Program

4

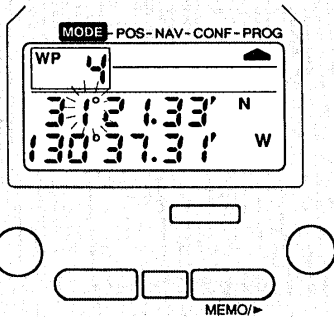

Press the [MEMO/▶] key to select the next digit position.

- A flashing number is displayed and flashing moves to the next digit position.

5

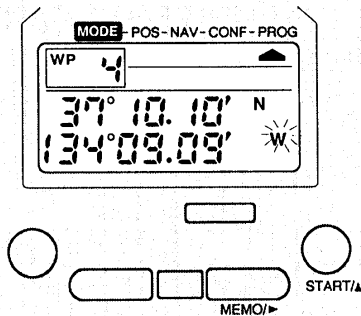

Repeat the same operation as in Step 3 and 4 to change the degrees, minutes and seconds (or hundredths) of latitude and longitude.

- "N" or "S," "E" or "W" can be selected by pressing the [START/▲] key.

6

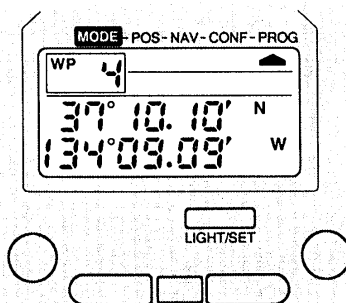

Press the [LIGHT/SET] key.

- Entry completion beep sounds. Flashing stops.
- After entry is completed, the display can be returned to Step 1 by pressing the [MEMO/▶] key.

6

Program

Clearing Entered Latitude/Longitude

You can clear the entered latitude and longitude of a Waypoint as follows.

1

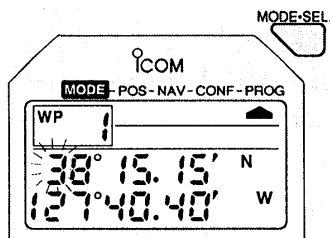

Press the [MODE•SEL.] key until the PROG mode is accessed.

- The number in the first digit of the degrees of latitude flashes.

2

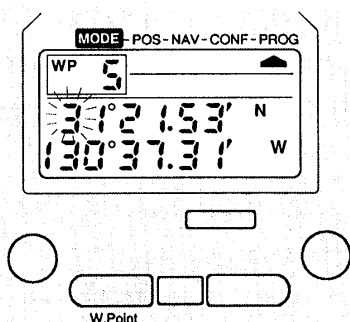

Press the [W.Point] key to select the WP number that you wish to clear.

3

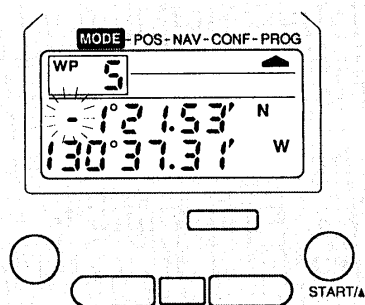

Press the [START/▲] key to select “—” in the first digit position of the degrees of latitude.

- Each press advances the number as follows.

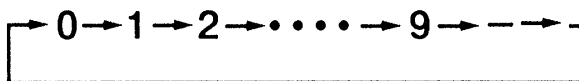

6

Program

4

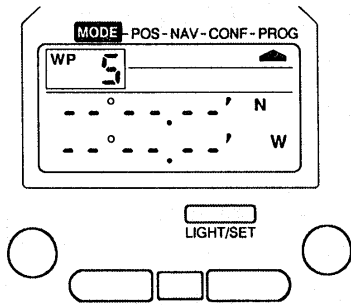

Press the [LIGHT/SET] key.

- Clearing completion beep sounds.
 - After clearing is completed, the display can be returned to Step 1 by pressing the [MEMO/▶] key.
-

Route Planning

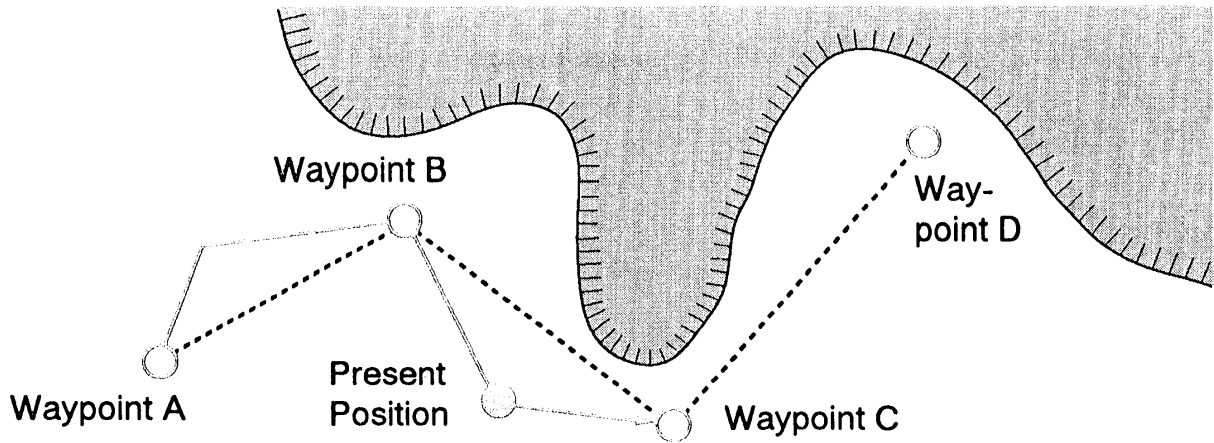

After planning a route by entering the data (latitude/longitude) of the points you want to pass through and the final destination, you can advance to your destination by calculating your present position and revising the cross track error.

Creating a Route

On a chart, a route can be created by entering the Waypoints you want to pass through in the desired sequence. This sequence of Waypoints enables you to create a route, numbered from 1 to 9. One route consists of several Waypoints, which are stored in memory.

1. A Complex Route

You can create up to nine routes. Up to ten Waypoints can be assigned to each route.

(Example) WP Number Assignment

Route Number Assigned Waypoint Number

route 1	1	2	4	5	7	8	10	11	13	14
route 2	1	4	3	7	8	4				
	⋮										
route 9	25	40	32	99						

route 1

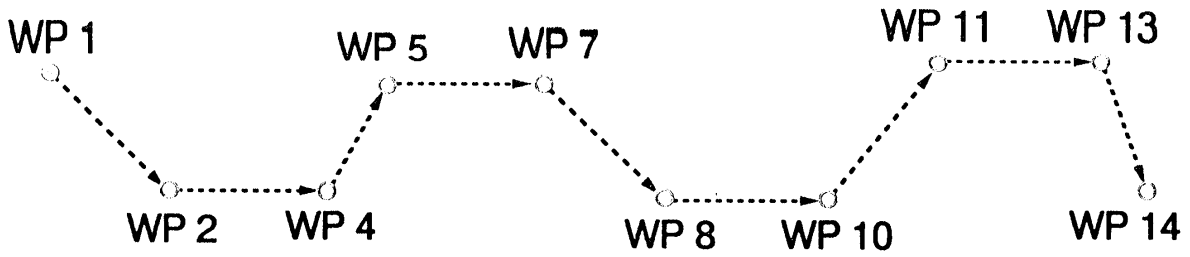

route 2

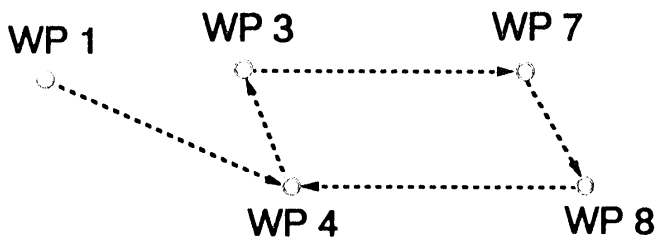

⋮

route 9

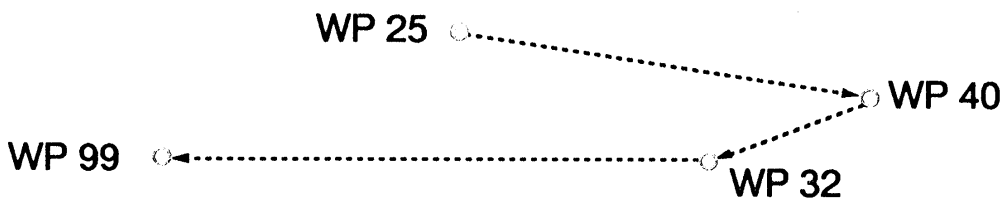

* When you create a route, the reverse route is automatically created.
 You can navigate the reverse route by selecting a reverse route (Ex. route 1A).

Route Number	Assigned WP Numbers
route 1	1 2 4 5 7 8 10 11 13 14
route 1A (reverse route of route 1)	14 13 11 10 8 7 5 4 2 1

Creating a Route

A route can be created by selecting a starting point and a final destination from Waypoints which have the assigned WP number. You can use a route which connects a starting point and a final destination. You can create up to nine routes. Up to ten Waypoints are assigned to each route.

1

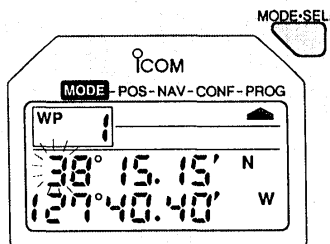

Press the [MODE•SEL.] key until the PROG mode is accessed.

2

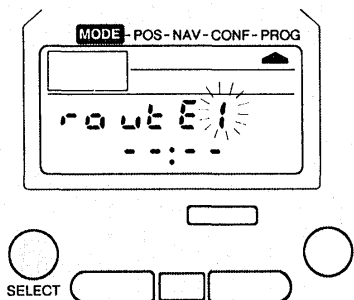

Press the [SELECT] key twice.

- "route 1" is displayed.
- The route number flashes.

3

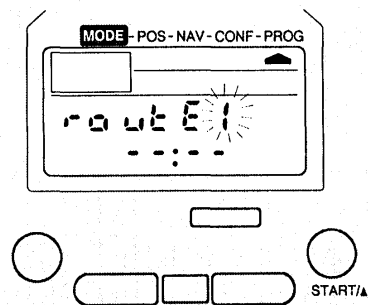

Press the [START/▲] key to select a route number to enter.

- Each press advances the number as follows.

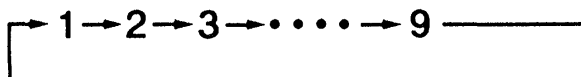

4

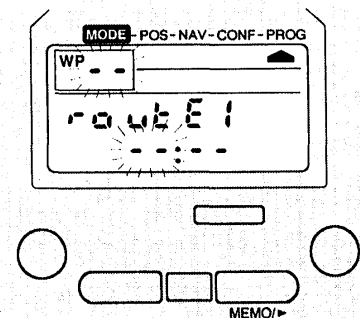

Press the [MEMO/▶] key.

- Flashing of the selected route stops.
- The WP number field flashes.

5

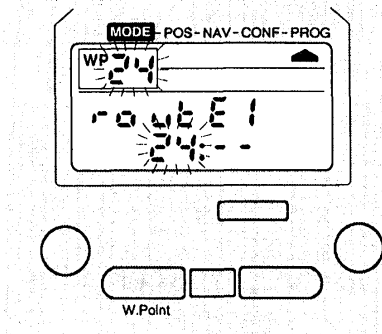

Press the [W.Point] key to select the desired WP number.

- You can enter up to ten WP numbers into one route.
- Empty WP numbers are skipped.

6

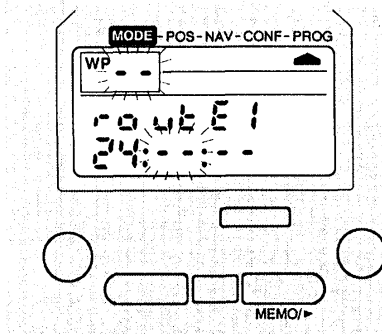

Press the [MEMO/▶] key.

- The entered WP number moves to the left and the WP number field flashes.
- When ten WP numbers are entered, the right WP number field will be blank.

7

Repeat the same operation as in Steps 5 and 6 to assign Waypoints.

8

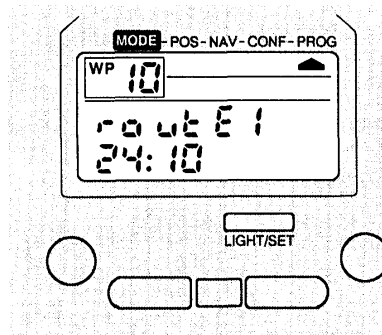

Press the [LIGHT/SET] key.

- Entry completion beep sounds.
- Flashing stops.

Note

- Entering the same WP number.
The same WP number can be entered several times in a single route.
- To change the WP number assigned in a route, press the [START/▲] key after pressing the [LIGHT/SET] key in Step 8. The route number flashes; then go back to step 3 again to assign the desired WP number and continue.

Selecting a Route

You can select one route from among assigned routes to navigate. When you create a route, the reverse route is automatically set. The display "rout E1A" indicates the reverse route of route 1.

1

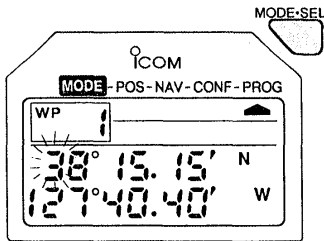

Press the [MODE-SEL.] key until the PROG mode is accessed.

2

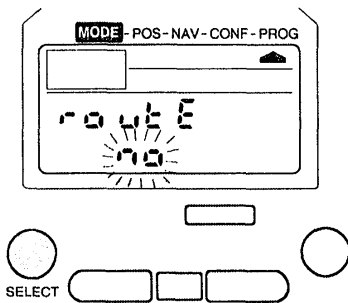

Press the [SELECT] key.

- "rout E" (Route) is displayed and "no" flashes.

3

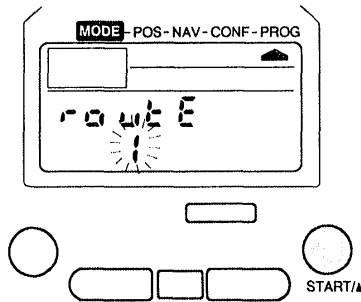

Press the [START/▲] key to select the desired route number.

- Each press advances the number as follows.

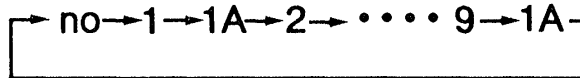

- Empty route numbers are skipped.

4

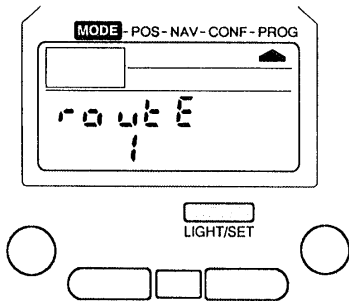

Press the [LIGHT/SET] key.

- Entry completion beep sounds.
- Flashing stops.

Note

- Empty route numbers are not displayed when you press the [START/▲] key in Step 3.
- The following entered routes can be selected.
 - route no (See page 60)
 - route 1–9
 - route 1A–9A (reverse routes)

Clearing a Route

The entered Waypoint assignment in one route can be cleared.

1

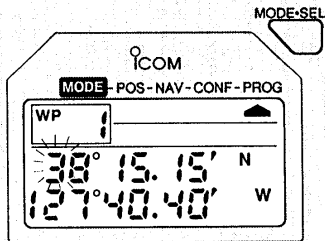

Press the [MODE•SEL.] key until the PROG mode is accessed.

2

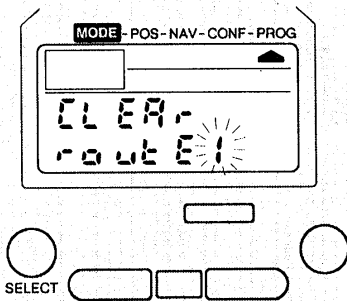

Press the [SELECT] key 3 times.

- "route E" is displayed and the route number flashes.

3

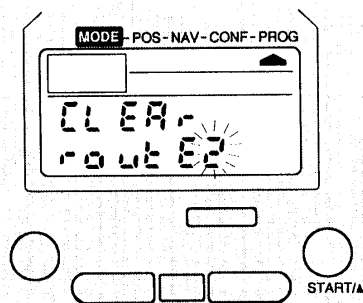

Press the [START/▲] key to select a route number to be cleared.

- Each press advances the route number as follows.

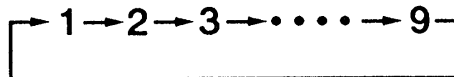

6

Program

4

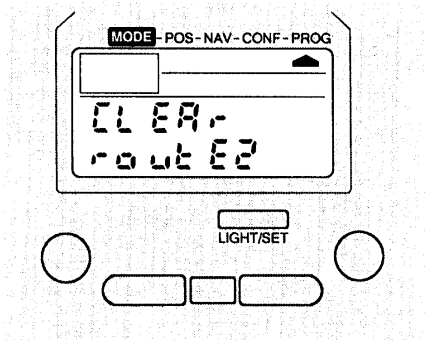

Press the [LIGHT/SET] key.

- Clearing completion beep sounds. Flashing stops.

Note

- Latitude and longitude of Waypoints are not cleared in this case.
Only the WP number entry of a route can be cleared by this operation.
- All WP numbers in the selected route will be cleared by a single operation.

Function Summary Chart

The POS mode is set after turning the power on. The other modes (NAV, CONF, PROG) are selected by pressing the [MODE•SEL.] key.

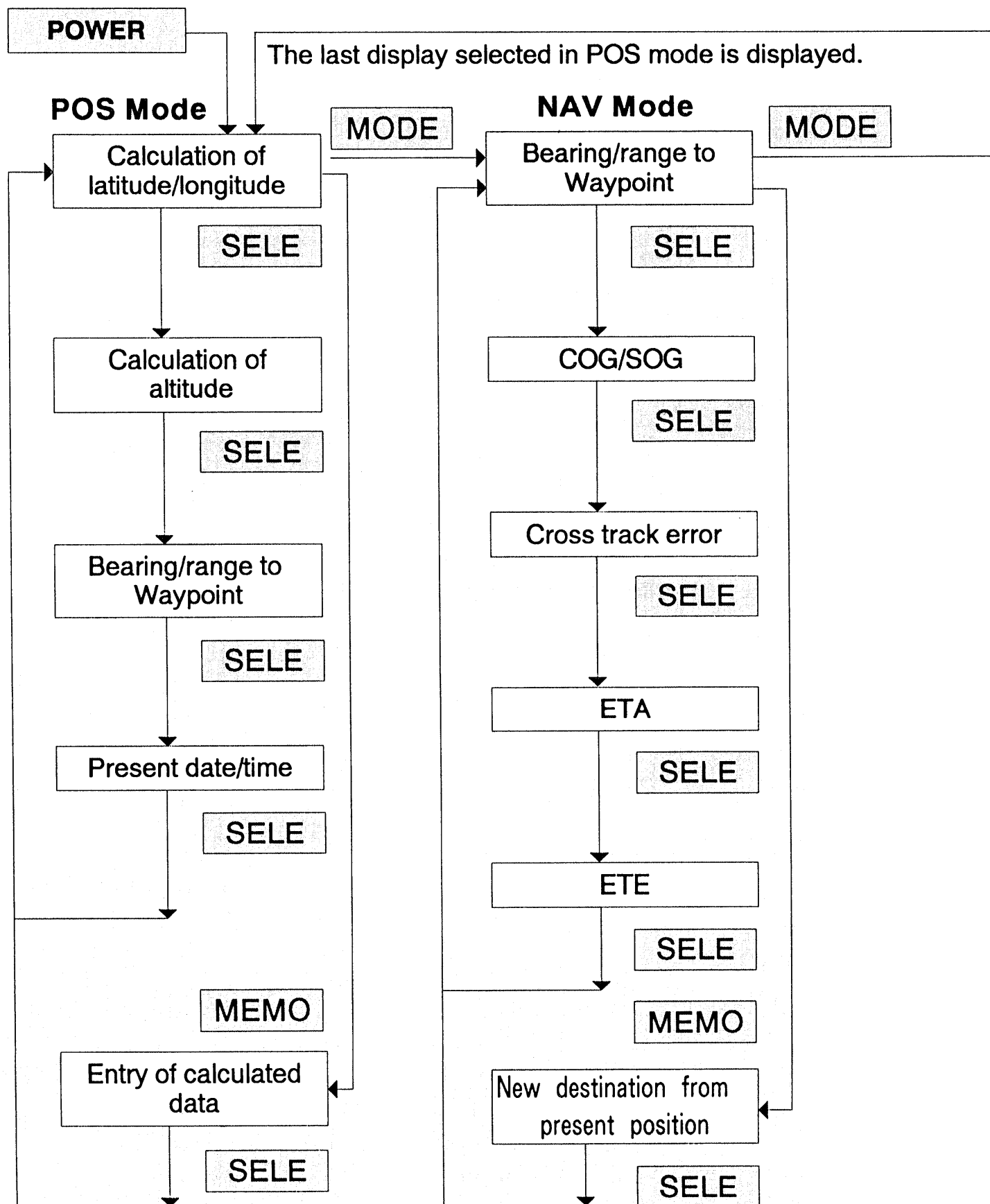

The display screen is changed by pressing the [SELECT] key in each mode.

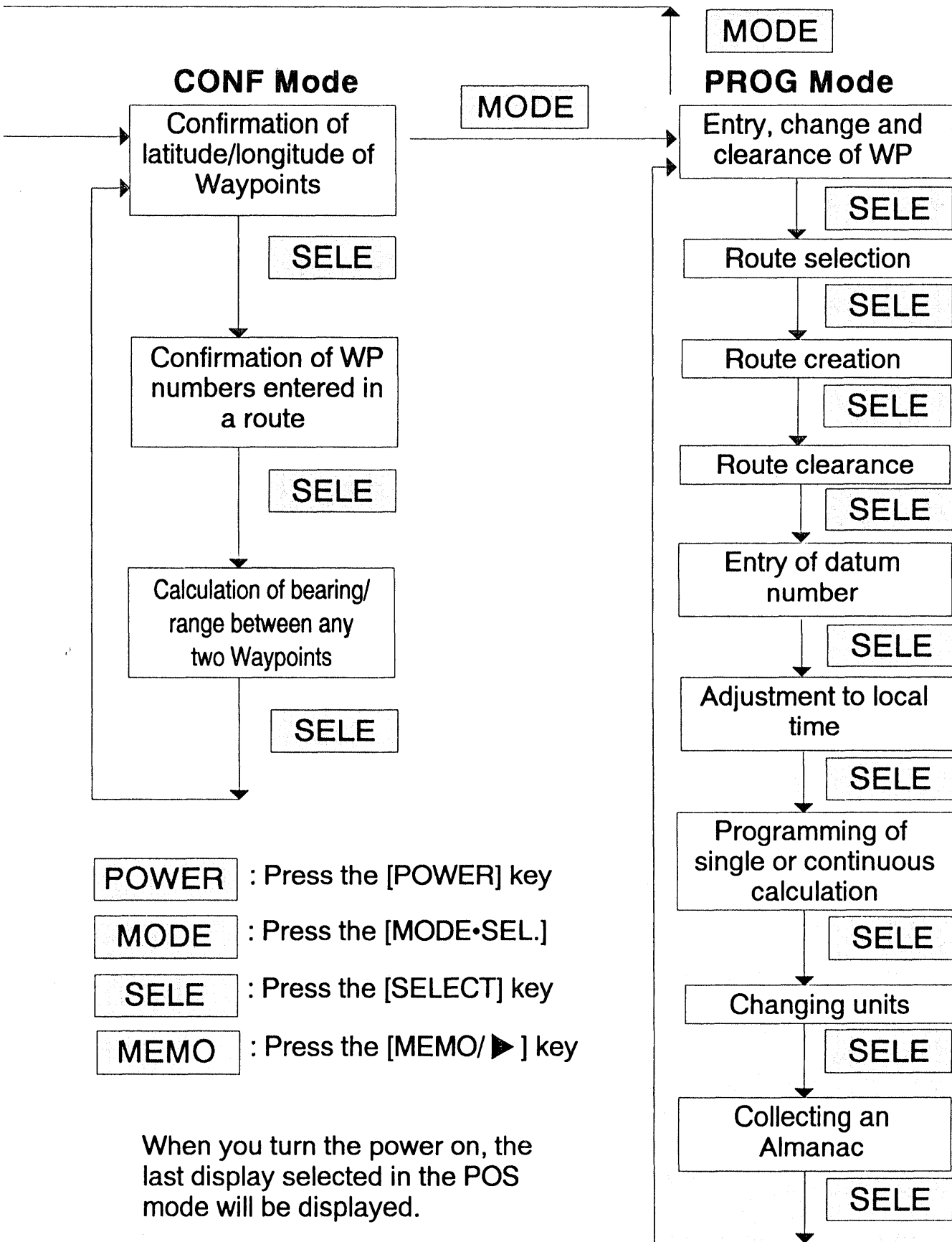

- POWER** : Press the [POWER] key
- MODE** : Press the [MODE•SEL.]
- SELE** : Press the [SELECT] key
- MEMO** : Press the [MEMO/▶] key

When you turn the power on, the last display selected in the POS mode will be displayed.

Display Characters

Display Type	Meaning	Reference Page
AL	Almanac: Information about location of satellites	40
br	Bearing	50
CLEAR route	Route Clear: Clearing a route	82
COG	COG (Course Over Ground): Direction you are moving in relation to the ground	54
Cont	Continuous: Continuous Calculation	32
CTE	CTE (Cross Track Error): Deviation from intended course	55
d no.	Datum Number	28
Error AL	Error Almanac: Error in receiving Almanac	41
ETA	ETA (Estimated Time of Arrival)	58
ETE	ETE (Estimated Time Enroute)	58
Found	Found: Satellites are being received	45
From to	From 0 to: Entry from WP 0 to WP #	61
ft	Feet	36
FULL	Full: WP numbers (01–99) are all used No empty WP available	49
km	Kilometers	39
km/h	Kilometers Per Hour	54
L	Local Time	45

Display Type	Meaning	Reference Page
L - -	Left: Your position is off course to the LEFT of the intended course Steer right to get back on course	55
M	Miles	39
M/h	Miles Per Hour	54
m	Meters	36
	Magnetic Bearing	51
MEMO	Memo: Completion of entering calculated data	48
NM	Nautical Miles	39
NM/h	Nautical Miles Per Hour (Knots)	54
Once	Once: Single Calculation	32
r	Range: Distance to selected WP	51
r - -	Right: Your position is off course to the RIGHT of the intended course Steer left to get back on course	55
route no	Entry of Route Number (NAV information from WP 0 to desired WP)	60
SoG	Speed Over Ground: Actual speed in relation to the ground	54
Store	Store: Storing current lat./lon. into WP memory	48
Stored	Stored: Storing is completed.	49
U	UTC (Universal Time Coordinated) or GMT	45
WP	Waypoint: Entry number for calculated lat./lon.	48

World Time Difference Table

To display local time, refer to "Adjusting to Local Time." (page 30)

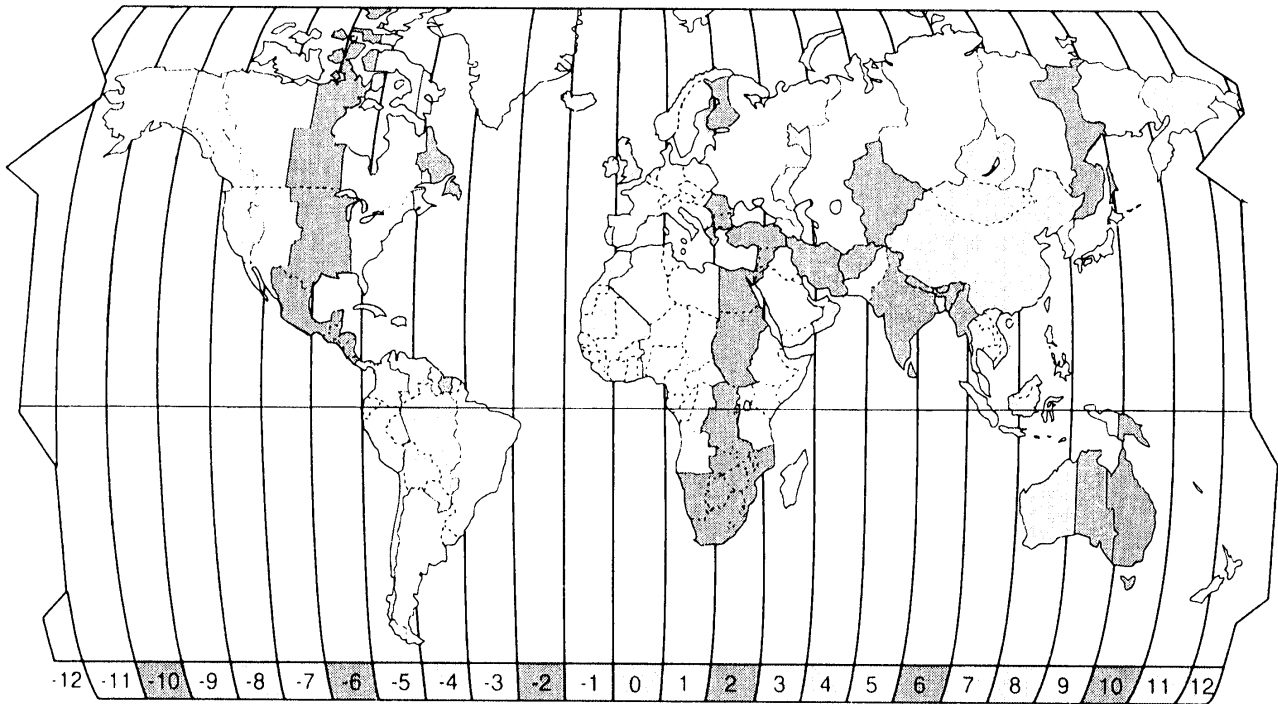

This "World Time Difference Table" shows an outline of time differentials from UTC (GMT).

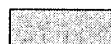
 Shaded areas differ from the indicated time zones by less than one hour.

Explanation of Terms

A

Almanac (page 40)

Almanac is the information about locations of all the GPS satellites. Each satellite sends messages constantly and the GP-22 is designed to reduce the calculating time by saving Almanac information.

Arrival Confirmation Tone (page 59)

The arrival function emits 8 long beep tones to alert you when coming within a 0.1 NM radius of a preselected Waypoint. After this, the receiver starts calculating the bearing and range from the present position to the next Waypoint.

B

Bearing (page 50)

Direction in degrees relative to Magnetic North, from one location to another location.

C

Complex Route (page 76)

This receiver provides 9 routes, each of which consists of up to 10 Waypoints. The desired route can be created by assigning the desired Waypoints you want to pass through to your destination. The same Waypoint can be assigned several times in the same route.

CONF (page 62)

CONF is an abbreviation for Confirmation. This mode confirms latitude and longitude entered in Waypoints, WP number entered in the route and bearing/range between any two Waypoints.

Continuous Calculation (page 32)

Once a calculation of a current position is started by pressing the [START/▲] key, the latest (up-to-date) calculated data is automatically displayed approx. every 3 seconds.

Course Over Ground (COG) (page 54)

The direction you are moving over the ground, relative to Magnetic North.

Cross Track Error (page 55)

Cross Track Error is the deviation from the intended course (rhumb line which connects the previous Waypoint and the next Waypoint) to the present position.

The perpendicular line from the current position to the course will be displayed by the deviation as “to the right ○○ NM” or “to the left ○○ NM.” Up to 99.99 NM (km, M) can be displayed.

Datum Number (page 28, 95)

Because the earth is an oval and not a perfect sphere, different systems have been devised to represent regions of the earth on two-dimensional maps and charts.

Unfortunately, this means that charts meant to accurately portray one specific region of the earth may be very poor representations for other regions of the earth.

In an effort to standardize maps and charts throughout the world, a system called WGS84 (World Geodetic System) was devised. This system utilizes what are called Datum Numbers to correct for variations between different regions of the world. GPS adopts this standard, which takes the earth as a rotating oval having its center at the gravitational center of the earth, to calculate latitude, longitude and altitude.

Because the information received from GPS satellites is in accord with WGS84 standards, this data needs to be adjusted with the datum number for the specific region you are interested in.

The GP-22's default setting is 00 (WGS84). This datum number needs to be changed to the datum number for the specific region of the world you taking measurements in (01–93).

(D)



ETA (page 58)

Estimated Time of Arrival is calculated at current speed to destination.

ETA is displayed when keeping the present heading and speed in Continuous Calculation. ETA is displayed only when moving in Continuous Calculation. Up to 23 hours 59 minutes and 59 seconds from the present time can be displayed.

ETE (page 58)

Estimated Time Enroute or time remaining.

ETE is displayed only when moving in Continuous Calculation. Up to 99 hours 59 minutes and 59 seconds from the present time can be displayed.



Latitude (page 45)

The coordinates which indicate a distance north or south from the equator measured in degrees. Latitude is shown by an angle between the equator's surface and a line connecting the center of the earth and a point on the earth.

The latitude of the Equator is 0° .

The latitude of the North Pole is 90° N.

The latitude of the South Pole is 90° S.

Longitude (page 45)

The coordinates which indicate a distance east or west on the earth. A distance east or west of the Greenwich Meridian (longitude 0°) is shown by an imaginary arc which is drawn between the North and South Poles. East and west longitude are counted from 0° to 180° .

(M)

Magnetic Bearing (page 50)

The earth is itself a gigantic magnet and the magnetic needle of a compass points to the North and South Pole's as a result of the Earth's magnetic field.

Magnetic Bearing is a unit of measure of the earth's magnetic field that takes a value of 0° for Magnetic North.

Magnetic Bearing is not the same as True Bearing.

(N)

NAV (page 52)

NAV is an abbreviation of navigation.

Navigation functions include bearing and range from the present position to the destination, COG and SOG, Cross Track Error, ETA and ETE and Fr/to calculations.

(P)

POS (page 43)

POS is an abbreviation of position.

This mode accesses the calculation of a present position in lat./long., altitude, bearing and range to a destination, and date/time. You can also instantly store your current position into Waypoint memory.

Present Date and Time Display (page 44)

The accuracy of Universal Time Coordinated (UTC) is included in the information from the GPS satellites. Once this receiver starts calculating a position by receiving information from the GPS satellites, the internal clock of the GP-22 is automatically synchronized to the GPS satellites' clock.

PROG (page 69)

PROG is an abbreviation of programming.

This mode functions by entering latitude and longitude into a Waypoint or entering or clearing a route.



Range (page 50)

The distance between two Waypoints, expressed in NM, M or km.

Route (page 76)

Route consists of the Waypoints to be passed through to a destination. A route can be created by utilizing these points. You can make up to nine routes and store up to ten Waypoints in each route. The latitude and longitude of the points to be passed through should be entered in Waypoints, and these numbers should be assigned to the route in the desired sequence. The reverse of the route you assigned is also available and designated with an "A."



Single calculation (page 32)

Calculation of a current position is made only once by pressing the [START/▲] key each time. If no key operation is made for 2 minutes after displaying the outcome of the calculation, the power is automatically turned off. When moving a long distance or using the receiver for long periods of time, minimize battery consumption by using Single Calculation mode.

SOG (page 54)

The speed which you are actually moving in relation to the ground is calculated and displayed when moving in Continuous Calculation. The faster you are moving, the more accurate the calculated figure is. An incorrect figure is displayed when you are stationary.

Up to 999 NM/h (km/h, M/h) can be displayed.



Two dimensional calculation (page 46)

A two-dimensional reading indicating latitude and longitude. When signals from only three satellites are available after starting the calculation of a current position, only latitude and longitude are displayed (two dimensions of information). Altitude is not displayed.



UTC (page 44)

Universal Time Coordinated

Greenwich Mean Time, which is fixed on the Prime Meridian (longitude 0°) of the old Greenwich Astronomical Observatory, is now adopted as Universal Time Coordinated.



Waypoint (page 48)

Waypoints are destinations or locations that are entered into memory to be recalled to utilize the Navigation functions at any time. Up to 99 Waypoints (1–99) can be stored in non-volatile memory.

World Datum List

To set up a datum number, refer to "Adjusting Datum to Regional Standards," (page 28).

Datum Number	Region	Coordinate System
00		WGS84 (standard)
01	Japan Korea Okinawa	TOKYO
02	Ethiopia Mali Senegal Sudan	ADINDAN
03	Somalia	AFGOOYE
04	Bahrain Island	AIN EL ABD 1970
05	Cocos Island	ANNA 1 ASTRO 1965
06	Botswana Lesotho Malawi Swaziland Zaire Zambia Zimbabwe	ARC 1950
07	Kenya Tanzania	ARC 1960
08	Ascension Island	ASCENSION ISLAND 1958
09	Iwo Jima Island	ASTRO BEACON "E"
10	Tern Island	ASTRO B4 SOROL ATOLL
11	St. Helena Island	ASTRO DOS 71/4
12	Marcus Island	ASTRONOMIC STATION 1952
13	Australia Tasmania Island	AUSTRALIAN GEODETIC 1966
14	Australia Tasmania Island	AUSTRALIAN GEODETIC 1984
15	Efate Erromango Islands	BELLEVUE (IGN)
16	Bermuda Islands	BERMUDA 1957
17	Colombia	BOGOTA OBSERVATORY

World Datum List (cont.)

Datum Number	Region	Coordinate System
18	Argentina	CAMPO INCHAUSPE
19	Phoenix Islands	CANTON ASTRO 1966
20	South Africa	CAPE
21	Florida Bahama Islands	CAPE CANAVERAL
22	Tunisia	CARTHAGE
23	Chatham Island New Zealand	CHATHAM 1971
24	Paraguay	CHUA ASTRO
25	Brazil	CORREGO ALEGRE
26	Sumatra Island Indonesia	DJAKARTA (BATAVIA)
27	Gizo Island New Georgia Islands	DOS 1968
28	Easter Island	EASTER ISLAND 1967
29	Austria Belgium Denmark Finland France Germany Gibraltar Greece Italy Luxembourg Netherlands Norway Portugal Spain Sweden Switzerland	EUROPEAN 1950

Datum Number	Region	Coordinate System
30	Austria Finland Netherlands Norway Spain Sweden Switzerland	EUROPEAN 1979
31	Republic of Maldives	GANDAJIKA BASE
32	New Zealand	GEODETIC DATUM 1949
33	Guam Island	GUAM 1963
34	Guadalcanal Island	GUX 1 ASTRO
35	Iceland	HJORSEY 1955
36	Hong Kong	HONG KONG 1963
37	Thailand Vietnam	INDIAN (Part 1)
38	Bangladesh India Nepal	INDIAN (Part 2)
39	Ireland	IRELAND 1965
40	Diego Garcia	ISTS 073 ASTRO 1969
41	Johnston Island	JOHNSTON ISLAND 1961
42	Sri Lanka	KANDAWALA
43	Kerguelen	KERGUELEN ISLAND
44	West Malaysia Singapore	KERTAU 1948
45	Cayman Brac Island	L. C. 5 ASTRO
46	Liberia	LIBERIA 1964
47	Philippines	LUZON (Part 1)

World Datum List (cont.)

Datum Number	Region	Coordinate System
48	Mindanao Island	LUZON (Part 2)
49	Mahe Island	MAHE 1971
50	Salvage Islands	MARCO ASTRO
51	Eritrea Ethiopia	MASSAWA
52	Morocco	MERCHICH
53	Midway Island	MIDWAY ASTRO 1961
54	Nigeria	MINNA
55	Masirah Island Oman	NAHRWAN (Part 1)
56	United Arab Emirates	NAHRWAN (Part 2)
57	Saudi Arabia	NAHRWAN (Part 3)
58	Trinidad and Tobago	NAPARIMA, BWI
59	Contiguous United States	NORTH AMERICAN 1927 (Part 1)
60	Alaska	NORTH AMERICAN 1927 (Part 2)
61	Bahamas	NORTH AMERICAN 1927 (Part 3)
62	San Salvador Island	NORTH AMERICAN 1927 (Part 4)
63	Canada Newfoundland Island	NORTH AMERICAN 1927 (Part 5)
64	Canal Zone	NORTH AMERICAN 1927 (Part 6)

Appendices

7

Datum Number	Region	Coordinate System
65	Caribbean Barbados Caicos Islands Cuba Dominican Republic Grand Cayman Jamaica Leeward Islands Turks Islands	NORTH AMERICAN 1927 (Part 7)
66	Central America Belize Costa Rica El Salvador Guatemala Honduras Nicaragua	NORTH AMERICAN 1927 (Part 8)
67	Cuba	NORTH AMERICAN 1927 (Part 9)
68	Greenland Hayes Peninsula	NORTH AMERICAN 1927 (Part 10)
69	Mexico	NORTH AMERICAN 1927 (Part 11)
70	Alaska Canada Central America Contiguous United States Mexico	NORTH AMERICAN 1983
71	Corvo Flores Islands Azores	OBSERVATORIO 1966
72	Egypt	OLD EGYPTIAN
73	Hawaii	OLD HAWAIIAN
74	Oman	OMAN

World Datum List (cont.)

Datum Number	Region	Coordinate System
75	England Isle of Man Scotland Shetland Islands Wales	ORDNANCE SURVEY OF GREAT BRITAIN 1936
76	Canary Islands	PICO DE LAS NIEVES
77	Pitcairn Island	PITCAIRN ASTRO 1967
78	South Chile (near 53° S)	PROVISIONAL SOUTH CHILEAN 1963
79	Bolivia Chile Colombia Ecuador Guyana Peru Venezuela	PROVISIONAL SOUTH AMERICAN 1956
80	Puerto Rico Virgin Islands	PUERTO RICO
81	Qatar	QATAR NATIONAL
82	South Greenland	QORNOQ
83	Mascarene Island	REUNION
84	Sardinia Island	ROME 1940
85	Argentina Bolivia Brazil Chile Colombia Ecuador Guyana Paraguay Peru Trinidad and Tobago Venezuela	SOUTH AMERICAN 1969
86	Porto Santo Medeira Islands	SOUTHEAST BASE

Datum Number	Region	Coordinate System
87	Faial Graciosa Pico São Jorge Terceira Islands Azores	SOUTHWEST BASE
88	Brunei East Malaysia Sarawak Sabah	TIMABALAI 1948
89	Tristan de Cunha	TRISTAN ASTRO 1968
90	Viti Levu Island Fiji Islands	VITI LEVU 1916
91	Marshall Islands	WAKE-ENIWETOK 1960
92	Surinam	ZANDERIJ
93	Sweden	RT90

Conserving Battery Power

Saving Latitude/Longitude

Conserving Battery Power

The GP-22 continues to calculate (and consume battery power) until the power is turned off (Continuous Calculation).

However, there is an Automatic Power-Off function to conserve battery power. In order to use this function, programming a Single Calculation is necessary. If no keys are pressed for 2 minutes during Single Calculation, the power is automatically turned off. The Automatic Power-Off function does not apply in the following circumstances.

- When searching for satellites to receive signals. (page 45)
- When receiving Almanac information to shorten calculation times. (page 40)

Saving Latitude/Longitude

Latitude and longitude entered into the GP-22 is retained by the internal lithium backup battery even when power is turned off.

- The lithium backup battery's life is approx. 5 years.
- When the lithium battery is depleted, any information stored in the receiver is lost after power off.
- Do not attempt to replace a depleted lithium battery yourself. Have an authorized service technician replace it.

Maintenance

To clean the GP-22

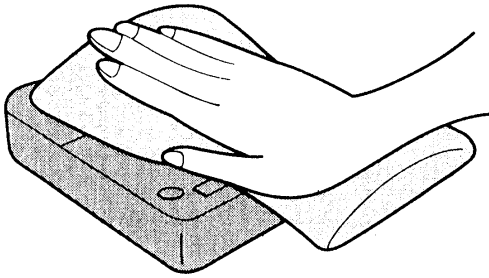

Use a soft, dry cloth.

If there is a buildup of dirt on the receiver's exterior, immerse the cloth in a weak solution of dish water detergent; wring firmly so that the cloth is not soaking but only damp; then wipe the receiver clean.

After cleaning in this manner, gently wipe the receiver dry.

NEVER clean the GP-22 using any of the items listed below. Doing so may damage the receiver's surfaces.

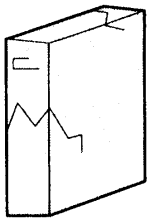

Abrasive
powders

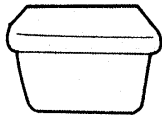

Detergent
powders

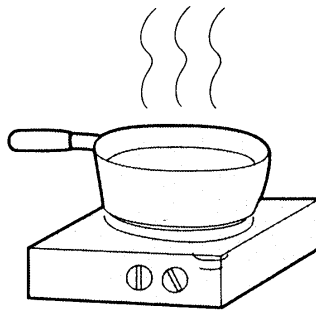

Hot water

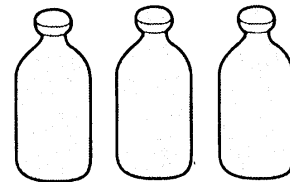

Thinner, Benzene, Alcohol

Troubleshooting Guide

If you are experiencing difficulties with the GP-22, please check the items listed below. If you cannot resolve the problem in this manner, consult your nearest Icom Service Center.

Problem	Possible cause	Solution	Reference page
Calculation result does not appear for a long time after receiving signals.	An obstacle such as a building is in the way.	Move to an area free from surrounding obstructions.	11
	Constellation of GPS satellites is no good.		11
COG and SOG are not displayed.	Single Calculation is programmed.	Program Continuous Calculation. (page 32)	54
ETA is not displayed.			58
ETE is not displayed.			58
Power is not on. (When using rechargeable battery.)	Rechargeable battery is depleted.	Charge rechargeable battery.	15
Power is not on. (When using dry cell batteries.)	Batteries are depleted.	Replace the batteries with new ones.	19
	Battery's polarity (⊕, ⊖) is reversed.	Install the batteries correctly.	
Rechargeable battery does not last long.	Battery is not charged sufficiently.	Charge the battery until fully charged (about 10 hours).	15
Rechargeable battery does not last long even after charging it for the prescribed time (about 10 hours).	The life of the rechargeable battery is over.	Replace the rechargeable battery with a new one. (See your Icom Dealer.)	22

Specifications

Main Unit

Receiving Method	5 Channels, Parallel Receiving (1575.42 MHz)
Receiving Sensitivity	- 130 dBm
Position Accuracy	15 mRMS (GDOP \leq 6) Position may be degraded up to 328 feet 2D RMS under the control of the U.S. Dept. of Defense.
Display Type	2 Lines, 7 Segments, Liquid Crystal Display
Memory Backup	5 Years (Internal Lithium Battery)
Useable Temperature	- 10 °C to +50 °C (+14 °F to +122 °F)
Power Supply	Rechargeable Battery : Approx. 80 min. Display backlight off, continuous use at +20 °C (+68 °F) 5 AA (R6) Alkaline Batteries : Approx. 300 min. Display backlight off, continuous use at +20 °C (+68 °F)
Dimensions (W × H × D)	65 × 131 × 35 mm; 2 ⁹ / ₁₆ × 5 ⁵ / ₃₂ × 1 ³ / ₈ in * ¹ 65 × 131 × 52 mm; 2 ⁹ / ₁₆ × 5 ⁵ / ₃₂ × 2 ¹ / ₁₆ in * ² (Projections not included)
Weight	Approx. 240 g; 8.4 oz (Main unit) Approx. 330 g; 11.6 oz (With rechargeable battery) Approx. 420 g; 14.7 oz (With alkaline batteries)

*¹ With BP-154 Rechargeable battery pack.

*² With BP-155 Battery case with alkaline batteries.

Battery Charger

Useable temperature	+10 °C to +35 °C (+50 °F to +95 °F)
Dimensions (W × H × D)	66 × 130 × 34 mm; 2 ⁵ / ₈ × 5 ¹ / ₈ × 1 ³ / ₈ in
Weight	Approx. 100 g; 3.5 oz

Accessory Order Information

Replacement parts and accessories are available through your local authorized Icom Dealer.

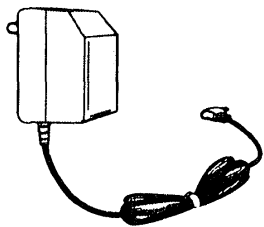
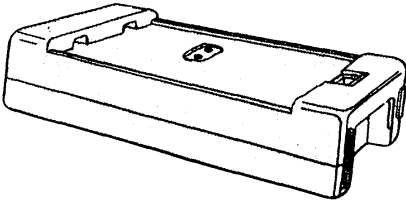
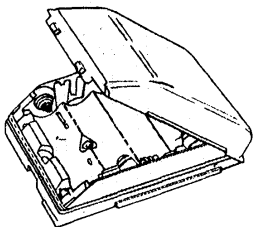
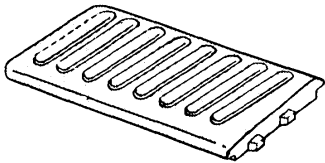
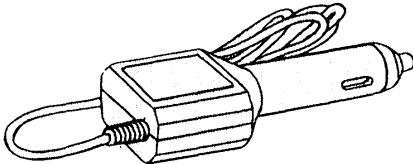
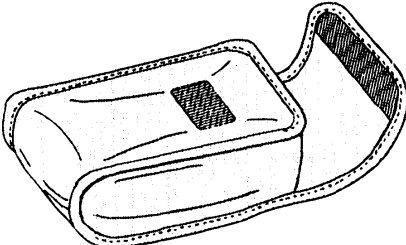
Part No.	Accessory	Description
AD-37 (117 V/U.S.A) AD-39 (230 V/Eur) AD-40 (240 V/U.K.) AD-41 (240 V/AUS) AD-42 (220-240 V)		AC Adaptor
BC-101		Battery Charger
BP-155		Battery Case for AA (R6) Dry Cell Batteries
BP-154		Rechargeable Nickel Metal Hydride Battery Pack
CP-15 (General) CP-16 (Eur-type plug)		Cigarette Lighter Cable
LC-112		Carrying Case

Product Service

See your local authorized Icom Dealer for details concerning product service.

If you ship the GP-22

Carefully pack it and send it prepaid, adequately insured and preferably in the original carton. Attach a postage-paid letter, detailing the problem, to the outside of the carton.

For your future reference

Serial No. _____ Date of purchase _____
(found on the bottom of the receiver)

Name of dealer _____

Dealer's address _____

Count on us!

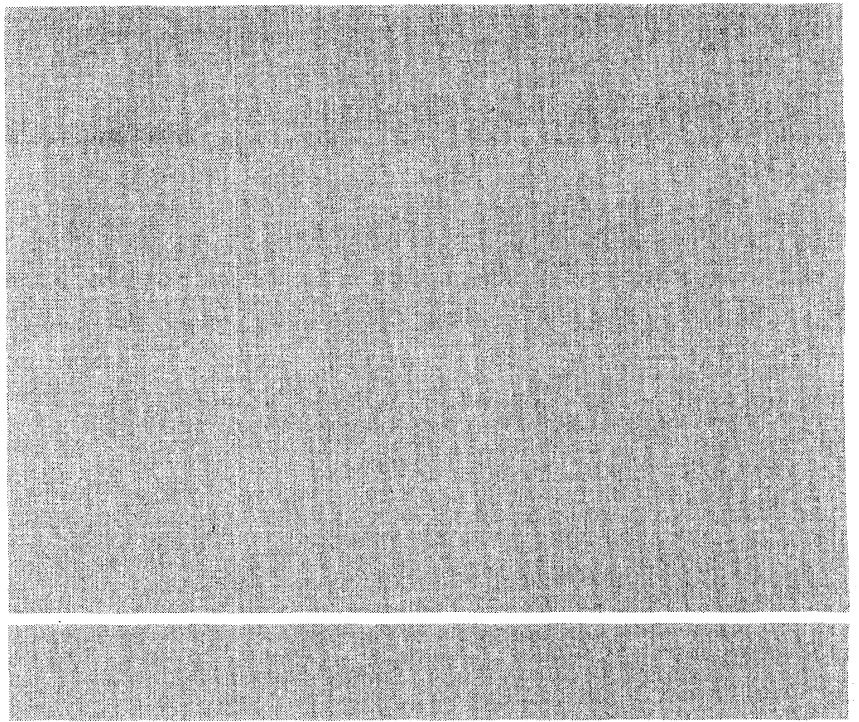

A-5241@-1EX
Printed in Japan
Copyright © 1993 by Icom Inc.

PQQX10444ZA S0193K0

Icom Inc.
6-9-16, Kamihigashi, Hirano-ku, Osaka 547, Japan
