



IC-22S

PLL SYNTHESIZED
2-METER
TRANSCEIVER

INSTRUCTION
MANUAL



TABLE OF CONTENTS

I SPECIFICATIONS	1
II DESCRIPTION	2
III INSTALLATION	3
IV CONTROL FUNCTIONS	7
V OPERATION	8
VI THEORY OF OPERATION	9
VII PARTS LIST	17
VIII VOLTAGE CHARTS	21
IX BLOCK DIAGRAM	27

SECTION I SPECIFICATIONS

GENERAL:

Semiconductor Complement :	Transistors	34
	FET	7
	IC	13
	Diodes	33 to 128 depending on channels
Frequency Range (For Specification)		146 - 148 MHz
Voltage		13.8 VDC Negative Ground
Current Required	TX	2.0 AMP @ 10W 0.9A at 1W
	RX	700 MA at MAX Audio. 400 MA Squelched
Size		58 MM (H) x 156 MM(W) x 218 MM(D)
Weight		1.9 Kilograms
Antenna Impedance		50 OHMS
Number of Channels		23 Channels selected from any of the 132 channels on 15 KHz spacing.
Frequency Control		Stablized Master oscillator PLL programmed by diode matrix.

TRANSMITTER:

Power Out	10 Watts or 1 Watt, Selectable
Modulation Width	5 KHz
Microphone Impedance	500 OHMS
Spurious Level	Lower Than - 60DB Below carrier

RECEIVER:

Modulation Acceptance	16F3
Type	Double Superhet, 1st I. F. 10.7 MHZ, 2nd I.F. 455 kHz
Receiver Sensitivity	4DB Below 1 UV or Lower (0.4 micro)
1 Microvolt S+N/N	30 DB or Better S+N/N
Spurious Response	60 DB or More Attenuation
Bandpass	+/-7.5 KHz/-6DB, +/-15 KHz/-60DB
Squelch Sensitivity	-8 DB Below 1 Microvolt
Audio Output	1.5 watts or more into 8 OHMS.

SECTION II DESCRIPTION

This transceiver is extremely rugged and completely solid state. State of the art devices such as Integrated Circuits, Field Effect Transistors, Varactor and Zener diodes are engineered into a tight-knit straightforward electronic design throughout both transmitter and receiver. Reliability, low current demand, unexcelled performance and ease of operation are the net result.

The dual conversion receiver with its FET front end and high-Q helicalized cavity resonators boasts low noise and sensitivity of 0.4 V or less. Signal gain of 90-db or more is accomplished from the second mixer back by virtue of a 6-stage IF amplifier. The need for additional front end RF amplification is thus eliminated. Zener-regulated PLL controlled first and crystal-controlled second local oscillators produce very good stability. Audio reproduction is of an unusually high order of distortion free clarity.

The transmitter section will produce a minimum of 10 watts RF output. Again, a phase locked loop is employed for initial frequency stability. Twenty two (22) channels are provided for operating convenience and versatility. High-Q stages provide minimum interstage spurious response. A low pass filter is placed at the output to further insure undesirable frequency products not being emitted. Final PA transistor protection circuit is incorporated in the final circuitry. A new design heat radiator is employed to increase final amplifier reliability.

All circuitry is constructed on three printed circuit boards which are easily accessible for servicing. The printed circuit boards are housed in a sturdy frame which is, in turn, housed in a rigid metal case providing an extremely durable and rugged unit. Care has been taken to filter and regulate internal DC voltages. A DC input filter is provided to eliminate alternator or generator "whine" generated in the vehicle environment. Test points are brought up from all major circuits to facilitate maintenance checks and trouble shooting should the necessity arise.

Each unit comes complete with built-in speaker, a high quality dynamic microphone, mobile mounting bracket, microphone clip, DC cabling and plug, external speaker plug, and operating manual. A modern styled face plate, large S meter, small size and low profile design complete the unit's styling. A welcome addition to a dashboard or fixed station.

SECTION III INSTALLATION

Unpacking:

Carefully remove your transceiver from the packing carton and examine it for signs of shipping damage. Should any shipping damage be apparent, notify the delivering carrier or dealer immediately, stating the full extent of the damage. It is recommended you keep the shipping cartons. In the event storage, moving, or reshipment becomes necessary, they come in handy. Accessory hardware, cables, etc., are packed with the transceiver. Make sure you have not overlooked anything.

Location:

Where you place the transceiver in your automobile is not critical and should be governed by convenience and accessibility. Since the unit is so compact, many mobile possibilities present themselves. In general, the mobile mounting bracket will provide you with some guide as to placement. Any place where it can be mounted with metal screws, bolts, or pop-rivets will work. For fixed station use, a power supply should be designed to produce 3 amps for the transceiver.

Power Requirements:

The transceiver is supplied ready to operate from any regulated 13.5 VDC, 2.5 ampere negative ground source. An automobile 12 volt, negative ground, system is usually more than adequate. Some note must be taken, however, of the condition of the vehicle's electrical system. Items such as low battery, worn generator/alternator, poor voltage regulator, etc., will impair operation of your transceiver as well as the vehicle. High noise generation or low voltage delivery can be traced to these deficiencies. If an AC power supply other than the matching supply is used with your transceiver, make certain it is adequately regulated for both voltage and current. Low voltage while under load will not produce satisfactory results from your transceiver. Receiver gain and transmitter output will be greatly impaired. Caution against catastrophic failure of the power supply should be observed.

CAUTION: Excessive Voltage (above 15VDC) will cause damage to your transceiver. Be sure to check the source voltage before plugging in the power cord.

Included with your transceiver is a DC power cable with plug attached. The Red Wire is positive (+), the Black, negative (-). If your mobile installation permits, it is best to connect these directly to the battery terminals. This arrangement eliminates random noise and transient spikes sometimes found springing from automotive accessory wiring. If such an arrangement is not possible, then any convenient B+ lead in the interior of the vehicle and the negative frame can be utilized. Your transceiver provides an internal DC filter that will take out a large amount of transient difficulties anyway. Remember, the unit operates on a negative ground system only—it cannot be used in a positive ground automobile. After making your connections, simply insert the plug into your transceiver. When your transceiver is mated with its matching AC power supply, the power cable from the IC-3PA is simply plugged in the same receptacle in the transceiver and the AC line cord into any convenient wall receptacle.

Antenna:

The most important single item that will influence the performance of any communication system is the antenna. For that reason, a good, high-quality, gain antenna of 50 Ohms impedance is recommended, fixed or mobile. In VHF as well as the low bands, every watt of ERP makes some difference. Therefore, 10 watts average output plus 3 db of gain antenna equals 20 watts ERP, presuming low VSWR of course. The few more dollars invested in a gain type antenna is well worth it. When adjusting your antenna, whether mobile or fixed, by all means follow the manufacturer's instructions. There are some pitfalls to be aware of. For example, do not attempt to adjust an antenna for lowest VSWR when using a diode VSWR meter not engineered for VHF applications. Such readings will invariably have error of 40% or more. Rather, use an in line watt meter similar to the Drake WV-4, Bird Model 43 or Sierra Model 164B with VHF cartridge. Further, when adjusting a mobile antenna, do so with the motor running preferably above normal idling speed. This will insure proper voltage level to the transceiver.

The RF coaxial connector on the rear chassis mates with a standard PL-259 connector. Some models may have metric thread. In any event, the RF connector will mate with almost any PL-259 connector if care is taken to seat them properly.

Microphone:

A high quality dynamic microphone is supplied with your transceiver. Merely plug it into the proper receptacle on the front panel. Should you wish to use a different microphone, make certain it is of the high impedance type; at least 500 ohms or better. Particular care should be exercised in wiring also, as the internal electronic switching system is dependent upon it. See the schematic for the proper hook up. Under no circumstances use a "gain pre-amp" type microphone. The audio system in your transceiver is more than adequate and additional preamplification unnecessary. To use this class of microphone is to invite distortion.

Synthesizer Programming :

Your transceiver does not need crystals to set the frequency. It has 22 channels selected by the channel selector switch. In addition, the channel selected has three options of how the offset is handled: receive and transmit on the programmed frequency (SPX), receive 600 kHz higher than the programmed frequency (DPX A), and transmit 600 kHz above the programmed frequency (DPX B). The programming is done on the diode matrix board by soldering computer grade diodes into the boards in the locations indicated on the diode matrix diagram. Please refer to the chart on pages 22~24 for the locations.

CAUTION:

DO NOT USE A SOLDERING IRON OF MORE THAN 40 WATTS ON THE MATRIX

The matrix board may be removed by taking out the hold-down screw at the end of the board and pulling gently straight up on the other end to disconnect the matrix from the connector. The numbers 1 through 22 indicate the channel number to be programmed and the numbers D-0 through D-7 indicate the position in which the diode is to be placed corresponding to the insert positions on the Frequency vs Matrix Chart. Insert the diode into the line for the desired channel with the cathode pointing UP. The cathode lead is bent down to go through the board to connect to the other side. After the diodes have been inserted for the channel, turn the board over carefully so as to not have the diodes fall out and solder each of the leads with a small tip, low wattage soldering iron. Clip end diode lead off as close to the board as possible. Replace the board on its connector and replace the screw in the end.

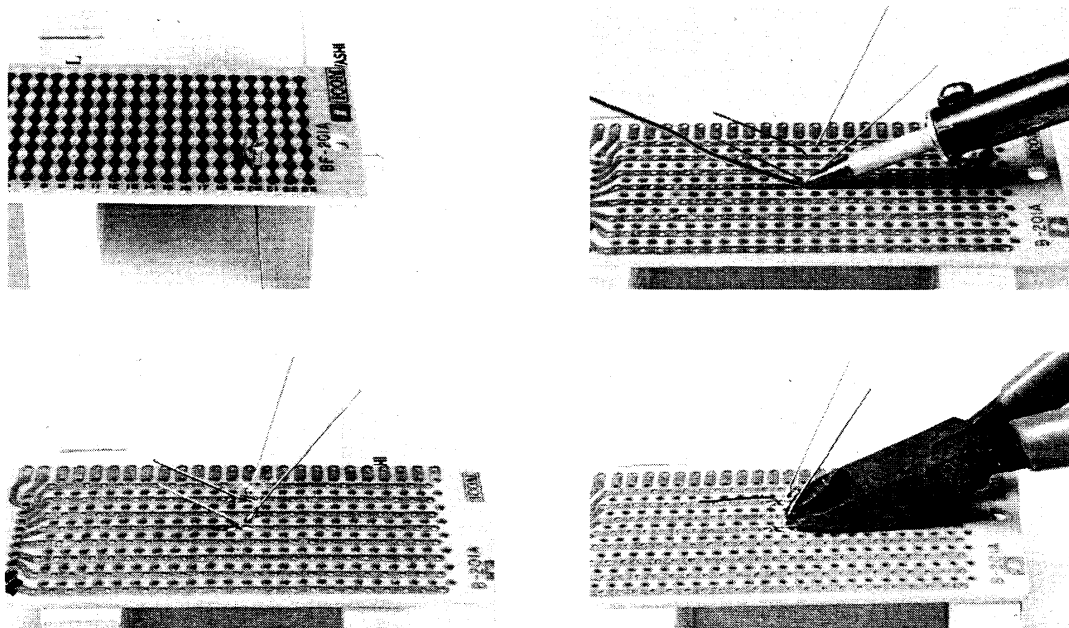

External Speaker:

An external speaker jack and plug is supplied with your unit in the event another speaker is desirable. The external speaker impedance should be 8 ohms. The use of the external speaker jack will disable the internal speaker. An 8 ohm headset can be utilized as well. (See Fig. 2B)

FRONT VIEW

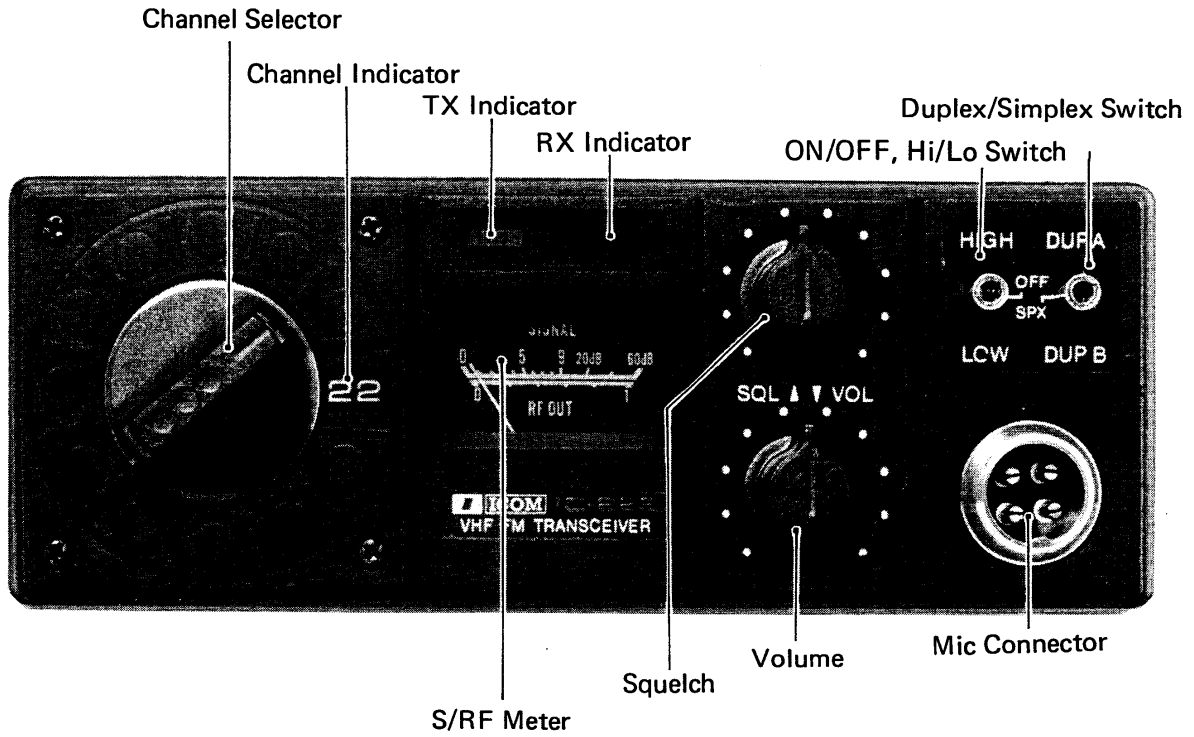

BACK VIEW

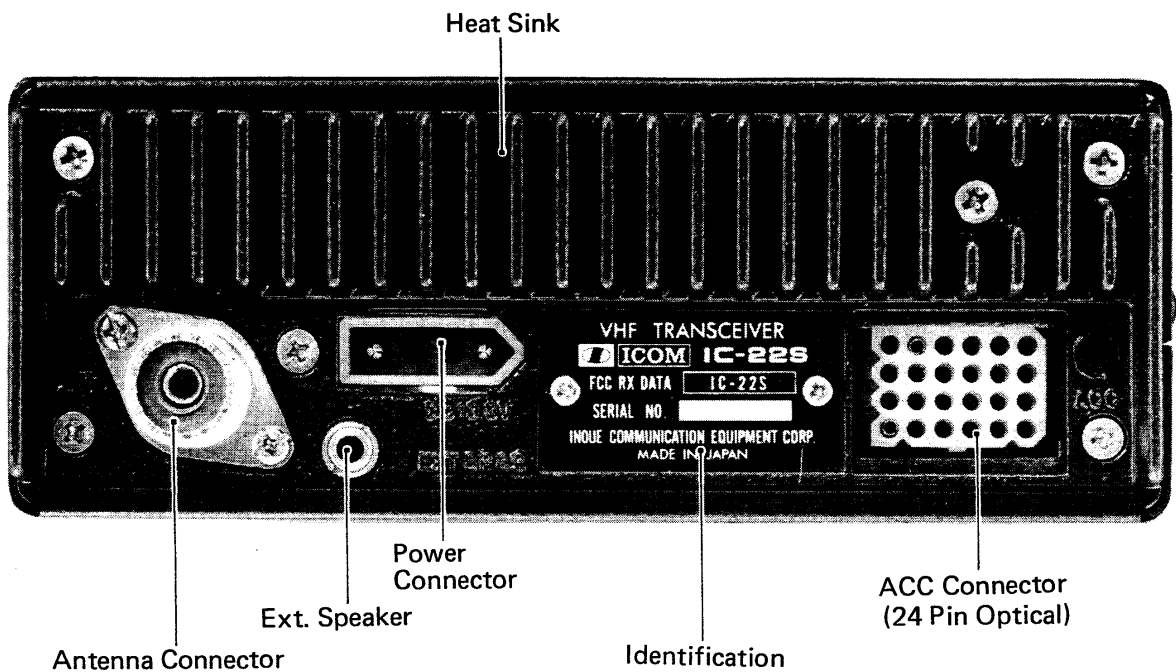

SECTION IV CONTROL FUNCTIONS

Front Control and Jacks (Fig. 2A)

High-Off-Low Switch: Opens or closes the 12 VDC source voltage to the transceiver. "In High" position, output power is 10 watts. "In Low" position, output power is 1 watt.

DPXA – SPX – DPXB: This determines whether the transceiver transmits or receives on the program frequency, or +600KHz above the program frequency.

Volume Control: Controls audio output level of the receiver.

Squelch Control: Controls the squelch threshold point of the receiver.

Microphone Jack: Accepts 4 prong mike plug supplied on microphone.

S–RF Meter: Reads S signal strength in receive mode and relative RF output in transmit mode. The meter face is illuminated with a white lamp when the transceiver is switched on.

Channel Selector: Selects one of 22 channels.

C.O.S. lamp. (Also shows out of lock in transmit.)

Transmit Indicator

Rear Panel 4.2.1FR Output Jack: Accepts standard PL-259 coaxial connector.

Note: Some transceivers may come with a metric threaded connector. Most PL-259 connectors will mate satisfactorily if care is taken to seat them properly. If you have difficulty, try a different make of PL-259.

External Speaker Jack: This jack mates with the plug supplied for external 8 ohm speaker or headset use. The use of this jack mutes the internal speaker.

Power Cord: Mates with DC cord plug or power cord of IC-3P AC power supply.

Identification Plate: States model, serial number.

Accessory Socket: Center Meter, etc., can be connected with 9 Pin plug.

SECTION V OPERATION

Initial Preparations:

Connect the microphone to the microphone jack.

Connect the antenna to the antenna coax connector. Make sure the coax line is of the correct impedance (50 ohms) and is neither shorted nor open.

Make sure the function switch is in the off position, then connect the power supply cord to the power supply jack. The red lead should be connected to the positive side of the power source and the black lead to the negative side. In the event that these leads are improperly connected, the transceiver will not function. No damage will be, however, incurred since protection is provided in the P.A. for this purpose.

Turn the volume and squelch controls to the maximum counter-clockwise position.

Operation:

When the function switch is set to either the high or low position the set is switched on and the channel indicator window and meter will be illuminated.

Switch the channel selector to the desired channel.

Choose the proper DPX offset setting, or SPX for simplex operation.

Reception:

Adjust the volume control to a comfortable listening level of noise, if no signal is present.

Carefully adjust the squelch control clockwise until the noise just disappears. This is the proper squelch threshold setting and must be done when no signal is present. Your transceiver will now remain silent until an in-coming signal is received which opens the squelch. If the squelch is unstable due to the reception of weak or stations, adjust the squelch control further until the proper threshold is obtained.

The S meter indicates the signal strength of the incoming stations and is calibrated in S units, and db over S9. The light illuminating the meter acts also as lock indicator for the PCC.

Transmitting:

Push the PTT (push to talk) button on the microphone and the transceiver will transmit. At the same time the TX indicator will be illuminated red and the meter will provide an indication of relative power output of the transmitter. The pointer will be on or near the red mark on the meter scale when on high power and just a little over 1 on low power.

Hold the microphone about three inches from your mouth and speak in a normal voice. The microphone is of the dynamic type and provides good pickup for all levels of voice.

To receive again, just release the PTT button. This will also switch off the light.

SECTION VI THEORY OF OPERATION

TRANSMITTER:

Microphone, pre-amplifier circuit

The pre-amplifier circuit is composed of Q30, Q29, in an NPN, PNP direct-coupled 2-stage amplifier configuration. The low noise transistors used and application of a large amount of feedback in the 1st stage gives a high signal-to-noise ratio and high stability.

Since DC voltage is supplied through R139 to the microphone connector, the ICSM2 (electrolytic condenser microphone) can be used also. C166, R140, C165 constituting a which filter suppress high frequency regeneration and C163 provided between base and emitter of the 1st stage transistor prevents oscillation due to regeneration.

Pre-amplifier output is through R132 to the microphone circuit.

IDC circuit (Instantaneous Deviation Control.)

Passing of signals through narrow band filter stage can result in distortion if the signal is overmodulated and consequent degrading of following channels. To give improved limiting characteristics Q28, Q27, Q26, are connected in a 3-stage direct-coupled configuration which results in less distortion and protects succeeding stages from the effects of excessive input.

Since feedback is supplied to the 3-stage d.c. circuit and the input impedance is low, the frequency characteristic of the differentiation by R130 and C159 is improved. R124 through which the feedback circuit connects to ground serves for adjusting the operating point of Q26 and insuring symmetry of clipped waveforms. D18 and D19 are temperature compensating elements for the 3-stage d.c. circuit.

The limiter output is close to square waves in form, and since it includes harmonics an active filter is provided to eliminate anything over 3 kHz. To prevent the frequency deviation from becoming too large as temperature increases, compensation is made by thermistor R113, after which adjustment is made by R112 to narrow the frequency deviation range.

Frequency modulation, 10.7 MHz oscillator

Because of the quartz crystal characteristics in the frequency modulator Q24, a non-controlled VXO configuration, the variations circuit is tolerant of temperature variations, and there is less drift. Output signals from the IDC circuit are supplied to the anode of varicap diode D17. To improve the temperature characteristics, temperature compensation is effected by thermistor R106 connected to the cathode of D17. The signal is set to 10.7 MHz by L41 connected to the cathode of D17.

Transmission mixer

IC3 includes a constant current circuit and differential amplifier. L39 provides balanced output from the 10.7 MHz oscillator and drives the two inputs of the differential amplifier. Local oscillator output enters via the constant current input and differential amplifier output is filtered by L36, opposite phase components of the 10.7 MHz output and local oscillator cancel, and so signals obtained at the secondary side of L36 are LO+/- 10.7 MHz. The required LO+10.7 MHz signals are obtained from the Band Pass Filter following L36.

Interstage amplifier

BPF output is amplified up to about 2 mW in the Q22 stage which is a MOSEFT with good linearity.

Low level amplifier

Interstage amplifier output is amplified to about 100 mW by stage Q19, which also functions as an ALC circuit.

Driver stage

Low level output is amplified to approximately 1.6 W by Q18.

ALC Circuit

Spurious signals, which might occur when voltage is reduced or when the degree of excitation is low, are prevented by a small amount of forward bias applied by bias circuit D14.

Part of this output is brought up to excitation level in the threshold type voltage-doubling rectifying circuit constituted by D19, D29. When ALC is not applied, the self-bias of Q15 causes Q16 to conduct. When ALC is applied, both Q15 and Q16 are close to cut-off, collector voltage of Q19 falls, and the excitation level is lowered.

ALC is effective for both high power and low modes. For high power, the threshold level is controlled by R73, and for low power, the threshold is set by R149.

Power amplification

Output is amplified by Q17 to give an output of 10W, including low pass filter losses. Since power handled in this stage is particularly high, use is made of an aluminum die-cast radiator which is in direct contact with the rear chassis and serves to keep the transistor temperature low in order to insure reliability. A padding mica trimmer which has an excellent temperature characteristic and causes little induction loss is also employed.

Low pass filter, SWR detector

Power amplifier output includes harmonic components and in passing through 2 Chebyshev section and one standard section in order to get to the ANT terminal, harmonic components are attenuated by about 70 dB. Cut-off frequency of this low-pass filter is set to about 180MHz, and so there is very little loss in the 146-148 MHz band.

SWR

D10, D11 constitute an SWR detector. The closer it is to the ANT terminal the better the detector functions, but because of diode rectification, harmonics are produced. An excellent compromise is therefore made by inserting the detector between the low-pass filters. Standing waves which pass through the SWR detector are rectified by D11 and supplied to the RF meter. Indication of the RF meter for proper high power output is set to 4/5 of full-scale by R156.

APC circuit

Reflected waves are rectified by D10 and then amplified by Q20, Q21 up to the level set by R89. By raising Q22 source voltage, excitation level is lowered, and damage to the power amplifier transistor due to mismatch is prevented.

RECEIVER

R.F. Amplifier

Antenna input or self contained antenna signals pass through switching diode D-40 located in the PA section to the RF amplifier Q2 where it is amplified and passed to the R.F. filter section. Out-of-band signals are attenuated by the band pass filters.

Mixer Filter

The amplifier signal is injected into Gate-1 of the mixer Q-3. The LO frequency is also applied to Q3 where a resultant 10.7 MHz IF signal is derived. This signal is passed through a crystal BP filter which greatly attenuates other in-band signals. The 10.7 MHz signal is again mixed with a second LO, Q8 operating at 11.155 MHz at mixer 2, Q4. The resulting mixer output is 455 kHz.

I. F. Amplifiers

Two ceramic filters provide the low frequency selectivity and the adjacent channel rejection needed in today's crowded repeater world. I.F. amplifiers Q5 and Q7 drive IC-1 limiter. The signal is detected by the ceramic discriminator.

Audio

Lower frequency audio components (300 Hz to 3 kHz) are amplified by Q-10 and passed by Q-11 active filter. These (desired) audio signals are adjusted to level by the volume control and amplified to 1 watt power by IC-2.

Squelch

At point J-5, higher frequency discriminator noise is taken at a selected level by R-1 Squelch Control back via J-4 and amplified by Q-4 and Q-5, rectified by D-32 and applied to Q9 base. Under no-signal conditions, when noise is high, this rectified voltage is high, and Q9 turns off Q10. The reverse is true when a signal is of sufficient strength to reduce noise and the squelch opens permitting the audio signal path to operate normally.

During transmit, positive voltage is fed to the Q9 base, silencing the audio system. After switching back to receive, a delay in Q9 base voltage change provided by C-56 allows a silent transition.

PHASE LOCKED LOOP

Voltage controlled oscillator

Use of a clap oscillator in the form of a junction FET in Q8 gives an improved signal-to-noise, and by use of other elements having excellent temperature characteristics, frequency stability of the order of ± 50 ppm/C is achieved.

Varicap diode D3 serves to broaden the range of frequency permitted and by contributing to the linearity improves stability of the circuit as a whole.

Buffer amplifier

In Q5, a MOSEFT using very little feedback minimizes the effects of load variation, and the necessary LO output of 400 mV of the main unit is obtained.

Local oscillator

The overtone oscillator in Q7 is provided to reduce spurious signals resulting from multiplication of the fundamental oscillator. L6 is provided in series with the crystal to facilitate frequency adjustment. L5, which is connected to the collector, is tuned to a frequency which is three (3) times the overtone oscillator output, giving a frequency of 131.70 MHz.

Frequency converter

Balanced mixer IC4 is a voltage regulator and a differential amplifier. A portion of the buffer amplifier output is fed to the voltage regulator portion of IC4 and input to the differential amplifier is the local oscillator output. This is fed through L3 to balance the transformation of pulses. Using this frequency conversion technique employing the 131.7 MHz signal insures the elimination of spurious signals in the PLL output.

Low pass filter

The Heterodyning process in various frequencies being present at the output of IC4, but the LPF passes only the frequencies of 6 MHz or lower.

Limiting amplifier

Since the level of the LPF output is small, a broad band amplifier IC5 consisting of 3 differential amplifier stages is provided to amplify these signals. The interface with the divide by two circuit is transistor Q6.

Divide by two

Since maximum operating frequency of ICI is low, $\frac{1}{2}$ of IC6, whose operating frequency is high, divides the Q6 output frequency by 2, to give signals of approximately 3 MHz or less which are supplied to the programmable divider.

Programmable divider

ICI divides the IC6 output using a frequency division ratio determined by the program set by the diode matrix.

This IC operates in binary and the maximum dividing ratio is 255. Because of this circuit's action, lock is not released when VCO free-running oscillations are at the upper frequency limit. At the low frequency limit, lock-up is terminated when the frequency of the VCO is lower than a value equal to the local oscillator frequency plus N times the reference frequencies. When power is connected, the transient voltage of the differentiating circuit defined by C24, R12 is passed through D2, and potential at the varicap diode temporarily goes to a high value. As this voltage falls, and the value set by the programmable divider N is entered, D2 is reverse-biased, and in normal conditions is off. By putting D4 in parallel to R12 the charge on C4 is discharged quickly when power is switched off, and when power is connected again the lock circuit is reset.

Diode Matrix

This is a binary code, read only memory, defining a frequency as a binary number. This matrix determines the frequency dividing ratio (N) to be employed by the programmable divider in order to obtain the frequency required in response to activation of each of the 22 switch positions.

See diode matrix charts

Reference oscillator divider

IC3 is an IC used to produce the reference frequency for the synthesizer, and includes a quartz crystal oscillator and a 12-stage high speed divider. The oscillator produces 7.8MHz oscillations which the high-speed divider section divides by 1024 to give the 7.5 kHz reference pulses.

Phase detection loop filter

IC2 is a phase detector for the frequency synthesizer and is made up of a digital phase comparator and an amplifier for the active low-pass filter. Reference pulses from IC3 are supplied to IC2 Pin 7 and divided pulses from IC1 to IC2 Pin 8, and the digital phase comparator produces output which is proportional to the difference in phase of these inputs, and is taken out at IC2 Pin 3. Damping factor of this output is set at 0.6. Lock-up time is set to 50 msec, 25% overshoot by a lag-lead filter consisting of R9, R10, R8, C10 and the filter amplifier in IC2.

If the divider output frequency becomes higher than the reference frequency, output voltage of the lag-lead filter becomes low and the VCO frequency is lowered. When the divider output frequency becomes low, circuit action is the reverse, and the VCO synchronizes the output with the reference frequency.

Lock indication circuit, transmission termination circuit

At IC2 Pin 4 there is a pulse output which is equal to VCC of Pin 5 when reference pulses and divider output have the same frequency. When these inputs to IC2 are not phase locked they have a width proportional to the phase difference of the inputs. Pin 4 output pulses are integrated by R7, C8, and when the integrated value obtained exceeds the junction potential of Q4, Q4 conducts and Q1 of the next stage also is turned on.

Transmission is terminated when current flowing through D1 connected to the Q1 collector causes base voltage of main unit Q32 to be lowered and the lock is released. As the transmit 9V supply comes down, the signal lamp lights during transmission to indicate that lock-up is no longer in effect. When Q2 base bias disappears, the meter lamp goes out both for transmit and receive and, together with the signal lamp, indicates that lock is not present.

Ripple filter

The ripple filter, Q3, acts to further smooth the 9V supply and so protect the VCO phase comparator and loop filter against voltage variations and improve stability.

Lock start circuit

When PLL lock is applied, the upper frequency limit is determined mainly by the operating frequency of the divider $\frac{1}{2}$ IC6, and the VCO filter L7 is set so that oscillation is at this upper limit when loop filter output is at maximum.

LO switching circuit

1st LO output from PLL is supplied to J1 and J2. While receiving, forward bias passes through R10, L43, R155, and flows through D15. D15 is switched on so the 1st LO is directed to L43.

Similarly, during transmit, forward current passes through R96, R155, flows through in D16, which is switched on and 1st LO is supplied to IC3.

INSIDE VIEW (TOP)

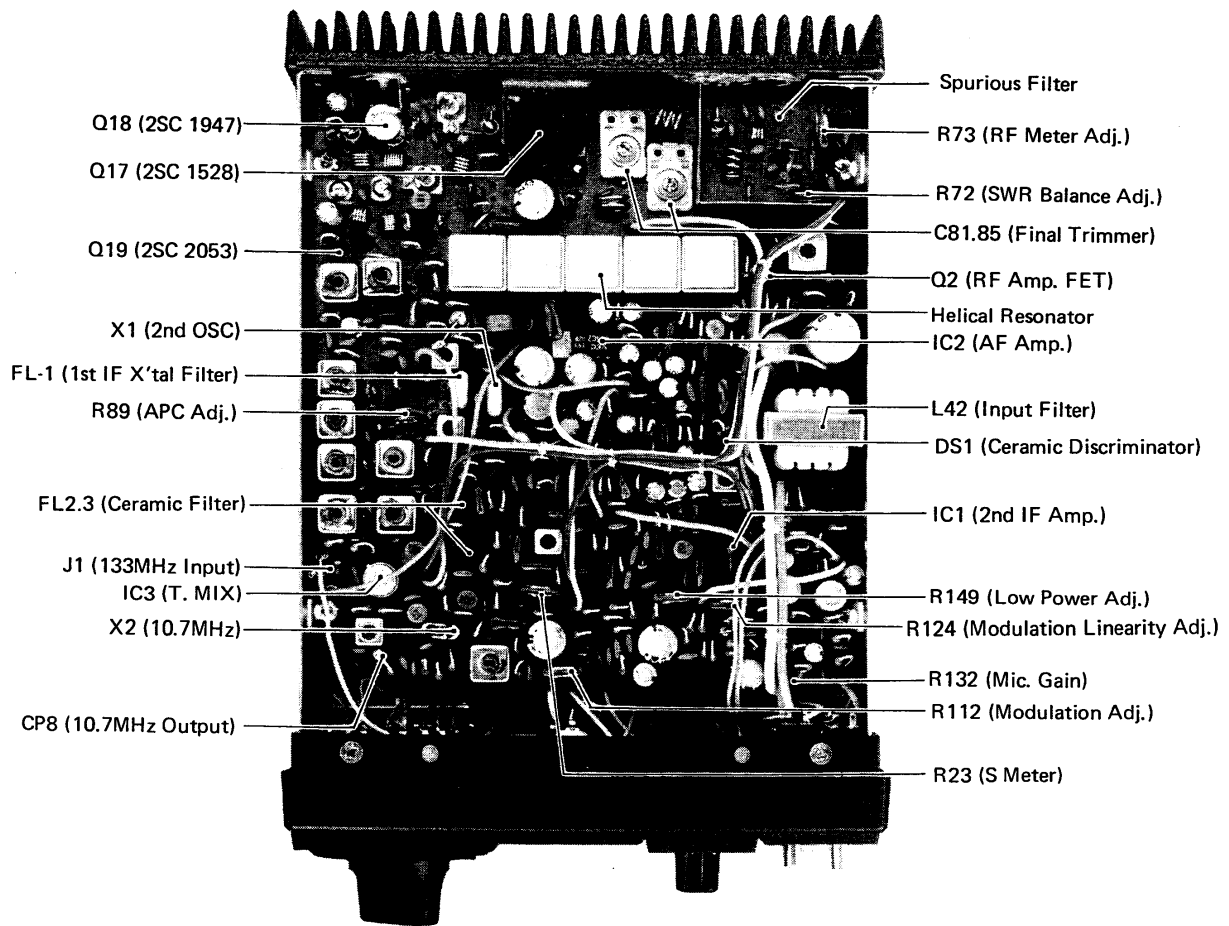

INSIDE VIEW (BOTTOM)

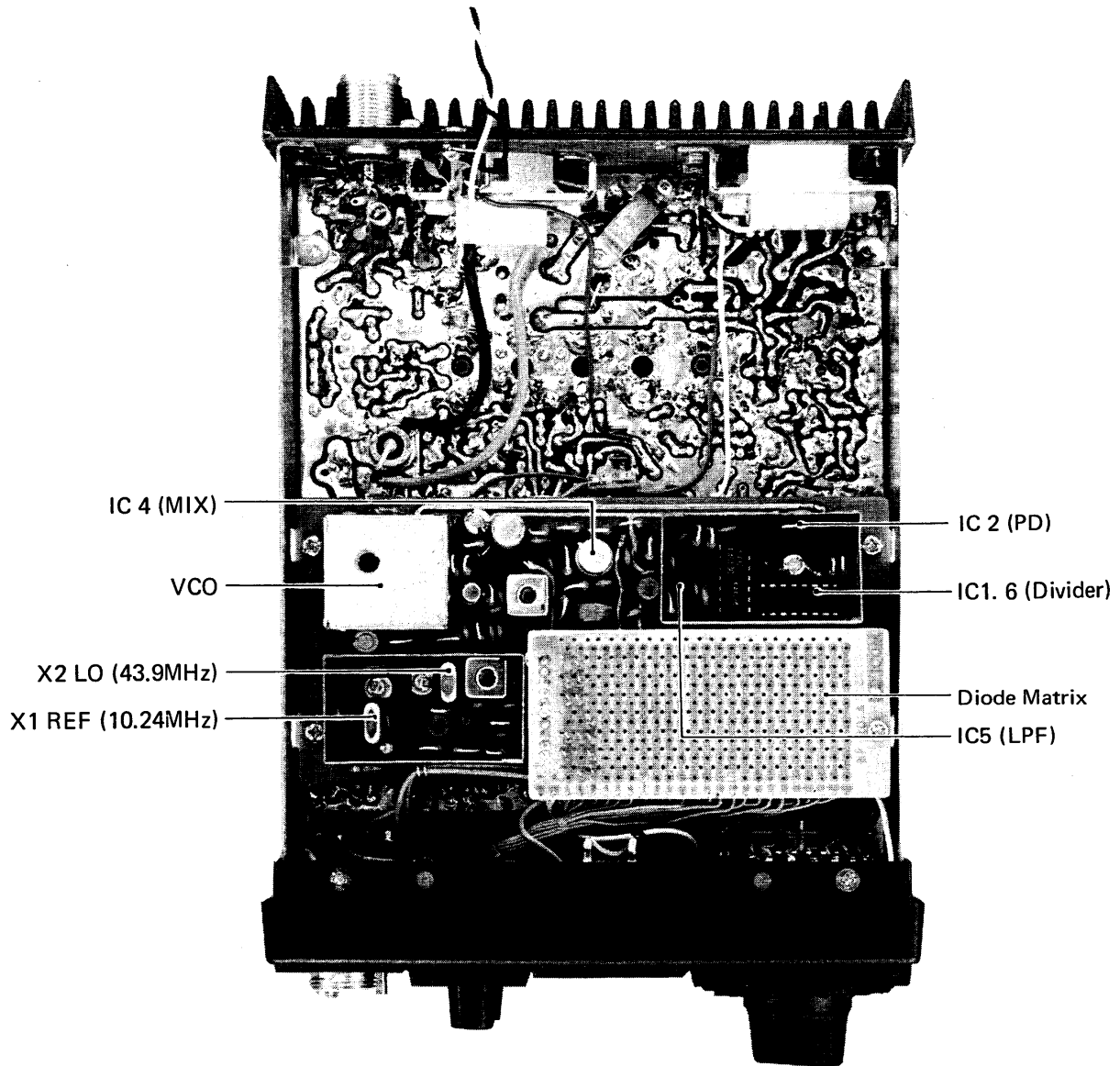

Power supply

Reverse connection protection circuit

If power with the wrong polarity is applied, D28 is forward biased and there is therefore a large current flow which blows the fuse provided on the external lead, preventing damage to circuit elements.

Power supply circuit, stand-by circuit

The constant 9 V supply appears as regulated voltage at the anode of D20 due to the action of the clamp circuit of R142, D20, and zener diode D21. This voltage is sent by the emitter-follower circuit Q31 and supplied to the PLL, IDC circuit, reception AF circuit, and the low pass filter group.

Similarly, 9 V for reception is taken from the clamp circuit of R147, D27, and D21 by Q34 in an emitter-follower configuration. This voltage is supplied to the RF, IF, 2nd LO and noise amplification circuits.

The 9 V for transmit is similarly taken from emitter-follower circuit Q32 from the clamp circuit constituted by R143, D22, D21, and is supplied to the IDC, 10.7 MHz oscillator, transmission mixer, inter-stage amplifier, and bias circuits.

The 13.8 V supply is supplied to the ALC DC amplifier, exciting amplifier, power amplifier, and IC2.

In the stand-by mode, when the PTT switch is switched off, D24 and D26 are both non-conductive and +9 V for reception is obtained. Since D25 also is switched off, Q33 conducts due to bias established by R145. The base of Q32 is connected to ground through D3, and transmit voltage ceases.

When the PTT switch is switched on, the base of Q34 is connected to ground through D26 and the 9 V receive supply dies. D24 connected to the emitter of Q34 is used for effecting rapid discharge of the electrolytic condenser connected to the 9 V receive supply line. Q33 becomes non-conductive since its base is connected to ground through D25, and 9 V for transmit is obtained.

SECTION VII PARTS LIST

MAIN		
IC1	IC	upc577H
IC2	IC	upc575CZ
IC3	IC	TA7045M
Q1	Transistor	2SA639
Q2	FET	3SK40M
Q3	FET	3SK40M
Q4	FET	2SK49H2
Q5	Transistor	2SC945P
Q6	Transistor	2SC945P
Q7	Transistor	2SC945P
Q8	Transistor	2SC1571G
Q9	Transistor	2SC945P
Q10	Transistor	2SC1571G
Q11	Transistor	2SC945P
Q12	Transistor	2SC945P
Q13	Transistor	2SC945P
Q14	Transistor	2SC945P
Q15	FET	2SK44D
Q16	Transistor	JA1050
Q17	Transistor	2SC1528
Q18	Transistor	2SC1947
Q19	Transistor	2SC2053
Q20	Transistor	2SC945P
Q21	Transistor	JA1050
Q22	FET	3SK40M
Q23	—	—
Q24	Transistor	2SC945P
Q25	Transistor	2SC945P
Q26	Transistor	2SC945R
Q27	Transistor	2SC945R
Q28	Transistor	2SC1571G
Q29	Transistor	JA1050
Q30	Transistor	2SC1571G
Q31	Transistor	JA1600G
Q32	Transistor	JA1600G
Q33	Transistor	2SC945P
Q34	Transistor	JA1600G
D1	Diode	1SS55
D2	Diode	1SS55
D3	Diode	1S2473
D4	Diode	IN60
D5	Diode	IN60
D6	Diode	IN60
D7	Diode	IN60
D8	Diode	IN60
D9	Diode	1S1555
D10	Diode	IN60
D11	Diode	IN60
D12	Diode	1S2473
D13	Diode	1SS53
D14	Diode	1S1555
D15	Diode	1SS53
D16	Diode	1SS53
D17	Vari Cap	1S2688C

D18	Diode	IN60
D19	Diode	IN60
D20	Diode	1SS53
D21	Diode	XZ096
D22	Diode	1SS53
D23	Diode	1SS53
D24	Diode	1SS53
D25	Diode	1SS53
D26	Diode	1SS53
D27	Diode	1SS53
D28	Diode	SR 10N-2R
D29	Diode	1S2473
D30	Diode	1SS53
R23	Trimmer	3K FR-10
R71	Thermistor	33D28
R89	Trimmer	100K FR-10
R106	Thermistor	23D29
R113	Thermistor	33D28
R132	Trimmer	5K FR-10
C1	Ceramic	0.01 50V
C2	Ceramic	0.001 50V
C3	Ceramic	0.001 50V
C4	DIP	10P 50V
C5	Ceramic	0.01 50V
C6	Ceramic	0.001 50V
C7	Ceramic	0.01 50V
C8	Ceramic	0.01 50V
C9	Ceramic	0.01 50V
C10	Ceramic	0.01 50V
C11	Ceramic	0.01 50V
C12	Ceramic	0.01 50V
C13	Milar	0.039 50V
C14	Ceramic	2P 50V
C15	Milar	0.039 50V
C16	Milar	0.01 50V
C17	Milar	0.039 50V
C18	Milar	0.039 50V
C19	Milar	0.039 50V
C20	Milar	0.01 50V
C21	Chemicon	10u 16V
C22	Milar	0.01 50V
C23	Milar	0.01 50V
C24	Milar	0.056 50V
C25	Milar	0.056 50V
C26	Milar	0.01 50V
C27	Milar	0.01 50V
C28	Milar	0.01 50V
C29	Milar	0.001 50V
C30	Chemicon	10u 16V
C31	Milar	0.056 50V
C32	Milar	0.056 50V
C33	Milar	0.056 50V
C34	Milar	0.056 50V
C35	Milar	0.002 50V
C36	Milar	0.056 50V
C37	Chemicon	4.7u 25V

C38	Milar	0.01 50V
C39	Milar	0.001 50V
C40	Milar	0.056 50V
C41	Chemicon	0.47 μ 50V
C42	Milar	0.02 50V
C43	Chemicon	10 μ 16V
C44	Chemicon	0.47 50V
C45	Ceramic	0.01 50V
C46	Ceramic	30P 50V
C47	Stycon	100P 50V
C48	Stycon	200P 50V
C49	Chemicon	10 μ 16V
C50	Milar	0.01 50V
C51	Ceramic	100P 50V
C52	Milar	0.01 50V
C53	Chemicon	0.447 50V
C54	Milar	0.003 50V
C55	Chemicon	3.3 μ 35V
C56	Chemicon	3.3 μ 35V
C57	Chemicon	3.3 μ 35V
C58	Chemicon	10 μ 16V
C59	Milar	0.039 50V
C60	Chemicon	4.7 μ 25V
C61	Milar	0.002 50V
C62	Milar	0.039 50V
C63	Milar	0.150V
C64	Milar	0.01 50V
C65	Ceramic	10P 50V
C66	Ceramic	10P 50V
C67	Ceramic	0.01 50V
C68	Chemicon	10 μ 16V
C69	Ceramic	1P 50V
C70	Ceramic	0.01 50V
C71	Ceramic	15P 50V
C72	Ceramic	6P 50V
C73	Ceramic	30P 50V
C74	Ceramic	2P 50V
C75	Ceramic	20P 50V
C76	Ceramic	0.001 50V
C77	Ceramic	0.01 50V
C78	Ceramic	0.001 50V
C79	Milar	0.150V
C80	Ceramic	0.01 50V
C81	Trimmer	70P type-C
C82	Ceramic	40P 50V
C83	Chemicon	220 μ 16V
C84	Ceramic	0.01 50V
C85	Trimmer	70P type-C
C86	Ceramic	10P 50V
C87	Ceramic	0.001 50V
C88	Ceramic	10P 50V
C89	Ceramic	10P 50V
C90	Ceramic	68P 50V
C91	Trimmer	20P CVC20-11
C92	Trimmer	20P CVC20-11
C93	Ceramic	0.001 50V
C94	Ceramic	0.01 50V
C95	Chemicon	4.7 μ 25V

C96	Ceramic	0.01 50V
C97	Trimmer	10P CVO5C-12
C98	Ceramic	5P 50V
C99	Trimmer	10P CVO5C-12
C100	Ceramic	15P 50V
C101	Ceramic	0.001 50V
C102	Ceramic	0.01 50V
C103	Milar	0.1 50V
C104	Chemicon	220 μ 10V
C105	Milar	0.003 50V
C106	Chemicon	47 μ 16V
C107	Chemicon	4.7 μ 25V
C108	Chemicon	4.7 μ 25V
C109	Chemicon	47 μ 16V
C110	Chemicon	33 μ 10V
C111	Chemicon	0.47 μ 50V
C112	Ceramic	500P 50V
C113	Ceramic	0.001 50V
C114	Ceramic	0.01 50V
C115	Ceramic	0.01 50V
C116	Chemicon	10 μ 16V
C117	Ceramic	5P 50V
C118	—	—
C119	Ceramic	0.5P 50V
C120	Ceramic	6P 50V
C121	Ceramic	0.01 50V
C122	Ceramic	0.01 50V
C123	Ceramic	0.001 50V
C124	Ceramic	0.01 50V
C125	Ceramic	0.01 50V
C126	Ceramic	0.01 50V
C127	Ceramic	0.01 50V
C128	Ceramic	4P 50V
C129	Ceramic	0.35P 50V
C130	Ceramic	0.35P 50V
C131	Ceramic	0.35P 50V
C132	Ceramic	0.035P 50V
C133	Ceramic	6P 50V
C134	Ceramic	6P 50V
C135	Ceramic	6P 50V
C136	Ceramic	6P 50V
C137	Ceramic	7P 50V
C138	Ceramic	0.01 50V
C139	Ceramic	6P 50V
C140	Ceramic	0.01 50V
C141	Ceramic	0.01 50V
C142	Ceramic	0.01 50V
C143	Ceramic	0.01 50V
C144	Ceramic	100P 50V
C145	Ceramic	200P 50V
C146	Ceramic	10P 50V
C147	Ceramic	0.01 50V
C148	Milar	0.047 50V
C149	Milar	0.1 50V
C150	Chemicon	220 μ 10V
C151	Milar	0.003 50V
C152	Milar	0.01 50V
C153	Milar	0.01 50V

C154	Ceramic	100P 50V
C155	Chemicon	100u 10V
C156	Chemicon	4.7u 25V
C157	Milar	0.0047 50V
C158	Chemicon	33u 10V
C159	Milar	0.01 50V
C160	Chemicon	100u 10V
C161	Chemicon	4.7u 25V
C162	Chemicon	47u 10V
C163	Milar	0.001 50V
C164	Chemicon	4.7u 25V
C165	Milar	0.001 50V
C166	Milar	0.001 50V
C167	Chemicon	47u 10V
C168	Ceramic	0.01 50V
C169	Ceramic	0.01 50V
V170	Chemicon	10u 16V
C171	Chemicon	470u 16V
C172	Ceramic	0.01 50V
C173	Ceramic	0.04 50V
C175	Ceramic	.01 50V
C176	Ceramic	.001 50V
C177	Ceramic	.01 50V

L1	Coil	LS-4
L2	Coil	LB-1-3A
L3	Coil	LB-1-1
L4	Coil	LB-1-1
L5	Coil	LB-1-1
L6	Coil	LB-1-3A
L7	Coil	LS-81
L8	Coil	LS-79
L9	Coil	LS-20
L10	Coil	102 1mH
L11	Coil	LS-16
L12	Coil	102 1mHL
L13	—	—
L14	Coil	LR-13
L15	Coil	LA-71
L16	Coil	LA-71
L17	Coil	LW-5
L18	—	—
L19	Coil	LA-74
L20	Coil	LA-73
L21	Coil	LW-1
L22	—	—
L23	Coil	LS-2
L24	Coil	LA-31
L25	Coil	LW-1
L26	Coil	LA-71
L27	Coil	LA-96
L28	Coil	LA-71
L29	Coil	LS-73
L30	Coil	LS-73
L31	Coil	LS-73
L32	Coil	LS-73
L33	Coil	LS-73
L34	Coil	LS-73

L35	Coil	LS-73
L36	Coil	LS-73
L37	Coil	101 100uH
L38	Coil	101 100uH
L39	Coil	LS-66A
L40	Coil	120-12uH
L41	Coil	LS-80
L42	Choke Trans	TC-1B
L43	Coil	LA-17
FL1	Filter	10M20A
FL2	Filter	CFU-455E
FL3	Filter	CFU-455E
DISC-1	Ceramic Disc	455D
X1	X'tal	HC/18U 10.24MHz
X2	X'tal	HC/18U 10.703MHz
PC1	Check Point	
PC2	Check Point	
PC3	Check Point	

PLL UNIT		
IC1	IC	TC5080P
IC2	IC	TC5081P
IC3	IC	TC5082P
IC4	IC	TA7045M
IC5	IC	uPC577H
IC6	IC	uPD4013C
IC7	IC	uPD4011C
IC8	IC	uPD4030C
IC9	IC	uPD4011C
IC10	IC	uPD4011C

Q1	Transistor	2SC945-Q
Q2	Transistor	2SC945
Q3	Transistor	2SC945
Q4	Transistor	JA1050
Q5	FET	3SK40-K
Q6	Transistor	2SC945-Q
Q7	Transistor	2SC748-BN
Q8	FET	2SK19-GR
L1	Coil	LS-3A
L2	Choke Coil	L100
L3	Coil	LR-11A
L4	Choke Coil	L100
L5	Coil	LS-3A
L6	Choke Coil	I-W-10
L7	Coil	LS-92
L8	Coil	LW-5
D1	Diode	1SS53
D2	Diode	1SS53
D3	Vari fap	ITT410
D4	Diode	1ss53
D5	Diode	1ss53

X1	X'tal	HC/18U 7.68MHz
X2	X'tal	HC/18U 44.56333MHz
C1	Capacitor	39pF 50V
C2	Trimmer	CVO 18P
C3	Capacitor	51pF 50V
C4	Capacitor	0.01uF 50V
C5	—	—
C6	Capacitor	4,7uP 50V
C7	Capacitor	—
C8	Capacitor	10uF 16V
C9	Capacitor	100uF 10V
C10	Capacitor	1.0047uF 50V
C11	Capacitor	47uF 10V
C12	Capacitor	0.01uF 50V
C13	Capacitor	8pF 50V
C14	Capacitor	0.001uF 50V
C15	Capacitor	0.01uF 50V
C16	Capacitor	0.01uF 50V
C17	Capacitor	0.01uF 50V
C18	Capacitor	0.001uF 50V
C19	Capacitor	0.01uF 50V
C20	Capacitor	0.001uF 50V
C21	Capacitor	0.01uF 50V
C22	Capacitor	0.04uF 50V
C23	Capacitor	0.01uF 50V
C24	Capacitor	33uF 10V
C25	Capacitor	40pF 50V
C26	Capacitor	40pF 50V
C27	Capacitor	0.01uF 50V
C28	Capacitor	0.056uF 50V
C29	Capacitor	0.01uF 50V
C30	Capacitor	0.01uF 50V
C31	Capacitor	00.001uF 50V
C32	Capacitor	0.04uF 50V
C33	Capacitor	2pF 50V
C34	Capacitor	8pF 50V
C35	Capacitor	0.01uF 50V
C36	Capacitor	25pF 50V
C37	Capacitor	50pF 50V
C38	Trimmer	CVO5 18p
C39	Capacitor	10PF 50V
C40	Capacitor	10pF 50V
C41	Capacitor	150pF 50V
C42	Capacitor	0.01uF 50V
C43	Capacitor	30pF 50V
C44	Capacitor	40pF 50V
C45	Capacitor	40pF 50V
C46	Capacitor	40pF 50V
C47	Capacitor	3.3uF 50V
C48	(CAP)	20p 50V
MATRIX UNIT		
D1	Diode	1SS53
J1	Connector	3024-10C

SECTION VIII VOLTAGE CHARTS

No.	INPUT						OUTPUT				
	128 D7	64 D6	32 D5	16 D4	8 D3	DUP- LEX	128 P7	64 P6	32 P5	16 P4	8 P3
0	0	0	0	0	0	1	0	0	1	1	0
1	0	0	0	0	1	1	0	0	1	1	1
2	0	0	0	1	0	1	0	1	0	0	0
3	0	0	0	1	1	1	0	1	0	0	1
4	0	0	1	0	0	1	0	1	0	1	0
5	0	0	1	0	1	1	0	1	0	1	1
6	0	0	1	1	0	1	0	1	1	0	0
7	0	0	1	1	1	1	0	1	1	0	1
8	0	1	0	0	0	1	0	1	1	1	0
9	0	1	0	0	1	1	0	1	1	1	1
10	0	1	0	1	0	1	1	0	0	0	0
11	0	1	0	1	1	1	1	0	0	0	1
12	0	1	1	0	0	1	1	0	0	1	0
13	0	1	1	0	1	1	1	0	0	1	1
14	0	1	1	1	1	1	1	0	1	0	0
15	0	1	1	1	1	1	1	0	1	0	1
16	1	0	0	0	0	1	1	0	1	1	0
17	1	0	0	0	1	1	1	0	1	1	1
18	1	0	0	1	0	1	1	1	0	0	0
19	1	0	0	1	1	1	1	1	0	0	1
20	1	0	1	0	0	1	1	1	0	1	0
21	1	0	1	0	1	1	1	1	0	1	1
22	1	0	1	1	0	1	1	1	1	0	0
23	1	0	1	1	1	1	1	1	1	1	1
24	1	1	0	0	0	1	1	1	1	1	0
25	1	1	0	0	1	1	1	1	1	1	1
26	1	1	0	1	0	1	1	0	0	0	0
27	1	1	0	1	1	1	1	0	0	0	1
28	1	1	1	0	0	1	1	0	0	1	0
29	1	1	1	0	1	1	1	0	0	1	1
30	1	1	1	1	0	1	1	0	1	0	0
31	1	1	1	1	1	1	1	0	1	0	1

In SIMPLEX, the input code is the same as the output code.

Simp-lex	Set Freq. (MHz)	Dup-lex	PII Out Freq. (MHz)	1/M Freq. (MHz)	Total N	DIODE INSERT POSITIONS							
						128 D7	64 D6	32 D5	16 D4	8 D3	4 D2	2 D1	1 D0
1	146.010		135.310	1.620	108		*	*		*	*		
2	146.025		135.325	1.635	109		*	*		*	*		*
3	146.040		135.340	1.650	110		*	*		*	*	*	
4	146.055		135.355	1.665	111		*	*		*	*	*	*
5	146.070		135.370	1.680	112		*	*	*				
6	146.085		135.385	1.695	113		*	*	*				*
7	146.100		135.400	1.710	114		*	*	*			*	
8	146.115		135.415	1.725	115		*	*	*			*	*
9	146.130		135.430	1.740	116		*	*	*		*		
10	146.145		135.445	1.755	117		*	*	*		*	*	
11	146.160		135.460	1.770	118		*	*	*		*	*	
12	146.175		135.475	1.785	119		*	*	*		*	*	*
13	146.190		135.490	1.800	120		*	*	*	*			
14	146.205		135.505	1.815	121		*	*	*	*			*
15	146.220		135.520	1.830	122		*	*	*	*		*	
16	146.235		135.535	1.845	123		*	*	*	*		*	*
17	146.250		135.550	1.860	124		*	*	*	*	*		*
18	146.265		135.565	1.875	125		*	*	*	*	*		*
19	146.280		135.580	1.890	126		*	*	*	*	*	*	
20	146.295		135.595	1.905	127		*	*	*	*	*	*	*
21	146.310		135.610	1.920	128	*							
22	146.325		135.625	1.935	129	*							*
23	146.340		135.640	1.950	130	*					*	*	
24	146.355		135.655	1.965	131	*					*	*	
25	146.370		135.670	1.980	132	*				*			
26	146.385		135.685	1.995	133	*				*			*
27	146.400		135.700	2.010	134	*				*	*		
28	146.415		135.715	2.025	135	*				*	*	*	*
29	146.430		135.730	2.040	136	*			*				
30	146.445		135.745	2.055	137	*			*				*
31	146.460		135.760	2.070	138	*			*		*		
32	146.475		135.775	2.085	139	*			*		*	*	
33	146.490		135.790	2.100	140	*			*	*			
34	146.505		135.805	2.115	141	*			*	*			*
35	146.520		135.820	2.130	142	*			*	*	*		
36	146.535		135.835	2.145	143	*			*	*	*	*	*
37	146.550		135.850	2.160	144	*			*				
38	146.565		135.865	2.175	145	*			*				*
39	146.580		135.880	2.190	146	*			*		*		
40	146.595		135.895	2.205	147	*			*		*	*	
41	146.610	1	135.910	2.220	148	*			*	*			
42	146.625	2	135.925	2.235	149	*			*	*	*	*	*
43	146.640	3	135.940	2.250	150	*			*	*	*	*	
44	146.655	4	135.955	2.265	151	*			*	*	*	*	*
45	146.670	5	135.970	2.280	152	*			*	*			
46	146.685	6	135.985	2.295	153	*			*	*			*
47	146.700	7	136.000	2.310	154	*			*	*	*		

Simp-lex	Set Freq. (MHz)	Dup-lex	PLL Out Freq. (MHz)	1/M Freq. (MHz)	Total N	DIODE INSERT POSITIONS							
						128 D7	64 D6	32 D5	16 D4	8 D3	4 D2	2 D1	1 D0
48	146.715	8	136.015	2.325	155	*			*			*	*
49	146.730	9	136.030	2.340	156	*			*	*	*		
50	146.745	10	136.045	2.355	157	*			*	*	*		*
51	146.760	11	136.060	2.370	158	*			*	*	*	*	
52	146.775	12	136.075	2.385	159	*			*	*	*	*	*
53	146.790	13	136.090	2.400	160	*		*					
54	146.805	14	136.105	2.415	161	*		*					*
55	146.820	15	136.120	2.430	162	*		*				*	
56	146.835	16	136.135	2.445	163	*		*				*	*
57	146.850	17	136.150	2.460	164	*		*		*			
58	146.865	18	136.165	2.475	165	*		*		*			*
59	146.880	19	136.180	2.490	166	*		*		*	*	*	
60	146.895	20	136.195	2.505	167	*		*		*	*	*	*
61	146.910	21	136.210	2.520	168	*		*		*			
62	146.925	22	136.225	2.535	169	*		*					
63	146.940	23	136.240	2.550	170	*		*		*		*	
64	146.955	24	136.255	2.565	171	*		*		*		*	*
65	146.970	25	136.270	2.580	172	*		*		*	*		
66	146.985	26	136.285	2.595	173	*		*		*	*		*
67	147.000	27	136.300	2.610	174	*		*		*	*	*	
68	147.015	28	136.315	2.625	175	*		*		*	*	*	*
69	147.030	29	136.330	2.640	176	*		*	*				
70	147.045	30	136.345	2.655	177	*		*	*				*
71	147.060	31	136.360	2.670	178	*		*	*			*	
72	147.075	32	136.375	2.685	179	*		*	*			*	*
73	147.090	33	136.390	2.700	180	*		*	*	*			
74	147.105	34	136.405	2.715	181	*		*	*	*		*	*
75	147.120	35	136.420	2.730	182	*		*	*	*	*	*	
76	147.135	36	136.435	2.745	183	*		*	*	*	*	*	*
77	147.150	37	136.450	2.760	184	*		*	*	*			
78	147.165	38	136.465	2.775	185	*		*	*	*			*
79	147.180	39	136.480	2.790	186	*		*	*	*		*	
80	147.195	40	136.495	2.805	187	*		*	*	*	*	*	*
81	147.210	41	136.510	2.820	188	*		*	*	*	*	*	
82	147.225	42	136.525	2.835	189	*		*	*	*	*	*	*
83	147.240	43	136.540	2.850	190	*		*	*	*	*	*	
84	147.255	44	136.555	2.865	191	*		*	*	*	*	*	*
85	147.270	45	136.570	2.880	192	*	*						
86	147.285	46	136.585	2.895	193	*	*						*
87	147.300	47	136.600	2.910	194	*	*				*		
88	147.315	48	136.615	2.925	195	*	*				*	*	*
89	147.330	49	136.630	2.940	196	*	*			*			
90	147.345	50	136.645	2.955	197	*	*			*		*	*
91	147.360	51	136.660	2.970	198	*	*			*	*	*	
92	147.375	52	136.675	2.985	199	*	*			*	*	*	*
93	147.390	53	136.690	3.000	200	*	*		*				
94	147.405	54	136.705	3.015	201	*	*		*				*
95	147.420	55	136.720	3.030	202	*	*		*		*		

Simp-lex	Set Freq. (MHz)	Dup-lex	PLL Out Freq. (MHz)	1/M Freq. (MHz)	Total N	DIODE INSERT POSITIONS							
						128 D7	64 D6	32 D5	16 D4	8 D3	4 D2	2 D1	1 D0
96	147.435	56	136.735	3.045	203	*	*			*		*	*
97	147.450	57	136.750	3.060	204	*	*			*	*		
98	147.465	58	136.765	3.075	205	*	*			*	*		*
99	147.480	59	136.780	3.090	206	*	*			*	*	*	
100	147.495	60	136.795	3.105	207	*	*			*	*	*	*
101	147.510	61	136.810	3.120	208	*	*		*				
102	147.525	62	136.825	3.135	209	*	*		*				*
103	147.540	63	136.840	3.150	210	*	*		*			*	
104	147.555	64	136.855	3.165	211	*	*		*			*	*
105	147.570	65	136.870	3.180	212	*	*		*	*			
106	147.585	66	136.885	3.195	213	*	*		*	*			*
107	147.600	67	136.900	3.210	214	*	*		*	*	*		
108	147.615	68	136.915	3.225	215	*	*		*	*	*	*	*
109	147.630	69	136.930	3.240	216	*	*		*	*			
110	147.646	70	136.945	3.255	217	*	*		*	*			*
111	147.660	71	136.960	3.270	218	*	*		*	*		*	
112	147.675	72	136.975	3.285	219	*	*		*	*		*	*
113	147.690	73	136.990	3.300	220	*	*		*	*	*		
114	147.705	74	137.005	3.315	221	*	*		*	*	*		*
115	147.720	75	137.020	3.330	222	*	*		*	*	*	*	
116	147.735	76	137.035	3.345	223	*	*		*	*	*	*	*
117	147.750	77	137.050	3.360	224	*	*	*					
118	147.765	78	137.065	3.375	225	*	*	*					*
119	147.780	79	137.080	3.390	226	*	*	*				*	
120	147.795	80	137.095	3.405	227	*	*	*				*	*
121	147.810	81	137.110	3.420	228	*	*	*		*			
122	147.825	82	137.125	3.455	229	*	*	*		*			*
123	147.840	83	137.140	3.450	230	*	*	*		*	*		
124	147.855	84	137.155	3.465	213	*	*	*		*	*	*	*
125	147.870	85	137.170	3.480	232	*	*	*	*				*
126	147.885	86	137.185	3.495	233	*	*	*	*	*			*
127	147.900	87	137.200	3.510	234	*	*	*	*	*	*		*
128	147.915	88	137.215	3.525	235	*	*	*	*	*	*	*	*
129	147.930	89	137.230	3.540	236	*	*	*	*	*	*	*	*
130	147.945	90	137.245	3.555	237	*	*	*	*	*	*	*	*
131	147.960	91	137.260	3.570	238	*	*	*	*	*	*	*	*
132	147.975	92	137.275	3.585	239	*	*	*	*	*	*	*	*
133	147.990	93	137.290	3.590	240	*	*	*	*	*	*	*	*

Unit	No.	Transmit				Receive				Notes
		Base or Gate 1	Gate 2	Collector or Drain	Emitter or Source	Base or Gate 1	Gate 2	Collector or Drain	Emitter or Source	
	Q1	0.2V		-25V	0.26V	8.2V		6.8V	8.2V	
	Q2					0V	4.3V	8.1V	0.24V	
	Q3					0V	0V	9.1V	E	
	Q4					0V		8.0V	1.3V	
	Q5					1.85V		9.6V	1.7V	
	Q6					0.67V		2.45V	E	
	Q7					5.0V		6.6V	4.7V	
	Q8	0V		9.6V	0V	1.35V		5.1V	1.0V	Squelch Open
	Q9					2.4V		9.3V	3.2V	
	Q10	5.9V		9.6V	5.5V	6.1V		9.7V	5.7V	
	Q11	0.05V		13.8V	E	0.75V		0.35V	E	Squelch Closed
	Q12	0.65V		0.75V	E	0V		8.0V	E	"
	Q13					1.35V		5.8V	0.80V	
	Q14					1.35V		9.4V	0.75V	
	Q15	0.26V		12.9V	+0.90V	0V		13.5V	0.7V	
	Q16	12.9V		6.6V	13.7V	13.5V		13.8V	13.8V	
	Q17	-0.125V		13.7V	E	0V		13.8V	E	
	Q18	-0.4V		13.7V	E	0V		13.8V	E	
	Q19	0.85V		7.2V	0.18V	0.05V		13.8V	0V	
	Q20	0.02V		9.5V	E					
	Q21	0.6V		0.26V	9.7V					
	Q22	0V	4.6V	8.4V	0.26V					
	Q24	4.7V		9.7V	4.2V					
	Q25	5.7V		9.6V	5.4V	5.8V		9.6V	5.4V	
	Q26	0.70V		1.65V	E	0.70V		1.65V	E	
	Q27	0.65V		0.70V	E	0.65V		0.70V	E	
	Q28	0.55V		0.65V	E	0.55V		0.65V	E	
	Q29	8.3V		7.7V	8.8V	8.3V		7.7V	8.8V	
	Q30	8.4V		8.1V	7.9V	8.4V		8.1V	7.9V	
	Q31	10.3V		12.6V	9.7V	10.3V		12.7V	9.7V	
	Q32	10.3V		12.9V	9.7V	0.9V		13.8V	0.35V	
	Q33	0.75V		10.3V	0.26V	1.55V		0.85V	0.85V	
	Q34	0.85V		13.7V	0.26V	10.3V		12.9V	9.7V	

Unit	No.	Transmit				Receive				Notes
		Base or Gate 1	Gate 2	Collector or Drain	Emitter or Source	Base or Gate 1	Gate 2	Collector or Drain	Emitter or Source	
PLL Unit	Q1	0V		9.3V	E	0V		9.3V	E	
"	Q2	0.75V		0.6V	E	0.75V		0.6V	E	
"	Q3	9.5V		9.7V	8.8V	9.5V		9.7V	8.8V	

Unit	No.	Transmit				Receive				Notes
		Base or Gate 1	Gate 2	Collector or Drain	Emitter or Source	Base or Gate 1	Gate 2	Collector or Drain	Emitter or Source	
PLL Unit	Q1	0V		9.3V	E	0V		9.3V	E	
"	Q2	0.75V		0.6V	E	0.75V		0.6V	E	
"	Q3	9.5V		9.7V	8.8V	9.5V		9.7V	8.8V	
"	Q4	8.8V		0V	8.8V	8.8V		0V	8.8V	
"	Q5	0V	3.5V	8.3V	1.25V	0V	3.5V	8.3V	1.25V	
"	Q6	0.5V		3.8V	E	0.5V		3.8V	E	
"	Q7	1.4V		8.5V	0.75V	1.4V		8.5V	0.75V	
"	Q8	0V		8.4V	0V	0V		8.4V	0V	
"	Q9	0V		8.8V	E	0V		8.8V	E	Japan only (145.00MHz)

		Transmit														Pin No.	
Unit	No.	1	2	3	4	5	6	7	8	9	10	11	12	13	14	Notes	
IC2		1.6V	13.7V	13.7V	0V	0.55V	13.7V	0V	5.2V								
IC3		6.4V	3.4V	E	2.8V	6.4V	9.7V	9.7V	9.7V								

		Receive														Pin No.	
Unit	No.	1	2	3	4	5	6	7	8	9	10	11	12	13	14	Notes	
IC1		5.3V	1.8V	1.8V	E	8.5V	3.0V	8.6V									
IC2		1.55V	13.8V	13.3V	8.0V	6.8V	13.8V	0V	1.95V								

		Transmit														Pin No.	
Unit	No.	1	2	3	4	5	6	7	8	9	10	11	12	13	14	Notes	
PLL	IC1									E		E	E	9.0V			
	IC2	0.9		3.7V	8.8V	8.8V	3.7V			E							
	IC3					7.6V				E							
	IC4	1.0V		E	0.3V	1.0V	5.6V	5.6V	5.6V								
	IC5	5.0V		1.9V	E	8.3V	3.0V	9.0V									
	IC6	4.5V			E		E	E	E						9.0V		

		Receive														Pin No.		
Unit	No.	1	2	3	4	5	6	7	8	9	10	11	12	13	14	15	16	Notes
IC	IC1									E		E	E	9.0V		4.5V	9.0V	
	IC2	0.9V	3.7V	3.7V	8.8V	8.8V	3.7V			E								
	IC3					7.6V				E								
	IC4	1.0V	1.1V	E	0.3V	1.0V	5.6V	5.6V	5.6V									
	IC5	5.0V	1.9V	1.9V	E	8.3V	3.0V	9.0V										
	IC6	4.5V			E		E	E	E					9.0V				

SECTION IX BLOCK DIAGRAM

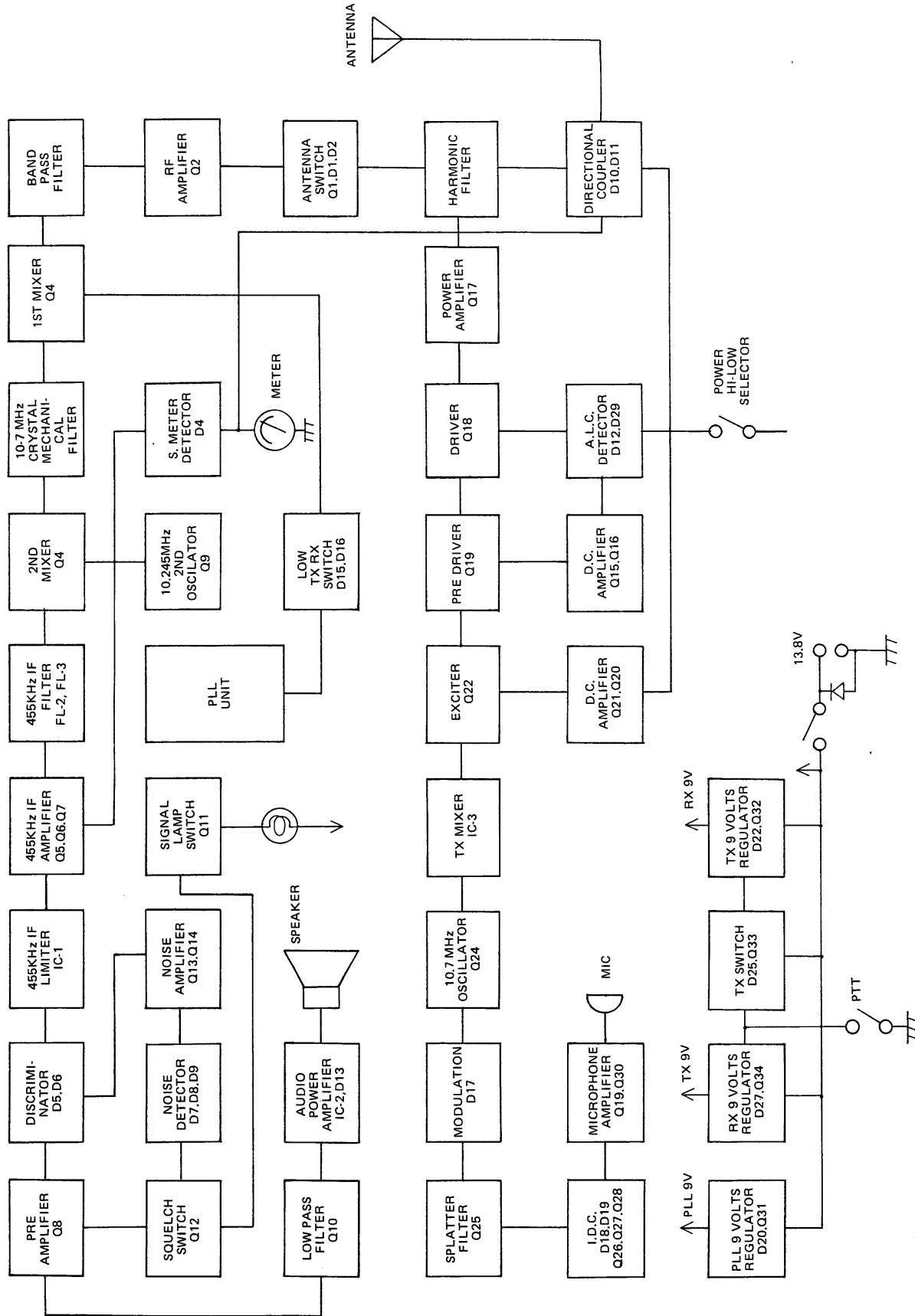

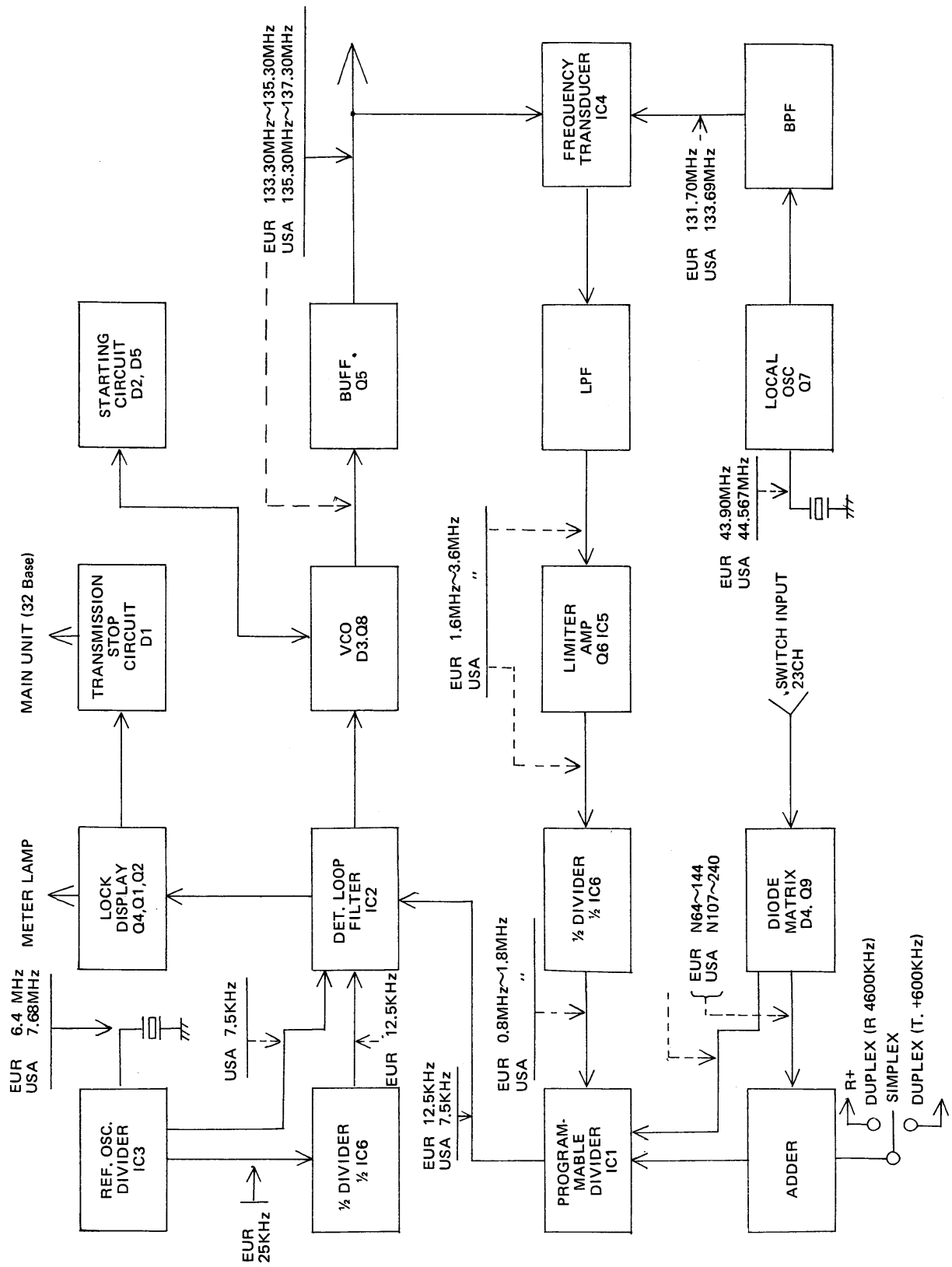



INOUE COMMUNICATION EQUIPMENT CORPORATION

NO 6-19, 1 CHOME, KAMI KURATSUKURI, HIRANO-KU,
OSAKA JAPAN

