

# ICOM

## INSTRUCTION MANUAL

DUAL BAND FM TRANSCEIVER

# IC-2700H

# IC-2700A

# IC-2700E

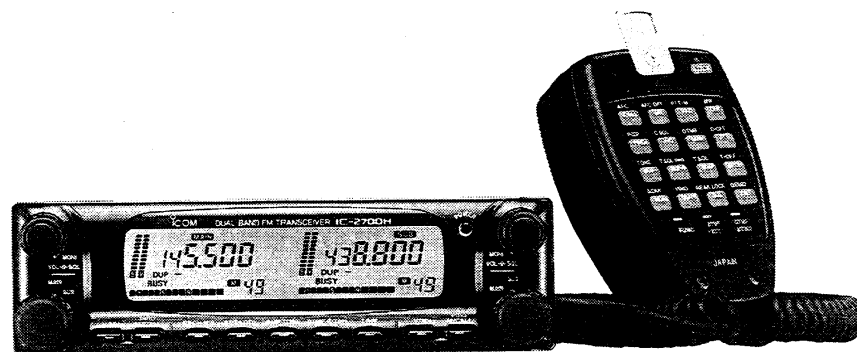

Radio Mods Manuals

---

## IMPORTANT

---

**READ ALL INSTRUCTIONS** carefully and completely before using the transceiver.

**SAVE THIS INSTRUCTION MANUAL** – This instruction manual contains important safety and operating instructions for the IC-2700H/A/E.

---

## FOREWORD

---

The IC-2700H/A/E is a compact, easy-to-operate, multi-function transceiver designed using Icom's state-of-the-art technology.

Sections beginning with a microphone illustration describe operations using the supplied microphone or optional HM-90/A WIRELESS MICROPHONE.

**NOTE:** See "Unpacking" on p. 87 for included accessories.

---

## CAUTIONS

---

**NEVER** connect the transceiver to an AC outlet or to a power source of more than 16 V DC. These connections will ruin the transceiver.

**NEVER** connect the transceiver to a power source using reverse polarity. This connection will ruin the transceiver.

**NEVER** place the transceiver where normal operation of the vehicle may be hindered or where it could cause bodily injury.

**NEVER** allow children to touch the transceiver.

**DO NOT** use or place the transceiver in areas with temperatures below  $-10^{\circ}\text{C}$  ( $+14^{\circ}\text{F}$ ) or over  $+60^{\circ}\text{C}$  ( $+140^{\circ}\text{F}$ ) or, in areas subject to direct sunlight, such as the dashboard.

**AVOID** the use of chemical agents such as benzine or alcohol when cleaning, as they can damage the transceiver surfaces.

**BE CAREFUL!** The transceiver will become hot when operating it continuously for long periods.

# TABLE OF CONTENTS

<b>1 PANEL DESCRIPTION</b> .....	<b>1-8</b>	<b>7 MEMORY OPERATION</b> .....	<b>39-44</b>	<b>14 PAGER AND CODE SQUELCH</b> ..	<b>65-71</b>
■ Front panel (remote controller)	1	■ General description	39	■ Pager function	65
■ Function display	3	■ Memory channel selection	39	■ Code channels	66
■ Rear panel	5	■ Programming a memory channel	40	■ Code programming	67
■ Microphone	6	■ Programming a memory channel via the microphone	41	■ Pager operation	68
■ Microphone keyboard	7	■ Transferring memory contents	42	■ Code squelch function	70
<b>2 INSTALLATION</b> .....	<b>9-16</b>	■ Memory area setting	43	■ Code squelch operation	71
<b>3 MODE ARRANGEMENT CHART</b> ..	<b>17-18</b>	■ Memory channel allocation	44	<b>15 POCKET BEEP AND TONE SQUELCH</b> .....	<b>72-74</b>
<b>4 SETTING A FREQUENCY</b> .....	<b>19-23</b>	■ Auto channel advance	44	■ Pocket beep operation	72
■ Pre-operation	19	<b>8 CALL CHANNEL OPERATION</b> ..	<b>45-46</b>	■ Tone squelch operation	73
■ Lock functions	20	<b>9 SCRATCH PAD MEMORY</b> .....	<b>47-48</b>	■ Optional unit installation	74
■ Using a tuning dial	21	■ What is a scratch pad memory	47	<b>16 WIRELESS MICROPHONE</b> .....	<b>75-76</b>
■ Using [UP]/[DN] switches	21	■ Calling up a scratch pad memory	47	■ HM-90/A microphone	75
■ Tuning step selection	22	■ Transferring scratch pad memory contents	48	■ Charging the microphone	75
■ Using the keyboard	23	<b>10 SCAN OPERATION</b> .....	<b>49-56</b>	■ EX-1513 installation	76
<b>5 BASIC OPERATION</b> .....	<b>24-32</b>	■ Scan types	49	<b>17 OTHER FUNCTIONS</b> .....	<b>77-82</b>
■ Receiving	24	■ Full scan and programmed scan	50	■ Audio output selection	77
■ Setting a squelch level	25	■ Scan edge selection	51	■ Beep tone on/off	78
■ Monitor function	25	■ Programming scan edges	52	■ Time-out timer	78
■ Audio mute function	26	■ Programming scan edges via the microphone	53	■ Auto power-off	79
■ Display dimmer setting	26	■ Memory scan	54	■ Cooling fan setting	79
■ Sub band access	27	■ Skip channel setting	55	■ Microphone address	80
■ Sub band mute/sub band busy beep	28	■ Scan resume condition	56	■ Optional voice synthesizer	81
■ Mono band operation	29	<b>11 PRIORITY WATCH</b> .....	<b>57-58</b>	■ Demonstration display	82
■ Para-watch	29	<b>12 DTMF MEMORY</b> .....	<b>59-62</b>	<b>18 MAINTENANCE</b> .....	<b>83-85</b>
■ Transmitting	31	■ Programming a DTMF code	59	■ Troubleshooting	83
■ Selecting the output power	31	■ Clearing the DTMF memory contents	59	■ Fuse replacement	85
■ Crossband full duplex	32	■ Programming a DTMF code via the microphone	60	■ Partial resetting	85
■ One-touch PTT function	32	■ Transmitting a DTMF code	61	■ Resetting the transceiver	85
<b>6 REPEATER OPERATION</b> .....	<b>33-38</b>	■ DTMF speed	62	<b>19 SPECIFICATIONS</b> .....	<b>86</b>
■ Operation	33	<b>13 EXTERNAL DTMF REMOTE</b> .....	<b>63-64</b>	<b>20 OPTIONS</b> .....	<b>87-88</b>
■ Tone information	34			■ Unpacking	87
■ Subaudible tones	35			■ Options	87
■ Offset frequency	36				
■ Tone scan	37				
■ Auto repeater	38				

## Front panel (remote controller)

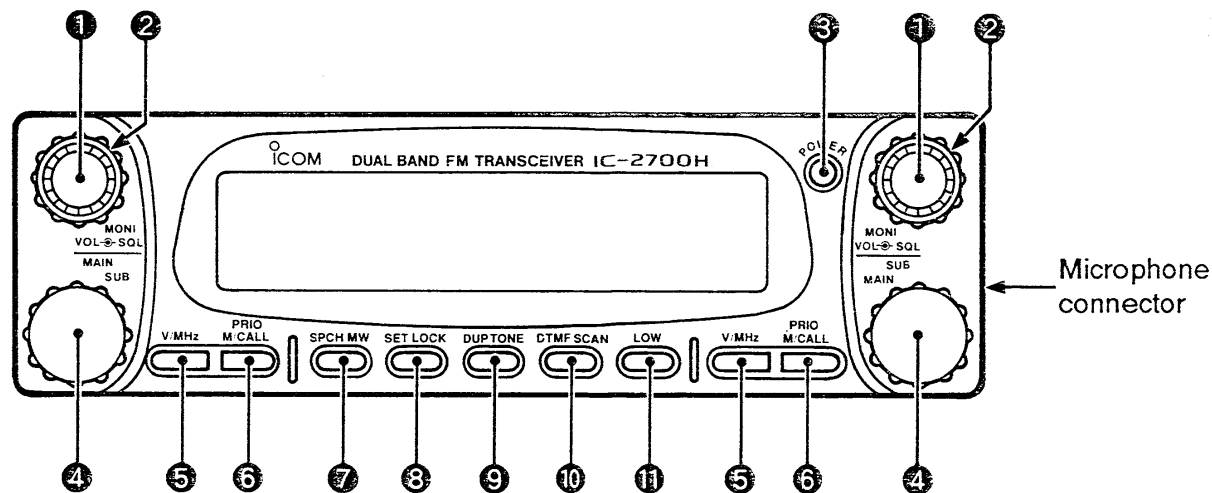

### ① VOLUME CONTROLS [VOL•MONI]

- Adjust the audio level. (p. 24)
- Open the squelch and monitor the transmit frequency when pushed and held. (pgs. 25, 33)

### ② SQUELCH CONTROLS [SQL] (p. 25)

Vary the squelch level.

### ③ POWER SWITCH [POWER] (p. 19)

Turns power ON and OFF when pushed for 1 sec.

### ④ TUNING DIALS [MAIN•SUB]

- Select the operating frequency (p. 21), the memory channel (p. 39), the contents of the set mode display (p. 18) and the scanning direction (pgs. 50, 54).

- Select the main band when pushed. (p. 19)

- Activate the sub band access function when pushed and held (when the main band is not selected). (p. 27)

- Change the operating band for para-watch when pushed and held (when the main band is selected). (p. 29)

### ⑤ VFO/MHz SWITCHES [V/MHz]

- Select VFO mode. (p. 19)

- Select the 1 MHz tuning step in VFO mode. (p. 21)

- Select the 10 MHz tuning step when pushed and held. Some versions do not have the 10 MHz tuning step. (p. 21)



**⑥ MEMORY/CALL CHANNEL SWITCHES**

**[M/CALL•PRIO]**

- Select memory mode or a call channel. (pgs. 39, 45)
- Activate the priority watch function when pushed and held. (p. 58)
- Cancel the priority watch function when the function is activated. (p. 58)

**⑦ SPEECH/MEMORY WRITE SWITCH [SPCH•MW]**

- Programs a memory channel or a call channel when pushed and held. (pgs. 40, 46) Also advances the memory channel number when continuously pushed after programming is completed. (p. 44)
- Transfers the contents of a memory channel, call channel or scratch pad memory to the VFO. (pgs. 42, 45, 48)
- Announces the accessed band frequency in a synthesized voice when an optional UT-66 VOICE SYNTHESIZER UNIT is installed. (p. 74, 81)
- Reverses the set mode selection order in set mode. (p. 18)

**⑧ SET MODE SWITCH [SET•LOCK]**

- Accesses set mode and advances the set mode display. (p. 18)
- Activates the frequency lock function when pushed and held. (p. 20)

**⑨ DUPLEX/TONE SWITCH [DUP•TONE]**

- Selects simplex, – duplex or + duplex. (p. 33)
  - Activates the optional subaudible tone encoder\* (p. 34); pocket beep (p. 72) or tone squelch function (p. 73) when pushed and held.
- \* U.S.A. and Korea versions : Built-in  
 Other versions : Optional except for 88.5 Hz.

**⑩ DTMF/SCAN SWITCH [DTMF•SCAN]**

- Activates the pager, code squelch, DTMF memory or DTMF remote functions. (pgs. 59, 63, 68, 71)
- Starts scan in VFO or memory mode when pushed and held. (pgs. 50, 54)
- Starts tone scan when pushed and held while an optional tone squelch is in use. (p. 37)

**⑪ TRANSMIT POWER SWITCH [LOW] (p. 31)**

Selects the transmit output power levels.

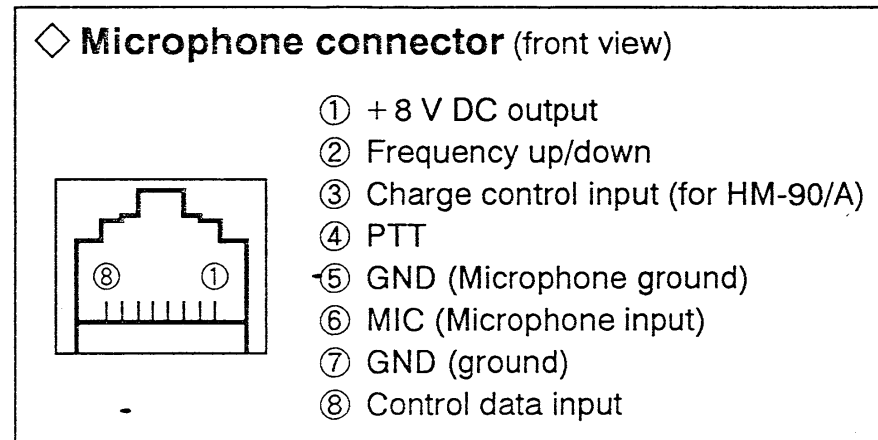

# 1 PANEL DESCRIPTION

## Function display

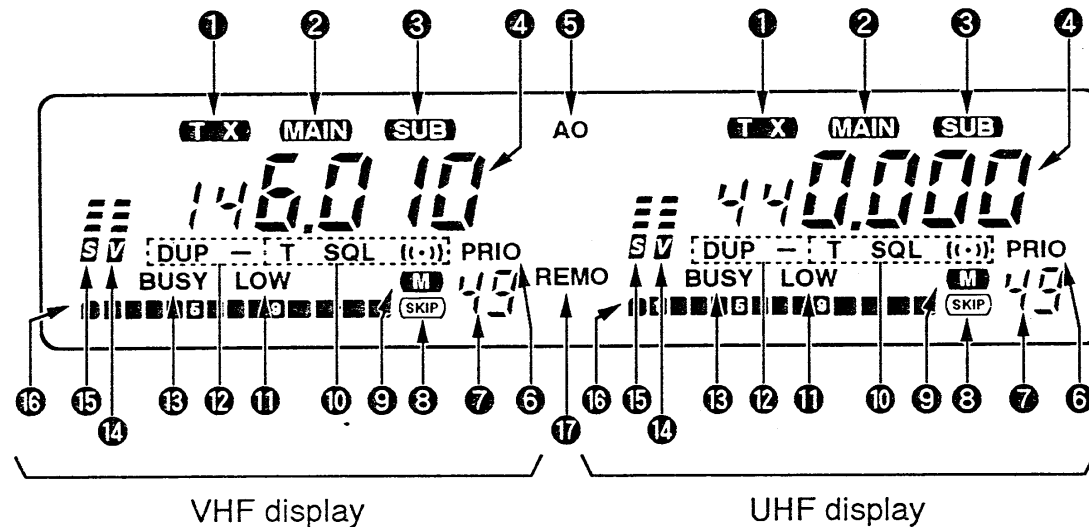

### ① TRANSMIT INDICATORS

Appear while transmitting. (p. 31) Flash while transmitting with the one-touch PTT function. (p. 32)

### ② MAIN BAND INDICATORS (p. 19)

Appear above a frequency readout to show the main band for transmitting and function control.

### ③ SUB BAND ACCESS INDICATORS

- Appear above a frequency readout to show the accessed band for function control (except transmitting). (p. 27)
- Flash while External DTMF Remote is in use. (p. 63)

### ④ FREQUENCY READOUTS

- Show the operating frequency, set mode contents, etc.
- The decimal point of the frequency flashes while scanning. (pgs. 37, 50, 54)
  - "P," "C" or "d" appears in place of the 100 MHz digit while the pager, code squelch or DTMF memory function is in use, respectively. (pgs. 59, 68, 71)

### ⑤ AUTO POWER-OFF INDICATOR (p. 79)

Appears while the auto power-off function is in use.

**6 PRIORITY WATCH INDICATORS** (p. 58)

Appear while the priority watch is activated; flash while the watch is paused.

**7 MEMORY CHANNEL READOUTS**

Show the selected memory channel numbers. (p. 39)

- Only 2 large “L” ’s appear while the frequency lock function is in use. (p. 20)
- A large “C” appears while on a call channel. (p. 45)
- “r1”–“r3” appear when a duplex scratch pad memory is selected. (p. 47)
- “L1”–“L3” appear when a simplex scratch pad memory is selected. (p. 47)
- A small “c” appears when VFO mode is selected from the call channel or a scratch pad memory. (pgs. 45, 47)

**8 SKIP INDICATORS** (p. 55)

Appear when the displayed memory channel is specified as a skip channel.

**9 MEMORY INDICATORS** (p. 39)

Appear when memory mode is selected.

**10 TONE INDICATORS**

- “T” appears while the subaudible tone encoder is in use. (p. 34)
- “T SQL” appears while the optional tone squelch function is in use. (p. 73)
- “T SQL ((•))” appears while the optional pocket beep function is in use. (p. 72)

**11 LOW POWER INDICATORS** (p. 31)

Appear while low output power 1 or 2 is selected.

**12 DUPLEX INDICATORS** (p. 33)

“DUP –” or “DUP” appear during semi-duplex operation (repeater operation).

**13 BUSY INDICATORS** (p. 24)

Appear while a signal is being received or the squelch is open.

**14 VOLUME LEVEL INDICATORS**

- Show the audio volume level. (p. 24)
- Flash while the audio mute function is in use. (p. 26)

**15 SQUELCH LEVEL INDICATORS** (p. 25)

Show the squelch volume level.

**16 S/RF INDICATORS**

- Show the relative strength while receiving signals. (p. 24)
- Show the output power selection while transmitting. (p. 31)

**17 REMOTE INDICATOR** (p. 63)

Appears while the External DTMF Remote is in standby. Flashes while the function is activated. (This function is available for the U.S.A. version only.)

# 1 PANEL DESCRIPTION

## ■ Rear panel

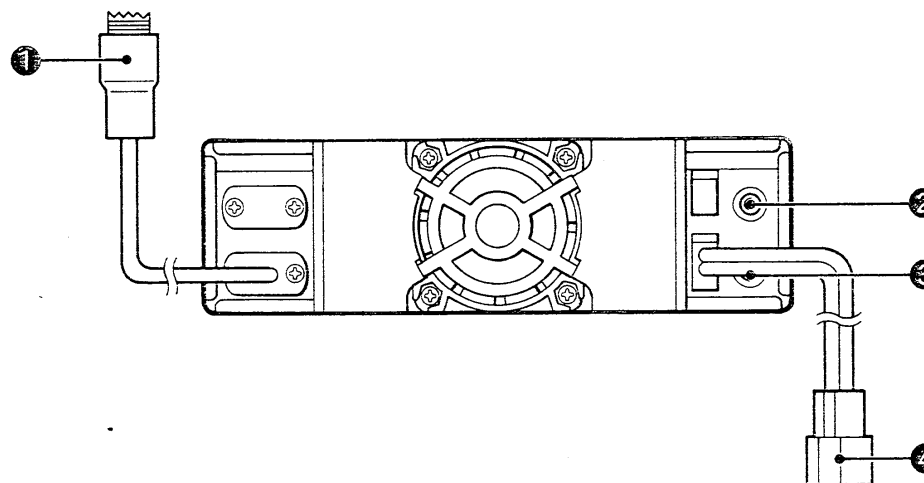

### ❶ ANTENNA CONNECTOR [ANT]

Accepts a 50  $\Omega$  dual band antenna with a PL-259 connector. (p. 15)

### ❷ SPEAKER JACK 1 [SP-1]

Connects a 4–8  $\Omega$  speaker, if required. Outputs both band's audio when [SP-2] has no connection. See the table at right for details.

### ❸ SPEAKER JACK 2 [SP-2]

Connects a 4–8  $\Omega$  speaker. Outputs the 430(440) MHz or 144 MHz band audio according to the set mode selection. (p. 77)

### ❹ POWER RECEPTACLE [DC13.8V] (p. 14)

Accepts 13.8 V DC with the supplied DC power cable.

### ◇ Speaker information

"AFo" setting	"AFo-0"		"AFo-1"	
	VHF audio	UHF audio	VHF audio	UHF audio
Connected speaker				
With no external speakers	Internal speaker (mixed audio)			
[SP-1] only	External speaker (mixed audio)			
[SP-2] only	Internal speaker	External speaker	External speaker	Internal speaker
2 external speakers	External speaker via [SP-1]	External speaker via [SP-2]	External speaker via [SP-2]	External speaker via [SP-1]

## Microphone

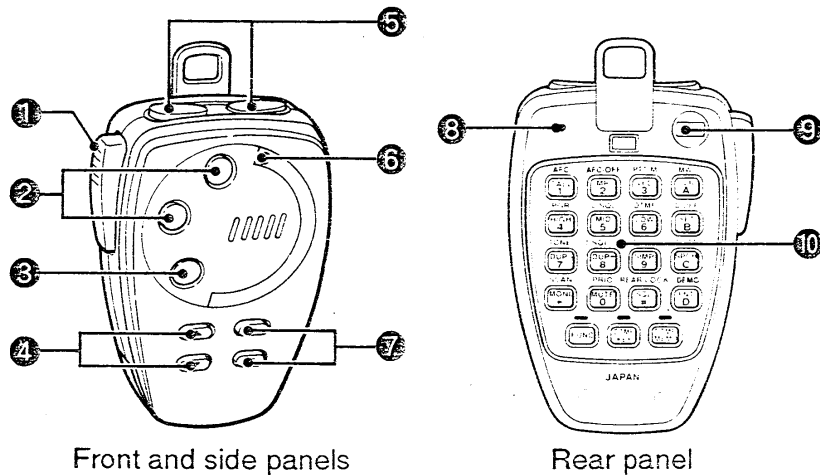

Front and side panels

Rear panel

### 1 PTT SWITCH

- Push and hold to transmit; release to receive. (p. 31)
- Toggles between transmitting and receiving while the one-touch PTT function is in use. (p. 32)

### 2 BAND SWITCHES [BAND SELECT ▲, ▼]

- Select the desired band as the main band. (p. 19)
- Activates the para-watch function when pushed and held when the main band is selected. (p. 30)
- Activate the sub band access function after pushing [FUNC] on the rear panel. (p. 27)

### 3 MONITOR SWITCH [MONI] (pgs. 25, 33)

- Opens the accessed band's squelch and monitors the transmit frequency when pushed and held.

### 4 SQUELCH LEVEL UP/DOWN SWITCHES

[▲ SQL], [▼ SQL]

- Vary the accessed band's squelch threshold point for noise mute. (p. 25)

### 5 FREQUENCY UP/DOWN SWITCHES [UP], [DN]

- Push either switch to change the operating frequency, memory channel, set mode contents, etc. (pgs. 21, 39)
- Push and hold either switch to start scanning. (pgs. 50, 54)

### 6 ACTIVE INDICATOR

- Lights up in red while a key is pushed; lights up in green while the one-touch PTT function is in use. (p. 32)

### 7 AUDIO VOLUME UP/DOWN SWITCHES

[▲ VOL], [▼ VOL]

- Adjust the accessed band's audio level. (p. 24)

### 8 MODE INDICATOR

- Indicates the microphone condition.

- Lights up in red when [FUNC] is pushed.
- Lights up in green when [DTMF KEY] is pushed.
- Lights up in orange when [DTMF MEMO] is pushed.

### 9 LOCK SWITCH [LOCK] (p. 20)















- Locks all switches and keys on the microphone except for the PTT switch.









### 10 KEYBOARD

- Used for controlling the transceiver, transmitting a DTMF memory channel, etc. See pgs. 7 and 8 for function details.

# 1 PANEL DESCRIPTION

## Microphone keyboard

KEY	FUNCTION	SECONDARY FUNCTION (After  )	OTHER FUNCTIONS
	Calls up a call channel. (p. 45)	No secondary function.	<ul style="list-style-type: none"> <li>• After : Input the appropriate digit for frequency or memory channel selection. (pgs. 23, 39)</li> <li>• After : Transmit the appropriate DTMF code. (p. 61)</li> <li>• After : Transmit the appropriate DTMF memory contents. (p. 61)</li> </ul>
	Selects memory mode. (p. 39)	No secondary function.	
	Selects VFO mode. (p. 19)	Turns the one-touch PTT function ON and OFF. (p. 32)	
	Selects high output power. (p. 31)	Turns the pager function ON. (p. 68)	
	Selects middle output power (low-2). (p. 31)	Turns the code squelch function ON. (p. 71)	
	Selects lowest output power (low-1). (p. 31)	Turns the DTMF memory function ON. (p. 59)	
	Selects - duplex. (p. 33)	Turns the subaudible tone encoder ON. (p. 34)	
	Selects + duplex. (p. 33)	Turns the optional pocket beep function ON. (p. 72)	
	Selects simplex. (p. 33)	Turns the optional tone squelch function ON. (p. 73)	
	Mutes both bands' audio signals. (p. 26)	Starts a priority watch. (p. 58)	

KEY	FUNCTION	SECONDARY FUNCTION (After  )	OTHER FUNCTIONS
	<p>Clears a digit before entry. (p. 23)</p> <p>Cancels the scan, priority watch, pager, code squelch or DTMF memory function. (pgs. 50, 54, 58, 59, 68, 71)</p>	<p>Writes the VFO contents into the memory channel or call channel. (pgs. 41, 46)</p> <p>Advances the memory channel number when continuously pushed after programming is completed. (p. 44)</p>	<ul style="list-style-type: none"> <li>• After  : Transmit the appropriate DTMF code. (p. 61)</li> <li>• After  : [A CLR]—[D ENT] Transmit the appropriate DTMF memory contents. (p. 61)</li> <li>[* MONI] Transmits a 1750 Hz tone call signal for 0.5 sec. (p. 34)</li> <li>[# SQL] Transmits a 1750 Hz tone call signal while pushing. (p. 34)</li> </ul>
	<p>Enters set mode and advances the set mode selection order. (p. 18)</p>	<p>Turns the pager, code squelch, DTMF memory or DTMF remote function OFF. (pgs. 59, 63, 68, 71)</p>	
	<p>Announces the accessed band's frequency in a synthesized voice when an optional UT-66 is installed. (p. 81)</p> <p>Reverses the set mode selection order in set mode. (p. 18)</p>	<p>Turns the subaudible tone encoder, pocket beep or tone squelch OFF. (pgs. 34, 72, 73)</p>	
	<p>Sets the keyboard for numeral input. (pgs. 23, 39)</p>	<p>Enters demonstration mode. (p. 82)</p>	
	<p>Opens and closes the accessed band's squelch. (p. 25)</p>	<p>Starts scanning. (pgs. 50, 54)</p> <p>Starts tone scan while an optional tone squelch is in use. (p. 37)</p>	
	<p>Selects 1 of the 4 preset squelch levels. (p. 25)</p>	<p>Locks all keys on the microphone keyboard. (p. 20)</p>	

## Installation methods

### ◆ Single body installation

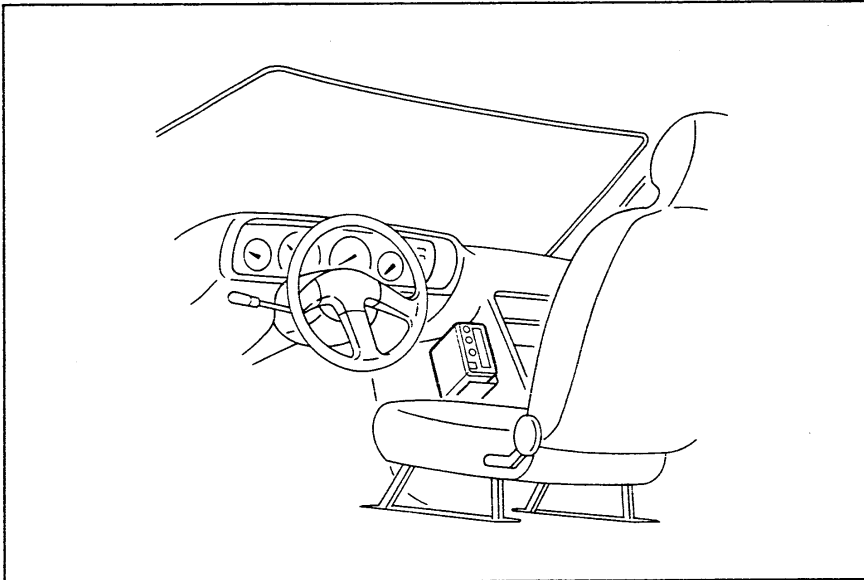

- It is not necessary to purchase a mounting bracket. The supplied mounting bracket (MB-26) can be used for installation.

### ◆ Separate installation

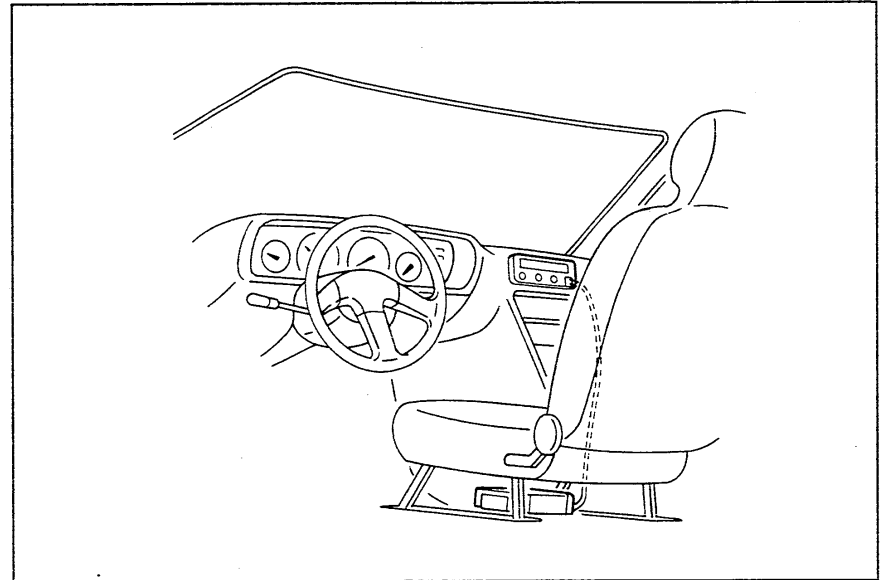

- Optional OPC-438 SEPARATION KIT (3.5 m; 11.5 ft) or OPC-439 (7.0 m; 23.0 ft) is necessary.
- Optional MB-58 REMOTE CONTROLLER BRACKET is available for front panel mounting.
- Optional OPC-440 MICROPHONE CABLE (5.0 m; 16.4 ft) is available to extend the microphone cable.
- Optional OPC-441 SPEAKER CABLE (5.0 m; 16.4 ft) is available to extend the speaker cable.



## ■ Location

Select a location which can support the weight of the transceiver and does not interfere with driving in any way. We recommend the locations shown in the diagram below.

**NEVER** place the transceiver or remote controller where normal operation of the vehicle may be hindered or where it could cause bodily injury.

**NEVER** place the transceiver or remote controller where air bag operation may be obstructed.

**DO NOT** place the transceiver or remote controller where hot or cold air blows directly onto it.

**AVOID** placing the transceiver or remote controller in direct sunlight.

### • EXAMPLE INSTALLATION LOCATIONS

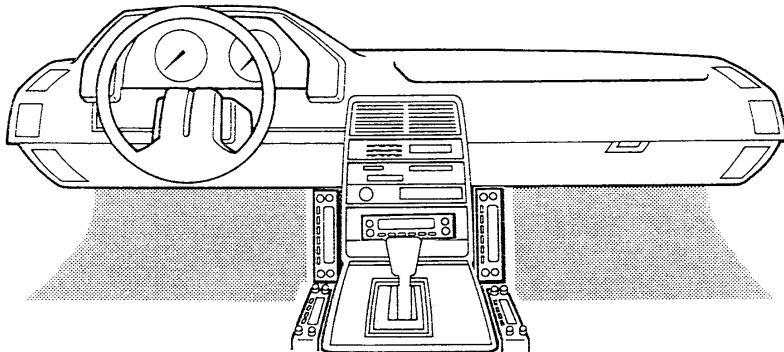

## ■ Single body installation

- ① Drill 4 holes where the mounting bracket is to be installed.
  - Approx. 5.5–6 mm (3/16 in) when using nuts; approx. 2–3 mm (1/16 in) when using self-tapping screws.
- ② Insert the supplied screws, nuts and washers through the mounting bracket and tighten.
- ③ The supplied mounting support bracket may help achieve a secure fit.
- ④ Adjust the angle for the clearest view of the function display.

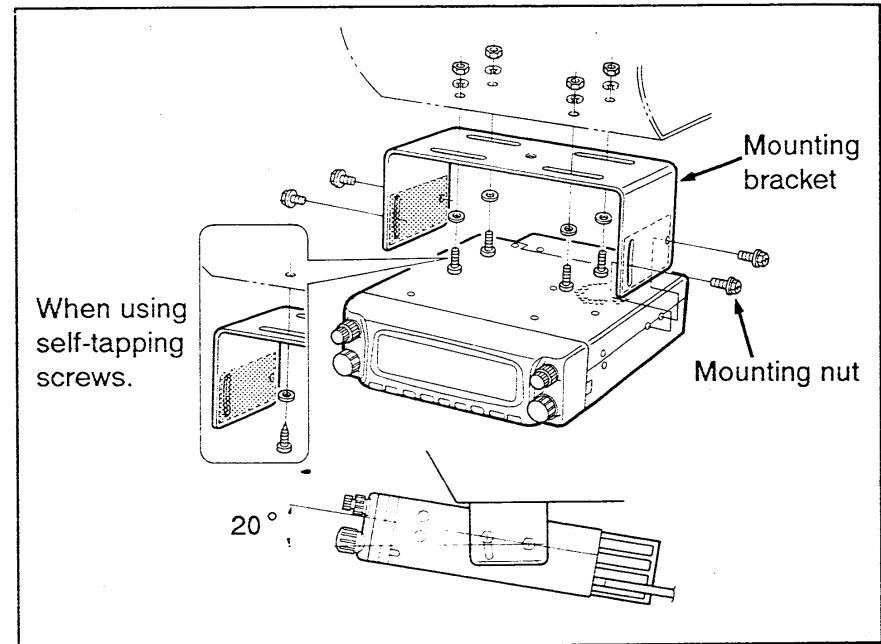

## 2 INSTALLATION

### ■ Microphone connection

The microphone connector is located behind the front panel. Connect the supplied microphone as follows:

- ① Push the release button, then detach the remote controller as shown below.
- ② Connect the supplied microphone to the microphone connector.

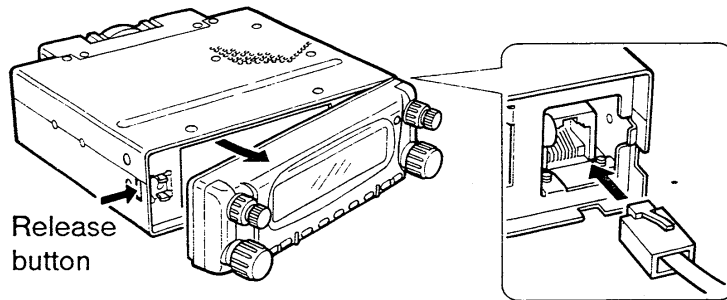

- ③ Attach the remote controller to the main body.

### ■ Separate installation

Using an optional OPC-438/439 SEPARATION KIT, the front panel can be separated from the main body, doubling as a remote controller.

The remote controller can be placed on the vehicle dashboard or in another convenient place. To install the main body in the trunk or under the seat, the optional OPC-440 MICROPHONE CABLE and OPC-441 SPEAKER CABLE are available to extend the microphone and speaker cables. An optional HM-90/A WIRELESS MICROPHONE and EX-1513 INFRARED SUB RECEIVER are available for wireless operation. (p. 76)

- ① Turn power OFF, then disconnect the DC power cable.
- ② Push the release button, then detach the remote controller as shown below.

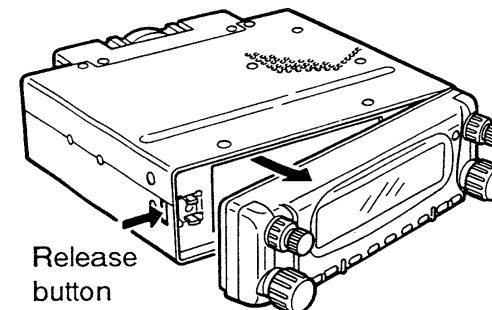

- ③ Disconnect the control cable from the main body.

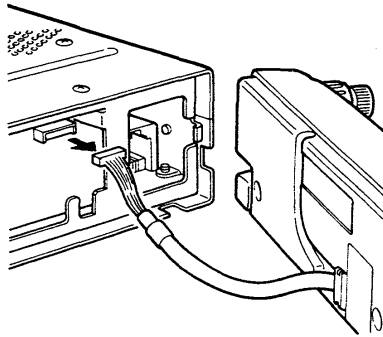

- ④ Remove the cable cover on the controller rear panel.  
 ⑤ Replace the control cable with the optional OPC-438/439. Connect the optional EX-1513 when operating with the optional HM-90/A if desired. (p. 75) Replace the cable cover. Keep the original control cable for future use.

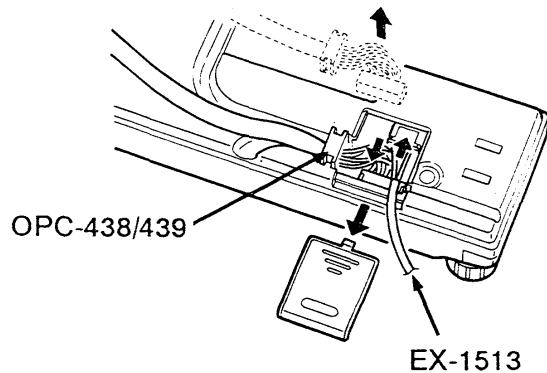

- ⑥ Connect the other end of the OPC-438/439 to the main body connector. Insert the rubber fitting ① between the 2 prongs. Connect the OPC-440 to the microphone connector.  
 ⑦ Pass the control cable and OPC-440 through the openings in the dummy front cover (supplied with the OPC-438/439).

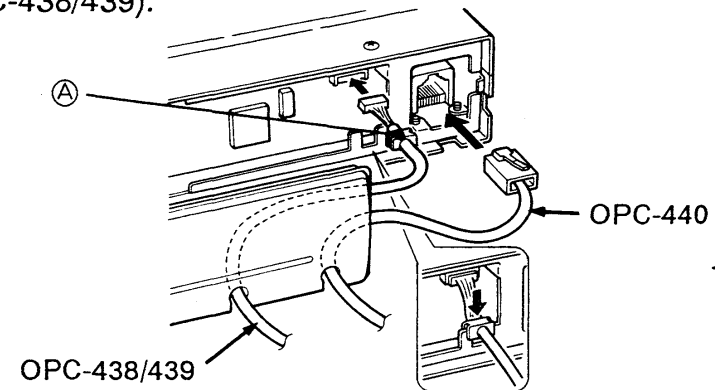

- ⑧ Attach the dummy front cover to the main body.  
 ⑨ Connect the DC power cable.

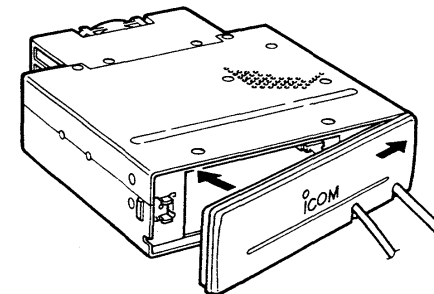

## 2 INSTALLATION

### ■ Optional MB-58 installation

The optional MB-58 REMOTE CONTROLLER BRACKET is available for separate installation.

- ① Drill 2 or 4 holes where the bracket or mounting base is to be installed, respectively.
  - Approx. 3.5–4 mm (1/8 in) when using nuts; approx. 1–2 mm (1/16 in) when using self-tapping screws.
- ② Insert the supplied screws, bolts and washers through the mounting base and tighten.
- ③ Adjust the angle for the clearest view of the function display and tighten 2 screws when the mounting base is used.

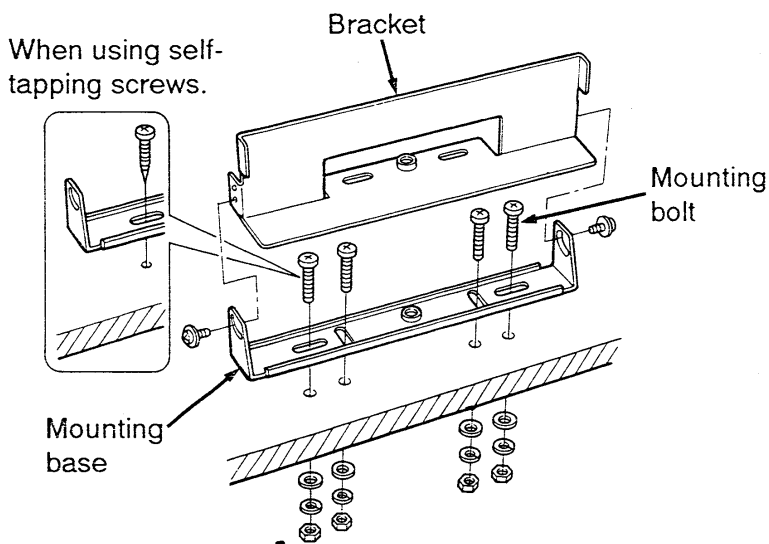

- ④ Attach the supplied Velcro pads (large) to the remote controller and bracket.
- ⑤ Attach the supplied Velcro pad (small) or rubber sheet to the bracket as shown below.

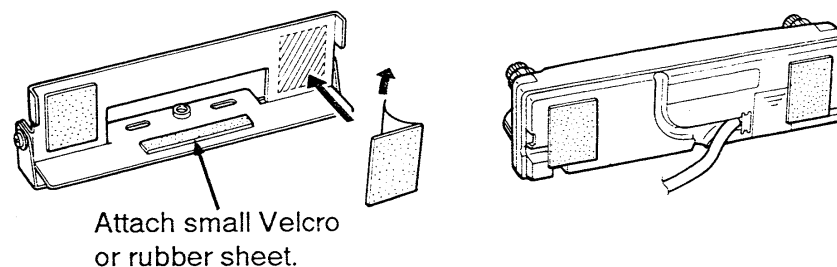

- ⑥ Attach the remote controller as shown below.

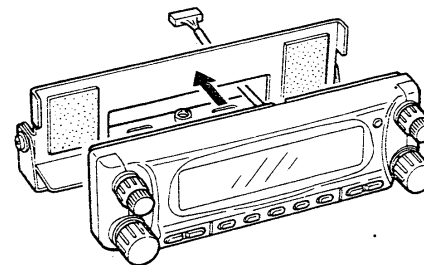

#### ◆ When using a gooseneck mount

The mounting base and bracket of the MB-58 can connect to a gooseneck mount with a tripod screw (1/4-20 UNC), such as that for a portable CD player or LCD TV set.

## Battery connection

**NEVER** connect the transceiver directly to a 24 V battery.

**DO NOT** use the cigarette lighter socket for power connections.

Attach a rubber grommet when passing the DC power cable through a metal plate to prevent short circuits.

### CONNECTING TO A DC POWER SOURCE

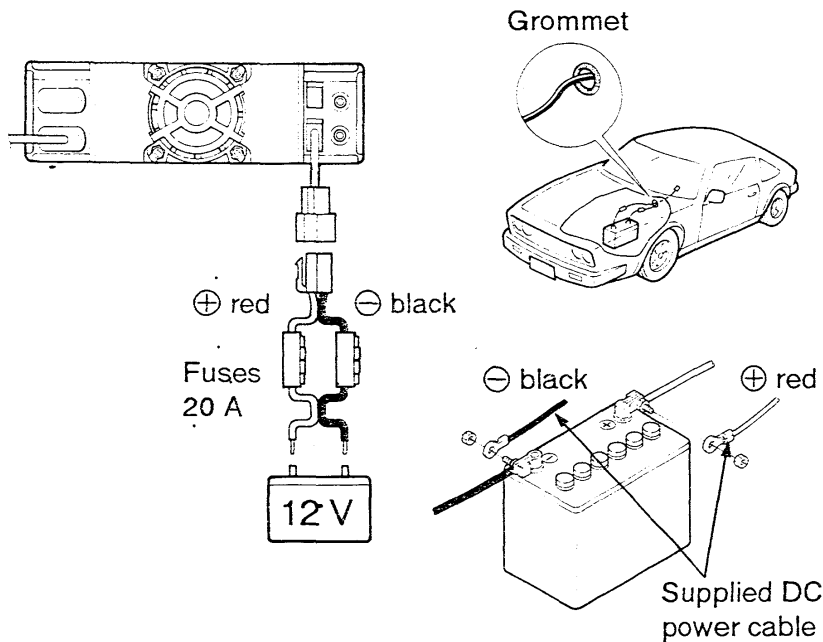

See p. 85 for fuse replacement.

## DC power supply connection

Use a 13.8 V DC power supply with more than 12 A capability. An optional IC-PS30 DC POWER SUPPLY is available for using the transceiver with a DC power supply in your home.

Make sure the ground terminal of the DC power supply is grounded.

### CONNECTING TO A DC POWER SUPPLY

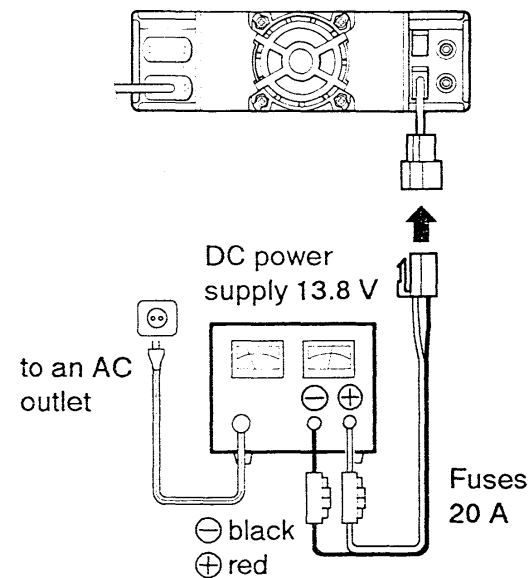

See p. 85 for fuse replacement.

## 2 INSTALLATION

### ■ Antenna installation

#### ◇ Antenna location

To obtain maximum performance from the transceiver, select a high-quality antenna and mount it in a good location. A non-radial antenna should be used when using a magnetic mount.

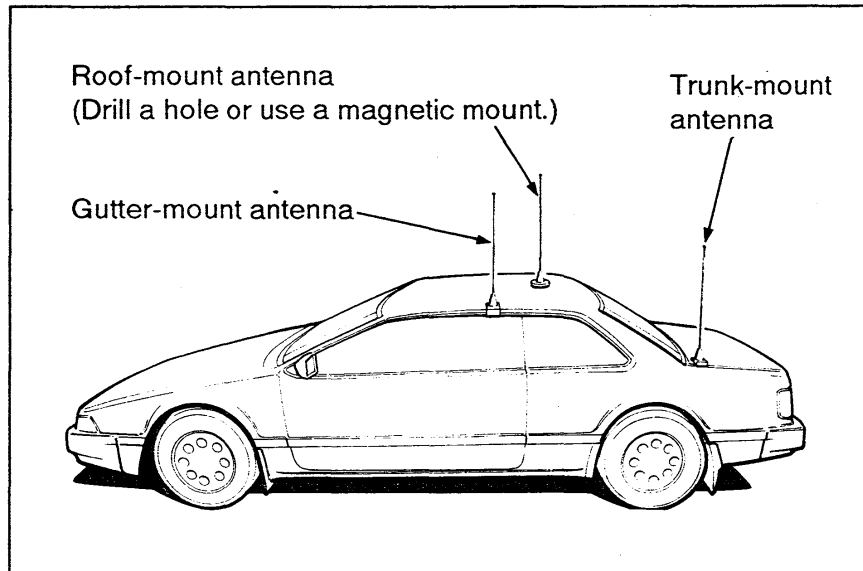

#### ◇ Antenna connector

The antenna uses a PL-259 connector.

##### • PL-259 CONNECTOR

- ① Slide the coupling ring over the coaxial cable.

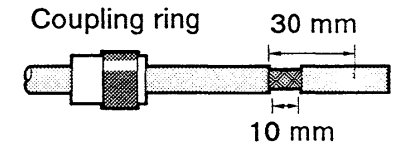

- ② Strip the cable as shown in the diagram, and soft solder the center conductor.

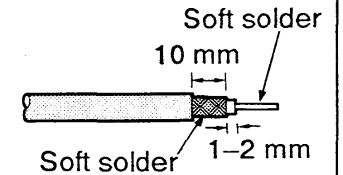

- ③ Slide the connector body onto the cable and solder.

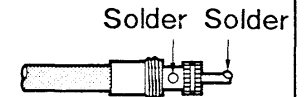

- ④ Screw the coupling ring onto the connector body.



30 mm  $\approx$  9/8 in  
10 mm  $\approx$  3/8 in  
1-2 mm  $\approx$  1/16 in

◇ **Antenna splitter connections**

You can use a dual band antenna because a duplexer is installed in the transceiver. However, an external duplexer must be connected when using a separate antenna for each band.

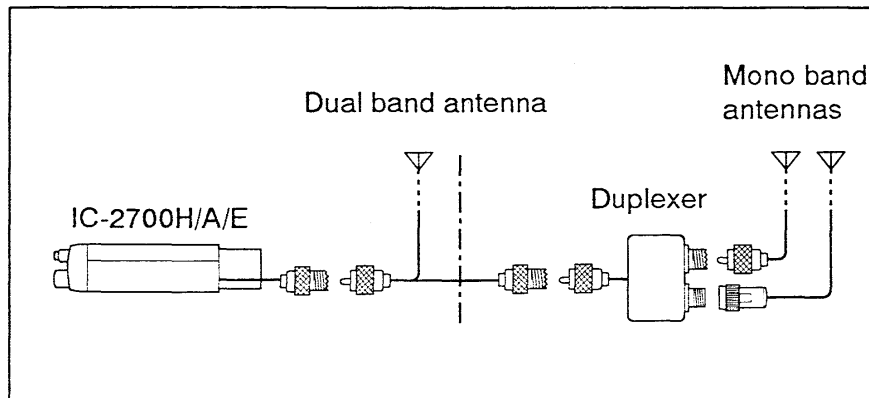

# 3

## MODE ARRANGEMENT CHART

Although the following chart refers only to the VHF band, the transceiver has the same mode arrangement in the UHF band.

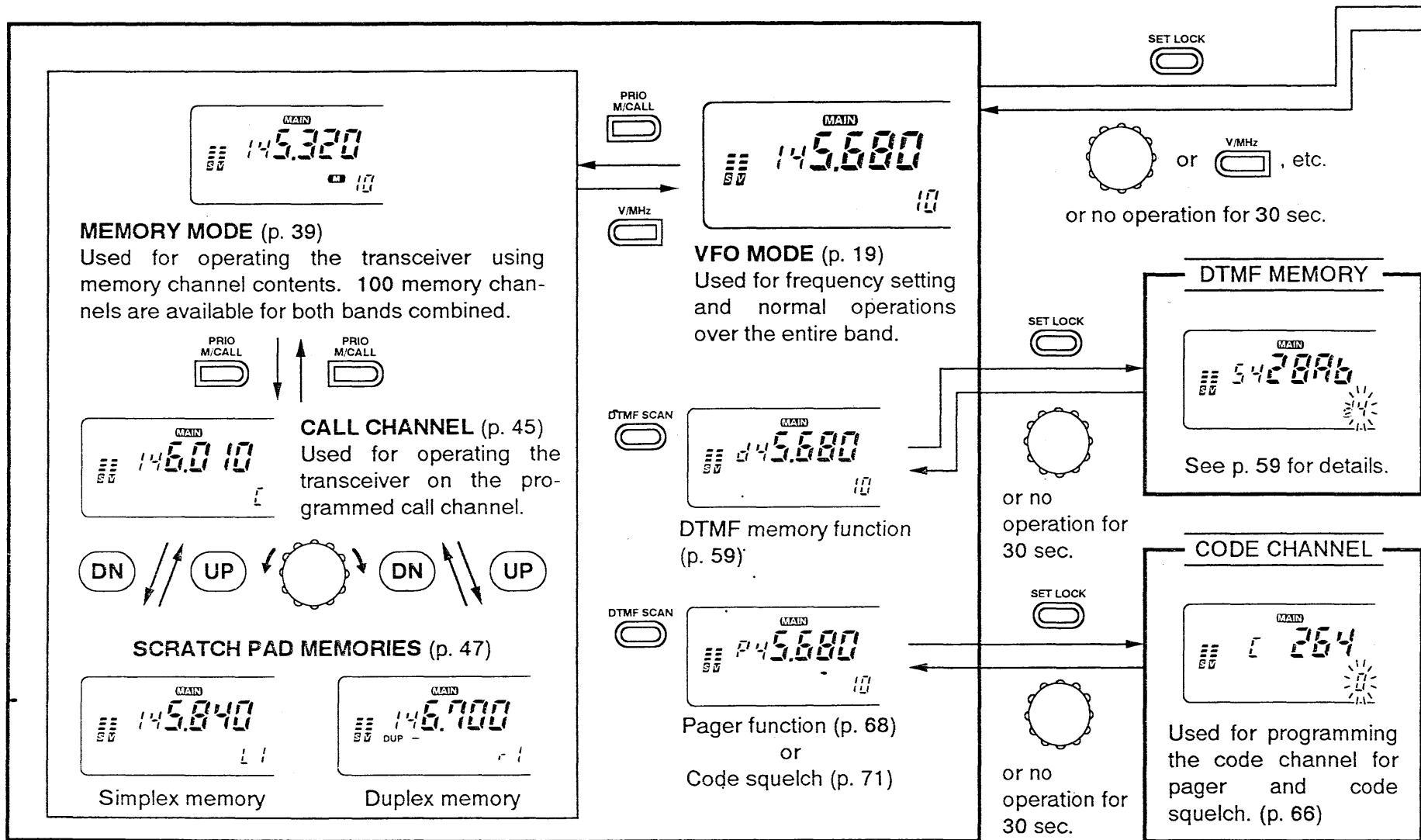



## SET MODE

Display dimmer  
(p. 26)

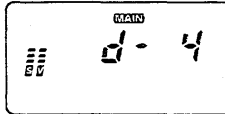

Subaudible tone frequency\*<sup>1</sup> (p. 35)



Offset frequency  
(p. 36)

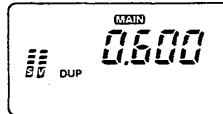

Tuning step selection\*<sup>2</sup> (p. 22)

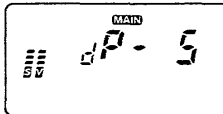

DTMF speed  
(p. 62)

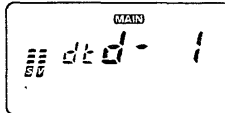

Audio output selection  
(p. 77)

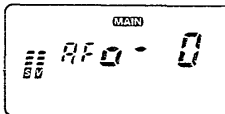

Sub band mute/  
Sub band busy  
beep (p. 28)

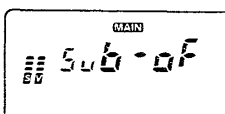

Skip channel  
setting\*<sup>3</sup> (p. 55)

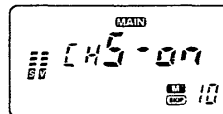

Memory area setting  
(p. 43)

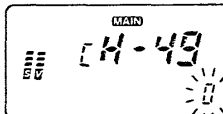

Scan resume  
condition (p. 56)

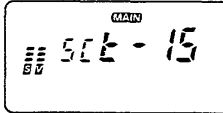

Scan edge  
selection (p. 51)

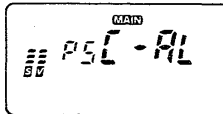

\*<sup>1</sup> Appears for the U.S.A. or Korea version or when the UT-84 is installed.

\*<sup>2</sup> Selectable only when entering set mode from VFO mode.

\*<sup>3</sup> Selectable only when entering set mode from memory mode.

**NOTE:** These displays show the default settings except for the offset frequency and tuning step setting.

## INITIAL SET MODE

SET LOCK + Power ON to entering;  
power OFF to exit.

Beep tone on/off (p. 78)

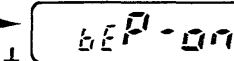

Time-out timer (p. 78)

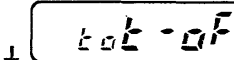

Auto repeater\*<sup>4</sup> (p. 38)

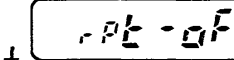

Memory channel allocation (p. 44)

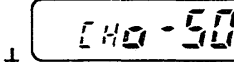

Auto power-off (p. 79)



Cooling fan setting (p. 79)

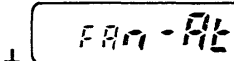

Voice synthesizer\*<sup>5</sup> (p. 81)

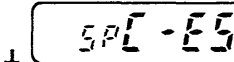

Microphone address (p. 80)

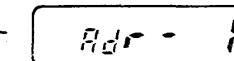

\*<sup>4</sup> Appears for the U.S.A. version.

\*<sup>5</sup> Appears when an optional UT-66 is installed.

# 4

## SETTING A FREQUENCY

### ■ Pre-operation

#### ◇ Turning power ON

Push [POWER] for 1 sec. to turn power ON.

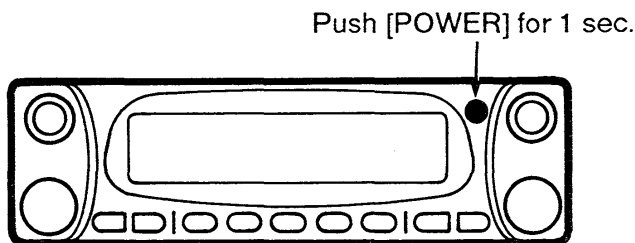

#### ◇ Main band

The IC-2700H/A/E can receive 144 MHz and 430(440) MHz band signals simultaneously. To activate all functions or to change frequency via the microphone, you must designate one band as the main band. The transceiver can transmit a signal on the main band only.

Push the desired band's tuning dial to select the main band.

- " **MAIN** " indicator shows the selected band as the main band.



Push the desired band switch [BAND SELECT ▲] or [▼] to select the main band.

#### ◇ VFO and memory modes

The transceiver has 2 normal operating modes: VFO mode and memory mode. You can select VFO mode or memory mode independently on each band.

Push the desired band's [V/MHz] to select VFO mode when the transceiver is not in VFO mode.

- If VFO mode is already selected, the digits below 100 kHz disappear. In this case, push [V/MHz] again.

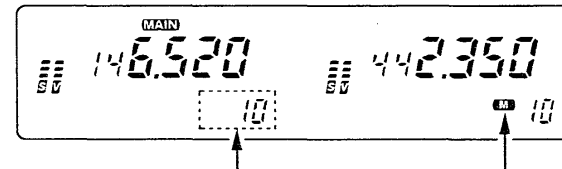

VFO mode is selected. Indicates memory mode.



Push [③ VFO] to select VFO mode.

- The microphone controls the main band only. Push the desired band switch: [BAND SELECT ▲] or [▼] in advance to change the main band.

#### ◇ Microphone address

The HM-92/A and optional HM-90/A have 8 possible control addresses. If the transceiver cannot be controlled from these microphones, check the microphone address. (p. 80)

## Lock functions

To prevent accidental frequency changes and unnecessary function access, use the lock function. The transceiver has 3 kinds of lock functions for your needs.

### ◇ Frequency lock

This function locks the tuning dials and switches electronically. This function can be used together with the microphone all lock or microphone rear lock functions.

Push and hold [SET•LOCK] until "L" appears in the memory channel readout to activate the function.

- To cancel the function, push and hold [SET•LOCK] until "L" disappears.
- [PTT], [BAND], [MONI], [MUTE], [VOL], [SQL] and the optional [SPCH] can be used while the frequency lock function is in use. DTMF tone or DTMF memory contents can be transmitted from the microphone.

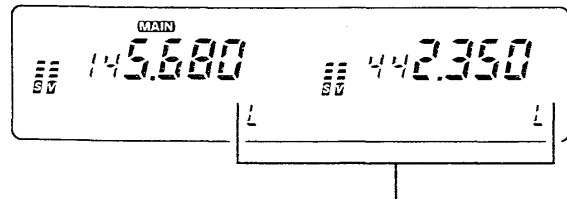

2 "L" 's appear while the frequency lock function is in use.

### ◇ Microphone all lock

This function locks all switches on the microphone except for [PTT].



Push [LOCK] to turn the function ON and OFF.

- All switches and tuning dials on the transceiver and [PTT] can be used while the microphone all lock function is in use.
- The microphone rear lock function is cancelled if previously activated.

### ◇ Microphone rear lock

This function locks all switches on the microphone rear panel except [LOCK].

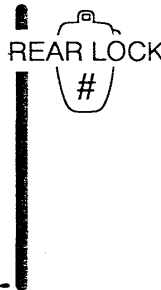

Push [FUNC] then [Ⓜ REAR LOCK] to turn the function ON and OFF.

- All switches and tuning dials on the transceiver and the microphone front panel can be used while the microphone rear lock function is in use.
- The microphone all lock function is cancelled if previously activated.

## 4 SETTING A FREQUENCY

### ■ Using a tuning dial

- ① Rotate the desired band's tuning dial to set the frequency.
  - If VFO mode is not selected, push the same band's [V/MHz] to select VFO mode.
  - Frequency changes according to the selected tuning steps. (p. 22)
- ② For the 1 MHz frequency setting, rotate the same band's tuning dial after pushing [V/MHz].
  - Pushing [V/MHz] for 1 sec. selects the 10 MHz tuning step in some versions.

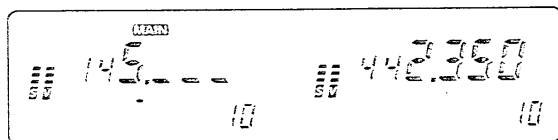

The display shows that the 1 MHz tuning step is selected in VHF.

### ■ Using [UP]/[DN] switches



Push [UP] or [DN] to set the main band's frequency in the selected tuning steps.



- If VFO mode is not selected, push [③ VFO] to select VFO mode.
- Frequency changes according to the selected tuning steps. (p. 22)
- Pushing [UP] or [DN] for more than 0.5 sec. will activate a scan.
- If a scan is started, push [UP] or [DN] again to stop it.

**NOTE** (except for the HM-92/A and HM-90/A)

While the External DTMF Remote is in standby ("REMO" appears), [UP] and [DN] cannot be used for frequency setting. In this case, push [DTMF] once or twice to clear the "REMO" indicator. (p. 63)

## Tuning step selection

*SET mode*

Tuning steps are the minimum frequency change increments when you rotate the tuning dial or push the [UP]/[DN] keys on the microphone. Separate tuning steps can be specified for each band. The following tuning steps are available.

- 5 kHz
- 10 kHz
- 12.5 kHz
- 15 kHz
- 20 kHz
- 25 kHz
- 30 kHz
- 50 kHz

**NOTE:** For your convenience, select a tuning step that matches the frequency intervals of repeaters in your area.

- ① Push the desired band's tuning dial.
- ② Push the selected band's [V/MHz] to select VFO mode if another mode has been selected.
- ③ Push [SET] one or more times until "dP" appears as shown at right.
  - Pushing [SPCH] reverses the order. (p. 18)
  - Cancel the pager, code squelch or DTMF memory function in advance. (pgs. 59, 68, 71)

- ④ Rotate the selected band's tuning dial to select the tuning step.
- ⑤ Push the selected band's tuning dial to exit set mode.

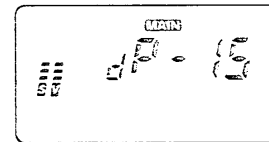

15 kHz tuning step

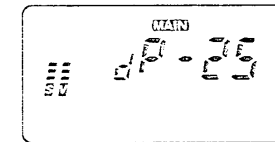

25 kHz tuning step



- ① Push the desired band switch.
- ② Push [③ VFO] to select VFO mode.
- ③ Push [SET] one or more times until "dP" appears as shown above.
  - Pushing [SPCH] reverses the order. (p. 18)
  - Cancel the pager, code squelch or DTMF memory function in advance. (pgs. 59, 68, 71)
- ④ Push [UP] or [DN] to select the tuning step.
- ⑤ Push [CLR] to exit set mode.

## 4 SETTING A FREQUENCY

### Using the keyboard

The frequency can be directly set via numeral keys on the microphone.

- 1 Push the desired band switch.
- 2 Push [VFO] to select VFO mode.
- 3 Push [ENT] to activate the keyboard for digit input.
- 4 Push 5 appropriate digit keys to input a frequency.
  - When an undesired digit is input, push [ENT] to clear the input, then input from the 1st digit.
  - Pushing [CLR] clears input digits and retrieves the frequency.
  - An out-of-band frequency will be cleared automatically.
- 5 Push [UP] or [DN] to make adjustments below the 10 kHz digit, if desired.

[EXAMPLE]: Setting the frequency to 145.360 MHz.

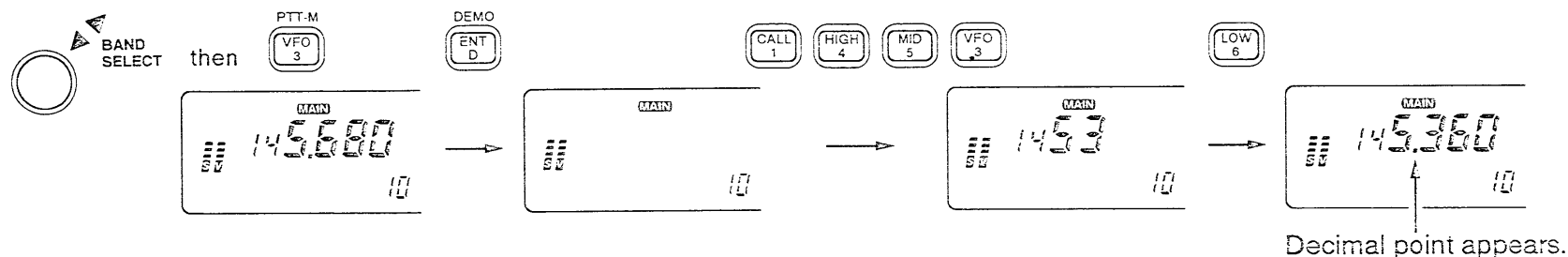

[EXAMPLE]: Setting the frequency to 446.325 MHz. (When the 25 kHz tuning step is selected in UHF.)

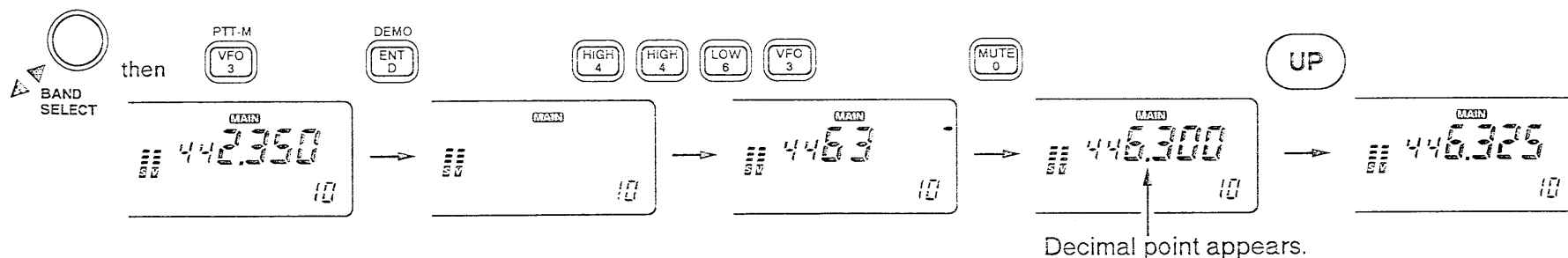

## Receiving

The IC-2700H/A/E can receive a 144 MHz and a 430(440) MHz band signal simultaneously.

- ① Push [POWER] for 1 sec. to turn power ON.
- ② Set the audio levels.
  - Rotate the desired band's [SQL] counterclockwise until noise is emitted. (Squelch opens.)
  - Rotate the same band's [VOL] to adjust the audio output level.
  - Rotate the same band's [SQL] clockwise until noise is muted. See p. 25 for setting the squelch level.
  - Set the other band's audio and squelch levels, if desired.
- ③ Set the operating frequency. (pgs. 19–23)
- ④ When receiving a signal on the set frequency, squelch opens and the transceiver emits audio.
  - "BUSY" appears and the S/R/F indicator shows the relative signal strength on the received band.

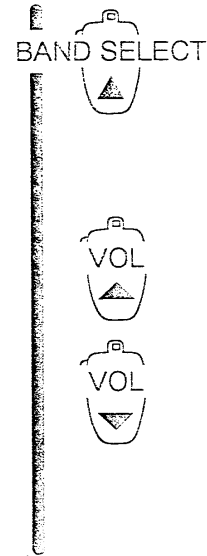

- ① Push [POWER] on the transceiver for 1 sec. to turn power ON.
- ② Set the audio levels.
  - Push the desired band switch.
  - Push [⊕SQL] one or more times until noise is emitted. (Squelch opens.)
  - Push [▲VOL] or [▼VOL] on the microphone front panel to adjust the audio output level.
  - Push [⊕SQL] one or more times until noise is muted. See p. 25 for setting the squelch level.
  - Set the other band's audio and squelch levels, if desired.
- ③ Set the operating frequency. (pgs. 19–23)

When receiving a signal on VHF.

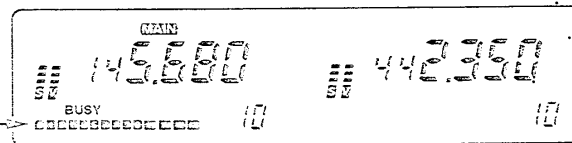

## 5 BASIC OPERATION

### ■ Setting a squelch level

A squelch circuit allows you to mute undesired audio noise while receiving no signal and emit audio while receiving signals. This provides quiet standby.

- Pushing [VOL•MONI] bypasses the squelch circuit without changing the squelch setting. This is useful for weak signal reception. (see right.)

#### ◇ 4-step digital squelch

The transceiver has 34 selectable squelch levels. For rapid and easy setting, 4 preset squelch levels are available using the supplied HM-92/A or optional HM-90/A.

- 
- 1 Push the desired band switch.
  - 2 Push [⊕SQL] one or more times to set the squelch level.

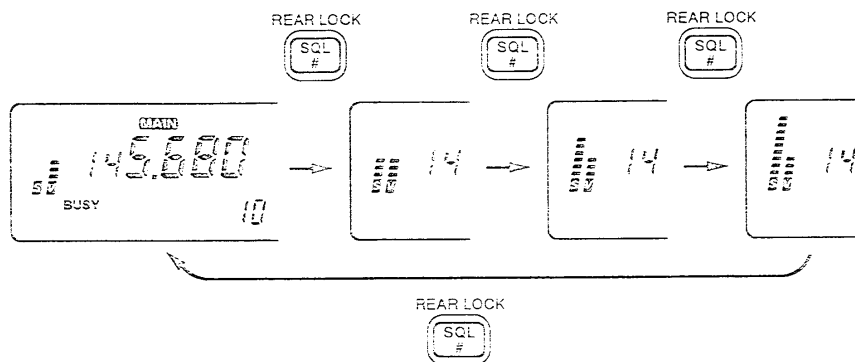

#### ◇ Manual squelch

Rotate the desired band's [SQL] to vary the squelch level manually.

- 
- 1 Push the desired band switch.
  - 2 Push [▲SQL] or [▼SQL] to adjust the squelch level.

### ■ Monitor function

This function is used to listen to weak signals without disturbing the squelch setting or to open the desired band's squelch manually even when the pager, code squelch, optional pocket beep or optional tone squelch is in use.

Push and hold the desired band's [VOL•MONI] to open the desired band's squelch.

- While duplex is ON for repeater operation, the transmitting frequency can be monitored with [VOL•MONI].



 The microphone has 2 kinds of monitor functions: arbitrary period type and toggle type.

- Push and hold [MONI] on the microphone front panel to open the main band's squelch.
- Push [ $\oplus$  MONI] on the microphone rear panel to open the main band's squelch.
  - Push [ $\oplus$  MONI] again to cancel the function.

## Audio mute function

 This function mutes both bands' audio signals quickly without disturbing the volume settings.

- 1 Push [ $\odot$  MUTE] to mute both bands' audio signals.
  - The volume level indicators flash.
- 2 Push [ $\odot$  MUTE] again to cancel the function.
  - The volume level indicators stop flashing:

## Display dimmer setting

SET mode

Adjust the Intensity to suit lighting conditions and personal preference.

- 1 Push [SET] several times until one of "d-1"–"d-4" appears as shown below.
  - Pushing [SPCH] reverses the order. (p. 18).
  - Cancel the pager, code squelch or DTMF memory function in advance. (pgs. 59, 68, 71)
- 2 Rotate the main band's tuning dial to set the desired intensity.
  - The intensity level can be changed in 4 steps from d-1 (Dark) to d-4 (Bright).
- 3 Push the main band's tuning dial to exit set mode.

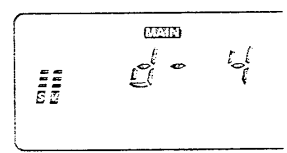

The display shows that intensity is set for "d-4" (maximum).



- 1 Push [ $\textcircled{B}$  SET] one or more times until "d-1"–"d-4" appears as shown above.
  - Pushing [ $\textcircled{C}$  SPCH] reverses the order. (p. 18).
  - Cancel the pager, code squelch or DTMF memory function in advance. (pgs. 59, 68, 71)
- 2 Push [UP] or [DN] to set the desired intensity.
  - The intensity level can be changed in 4 steps from d-1 (Dark) to d-4 (Bright).
- 3 Push [ $\textcircled{A}$  CLR] to exit set mode.

## 5 BASIC OPERATION

### ■ Sub band access

This function allows you to change sub band settings such as frequency and duplex settings, especially useful from the microphone, while transmitting or receiving on the main band.

It is easy to access the sub band and return to the main band with the band switch.

- ① Push and hold the sub band's tuning dial until "SUB" appears as shown below.
  - The main band still functions for receiving and transmitting.
  - When the main band's tuning dial is mistakenly pushed and held, the para-watch function is activated. In this case, push the main band's tuning dial for 1 sec. and repeat ① again. (p. 29)

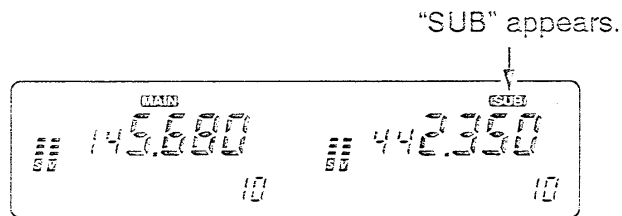

- ② Set the sub band's operating frequency or activate functions.
  - The main band's output power cannot be changed while accessing the sub band.

- ③ To exit the sub band access, push the main band's tuning dial.
  - To switch from the sub band to the main band, push the sub band's tuning dial.
  - Pushing and holding the sub band's tuning dial until "SUB" disappears also exits the sub band access.



The sub band access function is also available from the microphone and is useful for setting the sub band's frequency, etc. while operating on the main band.

- ① Push [FUNC] then the sub band's [BAND SELECT] ([▲] or [▼]).
  - "SUB" appears above the frequency display.
  - The main band still functions for receiving and transmitting.
- ② Set the sub band's operating frequency or activate functions.
  - The main band's output power cannot be changed while accessing the sub band.
- ③ To exit the sub band access, push the main band's band switch.
  - "SUB" disappears.
  - To switch from the sub band to the main band, push the sub band's band switch.

## Sub band mute/ sub band busy beep

*SET mode*

The sub band mute function automatically cuts out sub band AF signals when both main and sub band signals are received simultaneously.

The sub band busy beep sounds when the sub band's squelch is closed to inform you that the sub band's squelch has been opened.

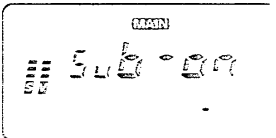

The display shows that the sub band mute is turned ON and the sub band busy beep is turned OFF.

Common setting for each band.

- ① Push [SET] one or more times until "Sub" appears in the display as shown above.
  - Pushing [SPCH] reverses the order. (p. 18)
  - Cancel the pager, code squelch or DTMF memory function in advance. (pgs. 59, 68, 71)

- ② Rotate the main band's tuning dial to set the condition.

DISPLAY	SUB BAND MUTE	BUSY BEEP
Sub - oF	OFF	OFF
Sub - oF ((•))	OFF	ON
Sub - on	ON	OFF
Sub - on ((•))	ON	ON

- ③ Push the main band's tuning dial to exit set mode.



- ① Push [B SET] one or more times until "Sub" appears in the display as shown at left.
  - Pushing [C SPCH] reverses the order. (p. 18)
  - Cancel the pager, code squelch or DTMF memory function in advance. (pgs. 59, 68, 71)
- ② Push [UP] or [DN] to set the desired condition as shown in the table above.
- ③ Push [A CLR] to exit set mode.

## 5 BASIC OPERATION

### ■ Mono band operation

If desired, one of the bands can be turned OFF. Mono band operation makes the function display simpler and reduces confusion.

#### ◇ Deactivating a band

- ① Push [POWER] to turn power OFF.
- ② While pushing a band's tuning dial, push [POWER] to turn the band OFF.
  - The frequency display disappears for the deactivated band.

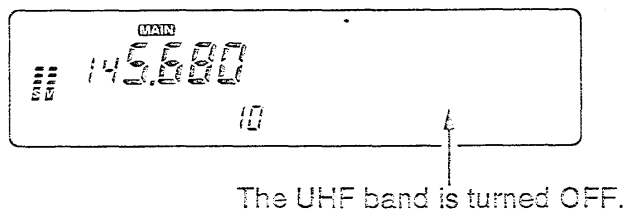

#### ◇ Activating a band

- ① Push [POWER] to turn power OFF.
- ② While pushing the deactivated band's tuning dial, push [POWER] to turn the band ON.

### ■ Para-watch

The IC-2700H/A/E can simultaneously receive 2 signals on the 144 MHz or 430(440) MHz band using the para-watch function.

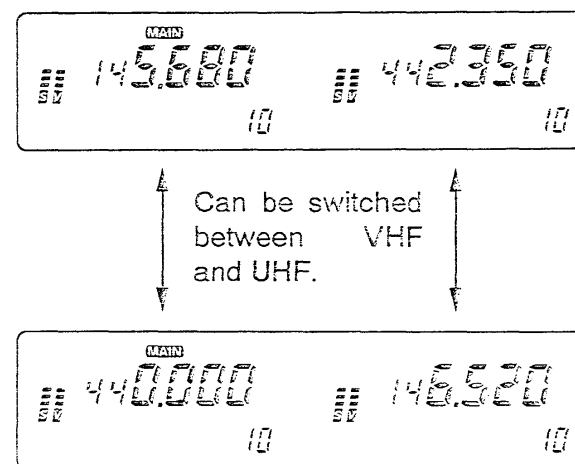

- ① Push the desired band's tuning dial.
  - The VHF band can receive a 430(440) MHz signal; the UHF band can receive a 144 MHz signal.
  - When the sub band access function is in use, push the desired band's tuning dial in advance to cancel the sub band access function.
- ② Push and hold the desired band's tuning dial until "-144-" or "-430-" appears to change the operating band.
- ③ Push and hold the desired band's tuning dial until "-144-" or "-430-" appears to cancel the function.

[EXAMPLE]

**NOTE:**

- The frequency which would normally be in the other band is weaker than normal.
- The S-meter indication on the para-watch frequency may differ from regular indication.
- Memory channels are common for the same band.
- Transmitting on the para-watch frequency is possible and the transmission quality is the same as usual.
- During main band transmitting, the receive frequency on the same band is muted.

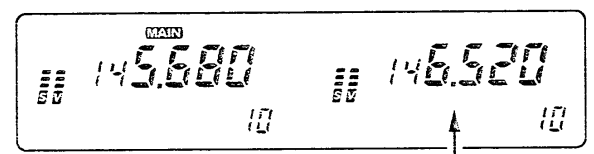

Receiving a VHF signal

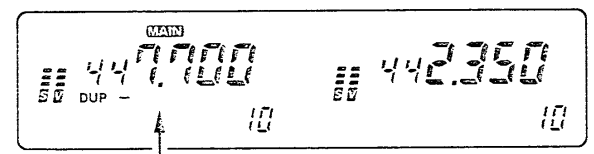

Receiving a UHF signal

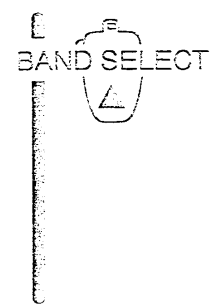

- ① Push the desired band switch.
- ② Push and hold the desired band switch until "-144-" or "-430-" appears to change the operating band.
- ③ Push and hold the desired band switch until "-144-" or "-430-" appears to cancel the function.

## 5 BASIC OPERATION

### ■ Transmitting

**CAUTION:** Transmitting without an antenna may damage the transceiver.

**NOTE:** To prevent interference, listen on the frequency before transmitting by pushing and holding the main band's [VOL•MONI] or the microphone's [MONI].

**NOTE:** To prevent howling and sensitivity rejection, AVOID setting the 430(440) MHz band frequency near a multiple of the 144 MHz MHz band frequency; e.g. setting for 145 MHz and 435 MHz.



- ① Push the desired band's tuning dial to select the main band for transmitting.
- ② Set the operating frequency. (pgs. 19–23)
  - Select output power, if desired. See section at right for details.
- ③ Push and hold [PTT] to transmit.
  - "  " appears.
  - The S/RF indicator shows the output power selection.
  - The operating frequency, etc. are automatically programmed into a scratch pad memory. See p. 47 for details.
  - One-touch PTT function is available. See p. 32 for details.

- ④ Speak into the microphone using your normal voice level.
  - DO NOT hold the microphone too close to your mouth or speak too loudly. This may distort the signal.
- ⑤ Release [PTT] to return to receive.

### ■ Selecting the output power

The transceiver has 3 output power levels to suit your operating requirements. Lower output power during short-distance communication may reduce interference to other stations and reduces current consumption.

- ① Push the desired band's tuning dial.
- ② Push [LOW] one or more times to select the desired output power.
  - The output power can be changed while transmitting.

POWER SELECTION	S/RF INDICATOR	VHF	UHF
HIGH		50 W (25 W)	35 W (25 W)
LOW 2 (LPo-2)	 LOW	10 W	10 W
LOW 1 (LPo-1)	 LOW	5 W (3 W)	5 W (3 W)

Above values are typical. Bracketed values are for the "A/E" types.



The microphone can select the desired output power directly.



① Push the desired band switch.

② Push [④ HIGH] for high output power; push [⑤ MID] for low output power 2 (middle); push [⑥ LOW] for low output power 1.



## ■ Crossband full duplex

The transceiver can receive a signal on the sub band while transmitting on the main band. Using this capability, crossband full duplex operation is possible. No special setting is necessary for crossband full duplex operation.

- ① Set the desired transmit and receive frequencies on the main and sub bands respectively for your transceiver. (pgs. 19–23)
- ② Set the same frequencies, but set the receive band as the main band for the other transceiver.
- ③ Push and hold [PTT] to operate with full duplex.
  - Transmitting and receiving activate simultaneously.
  - One-touch PTT function and time-out timer is useful for crossband full duplex operation. (p. 32, 78)

## ■ One-touch PTT function



The PTT switch can be operated as a one-touch PTT switch (transmit/receive switch). Using this function, you can transmit without pushing and holding the PTT switch.

To prevent accidental continuous transmission with the one-touch PTT function, the transceiver has a time-out timer. See p. 78 for details.

- ① Push [FUNC] then [③ PTT-M] to turn the one-touch PTT function ON.
  - The active indicator on the microphone front panel lights up in green.
- ② Push [PTT] to transmit and push it again to receive.
  - 2 beeps sound when transmission is started and a long beep sounds when returning to receive.
  - "  " blinks while transmitting with the one-touch PTT function.
- ③ Push [FUNC] then [③ PTT-M] to turn the one-touch PTT function OFF.
  - The active indicator goes out.





## ■ Tone information

### ◇ Subaudible tone

To access some closed repeaters, your transmit signal needs to include a matching subaudible tone. Turn the subaudible tone encoder ON in this case. To set the subaudible tone frequency, see "Subaudible tone" on p. 35. An optional UT-84 is necessary except for 88.5 Hz tones for non-U.S.A./Korea versions.

- ① Push [DUP·TONE] for 1 sec. one or more times until only "T" appears on the main band's display to turn ON the subaudible tone encoder.
- ② Push [DUP·TONE] for 1 sec. one or more times until "T" disappears from the main band's display to turn OFF the subaudible tone encoder.

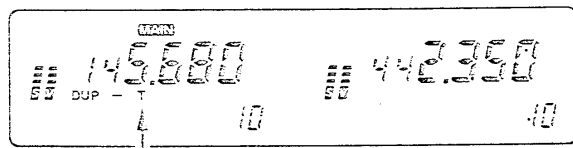

Shows that the subaudible tone encoder is ON.

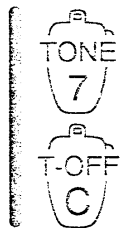

- ① Push [FUNC] then [7 TONE] to turn the subaudible tone encoder ON.
- ② Push [FUNC] then [C T-OFF] to turn the subaudible tone encoder OFF.

### ◇ DTMF tones



- Push [DTMF KEY], then push the keys of the desired DTMF digits.
  - The mode indicator lights up in green.
  - 1-0, A-D, \* (E) and # (F) are available.
  - Cancel the pager, code squelch or DTMF memory function in advance. (pgs. 59, 68, 71)
  - Push [DTMF KEY] again to set the keyboard for function control (normal condition).
  - The transceiver has 14 DTMF memory channels. See p. 59 for details.
- Push the keys of the desired DTMF digits while pushing [PTT].

### ◇ 1750 Hz tone



A 1750 Hz tone is necessary to access some European repeaters. The transceiver has 1750 Hz tone capability.

- ① Push [DTMF MEMO] to set the microphone to the DTMF memory reading condition.
  - The mode indicator lights up in orange.
- ② Push [⊗ MONI] to transmit a 1750 Hz tone call signal for 0.5 sec.; push and hold [⊕ SQL] to transmit a 1750 Hz tone call signal for a desired period.
  - The mode indicator goes out automatically.
  - The optional HM-90/A also has 1750 Hz tone capability.

## 6 REPEATER OPERATION

### Subaudible tones

*SET mode*

(An optional UT-84 is necessary for non-U.S.A./Korea versions.)

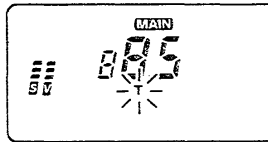

The display shows that an 88.5 Hz subaudible tone frequency is set.

Separate setting for each band.

- 1 Push the desired band's tuning dial.
- 2 Select the desired mode or channel you wish to set the subaudible tone frequency to, such as VFO mode, memory/call channel or scratch pad memory.
  - The subaudible tone frequency is independently programmed into each mode or channel.
- 3 Push [SET] one or more times until "T" appears and blinks as shown above.
  - Pushing [SPCH] reverses the order. (p. 18)
  - Cancel the pager, code squelch or DTMF memory function in advance. (pgs. 59, 68, 71)
- 4 Rotate the selected band's tuning dial to select and set the desired frequency.
- 5 Push the selected band's tuning dial to exit set mode.



- 1 Push the desired band switch.
- 2 Select the desired mode or channel you wish to set the subaudible tone frequency to, such as VFO mode, memory/call channel or scratch pad memory.
  - The subaudible tone frequency is independently programmed into each mode or channel.
- 3 Push [SET] one or more times until "T" appears and blinks as shown at left.
  - Pushing [SPCH] reverses the order. (p. 18)
  - Cancel the pager, code squelch or DTMF memory function in advance. (pgs. 59, 68, 71)
- 4 Push [UP] or [DN] to select and set the desired frequency.
  - Pushing and holding [UP] or [DN] changes the frequency continuously.
- 5 Push [CLR] to exit set mode.

• Subaudible tone frequency list (Unit: Kz)

67.0	82.5	100.0	123.0	151.4	186.2	233.6
69.3*	85.4	103.5	127.3	156.7	192.8	241.8
71.9	88.5	107.2	131.8	162.2	203.5	250.3
74.4	91.5	110.9	136.5	167.9	210.7	
77.0	94.8	114.8	141.3	173.8	218.1	
79.7	97.4	118.8	146.2	179.9	225.7	

\* The built-in tone encoder in the U.S.A./Korea versions does not have a 69.3 Hz tone.

## Offset frequency

*SET mode*

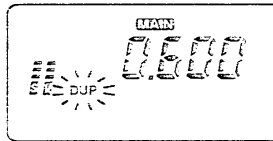

The display shows that a 0.6 MHz (600 kHz) offset frequency is set.

Separate setting for each band.

- ① Push the desired band's tuning dial.
- ② Select the desired mode or channel you wish to set the subaudible tone frequency to, such as VFO mode, memory/call channel or scratch pad memory.
  - The offset frequency is independently programmed into each mode or channel.
- ③ Push [SET] one or more times until "DUP" appears and blinks as shown above.
  - Pushing [SPCH] reverses the order. (p. 18)
  - Cancel the pager, code squelch or DTMF memory function in advance. (pgs. 59, 68, 71)
- ④ Rotate the selected band's tuning dial to set the desired frequency.
  - Selectable step increment is the same as the preset tuning step. (p. 22)
  - Use the selected band's [V/MHz] for quick MHz setting.
- ⑤ Push the selected band's tuning dial to exit set mode.



- ① Push the desired band switch.
- ② Select the desired mode or channel you wish to set the subaudible tone frequency to, such as VFO mode, memory/call channel or scratch pad memory.
  - The offset frequency is independently programmed into each mode or channel.
- ③ Push [ⓑSET] one or more times until "DUP" appears and blinks as shown at left.
  - Pushing [ⓒSPCH] reverses the order. (p. 18)
  - Cancel the pager, code squelch or DTMF memory function in advance. (pgs. 59, 68, 71)
- ④ Push [UP] or [DN] to set the desired frequency.
  - Selectable step increment is the same as the preset tuning step. (p. 22)
  - Pushing and holding [UP] or [DN] changes the frequency continuously.
- ⑤ Push [ⒶCLR] to exit set mode.

## ■ Tone scan

By monitoring a signal that is being transmitted on a repeater input frequency, you can determine the tone frequency necessary to open a repeater.

An optional UT-84 is required to activate the tone scan.

- ① Push the desired band's tuning dial.
- ② Set the desired frequency to be checked for a tone frequency. (e.g. repeater input frequency)
- ③ Push [DUP•TONE] for 1 sec., one or more times until "T SQL" appears in the function display.
- ④ Push [DTMF•SCAN] for 1 sec. to start the tone scan.
  - To change the scanning direction, rotate the selected band's tuning dial.
- ⑤ When the tone frequency is matched, the squelch opens and the tone frequency is programmed into the selected mode such as VFO, memory/call channel or scratch pad memory.
- ⑥ Push [DTMF•SCAN] to stop the scan.
- ⑦ Push [DUP•TONE] for 1 sec. twice to activate the tone encoder with the detected tone frequency.

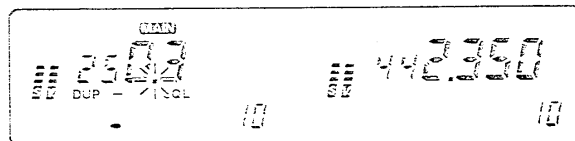

- ① Push the desired band switch.
- ② Set the desired frequency to be checked for a tone frequency. (e.g. repeater input frequency)
- ③ Push [FUNC] then [9 T SQL] to turn the tone squelch ON.
- ④ Push [FUNC] then [⊕ SCAN] to start the tone scan.
- ⑤ When the tone frequency is matched, the squelch opens and the tone frequency is programmed into the selected mode such as VFO, memory/call channel or scratch pad memory.
- ⑥ Push [Ⓐ CLR] to stop the scan.
- ⑦ Push [FUNC] then [7 TONE] to activate the tone encoder with the detected tone frequency.

## ■ Auto repeater INITIAL SET mode (U.S.A. version only)

The U.S.A. version automatically activates the repeater settings (DUP or DUP – and tone encoder ON/OFF) when the operating frequency falls within the general repeater output frequency range and deactivates them when outside of the range.

### ◇ Setting the auto repeater function ON/OFF

- ① Push [POWER] to turn power OFF.
- ② While pushing [SET], turn power ON to enter initial set mode.
- ③ Push [SET] twice to select the “rPt” display as shown below.
- ④ Rotate the left-hand tuning dial to turn the auto repeater function ON (“rPt-r1” or “rPt-r2”) or OFF (“rPt-oF”).
  - “rPt-r1” and “rPt-r2” automatically set the duplex setting and duplex/tone encoder settings, respectively.
- ⑤ Turn power OFF to exit initial set mode.

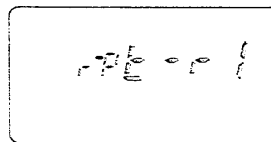

Duplex setting: Automatic  
Tone encoder: Automatic OFF

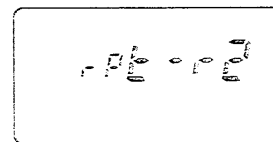

Duplex setting: Automatic  
Tone encoder: Automatic ON

### ◇ Frequency range and offset direction

FREQUENCY RANGE	DUPLEX DIRECTION
145.200–145.495 MHz 146.610–146.995 MHz	“DUP –” appears.
147.000–147.395 MHz	“DUP” appears.
442.000–444.995 MHz	“DUP” appears.
447.000–449.995 MHz	“DUP –” appears.

## ■ General description

The transceiver has 50 regular memory channels plus 6 scan edge memory channels on each band; each of these can be individually programmed with the following data.

- Operating frequency (pgs. 19–23)
- Duplex direction (DUP or DUP –) (p. 33)
- Offset frequency (p. 36)
- Subaudible tone frequency\*<sup>1</sup> (p. 35)
- Subaudible tone encoder ON/OFF (p. 34)
- Tone squelch ON/OFF\*<sup>2</sup> (p. 73)
- Skip information\*<sup>3</sup> (p. 55)

\*<sup>1</sup> An optional UT-84 TONE SQUELCH UNIT is necessary for non-U.S.A./Korea versions.

\*<sup>2</sup> An optional UT-84 TONE SQUELCH UNIT is necessary.

\*<sup>3</sup> Except for the scan edge memory channels.

Memory channels can be added or subtracted to either band. Using initial set mode, 20–80 channels can be allocated to a band in 10 channel steps for a maximum of 80 channels for a given band (maximum of 100 channels for both bands combined). See p. 44 for details.

In addition, the accessible memory channel area can be restricted to speed up memory channel selection, etc. (p. 43)

## ■ Memory channel selection

### ◇ Using a tuning dial

- ① Push the desired band's [M/CALL] once or twice to display "MR" and a memory channel number.
- ② Rotate the same band's tuning dial to select the desired memory channel.

### ◇ Using [UP]/[DN] switches



- ① Push the desired band switch.
- ② Push [②MR] to select memory mode.
- ③ Push [UP] or [DN] several times to select the desired memory channel.



- Pushing [UP] or [DN] for more than 0.5 sec. will activate a scan.
- If a scan is started, push [UP] or [DN] again to stop it.

### ◇ Using the keyboard



- ① Push the desired band switch.
- ② Push [②MR] to select memory mode.
- ③ Push [ⓈENT] to activate the keyboard for numeral input.



- ④ Push 2 appropriate digit keys to input a channel number.
- Any memory channel which is outside of the memory area is cleared. (p. 43)

## ■ Programming a memory channel

VFO mode settings, including the set mode contents such as subaudible tone frequency, etc., are programmed into a memory channel.

- ① Push the desired band's tuning dial.
- ② Select the memory channel to be programmed:
  - Select memory mode by pushing the selected band's [M/CALL] once or twice. ("MEM" appears.)
  - Rotate the selected band's tuning dial to select the memory channel.
- ③ Set the desired frequency in VFO mode:
  - Push the selected band's [V/MHz] to select VFO mode.
  - Set the frequency using the selected band's tuning dial.
  - Set other data (e.g. offset frequency, duplex direction, subaudible tone encoder ON/OFF and its frequency), if required.
- ④ Push [SPCH·MW] for 1 sec. to program.
  - 3 beeps may sound and the VFO contents (including the subaudible tone frequency, etc.) are programmed.
  - Memory channel number advances when continuously pushing [SPCH·MW] for 1 sec. after programming. (p. 44)

[EXAMPLE]: Programming 145.870 MHz into memory channel 20 via the remote controller.

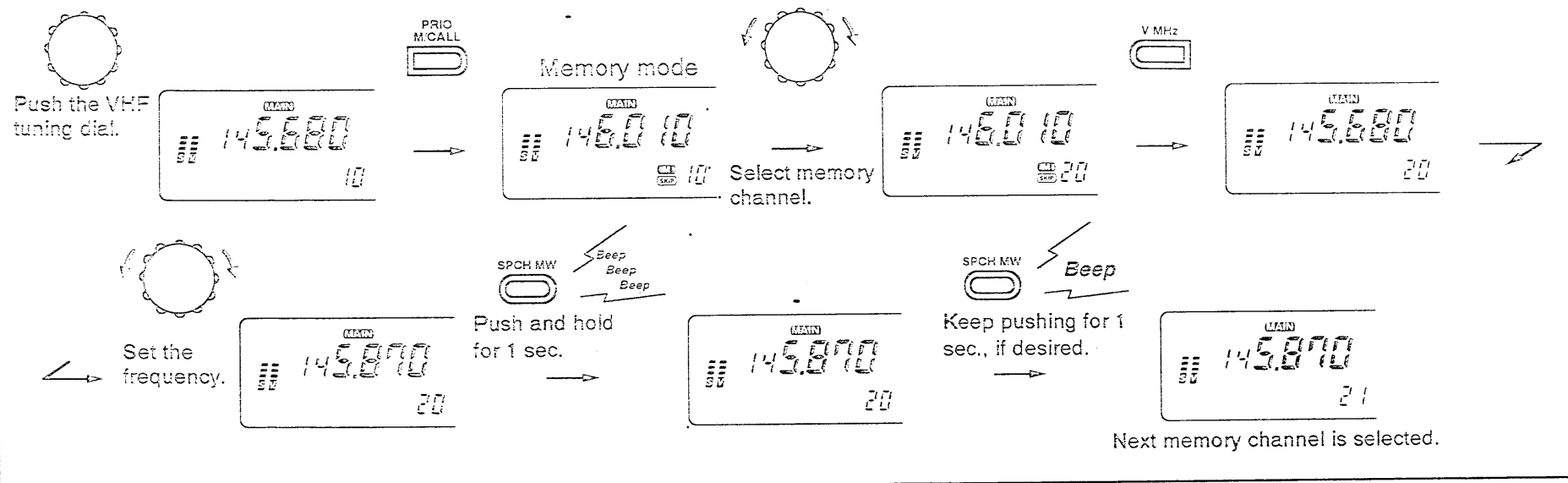

## ■ Programming a memory channel via the microphone

 Memory channel programming can be performed via the microphone.

- 1 Push the desired band switch.
- 2 Select the memory channel to be programmed:
  - Push [MR] to select memory mode. ("MEM" appears.)
  - Push [UP] or [DN] to select the memory channel; or push [ENT] then push the desired memory channel number (2 digits) to select the memory channel directly.
- 3 Set the desired frequency in VFO mode:
  - Push [VFO] to select VFO mode.
  - Set the frequency using the keyboard.
  - Set other data (e.g. offset frequency, duplex direction, sub-audible tone encoder ON/OFF and its frequency), if required.
- 4 Push [FUNC] then [MW] for 1 sec. to program.
  - 3 beeps may sound and the VFO contents (including the subaudible tone frequency, etc.) are programmed.
  - Memory channel number advances when continuously pushing [MW] for 1 sec. after programming. (p. 44)

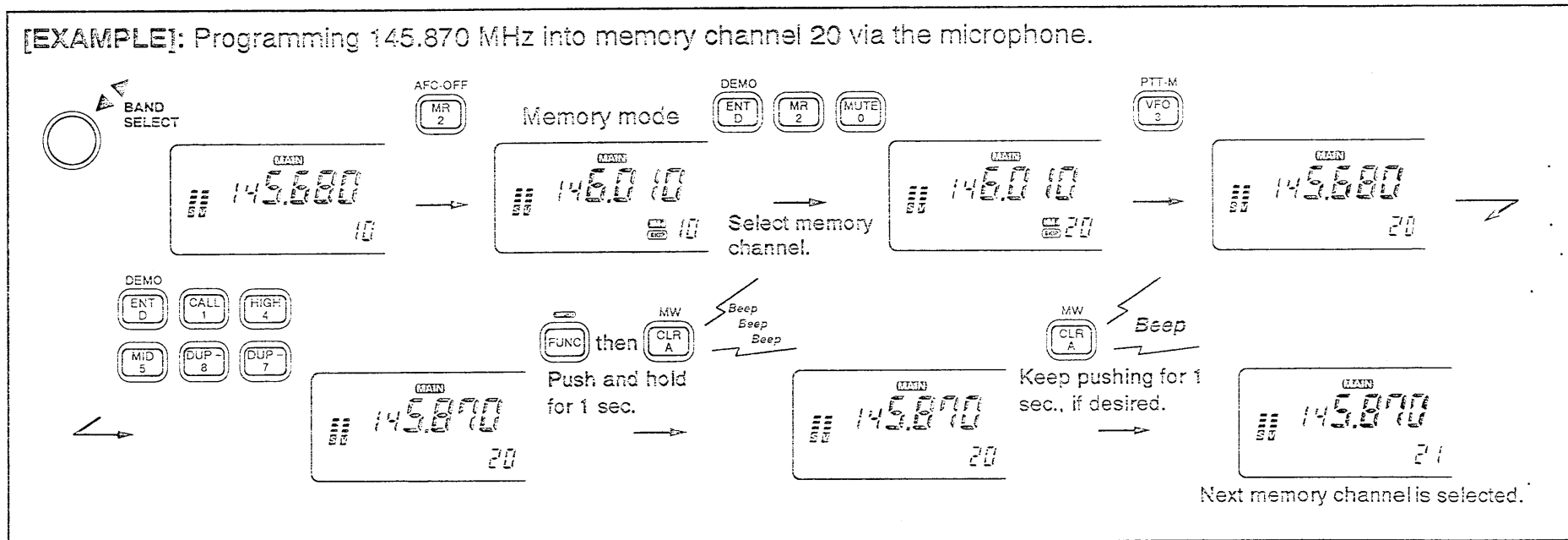



## ■ Transferring memory contents

This function transfers a memory channel's contents into a VFO. This is useful when searching for signals around a memory channel frequency and for recalling the offset frequency, subaudible tone frequency, etc.

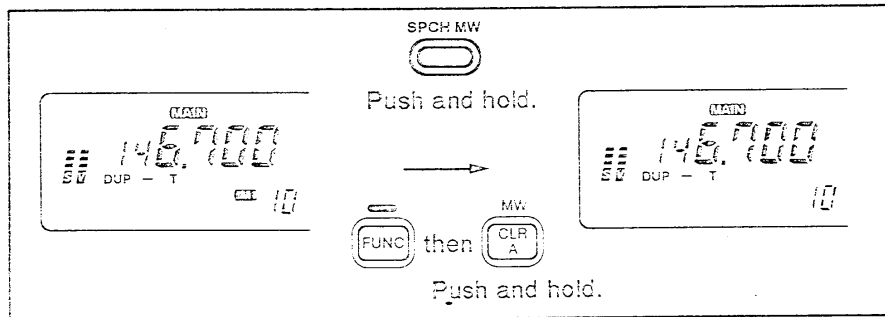

- ① Push the desired band's tuning dial.
- ② Select the memory channel to be transferred:
  - Select memory mode by pushing the selected band's [M/CALL] once or twice. ("MW" appears.)
  - Rotate the selected band's tuning dial to select the memory channel.
- ③ Push [SPCH·MW] for 1 sec.
  - "MW" disappears as VFO mode is automatically selected.
  - 3 beeps may sound and the memory contents (including the subaudible tone frequency, etc.) are transferred.



- ① Push the desired band switch.
- ② Select the memory channel to be transferred:
  - Push [MR] to select memory mode.
  - Push [UP] or [DN] to select the memory channel; or push [ENT] then the desired memory channel number (2 digits) to select the memory channel directly.
- ③ Push [FUNC] then [MW] for 1 sec.
  - "MW" disappears as VFO mode is automatically selected.
  - 3 beeps may sound and the memory contents (including the subaudible tone frequency, etc.) are transferred.

## Memory area setting *SET mode*

The usable range of memory channels on each band can be specified. This function speeds up memory scan or memory channel selection with the tuning dial or [UP]/[DN] keys. Memory area setting does not clear the memory contents.

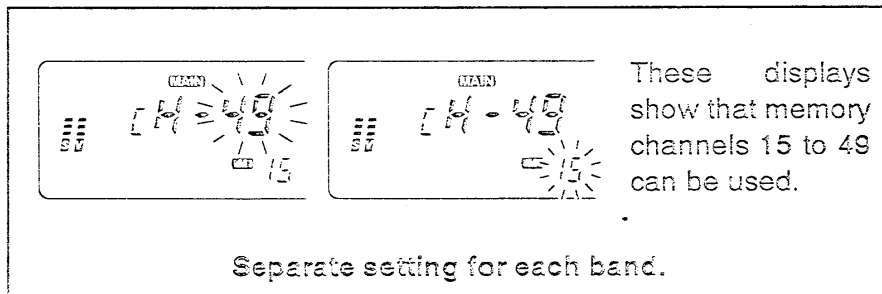

- ① Push the desired band's tuning dial.
- ② Push [SET] one or more times until "CH-49" (or another number) appears and "-49" blinks as shown above left.
  - Pushing [SPCH] reverses the order. (p. 18)
  - Cancel the pager, code squelch or DTMF memory function in advance. (pgs. 59, 68, 71)
- ③ Rotate the selected band's tuning dial to set the desired channel number.
- ④ Push [SET]; then, rotate the selected band's tuning dial to set the other edge channel number.
- ⑤ Push the selected band's tuning dial to exit set mode.



- ① Push the desired band switch.
- ② Push [B SET] one or more times until "CH-49" (or another number) appears and "-49" blinks as shown at left.
  - Pushing [C SPCH] reverses the order. (p. 18)
  - Cancel the pager, code squelch or DTMF memory function in advance. (pgs. 59, 68, 71)
- ③ Push [UP] or [DN] to set the desired channel number.
  - Pushing and holding [UP] or [DN] changes the channel number continuously.
- ④ Push [SET] then [UP] or [DN] to set the other edge channel number.
- ⑤ Push [A CLR] to exit set mode.

## Memory channel INITIAL SET mode allocation

A total of 100 regular memory channels are available with a default setting of 50 memory channels for each band. This default allocation for each band can be changed in 10-channel steps for a maximum of 80 channels and a minimum of 20 channels (total of 100 channels for the 2 bands combined). For convenience, allocate more channels to your most-often-used band.

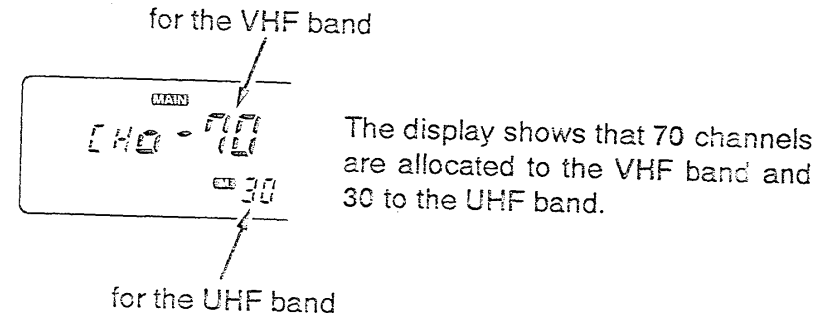

## Auto channel advance

The selected memory channel number in VFO mode automatically advances when programming a memory channel. This is useful when programming 2 or more memory channels in succession, such as during initial programming.

Push [SPCH·MW] for 2 sec. to program the VFO contents into the selected memory channel and advance the memory channel number.

- 3 beeps and a longer beep may sound.
- When you do not want to advance the memory channel number, release [SPCH·MW] after 3 beeps sound. (Memory channel programming is completed in approx. 0.5 sec.)

- ① Push [POWER] to turn power OFF.
- ② While pushing [SET], turn power ON to enter initial set mode.
- ③ Push [SET] twice (3 times for the U.S.A. version) to select the "CH0" display as shown at right.
  - "CH0-50" and "M 50" (or other numbers) appear.
- ④ Rotate the left-hand tuning dial to allocate the number of memory channels (in 10 channel steps) for each band.
  - "CH0-70" and "M 30" indicates a total of 70 channels for the VHF band and 30 channels for the UHF band. See right for an example of allocating memory channels to each band.
- ⑤ Turn power OFF to exit initial-set mode.

Subtracted band memory contents are not cleared and can be recalled by setting the previous memory channel allocation.

## ■ Calling up a call channel

Each band has an independent call channel to store a most-often-used frequency for quick recall.

- ① Push the desired band's [M/CALL] once or twice to display a large "C" in the memory channel readout.
  - To transmit on the call channel, select the desired band as the main band in advance.
- ② Push the same band's [V/MHz] or [M/CALL] to exit the call channel.

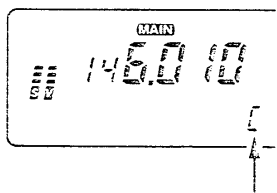

Large "C" shows the call channel is selected.

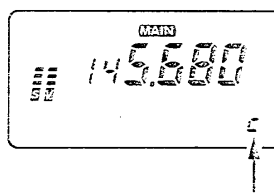

Small "c" shows VFO mode is selected from the call channel.



- ① Push the desired band switch.
- ② Push [① CALL] to select the call channel.

## ■ Transferring call channel contents

- ① Push the desired band's tuning dial.
- ② Select the call channel by pushing the selected band's [M/CALL] once or twice.
  - A large "C" appears.
- ③ Push [SPCH•MW] for 1 sec.
  - The large "C" changes to a small "c."
  - 3 beeps may sound and the call channel contents (including the subaudible tone frequency, etc.) are transferred.



- ① Push the desired band switch.
- ② Push [① CALL] to select the call channel.
- ③ Push [FUNC] then [Ⓐ MW] for 1 sec.
  - The large "C" changes to a small "c."
  - 3 beeps may sound and the call channel contents (including the subaudible tone frequency, etc.) are transferred.

## ■ Programming a call channel

In addition to an operating frequency, duplex information and subaudible tone information (tone encoder or tone squelch\*<sup>1</sup> ON/OFF and its frequency\*<sup>2</sup>) can be programmed into the call channel.

\*<sup>1</sup> An optional UT-84 is necessary.

\*<sup>2</sup> An optional UT-84 is necessary for non-U.S.A./Korea versions.

- ① Push the desired band's tuning dial.
- ② Select the call channel by pushing the selected band's [M/CALL] once or twice. (A large "C" appears.)
- ③ Set the desired frequency in VFO mode:
  - Push the selected band's [V/MHz] to select VFO mode.
  - Set the frequency using the selected band's tuning dial.
  - Set other data (e.g. offset frequency, duplex direction, sub-audible tone encoder ON/OFF and its frequency), if required.

- ④ Push [SPCH·MW] for 1 sec. to program.
  - 3 beeps may sound and the VFO contents (including the subaudible tone frequency, etc.) are programmed.



- ① Push the desired band switch.
- ② Push [① CALL] to select the call channel.
- ③ Set the desired frequency in VFO mode:
  - Push [③ VFO] to select VFO mode.
  - Set the desired frequency using the keyboard.
  - Set other data, if required.
- ④ Push [FUNC] then [Ⓐ MW] for 1 sec. to program.

[EXAMPLE]: Programming 145.120 MHz into the VHF call channel via the microphone.

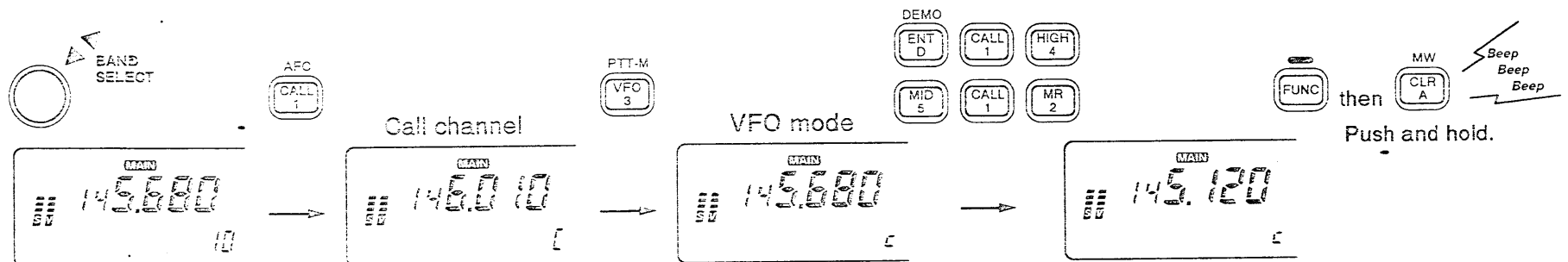

## What is a scratch pad memory

The transceiver automatically memorizes operating frequency information, separate from regular memory channels, when transmitting on a new frequency. The 3 previously operated frequencies for each band can be recalled.

When transmitting with a duplex setting (for repeater use), the operating frequency is stored into a separate scratch pad memory. 3 duplex scratch pad memories, separate from simplex scratch pad memories, are available for a total of 6 scratch pad memories for each band.

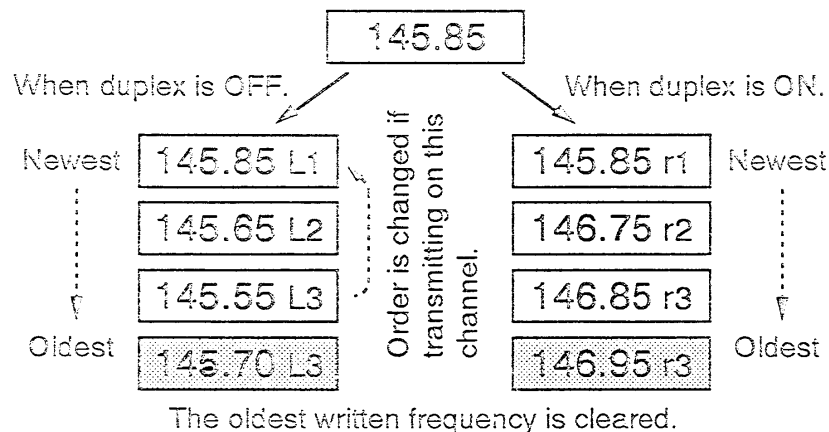

## Calling up a scratch pad memory

- ① Select the call channel by pushing the desired band's [M/CALL] once or twice. (A large "C" appears.)
  - To transmit on the scratch pad memory, select the desired band as the main band in advance.
- ② Rotate the selected band's tuning dial clockwise or push [UP] to select a duplex scratch pad memory; or rotate the tuning dial counterclockwise or push [DN] to select a simplex scratch pad memory.
  - Previously transmitted frequency and "r1"–"r3" or "L1"–"L3" appears.
  - When first applying power or after CPU resetting, scratch pad memories contain no data and therefore cannot be accessed.
- ③ Push the selected band's [V/MHz] or [M/CALL] to exit the scratch pad memory.

- The 3rd simplex or duplex scratch pad memory will be cleared when transmitting on a new frequency. If the transmit frequency is already stored in a scratch pad memory, the scratch pad memory is not cleared but the order is changed.
- When transmitting on a scratch pad memory, the scratch pad memory becomes the 1st scratch pad memory (duplex or simplex) and the order is changed.



- ① Push the desired band switch.
- ② Push [① CALL] to select the call channel.
- ③ Push [UP] one or more times to select a duplex scratch pad memory or push [DN] one or more times to select a simplex scratch pad memory.
- ④ Push [① CALL], [② MR] or [③ VFO] to exit the scratch pad memory.

## Transferring scratch pad memory contents

Transferring scratch pad memory contents to the VFO can be done in a similar manner to transferring regular memory or call channel contents.

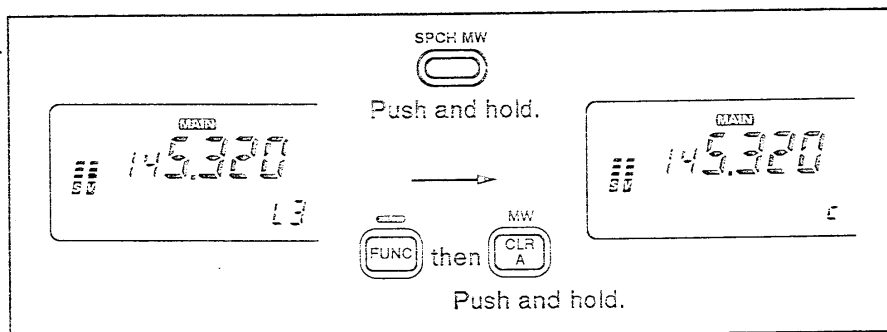

- ① Push the desired band's tuning dial.
- ② Select the call channel by pushing the selected band's [M/CALL] once or twice.
  - A large "C" appears.
- ③ Rotate the selected band's tuning dial to select the desired scratch pad memory.
  - "r1"–"r3" or "L1"–"L3" appears.
- ④ Push [SPCH•MW] for 1 sec.
  - The "r1"–"r3" or "L1"–"L3" changes to a small "c."
  - 3 beeps may sound and the scratch pad memory contents (including the subaudible tone frequency, etc.) are transferred to the VFO.



- ① Push the desired band switch.
- ② Push [① CALL] to select the call channel.
- ③ Push [UP] or [DN], one or more times to select the desired scratch pad memory.
- ④ Push [FUNC] then [Ⓐ MW] for 1 sec.
  - "r1"–"r3" or "L1"–"L3" changes to a small "c."
  - 3 beeps may sound and the scratch pad memory contents (including the subaudible tone frequency, etc.) are transferred to the VFO.

# 10 SCAN OPERATION

## ■ Scan types

Scanning searches for transmitted signals automatically and makes it easier to locate new stations for contact or listening purposes.

Each band has 3 scan types and 5 resume conditions to suit your needs. Scans on both bands can be operated separately or simultaneously.

### FULL SCAN (p. 50)

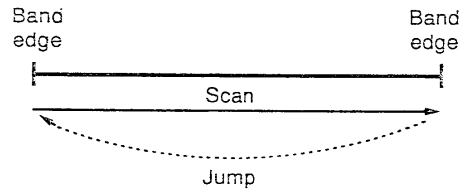

Repeatedly scans all frequencies over the entire selected band. Used as the simplest scan without any presetting.

### PROGRAMMED SCAN (p. 50)

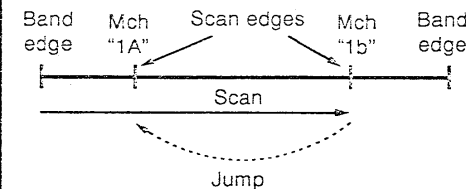

Repeatedly scans between two user-programmed frequencies. Used for checking for frequencies within a specified range such as repeater output frequencies, etc. 3 pairs of scan edges are selectable.

### MEMORY SCAN (p. 54)

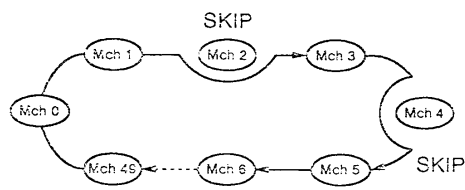

Repeatedly scans memory channels within the range of the memory area except skip channels. Used for checking often-called channels and bypassing normally busy channels such as repeater frequencies.

### SCAN RESUME CONDITION (p. 56)

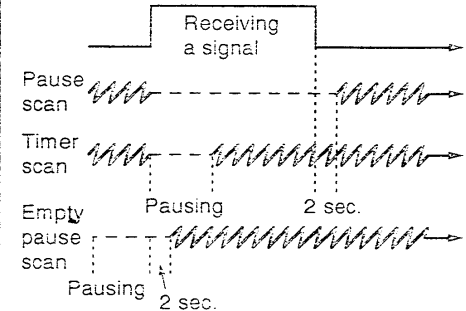

5 resume conditions are available: 3 timer scans, pause scan, empty pause scan. When receiving a signal, pause scan pauses until the signal disappears; timer scans pause for 5, 10 or 15 sec. Empty pause scan pauses until a signal appears.



## Full scan and programmed scan

- ① Push the desired band's tuning dial.
- ② Select VFO mode with the selected band's [V/MHz] switch.
- ③ Set the selected band's [SQL] to the point where noise is muted.
- ④ Select full scan or one of 3 programmed scan edges as described on p. 51.
- ⑤ Push [DTMF•SCAN] for 1 sec. to start the scan.
  - When the optional tone squelch is in use, [DTMF•SCAN] starts the tone scan. Push [UP]/[DN] for 1 sec. in this case.
  - To change the scanning direction, rotate the selected band's tuning dial.
  - Memory channel readout shows the selected scan edges as follows:
    - "AL": Full scan is selected.
    - "P1": A pair of scan edge channels "1A/1b" is selected.
    - "P2": A pair of scan edge channels "2A/2b" is selected.
    - "P3": A pair of scan edge channels "3A/3b" is selected.
- ⑥ To stop the scan, push [DTMF•SCAN].

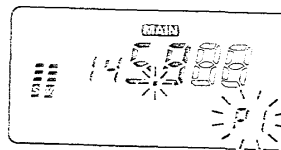

Indicates scan edge channels "1A/1b" are selected.



- ① Push the desired band switch.
- ② Push [③ VFO] to select VFO mode.
- ③ Push [⊕ SQL] one or more times until the noise is muted.
- ④ Select full scan or one of 3 programmed scan edges as described on p. 51.
- ⑤ Push [UP] or [DN] for 1 sec. to start the scan.
  - Pushing [FUNC] then [⊕ SCAN] starts an upward scan except when the optional tone squelch is in use.
- ⑥ To stop the scan, push [Ⓐ CLR] or [UP]/[DN].

### ◇ Scan resume condition:

- When receiving a signal, scan resumes in one of the following ways:
  - after pausing 15 sec.
  - after pausing 10 sec.
  - after pausing 5 sec.
  - after the signal disappears or appears.
- The scan resume condition can be selected in set mode. (p. 56)
- While scanning, rotating the tuning dial changes the scanning direction or skips a paused frequency.

# 10 SCAN OPERATION

## ■ Scan edge selection *SET mode*

The transceiver has 4 pairs of scan edges. 3 pairs of scan edges are programmable and are used for scanning within a range such as repeater output frequencies, regulated simplex frequencies, etc. The remaining scan edges are the band edges for full scan and cannot be changed.

Select the scan edges in advance to activate full scan or programmed scan as follows:

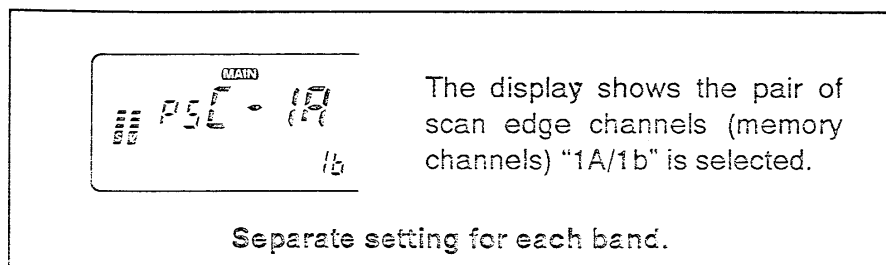

- ① Push the desired band's tuning dial.
- ② Push [SET] one or more times until "PSC" appears as shown above.
  - Pushing [SPCH] reverses the order. (p. 18)
  - Cancel the pager, code squelch or DTMF memory function in advance. (pgs. 59, 68, 71)

- ③ Rotate the selected band's tuning dial to select full scan or one of 3 programmed scan edges.
  - "PSC-AL" : Scan operates as full scan.
  - "PSC-1A/1b" : A pair of scan edge channels "1A/1b" is selected.
  - "PSC-2A/2b" : A pair of scan edge channels "2A/2b" is selected.
  - "PSC-3A/3b" : A pair of scan edge channels "3A/3b" is selected.
- ④ Push the selected band's tuning dial to exit set mode.



- ① Push the desired band switch.
- ② Push [SET] one or more times until "PSC" appears as shown at left.
  - Pushing [SPCH] reverses the order. (p. 18)
  - Cancel the pager, code squelch or DTMF memory function in advance. (pgs. 59, 68, 71)
- ③ Push [UP] or [DN] to select full scan or one of 3 programmed scan edges.
  - "PSC-AL"
  - "PSC-1A/1b"
  - "PSC-2A/2b"
  - "PSC-3A/3b"See item ③ above for description.
- ④ Push [CLR] to exit set mode.

## ■ Programming scan edges

Scan edges can be programmed in the same way as memory channels. Memory channels "1A"–"3A" and "1b"–"3b" are available for programming scan edges.

- ① Push the desired band's tuning dial.
- ② Select scan edge memory channel "1A," "2A" or "3A":
  - Select memory mode by pushing the selected band's [M/CALL] once or twice.
  - Rotate the selected band's tuning dial to select memory channel "1A," "2A" or "3A."
- ③ Push the selected band's [V/MHz] to select VFO mode.

- ④ Rotate the selected band's tuning dial to set the desired frequency.
- ⑤ Push [SPCH•MW] for 2 sec. to program and advance the memory channel number.
  - 3 beeps and a longer beep may sound, the VFO contents are programmed and the other scan edge memory channel "1b," "2b" or "3b" is selected.
- ⑥ To program a frequency for the other scan edge memory channel "1b," "2b" or "3b," repeat steps ④ and ⑤
  - If the same frequency is programmed into a pair of scan edges and the pair is selected for programmed scan, programmed scan will not function.

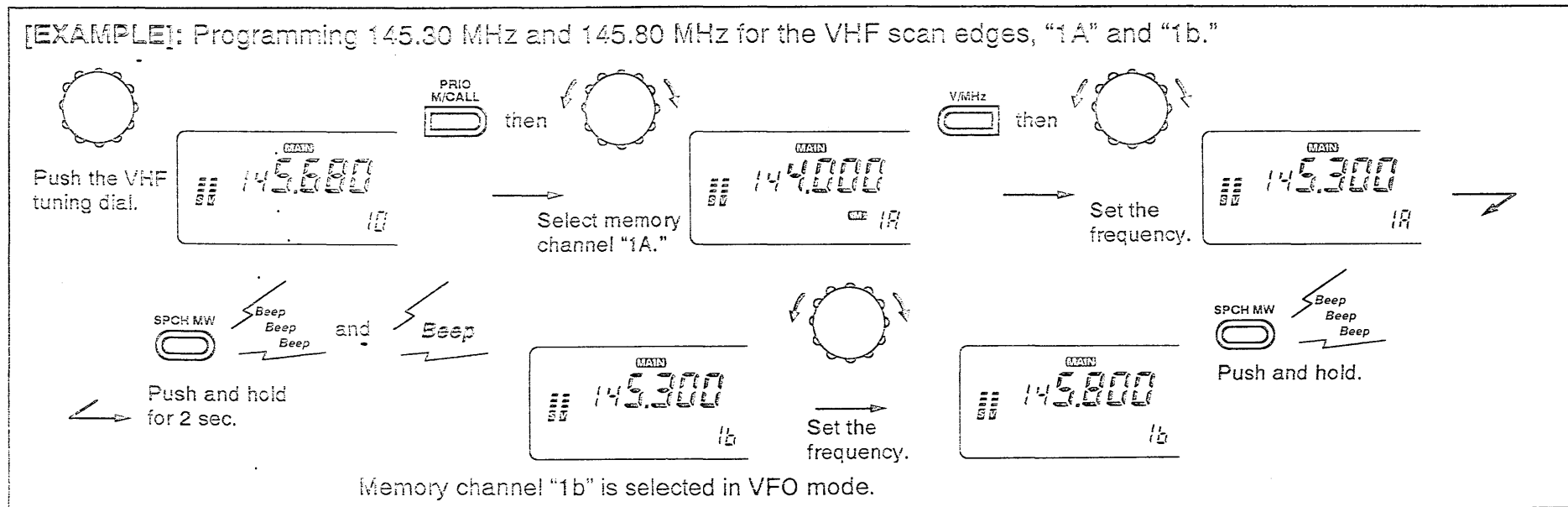

## Programming scan edges via the microphone



- 1 Push the desired band switch.
- 2 Select scan edge memory channel "1A," "2A" or "3A":
  - Push [MR] to select memory mode.
  - Push [UP] or [DN] to select memory channel "1A," "2A" or "3A."
- 3 Push [VFO] to select VFO mode.
- 4 Set the desired frequency using the keyboard.

- 5 Push [FUNC] then [MW] for 2 sec. to program and advance the memory channel number.
  - 3 beeps and a longer beep may sound, the VFO contents are programmed and the other scan edge memory channel "1b," "2b" or "3b" is selected.
- 6 To program a frequency for the other scan edge memory channel "1b," "2b" or "3b," repeat steps 4 and 5.
  - if the same frequency is programmed into a pair of scan edges and the pair is selected for programmed scan, programmed scan will not function.

[EXAMPLE]: Programming 145.30 MHz and 145.80 MHz for the VHF scan edges, "1A" and "1b."

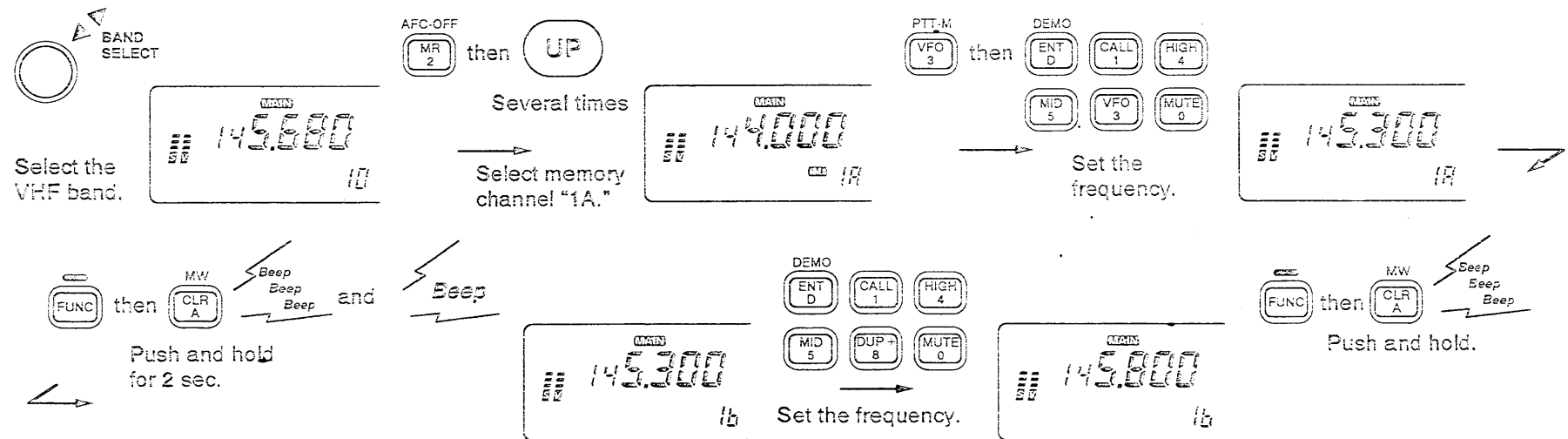

Memory channel "1b" is selected in VFO mode.

## Memory scan

Memory scan repeatedly scans all memory channels except skip channels. The skip channel setting (p. 55) and memory area setting (p. 43) are convenient to speedup the memory scan, checking the desired memory channels only.

- ① Push the desired band's tuning dial.
- ② Select memory mode by pushing the selected band's [M/CALL] once or twice.
- ③ Set the selected band's [SQL] to the point where noise is muted.
- ④ Push [DTMF•SCAN] for 1 sec. to start the scan.
  - When the optional tone squelch is in use, [DTMF•SCAN] starts the tone scan. Push [UP]/[DN] for 1 sec. in this case.
  - To change the scanning direction, rotate the selected band's tuning dial.
  - The scan resume condition is the same as the programmed scan. See p. 58 for details.
  - Set memory area, if desired. (p. 43)
- ⑤ To stop the scan, push [DTMF•SCAN].

**NOTE:** All memory channels are initially set as skip channels by default. Program 2 or more memory channels (p. 40) or cancel the skip function for 2 or more channels (p. 55) in advance.



- ① Push the desired band switch.
- ② Push [②MR] to select memory mode.
- ③ Push [#SQL] one or more times until the noise is muted.
- ④ Push [UP] or [DN] for 1 sec. to start the scan.
  - Pushing [FUNC] then [⊕SCAN] starts upward scan.
  - Set memory area, if desired. (p. 43)
  - When all memory channels are set as skip channels (default setting) or all memory channels except one memory channel are set as skip channels, memory scan does not start.
- ⑤ To stop the scan, push [UP] or [DN].

# 10 SCAN OPERATION

## ■ Skip channel setting SET mode

The memory skip function speeds up scanning by checking only desired memory channels. When first applying power or after resetting the CPU, all memory channels are specified as skip channels. Programming a memory channel automatically cancels the skip function. Set the memory channels to be skipped or scanned as follows.

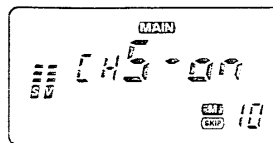

The display shows that VHF memory channel 10 is set as a skip channel.

Separate setting for each band.

- ① Push the desired band's tuning dial.
- ② Select the memory channel to program or to cancel the skip function on:
  - Select memory mode by pushing the selected band's [M/CALL] once or twice.
  - Rotate the selected band's tuning dial to select the memory channel.
- ③ Push [SET] one or more times until "CHS" appears as shown above.
  - Pushing [SPCH] reverses the order. (p. 18)

- ④ Rotate the selected band's tuning dial to turn the skip function ON or OFF on the selected channel.
  - "SKIP" appears : The memory channel is skipped during (CHS-on) memory scan.
  - "SKIP" disappears: The memory channel is scanned during (CHS-oF) memory scan.
- ⑤ Push the selected band's tuning dial to exit set mode.

**NOTE:** The scan edge memory channels (1A–3b) cannot be specified as skip channels, however, they are skipped during memory scan anyway.



- ① Push the desired band switch.
- ② Select the memory channel to cancel or to program the skip function on:
  - Push [②MR] to select memory mode.
  - Push [UP] or [DN] to select the memory channel.
- ③ Push [BSET] one or more times until "CHS" appears as shown at left.
  - Pushing [©SPCH] reverses the order. (p. 18)
- ④ Push [UP] or [DN] to set or cancel the skip information.
  - See item ④ above for skip indicator details.
- ⑤ Push [A CLR] to exit set mode.

## Scan resume condition

SET mode

The scan resume condition can be selected as timer, pause or empty pause scan. The empty pause scan is useful for finding unused frequencies. The resume condition is also used for priority watch. (p. 58)

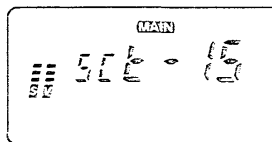

The display shows that the scan resumes 15 sec. after the scan stops.

Separate setting for each band.

- ① Push the desired band's tuning dial.
- ② Push [SET] one or more times until "SCt" or "SCP" appears as shown above.
  - Pushing [SPCH] reverses the order. (p. 18)
  - Cancel the pager, code squelch or DTMF memory function in advance. (pgs. 59, 68, 71)

- ③ Rotate the selected band's tuning dial to set the desired timer.
  - "SCt-15" : Scan pauses 15 sec. while receiving a signal.
  - "SCt-10" : Scan pauses 10 sec. while receiving a signal.
  - "SCt- 5" : Scan pauses 5 sec. while receiving a signal.
  - "SCP- 2" : Scan pauses until the signal disappears and then resumes 2 sec. thereafter.
  - "SCt-EP" : Scan pauses on a frequency that is not busy and resumes 2 sec. after a signal appears.
- ④ Push the selected band's tuning dial to exit set mode.



- ① Push the desired band switch.
- ② Push [B SET] one or more times until "SCt" or "SCP" appears as shown at left.
  - Pushing [C SPCH] reverses the order. (p. 18)
  - Cancel the pager, code squelch or DTMF memory function in advance. (pgs. 59, 68, 71)
- ③ Push [UP] or [DN] to select the scan resume condition.
  - See item ③ above for the scan resume condition details.
- ④ Push [A CLR] to exit set mode.

## Priority watch types

The priority watch checks for signals on a memory or call channel every 5 sec. while operating on a VFO frequency. The transceiver has 3 priority watch types to suit your needs. You can transmit on the VFO frequency while the priority watch operates.

The watch resumes according to the selected scan resume condition. See the previous page for settings.

### NOTE:

- The priority watch cannot be started from a scratch pad memory.
- The pager, code squelch and DTMF memory functions are turned OFF when priority watch starts.
- If the optional pocket beep function is activated, the transceiver automatically selects the tone squelch function when priority watch starts.
- When "SCt-EP" is selected for the scan resume condition, the priority watch pauses on a no-signal channel. (p. 56)

### MEMORY CHANNEL WATCH (p. 58)

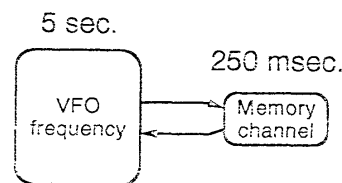

While operating on a VFO frequency, priority watch checks for a signal on the selected memory channel every 5 sec.

- A memory channel with skip information can be watched.

### MEMORY SCAN WATCH (p. 58)

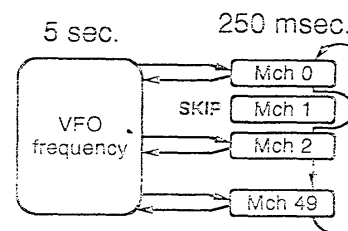

While operating on a VFO frequency, priority watch checks for signals on each memory channel in sequence.

- The memory skip function and memory area setting is useful to speedup the scan.

### CALL CHANNEL WATCH (p. 58)

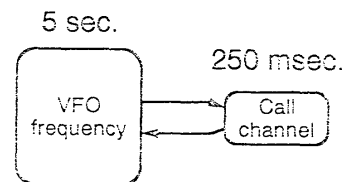

While operating on a VFO frequency, priority watch checks for a signal on the call channel every 5 sec.



## Priority watch operation

- ① Push the desired band's tuning dial.
- ② Select VFO mode; then, set an operating frequency.
- ③ Set the watching channel(s).
  - For memory channel watch:*  
Select the desired memory channel.
  - For memory scan watch:*  
Select memory mode; then, push [DTMF·SCAN] for 1 sec. to start the memory scan.
  - For call channel watch:*  
Select the call channel by pushing the selected band's [M/CALL] once or twice.
- ④ Push the selected band's [M/CALL·PRIO] for 1 sec. to start the watch.
  - The transceiver checks the memory or call channel frequency every 5 sec.
  - The watch resumes according to the selected scan resume condition. (p. 56)
  - While the watch is pausing, pushing the selected band's [M/CALL] resumes the watch manually.
- ⑤ Push the selected band's [M/CALL] while the display shows the VFO frequency to stop the watch.

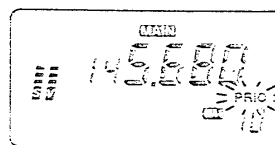

While pausing on the memory or call channel, "PRIO" blinks.



- ① Push the desired band switch.
- ② Select VFO mode; then, set an operating frequency.
- ③ Set the watching channel(s).
  - For memory channel watch:*  
Push [②MR] then [UP] or [DN] to select the desired memory channel.
  - For memory scan watch:*  
Push [②MR] then push [UP] or [DN] for 1 sec. to start the memory scan.
    - Pushing [FUNC] then [⊗SCAN] starts upward scan.
  - For call channel watch:*  
Push [①CALL] to select the call channel.
- ④ Push [FUNC] then [ⓄPRIO] to start the watch.
  - The transceiver checks the memory or call channel frequency every 5 sec.
  - The watch resumes according to the selected scan resume condition. (p. 56)
  - While the watch is pausing, pushing the selected band's [M/CALL] on the transceiver resumes the watch manually.
- ⑤ Push [ⒶCLR] while the display shows the VFO frequency to stop the watch.

# 12 DTMF MEMORY

## ■ Programming a DTMF code

DTMF codes are used for autopatching, accessing repeaters, controlling other equipment, etc. The transceiver has 14 DTMF memory channels (d0–d9, dA–dd) for storage of often-used DTMF codes of up to 24 digits.

**NOTE:** DTMF memory channels are commonly used for both bands. Therefore, programming each band is not necessary.

- ① Push [DTMF] 3 times and “d” appears in place of the main band’s 100 MHz digit as shown below.

“d” appears in place of the 100 MHz digit.

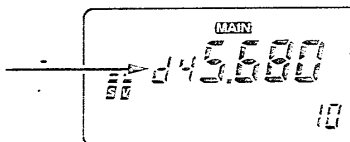

- ② Push [SET] to enter the programming condition.
- ③ Rotate the main band’s tuning dial to select the desired channel.
- ④ Push [SET] to start programming.
- ⑤ Rotate the main band’s tuning dial to select a digit.
  - “E” stands for “\*” and “F” stands for “#.”

- ⑥ Push [SET] to set the next digit.
  - If you make a mistake, push [SPCH] to backspace and rotate the main band’s tuning dial to correct the digit.
  - The S/R/F indicator shows the digit group. The indication increases every 6 digits.
  - Select “ - ” to clear the remaining digits when programming over a previously used memory channel.
- ⑦ Repeat ⑤ and ⑥ until the last digit is entered.
- ⑧ Push the main band’s tuning dial to exit the programming condition.

## ■ Clearing the DTMF memory contents

- ① Select “d” in place of the main band’s 100 MHz digit with the [DTMF] switch.
- ② Push [SET] to enter the programming condition.
- ③ Rotate the main band’s tuning dial to select the desired channel.
- ④ Push [SET] once to start programming.
- ⑤ Rotate the main band’s tuning dial to select “ - ” to clear the memory channel contents.
- ⑥ Push the main band’s tuning dial to exit the programming condition.

## Programming a DTMF code via the microphone



DTMF codes can be directly programmed via the keyboard on the microphone. The contents can be overwritten, but cannot be cleared via the microphone. See the page at left for clearing the contents.

- 1 Push [FUNC] then [6 DTMF] to turn the DTMF memory function ON.
  - "d" appears in place of the main band's 100 MHz digit.
- 2 Push [SET] to enter the programming condition.
- 3 Push [UP] or [DN] to select the desired channel.

- 4 Push the desired digit keys.
  - When the 1st digit is input, previous memory contents are cleared automatically.
  - "E" stands for "\*" and "F" stands for "#."
  - Push [UP] then [DN], and repeat this step when making a mistake.
  - The S/R/F indicator shows the digit group. The indication increases every 6 digits.
- 5 Push the band switch to exit the programming condition.
  - Pushing [PTT] also exits the condition and transmits the memory contents.

[EXAMPLE]: Programming "5428AB453" into DTMF memory channel "d4."

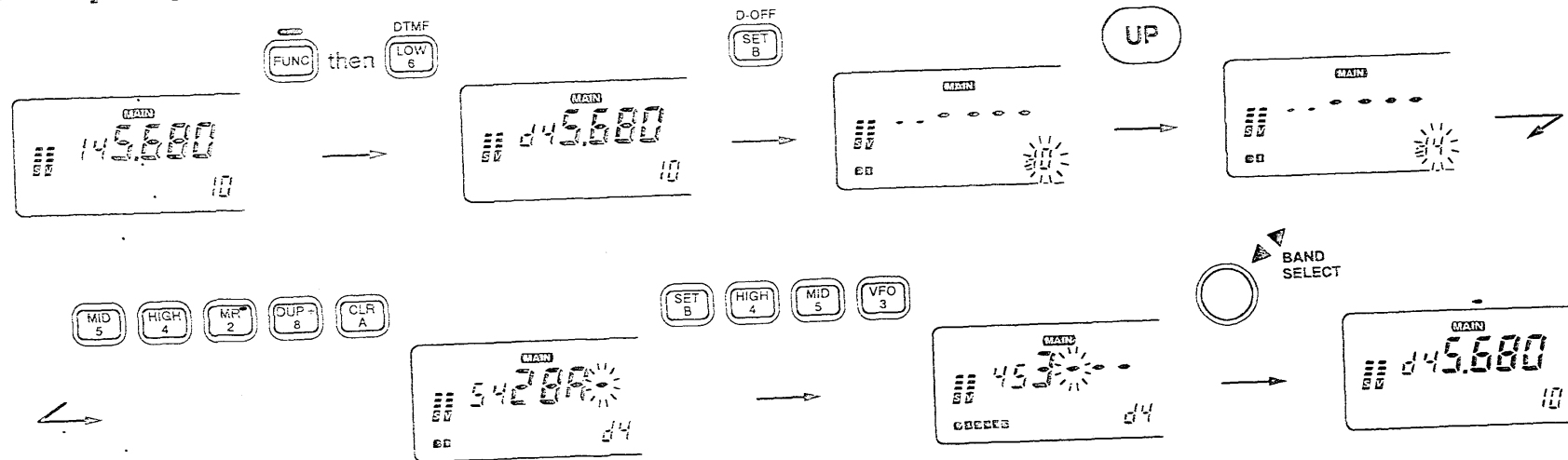

## ■ Transmitting a DTMF code

### ◇ Using the DTMF memory function (automatic transmission)

The selected DTMF code is transmitted at each push of the PTT switch when the DTMF memory function is turned ON.

- ① Select "d" in place of the main band's 100 MHz digit with the [DTMF] switch.
- ② Push [SET] to enter the programming condition.
- ③ Rotate the main band's tuning dial to select the desired DTMF memory channel.
- ④ Push [PTT] to transmit the selected DTMF code.
  - At each push of [PTT], the selected DTMF code is transmitted.
  - The speaker emits the DTMF tones sent.
- ⑤ Push [DTMF] twice to cancel the function.
  - "d" disappears and the function display shows the operating frequency. Be sure "REMO" does not appear.



- ① Push [FUNC] then [⑥DTMF] to turn the DTMF function ON.
  - "d" appears in place of the main band's 100 MHz digit.
- ② Push [③SET] to enter the programming condition.

- ③ Push [UP] or [DN] to select the desired channel.
- ④ Push [PTT] to transmit the selected DTMF code.
  - At each push of [PTT], the selected DTMF code is transmitted.
- ⑤ Push [ⒶCLR] to cancel the function.

### ◇ Transmitting a DTMF memory channel



- ① Push [DTMF MEMO] to set the keyboard for transmitting a DTMF memory channel.
  - The mode indicator lights up in orange.
- ② Push the desired DTMF memory channel number [①]–[⑨] or [Ⓐ]–[Ⓓ].
  - The memorized DTMF code is automatically transmitted.
  - The mode indicator goes out automatically.

### ◇ Transmitting a DTMF code manually



- ① Push [DTMF KEY] then the keys of the desired DTMF digits.
  - The mode indicator lights up in green.
  - 1–0, A–D, ✖ (E) and # (F) are available.
  - Cancel the pager, code squelch or DTMF memory function in advance. (pgs. 59, 68, 71)
- ② Push [DTMF KEY] again to set the keyboard for function control (normal condition).

## ■ DTMF speed

### SET mode

The sending speed of the DTMF memory can be selected from 4 speeds to suit your needs. This setting does not affect pager and code squelch operation.

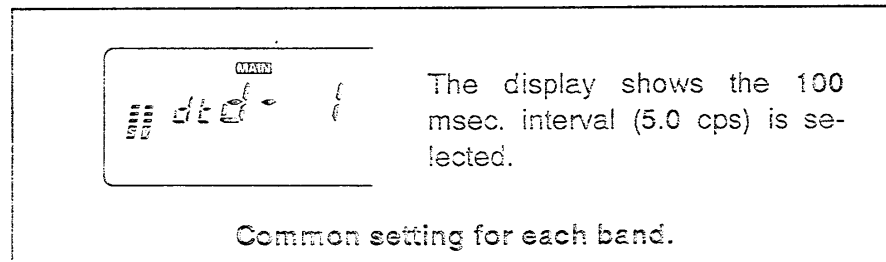

- ① Push [SET] one or more times until “dtd” appears as shown above.
  - Pushing [SPCH] reverses the order. (p. 18)
  - Cancel the pager, code squelch or DTMF memory function in advance. (pgs. 59, 68, 71)
- ② Rotate the main band’s tuning dial to select the desired speed as shown in the table below.

DISPLAY	INTERVAL	SPEED
dtd- 1	100 msec.	5.0 cps
dtd- 2	200 msec.	2.5 cps
dtd- 3	300 msec.	1.6 cps
dtd- 5	500 msec.	1.0 cps

cps =  
characters/sec.



- ① Push [SET] one or more times until “dtd” appears as shown at left.
  - Pushing [SPCH] reverses the order. (p. 18)
  - Cancel the pager, code squelch or DTMF memory function in advance. (pgs. 59, 68, 71)
- ② Push [UP] or [DN] to select the desired speed as shown in the table at left.
- ③ Push [CLR] to exit set mode.

- ③ Push the main band’s tuning dial to exit set mode.

The U.S.A. version can be remotely controlled using DTMF signals on the sub band. To operate external DTMF remote, a 144 MHz or 430(440) MHz transceiver with a DTMF encoder is necessary.

- ① Set the sub band frequency to receive a control signal (DTMF code).
  - An optional tone squelch function can be used for the sub band to increase remote control reliability. (p. 73)
- ② Program a 3-digit password into the sub band's code channel 5, if desired. (p. 67)
  - The initial value of code channel 5 is "000." If you do not require the password, set the channel as "receive inhibit."
- ③ Select the main band with pushing a tuning dial, then set the desired frequency for operation.
- ④ Push [DTMF] one or more times until "REMO" appears to select standby for the remote control.
- ⑤ Set the operating frequency of the controller transceiver equal to the sub band frequency of the IC-2700H/A/E.
  - Make sure a tone frequency is set when using the optional tone squelch function with the IC-2700H/A/E.
  - The external DTMF remote does not accept a control signal on the main band frequency.

- ⑥ From the controller transceiver, transmit the DTMF code as follows.

- "SUB" and "REMO" blink while receiving a control signal.

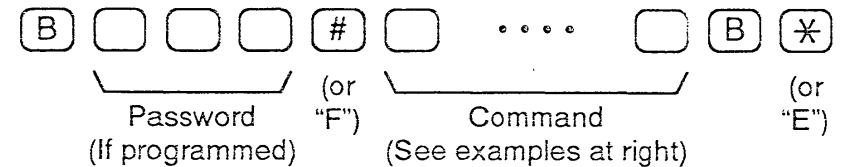

- ⑦ To cancel standby for the remote control, push [DTMF].
  - "REMO" disappears.
  - Pushing [FUNC] then [ⓑ D-OFF] also cancels standby for the remote control.

[EXAMPLE]

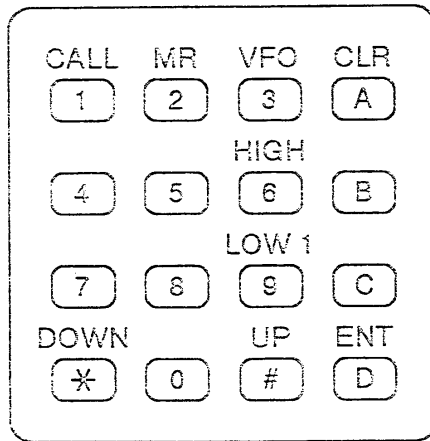

DTMF KEYBOARD

144.750 MHz

[3] [D] [1] [4] [4] [7] [5]  
 VFO mode [ENT] 100 MHz 10 MHz 1 MHz 100 kHz 10 kHz

Memory channel 15

[2] [D] [1] [5]  
 Memory mode [ENT] 2-digit

Duplex scratch pad memory 2

[1] [#] [#]  
 Call channel [UP] [UP]

Note for the [ENT] key

- When the entered frequency is outside of the frequency coverage or the entered memory channel is outside of the memory area, the input digit will be cleared.
- To adjust the frequency less than 10 kHz or to select a scan edge memory channel (1A–3A, 1b–3b), use the [UP] or [DOWN] key.

[EXAMPLE]: Setting the operating frequency to 145.8125 MHz (when the VHF tuning step is 12.5 kHz).

[B] [1] [2] [3] [#] [3] [D] [1] [4] [5] [8] [0] [#] [B] [\*]  
 Password (or "F") VFO mode [ENT] Frequency setting [UP] (or "E")

# 14 PAGER AND CODE SQUELCH

## ■ Pager function

This function uses DTMF codes for paging and can be used as a "message pager" to inform you of a caller's identity even if you leave the transceiver temporarily unattended.

Personal calls and group calls are available with the pager function. Personal calls use the receiving parties' ID code for calling. The receiving parties' display shows your ID code and other stations in the party know that you called.

Group calls use the group code for calling. All stations' displays show the group code and all stations know that someone in your group called.

To use the pager function in your group, all stations need the pager function.

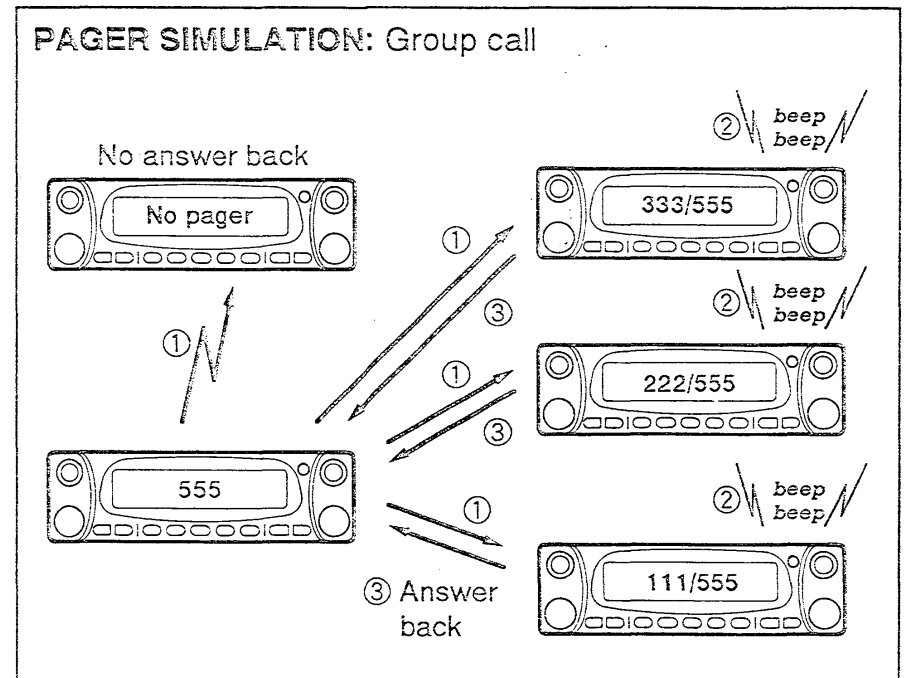
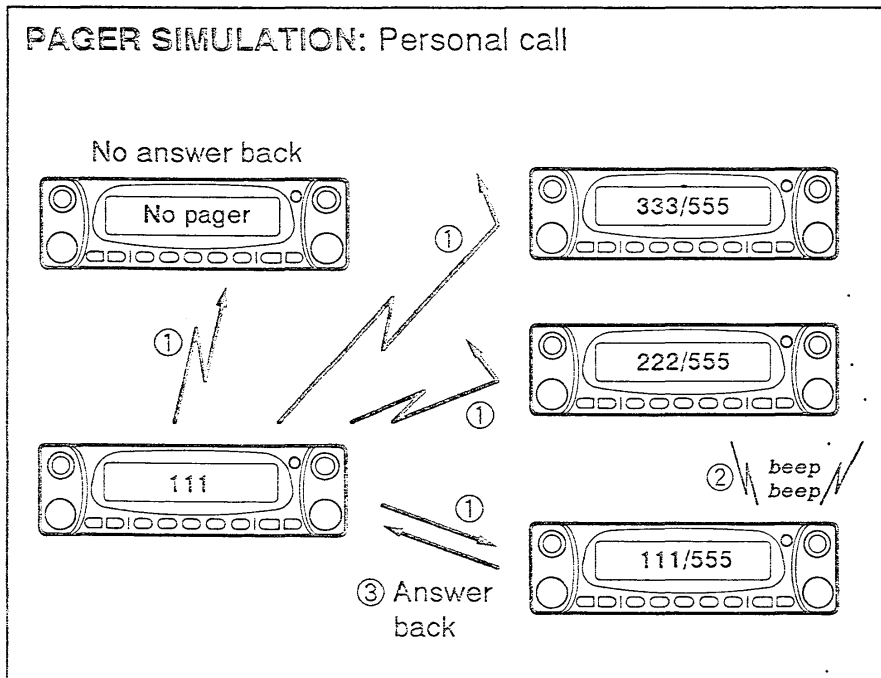



## ■ Code channels

### ◇ Before programming

The pager and code squelch functions require ID codes and a group code. These codes are 3-digit DTMF codes and must be written in the code channels before operation. The transceiver has separate code channels for each band.

### ◇ Code channel assignment

ID OR GROUP CODE	CODE CHANNEL NUMBER	"RECEIVE ACCEPT" OR "RECEIVE INHIBIT"
Your ID code	0	"Receive accept" only.
Other parties' ID code	1-5	"Receive inhibit" should be programmed in each channel.
Group code	One of 1-5	"Receive accept" must be programmed.
Memory space*	P	"Receive inhibit" only.

\* Code channel P automatically memorizes an ID code when receiving a pager call. The contents in channel P cannot be changed manually.

### RECEIVE ACCEPT AND INHIBIT

Code channels 1-5 can store the transmit codes for personal calls with other parties and the group codes for group calls.

The group codes should be programmed as "receive accept" ("SKIP" disappears) to receive all calls from your parties' members.

If transmit codes are not programmed as "receive inhibit," the transceiver accepts calls directed to other parties and your answer back may confuse your party members – this is not a selective calling system. Therefore, transmit codes should be programmed as "receive inhibit" ("SKIP" appears) so the transceiver rejects calls directed to other parties.

## Code programming

- ① Push the desired band's tuning dial.
  - Each band has separate code channels.
- ② Push [DTMF] to turn the pager function ON.
  - "P" appears in place of the 100 MHz digit.
- ③ Push [SET] to select the code channel setting display.
- ④ Rotate the selected band's tuning dial to select the desired code channel, 0-5.
  - Code channel P cannot be used for programming.
- ⑤ Push [SET] or [SPCH] to select the digit to be programmed.
- ⑥ Rotate the selected band's tuning dial to set the digit.
- ⑦ Repeat ⑤ and ⑥ until the last digit is programmed.
- ⑧ Push [DTMF] to set the code channel for "receive inhibit" or "receive accept."
  - When "receive inhibit" is set, "SKIP" appears.
  - Code channel 0 cannot be set as "receive inhibit."
  - See p. 66 for "receive inhibit" or "receive accept" details.
- ⑨ Push the selected band's tuning dial to exit the setting display.

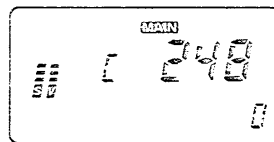

The display shows that VHF code channel 0 is programmed for 248.



- ① Push the desired band switch.
  - Each band has separate code channels.
- ② Push [FUNC] then [④PGR] to turn the pager function ON.
  - "P" appears in place of the 100 MHz digit.
- ③ Push [ⒷSET] to select the code channel setting display.
- ④ Push [UP] or [DN] to select the desired code channel, 0-5.
  - Code channel P cannot be used for programming.
- ⑤ Push the numeral keys to enter the desired 3-digit code.
  - Digits are automatically stored once the 3rd digit has been entered.
  - When an unwanted digit is entered, push [ⒶCLR] then repeat steps ③ and ⑤.
- ⑥ Push [ⒷSET] to set the code channel for "receive inhibit" or "receive accept."
  - When "receive inhibit" is set, "SKIP" appears.
  - Code channel 0 cannot be set as "receive inhibit."
  - See p. 66 for "receive inhibit" or "receive accept" details.
- ⑦ Push [ⒶCLR] to exit the setting display.

## ■ Pager operation

### ◆ Calling a specific station

- ① Push the desired band's tuning dial.
- ② Set the operating frequency.
- ③ Push [DTMF] to turn the pager function ON.
  - "P" appears in place of the 100 MHz digit.
  - An optional tone squelch can be used together with the pager function. (p. 73)
- ④ Select the desired code channel:
  - Push [SET].
  - Rotate the selected band's tuning dial to select the code channel.
  - Push the selected band's tuning dial to exit the setting display.
- ⑤ Push [PTT] to transmit the pager code.
- ⑥ Wait for an answer back.
  - When the transceiver receives an answer back code, the function display shows the other party's ID or group code and beeps. (p. 70)
- ⑦ After confirming a connection, push the selected band's tuning dial to display the operating frequency.
  - **DO NOT** push numeral keys on the microphone while code channels 0-5 are indicated, or code channel contents are changed.
- ⑧ Push [DTMF] once to select code squelch or 4 times to select the non-selective calling system.
  - Be sure that "REMO" does not appear when the non-selective calling system is selected.

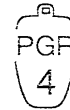

- ① Push the desired band switch.
- ② Set the operating frequency.
- ③ Push [FUNC] then [④PGR] to turn the pager function ON.
  - "P" appears in place of the 100 MHz digit.
  - An optional tone squelch can be used together with the pager function. (p. 73)
- ④ Select the desired code channel:
  - Push [ⒷSET].
  - Push [UP] or [DN] to select the code channel.
  - Push [ⒶCLR] to exit the setting display.
- ⑤ Push [PTT] to transmit the pager code.
- ⑥ Wait for an answer back.
  - When the transceiver receives an answer back code, the function display shows the other parties' ID or group code and beeps. (p. 70)
- ⑦ After confirming a connection, push [ⒶCLR] to display the operating frequency.
  - **DO NOT** push numeral keys while code channels 0-5 are indicated, or code channel contents are changed.
- ⑧ Push [FUNC] then [⑤C SQL] to select code squelch or push [ⒶCLR] to select the non-selective calling system.
  - Pushing [FUNC] then [ⒷD-OFF] also selects the non-selective calling system.

## ◇ Waiting for a call from a specific station

- ① Push the desired band's tuning dial.
- ② Set the operating frequency.
- ③ Push [DTMF] to turn the pager function ON.
  - "P" appears in place of the 100 MHz digit.
  - An optional tone squelch can be used together with the pager function. (p. 73)
- ④ Wait for a call.
  - When receiving a call, the other parties' ID or group code appears; "(••)" and the channel number blink as shown on the next page.
  - **DO NOT** push numeral keys on the microphone while code channels 0–5 are indicated, or code channel contents are changed.
- ⑤ Push [PTT] to send an answer back call and display the operating frequency.
- ⑥ Push [DTMF] once to select code squelch or 4 times to select the non-selective calling system.

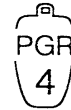

- ① Push the desired band switch.
- ② Set the operating frequency.
- ③ Push [FUNC] then [④ PGR] to turn the pager function ON.
  - "P" appears in place of the 100 MHz digit.
  - An optional tone squelch can be used together with the pager function. (p. 73)
- ④ Wait for a call.
  - When receiving a call, the other parties' ID or group code appears; "(••)" and the channel number blink as shown on the next page.
  - **DO NOT** push numeral keys while code channels 0–5 are indicated, or code channel contents are changed.
- ⑤ Push [PTT] to send an answer back call and display the operating frequency.
- ⑥ Push [FUNC] then [⑤ C SQL] to select code squelch or push [Ⓐ CLR] to select the non-selective calling system.
  - Pushing [FUNC] then [Ⓑ D-OFF] also selects the non-selective calling system.

### Code squelch function

Code squelch operation provides communication with silent standby since you will only receive calls from stations which know your ID or group code. To use the code squelch function in your group, all stations need the code squelch function.

The code squelch function transmits a 3-digit code prior to voice transmission in order to open the receiving station's code squelch.

**PERSONAL CALLS**  
 This display appears when you are called with your ID code and the calling station's ID code is 263.

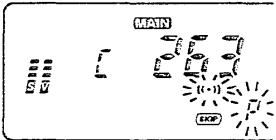

**GROUP CALLS**  
 This display appears when you are called with the group code, 123, and 123 has been programmed into code channel 5.

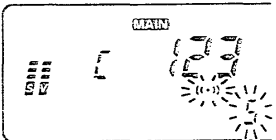

**ERROR INFORMATION**  
 When the transceiver receives an incomplete signal, "E" appears.

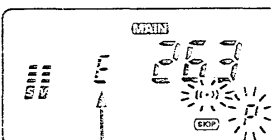

"E" appears.

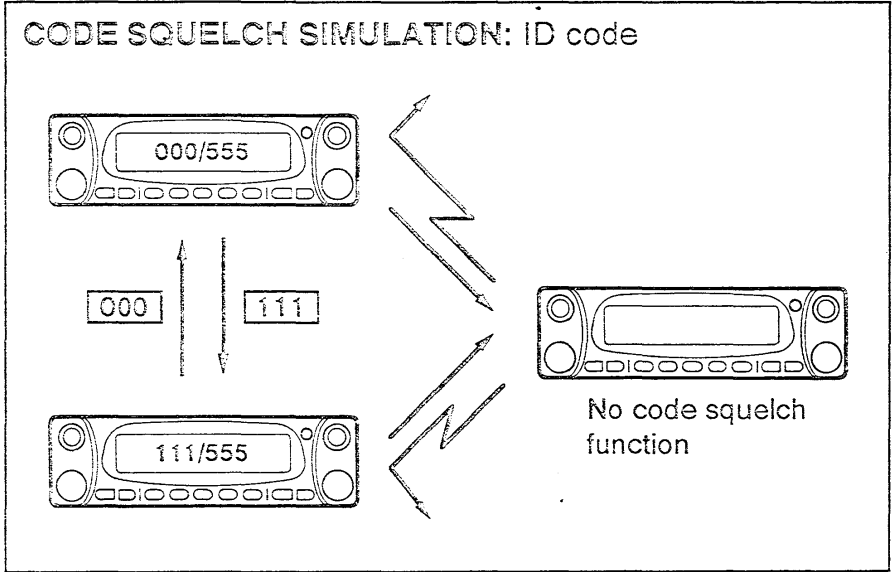

## Code squelch operation

- ① Push the desired band's tuning dial.
- ② Set the operating frequency.
- ③ Push [DTMF] twice to turn the code squelch ON.
  - "C" appears in place of the 100 MHz digit as shown below.
  - An optional tone squelch can be used together with the code squelch. (p. 73)

"C" appears in place of the 100 MHz digit.

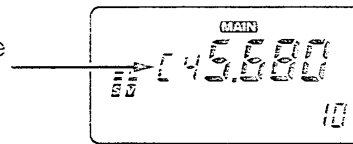

- ④ Select the desired code channel:
  - Push [SET].
  - Rotate the selected band's tuning dial to select the code channel.
  - Push the selected band's tuning dial to exit the setting display.
- ⑤ Operate the transceiver in the normal way (push [PTT] to transmit; release [PTT] to receive).
  - Prior to voice transmission, a 3-digit transmit code is sent each time [PTT] is pushed in order to open the receiving station's code squelch.
- ⑥ To cancel the code squelch, push [DTMF] 3 times.
  - The display shows the operating frequency and "REMO" does not appear.



- ① Push the desired band switch.
- ② Set the operating frequency.
- ③ Push [FUNC] then [5 C SQL] to turn the code squelch ON.
  - "C" appears in place of the 100 MHz digit.
  - An optional tone squelch can be used together with the code squelch. (p. 73)

- ④ Select the desired code channel:
  - Push [B SET].
  - Push [UP] or [DN] to select the code channel.
  - Push [A CLR] to exit the setting display.

- ⑤ Operate the transceiver in the normal way (push [PTT] to transmit; release [PTT] to receive).
  - Prior to voice transmission, a 3-digit transmit code is sent each time [PTT] is pushed in order to open the receiving station's code squelch.



- ⑥ To cancel the code squelch, push [A CLR].
  - Pushing [FUNC] then [B D-OFF] also cancels the code squelch.

## ■ Pocket beep operation

This function uses subaudible tones for calling and can be used as a "common pager" to inform you that someone has called while you were away from the transceiver.

To operate the pocket beep function, an optional UT-84 is necessary. See p. 74 for installation.

### ◇ Waiting for a call from a specific station

- ① Push the desired band's tuning dial.
- ② Set the operating frequency.
- ③ Program the subaudible tone frequency in set mode.
  - See p. 35 for programming details.
- ④ Push [DUP-TONE] for 1 sec., several times until "T SQL ((·))" appears in the function display.
  - Turn OFF the pager or code squelch to activate the pocket beep. (pgs. 68, 71) The pocket beep cannot be used in combination with the pager or code squelch.
- ⑤ When a signal with the correct tone is received, the transceiver emits beep tones for 30 sec. and flashes "((·))."
- ⑥ Push [PTT] to answer or push the desired band's tuning dial to stop the beeps.
  - Tone squelch is automatically selected when an answer back call is transmitted.
- ⑦ Push [DUP-TONE] for 1 sec. to cancel the function.



- ① Push the desired band switch.
- ② Set the operating frequency.
- ③ Program the subaudible tone frequency in set mode.
  - See p. 35 for programming details.
- ④ Push [FUNC] then [Ⓢ T SQL ((·))] to turn the pocket beep ON.
  - Turn OFF the pager or code squelch to activate the pocket beep. (pgs. 68, 71) The pocket beep cannot be used in combination with the pager or code squelch.
- ⑤ When a signal with the correct tone is received, the transceiver emits beep tones for 30 sec. and flashes "((·))."
- ⑥ Push [PTT] to answer or push [Ⓐ CLR] to stop the beeps and flashing.
  - Tone squelch is automatically selected.
- ⑦ To cancel the function, push [FUNC] then [Ⓢ T-OFF].



### ◇ Calling a waiting station using pocket beep

A subaudible tone matched with the station's tone frequency is necessary. Use the tone squelch on the next page or a subaudible tone encoder (p. 34, optional except for 88.5 Hz for non-U.S.A./Korea versions).

## ■ Tone squelch operation

The tone squelch opens only when receiving a signal with the same pre-programmed subaudible tone. You can silently wait for a call from group members using the same tone. This function can be activated on both bands with separate tone frequencies simultaneously.

- ① Push the desired band's tuning dial.
- ② Set the operating frequency.
- ③ Program the subaudible tone frequency in set mode.
  - See p. 35 for programming details.
- ④ Push [DUP•TONE] for 1 sec., several times until "T SQL" appears in the function display.
  - The code squelch can be used together with the tone squelch. (p. 71)
- ⑤ When the received signal includes the correct tone, the squelch opens and the signal can be heard.
  - When the received signal includes an incorrect tone, the squelch does not open. However, the S/RF indicator shows the received signal strength.
  - To open the accessed band's squelch manually, push and hold the accessed band's [VOL•MONI].
- ⑥ Operate the transceiver in the normal way (push [PTT] to transmit; release [PTT] to receive).
- ⑦ To cancel the tone squelch, push [DUP•TONE] for 1 sec.
  - "T SQL" disappears from the function display.



- ① Push the desired band switch.
- ② Set the operating frequency.
- ③ Program the subaudible tone frequency in set mode.
  - See p. 35 for programming details.
- ④ Push [FUNC] then [Ⓣ T SQL] to turn the tone squelch ON.
  - The code squelch can be used together with the tone squelch. (p. 71)
- ⑤ When the received signal includes the correct tone, the squelch opens and the signal can be heard.
  - When the received signal includes an incorrect tone, the squelch does not open. However, the S/RF indicator shows the received signal strength.
  - To open the accessed band's squelch manually, push and hold [MONI].
- ⑥ Operate the transceiver in the normal way (push [PTT] to transmit; release [PTT] to receive).
- ⑦ To cancel the tone squelch, push [FUNC] then [Ⓢ T-OFF].





## Optional unit installation

There are 2 types of optional internal units available.

### ◦ UT-66 VOICE SYNTHESIZER UNIT (p. 81)

Announces the operating band frequency in English or Japanese.

For the UT-66 installation, proceed as follows:

- ① Turn power OFF, then disconnect the DC power cable.
- ② Unscrew the 6 screws, then remove the bottom cover as shown below. (Fig. 1)
- ③ Install the UT-66 as shown in the diagram below. (Fig. 2)
- ④ Replace the bottom cover and screws, then connect the DC power cable.

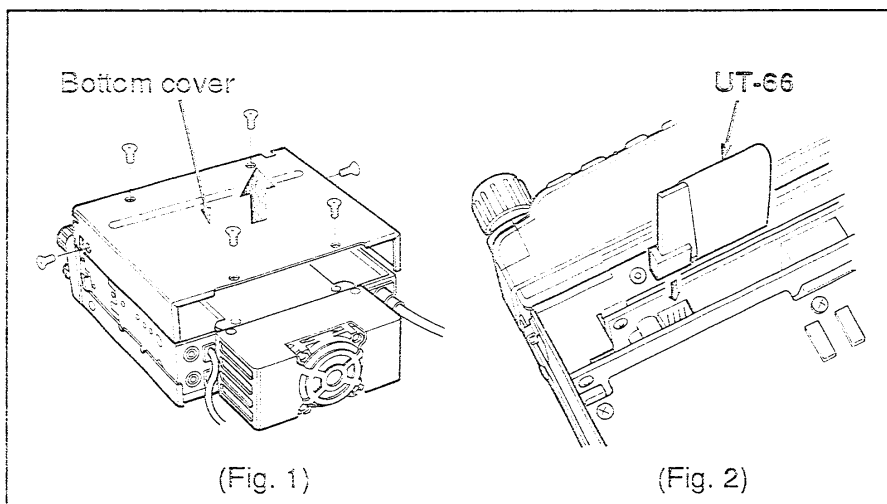

### ◦ UT-84 TONE SQUELCH UNIT (pgs. 34, 37, 72, 73)

Allows you to operate through a repeater that requires a subaudible tone\* for access, the pocket beep function, tone squelch function or tone scan.

\* U.S.A./Korea versions : Built-in.

Other versions : 88.5 Hz only.

For UT-84 installation, proceed as follows:

- ① Turn power OFF, then disconnect the DC power cable.
- ② Push the release button, then detach the remote controller as shown below. (Fig. 3)
- ③ Install the UT-84 as shown in the diagram below. (Fig. 4)
  - For the U.S.A. and Korea versions, remove the built-in TONE UNIT in advance.
- ④ Attach the remote controller and connect the DC power cable.

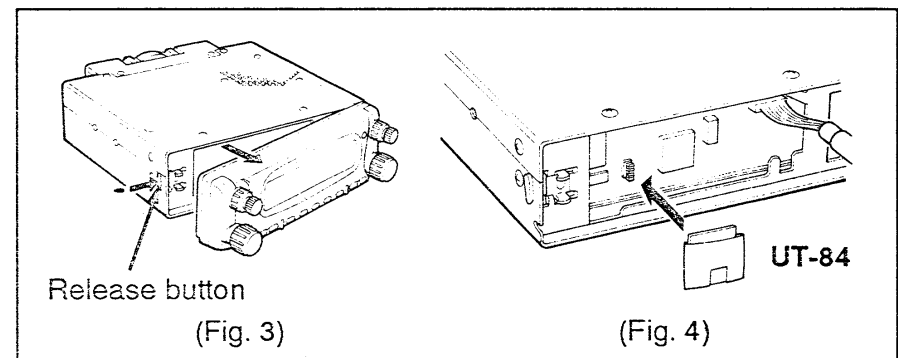

## ■ HM-90/A microphone

The transceiver accepts remote control signals from the optional HM-90/A WIRELESS MICROPHONE. The HM-90/A uses infrared signals for function control of the transceiver. This microphone has the same functions as the supplied microphone.

- The transceiver may become uncontrollable depending on the remote controller location. Move the remote controller or use the optional EX-1513 INFRARED SUB RECEIVER in this case.
- **DO NOT** place the remote controller or optional EX-1513 in direct sunlight.
- Disconnect the supplied microphone to use the optional HM-90/A.

### ◇ Turning the charging circuit ON/OFF

When you use the HM-90/A as a wired microphone, turn OFF the charging circuit in the microphone to prevent a shortening of the internal Ni-Cd battery's life.

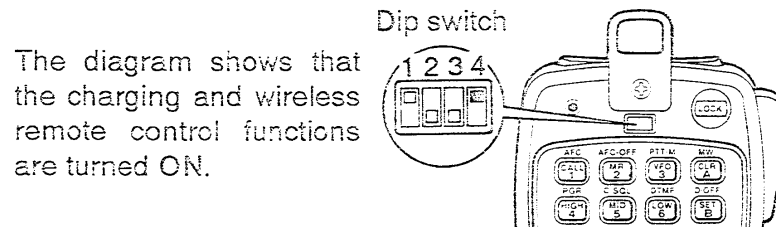

The diagram shows that the charging and wireless remote control functions are turned ON.

## ■ Charging the microphone

The optional HM-90/A includes Ni-Cd batteries and a charging circuit for wireless operation. The Ni-Cd battery is charged via the microphone cable even when the transceiver power is turned OFF. The charging time is approx. 8 hrs. and is automatically turned OFF. 1.5 hrs. charging time is selected depending on the remaining battery capacity.

When the Ni-Cd battery is charged completely, the operating time is approx. 12 hrs. (Tx : Rx = 1 min. : 4 min.)

The optional BC-96 MICROPHONE HOLDER conveniently supports the HM-90/A body and supplies power to the charging circuit in the HM-90/A. The BC-96 accepts the following cables for connection to a charging power source. The charging terminal of the HM-90/A has no polarity.

### ◇ Using the microphone cable

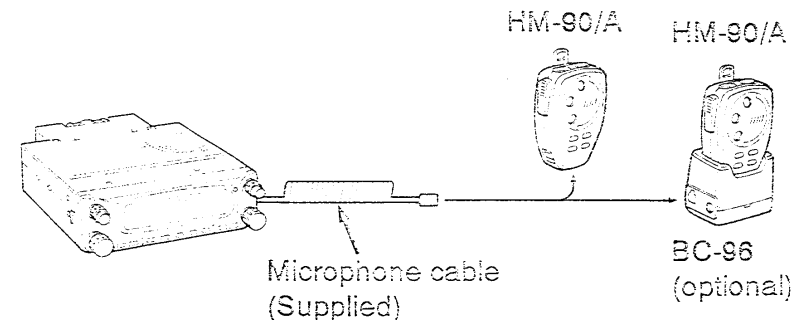

◇ Using an optional separation kit

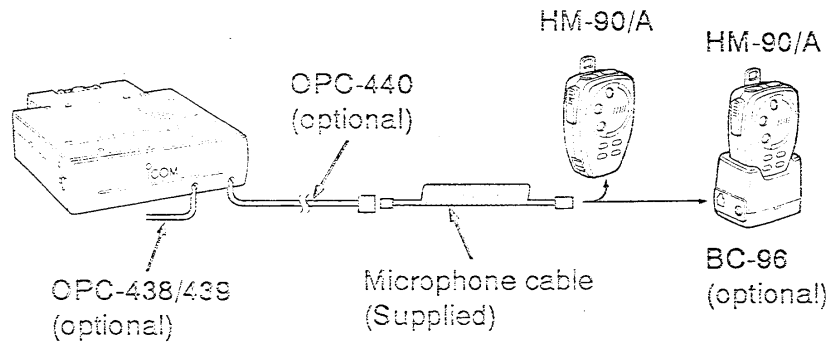

◇ Using an optional power cable

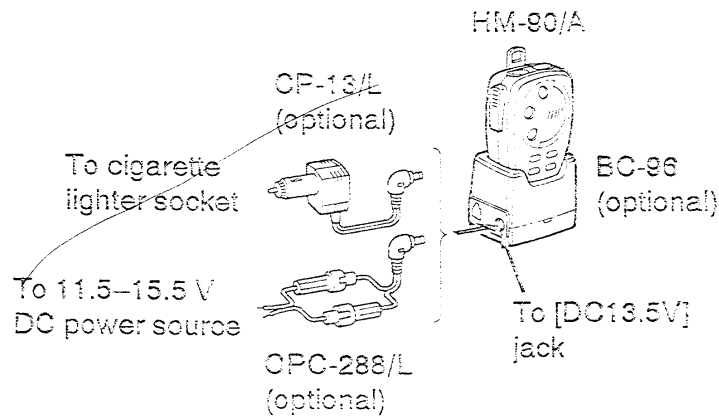

■ EX-1513 installation

The transceiver may become uncontrollable depending on the remote controller location or when the microphone is outside of the controllable area (approx. 2 m; 6.6 ft).

The optional EX-1513 INFRARED SUB RECEIVER is available to increase remote control reliability and extends the controllable area.

◦ Cable connection

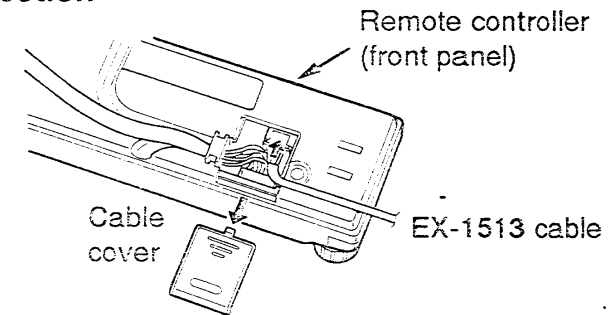

◦ Installation example

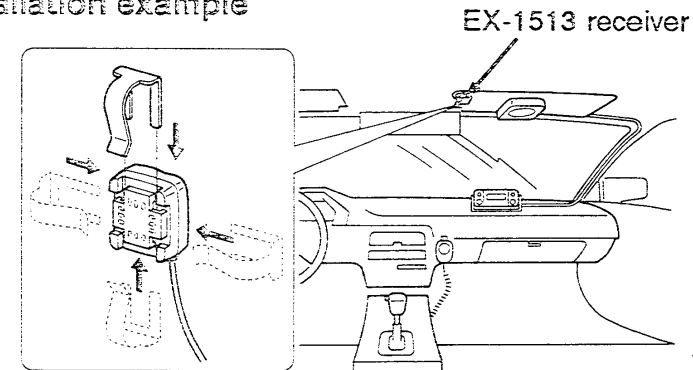

The installation clip can be oriented in 1 of 4 ways.

# 17 OTHER FUNCTIONS

## Audio output selection

*SET mode*

You can select the audio output for each band separately or mix them via [SP-1] or [SP-2].

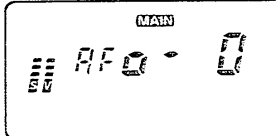

The display shows that the audio output 0 (default) is selected.

**Common setting for each band.**

- ① Push [SET] one or more times until "AFO" appears in the display as shown above.
  - Pushing [SPCH] reverses the order. (p. 18)
  - Cancel the pager, code squelch or DTMF memory function in advance. (pgs. 59, 68, 71)
- ② Rotate the main band's tuning dial to select one of the conditions as shown in the table at right.

"AFo" setting Connected speaker	"AFo-0"		"AFo-1"	
	VHF audio	UHF audio	VHF audio	UHF audio
With no external	Internal speaker (mixed audio)			
[SP-1] only	External speaker (mixed audio)			
[SP-2] only	Internal speaker	External speaker	External speaker	Internal speaker
2 external speakers	External speaker via [SP-1]	External speaker via [SP-2]	External speaker via [SP-2]	External speaker via [SP-1]

- ③ Push the main band's tuning dial to exit set mode.

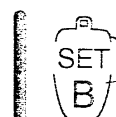

- ① Push [SET] one or more times until "AFO" appears in the display as shown at left.
  - Pushing [SPCH] reverses the order. (p. 18)
  - Cancel the pager, code squelch or DTMF memory function in advance. (pgs. 59, 68, 71)
- ② Push [UP] or [DN] to set the desired condition as shown in the table above.
- ③ Push [CLR] to exit set mode.

## ■ Beep tone on/off

INITIAL SET mode

You can select silent operation by turning beep tones OFF or you can select to have confirmation beeps sound at the push of a switch by turning beep tones ON.

The display shows that beep tones are turned ON.

- ① Push [POWER] to turn power OFF.
- ② While pushing [SET], turn power ON to enter initial set mode.
  - "bEP" appears.
  - If "bEP" doesn't appear, push [SET] or [SPCH] one or more times until it does. (p. 18).
- ③ Rotate the left-hand tuning dial to select the condition.
  - "bEP-oF" : Beep tones are turned OFF.
  - "bEP-on" : Beep tones are turned ON.
- ④ Turn power OFF to exit initial set mode.

## ■ Time-out timer

INITIAL SET mode

To prevent continuous transmission with the one-touch PTT function, etc., the transceiver has a time-out timer. This timer cuts a transmission OFF after 3, 5, 15 or 30 min. of continuous transmission. This timer can be cancelled. (default)

Approx. 10 sec. before the time-out time passes, the transceiver emits a beep tone.

The display shows that the 5 min. timer is selected.

The display shows that the time-out timer is cancelled.

- ① Push [POWER] to turn power OFF.
- ② While pushing [SET], turn power ON to enter initial set mode.
- ③ Push [SET] once to select the "tot" display as shown above.
- ④ Rotate the left-hand tuning dial to select the desired time-out time to 3, 5, 15, 30 min. or turn the timer OFF ("oF").
- ⑤ Turn power OFF to exit initial set mode.

## ■ Auto power-off INITIAL SET mode

The auto power-off function conveniently turns the transceiver power OFF after a preset time in which no operations are performed. In this way, when you forget to turn the power OFF, the transceiver automatically turns OFF itself, thereby conserving battery power.

The time can be set to 30 min., 1 hr., 2 hr. or turned OFF. The selected time is retained even when the transceiver is turned OFF by the auto power-off function. To cancel the function, select "oF" in step ④ below.

- ① Push [POWER] to turn power OFF.
- ② While pushing [SET], turn power ON to enter initial set mode.
- ③ Push [SET] 3 times (4 times for the U.S.A. version) to select the "PoF" display as shown at right.
- ④ Rotate the tuning dial to select the desired auto power-off time to 30 min., 1 hr., 2 hr. or turn the timer OFF ("oF").

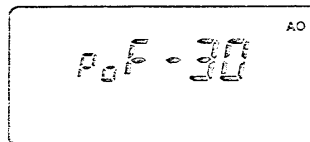

The display shows that the 30 min. timer is selected.

◦ "AO" appears when an auto power-off time is set.

- ⑤ Turn power OFF to exit initial set mode.

## ■ Cooling fan INITIAL SET mode setting

The transceiver has a heatsink and cooling fan to radiate heat. The cooling fan automatically turns ON while transmitting and remains ON for 2 min. after transmitting. The cooling fan can be activated continuously, if desired.

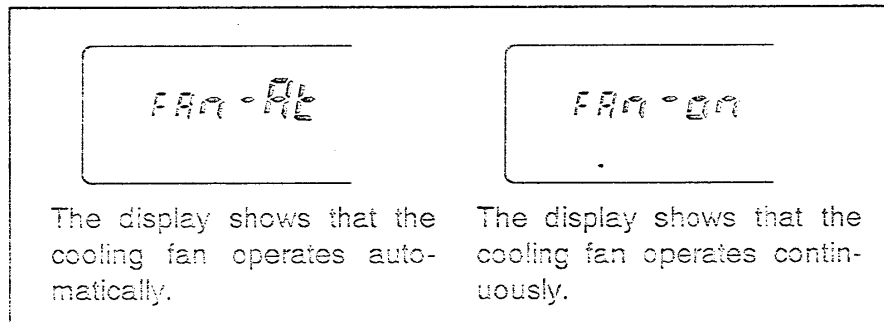

The display shows that the cooling fan operates automatically.

The display shows that the cooling fan operates continuously.

- ① Push [POWER] to turn power OFF.
- ② While pushing [SET], turn power ON to enter initial set mode.
- ③ Push [SET] 4 times (5 times for the U.S.A. version) to select the "FAn" display as shown above.
- ④ Rotate the left-hand tuning dial to set the cooling fan to automatic ("At") or continuously ("on").
- ⑤ Turn power OFF to exit initial set mode.

## Microphone address

*INITIAL SET mode*

The transceiver has 8 possible microphone addresses to help prevent interference from other HM-90/A WIRELESS MICROPHONES. Set both the microphone address and microphone dip switch to the same value as follows.

**NOTE:** When the supplied microphone is connected, the transceiver rejects control signals from the HM-90/A even when the microphone address is matched.

### ◇ Microphone address

- ① Push [POWER] to turn power OFF.
- ② While pushing [SET], turn power ON to enter initial set mode.
- ③ Push [SPCH] to select the "Adr" display as shown above.
- ④ Rotate the left-hand tuning dial to set the microphone address to 0-7 or to turn the microphone control OFF.
  - When "Adr-oF" is selected, the transceiver rejects all control signals from the HM-90/A or HM-92/A.
- ⑤ Turn power OFF to exit initial set mode.

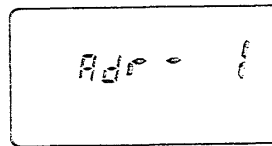

The display shows the microphone address is set to 1.

### ◇ Microphone dip switch

- ① Remove the switch cover from the microphone rear panel.
- ② Set the microphone dip switch and the microphone address to the same value as shown below.
- ③ Replace the switch cover.

MICROPHONE ADDRESS	DIP SWITCH		
	S1 - 1	S1 - 2	S1 - 3
Adr-0	OFF	OFF	OFF
Adr-1 (default)	ON	OFF	OFF
Adr-2	OFF	ON	OFF
Adr-3	ON	ON	OFF
Adr-4	OFF	OFF	ON
Adr-5	ON	OFF	ON
Adr-6	OFF	ON	ON
Adr-7	ON	ON	ON

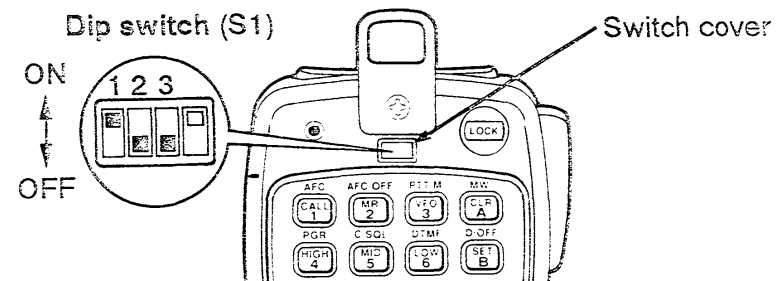

## Optional voice synthesizer

The transceiver can announce the operating frequency in English or Japanese when an optional UT-66 VOICE SYNTHESIZER UNIT is installed. This function can be activated even when the frequency lock function is turned ON. See p. 74 for installation.

Push [SPCH] to announce the operating frequency.

- While the sub band access function is in use, the transceiver announces the sub band frequency.
- 4 speech conditions are available. See right for selection.



Push [C]SPCH to announce the operating frequency.

### ◇ Speech condition setting *INITIAL SET mode*

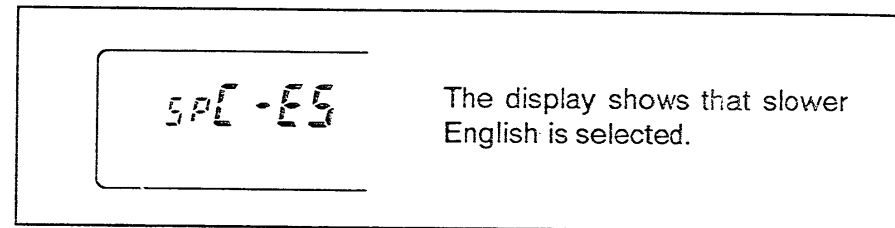

- ① Push [POWER] to turn power OFF.
- ② While pushing [SET], turn power ON to enter initial set mode.
- ③ Push [SPCH] twice to select the “SPC” display as shown above.
- ④ Rotate the left-hand tuning dial to select the condition.

DISPLAY	SPEECH CONDITION
SPc-ES	Slower English
SPc-EF	Faster English
SPc-JS	Slower Japanese
SPc-JF	Faster Japanese

- ⑤ Turn power OFF to exit initial set mode.



## ■ Demonstration display

A demonstration function is available. This function gives you a quick visual introduction to the function display indicators.



- ① Push [FUNC] then [ⓄDEMO] to enter the demonstration mode.
  - The transceiver cycles through a visual tour of the function display indicators.
- ② Push any switch to exit demonstration mode and enter the normal operating condition temporarily.
  - The transceiver automatically returns to demonstration mode after 2 min. in which no operations are performed.
  - The condition remains activated even when the power is turned OFF and ON again. Perform step ① again to cancel this function.

# 18 MAINTENANCE

## ■ Troubleshooting

If your transceiver seems to be malfunctioning, please check the following points before sending it to a service center.

PROBLEM	POSSIBLE CAUSE	SOLUTION	REF.
<ul style="list-style-type: none"> <li>No power comes on.</li> </ul>	<ul style="list-style-type: none"> <li>Power connector has a poor contact.</li> <li>Polarity of the power connection is reversed.</li> <li>Blown fuse.</li> </ul>	<ul style="list-style-type: none"> <li>Check the connector pins.</li> <li>Reconnect the power cable observing the proper polarity. Replace the fuse, if damaged.</li> <li>Check the cause, then replace the fuse.</li> </ul>	<p>—</p> <p>pgs. 14, 85</p> <p>p. 85</p>
<ul style="list-style-type: none"> <li>No sound comes from the speaker.</li> </ul>	<ul style="list-style-type: none"> <li>Volume level is too low.</li> <li>The squelch level is set too tight.</li> <li>The pager, code squelch, optional pocket beep or optional tone squelch is turned ON.</li> </ul>	<ul style="list-style-type: none"> <li>Rotate [VOL] clockwise.</li> <li>Set the squelch level to the threshold. (4 dots)</li> <li>Turn the appropriate function OFF.</li> </ul>	<p>p. 24</p> <p>p. 25</p> <p>pgs. 68–73</p>
<ul style="list-style-type: none"> <li>Sub band signals are not audible.</li> </ul>	<ul style="list-style-type: none"> <li>The sub band mute function is activated.</li> </ul>	<ul style="list-style-type: none"> <li>Turn the function OFF.</li> </ul>	<p>p. 28</p>
<ul style="list-style-type: none"> <li>Sensitivity is low and only strong signals are audible.</li> </ul>	<ul style="list-style-type: none"> <li>Antenna feed line or the antenna connector solder has a poor contact or is short circuited.</li> </ul>	<ul style="list-style-type: none"> <li>Check, and if necessary, replace the feed line or solder the antenna connector again.</li> </ul>	<p>p. 15</p>
<ul style="list-style-type: none"> <li>No contact possible with another station.</li> </ul>	<ul style="list-style-type: none"> <li>The transceiver is set to semi-duplex.</li> <li>The other station is using code or tone squelch.</li> </ul>	<ul style="list-style-type: none"> <li>Set to simplex.</li> <li>Turn ON the code squelch or optional tone squelch (UT-84 is necessary.).</li> </ul>	<p>p. 33</p> <p>pgs. 70, 73</p>
<ul style="list-style-type: none"> <li>Repeater cannot be accessed.</li> </ul>	<ul style="list-style-type: none"> <li>Wrong offset frequency is programmed.</li> <li>Wrong subaudible tone frequency is programmed.</li> </ul>	<ul style="list-style-type: none"> <li>Correct the offset frequency.</li> <li>Correct the subaudible tone frequency. (UT-84 is necessary for non-U.S.A./Korea versions.)</li> </ul>	<p>p. 36</p> <p>p. 35</p>
<ul style="list-style-type: none"> <li>Frequency cannot be set.</li> </ul>	<ul style="list-style-type: none"> <li>The frequency lock function is activated.</li> <li>Priority watch is paused on the watching frequency.</li> </ul>	<ul style="list-style-type: none"> <li>Turn the function OFF.</li> <li>Push [M/CALL•PRIO] to resume the watch.</li> </ul>	<p>p. 20</p> <p>p. 58</p>

PROBLEM	POSSIBLE CAUSE	SOLUTION	REF.
<ul style="list-style-type: none"> <li>◦ Frequency cannot be set via microphone.</li> </ul>	<ul style="list-style-type: none"> <li>• The microphone all lock or rear lock function is activated.</li> <li>◦ The microphone address is not matched.</li> <li>◦ Priority watch is paused on the watching frequency.</li> </ul>	<ul style="list-style-type: none"> <li>• Turn the function OFF.</li> <li>• Reset the microphone address and dip switch.</li> <li>• Push the selected band's [M/CALL•PRIO] to resume the watch.</li> </ul>	<p>p. 20</p> <p>p. 80 p. 58</p>
<ul style="list-style-type: none"> <li>◦ Some memory channels cannot be selected.</li> </ul>	<ul style="list-style-type: none"> <li>• The memory channel is outside of the memory area.</li> </ul>	<ul style="list-style-type: none"> <li>• Reset the memory area.</li> </ul>	<p>p. 43</p>
<ul style="list-style-type: none"> <li>◦ Scan does not operate.</li> </ul>	<ul style="list-style-type: none"> <li>• Squelch is open.</li> <li>◦ The selected scan edge memory channels (e.g. 1A and 1b) have the same frequencies (for programmed scan).</li> <li>◦ All memory channels are programmed as skip channels (for memory scan).</li> <li>◦ Priority watch is activated.</li> </ul>	<ul style="list-style-type: none"> <li>• Set the squelch to the threshold point.</li> <li>• Reset the scan edges.</li> <li>• Cancel the memory skip function in the desired channels.</li> <li>• Turn the function OFF.</li> </ul>	<p>p. 25 pgs. 52, 53</p> <p>p. 55</p> <p>p. 58</p>
<ul style="list-style-type: none"> <li>◦ Transmission is automatically cut off.</li> </ul>	<ul style="list-style-type: none"> <li>• Time-out timer is activated.</li> </ul>	<ul style="list-style-type: none"> <li>• Set the timer to OFF.</li> </ul>	<p>p. 78</p>
<ul style="list-style-type: none"> <li>◦ Transmission continues even when the PTT switch is released.</li> </ul>	<ul style="list-style-type: none"> <li>• One-touch PTT function is activated.</li> </ul>	<ul style="list-style-type: none"> <li>• Turn the function OFF.</li> </ul>	<p>p. 32</p>
<ul style="list-style-type: none"> <li>◦ The function display shows erroneous information.</li> </ul>	<ul style="list-style-type: none"> <li>• The CPU is malfunctioning.</li> </ul>	<ul style="list-style-type: none"> <li>• Reset the transceiver.</li> </ul>	<p>p. 85</p>

## ■ Fuse replacement

If the fuse blows or the transceiver stops functioning, find the source of the problem if possible, and replace the damaged fuse with a new, rated fuse (FGB 20 A) as shown in the diagram below.

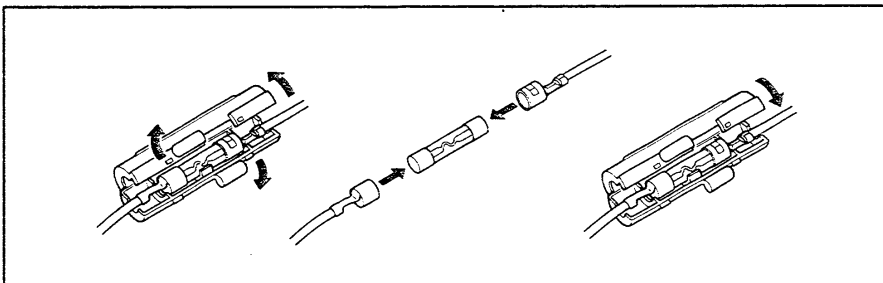

## ■ Partial resetting

If you want to initialize the operating conditions (VFO frequency, VFO settings, set mode settings, etc.) without clearing the memory contents or initial set mode settings, a partial reset function is available for the transceiver.

While pushing [SPCH], turn power ON to partially reset the transceiver.

- All programmed contents, except for memory contents (call and scratch pad memories included) and initial set mode settings, are cleared, and the transceiver displays its initial VFO frequency display.

## ■ Resetting the transceiver

The function display may occasionally display erroneous information, (e.g., when first applying power). This may be caused externally by static electricity or other factors.

If this problem occurs, turn power OFF. After waiting a few seconds, turn power ON again. If the problem persists, perform the following procedure.

Partial resetting is alternatively available. See left for details.

**NOTE:** Resetting the transceiver **CLEARs** all memory information, and initializes all values in the transceiver.

- ① Push [POWER] to turn power OFF.
- ② While pushing [SET] and [SPCH], turn power ON.
  - All LCD segments appear momentarily, the initial display appears and the transceiver is reset.

## ■ GENERAL

- Frequency coverage

VERSION		144 MHz	430(440) MHz
U.S.A.		144–148 MHz	440–450 MHz
Australia		144–148 MHz	430–440 MHz
Asia	Tx	144–148 MHz	430–440 MHz
	Rx	136–174 MHz* <sup>1</sup>	
Korea		144–146 MHz	435.075–440 MHz
Europe		144–146 MHz	430–440 MHz
Italy	Tx	144–148 MHz	430–440 MHz
	Rx	136–174 MHz* <sup>1</sup>	

\*<sup>1</sup> Guaranteed frequency coverage is 144–148 MHz.

\*<sup>2</sup> Guaranteed frequency coverage is 430–440 MHz.

- Mode : FM
- Antenna impedance : 50 Ω (nominal)
- Power supply requirement : 13.8 V DC ± 15%
- Usable temperature range : -10 °C to +60 °C; +14 °F to +140 °F
- Dimensions : 140(W) × 40(H) × 177(D) mm  
(projections not included) 5.5(W) × 1.6(H) × 7.0(D) in
- Weight : 1.45 kg; 3.2 lb

## ■ TRANSMITTER

- Modulation system : Variable reactance frequency modulation
- Max. frequency deviation : ± 5.0 kHz
- Spurious emissions : Less than -60 dB
- Microphone impedance : 600 Ω

- Output power and current drain:

CONDITION		IC-2700H		IC-2700A/E	
		POWER	CURRENT	POWER	CURRENT
144 MHz	High	50 W	12.0 A	25 W	7.5 A
	Low 2	10 W	5.5 A	10 W	6.0 A
	Low 1	5 W	4.0 A	3 W	4.5 A
430(440) MHz	High	35 W	11.5 A	25 W	9.5 A
	Low 2	10 W	6.0 A	10 W	6.0 A
	Low 1	5 W	4.5 A	3 W	4.5 A

## ■ RECEIVER

- Receive system : Double-conversion superheterodyne
- Intermediate frequencies :
  - 144 MHz : 1st 41.8 MHz 2nd 455 kHz
  - 430(440) MHz : 1st 42.25 MHz 2nd 455 kHz
- Sensitivity (for 12 dB SINAD): Less than 0.16 μV
- Squelch sensitivity (at threshold): Less than 0.13 μV
- Selectivity : More than 15 kHz/ -6 dB  
Less than 30 kHz/ -60 dB
- Spurious response rejection ratio : More than 60 dB
- Audio output power : More than 2.0 W at 10% distortion with the 8.Ω internal speaker.
- Current drain :
  - Rated audio output on both bands 1.8 A
  - Squelched on both bands 1.2 A

All stated specifications are subject to change without notice or obligation.

## ■ Unpacking

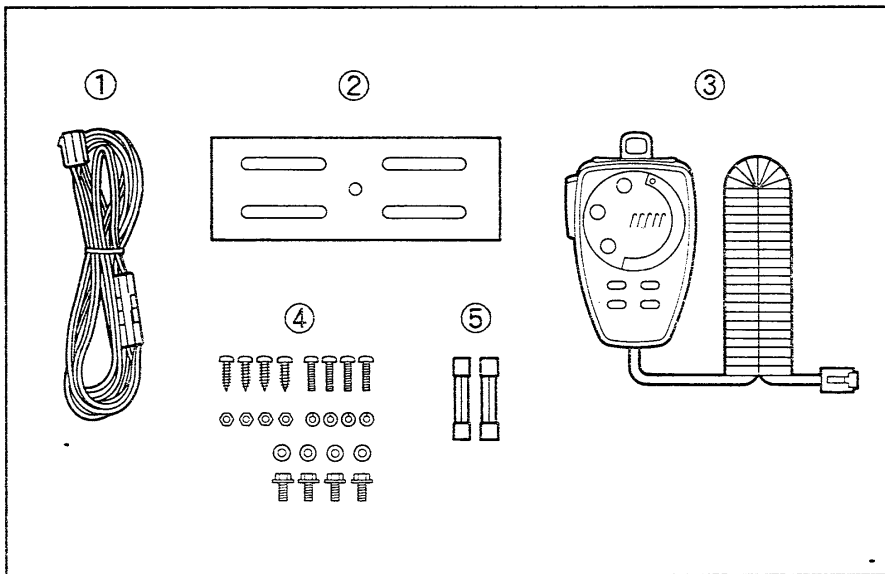

Accessories included with the transceiver:	Qty.
① DC power cable (OPC-346) .....	1
② Mounting bracket (MB-26) .....	1
③ Microphone* .....	1
④ Mounting screws, nuts and washers .....	1 set
⑤ Fuses (20 A) .....	2

\* U.S.A. version : HM-92A

Non-U.S.A. versions : HM-92

## ■ Options

Some versions cannot use all of the following options since electrical standards, etc. vary between countries. Ask your Icom Dealer which options are available.

### SP-7 EXTERNAL SPEAKER

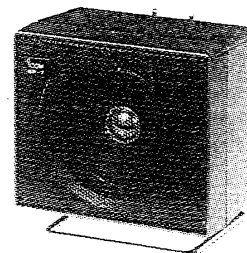

Cable length: 1.0 m; 3.3 ft

### SP-10 EXTERNAL SPEAKER

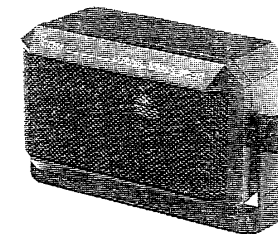

Cable length: 1.5 m; 4.9 ft

### SP-12 EXTERNAL SPEAKER

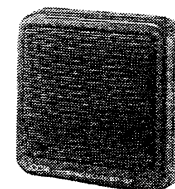

Cable length: 2.0 m; 6.6 ft

### OPC-438/439 SEPARATION KIT

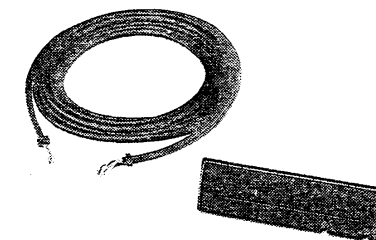

Cable length:  
OPC-438 : 3.5 m; 11.5 ft  
OPC-439 : 7.0 m; 23.0 ft

**AH-32** 144/430(440) MHz DUAL BAND ANTENNA

Dual band mobile antenna.

Frequency range : 144–148 MHz and 430–450 MHz

Max. input power : 150 W

**AHB-32** TRUNK MOUNT

Trunk mount with a coaxial cable for the AH-32.

**BC-96** MICROPHONE HOLDER

Holds the HM-90/A body in a convenient place and supplies power to the charging circuit of the HM-90/A. Has a charging indicator.

**CP-13/L** CIGARETTE LIGHTER CABLE WITH NOISE FILTER (for BC-96)

Supplies power to the BC-96 for charging the Ni-Cd battery inside the HM-90/A.

**EX-1513** INFRARED SUB RECEIVER

Receives control signals from the HM-90/A. Increases remote control reliability and extends the controllable area.

**HM-90/A** WIRELESS MICROPHONE

Infrared, full remote control microphone. Wired remote control is also possible.

**HM-92/A** HAND MICROPHONE

Same as the supplied one.

**MB-17A** MOBILE MOUNTING BRACKET

One-touch bracket. Transceiver body is easily attached and removed.

**MB-26** MOBILE MOUNTING BRACKET

Same as the supplied one.

**MB-34** JOINT PLATES

Used for stacking the IC-2700H/A/E with Icom UHF mobile transceivers.

**MB-58** REMOTE CONTROLLER BRACKET

Mounts the remote controller in a convenient location.

**OPC-288/L** DC POWER CABLE (for BC-96)

Supplies power to the BC-96 for charging the Ni-Cd battery inside the HM-90/A.

**OPC-346** DC POWER CABLE

Same as supplied one. Has 20 A capacity and a length of 3 m (9.8 ft).

**OPC-347** DC POWER CABLE

Has 20 A capacity and a length of 7.0 m (23.0 ft).

**OPC-440** MIC EXTENSION CABLE

Allows longer distance between main body and microphone. (5.0 m; 16.4 ft).

**OPC-441** SPEAKER CABLE

Allows longer distance between main body and external speaker. Has 2 band capability and a length of 5.0 m (16.4 ft).

**IC-PS30** DC POWER SUPPLY

Provides 13.8 V DC and 25 A max. for base station use.

**UT-66** VOICE SYNTHESIZER UNIT

Announces the accessed band frequency.

**UT-84** TONE SQUELCH UNIT

Provides pocket beep, tone squelch and tone scan functions. Also functions as a subaudible tone encoder.

A-5282S-1EX  
Printed in Japan  
Copyright © 1994 by Icom Inc.

**Icom Inc.**  
6-9-16, Kamihigashi, Hirano-ku, Osaka 547, Japan