

KB2LJJ Radio Mods Database

DUAL BAND FM TRANSCEIVER
IC-2710H

Icom Inc.

IMPORTANT

READ ALL INSTRUCTIONS carefully and completely before using the transceiver.

SAVE THIS INSTRUCTION MANUAL—This instruction manual contains important operating instructions for the IC-2710H.

EXPLICIT DEFINITIONS

The explicit definitions below apply to this instruction manual.

WORD	DEFINITION
⚠ WARNING	Personal injury, fire hazard or electric shock may occur.
CAUTION	Equipment damage may occur.
NOTE	If disregarded, inconvenience only. No risk of personal injury, fire or electric shock.



The IC-2710H Europe versions comply with essential requirements of the 89/336/EEC directive for Electromagnetic Compatibility. This compliance is based on conformity with the ETSI specification prEIS300 684 (EMC product standard for Commercially Available Amateur Radio Equipment).

CAUTIONS

⚠ WARNING! NEVER connect the transceiver to an AC outlet. This may pose a fire hazard or result in an electric shock.

⚠ WARNING! NEVER operate the transceiver while driving a vehicle. Safe driving requires your full attention—anything less may result in an accident.

NEVER connect the transceiver to a power source of more than 16 V DC. This connection will ruin the transceiver.

NEVER connect the transceiver to a power source using reverse polarity. This connection will ruin the transceiver.

NEVER cut the DC power cable between the DC plug and fuse holder. If an incorrect connection is made after cutting, the transceiver might be damaged.

NEVER place the transceiver where normal operation of the vehicle may be hindered or where it could cause bodily injury.

NEVER let objects impede the operation of the cooling fan on the rear panel.

DO NOT push the PTT when not actually desiring to transmit.

DO NOT allow children to play with any radio equipment containing a transmitter.

During mobile operation, **DO NOT** operate the transceiver without running the vehicle's engine. When transceiver power is ON and your vehicle's engine is OFF, the vehicle's battery will soon become exhausted.

BE CAREFUL! The transceiver will become hot when operating it continuously for long periods.

AVOID using or placing the transceiver in areas with temperatures below -10°C ($+14^{\circ}\text{F}$) or above $+60^{\circ}\text{C}$ ($+140^{\circ}\text{F}$) or in areas subject to direct sunlight, such as the dashboard.

AVOID the use of chemical agents such as benzine or alcohol when cleaning, as they can damage the transceiver surfaces.

USE Icom microphones only (supplied or optional). Other manufacturer's microphones have different pin assignments and may damage the transceiver.

UNPACKING

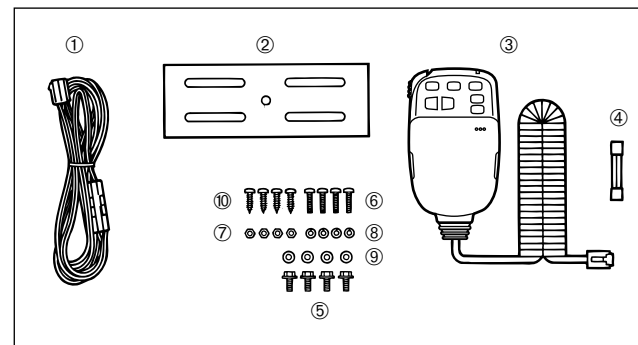

Accessories included with the transceiver:

	Qty.
① DC power cable (OPC-346).....	1
② Mobile mounting bracket	1
③ Microphone (HM-98).....	1
④ Fuse (20 A).....	1
⑤ Knob bolt (M4 x 8)	4
⑥ Mounting bolt (M5 x 12)	4
⑦ Nut (M5).....	4
⑧ Spring washer (M5)	4
⑨ Flat washer (M5).....	4
⑩ Self-tapping screws (A0 5 x 16).....	4

TABLE OF CONTENTS

IMPORTANT	i	■ Receiving	20
EXPLICIT DEFINITIONS	i	■ Monitor function	21
CAUTIONS	i	■ Audio mute function	21
UNPACKING	ii	■ Avionics band receive	21
TABLE OF CONTENTS	iii	■ Sub band access	22
1 PANEL DESCRIPTION	1 – 8	■ Sub band mute/sub band busy beep	23
■ Front panel	1	■ Para-watch	24
■ Function display	3	■ Transmitting	25
■ Rear panel	5	■ Selecting the output power	25
■ Microphone	6	■ Crossband full duplex	26
■ Microphone keypad	7	■ One-touch PTT function	26
2 INSTALLATION	9 – 14	5 REPEATER OPERATION	27 – 31
■ Installation methods	9	■ Operation	27
■ Location	10	■ Subaudible tones	29
■ Single body installation	10	■ Offset frequency	30
■ Microphone connection	11	■ Auto repeater	31
■ Separate installation	11	6 MEMORY OPERATION	32 – 36
■ Optional MB-58 installation	12	■ General description	32
■ Battery connection	13	■ Memory channel selection	32
■ DC power supply connection	13	■ Programming a memory channel	33
■ Antenna installation	14	■ Programming a memory channel via the microphone	34
3 SETTING A FREQUENCY	15 – 19	■ Transferring memory contents	35
■ Preparation	15	■ Memory clearing	36
■ Lock functions	16	7 CALL CHANNEL OPERATION	37 – 38
■ Using a tuning dial	17	■ Calling up a call channel contents	37
■ Using [▲]/[▼] switches	17	■ Transferring call channel contents	37
■ Tuning step selection	18	■ Programming a call channel	38
■ Using the keypad	19	8 SCRATCH PAD MEMORY	39 – 40
4 BASIC OPERATION	20 – 26	■ What is a scratch pad memory?	39

■ Calling up a scratch pad memory	39	14 EXTERNAL DTMF REMOTE	63 – 64
■ Transferring scratch pad memory contents	40	15 OPTIONAL UNIT INSTALLATION	65
9 SCAN OPERATION	41 – 46	■ Optional unit installation	65
■ Scan types	41	16 WIRELESS OPERATION	66 – 71
■ Start/stop scan	42	■ Connection	66
■ Programming scan edges	43	■ HM-90 WIRELESS MICROPHONE	66
■ Programming scan edges via the microphone	44	■ EX-1759 installation	67
■ Skip channel setting	45	■ HM-90 switches	68
■ Scan resume condition	46	■ Microphone address	71
10 PRIORITY WATCH	47 – 48	17 OTHER FUNCTIONS	72 – 74
■ Priority watch types	47	■ Beep tones on/off	72
■ Priority watch operation	48	■ Time-out timer	72
11 DTMF MEMORY ENCODER	49 – 52	■ Auto power-off	73
■ Programming a DTMF code	49	■ Cooling fan setting	73
■ Clearing the DTMF memory contents	49	■ Microphone [F-1]/[F-2] keys	74
■ Programming a DTMF code via the microphone	50	■ Display dimmer setting	74
■ Transmitting a DTMF code	51	■ Demonstration display	74
■ DTMF speed	52	18 MAINTENANCE	75 – 77
12 POCKET BEEP AND TONE SQUELCH	53 – 55	■ Troubleshooting	75
■ Pocket beep operation	53	■ Fuse replacement	77
■ Tone squelch operation	54	■ Partial resetting	77
■ Tone scan	55	■ Total resetting	77
13 PAGER AND CODE SQUELCH	56 – 62	19 SPECIFICATIONS	78
■ Pager function	56	20 OPTIONS	79 – 80
■ Code channels	57	21 MODE ARRANGEMENT CHART	81 – 82
■ Code programming	58		
■ Pager operation	59		
■ Code squelch function	61		
■ Code squelch operation	62		

1

PANEL DESCRIPTION

■ Front panel (remote controller)

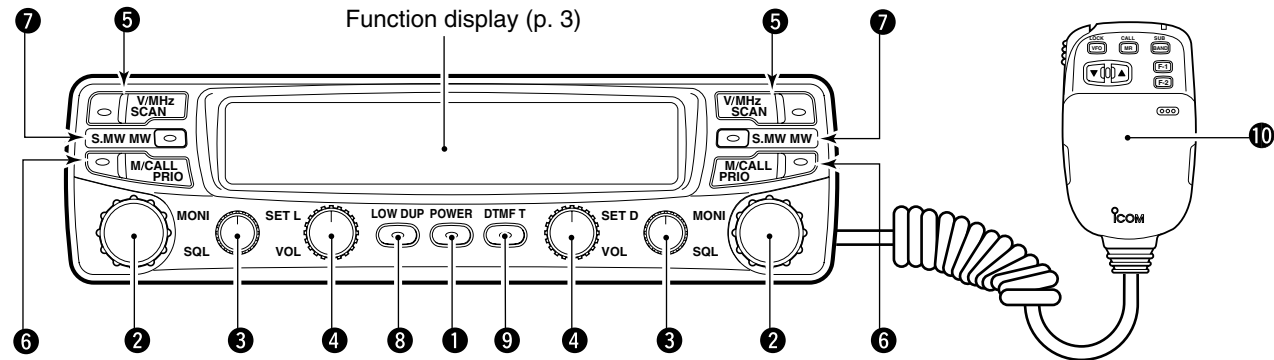

① POWER SWITCH [POWER]

Turns power ON and OFF when pushed for 1 sec.

② TUNING DIALS

- ➔ Select the operating frequency (p. 17), the memory channel (p. 32), the contents of the set mode display (p. 82) and the scanning direction. (p. 42)
- ➔ Select the main band when pushed. (p. 15)
- ➔ When the sub band is selected, activate the sub band function when pushed and held. (p. 22)
- ➔ When the main band is selected, change the operating band (for para watch) when pushed and held. (p. 24)

③ SQUELCH CONTROLS [SQL(MONI)]

- ➔ Vary the squelch level. (p. 20)
 - RF attenuator activates and increases the attenuation when rotated clockwise to the center position and further.
- ➔ Toggles squelch opened and closed when pushed.
 - Transmit frequency is automatically selected when squelch opens.

④ VOLUME CONTROLS [VOL(SET L)]/[VOL(SET D)]

- ➔ Adjust the audio levels. (p. 20)
- ➔ Select set mode when pushed. (p. 82)
- ➔ Toggles the lock function ON/OFF when pushed and held [SET(L)]. (p. 16)
- ➔ Allows you to adjust the display brightness when pushed and held [SET(D)]. (p. 74)

PANEL DESCRIPTION 1

- ⑤ **VFO/MHz SWITCHES [V/MHz(SCAN)]**
 - Select and toggle VFO mode and 1 MHz tuning display.
 - Start a scan when pushed and held. (p. 42)
- ⑥ **MEMORY/CALL CHANNEL SWITCHES [M/CALL(PRIO)]**
 - Select and toggle memory mode or a call channel. (pgs. 32, 37)
 - Activate the priority watch function when pushed and held. (p. 47)
- ⑦ **SELECT MEMORY/MEMORY WRITE SWITCHES [S.MW(MW)]**
 - Select a memory channel for programming. (p. 33)
 - Program selected memory when pushed and held. (p. 33)
- ⑧ **OUTPUT POWER/DUPLEX SWITCH [LOW(DUP)]**
 - Each push changes the output power selection. (p. 25)
 - There are 3 output powers available: low, mid and high.
 - Push and hold to select a duplex setting. (p. 27)
 - There are 3 duplex settings available: minus duplex (“-DUP” appears, plus duplex (“+ DUP” appears) and simplex.
- ⑨ **DTMF/TONE SWITCH [DTMF(T)]**
 - Turns DTMF memory encoder ON and OFF for autopatch operation. (p. 49)
 - When an optional UT-49 is installed, activates the DTMF memory, pager or code squelch function in sequence.
 - Turns the subaudible tone encoder ON and OFF for repeater access when pushed and held. (p. 27)
 - When an optional UT-104 is installed, activates the subaudible tone encoder, pocket beep or tone squelch function in sequence.

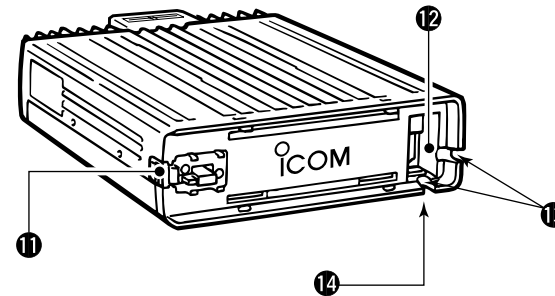

- ⑩ **MICROPHONE**
 - To connect the supplied microphone, detach the front panel in advance.
 - Multi-function keypad can be accessed by removing the keypad cover. (p. 7)
 - Be careful not to lose the cover.
- ⑪ **FRONT PANEL RELEASE LATCH**

While pushing this latch, slide the front panel to the left to remove it.
- ⑫ **MICROPHONE CONNECTOR**

Connect the supplied microphone or optional EX-1759 INFRARED RECEIVER . (p. 11)
- ⑬ **CABLE GUTTERS**

Pass the microphone cable through one of the gutters when attaching the front panel.
- ⑭ **MICROPHONE RELEASE**

Push to release the microphone.

1 PANEL DESCRIPTION

■ Function display

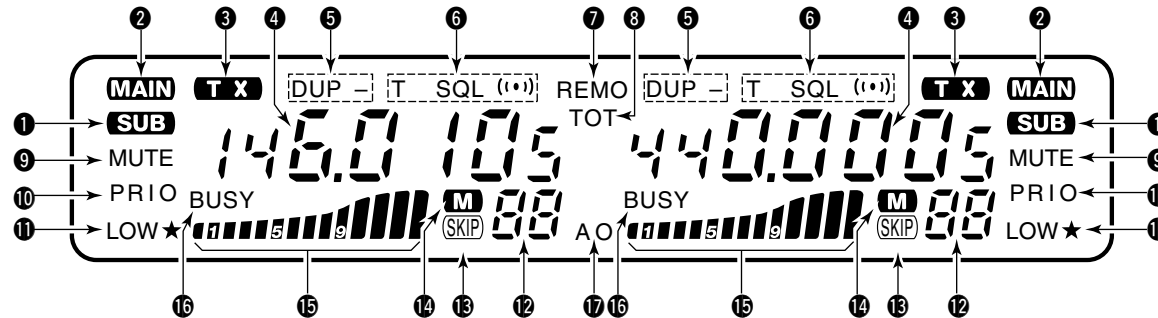

1 SUB BAND ACCESS INDICATORS (p. 22)

Appear when the sub band access function is activated and indicate the function control band via the microphone and some front panel switches (except transmitting).

2 MAIN BAND INDICATORS (p. 15)

Indicate the main band for transmit and function control.

3 TRANSMIT INDICATORS (p. 25)

- Appear while transmitting.
- Flash while transmitting with the one-touch PTT function (p. 26).

4 FREQUENCY READOUTS

- Show the operating frequency, set mode contents, etc.
- The decimal point of the frequency flashes while scanning. (p. 42)

- “d” appears in place of the 100 MHz while the DTMF memory function is in use; when optional units are installed, “P,” or “C” appears in place of the 100 MHz while the pager or code squelch functions are in use, respectively. (pgs. 49, 59, 61)

5 DUPLEX INDICATORS (p. 27)

“DUP-” or “DUP” appear during semi-duplex operation (repeater operation).

6 TONE INDICATORS

- “T” appears while the subaudible tone encoder is in use. (p. 27)
- “T SQL” appears while the optional tone squelch function is in use. (p. 54)
- “T SQL ((·))” appears while the optional pocket beep function is in use. (p. 53)

- 7 EXTERNAL DTMF CONTROL INDICATOR** (p. 63)
 Appears when the optional external DTMF control function is in use.

 - Available for the U.S.A. version only.
- 8 TOT (TIME-OUT TIMER) INDICATOR** (p. 72)
 Appears while the time-out timer has been activated.
- 9 AUDIO MUTE INDICATORS** (p. 21)
 Appear when the audio mute function is activated via microphone control.

 - This function is cancelled when any switch or control is operated.
- 10 PRIORITY WATCH INDICATORS** (p. 48)
 Appear while the priority watch is activated; flash while the watch is paused.
- 11 OUTPUT POWER INDICATORS** (p. 25)

 - ➔ “LOW” appears for low output power. (5 W)
 - ➔ “LOW ★” appears for mid output power. (10 W)
 - ➔ No indicator appears for high output power.
- 12 MEMORY CHANNEL READOUTS**

 - ➔ Show the selected memory channel numbers. (p. 32)
 - ➔ Only 2 capital “L”s appear while the frequency lock function is in use. (p. 16)
 - ➔ A capital “C” appears while on a call channel (p. 37)
 - ➔ “L1–L3” appear when a scratch pad memory is selected. (p. 39)
 - ➔ A small “c” appears when VFO mode is selected from the call channel or a scratch pad memory (pgs. 37, 39)

- 13 SKIP INDICATORS** (p. 45)
 Appear when the displayed memory channel is specified as a skip channel.
- 14 MEMORY INDICATORS** (p. 32)
 Appear when memory mode is selected.
- 15 S/RF INDICATORS** (p. 25)

 - ➔ Show the relative signal strength while receiving signals.
 - ➔ Show the output power selection while transmitting.
- 16 BUSY INDICATORS** (p. 20)
 Appear while a signal is being received or the squelch is open.
- 17 AUTO POWER-OFF INDICATOR** (p. 73)
 Appears while the auto power-off function is in use.

1 PANEL DESCRIPTION

■ Rear panel

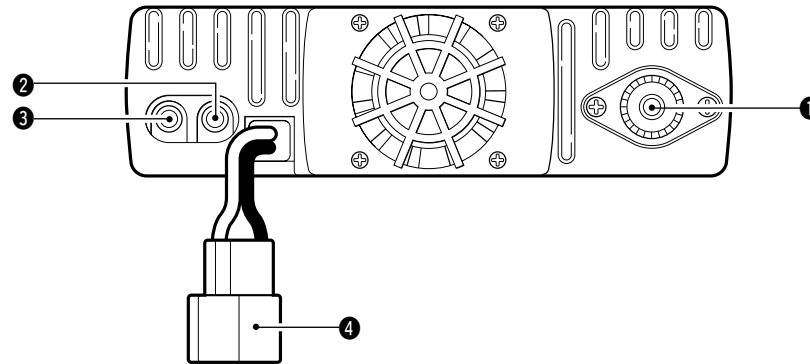

- 1 ANTENNA CONNECTOR [ANT]**
Accepts a 50 Ω dual band antenna with a PL-259 connector. (p. 14)
- 2 SPEAKER JACK 1 [144 MHz SP]**
Connects a 4–8 Ω speaker, if required. Outputs the 144 MHz band's audio. See the table at right for details.
- 3 SPEAKER JACK 2 [430(440) MHz SP]**
Connects a 4–8 Ω speaker, if required. Outputs both band's audio when [430(440) MHz SP] has no connection.
- 4 POWER RECEPTACLE [DC13.8V]**
Accepts 13.8 V DC with the supplied DC power cable.

◇ Speaker information

Connected speaker	VHF band audio	UHF band audio
With no external speakers	Internal speaker (mixed audio)	
[144 MHz SP] only	External speaker	Internal speaker
[430(440) MHz SP] only	External speaker (mixed audio)	
2 external speakers	External speaker via [144 MHz SP]	External speaker via [430(440) MHz SP]

Microphone

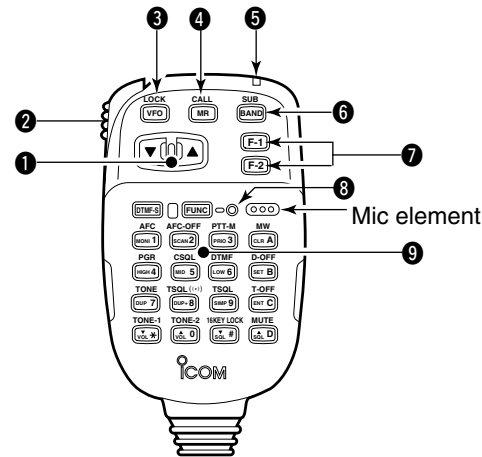

1 UP/DOWN SWITCHES [▲]/[▼]

- ➔ Push either switch to change the operating frequency, memory channel, set mode contents, etc. (pgs. 17, 32)
- ➔ Push and hold either switch to start scanning. (p. 42)

2 PTT SWITCH

- ➔ Push and hold to transmit; release to receive. (p. 25)
- ➔ Toggles between transmitting and receiving while the one-touch PTT function is in use. (p. 26)

3 VFO SWITCH [VFO(LOCK)]

- ➔ Push to select VFO mode.
- ➔ Push and hold to toggle the lock function ON and OFF.

4 MEMORY SWITCH [MR(CALL)]

- ➔ Push to select memory mode. (p. 32)
- ➔ Push and hold to select the call channel. (p. 37)

5 ACTIVITY INDICATOR

Lights red while a key is pushed; lights green while the one-touch PTT function is in use.

6 BAND SWITCH

- ➔ Push to toggle the main band. (p. 15)
- ➔ Push and hold to turn the sub band access function ON and OFF. (p. 22)

7 FUNCTION SWITCHES [F-1]/[F-2] (p. 74)

Assign your desired key function from the front panel switches.

- Default settings are VHF and UHF tuning dials to [F-1] and [F-2], respectively for quick band selection.

8 FUNCTION INDICATOR













- ➔ Lights yellow while [FUNC] is activated—indicates the secondary function of switches can be accessed.
- ➔ Lights green when [DTMF-S] is activated—DTMF signals can be transmitted with the keypad. (p. 51)

9 KEYPAD









Used for controlling the transceiver, transmitting a DTMF encoder, etc. See pgs. 7 and 8 for function details.

1 PANEL DESCRIPTION

■ Microphone keypad

KEY	FUNCTION	SECONDARY FUNCTION (after )	OTHER FUNCTIONS
	Toggles between opening and closing the accessed band's squelch. (p. 20)	No secondary function.	After  : Transmit the appropriate DTMF code or push [1] to [8] to transmit the DTMF memory contents when the DTMF memory encoder is activated. (p. 51)
	<ul style="list-style-type: none"> Starts and stops scanning. (p. 42) Starts tone scan when an optional tone squelch is in use. (p. 55) 	No secondary function.	
	Starts and stops priority watch. (p. 48)	Turns the one-touch PTT function ON and OFF. (p. 26)	
	Selects high output power. (p. 26)	Turns the optional pager function ON. (p. 59)	
	Selects middle output power. (p. 26)	Turns the optional code squelch function ON. (p. 62)	
	Selects low output power. (p. 26)	Turns the DTMF memory encoder function ON. (p. 50)	
	Selects -duplex. (p. 28)	Turns the subaudible tone encoder ON. (p. 28)	
	Selects +duplex. (p. 28)	Turns the optional pocket beep function ON. (p. 53)	
	Selects simplex (p. 28)	Turns the optional tone squelch function ON. (p. 54)	
	Increases the audio output. (p. 20)	While being pushed, transmits a 1750 Hz tone. (p. 28)	

PANEL DESCRIPTION 1

KEY	FUNCTION	SECONDARY FUNCTION (after )	OTHER FUNCTIONS
	<ul style="list-style-type: none"> • Clears a digit before entry. (p. 19) • Cancels the scan, priority watch, pager, code squelch or DTMF memory function. (pgs. 42, 48, 51, 59, 62) 	<ul style="list-style-type: none"> • Writes the VFO contents into the memory channel or call channel. (pgs. 34, 38) • Advances the memory channel number when continuously pushed after programming is completed. (p. 34) 	After  : Transmit the appropriate DTMF code. (p. 51)
	Enters set mode and advances the set mode selection order. (p. 82)	Turns the pager, code squelch, DTMF memory or DTMF remote function OFF. (pgs. 59, 62, 63)	
	<ul style="list-style-type: none"> • Sets the keypad for numeral input. (p. 19) • Decreases the set mode selection order after entering set mode. (p. 82) 	Turns the subaudible tone encoder, pocket beep or tone squelch OFF. (pgs. 28, 53, 54)	
	Increases the squelch level. (p. 20) <ul style="list-style-type: none"> • The [SQL] control on the front panel has priority when rotated. 	Mutes both band's audio signals. (p. 21) <ul style="list-style-type: none"> • Mute function is released when any operation is performed. 	
	Decreases the squelch level. (p. 20) <ul style="list-style-type: none"> • The [SQL] control on the front panel has priority when rotated. 	Locks the digit keys on the keypad (including the A–D, # and * keys. (p. 16)	
	Decreases the audio output. (p. 20)	Sends a 1750 Hz tone signal for 1 sec. (p. 28)	



2

INSTALLATION

■ Installation methods

◇ Single body installation

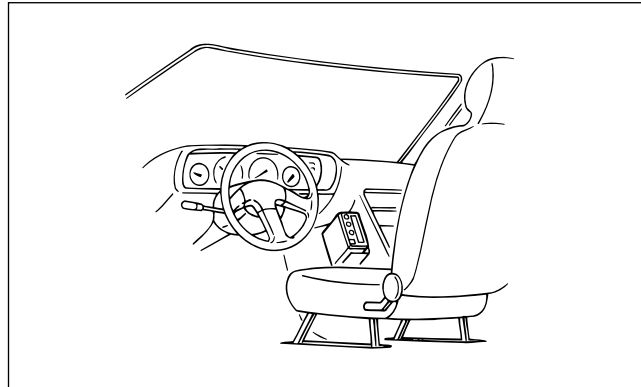

- It is not necessary to purchase a mounting bracket. The supplied mounting bracket (or optional MB-17A) can be used for installation.

◇ Separate installation

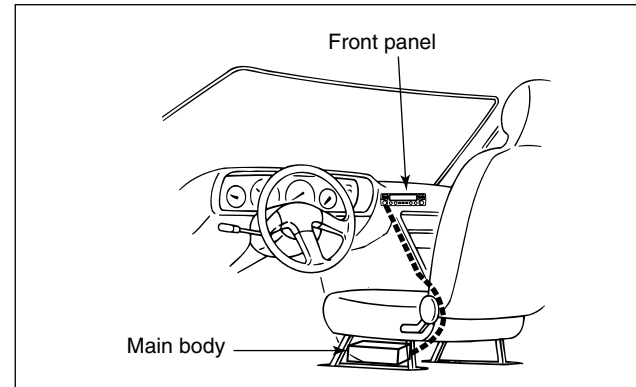

- Optional OPC-600 SEPARATION CABLE (3.5 m; 11.5 ft) or OPC-601 (7.0 m; 23.0 ft) is necessary.
- Optional MB-58 REMOTE CONTROLLER BRACKET is available for front panel mounting.
- Optional MB-65 MOUNTING BASE is available for increasing front panel mounting possibilities (MB-58 is necessary).
- Optional OPC-440 MICROPHONE CABLE (5.0 m; 16.4 ft) and OPC-647 (2.5 m; 8.2 ft) are available to extend the microphone cable.
- Optional OPC-441 SPEAKER CABLE (5.0 m; 16.4 ft) is available to extend the speaker cable.

■ Location

Select a location which can support the weight of the transceiver and does not interfere with driving in any way. We recommend the locations shown in the diagram below.

NEVER place the transceiver or remote controller where normal operation of the vehicle may be hindered or where it could cause bodily injury.
NEVER place the transceiver or remote controller where air bag deployment may be obstructed.
DO NOT place the transceiver or remote controller where hot or cold air blows directly onto it.
AVOID placing the transceiver or remote controller in direct sunlight.

• EXAMPLE INSTALLATION LOCATIONS

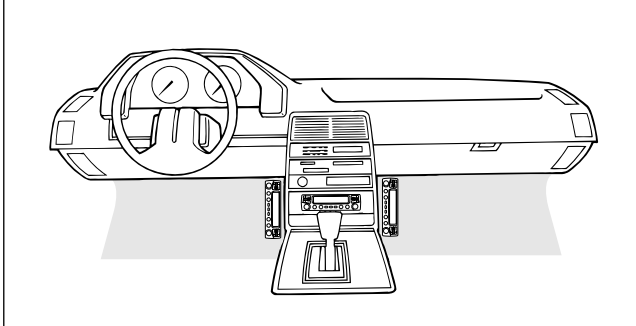

■ Single body installation

- ① Drill 4 holes where the mounting bracket is to be installed.
 - Approx. 5.5–6 mm ($\frac{9}{16}$ in) when using nuts; approx. 2–3 mm ($\frac{1}{16}$ in) when using self-tapping screws.
- ② Insert the supplied screws, nuts and washers through the mounting bracket and tighten.
- ③ Adjust the angle for the clearest view of the function display.

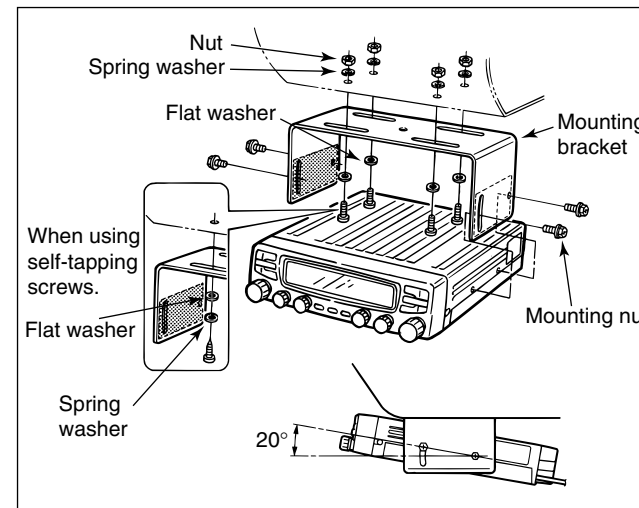

2 INSTALLATION

■ Microphone connection

The microphone connector is located behind the front panel. Connect the supplied microphone as follows:

- ① Push the release button, then detach the remote controller as shown below.
- ② Connect the supplied microphone to the microphone connector.

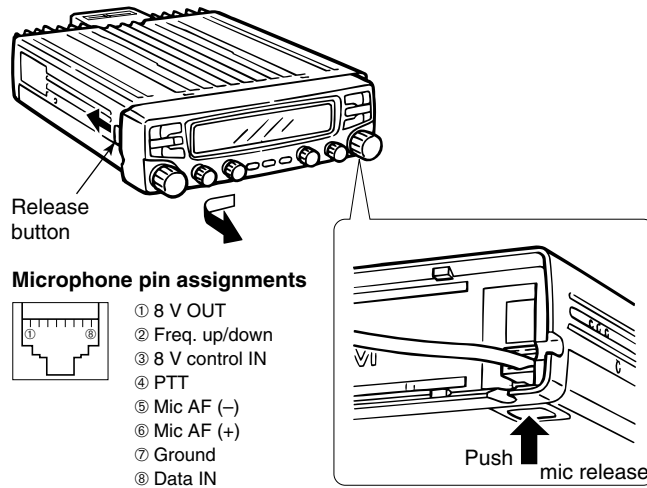

- ③ Reattach the remote controller to the main body.
- ④ To remove the microphone, push the release button as above.

■ Separate installation

Using an optional OPC-600/601 SEPARATION CABLE, the front panel can be separated from the main body, doubling as a remote controller.

- ① Detach the front panel as shown at left.
- ② Connect a separation cable to the front panel and to the main body using the supplied screws as illustrated below.

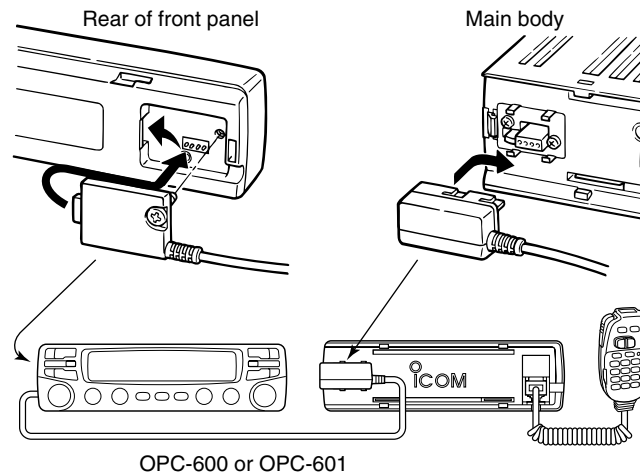

■ Optional MB-58 installation

The optional MB-58 REMOTE CONTROLLER BRACKET is available for separate installation.

- ① Drill 2 or 4 holes where the bracket or mounting base is to be installed, respectively.
 - Approx. 4 mm (1/8 in) when using nuts; approx. 1–2 mm (1/16 in) when using self-tapping screws.
- ② Insert the supplied screws, bolts and washers through the mounting base and tighten.
- ③ Adjust the angle for the clearest view of the function display and tighten 2 screws when the mounting base is used.

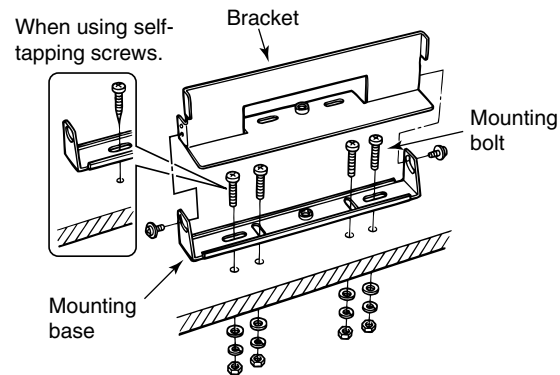

- ④ Attach the supplied Velcro pads (large) to the remote controller and bracket.
- ⑤ Attach the supplied Velcro pad (small) or rubber pad to the bracket as shown below; then attach the remote controller.

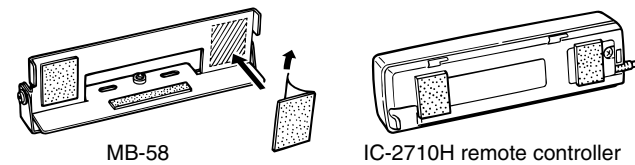

◇ When using the MB-65

Adjust the viewing angle for maximum visibility of the function display.

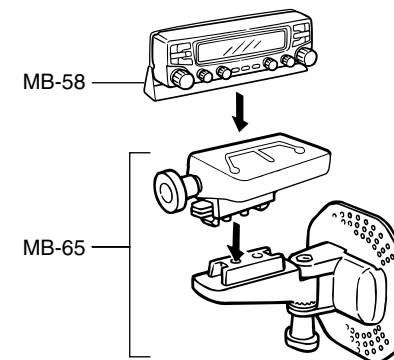

2 INSTALLATION

■ Battery connection

NEVER connect the transceiver directly to a 24 V battery.
DO NOT use the cigarette lighter socket for power connections.

Attach a rubber grommet when passing the DC power cable through a metal plate to prevent short circuits.

• CONNECTING TO A DC POWER SOURCE

See p. 77 for fuse replacement.

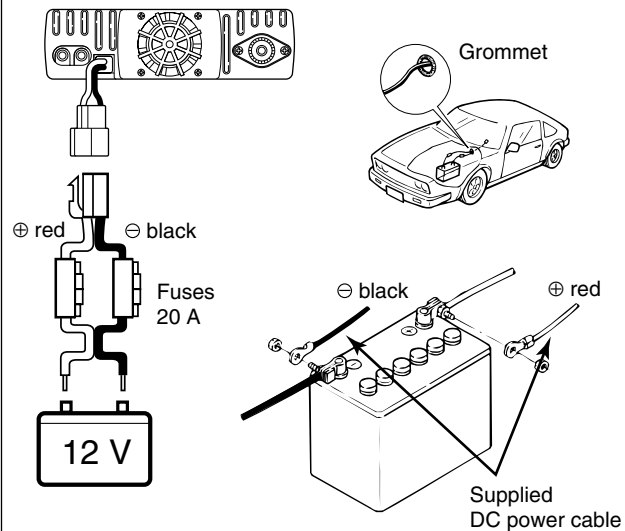

■ DC power supply connection

Use a 13.8 V DC power supply with more than 12 A capability. An optional IC-PS30 DC POWER SUPPLY is available for using the transceiver with a DC power supply in your home.

Make sure the ground terminal of the DC power supply is grounded.

• CONNECTING TO A DC POWER SUPPLY

See p.77 for fuse replacement.

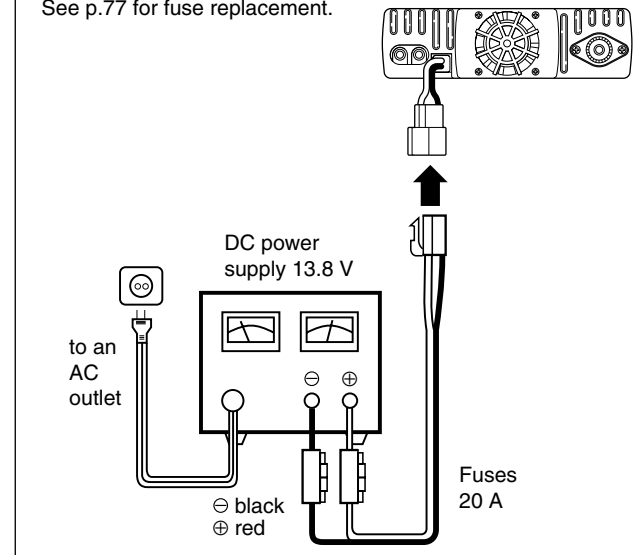

■ Antenna installation

◇ Antenna location

To obtain maximum performance from the transceiver, select a high-quality antenna and mount it in a good location. A non-radial antenna should be used when using a magnetic mount.

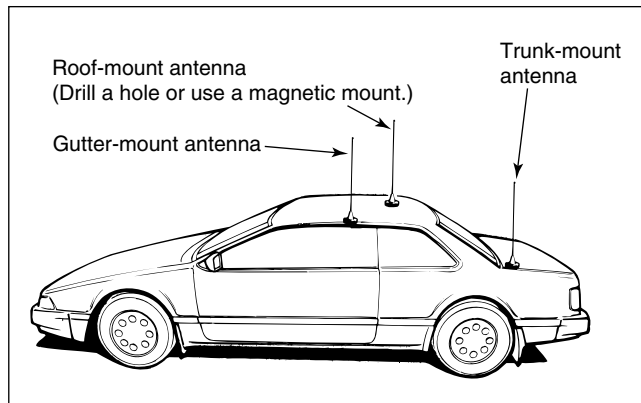

◇ Antenna splitter

You can use a dual band antenna because a duplexer is installed in the transceiver. However, an external duplexer must be connected when using a separate antenna for each band.

◇ Antenna connector

The antenna uses a PL-259 connector.

• PL-259 CONNECTOR

- ① Slide the coupling ring down. Strip the cable jacket and soft solder.

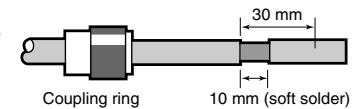

- ② Strip the cable as shown at right. Soft solder the center conductor.

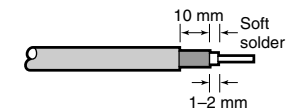

- ③ Slide the connector body on and solder it.

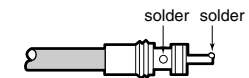

- ④ Screw the coupling ring onto the connector body.

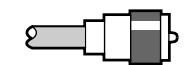

(10 mm \approx 3/8 in)



3

SETTING A FREQUENCY

■ Preparation

◇ Turning power ON

Push [POWER] for 1 sec. to turn power ON.

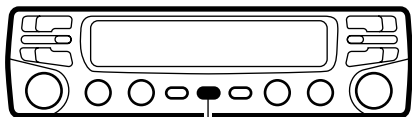

Push [POWER] for 1 sec.

◇ Main band

The IC-2710H can receive 144 MHz and 430(440) MHz band signals simultaneously. Function access or frequency changes affect the main band only. In addition, signals can be transmitted on the main band only. Set the desired band as the main band.

Push the desired band's tuning dial to select the main band.

- "MAIN" indicates the main band.



Push [BAND] to toggle the main band selection between the 144 and 430(440) MHz bands.

◇ VFO and memory modes

The transceiver has 2 normal operating modes: VFO mode and memory mode. You can select VFO mode or memory mode independently on each band.

Push the desired band's [V/MHz] to select VFO mode when the transceiver is not in VFO mode.

- If VFO mode is already selected, the digits below 100 kHz disappear. In this case, push [V/MHz] again (or push twice depending on version).

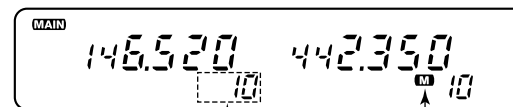

VFO mode is selected Indicates memory mode



Push [VFO] to select VFO mode.

- The microphone controls the main band only (or using sub band access; p. 22). Push [BAND] to toggle the main band, then push [VFO], if necessary.

■ Lock functions

To prevent accidental frequency changes and unnecessary function access, use the lock function. The transceiver has 2 different lock functions.

◇ Frequency lock

This function locks the tuning dials and switches electronically and can be used together with the microphone lock function.

Push and hold [(SET)L] until "L" appears in the memory channel readout to activate the function.

- To cancel the function, push and hold [(SET)L] until "L" disappears.
- [PTT], [BAND], [MONI], [MUTE], [VOL] and [SQL] can be used while the frequency lock function is in use. Also, DTMF tones or DTMF memory contents can be transmitted from the microphone.

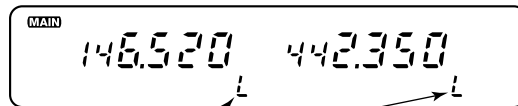

2 "L"s appear while the frequency lock function is in use.

- 
 Push and hold [(VFO)LOCK] for 1 sec. to toggle the function ON and OFF.

◇ Microphone keypad lock

This function locks the microphone keypad.

- 
 Push [FUNC] then [#16 KEYLOCK] to toggle the microphone keypad lock function ON and OFF.

- [PTT] and the 7 keys on the upper half of the microphone can be used.
- All switches on the transceiver can be used.
- The keypad lock function is released when the power is turned OFF then ON again.

3 SETTING A FREQUENCY

■ Using a tuning dial

- ① Rotate the desired band's tuning dial to set the frequency.
 - If VFO mode is not selected, push the same band's [V/MHz] to select VFO mode.
 - Frequency changes according to the selected tuning steps. (p. 18)
- ② For the 1 MHz frequency setting, rotate the same band's tuning dial after pushing [V/MHz].
 - Pushing [V/MHz] for 1 sec. starts a scan function. If this happens, push [V/MHz] again to stop the scan.

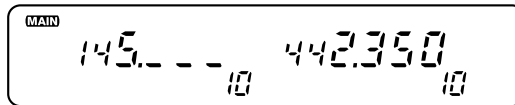

The display shows that the 1 MHz tuning step is selected for the VHF band.

◇ 10 MHz steps

Some versions have 10 MHz tuning steps. For these versions the [V/MHz] switch selects 10 MHz, 1 MHz then kHz steps in sequence.

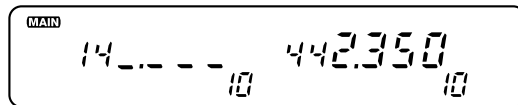

■ Using [▲]/[▼] switches



- Push [▲] or [▼] to set the main band's frequency.
- If VFO mode is not selected, push [VFO] to select it.
 - Frequency changes according to the selected tuning steps. (p. 18)
 - Pushing [▲] or [▼] for more than 0.5 sec. activates a scan. If this happens, push [▲] or [▼] again to stop it.

NOTE: 1 MHz steps cannot be used via the [▲]/[▼] switches

■ Tuning step selection USING SET MODE

Tuning steps are the minimum frequency change increments when you rotate the tuning dial or push the [▲] or [▼] switches on the microphone. The following tuning steps are available:

- 5 kHz • 10 kHz • 12.5 kHz • 15 kHz
- 20 kHz • 25 kHz • 30 kHz • 50 kHz

NOTE: For convenience, select a tuning step that matches the frequency intervals of repeaters in your area.

- ① Push the desired band's tuning dial.
- ② Push the selected band's [V/MHz] to select VFO mode if another mode has been selected.
- ③ Push the selected band's [(VOL)SET] one or more times until "tS" appears as shown below.
 - Pushing [(SQL)MONI] reverses the order of selection.
 - Cancel the DTMF memory or optional pager/code squelch in advance. (pgs. 49, 59, 62)
- ④ Rotate the selected band's tuning dial to select the tuning step.
- ⑤ Push the selected band's tuning dial to exit set mode.

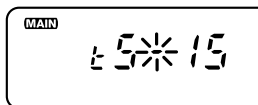

15 kHz tuning step

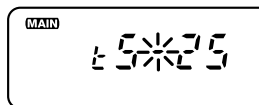

25 kHz tuning step

SET
B

- ① Push [BAND] to set the main band, if necessary.
- ② Push [VFO] to select VFO mode.
- ③ Push [®SET] one or more times until "tS" appears as shown previously.
 - Push [ENT] to reverse the order of selection.
 - Cancel the DTMF memory or optional pager/code squelch in advance. (pgs. 49, 59, 62)
- ④ Push [▲] or [▼] to select the tuning step.
- ⑤ Push [CLR] to exit set mode.

3 SETTING A FREQUENCY

■ Using the keypad

The frequency can be directly set via numeral keys on the microphone.

- 1 Push [BAND] to set the main band, if necessary.
- 2 Push [VFO] to select VFO mode.
- 3 Push [ENT] to activate the keypad for digit input.

- 4 Push 5 keys to input a frequency.
 - When a digit is mistakenly input, push [ENT] to clear the input, then input from the 1st digit.
 - Pushing [CLR] clears input digits and retrieves the frequency.
- 5 Push [▲] or [▼] to make adjustments below the 10 kHz digit, if desired.

[EXAMPLE]: Setting the frequency to 145.360 MHz.

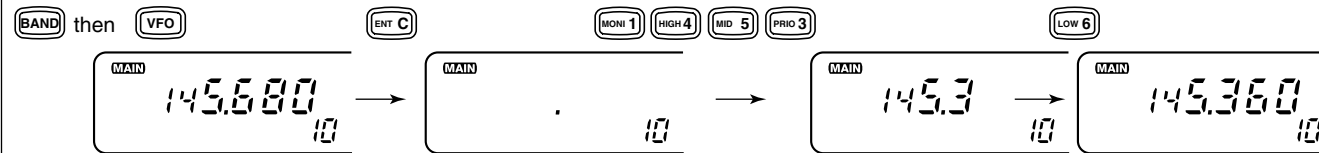

[EXAMPLE]: Setting the frequency to 446.325 MHz. (When the 25 kHz tuning step is selected in UHF.)

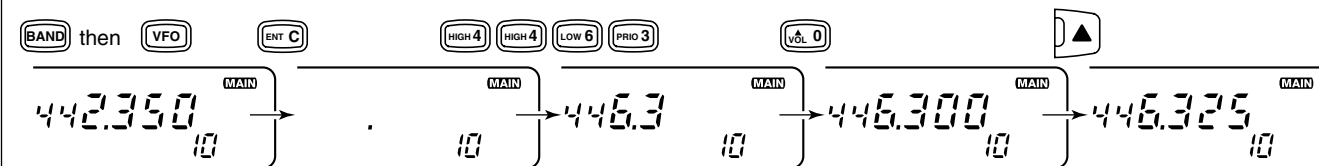

■ Receiving

The IC-2710H can receive 144 MHz and 430(440) MHz band signals simultaneously.

- ① Push [POWER] for 1 sec. to turn power ON.
- ② Set the audio levels.
 - ➔ Push [(SQL)MONI] to open the squelch.
 - ➔ Rotate the [VOL] control to adjust the audio output level.
 - ➔ Push [(SQL)MONI] again to close the squelch.
- ③ Set the squelch levels.
 - ➔ Rotate [SQL] fully counterclockwise in advance.
 - ➔ Rotate [SQL] clockwise until the noise just disappears.
 - ➔ When interference is received, rotate [SQL] clockwise again for attenuator operation.
- ④ Set the operating frequency. (pgs. 15–19)
- ⑤ When receiving a signal on the set frequency, squelch opens and the transceiver emits audio.
 - “BUSY” appears and the S/RF indicator shows the relative signal strength on the received band.



The volume and squelch levels can be adjusted via the microphone. However, levels return to the front panel setting when power is turned OFF or a front panel control is adjusted.

- ① Push [POWER] on the transceiver for 1 sec. to turn power ON.
- ② Set the audio levels.
 - ➔ Select the desired band.
 - ➔ Push [①MONI], then push [⊕▼VOL] or [①▲VOL] to adjust the audio level.
 - ➔ Push [①MONI] again to close the squelch.
- ③ Set the squelch level using [⊕▼SQL] or [①▲SQL], if desired.
- ④ Set the operating frequency. (pgs. 15–19)

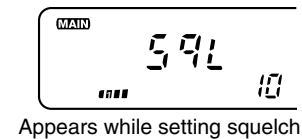
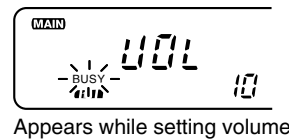

✓ CONVENIENT

RF attenuator: The transceiver has an RF attenuator related to the [SQL] setting. The attenuator is automatically activated when [SQL] is rotated further than the 12 o'clock position. Approx. 10 dB attenuation is obtained at full rotation.

4 BASIC OPERATION

■ Monitor function

This function is used to listen to weak signals without disturbing the squelch setting or to open the desired band's squelch manually even when the optional mute functions such as tone squelch, pager functions, etc., are in use.

Push the desired band's [MONI] to open the desired band's squelch.

- Push [MONI] again to cancel the function.
- While duplex is ON for repeater operation, the transmitting frequency can be monitored with [MONI].

- 
- 1 Push [BAND] to change bands, if necessary.
 - 2 Push [1MONI] to open the main band's squelch.
 - Push [1MONI] again to cancel the function.

■ Audio mute function



This function mutes both band's audio signals without disturbing the volume settings.

- 1 Push [FUNC] then [0MUTE] to mute both band's audio signals.
 - "MUTE" appears for both bands.
- 2 Push [A CLR] (or any other key) to cancel the function.
 - "MUTE" disappears.

■ Avionics band receive (U.S.A. version only)

AM mode can be selected over the range of 118.000 to 135.995 MHz for reception of avionics-related broadcasts.

- ➔ Push and hold [(SQL)MONI] to toggle between AM and FM modes.
 - Mode selection cannot be performed via the microphone.

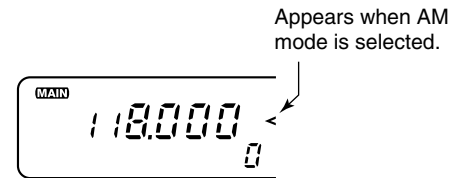

/// **NOTE:** The avionics band can be selected in the left band only, even when the para watch function is in use.

✓ **CONVENIENT**

The tuning steps for the avionics band are available separately from those for other ranges.

■ Sub band access

This function allows you to change sub band settings such as duplex settings, especially useful from the microphone, during transmission standby on the main band.

It's easy to access the sub band and return to the main band with the band switch.

- ① Push and hold the sub band's tuning dial until "**SUB**" appears as shown below.
 - If the [PTT] is pushed at this time, transmit is on the main band.
 - If the main band's tuning dial is mistakenly pushed and held, the para-watch function is activated. In this case, push the main band's tuning dial for 1 sec. and repeat ① again. (p. 24)

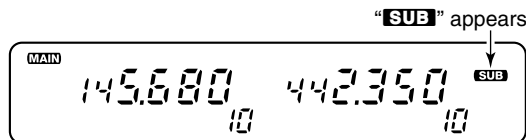

- ② Activate functions such as duplex setting, subaudible tones, etc.
- ③ To exit sub band access, push the main band's tuning dial.
 - To switch from the sub band to the main band, push the sub band's tuning dial.
 - Pushing and holding the sub band's tuning dial until "**SUB**" disappears also exits sub band access.

The sub band access function is also available from the microphone and is useful for setting the sub band's frequency, etc. during transmission standby on the main band.



- ① Push and hold [(BAND)SUB].
 - "**SUB**" appears.
 - If the [PTT] is pushed at this time, transmit is on the main band.
- ② Set the sub band's operating frequency or activate functions.
- ③ To exit sub band access, push and hold [(BAND)SUB] again.
 - "**SUB**" disappears.
 - To switch from the sub band to the main band (for transmitting), push [(BAND)SUB] (momentarily).

4 BASIC OPERATION

■ Sub band mute/ sub band busy beep

USING INITIAL SET MODE

The sub band mute function automatically cuts out sub band AF signals when both main and sub band signals are received simultaneously.

The sub band busy beep sounds when the sub band's squelch is closed to inform you that the sub band's squelch has been opened.

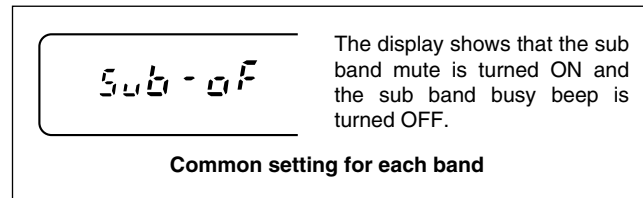

- ① While pushing [(VOL)SET L] (on the left side of the transceiver), push [POWER] to enter initial set mode.
- ② Push [SET] one or more times until "Sub" appears in the display as shown above.
 - Push [MONI] to reverse the order of selection.

- ③ Rotate the main band's tuning dial to set the condition.

DISPLAY	SUB BAND MUTE	BUSY BEEP
Sub-oF	OFF	OFF
Sub-oF ((•))	OFF	ON
Sub-on	ON	OFF
Sub-on ((•))	ON	ON

- ④ Push [POWER] momentarily to exit initial set mode.

■ Para-watch

The IC-2710H can simultaneously receive 2 signals on the same band, 144 MHz or 430(440) MHz band, using the para-watch function.

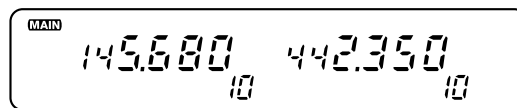

↑ Can be switched
between VHF and
UHF. ↓

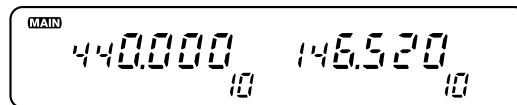

[EXAMPLE]

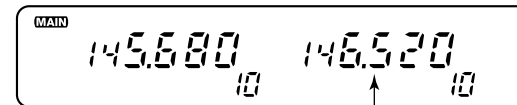

Receiving a VHF signal

- ① Push the desired band's tuning dial to assign the main band.
- ② Push and hold the main band's tuning dial until “-144-” or “-430-” (or “-440-” for U.S.A. version) appears to change the operating band.
- ③ Repeat step ② again to cancel the function.

NOTE:

- Memory channels are common for the same band.
- Transmitting on the para-watch frequency is possible and the transmission quality is the same as usual. However, the opposite band's audio is muted, even when both bands are reversed.

F-1
F-2

The para-watch function cannot be activated from the regular microphone keys. However, when the tuning dial function is assigned to the user-programmable keys, [F-1] and [F-2], the para-watch function can be activated via the microphone in the same manner as described above.

4 BASIC OPERATION

■ Transmitting

CAUTION: Transmitting without an antenna may damage the transceiver.

NOTE:

- ➔ To prevent interference, listen on the frequency before transmitting by pushing the main band's [(SQL)MONI] or the microphone's [①MONI].
- ➔ To prevent howling and sensitivity rejection, AVOID setting the 430(440) MHz band frequency near a multiple of the 144 MHz band frequency, e.g. setting for 145 MHz and 435 MHz.



- ① Push the desired band's tuning dial to select the main band for transmitting.
- ② Set the operating frequency. (pgs. 15–19)
 - Select output power if desired. See section at right for details.
- ③ Push and hold [PTT] to transmit.
 - “TX” appears.
 - The S/RF indicator shows the output power selection.
 - The operating frequency, etc. are automatically programmed into a scratch pad memory. See p. 39 for details.
 - One-touch PTT function is available. See p. 26 for details.

- ④ Speak into the microphone using your normal voice level.
 - DO NOT hold the microphone too close to your mouth or speak too loudly. This may distort the signal.
- ⑤ Release [PTT] to return to receive.

■ Selecting the output power

The transceiver has 3 output power levels to suit your operating requirements. Lower output power during short-distance communication may reduce interference to other stations and reduces current consumption.

- ① Push the desired band's tuning dial.
- ② Push [LOW] one or more times to select the desired output power.
 - The output power can be changed while transmitting.

POWER SELECTION	S/RF INDICATOR	VHF	UHF
HIGH		50 W	35 W
MID	LOW ★ 	10 W	10 W
LOW	LOW 	5 W	5 W



The microphone can select the desired output power directly.



① Push [BAND] to select the desired band, if necessary.



② Push [④HIGH] for high output power; [⑤MID] for middle output power; and [⑥LOW] for low output power.

- The output power CANNOT be changed while transmitting.

■ Crossband full duplex

The transceiver can receive a signal on the sub band while transmitting on the main band. Using this capability, crossband full duplex operation is possible. No special setting is necessary for crossband full duplex operation.

- ① Set the desired transmit and receive frequencies on the main and sub bands respectively for your transceiver. (pgs. 15–19)
- ② Set the same frequencies, but set the receive band as the main band for the other transceiver.
- ③ Push and hold [PTT] to operate with full duplex.
 - Transmitting and receiving activate simultaneously.
 - One-touch PTT function (at right) and time-out timer are useful for crossband full duplex operation. (p. 72)

■ One-touch PTT function



The PTT switch can be operated as a one-touch PTT switch (each push toggles transmit/receive). Using this function, you can transmit without pushing and holding the PTT switch.

To prevent accidental, continuous transmissions with the one-touch PTT function, the transceiver has a time-out timer. See p. 72 for details.

- ① Push [FUNC] then [③PTT-M] to turn the one-touch PTT function ON.
 - The activity indicator lights green.
- ② Push [PTT] to transmit and push again to receive.
 - Two beeps sound when transmission is started and a long beep sounds when returning to receive.
 - “TX” flashes while transmitting with the one-touch PTT function.
- ③ Push [FUNC] then [③PTT-M] to turn the one-touch PTT function OFF.
 - The activity indicator goes out.

5 REPEATER OPERATION

■ Operation

- ① Push the desired band's tuning dial.
- ② Set the receive frequency (repeater output frequency). (pgs. 15–19)
- ③ Push and hold [DUP] to select – duplex or push it for 1 sec. again for + duplex.
 - “DUP –” or “DUP” appears to indicate the transmit frequency for minus shift or plus shift, respectively.
 - When the auto repeater function is turned ON, (available for the U.S.A. version only), steps ② and ③ are not necessary. (p. 31)

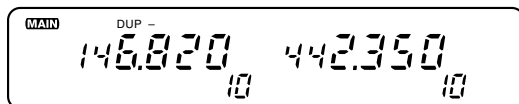

- ④ Push and hold [(DTMF)T] to turn ON the subaudible tone encoder, according to repeater requirements.
 - Refer to p. 29 for tone frequency settings.
 - When the repeater requires a different tone system, see the page at right.

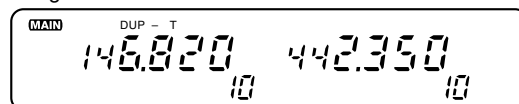

- ⑤ Push and hold [PTT] to transmit.
 - The displayed frequency automatically changes to the transmit frequency (repeater input frequency).
 - The operating condition is automatically programmed into a scratch pad memory. See p. 39 for details.
 - If “oFF” appears, confirm the offset frequency. (p. 30)
- ⑥ Release [PTT] to receive.
- ⑦ Push the selected band's [MONI] to check whether the other station's transmit signal can be directly received or not.
- ⑧ To return to simplex, push [DUP] for 1 sec., once or twice, to clear the “DUP” indicator.
- ⑨ To turn OFF the subaudible tone encoder, push and hold [(DTMF)T].
 - “T” disappears.
 - When the optional UT-104 is installed, push and hold [(DTMF)T] an additional 2 times (for a total of 3 times).



- 1 Push [BAND] to select the desired band, if necessary.
- 2 Set the receive frequency (repeater output frequency). (pgs. 15–19)
- 3 Push [7DUP–] to select – duplex; push [8DUP+] for + duplex.
- 4 Push [FUNC] then [7TONE] to turn ON the sub-audible tone encoder according to repeater requirements.
 - Refer to p. 29 for tone frequency setting.
 - When the repeater requires a different tone system, see at right.
- 5 Push and hold [PTT] to transmit.
- 6 Push and hold [1MONI] to check whether the other station's signal can be directly received.
- 7 Release [PTT] to receive.
- 8 To return to simplex operation, push [9SIMP].
- 9 To turn OFF the subaudible tone encoder, push [FUNC], then [0T-OFF].



◇ DTMF tones



Push [DTMF-S], then push the keys of the desired DTMF digits.

- The function indicator lights green.
- 0–9, A–D, * (E) and # (F) are available.
- Cancel the DTMF memory encoder or optional pager/code squelch function in advance. (pgs. 49, 59, 62)
- Push [DTMF-S] again to return the keypad to normal function control.
- The transceiver has 8 DTMF memory channels for autopatch operation. See p. 49 for details.

◇ 1750 Hz tone



A 1750 Hz tone is required to access most European repeaters. The microphone has 1750 Hz tone capability.



- 1 Push [FUNC].
 - The mode indicator lights orange.
- 2 Push [*TONE-1] to transmit a 1750 Hz tone call signal for 1 sec.; push and hold [0TONE-2] to transmit a 1750 Hz tone call signal for an arbitrary period.
 - The mode indicator goes out automatically.
 - The optional HM-90 also has 1750 Hz tone capability.

5 REPEATER OPERATION

■ Subaudible tones

USING SET MODE

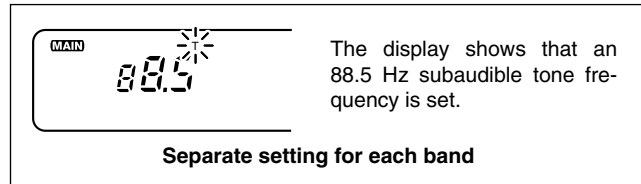

- ① Push the desired band's tuning dial.
- ② Select the mode/channel you wish to set the subaudible tone frequency to, such as VFO mode or memory/call channel.
- ③ Push [SET] one or more times until "T" appears and flashes as shown above.
 - Push [MONI] to reverse the order of selection.
 - Cancel the DTMF memory encoder or optional pager/code squelch function in advance. (pgs. 49, 59, 62)
- ④ Rotate the selected band's tuning dial to select and set the desired frequency.
- ⑤ Push the desired band's tuning dial to exit set mode.

NOTE: The subaudible tone frequency can be set in a memory channel temporarily. However, the set contents are cleared once the memory/call mode is selected. To store the tone frequency permanently, overwrite the channel information.

SET
B

- ① Push [BAND] to select the desired band, if necessary.
- ② Set the mode/channel you wish to set the subaudible tone frequency to, such as VFO mode, memory/call channel or scratch pad memory.
 - The subaudible tone frequency is independently programmed into each mode or channel.
- ③ Push [ⓈET] one or more times until "T" appears and flashes as shown at left.
 - Pushing [ⓈENT] reverses the order of selection.
 - Cancel the DTMF memory encoder or optional pager/code squelch function in advance. (pgs. 49, 59, 62)
- ④ Push [▲] or [▼] to select and set the desired frequency.
 - Pushing and holding [▲] or [▼] changes the frequency continuously.
- ⑤ Push [ⓈCLR] to exit set mode.

• Subaudible tone frequency list (unit: Hz)

67.0	79.7	94.8	110.9	131.8	156.7	171.3	186.2	203.5	229.1
69.3	82.5	97.4	114.8	136.5	159.8	173.8	189.9	206.5	233.6
71.9	85.4	100.0	118.8	141.3	162.2	177.3	192.8	210.7	241.8
74.4	88.5	103.5	123.0	146.2	165.5	179.9	196.6	218.1	250.3
77.0	91.5	107.2	127.3	151.4	167.9	183.5	199.5	225.7	254.1

■ Offset frequency

USING SET MODE

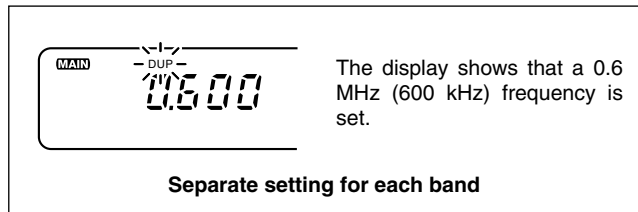

- ① Push the desired band's tuning dial.
- ② Select the mode/channel you wish to set the offset frequency to, such as VFO mode or memory/call channel.
 - The offset frequency can be independently programmed into each mode or channel.
- ③ Push [SET] one or more times until "DUP" appears and flashes as shown above.
 - Pushing [MONI] reverses the order of selection.
 - Cancel the DTMF memory encoder or optional pager/code squelch function in advance. (pgs. 49, 59, 62)
- ④ Rotate the selected band's tuning dial to set the desired frequency.
 - Selectable step increment is the same as the preset tuning step. (p. 18)
 - Use the selected band's [V/MHz] for quick MHz setting.
- ⑤ Push the selected band's tuning dial to exit set mode.

SET
B

- ① Push [BAND] to select the desired band, if necessary.
- ② Set the mode/channel you wish to set the offset frequency to, such as VFO mode or memory/call channel.
 - The offset frequency can be independently programmed into each mode or channel.
- ③ Push [BSET] one or more times until "DUP" appears and flashes as shown at left.
 - Pushing [CENT] reverses the order of selection.
 - Cancel the DTMF memory encoder or optional pager/code squelch function in advance. (pgs. 49, 59, 62)
- ④ Push [▲] or [▼] to select and set the desired frequency.
 - Selectable step increment is the same as the preset tuning step. (p. 18)
 - Pushing and holding [▲] or [▼] changes the frequency continuously.
- ⑤ Push [A CLR] to exit set mode.

NOTE: The offset frequency can be set in a memory channel temporarily. However, the set contents are cleared once the memory/call mode is selected. To store the offset frequency permanently, overwrite the channel information.

5 REPEATER OPERATION

■ Auto repeater (U.S.A. version only)

USING INITIAL SET MODE

The U.S.A. version automatically activates the repeater settings (DUP or DUP– and tone encoder ON/OFF) when the operating frequency falls within the general repeater output frequency range and deactivates them when outside of the range.

◇ Setting the auto repeater function ON/OFF

- ① Push [POWER] to turn power OFF.
- ② While pushing [(VOL)SET L] (left side), turn power ON to enter initial set mode.
- ③ Push [SET L] one or more times until the “rPt” display appears as shown below.
- ④ Rotate the left-hand tuning dial to turn the auto repeater function ON (“rPt-r1” or “rPt-r2”) or OFF (“rPt-oF”).
 - “rPt-r1” and “rPt-r2” automatically set the duplex setting and duplex/tone encoder settings, respectively.
- ⑤ Push [POWER] momentarily to exit initial set mode.

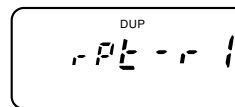

Duplex setting: Automatic ON
Tone encoder: Automatic OFF

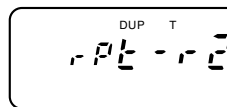

Automatic ON
Automatic ON

◇ Frequency range and offset direction

FREQUENCY RANGE	DUPLEX DIRECTION
145.200–145.495 MHz 146.610–146.995 MHz	“DUP–” appears
147.000–147.395 MHz	“DUP” appears
442.000–444.995 MHz	“DUP” appears
447.000–449.995 MHz	“DUP–” appears

■ General description

The transceiver has 99 regular memory channels plus 6 scan edge memory channels (3 pairs) on each band; each of these can be individually programmed with the following data.

- Operating frequency (pgs. 15–19)
- Duplex direction (DUP or DUP–) and its offset frequency (pgs. 27, 30)
- Subaudible tone encoder or tone squelch*¹ and its tone frequency (pgs. 27, 29)
- Skip information*² (p. 45)

*¹An optional UT-104 TONE SQUELCH UNIT is necessary.

*²Except for the scan edge memory channels.

■ Memory channel selection

◇ Using a tuning dial

- ① Push the desired band's [M/CALL] once or twice to display "M".
- ② Rotate the same band's tuning dial to select the desired memory channel.
 - Only the programmed memory can be selected.

◇ Using [▲]/[▼] switches

- 
- ① Push [BAND] to select the desired band, if necessary.
 - ② Push [MR] to select memory mode.
 - ③ Push [▲] or [▼] several times to select the desired memory channel.
 - Pushing [▲]/[▼] more than 0.5 sec. activates a scan.
 - If a scan is activated, push [▲] or [▼] again to stop it.

◇ Using the keypad

- 
- ① Push [BAND] to select the desired band, if necessary.
 - ② Push [MR] to select memory mode.
 - ③ Push [ENT] to activate the keypad for numeral input.
 - ④ Push 2 appropriate digit keys to input a channel number.
 - When inputting non-programmed channel numbers the previous memory channel appears.
 - To select scan edge channels, "a" and "b" can be used for A and B respectively.

6 MEMORY OPERATION

■ Programming a memory channel

VFO mode settings, including the set mode contents such as subaudible tone frequency, etc., are programmed into a memory channel.

- ① Set the desired frequency in VFO mode:
 - ➔ Push the desired band's [V/MHz] to select VFO mode.
 - ➔ Set the frequency using the desired band's tuning dial.
 - ➔ Set other data (e.g. tone frequency, etc.) if required.
- ② Push [S.MW] momentarily.
 - "M" and the memory channel number flashes.
- ③ Rotate the tuning dial to select the memory channel to be

programmed.

- Memory channels not yet programmed are blank.

- ④ Push [S.MW] for 1 sec. to program.

- 3 beeps may sound.

- Memory channel number automatically advances when continuing to push [S.MW] after programming.

✓ CONVENIENT

Memory programming can be performed in versatile ways e.g. memory channel to the same (or different) memory channel, memory channel to the call channel, etc.

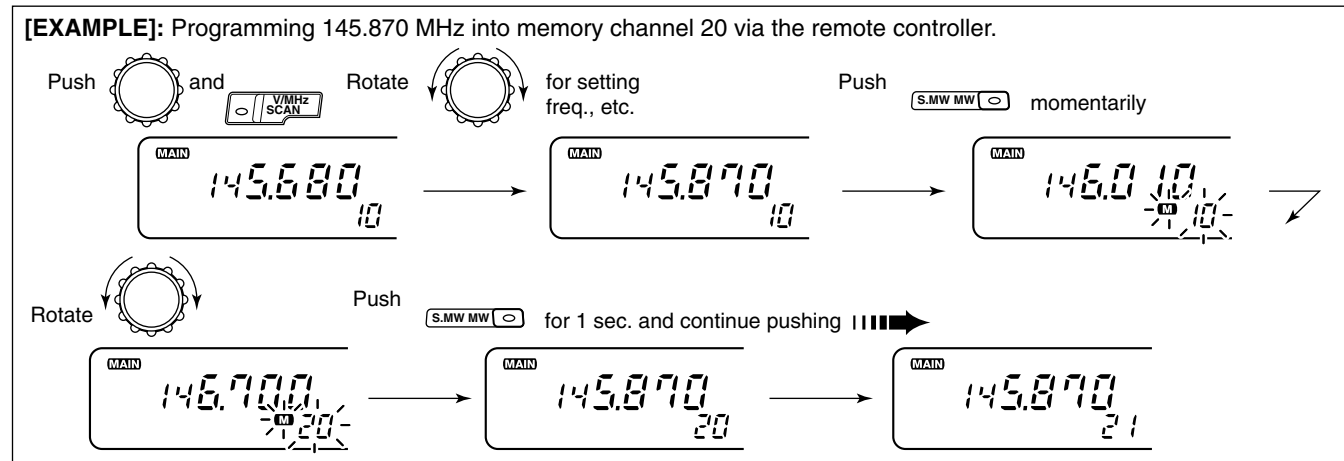

■ Programming a memory channel via the microphone

 Memory channel programming can be performed via the microphone.

- 1 Push [BAND] to select the desired band, if necessary.
- 2 Set the desired frequency in VFO mode:
 - ➔ Push [VFO] to select VFO mode.
 - ➔ Set the frequency using the keypad.
 - ➔ Set other data (e.g. offset frequency, duplex direction, subaudible tone encoder ON/OFF and its frequency), if required.
- 3 Push [FUNC] then [MW] momentarily.
- 4 Select the memory channel to be programmed:
 - ➔ Push [▲] or [▼] to select the memory channel (direct numeral input cannot be used).
- 5 Push [FUNC] then [MW] for 1 sec. to program.
 - ➔ 3 beeps may sound and the VFO contents (including the subaudible tone frequency, etc.) are programmed.
 - ➔ Memory channel number advances when continuing to push [MW] after programming.

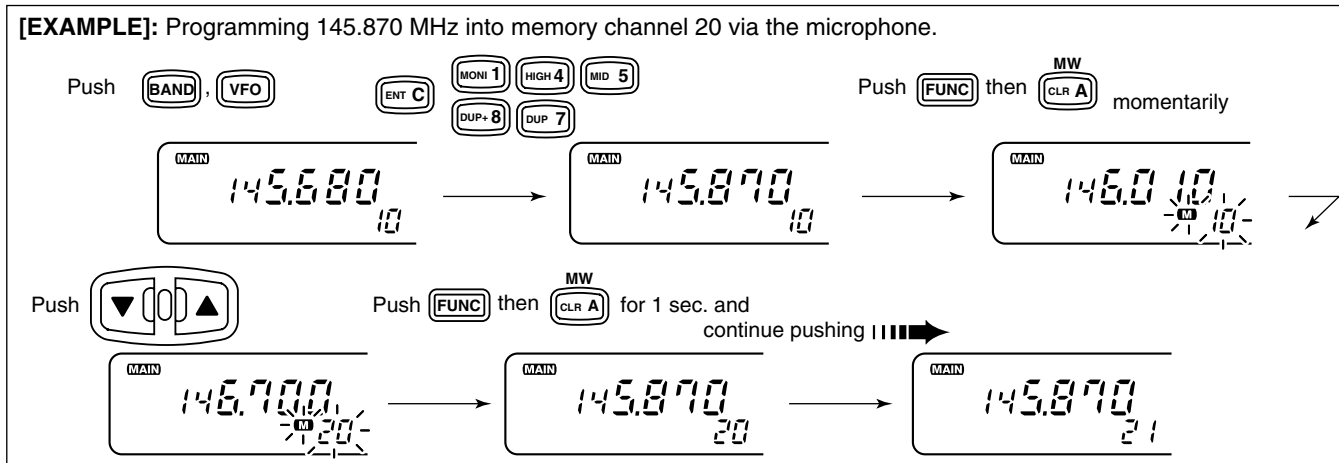

6 MEMORY OPERATION

■ Transferring memory contents

This function transfers a memory channel's contents into a VFO (or another memory/call channel). This is useful when searching for signals around a memory channel frequency and for recalling the offset frequency, subaudible tone frequency, etc.

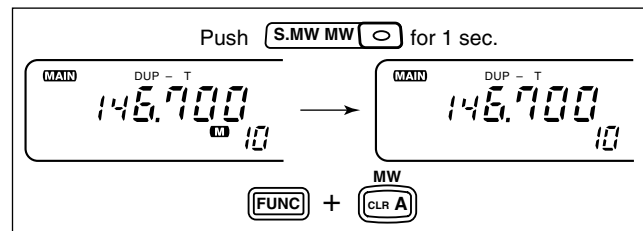

- ① Push the desired band's tuning dial.
- ② Select the memory channel to be transferred:
 - Select memory mode by pushing the selected band's [M/CALL] once or twice ("M" appears).
 - Rotate the selected band's tuning dial to select the memory channel.
- ③ Push [S.MW] momentarily, then rotate the tuning dial to select another memory channel to transfer.
 - To transfer to the VFO, push and hold [(S.MW)MW] instead of pushing momentarily.
- ④ Push and hold [(S.MW)MW] to transfer when a momentary push was used in the previous step.

MW

- ① Push [BAND] to select the desired band, if necessary.
- ② Select the memory channel to be transferred:
 - Push [MR] to select memory mode.
 - Push [▲] or [▼] to select the memory channel; or push [ENT] then push the desired memory channel number (2 digits) to select the memory channel directly.
- ③ Push [FUNC] then [MW] momentarily, then push [▲] or [▼] to select another memory channel to transfer.
 - To transfer to the VFO, push [FUNC] then push and hold [MW] instead of pushing momentarily.
- ④ Push [FUNC] then [MW] for 1 sec. to transfer when a momentary push was used in the previous step.

■ Memory clearing

Contents of programmed memories can be cleared (blanked), if desired.

- ① Push [S.MW] momentarily.
- ② Select the memory channel to be cleared with the tuning dial.
- ③ Push [S.MW] briefly, then a second time for 1 sec.
 - 3 beeps sound, then the frequency is cleared.
 - “M” flashes continuously.
 - Scan edges and call channel cannot be cleared.
- ④ Push any switch to stop the flashing.

NOTE:

Be careful—the contents of cleared memories CANNOT be recalled.

- Memory channel 0 and scan edge channels 1A/1b cannot be cleared.



Memory clearing may not be performed from the microphone.

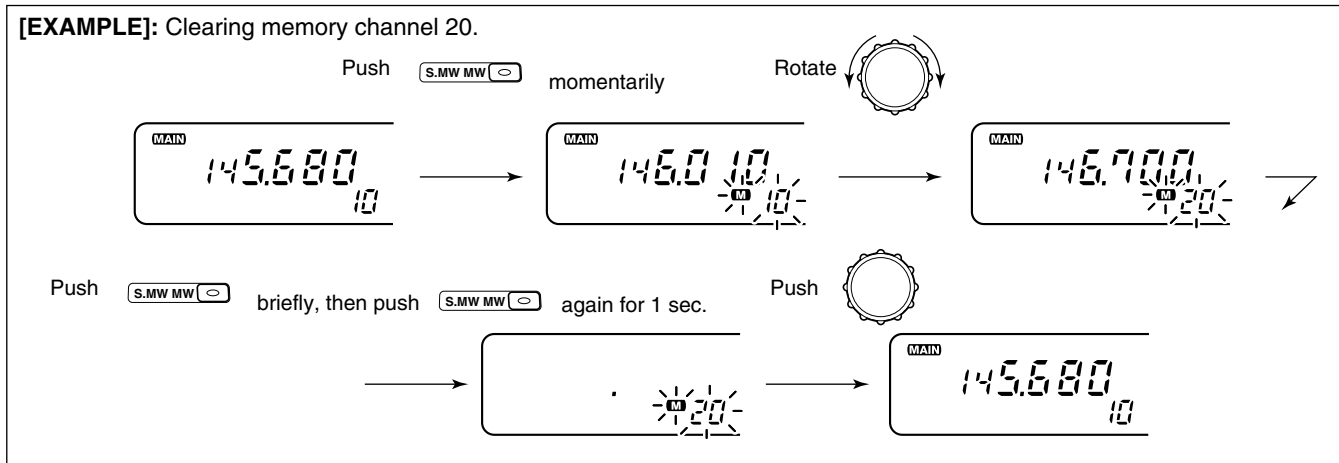

7

CALL CHANNEL OPERATION

■ Calling up a call channel

Each band has an independent call channel to store a most-often-used frequency for quick recall.

- ① Push the desired band's [M/CALL] once or twice to display a large "C" in the memory channel readout.
 - To transmit on the call channel, select the desired band as the main band in advance.
- ② Push the same band's [V/MHz] or [M/CALL] to exit the call channel.

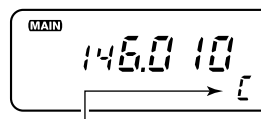

Large "C" shows the call channel is selected.

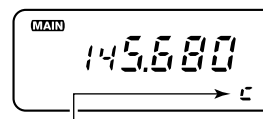

Small "c" shows VFO mode was selected from the call channel.



- ① Push [BAND] to select the desired band, if necessary.
- ② Push [(MR)CALL] for 1 sec. to select the call channel.

■ Transferring call channel contents

- ① Push the desired band's tuning dial.
- ② Select the call channel by pushing the selected band's [M/CALL] once or twice.
 - A large "C" appears.
- ③ Push [S.MW] momentarily, then rotate the tuning dial to select another memory channel to transfer.
 - To transfer to the VFO, push and hold [(S.MW)MW] instead of pushing momentarily.
- ④ Push and hold [(S.MW)MW] to transfer when a momentary push was used in the previous step.



- ① Push [BAND] to select the desired band, if necessary.
- ② Push [(MR)CALL] for 1 sec. to select the call channel.
- ③ Push [FUNC], then [▲MW] momentarily.
 - To transfer to the VFO, push [FUNC] then [▲MW] instead of pushing [▲MW] momentarily.
- ④ Push [FUNC] then [▲MW] for 1 sec. to transfer when momentarily pushing [▲MW] in step ③.

■ Programming a call channel

In addition to an operating frequency, duplex information and subaudible tone information (tone encoder or tone squelch* ON/OFF and its frequency) can be programmed into the call channel.

*An optional UT-104 is necessary.

- ① Push the desired band's tuning dial.
- ② Select the call channel by pushing the selected band's [M/CALL] once or twice. (A large "C" appears.)
- ③ Set the desired frequency in VFO mode:
 - ➔ Push [VFO] to select VFO mode.
 - ➔ Set the frequency using the keypad.
 - ➔ Set other data (e.g. offset frequency, duplex direction, subaudible tone encoder ON/OFF and its frequency), if required.
- ④ Push [(S.MW)MW] for 1 sec. to program.

✓ CONVENIENT

The call channel can also be programmed from the VFO directly (similar to memory programming).



- ① Push [BAND] to select the desired band, if necessary.
- ② Push [(MR)CALL] for 1 sec. to select the call channel.
- ③ Set the desired frequency in VFO mode:
 - Push [VFO] to select VFO mode.
 - Set the desired frequency using the keypad.
 - Set other data, if required.
- ④ Push [FUNC] then [▲MW] for 1 sec. to program.

[EXAMPLE]: Programming 145.120 MHz into the VHF call channel via the microphone.

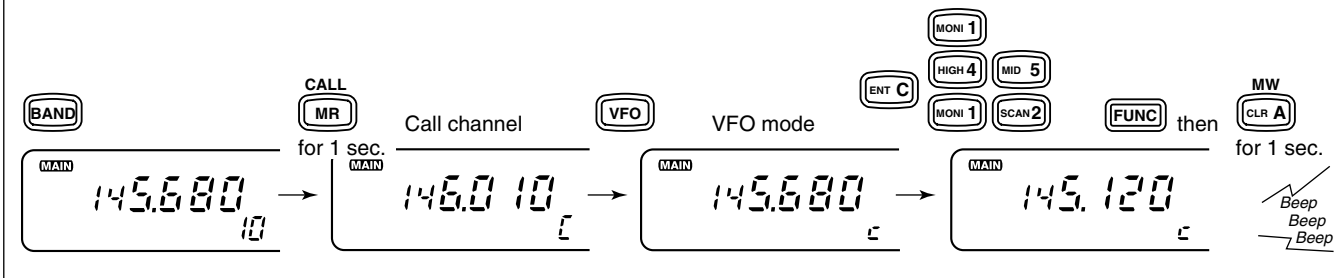

8

SCRATCH PAD MEMORY

■ What is a scratch pad memory?

During VFO operation, the transceiver automatically memorizes operating frequency information, separate from regular memory channels, when transmitting on a new frequency. The 3 previously operated frequencies for each band can be recalled.

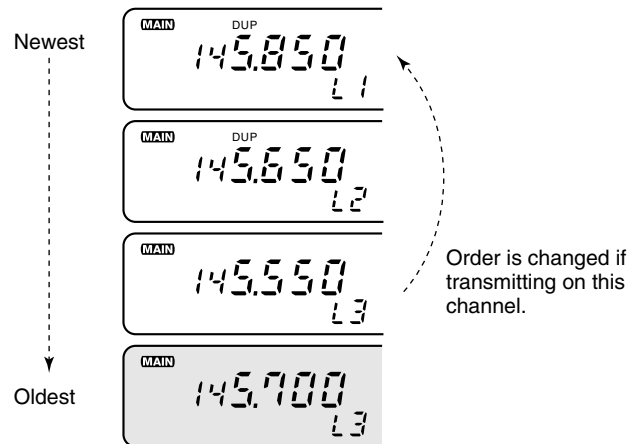

The oldest written frequency is cleared.

/// **NOTE:** When memory mode is selected, the frequency is not programmed into a scratch pad.

■ Calling up a scratch pad memory

- ① Select the call channel by pushing the desired band's [M/CALL] once or twice. (A large "C" appears.)
 - To transmit on the scratch pad memory, select the desired band as the main band in advance.
- ② Rotate the selected band's tuning dial to select a scratch pad memory.
 - Previously transmitted frequency and one of "L1-L3" appears.
 - When first applying power or after CPU resetting, scratch pad memories contain no data and therefore cannot be accessed.
- ③ Push the selected band's [V/MHz] or [M/CALL] to exit the scratch pad memory.
 - /// The 3rd scratch pad memory will be cleared when transmitting on a new frequency. If the transmit frequency is already stored in a scratch pad memory, the scratch pad memory is not cleared but the order is changed.
 - /// When transmitting on a scratch pad memory, the scratch pad memory becomes the 1st scratch pad memory and the order is changed.



- ① Push [BAND] to select the desired band, if necessary.
- ② Push and hold [(MR)CALL] to select the call channel.
- ③ Push [▼] one or more times to select a duplex scratch pad memory.
 - Once entering a scratch pad memory, [▲] can also be used for selection.
- ④ Push [MR] or [VFO] to exit the scratch pad memory.

■ Transferring scratch pad memory contents

Transferring scratch pad memory contents to the VFO is done similarly to transferring regular memory/call channel contents.

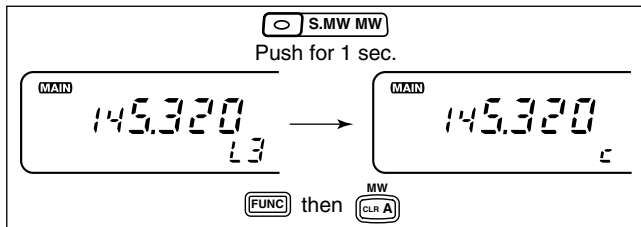

- ① Push the desired band's tuning dial.
- ② Select the call channel by pushing the selected band's [M/CALL] once or twice.
 - A large "C" appears.
- ③ Rotate the selected band's tuning dial to select the desired scratch pad memory.
 - One of "L1"–"L3" appears.
- ④ Push [(S.MW)MW] momentarily.
 - "MW - -" flashes to indicate VFO as the transferring channel.
- ⑤ Rotate the tuning dial to select the desired memory channel if required.
- ⑥ Push and hold [(S.MW)MW] to transfer.



- ① Push [BAND] to select the desired band, if necessary.
- ② Push [(MR)CALL] for 1 sec. to select the call channel.
- ③ Push [▼] one or more times to select the desired scratch pad memory.
- ④ Push [FUNC] then [ⓂMW] momentarily.
 - "MW - -" flashes to indicate VFO as the transferring channel.
- ⑤ Push [▲] or [▼] to select the desired memory channel if required.
- ⑥ Push [FUNC] then [ⓂMW] for 1 sec. to transfer.

■ Scan types

Scanning searches for transmitted signals automatically and makes it easier to locate new stations for contact or listening purposes.

Each band has 3 scan types and 5 resume conditions to suit your needs. Scans on both bands can be operated separately or simultaneously.

FULL SCAN (p. 42)

Repeatedly scans all frequencies over the entire band. Used as the simplest scan without any preliminary settings necessary.

PROGRAMMED SCAN (p. 42)

Repeatedly scans between two user-programmed frequencies. Used for checking for frequencies within a specified range such as repeater output frequencies, etc. 3 pairs of scan edges are available.

MEMORY SCAN (p. 42)

Repeatedly scans memory channels except for skip channels. Used for often-called channels and bypassing normally busy channels such as repeater frequencies.

SCAN RESUME CONDITION (p. 46)

5 resume conditions are available: 3 timer scans, pause scan and empty scan. When receiving a signal, pause scan pauses until the signal disappears; timer scans pause for 5, 10 or 15 sec. Empty pause scan pauses until a signal appears.

/// Scanning with tone squelch:

When an optional tone squelch is in use, tone decode scan activates instead of the above scans. To activate the

above scans with the tone squelch function, push and hold [▲] or [▼] on the microphone.

■ Scan start/stop

◇ Pre-operation

- Common setting: scan resume condition. (p. 46)
- For programmed scan: program the scan edges. (p. 43)
- For memory scan: program 2 or more memory channels; set memory skip settings, if desired. (p. 45)

◇ Operation

- ① Push the desired band's tuning dial.
- ② Select VFO mode for full/programmed scan; or memory mode for memory scan with the selected band's [V/MHz] switch.
- ③ Set the selected band's squelch to the point where noise is muted.
- ④ Push [(V/MHz)SCAN] for 1 sec. to start the scan.
 - When the optional tone squelch is in use, [(V/MHz)SCAN] starts the tone scan.
 - To change the scanning direction, rotate the selected band's tuning dial.
 - The memory channel readout indicates the scan type as follows:

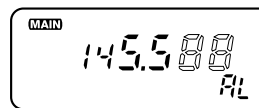

During full scan

Push **SET L**  to select full scan and scan edge pairs in sequence.

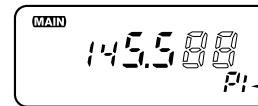

During programmed scan

- Indicates scan edge channels.
- P1 stands for 1A/1b.
- P1 to P3 are available when they are programmed.

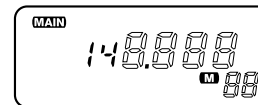

During memory scan

- ⑤ To select the scan range while operating full/programmed scan, push [SET] several times.
- ⑥ To stop the scan, push [(V/MHz)SCAN].



- ① Push [BAND] to select the desired band, if necessary.
- ② Push [VFO] to select VFO mode for full/programmed scan; or push [MR] to select memory mode for memory scan.
- ③ Push [D▲SQL] or [E▼SQL] one or more times to set the squelch just closed.
- ④ Push [3SCAN] to start the scan.
 - [▲]/[▼] also start the scan when pushed and held.
- ⑤ To select the scan range while operating full/programmed scan, push [SET] several times.
- ⑥ To stop the scan push [A CLR].



9 SCAN OPERATION

■ Programming scan edges

Scan edges can be programmed in the same manner as memory channels. Scan edges are programmed into pairs of scan edge channels, 1A/1b to 3A/3b, in memory channels.

- ① Push the desired band's tuning dial.
- ② Set the desired frequency in VFO mode:
 - ➔ Push the selected band's [V/MHz] to select VFO mode.
 - ➔ Set the frequency using the selected band's tuning dial.
 - ➔ Set other data (e.g. offset frequency, etc.) if required.
- ③ Push [S.MW] momentarily.
 - "M" and the memory channel number flashes.
- ④ Rotate the tuning dial to select a scan edge channel (1A to 3A).
- ⑤ Push [(S.MW)MW] for 1 sec. to program.
 - 3 beeps may sound and the frequency is programmed.
 - Scan edge 1b is automatically selected when continuing to push [(S.MW)MW] after programming.
- ⑥ To program a frequency for the other pair of scan edges, 1b to 3b, repeat steps ④ and ⑤.
 - If the same frequency is programmed into both scan edges, programmed scan will not function.

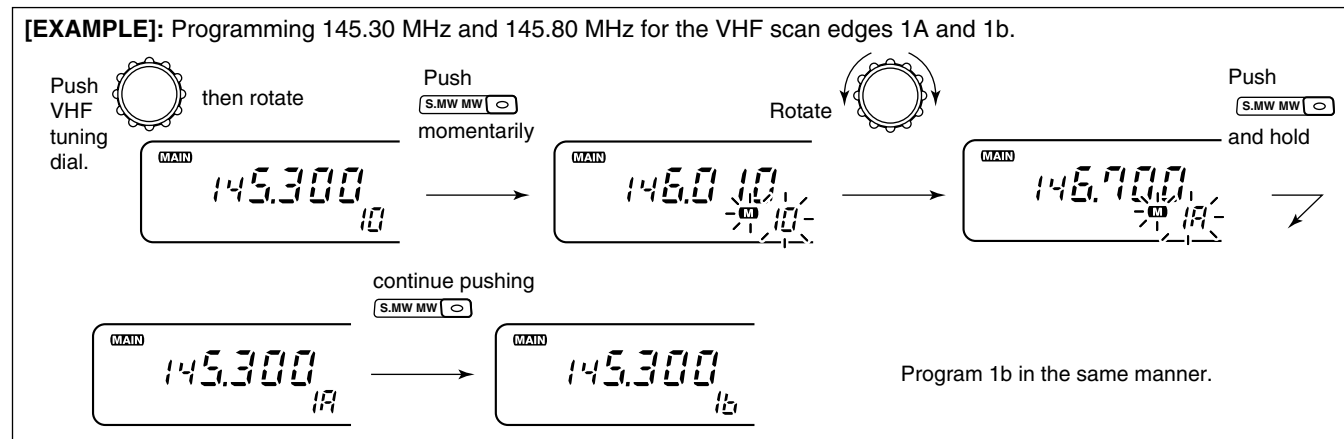

■ Programming scan edges via the microphone

- MW A**
- 1 Push [BAND] to select the desired band, if necessary.
 - 2 Set the desired frequency in VFO mode:
 - ➔ Push [VFO] to select VFO mode.
 - ➔ Set the frequency using the keypad.
 - 3 Push [FUNC] then [Ⓜ] momentarily.
 - 4 Push [▲] or [▼] to select scan edge channels.
 - 5 Push [FUNC] then [Ⓜ] for 1 sec. to program.

- ➔ 3 beeps may sound and the VFO contents (including the sub-audible tone frequency, etc.) are programmed.
 - ➔ Memory channel number advances to the next scan edge channel (1b to 3b) when continuing to push [Ⓜ] after programming.
- 6 To program a frequency for the other scan edge channel, repeat steps 2 and 3.

[EXAMPLE]: Programming 145.30 MHz and 145.80 MHz for the VHF scan edges 1A and 1b.

The diagram illustrates the programming process in two rows:

- Row 1 (Programming 1A):**
 - Starts with the LCD showing 145.600 MHz and channel 10.
 - Buttons: [VFO], [ENT], [MONI 1], [HIGH 4], [MID 5], [PRIORITY 3], [VOL 0].
 - Next LCD shows 145.300 MHz and channel 10.
 - Buttons: [FUNC], [MW CLR A].
 - Final LCD shows 146.0 MHz and channel 10.
- Row 2 (Programming 1b):**
 - Starts with the LCD showing 146.700 MHz and channel 1A.
 - Buttons: [▼], [▲].
 - Next LCD shows 145.300 MHz and channel 1A.
 - Buttons: [FUNC], [MW CLR A] (pushed for 1 sec. and continued).
 - Final LCD shows 145.870 MHz and channel 1b.
 - Text: "Program 1b in the same manner."

9 SCAN OPERATION

■ Skip channel setting USING SET MODE

The memory skip function speeds up scanning by checking only desired memory channels. Set the memory channels to be skipped or scanned as follows.

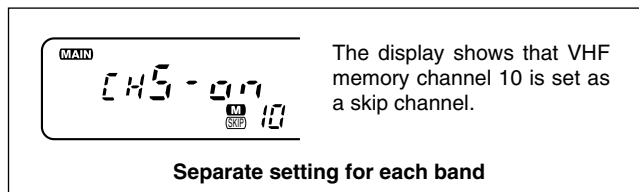

- ① Push the desired band's tuning dial.
- ② Select the memory channel to program or to cancel the skip function on:
 - Select memory mode by pushing the selected band's [M/CALL] once or twice.
 - Rotate the selected band's tuning dial to select the memory channel.
- ③ Push [SET] one or more times until "CHS" appears as shown above.
 - Pushing [MONI] reverses the order of selection.
- ④ Rotate the selected band's tuning dial to turn the skip function ON or OFF on the selected channel.
 - "SKIP" appears : The memory channel is skipped during (CHS-on) memory scan.
 - "SKIP" disappears : The memory channel is scanned during (CHS-OFF) memory scan.

- ⑤ Push the selected band's tuning dial to exit set mode.

NOTE: Scan edge memory channels cannot be specified as skip channels, however, they are skipped during memory scan anyway.

SET
B

- ① Push [BAND] to select the desired band, if necessary.
- ② Select the memory channel to program or to cancel the skip function on:
 - Select memory mode by pushing [MR].
 - Push [▲] or [▼] to select a memory channel.
- ③ Push [SET] one or more times until "CHS" appears as shown at left.
 - Pushing [ENT] reverses the order of selection once entering set mode.
- ④ Push [▲] or [▼] to set or cancel the skip information.
 - See item ④ at left for skip indicator details.
- ⑤ Push [CLR] to exit set mode.

■ Scan resume condition

USING SET MODE

The scan resume condition can be selected as timer, pause or empty pause scan. The empty pause scan is useful for finding unused frequencies. The resume condition is also used for priority watch. (p. 47)

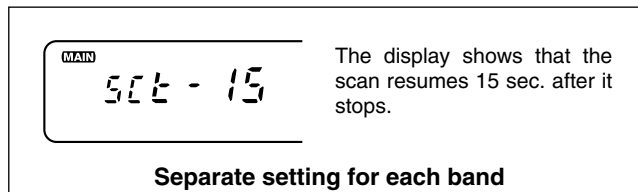

- ① Push the desired band's tuning dial.
- ② Push [SET] one or more times until "SCt" or "SCP" appears as shown above.
 - Pushing [MONI] reverses the order of selection.
 - Cancel the DTMF encoder or optional pager/code squelch in advance. (p. 49, 59, 62)

- ③ Rotate the selected band's tuning dial to set the desired timer.
 - "SCt-15" : Scan pauses 15 sec. while receiving a signal.
 - "SCt-10" : Scan pauses 10 sec. while receiving a signal.
 - "SCt-5" : Scan pauses 5 sec. while receiving a signal.
 - "SCP-2" : Scan pauses until the signal disappears and then resumes 2 sec. thereafter.
 - "SCt-EP" : Scan pauses on a frequency that is not busy and resumes 2 sec. after a signal appears.
- ④ Push the selected band's tuning dial to exit set mode.

SET
B

- ① Push [BAND] to select the desired band, if necessary.
- ② Push [SET] one or more times until "SCt" or "SCP" appears as shown at left.
 - Pushing [ENT] reverses the order of selection once entering set mode.
 - Cancel the DTMF memory encoder or pager/code squelch in advance. (pgs. 49, 59, 62)
- ③ Push [▲] or [▼] to select the scan resume condition.
 - See item ③ above for scan resume condition details.
- ④ Push [CLR] to exit set mode.

10 PRIORITY WATCH

Priority watch types

Priority watch checks for signals on a memory or call channel every 5 sec. while operating on a VFO frequency. The transceiver has 3 priority watch types to suit your needs. You can transmit on the VFO frequency while the priority watch operates.

The watch resumes according to the selected scan resume condition. See p. 46 for details.

NOTE:

- Priority watch cannot be started from a scratch pad memory.
- The DTMF memory encoder or optional pager/code squelch are turned OFF when priority watch starts.
- If the optional pocket beep function is activated, the transceiver automatically selects the tone squelch function when priority watch starts.
- When "SCt-EP" is selected for the scan resume condition, the priority watch pauses on a no-signal channel. (p. 46)

MEMORY CHANNEL WATCH (p. 48)

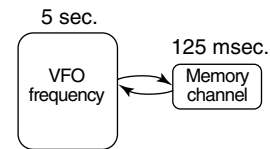

While operating on a VFO frequency, priority watch checks for a signal on the selected memory channel every 5 sec.

- A memory channel with skip information can be watched.

MEMORY SCAN WATCH (p. 48)

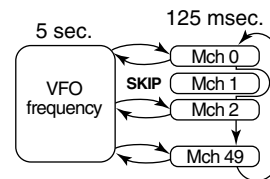

While operating on a VFO frequency, priority watch checks for signals on each memory channel in sequence.

- The memory skip function and memory area setting are useful to speed up the scan.

CALL CHANNEL WATCH (p. 48)

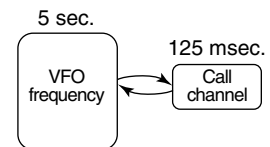

While operating on a VFO frequency, priority watch checks for a signal on the call channel every 5 sec.

■ Priority watch operation

- ① Push the desired band's tuning dial.
- ② Select VFO mode; then, set an operating frequency.
- ③ Set the watching channel(s).
 - For memory channel watch:**
Select the desired memory channel.
 - For memory scan watch:**
Select memory mode; then, push [(V/MHz)SCAN] for 1 sec. to start memory scan.
 - For call channel watch:**
Select the call channel by pushing the selected band's [M/CALL] once or twice.
- ④ Push the selected band's [(M/CALL)PRIO] for 1 sec. to start the watch.
 - The transceiver checks the memory or call channel frequency every 5 sec.
 - The watch resumes according to the selected scan resume condition. (p. 46)
 - While the watch is pausing, pushing the selected band's [M/CALL] resumes the watch manually.
- ⑤ Push the selected band's [M/CALL] while the display shows the VFO frequency to stop the watch.

While pausing on the memory or call channel, "PRIO" flashes. →

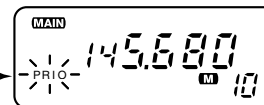

PRIO
3

- ① Push [BAND] to select the desired band, if necessary.
- ② Select VFO mode; then, set an operating frequency.
- ③ Set the watching channel(s).
 - For memory channel watch:**
Push [MR] then [▲] or [▼] to select the desired memory channel.
 - For memory scan watch:**
Push [MR] then [②SCAN] to start the memory scan.
 - For call channel watch:**
Push and hold [(MR)CALL] to select the call channel.
- ④ Push [③PRIO] to start the watch.
 - The transceiver checks the memory or call channel frequency every 5 sec.
 - The watch resumes according to the selected scan resume condition. (p. 46)
 - To resume the watch manually while pausing, push [③PRIO] or [ⒶCLR].
- ⑤ To stop the watch, push [ⒶCLR] once (or twice while watch pauses).



11 DTMF MEMORY ENCODER

■ Programming a DTMF code

DTMF codes are used for autopatching, accessing repeaters, controlling other equipment, etc. The transceiver has 8 DTMF memory channels (d1–d8) for storage of often-used DTMF codes of up to 16 digits.

NOTE: DTMF memory channels are commonly used for both bands. Therefore, programming each band is not necessary.

- ① Push [DTMF] once and “d” appears in place of the main band’s 100 MHz digit as shown below.

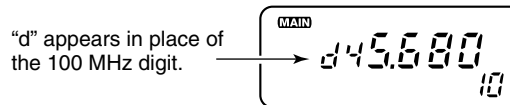

- ② Push [(VOL)SET] to enter the programming condition.
- ③ Rotate the main band’s tuning dial to select the desired channel.
- ④ Push [SET] or [MONI] to select the cursor.
- ⑤ Rotate the main band’s dial to select a digit.
 - “E” stands for “*” and “F” stands for “#.”
- ⑥ Repeat steps ④ and ⑤ until the last digit is entered.
 - The S/RF indicator shows the digit group. The indication increases every 6 digits.
 - Select “-” to clear the remaining digits when programming over a previously used memory channel.

- ⑦ Push the main band’s tuning dial to exit the programming condition.

■ Clearing the DTMF memory contents

- ① Push [DTMF] to turn the DTMF memory encoder ON.
- ② Push [SET] to enter the programming condition.
- ③ Rotate the main band’s tuning dial to select the desired channel.
- ④ Push [SET L] (for VHF display) or [MONI] (for UHF display) to activate the 1st digit.
- ⑤ Rotate the main band’s tuning dial to select “-” and clear the memory channel contents.
- ⑥ Push the main band’s tuning dial to exit the programming condition.

■ Programming a DTMF code via the microphone



DTMF codes can be directly programmed via the keypad on the microphone. The contents can be overwritten, but cannot be cleared via the microphone. See the page at left for clearing the contents.

1 Push [FUNC] then [DTMF] to turn the DTMF memory function ON.

- “d” appears in place of the 100 MHz digit.

2 Push [SET] to enter the programming condition.

3 Push [▲] or [▼] to select the desired channel.

4 Push the desired digit keys.

- When the first digit is input, previous memory contents are cleared automatically.
- “E” stands for “*” and “F” stands for “#.”
- Push [▲] then [▼], and repeat this step when making a mistake.
- The S/R/F indicator shows the digit group. The indication increases every 6 digits.

5 Push the [BAND] to exit the programming condition.

- The [CLR] key cannot be used to exit. If pushed, “A” is input, and the previously programmed data is erased. Reprogram again in such a case.

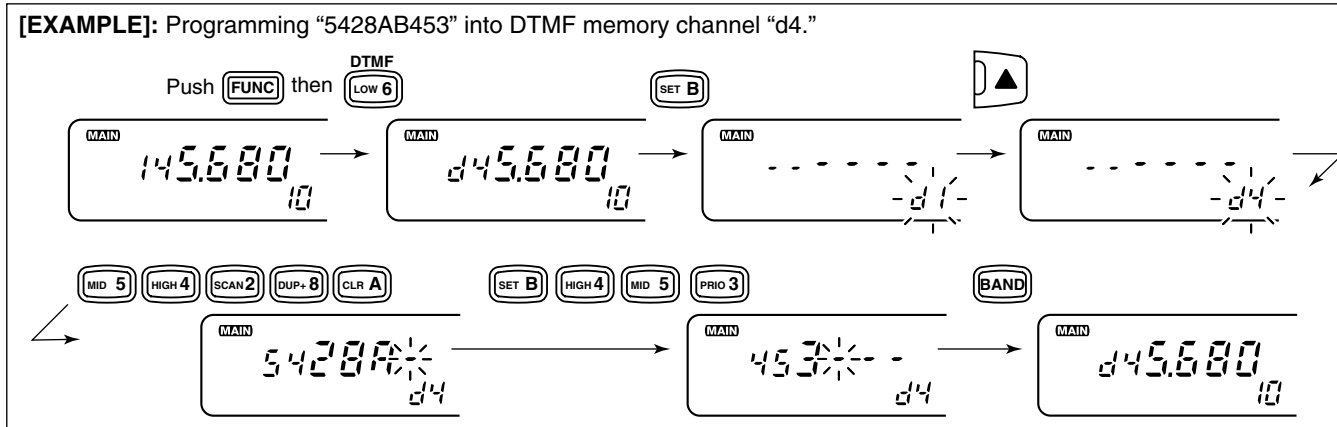

11 DTMF MEMORY ENCODER

■ Transmitting a DTMF code

◇ Using the DTMF memory function (automatic transmission)

The selected DTMF code is transmitted at each push of the PTT switch when the DTMF memory encoder is turned ON.

- ① Push [DTMF] to turn the DTMF memory encoder ON.
 - “d” appears in place of the main band’s 100 MHz digit.
- ② Push [SET] to enter the programming condition.
- ③ Rotate the main band’s tuning dial to select the desired DTMF memory channel.
- ④ Push [PTT] to transmit the selected DTMF code.
 - At each push of [PTT], the selected DTMF code is transmitted.
 - The speaker emits the DTMF tones sent.
- ⑤ Push [DTMF] to cancel the function.
 - “d” disappears.
 - When an optional UT-49 is installed, push [DTMF] several times until a number appears for the 100 MHz digit and “REMO” disappears.



- ① Push [FUNC] then [ⓄDTMF] to turn the DTMF memory encoder ON.
 - “d” appears in place of the main band’s 100 MHz digit.
- ② Push [ⓄSET] to enter the programming condition.
- ③ Push [▲] or [▼] to select the desired channel.

- ④ Push [PTT] to transmit the selected DTMF code.
 - At each push of [PTT], the selected DTMF code is transmitted.
- ⑤ Push [ⓄCLR] to cancel the function.

◇ Transmitting a DTMF memory channel directly



- ① Push [FUNC] then [ⓄDTMF] to turn the DTMF memory encoder ON.
 - “d” appears in place of the main band’s 100 MHz digit.
- ② Push [DTMF-S], then push the desired DTMF channel number.
 - “1” to “8” are available for channel numbers.
- ③ Push [DTMF-S] again to deactivate the DTMF setting.
- ④ Push [ⓄCLR] to turn the DTMF memory encoder OFF.
 - When the DTMF memory encoder is turned ON continuously, each push of the PTT transmits the previously selected DTMF code.

■ DTMF speed

USING INITIAL SET MODE

The rate at which DTMF memories send individual DTMF characters can be set to accommodate operating needs. This setting does not affect an optional pager or code squelch operation.

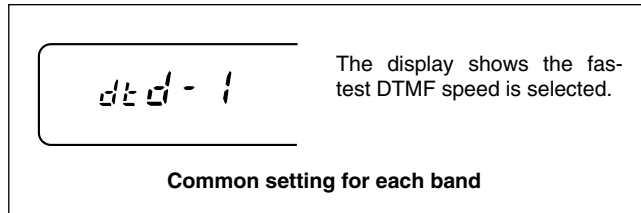

DISPLAY	INTERVAL	SPEED
dtd-1	100 msec.	5.0 cps
dtd-2	200 msec.	2.5 cps
dtd-3	300 msec.	1.6 cps
dtd-5	500 msec.	1.0 cps

cps=
characters/second

- ① Push [POWER] to turn power OFF.
- ② While pushing [(VOL)SET L] (left side), push [POWER] for 1 sec. to turn power ON and enter initial set mode.
- ③ Push [(VOL)SET L] or [(SQL)MONI] to select the "dtd" display as shown above.
- ④ Rotate the main band's tuning dial to select the desired speed as shown in the table at right.
- ⑤ Push [POWER] momentarily to exit initial set mode.



■ Pocket beep operation

This function uses subaudible tones for calling and can be used as a “common pager” to inform you that someone has called while you were away from the transceiver.

To operate the pocket beep function, an optional UT-104 is necessary. See p. 65 for installation details.

◇ Waiting for a call from a specific station

- ① Push the desired band's tuning dial.
- ② Set the operating frequency.
- ③ Program the subaudible tone frequency in set mode.
 - See p. 29 for programming details.
- ④ Push [(DTMF)T] for 1 sec., 2 times to indicate “T SQL ((·))” in the function display.
 - Turn OFF the pager or code squelch to activate the pocket beep. (pgs. 59, 62) The pocket beep cannot be used in combination with the pager or code squelch.
- ⑤ When a signal with the correct tone is received, the transceiver emits beep tones and flashes “((·))”.
 - Beep tones sound for 30 sec. To stop the beeps manually, push the tuning dial (or any key).
 - “((·))” flashes continuously until step ⑥ or ⑦.
 - When receiving another call while “((·))” is flashing, no beeps sound.
- ⑥ Push [PTT] to answer.
 - Tone squelch is automatically selected when transmitting.
- ⑦ Push [(DTMF)T] for 1 sec. once or twice to cancel the function.



- ① Push [BAND] to select the desired band, if necessary.
- ② Set the operating frequency.
- ③ Program the subaudible tone frequency in set mode.
 - See p. 29 for programming details.
- ④ Push [FUNC] then [ⓈT SQL ((·))] to turn the pocket beep ON.
 - Turn OFF the pager or code squelch to activate the pocket beep. (pgs. 59, 62) The pocket beep cannot be used with the pager or code squelch.
- ⑤ When a signal with the correct tone is received, the transceiver emits beep tones for 30 sec. and flashes “((·))”.
- ⑥ Push [PTT] to answer or push [ⒶCLR] to stop the beeps and flashing.
 - Tone squelch is automatically selected.
 - Pushing [FUNC] then [ⓈTSQL] also selects the tone squelch.
- ⑦ To cancel the function, push [FUNC] then [ⓈT-OFF].



◇ Waiting for a call from a specific station

A subaudible tone matched with the stations frequency is necessary. Use the tone squelch on the next page or a subaudible tone encoder (p. 29).

■ Tone squelch operation

The tone squelch opens only when receiving a signal with the same pre-programmed subaudible tone. This function can be activated on both bands with separate tone frequencies simultaneously. To operate the tone squelch function, an optional UT-104 is necessary.

- ① Push the desired band's tuning dial.
- ② Set the operating frequency.
- ③ Program the subaudible tone frequency in set mode.
 - See p. 29 for programming details.
- ④ Push [(DTMF)T] for 1 sec., several times until "T SQL" appears in the function display.
 - The pager or code squelch can be used together with the tone squelch. (p. 62)
- ⑤ When the received signal includes the correct tone, the squelch opens and the signal can be heard.
 - When the received signal includes an incorrect tone, the squelch does not open. However, the S/RF indicator shows the received signal strength.
 - To open the accessed band's squelch manually, push the accessed band's [MONI].
- ⑥ Operate the transceiver in the normal way (push [PTT] to transmit; release [PTT] to receive).
- ⑦ To cancel the tone squelch, push [(DTMF)T] for 1 sec.
 - "T SQL" disappears from the function display.

T SQL
9

- ① Push [BAND] to select the desired band, if necessary.
- ② Set the operating frequency.
- ③ Program the subaudible tone frequency in set mode.
 - See p. 29 for programming details.
- ④ Push [FUNC] then [ⓉSQL] to turn the tone squelch ON.
 - The pager or code squelch can be used with the tone squelch. (p. 62)
- ⑤ When the received signal includes the correct tone, the squelch opens and the signal can be heard.
 - When the received signal includes an incorrect tone, the squelch does not open. However, the S/RF indicator shows the received signal strength.
 - To open the accessed band's squelch manually, push [ⓂMONI].
- ⑥ Operate the transceiver in the normal way (push [PTT] to transmit; release [PTT] to receive).
- ⑦ To cancel the tone squelch, push [FUNC] then [ⓉT-OFF].

T-OFF
C

12 POCKET BEEP AND TONE SQUELCH

■ Tone scan

By monitoring a signal that is being transmitted on a repeater input frequency, you can determine the tone frequency necessary to open a repeater.

An optional UT-104 is required to activate the tone scan.

- ① Push the desired band's tuning dial.
- ② Set the desired frequency to be checked for a tone frequency e.g. repeater input frequency.
- ③ Push [(DTMF)T] for 1 sec., 3 times to display "T SQL."
- ④ Push [(V/MHz)SCAN] for 1 sec. to start the tone scan.
 - To change the scanning direction, rotate the selected band's tuning dial.
- ⑤ When the tone frequency is matched, the squelch opens and the tone frequency is programmed into the selected mode such as VFO, memory/call channel or scratch pad memory.
- ⑥ Push [(V/MHz)SCAN] to stop the scan.
- ⑦ Push [(DTMF)T] for 1 sec. to deactivate the tone squelch or twice to activate the tone encoder with the detected tone frequency.

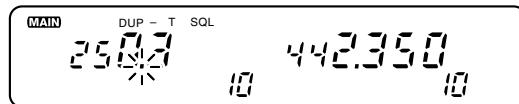

- ① Push [BAND] to select the desired band, if necessary.
- ② Set the desired frequency to be checked for a tone frequency e.g. repeater input frequency.
- ③ Push [FUNC] then [9 T SQL] to turn the tone squelch ON.
- ④ Push [2 SCAN] to start the tone scan.
- ⑤ When the tone frequency is matched, the squelch opens and the tone frequency is programmed into the selected mode such as VFO, memory/call channel or scratch pad memory.
- ⑥ Push [4 CLR] to stop the scan.
- ⑦ Push [FUNC] then [0 T-OFF] to deactivate the tone squelch or push [FUNC] then [7 TONE] to activate the tone encoder with the detected tone frequency.

NOTE: The decoded tone frequency is programmed temporarily when a memory or call channel is selected. However, this will be cleared when overwriting the memory/call channel.

■ Pager function

The pager functions can be used only when an optional UT-49 is installed. This function uses DTMF codes for paging and can be used as a “message pager” to inform you of a caller’s identity even if you leave the transceiver temporarily unattended.

Personal calls and group calls are available with the pager function. Personal calls use the receiving parties’ ID code for calling. The receiving parties’ display shows your ID code and

other stations in the party know that you called.

Group calls use the group code for calling. All station displays show the group code and all stations know that someone in your group called.

To use the pager function in your group, all stations need the pager function.

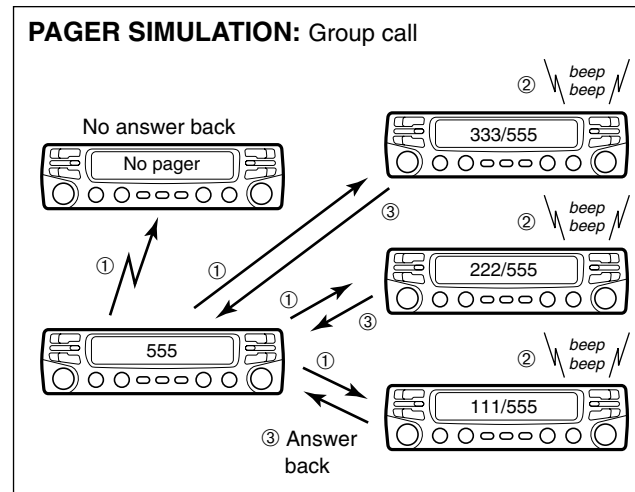
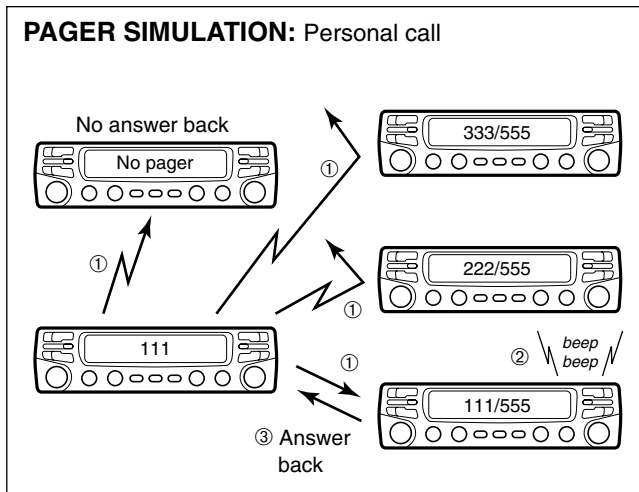

13 PAGER AND CODE SQUELCH

■ Code channels

◇ Before programming

The pager and code squelch functions require ID codes and a group code. These codes are 3-digit DTMF codes and must be written in the code channels before operation. The transceiver has separate code channels for each band.

◇ Code channel assignment

ID OR GROUP CODE	CODE CHANNEL NUMBER	“RECEIVE ACCEPT” OR “RECEIVE INHIBIT”
Your ID code	0	“Receive accept” only.
Other parties’ ID code	1–5	“Receive inhibit” should be programmed in each channel.
Group code	One of 1–5	“Receive accept” must be programmed.
Memory space*	P	“Receive inhibit” only.

* Code channel P automatically memorizes an ID code when receiving a pager call. The contents in channel P cannot be changed manually.

RECEIVE ACCEPT AND INHIBIT

Code channels 1–5 can store the transmit codes for personal calls to other individuals and the group codes for group calls.

The group codes should be programmed as “receive accept” (“**SKIP**” disappears) to receive all calls from group members.

If transmit codes are not programmed as “receive inhibit,” the transceiver accepts calls directed to other individuals and your answer back may confuse other members in your group—this is not a selective calling system. Therefore, transmit codes should be programmed as “receive inhibit” (“**SKIP**” appears) so the transceiver rejects calls directed to other individuals.

■ Code programming

- ① Push the desired band's tuning dial.
 - Each band has separate code channels.
- ② Push [DTMF] 2 times to turn the pager function ON.
 - "P" appears in place of the 100 MHz digit.
- ③ Push [(VOL)SET] to select the code channel setting display.
- ④ Rotate the selected band's tuning dial to select the desired code channel, 0–5.
 - Code channel P cannot be used for programming.
- ⑤ Push [(SQL)MONI] or [(VOL)SET] to select the digit to be programmed.
- ⑥ Rotate the selected band's tuning dial to set the digit.
- ⑦ Repeat ⑤ and ⑥ until the last digit is programmed.
- ⑧ Push [DTMF] to set the code channel for "receive inhibit" or "receive accept."
 - When "receive inhibit" is set, "SKIP" appears.
 - Code channel 0 cannot be set as "receive inhibit."
 - See p. 57 for "receive inhibit" or "receive accept" details.
- ⑨ Push the selected band's tuning dial to exit the setting display.

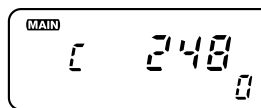

The display shows that VHF code channel 0 (your ID code) is programmed for 248.

SET
B

- ① Push [BAND] to select the desired band, if necessary.
 - Each band has separate code channels.
- ② Push [FUNC] then [PGR] to turn the pager function ON.
 - "P" appears in place of the 100 MHz digit.
- ③ Push [SET] to select the code channel setting display.
- ④ Push [▲] or [▼] to select and set the desired code channel, 0–5.
 - Code channel P cannot be used for programming.
- ⑤ Push the numeral keys to enter the desired 3-digit code.
 - Digits are automatically stored once the 3rd digit has been entered.
- ⑥ Push [SET] to set the code channel for "receive inhibit" or "receive accept."
 - When "receive inhibit" is set, "SKIP" appears.
 - Code channel 0 cannot be set as "receive inhibit."
 - See p. 57 for "receive inhibit" or "receive accept" details.
- ⑦ Push [CLR] to exit the setting display.

13 PAGER AND CODE SQUELCH

■ Pager operation

◇ Calling a specific station

- ① Push the desired band's tuning dial.
- ② Set the operating frequency.
- ③ Push [DTMF] 2 times to turn the pager function ON.
 - "P" appears in place of the 100 MHz digit.
 - An optional tone squelch can be used together with the pager function, although the pocket beep cannot be used. (p. 54)
- ④ Select the desired code channel:
 - ➔ Push [SET].
 - ➔ Rotate the selected band's tuning dial to select the code channel.
 - ➔ Push the selected band's tuning dial to exit the setting display.
- ⑤ Push [PTT] to transmit the pager code.
- ⑥ Wait for an answer back.
 - When the transceiver receives an answer back code, the function display shows the other parties' ID or group code and beeps. (p. 60)
- ⑦ After confirming a connection, push the selected band's tuning dial to display the operating frequency.
 - **DO NOT** push numeral keys on the microphone while a 3-digit code is indicated, or code channel contents are changed.
- ⑧ Push [DTMF] once to select code squelch or 2 times (or 3 times for U.S.A. version) to select the non-selective calling system.

PGR
4

- ① Push [BAND] to select the desired band, if necessary.
- ② Set the operating frequency.
- ③ Push [FUNC] then push [④PGR] to turn the pager function ON.
 - "P" appears in place of the 100 MHz digit.
 - An optional tone squelch can be used together with the pager function. (p. 54)
- ④ Select the desired code channel:
 - ➔ Push [⑤SET].
 - ➔ Push [▲] or [▼] to select the code channel.
 - ➔ Push [⑥CLR] to exit the setting display.
- ⑤ Push [PTT] to transmit the pager code.
- ⑥ Wait for an answer back.
 - When the transceiver receives an answer back code, the function display shows the other parties' ID or group code and beeps. (p. 60)
- ⑦ After confirming a connection, push [⑦CLR] to display the operating frequency.
 - **DO NOT** push numeral keys on the microphone while a 3-digit code is indicated, or code channel contents are changed.
- ⑧ Push [FUNC] then [⑧C SQL] to select code squelch or push [⑧CLR] to select the non-selective calling system.
 - Pushing [FUNC] then [⑧D-OFF] also selects the non-selective calling system.

◇ Waiting for a call from a specific station

- ① Push the desired band's tuning dial.
- ② Set the operating frequency.
- ③ Push [DTMF] to turn the pager function ON.
 - "P" appears in place of the 100 MHz digit.
 - An optional tone squelch can be used together with the pager function, although the pocket beep cannot be used. (p. 54)
- ④ Wait for a call.
 - When receiving a call, the other parties' ID or group code appears; "(·)" and the channel number blink as shown on the next page.
 - **DO NOT** push numeral keys on the microphone while a 3-digit code is indicated, or code channel contents are changed.
- ⑤ Push [PTT] to send an answer back call and display the operating frequency.
- ⑥ Push [DTMF] once to select the code squelch system or 2 times (or 3 times for U.S.A. version) to select the non-selective calling system.



- ① Push [BAND] to select the desired band, if necessary.
- ② Set the operating frequency.
- ③ Push [FUNC] then [④PGR] to turn the pager function ON.
 - "P" appears in place of the 100 MHz digit.
 - An optional tone squelch can be used together with the pager function. (p. 54)
- ④ Wait for a call.
 - When receiving a call, the other parties' ID or group code appears; "(·)" and the channel number blink as shown on the next page.
 - **DO NOT** push numeral keys on the microphone while a 3-digit code is indicated, or code channel contents are changed.
- ⑤ Push [PTT] to send an answer back call and display the operating frequency.
- ⑥ Push [FUNC] then [⑤C SQL] to select code squelch or push [④CLR] to select the non-selective calling system.
 - Pushing [FUNC] then [⑥D-OFF] also selects the non-selective calling system.

13 PAGER AND CODE SQUELCH

PERSONAL CALLS

This display appears when you are called with your ID code and the calling station's ID code is 263.

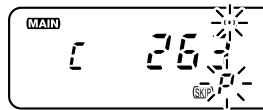

GROUP CALLS

This display appears when you are called with the group code, 123, and 123 has been programmed into code channel 5.

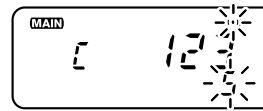

ERROR INFORMATION

When the transceiver receives an incomplete signal, "E" appears.

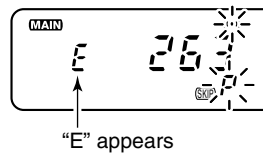

Code squelch function

The code squelch function can be used only when an optional UT-49 is installed.

Code squelch operation provides communication with silent standby since you only receive calls from stations which know your ID or group code. To use the code squelch function in your group, all stations need the code squelch function.

The code squelch function transmits a 3-digit code prior to voice transmission in order to open the receiving station's code squelch.

CODE SQUELCH SIMULATION:

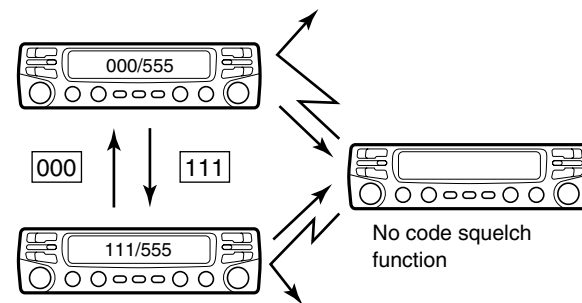

■ Code squelch operation

- ① Push the desired band's tuning dial.
- ② Set the operating frequency.
- ③ Push [DTMF] 3 times to turn the code squelch ON.
 - "C" appears in place of the 100 MHz digit as shown below.
 - An optional tone squelch can be used together with the code squelch, although the pocket beep cannot be used. (p. 54)

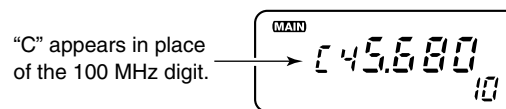

- ④ Select the desired code channel:
 - ➔ Push [SET].
 - ➔ Rotate the selected band's tuning dial to select the code channel.
 - ➔ Push the selected band's tuning dial to exit the setting display.
- ⑤ Operate the transceiver in the normal way (push [PTT] to transmit; release [PTT] to receive).
 - Prior to voice transmission, a 3-digit transmit code is sent each time [PTT] is pushed in order to open the receiving station's code squelch.
- ⑥ To cancel the code squelch, push [DTMF] once (or 2 times for the U.S.A. version).
 - The display shows the operating frequency.

C SQL
5

- ① Push [BAND] to select the desired band, if necessary.
- ② Set the operating frequency.
- ③ Push [FUNC] then [C SQL] to turn the code squelch ON.
 - "C" appears in place of the 100 MHz digit.
 - An optional tone squelch can be used together with the code squelch. (p. 54)
- ④ Select the desired code channel:
 - ➔ Push [SET].
 - ➔ Push [▲] or [▼] to select the code channel.
 - ➔ Push [CLR] to exit the setting display.
- ⑤ Operate the transceiver in the normal way (push [PTT] to transmit; release [PTT] to receive).
 - Prior to voice transmission, a 3-digit transmit code is sent each time [PTT] is pushed in order to open the receiving station's code squelch.
- ⑥ To cancel the code squelch push [CLR].
 - Pushing [FUNC] then [D-OFF] also cancels the code squelch.

CLR
A



14

EXTERNAL DTMF REMOTE (U.S.A. version only) optional UT-49

When installing the optional UT-49 DTMF DECODER UNIT, the U.S.A. version can be remotely controlled using DTMF signals on the sub band. To operate external DTMF remote, a 144 MHz or 430(440) MHz transceiver with a DTMF encoder is required.

- ① Set the sub band frequency to receive a control signal (DTMF code).
 - The optional tone squelch function can be used for the sub band to increase remote control reliability. (p. 54)
- ② Program a 3-digit password into the sub band's code channel 5, if desired. (p. 58)
 - The initial value of code channel 5 is "000; receive accept." If you do not require the password, set the channel as "receive inhibit."
- ③ Select the main band by pushing a tuning dial, then set the desired frequency for operation.
- ④ Push [DTMF] one or more times until "REMO" appears to select standby for the remote control.
- ⑤ Set the operating frequency of the controller transceiver equal to the sub band frequency of the IC-2710H.
 - Make sure a tone frequency is set when using the optional tone squelch function with the IC-2710H.
 - The external DTMF remote does not accept a control signal on the main band frequency.

⑥ From the controller transceiver, transmit the DTMF code as follows:

- "SUB" and "REMO" flash while receiving a control signal.

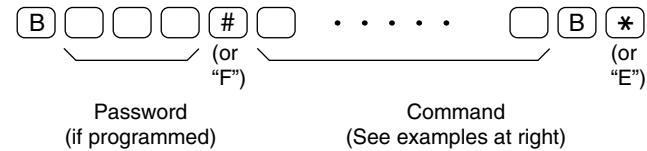

- ⑦ To cancel standby for the remote control, push [DTMF].
 - "REMO" disappears.
 - Pushing [FUNC] then [D-OFF] also cancels standby for the remote control

[EXAMPLE]

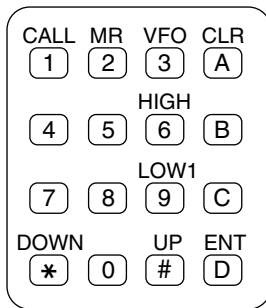

DTMF KEYPAD

144.750 MHz (3) (D) (1) (4) (4) (7) (5)
 VFO [ENT] 100 10 1 MHz 100 10 kHz
 mode MHz MHz kHz

Memory channel 15 (2) (D) (1) (5)
 Memory [ENT] 2 digits
 mode

Scratch pad (1) (*) (*)
 memory 2 Call [DOWN][DOWN]
 channel

- /// Note for the [ENT] key
- When the entered frequency is outside of the frequency coverage, the input digits will be cleared.
 - To adjust the frequency less than 10 kHz or to select a scan edge memory channel (1A, 1b), use the [UP] or [DOWN] key.

[EXAMPLE]: Setting the operating frequency to 145.8125 MHz (when the VHF tuning step is 12.5 kHz).

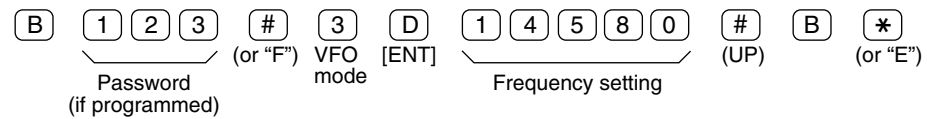

15 OPTIONAL UNIT INSTALLATION

Optional unit installation

There are 2 optional internal units available.

UT-49 DTMF DECODER UNIT

The following functions are added when the UT-49 is installed:

- Pager function
- Code squelch
- External DTMF remote function (U.S.A. version only)

UT-104 TONE SQUELCH UNIT

The following functions are added when the UT-104 is installed:

- Tone decode scan
- Tone squelch (CTCSS tone decoder)
- Pocket beep function

For installation of either unit, proceed as follows:

- ① Turn power OFF then disconnect the DC power cable.
- ② Set the transceiver upside down, then unscrew the one screw from the bottom cover.
- ③ Open the bottom cover. (fig. 1)
 - Use a flat head screwdriver or similar flat instrument to lever the bottom cover open via the 2 openings towards the rear.

⚠ WARNING! NEVER attempt to open the cover using your nails, this may result in injury.

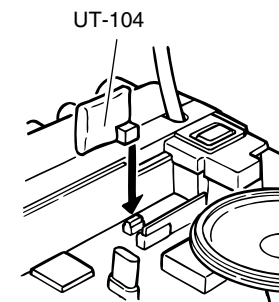
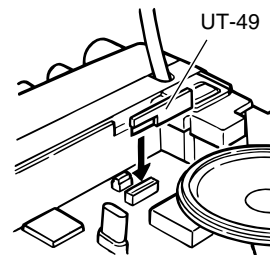
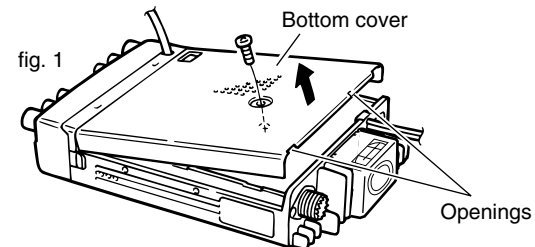

- ④ Plug the unit into the proper position as specified in the above illustration. (fig. 2, 3)
- ⑤ Replace the bottom cover and tighten the screw.

■ Connection

Wireless remote control is available when the following options are used:

- HM-90 WIRELESS MICROPHONE
- EX-1759 INFRARED RECEIVER

The BC-96 MICROPHONE HOLDER is additionally recommended for use with the HM-90, since the HM-90's internal battery requires charging.

◇ Recommended connection

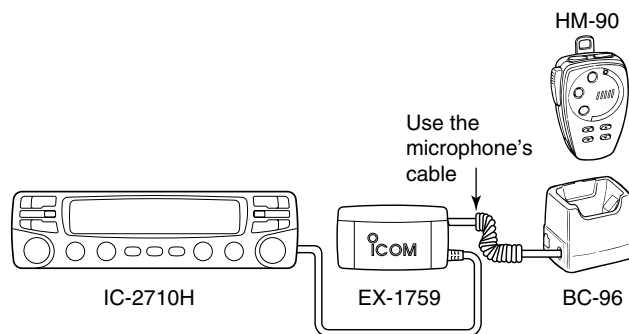

■ HM-90 WIRELESS MICROPHONE

The HM-90's internal battery should be charged when the microphone is not being held.

Charging period: 1.5 hrs. with timer
(or 8 hrs. when battery is exhausted)

Operating period: 12 hrs (Operation : standby= 1 : 4)

◇ Charging method

Choose a method from one of the following:

- Connect the cable from the HM-90 to the EX-1759.
- Connect the BC-96 and EX-1759; then put the HM-90 into the BC-96 (refer to the diagram at left).
- Use the CP-1 CIGARETTE LIGHTER CABLE to connect the BC-96 and cigarette lighter socket.

◇ Turning the wireless remote ON/OFF

When you use the HM-90 as a wired microphone, turn OFF the wireless remote control circuit if desired.

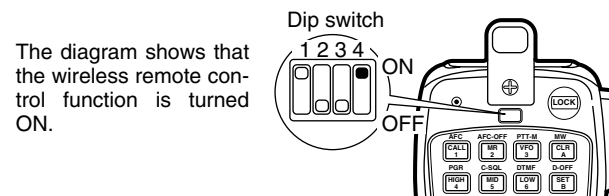

The diagram shows that the wireless remote control function is turned ON.

16 WIRELESS OPERATION

■ EX-1759 installation

The EX-1759 INFRARED RECEIVER can be installed for 2 different purposes depending on the HM-90 charger. This is because the EX-1759 has both an infrared receiver and a microphone connector which contains microphone charging capabilities.

- **When using the BC-96 with external DC input**

Attach the EX-1759 to a suitable location for receiving infrared signals, e.g. sunvisor, etc.

- **When using the connector for a microphone charger**

Attach the EX-1759 to a suitable location for receiving infrared signals and where it can be connected to a cable, e.g. the console, etc.

/// **NOTE:** DO NOT attach the EX-1759 where it will be subject to direct sunlight as it cannot detect infrared signals under such conditions.

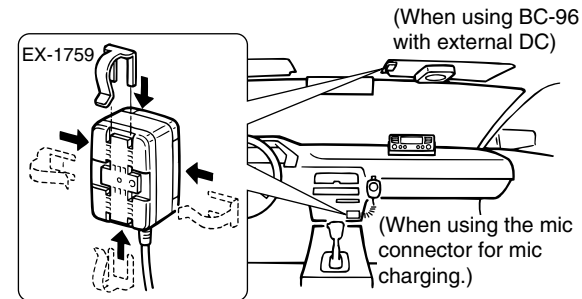

The installation clip can be oriented in 1 of 4 ways.

- **Optional infrared sub receiver**

An optional EX-1513 INFRARED SUB RECEIVER is available to increase the remote control reliability and extend the controllable area. Connect the EX-1513 to the inside connector of the EX-1759.

/// **NOTE:** The supplied microphone, HM-98, can be connected and used with the EX-1759, however, the optional wireless microphone cannot be used in such a case.

■ HM-90 switches

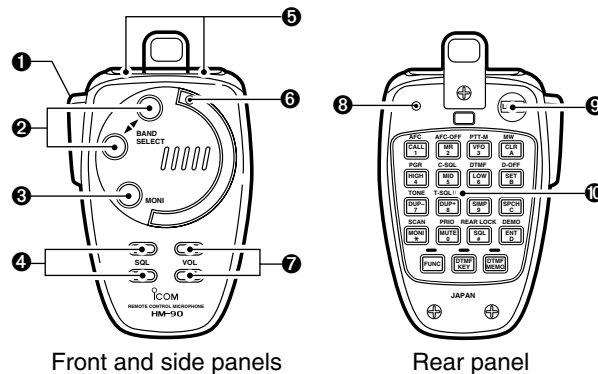

Front and side panels

Rear panel

❶ PTT SWITCH

- ➔ Push and hold to transmit; release to receive.
- ➔ Toggles between transmitting and receiving while the one-touch PTT function is in use.

❷ BAND SWITCHES [BAND SELECT ▲, ▼]

- ➔ Select the desired band as the main band.
- ➔ Activate the para-watch function when pushed and held when the main band is selected.
- ➔ Activate the sub band access function after pushing [FUNC] on the rear panel.

❸ MONITOR SWITCH [MONI]

Toggles between opening and closing the accessed band's squelch.

❹ SQUELCH LEVEL UP/DOWN SWITCHES

[▲SQL], [▼SQL]

Vary the accessed band's squelch threshold point for noise mute.

❺ FREQUENCY UP/DOWN SWITCHES [UP], [DN]

➔ Push either switch to change the operating frequency, memory channel, set mode contents, etc.

➔ Push and hold either switch to start scanning.

❻ ACTIVITY INDICATOR [UP], [DN]

Lights red while a key is pushed; lights green while the one-touch PTT function is in use.

❼ AUDIO VOLUME UP/DOWN SWITCHES

[▲VOL], [▼VOL]

Adjust the accessed band's audio level.

❽ MODE INDICATOR

Indicates the microphone condition.

- Lights red when [FUNC] is pushed.
- Lights green when [DTMF KEY] is pushed.
- Lights orange when [DTMF MEMO] is pushed.

❾ LOCK SWITCH [LOCK]















Locks all switches and keys on the microphone except for the PTT switch.









❿ KEYPAD

Used for controlling the transceiver, transmitting a DTMF memory channel, etc.

16 WIRELESS OPERATION

◇ Keypad

KEY	FUNCTION	SECONDARY FUNCTION (After )	OTHER FUNCTIONS
	Calls up a call channel.	No secondary function.	<ul style="list-style-type: none"> • After  : Input the appropriate digit for frequency or memory channel selection. • After  : Transmit the appropriate DTMF code. • After  : Transmit the appropriate DTMF memory contents. [1] to [8] can be used for DTMF memory.
	Selects memory mode.	No secondary function.	
	Selects VFO mode.	Turns the one-touch PTT function ON and OFF.	
	Selects high output power.	Turns the optional pager function ON.	
	Selects mid output power.	Turns the optional code squelch function ON.	
	Selects low output power.	Turns the DTMF memory function ON.	
	Selects – duplex.	Turns the subaudible tone encoder ON.	
	Selects + duplex.	Turns the optional pocket beep function ON.	
	Selects simplex.	Turns the optional tone squelch function ON.	
	Mutes both bands' audio signals.	Starts and stops a priority watch.	

KEY	FUNCTION	SECONDARY FUNCTION (After )	OTHER FUNCTIONS
	Clears a digit before entry. Cancels the scan, priority watch, pager, code squelch or DTMF memory function.	Writes the VFO contents into the memory channel or call channel. Advances the memory channel number when continuously pushed after programming is completed.	 : • After  : Transmit the appropriate DTMF code. [⊛MONI] Transmits a 1750 Hz tone call signal for 1 sec. [⊛SQL] Transmits a 1750 Hz tone call signal while pushing.
	Enters set mode and advances the set mode selection order.	Turns the pager, code squelch, DTMF memory or DTMF remote function OFF.	
	Decreases the set mode selection order after entering set mode. NOTE: The IC-2710H has no voice synthesizer function.	Turns the subaudible tone encoder, or optional pocket beep/tone squelch OFF.	
	Sets the keypad for numeral input.	Enters and exits demonstration mode.	
	Opens and closes the accessed band's squelch.	Starts and stops scanning. Starts tone scan while an optional tone squelch is in use.	
	Selects 1 of the 4 preset squelch levels.	Locks all the keys on the microphone keypad.	

16 WIRELESS OPERATION

■ Microphone address

USING INITIAL SET MODE

The transceiver has 8 possible microphone addresses to help prevent interference from other HM-90 WIRELESS MICROPHONES. Set both the microphone address and microphone dip switch to the same value as follows.

NOTE: When the supplied microphone is connected, the transceiver rejects control signals from the HM-90 even when the microphone address is matched.

◇ Microphone address

- ① Push [POWER] to turn power OFF.
- ② While pushing [(VOL)SET L], turn power ON to enter initial set mode.
- ③ Push [SET] a few times to select the “Adr” display as shown at right.
- ④ Rotate the left-hand tuning dial to set the microphone address to 0–7 or to turn the microphone control OFF.
 - When “Adr-of” is selected, the transceiver rejects all control signals from the HM-90.
- ⑤ Turn power OFF to exit initial set mode.

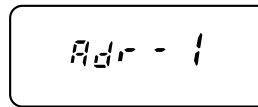

The display shows the microphone address is set to 1.

◇ Microphone dip switch

- ① Remove the switch cover from the microphone rear panel.
- ② Set the microphone dip switch and the microphone address to the same value as shown below.
- ③ Replace the switch cover.

MICROPHONE ADDRESS	DIP SWITCH		
	S1-1	S1-2	S1-3
Adr-0	OFF	OFF	OFF
Adr-1 (default)	ON	OFF	OFF
Adr-2	OFF	ON	OFF
Adr-3	ON	ON	OFF
Adr-4	OFF	OFF	ON
Adr-5	ON	OFF	ON
Adr-6	OFF	ON	ON
Adr-7	ON	ON	ON

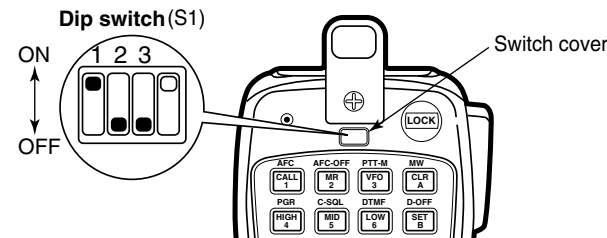

OTHER FUNCTIONS 17

■ Beep tones on/off USING INITIAL SET MODE

You can select silent operation by turning beep tones OFF or you can select to have confirmation beeps sound at the push of a switch by turning beep tones ON.

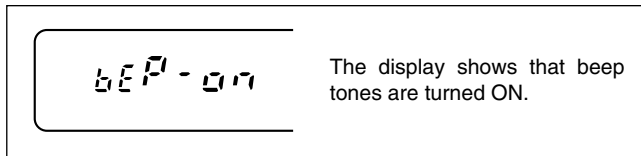

- ① Push power to turn power OFF.
- ② While pushing [(VOL)SET L], turn power ON to enter initial set mode.
- ③ Push [(VOL)SET L] one or more times until “bEP” appears.
 - Pushing [(SQL)MONI] reverses the order of selection.
- ④ Rotate the left-hand tuning dial to select the condition.
 - “bEP-oF”: Beep tones are turned OFF.
 - “bEP-on”: Beep tones are turned ON.
- ⑤ Push [POWER] momentarily to exit initial set mode.

■ Time-out timer USING INITIAL SET MODE

To prevent accidental prolonged transmission with the one-touch PTT function, etc., the transceiver has a time-out timer. This timer cuts a transmission OFF after 3, 5, 15 or 30 min. of continuous transmission. This timer can be cancelled (default).

Approx. 10 sec. before the time-out timer passes, the transceiver emits a beep tone as a warning.

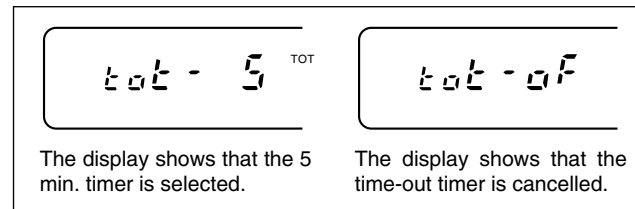

- ① Push [POWER] to turn power OFF.
- ② While pushing [(VOL)SET L], turn power ON to enter initial set mode.
- ③ Push [(VOL)SET L] one or more times until “tot” appears.
 - Pushing [(SQL)MONI] reverses the order of selection.
- ④ Rotate the left-hand tuning dial to select the desired time-out time or turn the timer OFF (“oF”).
- ⑤ Push [POWER] momentarily to exit initial set mode.

17 OTHER FUNCTIONS

■ Auto power-off

USING INITIAL SET MODE

The auto power-off function conveniently turns the transceiver power OFF after a preset time in which no operations are performed. In this way, when you forget to turn the power OFF, the transceiver automatically turns itself OFF, thereby conserving battery power.

The time can be set to 30 min., 1 hr., 2 hr. or turned OFF. The selected time is retained even when the transceiver is turned OFF via the auto power-off function. To cancel the function, select “oF” in step ④ below.

- ① Push [POWER] to turn power OFF.
- ② While pushing [(VOL)SET L], turn power ON to enter initial set mode.
- ③ Push [(VOL)SET L] one or more times until “PoF” appears.
 - Pushing [(SQL)MONI] reverses the order of selection.
- ④ Rotate the left-hand tuning dial to select the desired auto power-off time or turn the timer OFF (“oF”).
 - “AO” appears when an auto power-off time is set.
- ⑤ Push [POWER] momentarily to exit initial set mode.

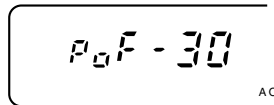

The display shows that the 30 min. timer is selected.

■ Cooling fan setting

USING INITIAL SET MODE

The transceiver has a heatsink and cooling fan to radiate heat. The cooling fan automatically turns ON while transmitting and remains ON for 2 min. after transmitting. The cooling fan can be activated continuously, if desired.

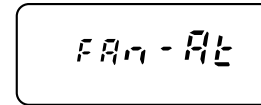

The display shows that the cooling fan is set for automatic operation.

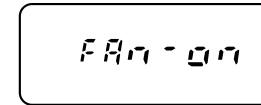

The display shows that the cooling fan is set for continuous operation.

- ① Push power to turn power OFF.
- ② While pushing [(VOL)SET L], turn power ON to enter initial set mode.
- ③ Push [(VOL)SET L] one or more times until “FAn” appears.
 - Pushing [(SQL)MONI] reverses the order of selection.
- ④ Rotate the left-hand tuning dial to set the cooling fan to automatic (“At”) or continuous (“on”).
- ⑤ Push [POWER] momentarily to exit initial set mode.

■ Microphone [F-1]/[F-2] keys

Switches on the transceiver's front panel can be assigned to the microphone's [F-1] and [F-2] keys.

- ① Turn power OFF.
- ② While pushing the desired switch on the transceiver and [F-1] or [F-2] on the microphone, turn power ON.
 - The switches' function is programmed into the key ([F-1] or [F-2]).

• Default setting

The following functions are assigned to the [F-1]/[F-2] keys when first applying power or after CPU resetting:

[F-1]: VHF band tuning dial switch

[F-2]: UHF band tuning dial switch

■ Display dimmer setting

Adjust the intensity to suit lighting conditions and personal preference.

- ① Push and hold [VOL(SET)D] (right side) until "d-1"–"d4" appears as shown below.

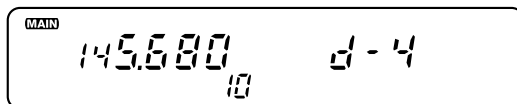

- ② Rotate the tuning dial (right side) to set the desired intensity.
 - Intensity can be set from "d1" (dark) to "d4" (bright).
- ③ Push [VOL(SET)D] to return to normal operation.

■ Demonstration display

A demonstration function is available at power ON. This function gives you a quick visual introduction to the function display indicators.

- ① While pushing either tuning dial, push [POWER] to turn power ON.
 - The transceiver cycles through a visual tour of the function display indicators.
- ② Push any switch to exit demonstration mode and enter the normal operating condition temporarily.

NOTE: The transceiver automatically returns to demonstration mode after 2 min. in which no operations are performed. To deactivate the demonstration display permanently, perform step ① again.

18 MAINTENANCE

■ Troubleshooting

If your transceiver seems to be malfunctioning, please check the following points before sending it to a service center.

PROBLEM	POSSIBLE CAUSE	SOLUTION	REF.
No power comes on.	<ul style="list-style-type: none"> • Power connector has a poor contact. • Polarity of the power connection is reversed. • Blown fuse. 	<ul style="list-style-type: none"> • Check the connector pins. • Reconnect the power cable observing the proper polarity. Replace the fuse, if damaged. • Check the cause, then replace the fuse. 	— pgs. 13, 77 p. 77
No sound comes from the speaker.	<ul style="list-style-type: none"> • Volume level is too low. • The squelch level is set too tight. • An optional selective call or squelch function is activated such as tone squelch, pocket beep, pager or code squelch. 	<ul style="list-style-type: none"> • Rotate [VOL] clockwise. • Set the squelch level to the threshold. • Turn the appropriate function OFF. 	p. 20 p. 20 pgs. 53, 54, 59, 62
Sub band signals are not audible.	<ul style="list-style-type: none"> • The sub band mute function is activated. 	<ul style="list-style-type: none"> • Turn the function OFF. 	p. 23
Sensitivity is low and only strong signals are audible.	<ul style="list-style-type: none"> • Antenna feedline or the antenna connector solder has a poor contact or is short circuited. 	<ul style="list-style-type: none"> • Check, and if necessary, replace the feedline or solder the antenna connector again. 	p. 14
No contact possible with another station.	<ul style="list-style-type: none"> • The transceiver is set to semi-duplex. • The other station is using code or tone squelch. 	<ul style="list-style-type: none"> • Set to simplex. • Turn ON the optional code squelch (UT-49) or optional tone squelch (UT-104). 	p. 28 pgs. 62, 54
Repeater cannot be accessed.	<ul style="list-style-type: none"> • Wrong offset frequency is programmed. • Wrong subaudible tone frequency is programmed. 	<ul style="list-style-type: none"> • Correct the offset frequency. • Correct the subaudible tone frequency. 	p. 30 p. 29
Frequency cannot be set.	<ul style="list-style-type: none"> • The frequency lock function is activated. • Priority watch is paused on the watching frequency. 	<ul style="list-style-type: none"> • Turn the function OFF. • Push [(M/CALL)PRIO] to resume the watch. 	p. 16 p. 48

PROBLEM	POSSIBLE CAUSE	SOLUTION	REF.
Frequency cannot be set via microphone.	<ul style="list-style-type: none"> • The frequency lock function is activated. • The microphone keypad lock function is activated. • Priority watch is paused on the watching frequency. 	<ul style="list-style-type: none"> • Push and hold [(VFO)LOCK] to deactivate the frequency lock function. • Push [FUNC], then [#16KEY LOCK] to deactivate the microphone keypad lock function. • Push the selected band's [(M/CALL)PRIO] to resume the watch. 	<p>p. 16</p> <p>p. 16 p. 48</p>
Some memory channels cannot be selected via the microphone keypad.	<ul style="list-style-type: none"> • The input channel number has not yet been programmed. 	<ul style="list-style-type: none"> • Rotate the tuning dial to check whether the channel has been programmed or not. 	<p>p. 32</p>
Scan does not operate.	<ul style="list-style-type: none"> • Squelch is open. • The selected scan edge memory channels (e.g. 1 A and 1b) have the same frequencies (for programmed scan). • Only 1 memory channel is programmed or other channels are set as skip channels. • Priority watch is activated. 	<ul style="list-style-type: none"> • Set the squelch to the threshold point. • Reset the scan edges. • Program other memory channels or cancel the memory skip function in the desired channels. • Turn the function OFF. 	<p>p. 20 p. 43</p> <p>pgs. 33, 45 p. 48</p>
Transmission is automatically cut off.	<ul style="list-style-type: none"> • Time-out timer is activated. 	<ul style="list-style-type: none"> • Set the timer to OFF. 	<p>p. 72</p>
Transmission continues even when the PTT is released.	<ul style="list-style-type: none"> • One-touch PTT function is activated. 	<ul style="list-style-type: none"> • Turn the function OFF. 	<p>p. 26</p>
The function display shows erroneous information.	<ul style="list-style-type: none"> • The CPU is malfunctioning. 	<ul style="list-style-type: none"> • Reset the transceiver. 	<p>p. 77</p>

18 MAINTENANCE

■ Fuse replacement

If the fuse blows or the transceiver stops functioning, find the source of the problem if possible, and replace the damaged fuse with a new, rated one (FGB 20 A) as shown in the diagram below.

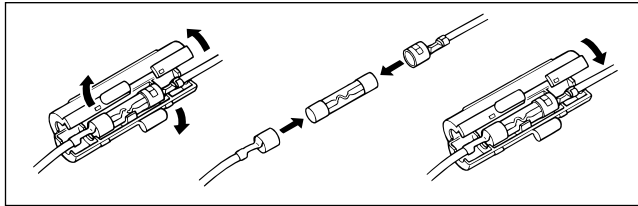

■ Partial resetting

If you want to initialize the operating conditions without clearing the memory contents, etc., a partial reset function is available for the transceiver. The partial reset can be performed independently for each band.

While pushing either left or right, or both [V/MHz] switches, turn power ON to partially reset the transceiver.

- ◆ *Initialized settings:* VFO frequency, SET mode settings.
- ◆ *Retained settings:* Memory channels, call channels, offset freq. in memory/call, DTMF memory, pager and code squelch settings, initial SET mode settings.

■ Resetting the transceiver

The function display may occasionally display erroneous information, (e.g. when first applying power). This may be caused externally by static electricity or other factors.

If this problem occurs, turn power OFF. After waiting a few seconds, turn power ON again. If the problem persists, perform the following procedure.

Partial resetting is alternatively available. See previous section for details.

CAUTION: Resetting the transceiver **CLEARs** all memory information, and initializes all values in the transceiver.

- ① Push [POWER] to turn power OFF.
- ② While pushing both left and right [S.MW] switches, turn power ON.
 - All LCD segments appear momentarily, the initial display appears and the transceiver is reset.

SPECIFICATIONS 19

General

- Frequency coverage

VERSION		VHF	UHF
U.S.A.	Tx	144–148 MHz	440–450 MHz
	Rx	118–174 MHz* ¹	
Asia	Tx	144–148 MHz	430–440 MHz
	Rx	136–174 MHz* ²	
Europe		144–146 MHz	430–440 MHz
Italy	Tx	144–146 MHz	430–440 MHz
	Rx	136–174 MHz* ²	400–479 MHz* ³

*¹118–136 MHz is usable in the VHF display only; guaranteed frequency coverage is 144–148 MHz.

*²Guaranteed frequency coverage is 144–148 MHz.

*³Guaranteed frequency coverage is 430–440 MHz.

- Mode : FM, AM*
(*U.S.A. version only; 118–136 MHz)
- Antenna impedance : 50 Ω (SO-239)
- Power supply requirement : 13.8 V DC ± 15%
- Usable temperature range : –10°C to +60°C; +14°F to +140°F
- Dimensions : 140(W) x 40(H) x 212.4(D) mm
(projections not included) 5½(W) x 1¼(H) x 8¾(D) in
- Weight : 1.4 kg; 3.1 lb

Transmitter

- Modulation system : Variable reactance frequency modulation
- Max. frequency deviation : ± 5.0 kHz
- Spurious emissions : Less than –60 dB
- Microphone impedance : 600 Ω (8-pin modular)

- Output power and current drain:

CONDITION		POWER	CURRENT
144 MHz	High	50 W	12.0 A
	Mid	10 W	6.5 A
	Low	5 W	4.5 A
430(440) MHz	High	35 W	11.0 A
	Mid	10 W	6.5 A
	Low	5 W	4.5 A

Receiver

- Receive system : Double conversion superheterodyne
- Intermediate frequencies :
Left display band 1st 45.05 MHz 2nd 455 kHz
Right display band 1st 57.65 MHz 2nd 455 kHz
- Sensitivity (for 12 dB SINAD) : Less than 0.16 μV (incl. para watch)
- Squelch sensitivity : Less than 0.13 μV (at threshold)
- Selectivity : More than 15 kHz/–6 dB
Less than 30 kHz/–60 dB
- Spurious response rejection ratio : More than 60 dB
- Audio output power : More than 2.4 W at 10% distortion with the 8 Ω internal speaker
- Current drain :
Max rated audio/both bands 1.8 A
Max audio/either band 1.5 A (squelch closed on other band)
Squelched on both bands 1.2 A

All stated specifications are subject to change without notice or obligation

20 OPTIONS

Some of the following options may not be available due to variations in local electrical standards, etc. If you have any questions regarding options please consult your Icom Dealer.

◇ Antenna

AH-32 144/430(440) MHz DUAL BAND ANTENNA

Dual band mobile antenna.

Frequency range: 144–148 MHz and 430–450 MHz.

Max. input power: 150 W

AHB-32 TRUNK MOUNT

Trunk mount with a coaxial cable for the AH-32.

◇ Speakers

SP-7 EXTERNAL SPEAKER

For base station use. Cable length: 1.0 m; 3.3 ft

SP-10 EXTERNAL SPEAKER

Compact design. Cable length: 1.5 m; 4.9 ft

SP-12 EXTERNAL SPEAKER

Slim-type. Cable length: 2.0 m; 6.6 ft

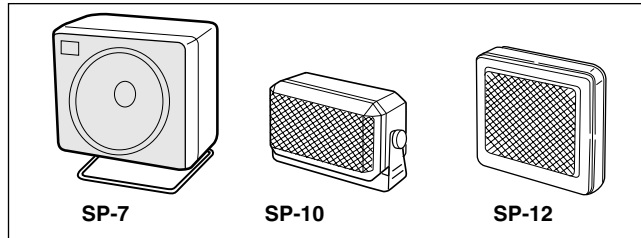

◇ Separation accessories

OPC-600/601 SEPARATION CABLE

For operation with the front panel detached.

Cable length

OPC-600: 3.5 m; 11.5 ft OPC-601: 7.0 m; 23.0 ft

MB-58 REMOTE CONTROLLER BRACKET

Mounts the remote controller in a convenient location for operation with the front panel detached from the main body.

MB-65 REMOTE CONTROLLER BRACKET

Mounts the remote controller with MB-58. Adjustable angle and direction for optimum installation positioning.

OPC-440/647 MIC EXTENSION CABLE

Cable length

OPC-440: 5.0 m; 16.4 ft OPC-647: 2.5 m; 8.2 ft.

OPC-347 DC POWER CABLE

Has a 20 A capacity and a length of 7.0 m (23.0 ft).

OPC-441 SPEAKER EXTENSION CABLE

Cable length: 5.0 m; 16.4 ft.

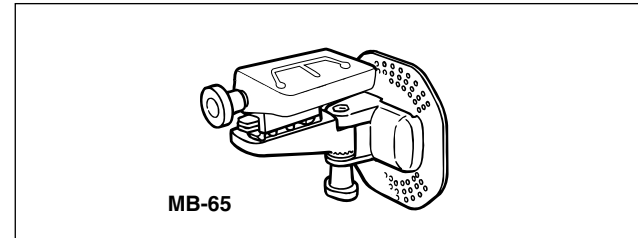

◇ **Wireless microphone accessories**

HM-90 WIRELESS MICROPHONE

Infrared, full remote control microphone. Wired remote control is also possible.

EX-1759 INFRARED RECEIVER

Used to receive control signals from the HM-90.

EX-1513 INFRARED SUB RECEIVER

Used with the EX-1759 to increase remote control reliability and extend the controllable area.

BC-96 MICROPHONE HOLDER

Holds the HM-90 body in a convenient place and supplies power to the charging circuit of the HM-90. Has a charging indicator.

CP-13/L CIGARETTE LIGHTER CABLE WITH NOISE FILTER

OPC-288/L DC POWER CABLE

Supply power to the BC-96 for charging the Ni-Cd battery inside the HM-90 when the BC-96 cannot be connected to the EX-1759 directly.

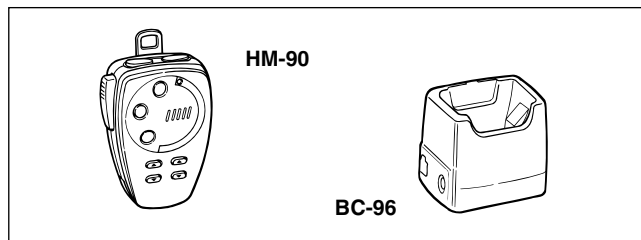

◇ **Internal units for function enhancements**

UT-49 DTMF DECODER UNIT

Provides pager and code squelch functions. Also provides an external DTMF function for the U.S.A. version only.

UT-104 TONE SQUELCH UNIT

Provides pocket beep, tone squelch and tone scan functions.

◇ **Others**

MB-17A MOBILE MOUNTING BRACKET

One-touch bracket. Transceiver body is easily attached and removed.

IC-PS30 DC POWER SUPPLY

Provides 13.8 V DC and 25 A max. for base station use.

CS-2710 CLONING SOFTWARE + OPC-646 CLONING CABLE

Provides quick and easy programming of items, including memory channels and set mode contents, for local repeater frequencies, etc.

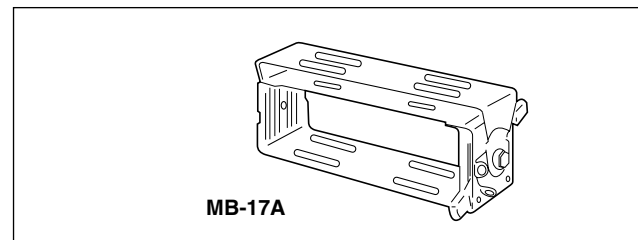

21 MODE ARRANGEMENT

Although the following chart refers mainly to the VHF band, the transceiver has the same mode arrangement in the UHF band.

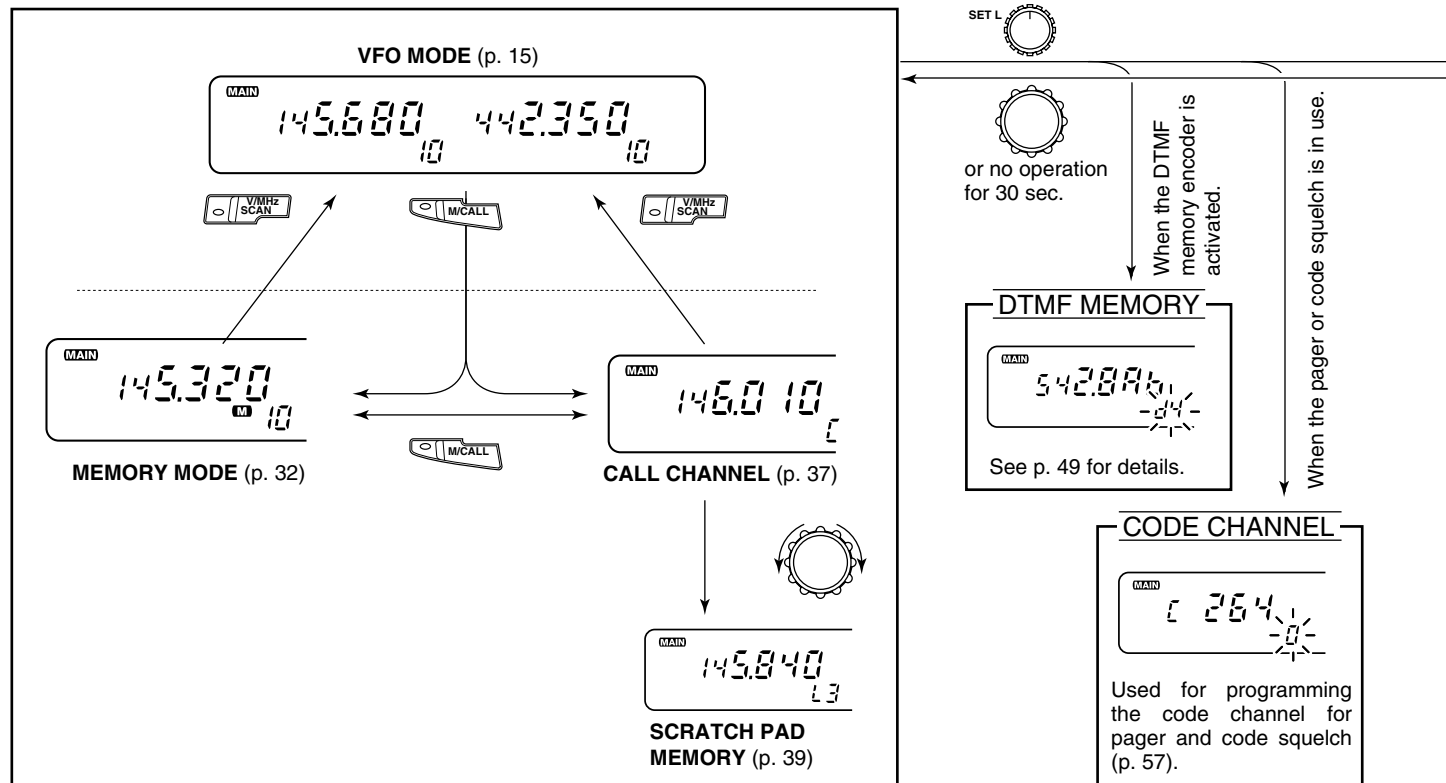

MODE ARRANGEMENT 21

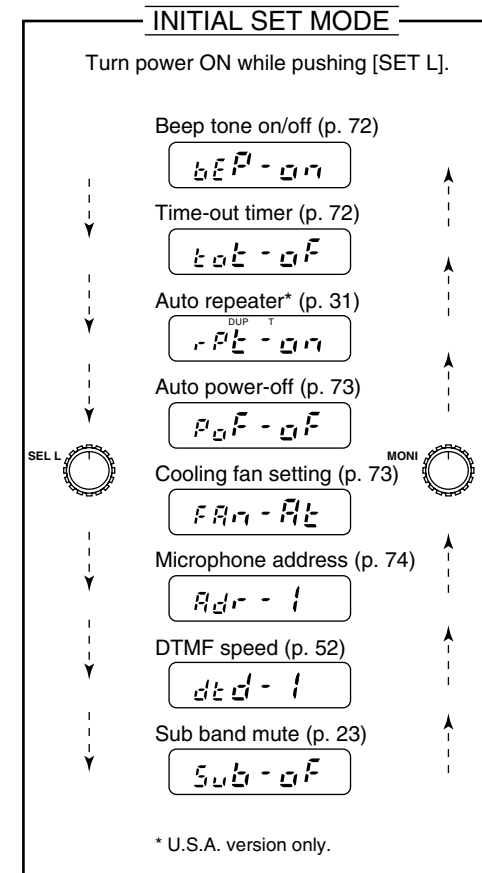
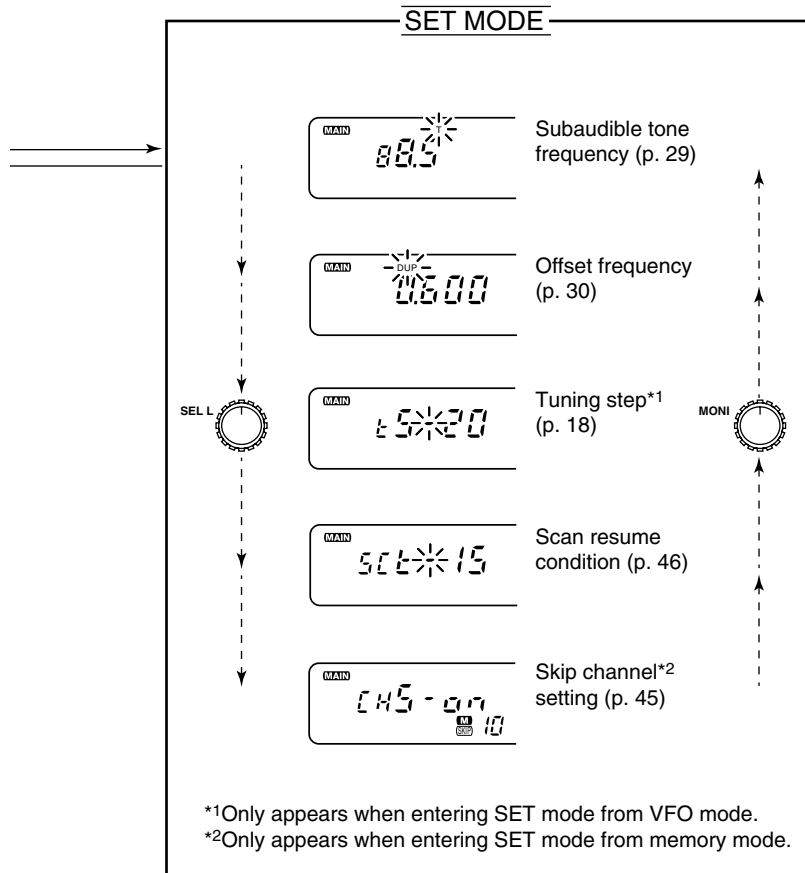

Count on us!



A-5382H-1EX
Printed in Japan
Copyright © 1996 by Icom Inc.

Icom Inc.
1-1-32 Kamiminami, Hirano-ku, Osaka 547-0003 Japan