

IC-28A/E

144MHz FM TRANSCEIVER

INSTRUCTION MANUAL



FOREWORD

Congratulations for choosing this technically-advanced ICOM product.

The IC-28A/E VHF FM transceiver is the latest addition to the ICOM system of Amateur radio equipment. Included in the IC-28A/E design is provision for use of the newly developed Digital Code Squelch method of communicating. Digital Code Squelch uses the latest digital techniques to create a communications system capable of dramatically reducing the inconvenience of heavily populated Amateur bands.

Use the IC-28A/E with the knowledge that this transceiver, and every ICOM product, is supported by a world-wide network of authorized service centers and dealers ready to provide assistance efficiently.

TABLE OF CONTENTS

SECTION	1	SPECIFICATIONS	1
SECTION	2	FEATURES	2
SECTION	3	CONTROL FUNCTIONS.....	3
SECTION	4	INSTALLATION	8
SECTION	5	OPERATION	13
SECTION	6	INSIDE VIEWS	24
SECTION	7	MAINTENANCE.....	25
SECTION	8	BLOCK DIAGRAM	27
SECTION	9	OPTIONS	28
SECTION	10	SCHEMATIC DIAGRAM.....	SEPARATE

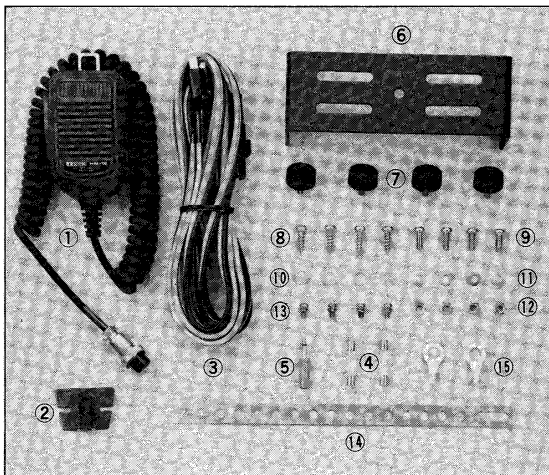

IC-28A/E ACCESSORIES SUPPLIED	QTY.
1.*Microphone	1
2.Microphone hanger	1
3.Power cable	1
4.Fuses (15A)	2
5.External speaker plug.	1
6.Mounting bracket	1
7.Mounting bracket knobs	4
8.Mounting screws (self-tapping)	4
9.Mounting screws	4
10.Flat washers (large)	4
11.Flat washers (small).	4
12.Nuts	4
13.Screws/spring washers	4
14.Support bracket.	1
15.Cable lugs	2
* IC-28A: HM-12	
IC-28E: HM-15	

SECTION 1 SPECIFICATIONS

1-1 GENERAL

Frequency coverage :

MODEL	GUARANTEED RANGE	OPERATIONAL RANGE	
	TRANSCEIVER	RECEIVER	TRANSMITTER
IC-28A	144.00 ~ 148.00	138.00 ~ 174.00	140.10 ~ 150.00
IC-28A Australia version	144.00 ~ 148.00	144.00 ~ 148.00	144.00 ~ 148.00
IC-28E	144.00 ~ 146.00	144.00 ~ 146.00	144.00 ~ 146.00
IC-28E Italy, Spain versions	144.00 ~ 148.00	140.00 ~ 150.00	140.00 ~ 150.00

Frequency resolution : IC-28A 5, 10, 15, 20 or 25kHz (programmable)

IC-28E 12.5 or 25kHz (programmable)

Frequency control : CPU based 5kHz (or 6.25kHz) step digital PLL synthesizer
Simplex and semi-duplex capability (programmable offset)

Memory channels : 21 channels

Usable temperature range : $-10^{\circ}\text{C} \sim +60^{\circ}\text{C}$ ($+14^{\circ}\text{F} \sim +140^{\circ}\text{F}$)

Power supply requirement : 13.8V DC $\pm 15\%$ (negative ground)
AC power supply is available for AC operation.

Current drain (at 13.8V DC) :

Transmit

HIGH (25W) Approx. 6.0A

LOW (5W) Approx. 3.0A

Receive

Max. audio output Approx. 800mA

Squelched Approx. 450mA

Antenna impedance : 50 ohms unbalanced

Dimensions : 140(140)mm(W) x 50(50)mm(H) x 133(148.5)mm(D)
Bracketed values include projections

Weight : 0.95kg

1-2 TRANSMITTER

Output power : HIGH 25W LOW 5W

Emission mode : 16K0F3E

Modulation system : Variable reactance frequency modulation

Max. frequency deviation : $\pm 5.0\text{kHz}$

Spurious emissions : More than 60dB below carrier

Microphone : 600 ohm electret condenser with push-to-talk and scanning switches
(IC-28E: 1750Hz tone burst switch)

1-3 RECEIVER

Receive system : Double-conversion superheterodyne

Modulation acceptance : 16K0F3E

Intermediate frequencies : 1st 17.2MHz 2nd 455kHz

Selectivity : More than 12.5kHz at -6dB

Less than 25.0kHz at -60dB

Sensitivity : Less than $0.18\mu\text{V}$ for 12dB SINAD

Audio output : More than 2.4 watts at 10% distortion with 8 ohm load

Audio output impedance : 4 ~ 8 ohms

SECTION 2 FEATURES

● COMPACT 144MHz MOBILE

Smaller than many conventional automobile broadcast band receivers, the sophisticated IC-28A/E transceiver provides 25 watts of output power on any frequency in the 2 meter band and contains an internal speaker as well.

● SIMPLE PANEL DESIGN

Front panel layout is extremely simple in spite of the great number of functions available. The total number of controls on the front panel is significantly fewer than other models currently available while, at the same time, new features have been added resulting in a mobile unit that is safe and easy to use while driving without sacrificing performance.

● HIGHLY VISIBLE LCD READOUT

The LCD front panel readout features a particularly wide viewing angle designed to enable the driver to easily see the display, even in bright daylight, without changing position.

● AUTOMATIC DIMMER CIRCUIT

Variations in ambient light conditions pose no problems when using the IC-28A/E since the built-in light sensor automatically adjusts a dimmer circuit to control the backlighting of the display to suit the time of day or night that you are operating. This feature is particularly convenient for night operation to reduce eye fatigue caused by overly bright displays.

● 21 MEMORY CHANNELS

The IC-28A/E introduces a large capacity memory with 21 fully programmable memory channels. These memory channels place a variety of communications functions at the fingertips of the driver.

● DUAL SCANNING FUNCTIONS

● FREQUENCY SCAN:

The entire band is searched continuously with frequency increments specified by the operator.

● MEMORY SCAN:

All memory channels are continuously checked.

● SUBAUDIBLE TONE ENCODER STANDARD

With 38 different subaudible tones standard on the IC-28A (U.S.A. version), maximum communications coverage is assured by allowing full access to all your local repeaters.

● SQUELCH OPTIONS

Two new optional units specially designed for the IC-28A/E are ideal for handling the crowded band conditions found on 2 meters in many locations. Either the UT-28 or the UT-29 may be installed.

● UT-28 DIGITAL CODE SQUELCH UNIT:

Incorporating a system of digital coding and decoding, the UT-28 option allows a "personalized" squelch to be programmed using 1 of 100,000 different code numbers.

● UT-29 TONE SQUELCH UNIT:

The UT-29 is a subaudible tone encoder/decoder which may be installed as an alternative to the UT-28 Digital Code Squelch Unit.

SECTION 3 CONTROL FUNCTIONS

3-1 FRONT PANEL

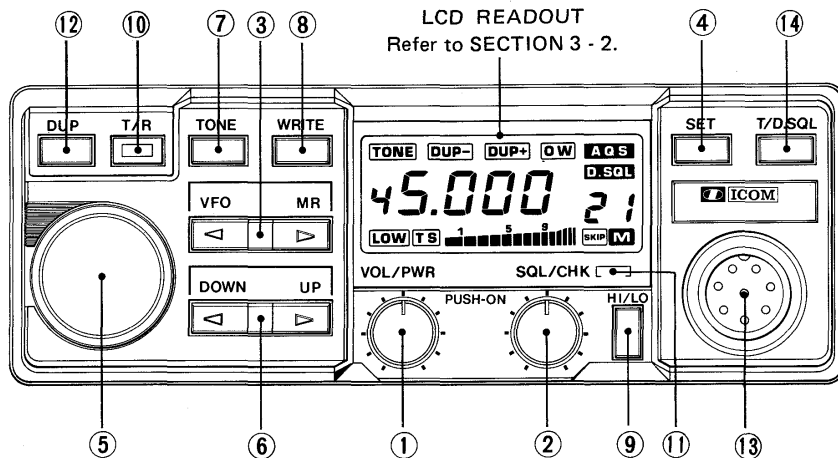

① VOLUME CONTROL/POWER SWITCH [VOL/PWR]

Push this control to turn the power ON and OFF. Turn the control clockwise to increase the audio level. Refer to SECTION 5 - 1 RECEIVING.

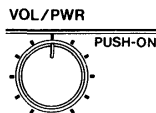

② SQUELCH CONTROL/CHECK SWITCH [SQL/CHK]

The squelch circuit quiets the noise from the receiver while no signals are being received. While monitoring a vacant channel, turn the control clockwise until the green T/R LED goes out. Refer to SECTION 5 - 1 RECEIVING.

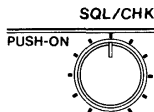

A second function of this control is to allow the operator to monitor the transmit frequency when the duplex mode is selected. Push the control to use the CHECK function. The receive frequency is restored when the control is released. Refer to SECTION 5 - 4 DUPLEX PROGRAMMING.

③ VFO/MEMORY READ SWITCH [VFO/MR]

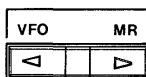

Push to select either the VFO mode or the MEMORY mode of operation. When the MEMORY mode is selected, the letter "M" appears under the memory channel number on the LCD readout. Refer to SECTIONS 5 - 1 RECEIVING and 5 - 2 MEMORY READING.

④ SET SWITCH



This is a multi-function switch which operates in different ways depending on which mode is currently selected with the IC-28A/E.

In the VFO mode, the SET SWITCH permits programming of the subaudible tone encoder on the IC-28A (U.S.A. version), the transmit offset frequency and the tuning step size of the TUNING CONTROL. Refer to SECTIONS 5 - 4 SUBAUDIBLE TONE ENCODER and DUPLEX PROGRAMMING, and 5 - 1 RECEIVING.

In the MEMORY mode, the SET SWITCH controls the skip function. The skip function allows memory channels to be deleted from the normal scanning sequence when memories are being scanned. Refer to SECTION 5 - 3 MEMORY CHANNEL SCANNING.

⑤ TUNING CONTROL

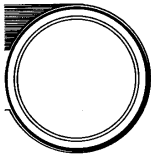

The function of this control is affected by the mode of operation being used.

In the VFO mode, turn clockwise to increase the operating frequency and counterclockwise to decrease it. After pushing the SET SWITCH, the TUNING CONTROL is used to select the subaudible tone number on the IC-28A (U.S.A. version), to set the amount of transmit offset when using the duplex mode and to select the tuning step size for frequency changes with the TUNING CONTROL. Refer to SECTIONS 5 - 4 SUBAUDIBLE TONE ENCODER and DUPLEX PROGRAMMING, and 5 - 1 RECEIVING.

In the MEMORY mode, turn clockwise to increase the selected memory channel and counterclockwise to decrease it. Refer to SECTION 5 - 2 MEMORY READING.

⑥ DOWN/UP SWITCH

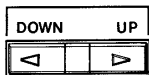

This switch operates differently depending on the setting of the VFO/MR SWITCH.

In the VFO mode, push to change the selected operating frequency in 1MHz increments. In the MEMORY mode, push to change the selected memory channel in one channel increments. Refer to SECTIONS 5 - 1 RECEIVING and 5 - 2 MEMORY READING.

**⑦ TONE SWITCH
(IC-28A U.S.A. version)**



The name and function of this switch varies depending on the version of transceiver.

• TONE SWITCH:

Push to turn ON and OFF the subaudible tone encoder when using the duplex mode. The word "TONE" appears when the tone encoder is turned ON. Refer to SECTION 5 - 4 SUBAUDIBLE TONE ENCODER.

**CALL SWITCH
(except U.S.A. version)**



• CALL SWITCH:

Push to select the call channel which has been programmed in memory channel 21. The letter "C" appears in place of the memory channel number when the call function is activated. Refer to SECTION 5 - 5 CALL CHANNEL FUNCTION.

⑧ WRITE SWITCH



This switch works differently depending on the setting of the VFO/MR SWITCH.

In the VFO mode, push to store the displayed frequency on the LCD readout in the memory channel represented by the memory channel number also displayed. Refer to SECTION 5 - 2 MEMORY PROGRAMMING.

In the MEMORY mode, push to transfer the displayed frequency, which is the contents of the selected memory channel, to the VFO. After the transfer, the IC-28A/E changes to the VFO mode. Refer to SECTION 5 - 2 MEMORY CHANNEL TO VFO TRANSFERS.

⑨ HIGH/LOW SWITCH [HI/LO]



Push to change between the HIGH (25W) and LOW (5W) transmit output power. The word "LOW" appears when LOW power is selected.

⑩ TRANSMIT/RECEIVE INDICATOR [T/R]



This two-color LED indicates whether the IC-28A/E is in the transmit or receive mode. The LED is red while transmitting and green while receiving with the squelch circuit open. The indicator is OFF when the squelch circuit is closed and the receiver is muted.

⑪ DISPLAY DIMMER SENSOR

This sensor measures the ambient light and controls the display dimmer circuit which varies the intensity of the LCD backlighting.

⑫ DUPLEX SWITCH [DUP]



Push to select simplex or duplex operation:

- The transmit frequency is LOWER than the receive frequency by 600kHz or by the programmed offset amount when "DUP-" appears on the display.
- The transmit frequency is HIGHER than the receive frequency by 600kHz or by the programmed offset amount when "DUP+" appears on the display.
- When neither "DUP-" nor "DUP+" appear on the display, the IC-28A/E is in the simplex mode. The transmit and receive frequencies are equal at this time.

Refer to SECTION 5 - 4 DUPLEX MODE.

⑬ MIC CONNECTOR

Connect the supplied microphone to this connector. Refer to SECTIONS 4 - 1 MOBILE INSTALLATION, 4 - 2 FIXED INSTALLATION and 5 - 6 MICROPHONE.

FRONT VIEW

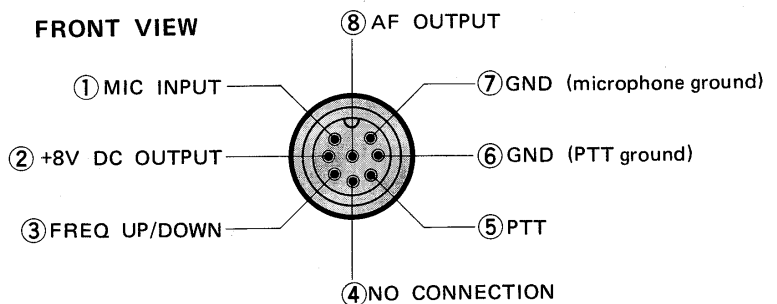

⑭ TONE SQUELCH SWITCH DIGITAL SQUELCH SWITCH [T/D.SQL]



This switch turns ON and OFF the optional squelch systems:

- TONE SQUELCH SYSTEM
When activated, "TONE" and "D.SQL" appear on the display. Push the SET SWITCH in order to program the desired subaudible tone numbers. Refer to SECTION 5 - 9 OPTIONAL UNITS.
- DIGITAL CODE SQUELCH SYSTEM
When activated, "D.SQL" appears on the display. Push the SET SWITCH in order to program the desired group code. Refer to SECTION 5 - 9 OPTIONAL UNITS.

This switch has no function when neither option is installed.

3-2 LCD READOUT

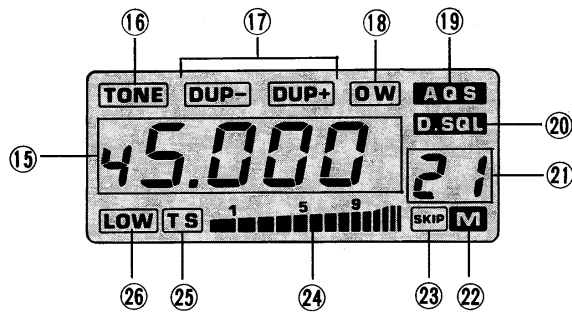

⑮ FREQUENCY

The operating frequency is displayed with digits representing the 10MHz, 1MHz, 100kHz, 10kHz and 1kHz positions. Additionally, the IC-28E displays the 100Hz digit.

The decimal point on the display flashes during scanning operations. Also, the subaudible tone number, the transmit offset, the tuning step size, and the group code for the optional digital code squelch are displayed on the LCD readout.

⑮ SUBAUDIBLE TONE INDICATOR

Appears when the subaudible tone encoder is activated. Also, appears when the optional UT-29 Tone Squelch unit is activated. Refer to SECTIONS 5 - 4 SUBAUDIBLE TONE ENCODER and 5 - 9 OPTIONAL UNITS.

⑮ DUPLEX MODE INDICATORS [DUP-, DUP+]

Appear while the IC-28A/E is being operated in the duplex mode (transmit frequency different from the receive frequency). Both indicators disappear while operating in the simplex mode. Refer to SECTION 5 - 4 DUPLEX PROGRAMMING.

⑮ OFFSET WRITE INDICATOR [OW]

Flashes when the IC-28A/E is ready to have the transmit offset programmed for duplex operation. Refer to SECTION 5 - 4 DUPLEX PROGRAMMING.

⑮ GROUP CODE INDICATOR [AQS]

Flashes when the IC-28A/E is ready to have the group code programmed when using the optional UT-28 Digital Code Squelch unit. Refer to SECTION 5 - 9 OPTIONAL UNITS.

⑮ SQUELCH SYSTEM INDICATOR [D.SQL]

Appears when either the optional tone squelch or optional digital code squelch system is activated. Flashes with the TONE INDICATOR when the IC-28A/E is ready to have the subaudible tone number for the tone squelch programmed. Refer to SECTION 5 - 9 OPTIONAL UNITS.

⑮ MEMORY CHANNEL NUMBER

This area displays various symbols:

- Selected memory channels "1" to "21".
- Offset programming symbol "F" or "P"
- Call channel function "C":
IC-28A/E except U.S.A. version
- Subaudible tone encoder memory number "1", "2" or "3":
IC-28A/E U.S.A. version

②② MEMORY MODE INDICATOR [M]

Appears when the MEMORY mode is selected with the VFO/MR SWITCH. Refer to SECTION 5 - 2 MEMORY READING.

②③ MEMORY CHANNEL SKIP INDICATOR [SKIP]

Appears when a particular memory channel has been programmed with the SET SWITCH to be excluded from the memory scan operation. Refer to SECTION 5 - 3 MEMORY SKIP FUNCTION.

②④ S/R/F INDICATOR

In the receive mode, this indicator operates as an S-meter showing the receive signal level. In the transmit mode, the relative output power of the transmitter is indicated:

- LOW power: 5 segments appear
- HIGH power: All segments appear

②⑤ TUNING STEP INDICATOR [TS]

Flashes when the IC-28A/E is ready for programming of the VFO step size. Use the TUNING CONTROL to select the desired step size. Refer to SECTION 5 - 1 SELECTING A FREQUENCY.

②⑥ OUTPUT POWER INDICATOR [LOW]

Appears when the transmitter LOW power is selected with the HI/LO SWITCH. The indicator does not appear when the transmitter HIGH power is used. Refer to SECTION 5 - 1 SELECTING OUTPUT POWER.

3 - 3 REAR PANEL

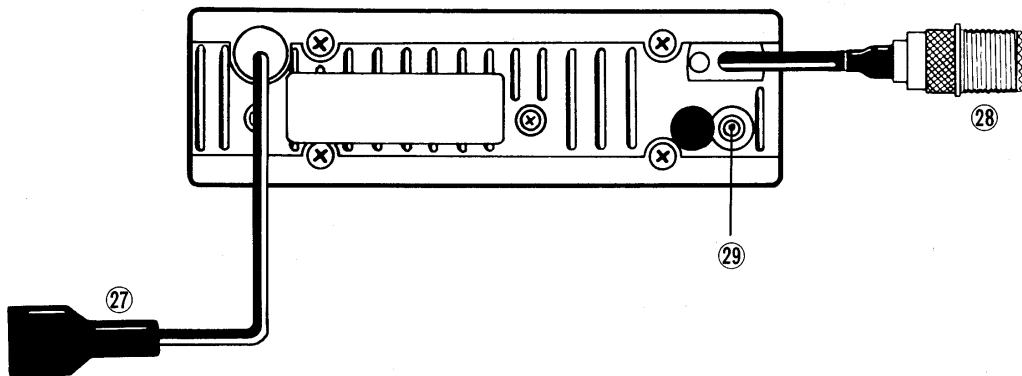

②⑦ POWER CONNECTOR

Connect 13.8V DC $\pm 15\%$ from a stable power source to this connector. Refer to SECTION 4 INSTALLATION.

②⑧ ANTENNA CONNECTOR

Connect a 50 ohm antenna with a PL-259 connector on the feedline to this connector. Refer to SECTION 4 INSTALLATION.

②⑨ EXTERNAL SPEAKER JACK

Connect a 4 ~ 8 ohm speaker to this jack, if required. Connecting the external speaker automatically disconnects the internal speaker. Refer to SECTION 4 INSTALLATION.

SECTION 4 INSTALLATION

4-1 MOBILE INSTALLATION

■ LOCATION

Where you place the IC-28A/E in your vehicle is not critical. The location should be accessible and convenient to reach from the driver's seat. There are numerous mounting possibilities since the transceiver is so compact. In general, the mounting bracket provides a guide for the installation location.

Keep the following items in mind when planning the mounting location:

- Avoid locations where hot or cold air can blow directly on the unit or where there are large temperature variations.
- Avoid mounting the transceiver where it will hinder the normal operation of the vehicle.
- Securely mount the transceiver with the supplied bracket to minimize vibration.

■ INSTALLATION

The installation angle of the IC-28A/E can be varied by approximately 18 degrees. Adjust the angle for the clearest view from the operating position.

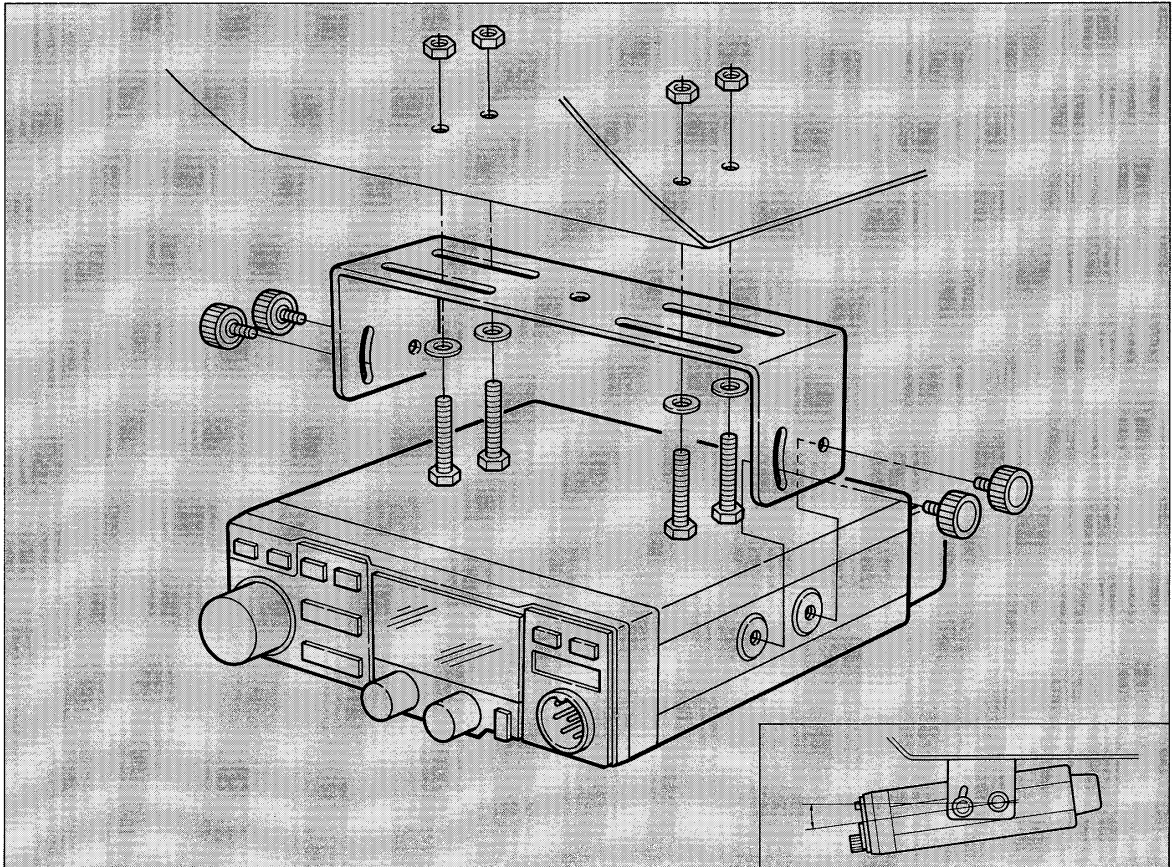

■ CONNECTIONS

Connect the unit directly to a 12V battery using the supplied power cable. Note the polarity of the connections:

- RED cable : POSITIVE (+) terminal
- BLACK cable: NEGATIVE (-) terminal

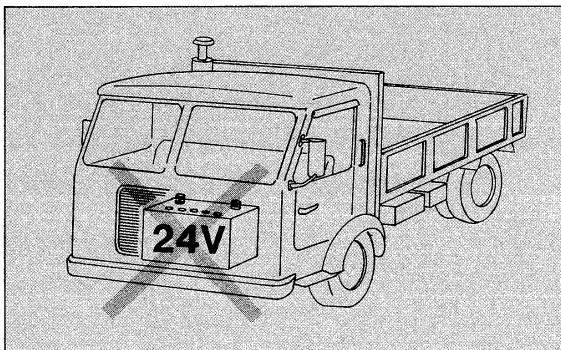
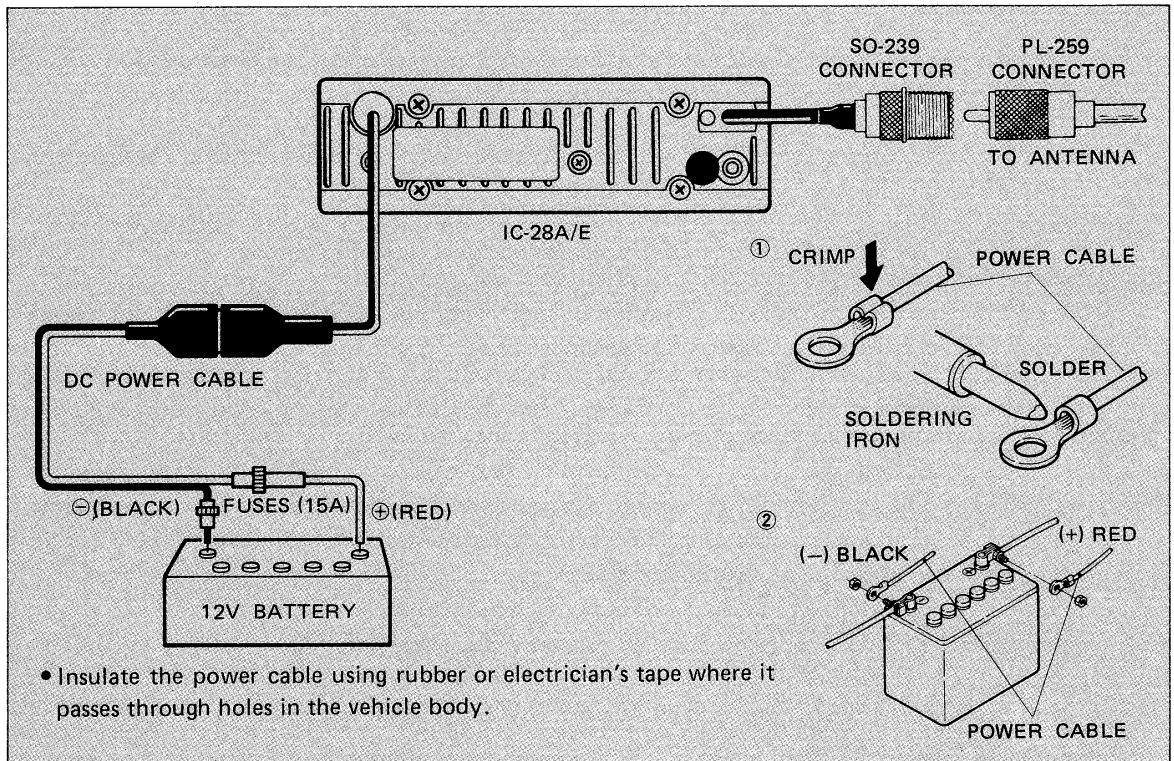

- The IC-28A/E cannot be connected directly to a 24V battery.

- Do not use the cigarette lighter for a power connection.

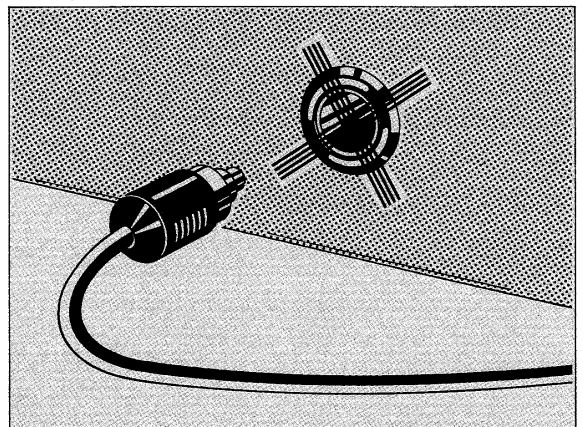

■ ANTENNA

Transceiver performance largely depends on the quality of the antenna used. Select a high-quality antenna and use it as recommended by the manufacturer.

■ COAXIAL CABLE

Use large diameter 50 ohm coaxial cable. The added efficiency of the larger cable is important in the VHF spectrum to reduce cable loss.

■ ANTENNA LOCATIONS

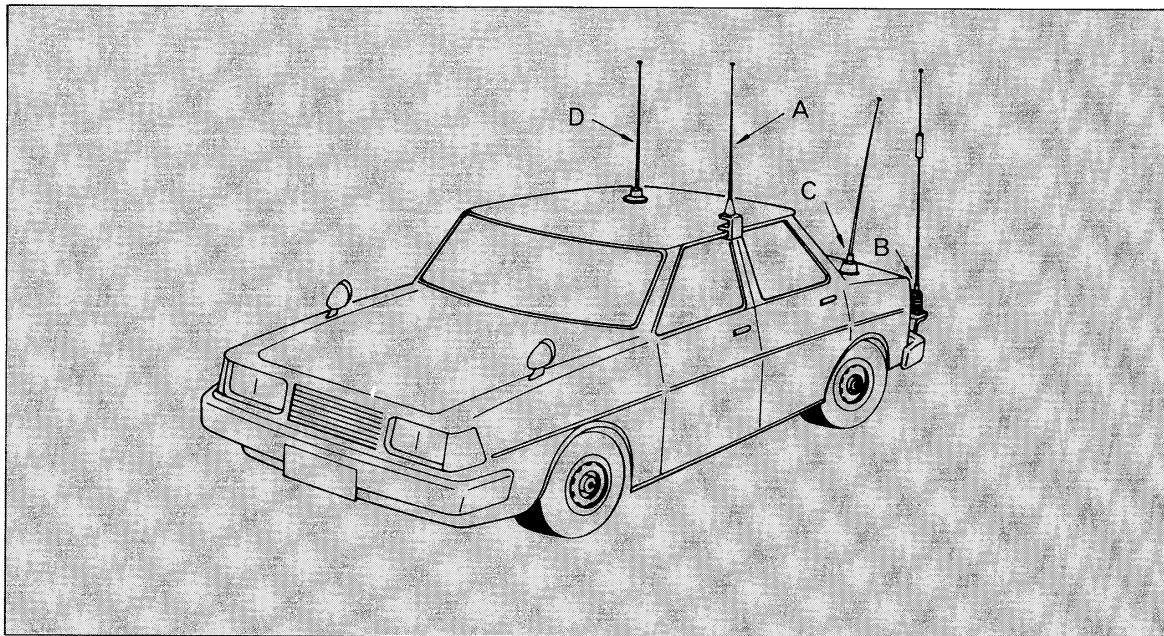

- A: Gutter-mount antenna
- B: Bumper-mount antenna
 - Best location for longer antennas.
- C: Trunk-mount antenna
- D: Roof-mount antenna
 - Best location for a good radiation pattern.
 - Drill a hole in the roof, or use a magnetic antenna base.

■ MICROPHONE

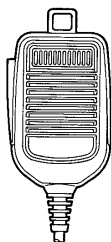

A high-quality electret condenser microphone is supplied with the IC-28A/E. Plug it directly into the jack on the front panel of the transceiver.

Optional microphones are available for mobile use with the IC-28A/E.

- IC-HM14: DTMF Microphone
- IC-HM16: Speaker-microphone (IC-28A)
- IC-HM17: Speaker-microphone (IC-28E)
- HS-15 : Flexible Mobile Microphone
- HS-15SB: Switch Box for HS-15 Microphone

■ EXTERNAL SPEAKER

An external speaker plug is supplied with the IC-28A/E for use with an optional external speaker if you feel you require one. The external speaker impedance should be 4 ~ 8 ohms. The internal speaker is disconnected when the external speaker is connected.

The SP-10 speaker is recommended for mobile use with the IC-28A/E.

4-2 FIXED INSTALLATION

■ CONNECTIONS

A stable AC power supply with a protective circuit is required for base station use. Battery-operated power supplies are not suitable.

The PS-45 AC Power Supply with the OPC-102 interface cable are recommended options.

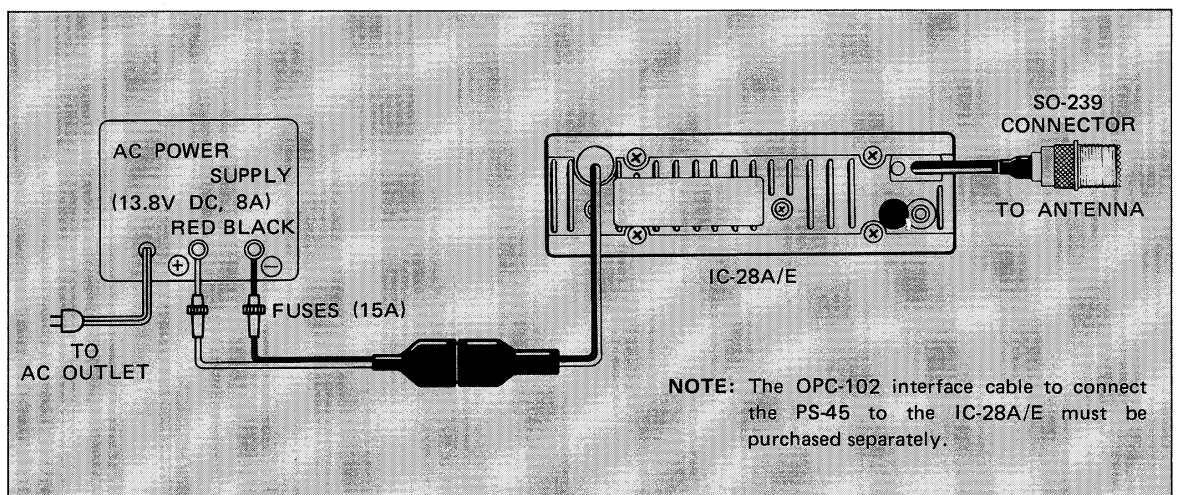

■ ANTENNA

Antenna performance is crucial for reliable radio communications. For this reason, a 50 ohm directional antenna is well worth the extra investment. A tremendous variety of fixed location antennas are available from various manufacturers. Choose one most suited for your needs.

■ COAXIAL CABLE

Particularly in a fixed location installation where feedline lengths are often longer than in a mobile installation, it is best to use coaxial cable with the lowest loss available.

At 144MHz, a 50 foot length of military grade RG-58C causes a loss of approximately 14 watts due to cable loss when using the IC-28A/E. An equal length of military grade RG-8A causes only approximately 6 watts loss due to cable loss. Therefore, simply by using a better quality cable, the power reaching the antenna will be about 19 watts instead of 11 watts.

■ INSTALLING PL-259 CONNECTORS

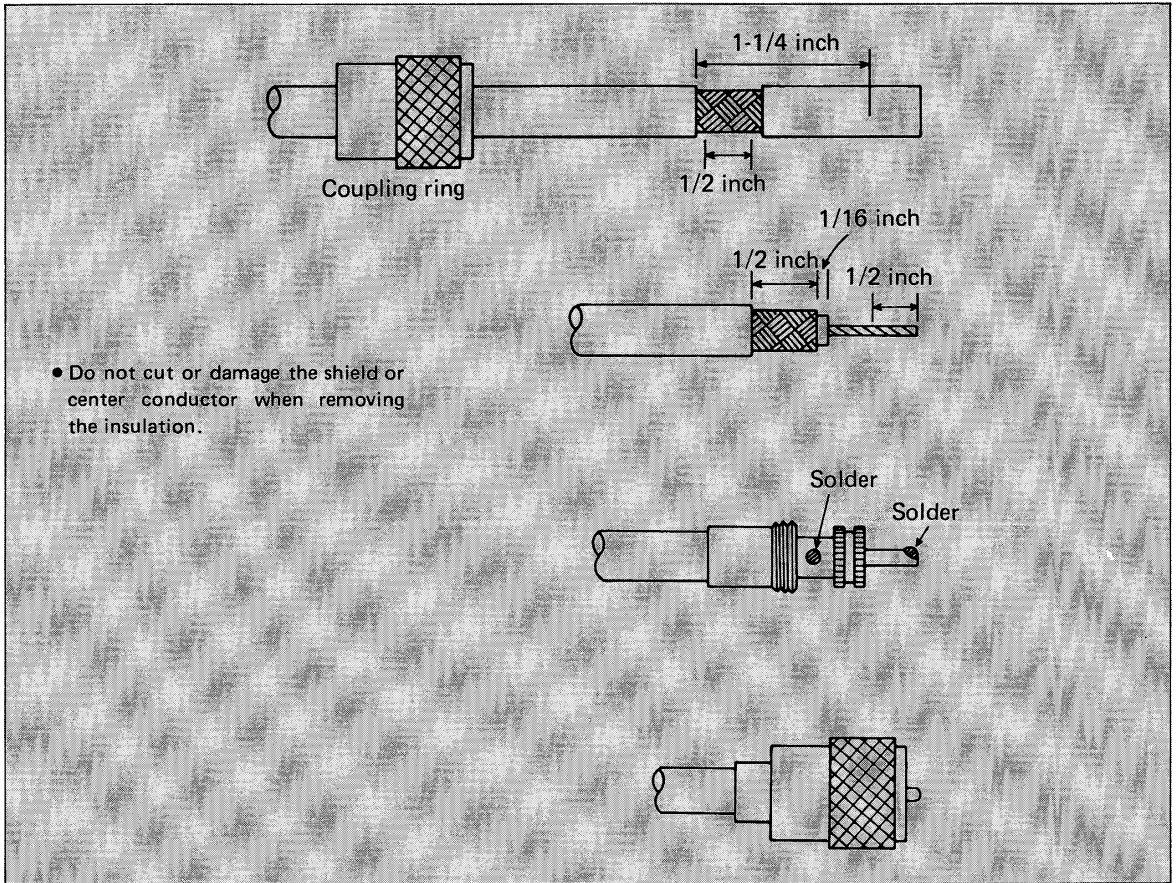

- 1) Slide the coupling ring over the coaxial cable.
- 2) Strip the cable as in the figure, and tin about 1/2" (13mm) of the shield conductor.
- 3) Remove the outer plastic casing and strip the center conductor insulation as in the figure. Tin the center conductor.
- 4) Slide the connector body onto the cable and solder.
- 5) Screw the coupling ring onto the connector body.

■ MICROPHONE

In addition to the microphones suggested in SECTION 4 - 1 MICROPHONE, also useful for base operation are the following:

- SM-8 : Desk Microphone
- SM-10: Compressor/Graphic Equalizer Microphone

■ EXTERNAL SPEAKER

In addition to the SP-10 mentioned in SECTION 4 - 1 EXTERNAL SPEAKER, the SP-7 Base Speaker is another optional speaker which is best for operation from a fixed location.

SECTION 5 OPERATION

5-1 BASIC OPERATION

■ RECEIVING

CONTROL	INITIAL SETTINGS
VOL/PWR	COUNTERCLOCKWISE
SQL/CHK	COUNTERCLOCKWISE

1) Push VOL/PWR CONTROL.

1) Push the VOL/PWR CONTROL to turn ON the power.

- The green T/R INDICATOR lights and the LCD READOUT displays the frequency and memory channel number last used.
- If the MEMORY mode was being used immediately prior to turning off the power to the IC-28A/E, the MEMORY mode is retained and the last used memory channel number and contents of that memory appear.

2) Adjust volume level.

2) Turn the VOL/PWR CONTROL clockwise until an adequate sound level is obtained.

3) Adjust squelch level.

3) Slowly turn the SQL/CHK CONTROL clockwise until the received noise is quieted.

- Perform this setting only on a vacant frequency (no received signal).
- The green T/R INDICATOR goes out.
- Setting the squelch in this manner mutes all sound from the speaker until a signal is received. On receiving a signal, it opens the squelch circuit and the signal is audible.
- Do not advance the SQL/CHK CONTROL beyond the point where the green T/R INDICATOR goes out or weak signals will not be heard.

4) Select operating frequency.

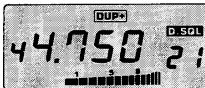

A strong signal being received at 144.750MHz. The duplex mode and optional digital code squelch are activated.

4) Select the desired operating frequency by using either the TUNING CONTROL, or the UP or DN SWITCH on the microphone.

- If the letter "M" appears on the display below the memory channel number, push the VFO side of the VFO/MR SWITCH to clear the MEMORY mode.
- When a signal is received, the green T/R INDICATOR lights, the S/RF INDICATOR displays the signal strength and the audio is heard from the speaker.

● SELECTING A FREQUENCY

Select the VFO mode by using the VFO/MR SWITCH. Select your desired frequency by the following procedure.

Ⓐ USING THE TUNING CONTROL

1) Use DOWN/UP SWITCH to set correct MHz digit.

1) Use the DOWN/UP SWITCH on the front panel to select the correct MHz range.

- Each time this switch is pushed, the frequency changes by 1MHz down or up.

- 2) Set tuning step size with SET SWITCH and TUNING CONTROL.

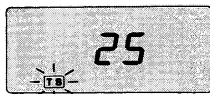

- 3) Select VFO mode.

- 4) Select frequency with TUNING CONTROL.

- 2) Push the SET SWITCH repeatedly until the TS INDICATOR appears flashing on the display.
 - The currently programmed tuning step size also appears:
 - IC-28A: 5, 10, 15, 20 or 25kHz
 - IC-28E: 12.5 or 25kHz
 - To change the tuning step size, turn the TUNING CONTROL until the desired step size appears.

- 3) Push the VFO side of the VFO/MR SWITCH to select the VFO mode.

- 4) Use the TUNING CONTROL to select the exact frequency desired.
 - As the TUNING CONTROL is turned, the frequency changes in increments as set in step 2).

Ⓑ USING THE MICROPHONE

- 1) Select correct MHz range and set tuning step size.

- 2) Push UP or DN SWITCH on microphone.

NOTE: The microphone SCAN SWITCH must be ON.

- 1) Follow steps 1) through 3) under Ⓐ USING THE TUNING CONTROL.

- 2) Push the UP SWITCH or DN SWITCH on the microphone until the correct frequency appears on the display.
 - Each time the UP SWITCH or DN SWITCH is pushed, the frequency changes by one increment.
 - If these switches are held down for longer than about 1/2 second, the frequency scan function begins. Refer to SECTION 5 - 3 FREQUENCY SCANNING.

■ TRANSMITTING

- 1) Push PTT SWITCH on microphone.

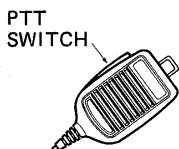

- 2) Speak into microphone.

- 3) Release PTT SWITCH.

Before transmitting, ensure your transmit frequency is not being used by other stations.

- 1) Push and hold the PTT SWITCH on the microphone to activate the transmitter.
 - The red T/R INDICATOR lights and the S/RF INDICATOR shows the relative output power of the transmitter.

- 2) Speak into the microphone using your normal voice level.
 - Do not hold the microphone too closely to your mouth or speak too loudly. This may cause a distorted signal.

- 3) Release the PTT SWITCH to stop transmitting.
 - The red T/R INDICATOR goes out.
 - The receive mode is restored.

● SELECTING OUTPUT POWER

NOTE: When using HIGH power, the IC-28A/E may become warm. This is normal.

Push the HI/LO SWITCH to alternately change between the HIGH or LOW transmit power.

- When the LOW power is selected, the LOW INDICATOR appears on the display.
- HIGH POWER: 25W LOW POWER: 5W

5 - 2 MEMORY MODE

■ MEMORY READING

- Select MEMORY mode.

Ⓐ USING THE TUNING CONTROL

Ⓑ USING THE DOWN/UP SWITCH

Ⓒ USING THE MICROPHONE

NOTE: The microphone SCAN SWITCH must be ON.

■ MEMORY PROGRAMMING

Example: Store 144.950MHz in memory channel 10.

- 1) Select memory channel 10.

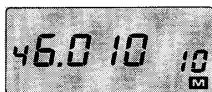

- 2) Select VFO mode.

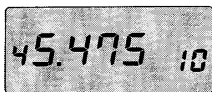

- 3) Select 144.950MHz.

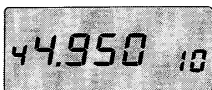

Memory channels 1 through 21 are useful for storing often-used frequencies. On all versions of the IC-28A/E except the U.S.A. version, channel 21 is reserved for the call function frequency. Refer to SECTION 5 - 5 CALL CHANNEL FUNCTION.

Push the MR side of the VFO/MR SWITCH to select the MEMORY mode.

- The letter "M" appears below the small memory channel number on the right side of the display to indicate the MEMORY mode is selected.

Turn the TUNING CONTROL clockwise or counterclockwise to select the desired memory channel.

- The selected memory channel number and contents of the memory appear on the display.
- This method is useful when a specific memory channel is desired.

Push the DOWN or UP side of the front panel DOWN/UP SWITCH to individually step through the memory channels.

- Each memory channel number and contents of its memory appear on the display as the IC-28A/E steps through the memory channels.
- This method is useful when wishing to slowly check several or all of the programmed memory channels.

Push the UP SWITCH or DN SWITCH on the microphone to step through the memory channels.

- Each memory channel number and contents of its memory appear on the display.
- This method is useful to monitor all channels since holding these switches down for longer than about 1/2 second causes the memory scan function to begin. Refer to SECTION 5 - 3 MEMORY CHANNEL SCANNING.

Use the following procedure to store operating frequencies plus duplex and memory skip information in memory channels. The duplex and memory skip functions are described in later sections.

- 1) Select the memory channel to be programmed by using the MEMORY READING procedure described above.

- 2) Push the VFO side of the VFO/MR SWITCH.

- 3) While in the VFO mode, select the information you wish to write into a memory channel:

- a) operating frequency (SECTION 5 - 1)
- b) duplex and subaudible tone programming (SECTION 5 - 4)
- c) memory skip programming (SECTION 5 - 3)

- 4) Push WRITE SWITCH.
Select MEMORY mode.

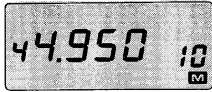

■ MEMORY CHANNEL TO VFO TRANSFERS

Example: Transfer the contents of memory channel 15 to the VFO.

- 1) Select memory channel 15.

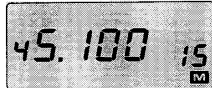

- 2) Push and hold WRITE SWITCH.

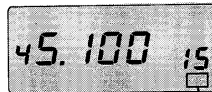

"M" disappears

5 - 3 SCAN FUNCTIONS

■ FREQUENCY SCANNING

- 1) Select VFO mode.
2) Push and hold UP SWITCH or DN SWITCH to start scan.

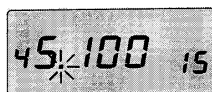

NOTE: The microphone SCAN SWITCH must be ON.

- 4) Push and hold the WRITE SWITCH for about 1/2 second.
- The 3 short tones indicate that the information selected in step 3) is now stored in the memory channel. Do not release the WRITE SWITCH until the 3 tones are heard.
 - Push the MR side of the VFO/MR SWITCH to confirm the memory channel has the correct information stored.

At times it may be desirable to transfer the contents of a memory channel to the VFO. Perform the following steps.

- 1) Select the memory channel containing the information to be transferred.
- Refer to the MEMORY READING section for information on selecting memory channels.
- 2) Push and hold the WRITE SWITCH for about 1/2 second.
- The 3 short tones indicate that the information contained in the memory channel has been transferred to the VFO. Do not release the WRITE SWITCH until the 3 tones are heard.
 - After the transfer is completed, the IC-28A/E changes to the VFO mode and the MEMORY mode "M" disappears from the display.
 - This transfer function does not affect the contents of the memory channel.

Both frequency and memory scanning on the IC-28A/E are controlled from the microphone. Before attempting to use either scan function, set the SQL/CHK CONTROL as below:

- SQL/CHK CONTROL: Speaker noise quieted
- T/R INDICATOR : OFF

When using the frequency scan, the entire frequency range is automatically searched by the IC-28A/E using the programmed size of frequency steps (SECTION 5 - 1 SELECTING A FREQUENCY). The receiver only stops on frequencies where a signal is present.

- 1) Push the VFO side of the VFO/MR SWITCH.
- 2) Push and hold the UP SWITCH or DN SWITCH on the microphone for about 1/2 second.
- The decimal point on the display begins to blink indicating the scan has started.
 - The receiver scans in ascending order if the UP SWITCH is pushed, or in descending order if the DN SWITCH is pushed. The frequency on the display changes to indicate each frequency checked as the scan progresses.
 - When a signal opens the receiver squelch circuit (i.e. the green T/R INDICATOR lights), the scan stops and the receiver monitors the signal. The scan begins again about 3 seconds after the frequency is clear of the signal, or about 15 seconds after the scan stops.

3) Push UP SWITCH or DN SWITCH to cancel scan.

■ MEMORY CHANNEL SCANNING

- 1) Select MEMORY mode.
- 2) Push UP or DN SWITCH to start and stop scan.

● MEMORY SKIP FUNCTION

- 1) Select MEMORY mode.
- 2) Select channel to be skipped.

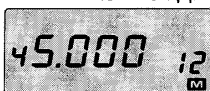

3) Push SET SWITCH.



"SKIP" appears

4) Push SET SWITCH to cancel skip function.



3) Push either the UP SWITCH or DN SWITCH on the microphone in order to cancel the scan function.

The memory channel scan is similar to the frequency scan except that all of the memory channels are checked repeatedly for signals.

- 1) Push the MR side of the VFO/MR SWITCH.
- 2) Follow steps 2) and 3) for FREQUENCY SCANNING.

Memory channels which are not required to be scanned may be eliminated from the memory channel scan by the following procedure.

- 1) Push the MR side of the VFO/MR SWITCH.
- 2) Select the channel which is not required in the memory channel scan.

- Refer to SECTION 5 - 2 MEMORY READING.

- 3) Push the SET SWITCH.
 - The SKIP INDICATOR appears on the display.
 - The selected channel will now be skipped when using the memory channel scan.

4) Push the SET SWITCH again to cancel the skip function on this channel.

NOTE: The memory channel scan will not operate if all memory channels are programmed to be skipped.

5 - 4 DUPLEX MODE

■ DUPLEX PROGRAMMING

Example: Program the following frequencies.

Receive : 144.75MHz
Transmit: 145.35MHz

1) Select the receive frequency.

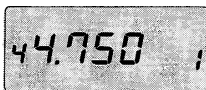

2) Push the SET SWITCH to select offset write mode.



The duplex mode allows operation with a transmit frequency which is different from the receive frequency. This is necessary when operating through repeaters. When the receive and transmit frequencies are identical, this is referred to as the simplex mode.

NOTE: Transmit offset refers to the frequency difference between the receive and transmit frequencies when using the duplex mode.

- 1) Push the VFO side of the VFO/MR SWITCH.
- 2) Push the SET SWITCH repeatedly until the OW INDICATOR appears flashing on the display.
 - The current transmit offset and the offset programming symbol ("F" or "P") also appear.

DISPLAYED SYMBOL	SYMBOL MEANING	OFFSET VALUE
F	FIXED Offset	600kHz
P	PROGRAMMABLE Offset	Variable (0 ~ 7.99MHz)

3) Select 600kHz transmit offset.

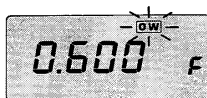

4) Select VFO mode.

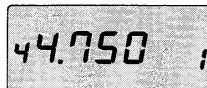

5) Push DUP SWITCH to select DUPLEX (+).

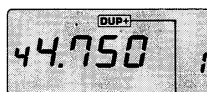

"DUP+" appears

6) Push SQL/CHK CONTROL to check transmit frequency.



3) Push the front panel DOWN/UP SWITCH to select one of the two methods for programming the transmit offset.

- The usual position is "F" since most repeaters operate with a 600kHz split between the receive and transmit frequencies.
- If the "P" position is selected, use the TUNING CONTROL to choose your required transmit offset value.

4) Push the VFO side of the VFO/MR SWITCH.

5) Push the DUP SWITCH to select either the DUPLEX (-) or DUPLEX (+) condition.

- DUP (-): The transmit frequency is lower than the receive frequency by the offset amount.
- DUP (+): The transmit frequency is higher than the receive frequency by the offset amount.
- Neither DUP (-) nor DUP (+) displayed:
The IC-28A/E is in the simplex mode with both receive and transmit frequencies equal.

6) Push the SQL/CHK CONTROL in order to monitor the transmit frequency when operating with the duplex mode.

- This allows checking of the signal strength of your contacted station directly without going through a repeater. If the signal is received strongly enough directly, both stations should move to a simplex frequency.

■ **SUBAUDIBLE TONE ENCODER**
(IC-28A U.S.A. version)

The supplied tone encoder allows access to repeaters which require a subaudible tone superimposed on the transmit signal in order to open the squelch circuit of the receiver at the repeater station. Without this tone being present, the repeater cannot be used.

● **PROGRAMMING THE SUBAUDIBLE TONE ENCODER**

Example: Program 88.5Hz in subaudible tone memory 3.

1) Select VFO mode.

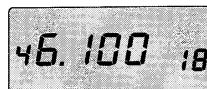

2) Push SET SWITCH to select subaudible tone programming mode.

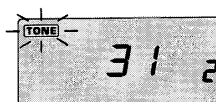

1) Push the VFO side of the VFO/MR SWITCH.

2) Push the SET SWITCH repeatedly until the TONE INDICATOR appears flashing on the display.

NOTE: In this mode, the IC-28A can store a total of three tone numbers in the three tone memories. The tone memories are named "1", "2" and "3" and are designated with small numbers on the right side of the display.

3) Push DOWN/UP SWITCH to select tone memory 3.

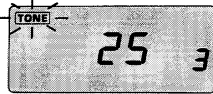

4) Turn TUNING CONTROL to select tone number 08 (88.5Hz).

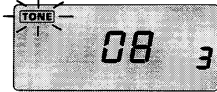

5) Select the VFO mode.

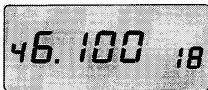

6) Select the duplex mode.

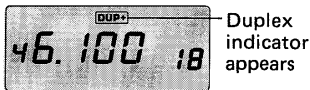

7) Activate tone encoder.

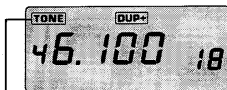

"TONE" appears

3) Push the front panel DOWN/UP SWITCH to select one of the tone memories.

4) Use the TUNING CONTROL to select a subaudible tone number.
 • Refer to the SUBAUDIBLE TONE FREQUENCY CHART to determine the number to select for your required tone frequency.

5) Push the VFO side of the VFO/MR SWITCH.

6) Push the DUP SWITCH to select DUPLEX (-) or DUPLEX (+).

7) Push the TONE SWITCH to turn the subaudible tone encoder ON or OFF.

- The TONE INDICATOR appears when the tone encoder is activated.
- The subaudible tone will be transmitted each time a transmission is made.
- The tone encoder does not function when the simplex mode is used.

•SUBAUDIBLE TONE ENCODER FREQUENCY CHART
 (For using IC-28A U.S.A. version with repeaters)

TONE NUMBER	FREQUENCY (Hz)	TONE NUMBER	FREQUENCY (Hz)	TONE NUMBER	FREQUENCY (Hz)
01	67.0	15	110.9	29	179.9
02	71.9	16	114.8	30	186.2
03	74.4	17	118.8	31	192.8
04	77.0	18	123.0	32	203.5
05	79.7	19	125.3	33	210.7
06	82.5	20	131.8	34	218.1
07	85.4	21	136.5	35	225.7
08	88.5	22	141.3	36	233.6
09	91.5	23	146.2	37	241.8
10	94.8	24	151.4	38	250.3
11	97.4	25	156.7	39	-----
12	100.0	26	162.2	40	-----
13	103.5	27	167.9	41	-----
14	107.2	28	173.8	42	-----

■ **1750Hz TONE BURST FUNCTION (IC-28E)**

- 1) Select duplex mode.
- 2) Push and release microphone TONE SWITCH.

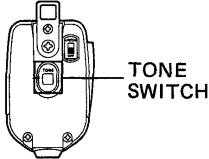

- 3) Transmit.

An audible tone burst may be generated for the purpose of accessing repeaters by the following method.

- 1) Adjust the IC-28E for operation in the duplex mode as described in SECTION 5 - 4 DUPLEX PROGRAMMING.
- 2) Push the TONE SWITCH on the back of the supplied microphone to generate the tone. Release the TONE SWITCH.
 - It is usually best to transmit the tone at the beginning of each transmission for a duration of approximately 300 milliseconds.

- 3) Push the PTT SWITCH on the microphone and transmit in the usual manner.

5 - 5 CALL CHANNEL FUNCTION (except U.S.A. version)

■ **USING THE CALL FUNCTION**

- 1) Push CALL SWITCH to select call function.

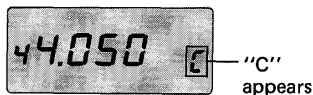

- 2) Push CALL SWITCH again to release call function.

- 1) Push the CALL SWITCH while in either the VFO or MEMORY mode.
 - The IC-28A/E immediately selects the frequency stored in memory channel 21.
 - The call channel symbol "C" also appears on the display.

- 2) Push the CALL SWITCH again when finished with the call function.
 - The IC-28A/E returns to the function in use before the call function was selected.
 - The "C" disappears from the display.
 - The VFO/MR SWITCH may also be used to return directly to either the VFO or MR mode.

■ **PROGRAMMING THE CALL CHANNEL**

To program the call channel, follow the same procedure as for programming memory channel 21. Refer to SECTION 5 - 2 MEMORY PROGRAMMING.

5 - 6 MICROPHONE

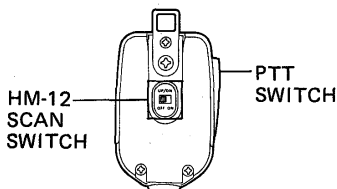
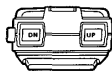

PTT SWITCH:

Push this switch to turn the transmitter ON and OFF.

UP SWITCH and DN (down) SWITCH:

In the VFO mode, pushing either of these switches changes the operating frequency in the direction indicated on the switch by one step. Holding either switch down starts the frequency scan (SECTION 5 - 3 FREQUENCY SCANNING).

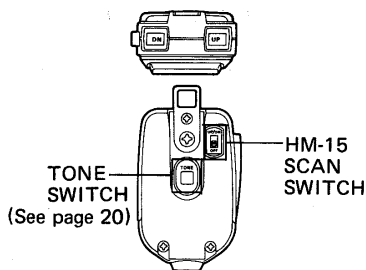

NOTE: When scanning, the SCAN SWITCH must remain ON at all times.

5 - 7 BACKUP BATTERY

In the MEMORY mode, the switches change the selected memory channel one channel at a time. Holding either switch down starts the memory channel scan (SECTION 5 - 3 MEMORY CHANNEL SCANNING).

SCAN SWITCH:

- OFF: The UP SWITCH and DN SWITCH on the microphone are disabled to eliminate the chance of accidental frequency or memory channel changes.
- ON: The SCAN SWITCH must be ON for the UP SWITCH and DN SWITCH to function as described above.

The IC-28A/E contains a lithium battery as a backup for the internal microcomputer memory in the transceiver for times when the external power source is removed or interrupted. The lithium battery is a reliable backup device which has been proven to last for more than five years under actual operating conditions.

After using the IC-28A/E for five years, monitor the transceiver operation carefully and replace the battery if there are repeated cases of display malfunction.

NOTE: Battery replacement should be done by your nearest ICOM authorized dealer or ICOM service center.

5 - 8 RESETTING INTERNAL MICROCOMPUTER (CPU)

NOTE: After resetting the CPU, all memory channels must be re-programmed.

Occasionally, the LCD READOUT may display erroneous information either during operation or when first applying power. This may, for example, be caused by an external cause such as static electricity.

When this sort of problem is encountered, turn OFF the power to the IC-28A/E, wait for a few seconds and turn the power ON again. If the problem persists, perform the following procedure.

- 1) Turn ON the power to the IC-28A/E.
- 2) Locate the RESET HOLE in the bottom cover of the transceiver.
- 3) Insert a non-metallic probe through the hole and push the RESET SWITCH.
- 4) The microcomputer in the IC-28A/E is now reset and the following parameters are automatically set as shown.

TRANSCEIVER	VFO FREQUENCY and MEMORY CHANNELS	TUNING STEPS	OPERATING MODE	TRANSMIT OFFSET	TRANSMIT OUTPUT POWER
IC-28A	146.010MHz	15kHz	VFO/SIMPLEX	600kHz	25W
IC-28A (Australia version)	145.000MHz	25kHz	VFO/SIMPLEX	600kHz	25W
IC-28E	145.000MHz	25kHz	VFO/SIMPLEX	600kHz	25W

5-9 OPTIONAL UNITS

■ PROGRAMMING THE UT-28 DIGITAL CODE SQUELCH UNIT

The following are descriptions for the operation of two optional units which provide alternative squelch circuits. Refer to the INSTRUCTION sheets which accompany each unit for installation instructions and additional information.

- 1) Push the T/D. SQL SWITCH.
 - "D.SQL" appears on the display.
- 2) Push the SET SWITCH.
 - "D.SQL" begins flashing on the display.
 - A five digit group code and the memory in which it is stored appear. There are three memories reserved for storing group codes.

NOTE: The group code is a five digit number which must be programmed identically in both the transmitting and receiving radios in order for the digital code squelch system to function. Any number from 00000 to 99999 inclusive may be programmed.

- 3) Use the front panel DOWN/UP SWITCH to select the desired group code memory.
- 4) Push the SET SWITCH again.
 - "AQS" begins flashing on the display and "D.SQL" disappears.
 - A single digit in the group code also begins flashing.
- 5) Turn the TUNING CONTROL to set the flashing digit to the number desired.
- 6) Use the front panel DOWN/UP SWITCH to select another digit in the group code.
 - The newly selected digit begins flashing and the digit may be set with the TUNING CONTROL.
- 7) Set the three remaining group code digits in a similar manner.
- 8) Push the SET SWITCH.

■ PROGRAMMING THE UT-29 TONE SQUELCH UNIT

- 1) Use the DUPLEX SWITCH to select the simplex mode.
 - "DUP—" or "DUP+" should not appear on the display.
- 2) Push the T/D.SQL SWITCH.
 - "D.SQL" and "TONE" appear on the display.
- 3) Push the SET SWITCH.
 - "D.SQL" and "TONE" begin flashing on the display.
 - A tone number and the memory in which it is stored appear. There are three memories reserved for storing tone numbers.
 - Refer to the chart for the correlation between the tone numbers and their associated frequencies.

AQS refers to Amateur Quinmatic System which includes digital code squelch as one feature. The digital code squelch used in AQS is not compatible with some other commercially available digital squelch systems.

● **UT-29 TONE SQUELCH UNIT
SUBAUDIBLE FREQUENCIES**

TONE NUMBER	FREQ. (Hz)	TONE NUMBER	FREQ. (Hz)	TONE NUMBER	FREQ. (Hz)
01	67.0	15	131.8	29	218.1
02	71.9	16	136.5	30	225.7
03	77.0	17	141.3	31	233.6
04	82.5	18	146.2	32	241.8
05	88.5	19	151.4	33	250.3
06	94.8	20	156.7	34	67.0
07	100.0	21	162.2	35	71.9
08	103.5	22	167.9	36	74.4
09	107.2	23	173.8	37	77.0
10	110.9	24	179.9	38	79.7
11	114.8	25	186.2	39	82.5
12	118.8	26	192.8	40	85.4
13	123.0	27	203.5	41	88.5
14	127.3	28	210.7	42	91.5

- 4) Use the front panel DOWN/UP SWITCH to select the desired tone memory.
- 5) Turn the TUNING CONTROL to choose the required tone number.
- 6) Push the SET SWITCH.

■ **OPTIONAL SQUELCH UNIT
OPERATION**

Complete the above programming before attempting to use either optional squelch unit.

- 1) Push the T/D.SQL SWITCH to activate the squelch unit.
 - UT-28: "D.SQL" appears on the display.
 - UT-29: "D.SQL" and "TONE" appear on the display.
(The simplex mode must be used.)
- 2) Operate the IC-28A/E in the usual manner as explained in the previous sections of this manual.
 - Turn the optional squelch unit OFF with the T/D.SQL SWITCH in order to program the subaudible tone encoder, the transmit offset or the tuning steps.
- 3) When operating with the digital code squelch unit, confirm that the station with whom you intend to communicate is using the same group code and an AQS system.
- 4) The scanning function cannot be used when the UT-28 Digital Code Squelch Unit is activated.

SECTION 6 INSIDE VIEWS

TOP VIEW (MAIN UNIT)

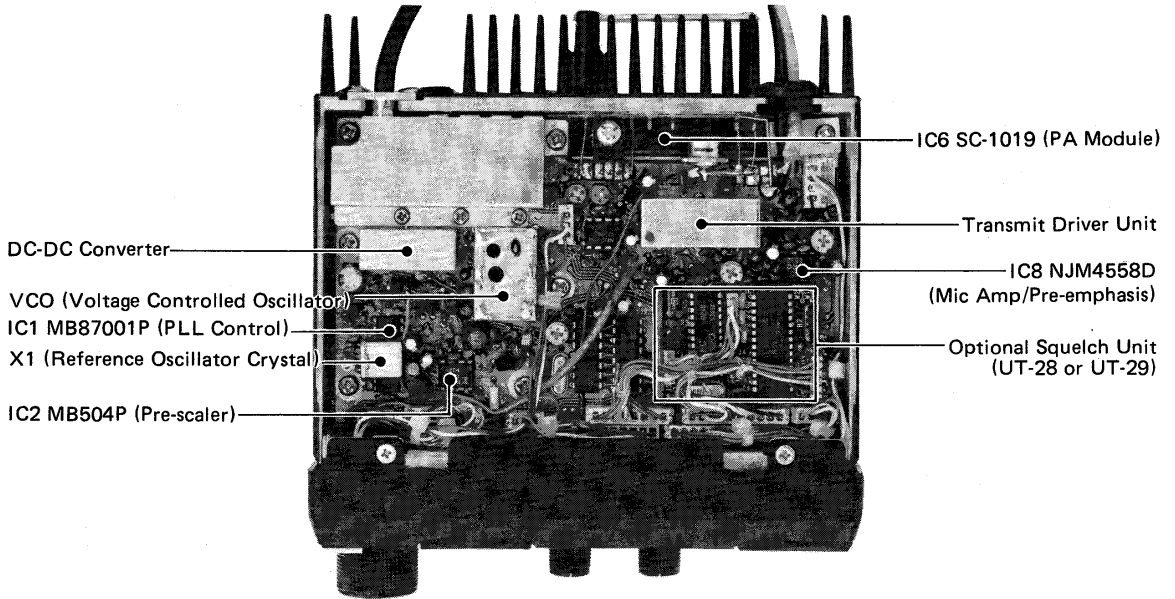

BOTTOM VIEW (RX UNIT)

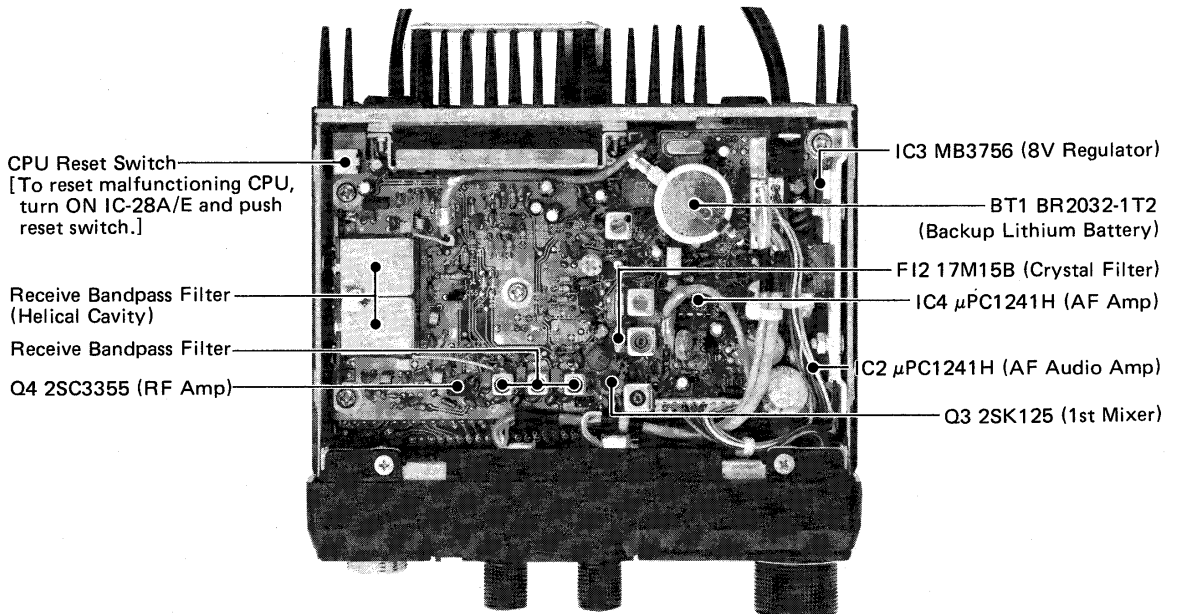

SECTION 7 MAINTENANCE

- **OPERATING ENVIRONMENT** The IC-28A/E is a sensitive electronic device which should not be abused. Avoid using the IC-28A/E in excessively hot, humid or dusty environments. Do not subject the transceiver to strong vibrations or install it where water damage could result.
- **ADJUSTMENTS** No internal adjustment of the transceiver is required since all variable components have been set correctly by the factory. Misadjusting certain components may damage the transceiver.
- **MALFUNCTIONS** A variety of apparent problems can be solved by simply resetting the internal microcomputer in the IC-28A/E. Refer to SECTION 5 - 8 RESETTING INTERNAL MICROCOMPUTER (CPU) for detailed instructions.
- **CLEANING** The IC-28A/E will eventually require cleaning after sitting in your ham shack for a period of time. Remove the three knobs from the front panel and use a soft cloth with a mild, soapy solution. Do not use strong chemicals or cleaning solvents. Wipe dry before replacing the knobs on the panel.
- **FUSES** Locate the cause for a blown fuse before replacing it and attempting to operate the IC-28A/E again. The IC-28A/E uses 15 ampere fuses in the DC power cable.
- **CHANGING A FUSE**

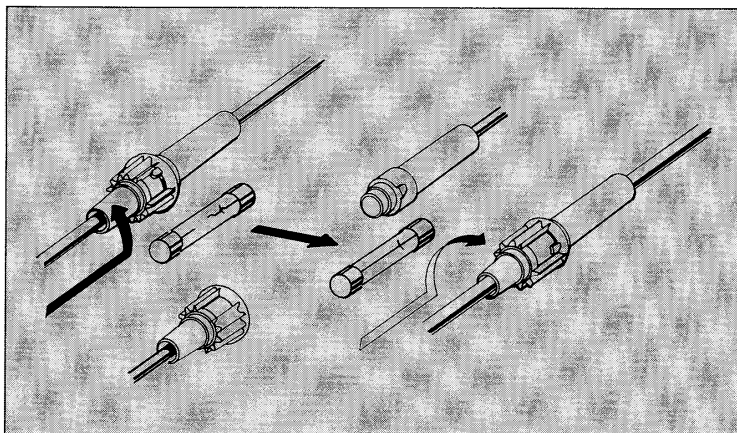

■ TROUBLESHOOTING

The following chart is designed to help you correct problems which are not equipment malfunctions. If you are not able to locate the cause of the problem or to solve it through the use of this chart, contact your nearest ICOM service center or dealer.

PROBLEM	POSSIBLE CAUSE	SOLUTION
1. Power does not come on when the VOL/PWR CONTROL is pushed ON.	<ul style="list-style-type: none"> • Power cable is improperly connected. • Power connector is making poor contact. • Polarity of the power connection is wrong. • Blown fuse. 	<ul style="list-style-type: none"> • Carefully reconnect power cable. • Check the connector pins. • Disconnect the power cable, replace the blown fuse, then reconnect the power cable observing proper polarity. • Check for the cause, then replace the fuse.
2. No sound comes from the speaker.	<ul style="list-style-type: none"> • Volume setting is too low. • SQUELCH CONTROL is set incorrectly. • External speaker is connected. 	<ul style="list-style-type: none"> • Set volume to an appropriate level. • Adjust squelch so the noise from the speaker is just quieted while receiving no signal. • Check that the external speaker plug is inserted properly, and that the external speaker cable is not cut.
3. Sensitivity is low and only strong signals are audible.	<ul style="list-style-type: none"> • Antenna feedline is cut or short circuited. 	<ul style="list-style-type: none"> • Check, and if necessary replace, the feedline.
4. No or low RF output.	<ul style="list-style-type: none"> • The LOW position is selected with the HI/LO SWITCH. • PTT SWITCH on the microphone is not operating due to poor connection of the MIC CONNECTOR. 	<ul style="list-style-type: none"> • Push the HI/LO SWITCH to select the HIGH output power position. • Check the connector pins on the MIC CONNECTOR.
5. No modulation of the transmitter.	<ul style="list-style-type: none"> • Poor connection of the MIC CONNECTOR. 	<ul style="list-style-type: none"> • Check the connector pins on the MIC CONNECTOR.
6. Frequency does not change when the TUNING CONTROL is turned.	<ul style="list-style-type: none"> • MEMORY mode is selected. 	<ul style="list-style-type: none"> • Select the VFO mode by using the VFO/MR SWITCH.
7. An abnormal, out-of-band frequency is displayed on the LCD READOUT.	<ul style="list-style-type: none"> • CPU malfunction. • Lithium backup battery is exhausted. 	<ul style="list-style-type: none"> • Reset the CPU (microcomputer). Refer to SECTION 5 - 8. • Take your IC-28A/E to an ICOM authorized dealer or service center.
8. Scan functions do not stop even when signals are received.	<ul style="list-style-type: none"> • SQL/CHK CONTROL is set incorrectly. 	<ul style="list-style-type: none"> • Adjust squelch so the noise from the speaker is just quieted while receiving no signal.
9. Memory channel frequencies change after resetting the CPU.	<ul style="list-style-type: none"> • All memories are initialized after the CPU is reset. 	<ul style="list-style-type: none"> • Re-program the memory channels after the CPU is reset.

SECTION 8 BLOCK DIAGRAM

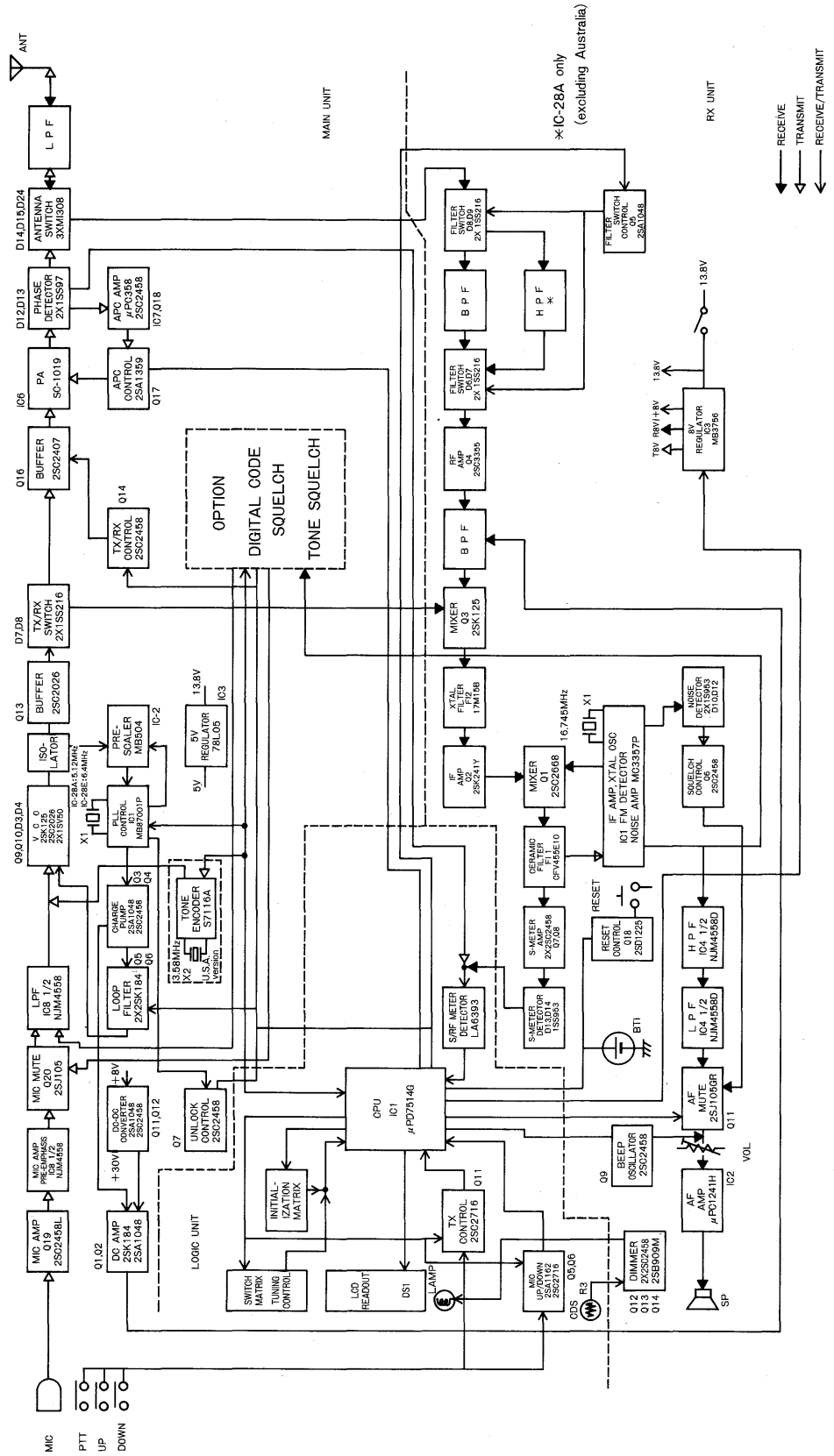

SECTION 9 OPTIONS

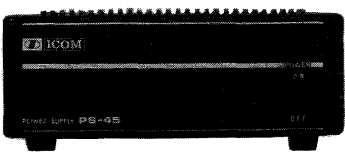
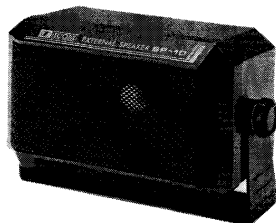
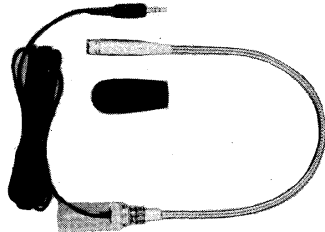
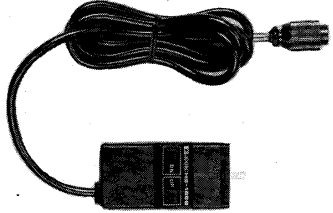
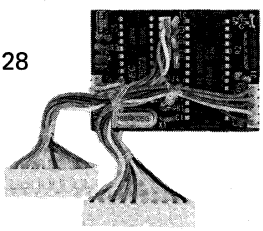
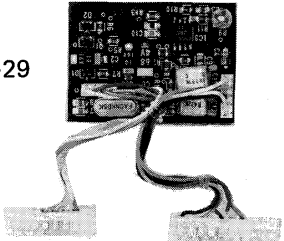
<p>BASE STATION AC POWER SUPPLY (13.8V DC, 8A max.)</p> <p>PS-45</p>  <p>The OPC-102 interface cable to connect the PS-45 to the IC-28A/E must be purchased separately.</p>	<p>MOBILE SPEAKER</p> <p>SP-10</p> 
<p>FLEXIBLE MOBILE MICROPHONE</p> <p>HS-15</p> 	<p>SWITCH BOX FOR HS-15</p> <p>HS-15SB</p> 
<p>COMPRESSOR/GRAPHIC EQUALIZER MICROPHONE</p> <p>SM-10</p> 	<p>ELECTRET CONDENSER DESK MICROPHONE</p> <p>SM-8</p> 
<p>DIGITAL CODE SQUELCH UNIT</p> <p>UT-28</p> 	<p>TONE SQUELCH UNIT</p> <p>UT-29</p> 

IC-HM14	DTMF MICROPHONE
SP-7	BASE SPEAKER
IC-HM16	SPEAKER-MICROPHONE (IC-28A)
IC-HM17	SPEAKER-MICROPHONE (IC-28E)



ICOM INCORPORATED

1-6-19, KAMIKURATSUKURI, HIRANO-KU,
OSAKA 547, JAPAN

A-0767
Printed in Japan