

ICOM IC2E/A VHF 2W HT



TALK (PTT) SWITCH



IC-2A, IC-2E



IC-2AT

SECTION V CONTROL FUNCTIONS

TOP PANEL

[IC-2Au, IC-2A0, IC-2AT]

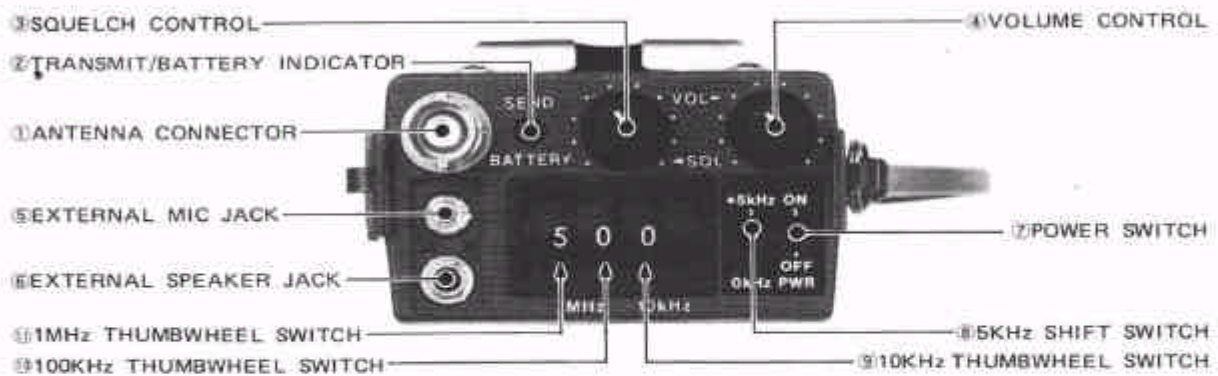

[IC-2EdL, IC-2Ei]



SECTION III ACCESSORIES

Carefully remove your transceiver from the packing carton and examine it for signs of shipping damage. Should any be apparent, notify the delivering carrier or dealer immediately, stating the full extent of the damage. It is recommended you keep the shipping cartons. In the event storage, moving, or reshipment becomes necessary, they come in handy. Various accessories are packed with the transceiver. Make sure you have not overlooked anything.

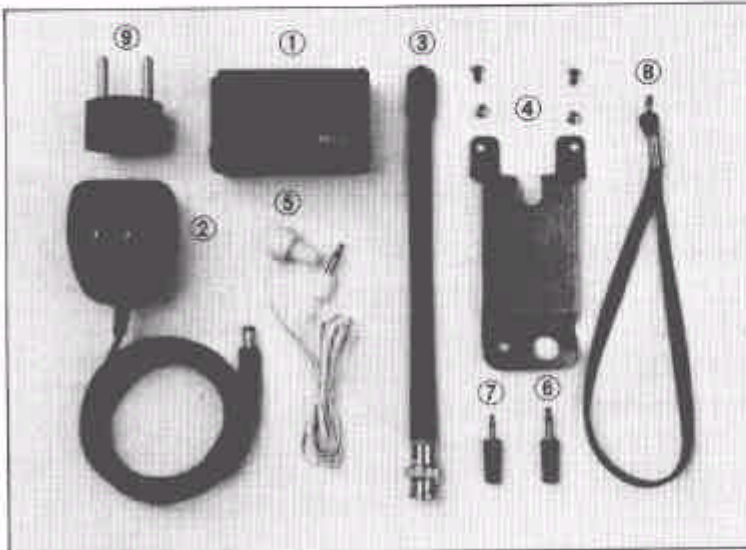

- | | |
|--|---|
| 1. Power pack IC-BP3 | 1 |
| 2. Wall charger BC-25U/E.* | 1 |
| 3. Flexible antenna | 1 |
| 4. Belt clip. | 1 |
| 5. Earphone. | 1 |
| 6. Earphone plug | 1 |
| 7. Microphone plug | 1 |
| 8. Hand-strap | 1 |
| 9. Ac conversion plug (Universal type)** | 1 |
- * BC-25U for 117V
* BC-25E for 240V
** for IC-2A_o, IC-2EDL and IC-2E_i only

TRANSMITTER

Output power	HIGH: 1.5W, LOW: 0.15W at 8.4V
Emission mode	16F ₃
Modulation system	Variable reactance frequency modulation
Max. frequency deviation	±5KHz
Spurious emission	More than 60dB below carrier
Microphone	Built-in Electret condenser microphone Optional Speaker-microphone can be used (IC-HM9)
Operating mode	Simplex Duplex ±600KHz from receive frequency

RECEIVER

Receiving system	Double-conversion superheterodyne
Modulation acceptance	16F ₃
Intermediate frequency	1st: 10.695MHz 2nd: 455KHz
Sensitivity	More than 26dB S+N+D/N+D at 1μV Less than 0.5μV for 20dB Noise quieting
Squelch sensitivity	Less than 0.4μV
Spurious response rejection ratio	More than 60dB
Selectivity	More than ±7.5KHz at -6dB point Less than ±15KHz at -60dB point
Audio output power	More than 300mW
Audio output impedance	8 ohms

Note: [] Values for IC-2AT () Values for IC-2Au and IC-2A_o < > Values for IC-2EDL and IC-2E_i Specifications are approximate and are subject to change without notice or obligation.

① **ANTENNA CONNECTOR**

Connect the supplied flexible antenna. An external antenna can be used, using a BNC connector.

② **TRANSMIT/BATTERY INDICATOR**

Illuminates in the transmit mode. Also indicates the battery condition; during transmission. The voltage of Nickel-Cadmium batteries drops rapidly just before they are exhausted, so when this indicator goes out, be sure to immediately stop using it, and charge the batteries again.

③ **SQUELCH CONTROL**

Sets the squelch threshold level. To turn OFF the squelch function, rotate this control completely counterclockwise. To set the threshold level higher, rotate the control clockwise.

④ **VOLUME CONTROL (and TONE CALL SWITCH)**

Controls the audio output level in the receive mode. Clockwise rotation increases audio output.

TONE CALL SWITCH (IC-2E independent tone type only)

Most repeaters require a 1750Hz Tone-burst for initial access. Depressing the VOLUME CONTROL knob for the required period for a repeater, puts the set in the transmit mode and the tone burst generator actuates and you can access the repeater.

⑤ **EXTERNAL MIC JACK**

When an external microphone is used, connect it to this jack. See the schematic for the proper hookup. When the external microphone is connected the built-in microphone does not function. The IC-HM9 optional speaker-microphone can also be used.

— 12 —

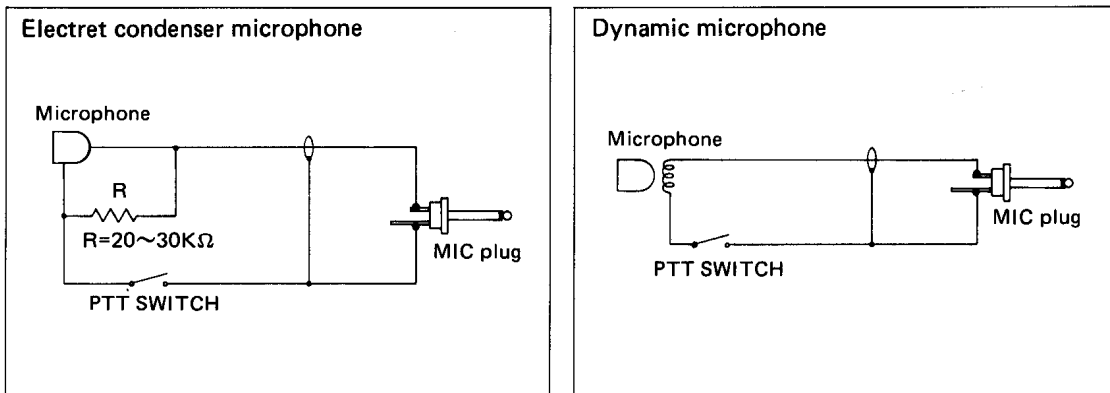

⑥ **EXTERNAL SPEAKER JACK**

When an external speaker (or an earphone) is used, connect it to this jack. Use a speaker with an impedance of 8 ohms. When the external speaker is connected the built-in speaker does not function.

⑦ **POWER SWITCH**

The ON/OFF switch controls the supplied power to the set.

⑧ **5KHz SHIFT SWITCH**

When the desired operating frequency has a 5KHz digit, set this switch in the +5KHz position, and add 5KHz to the indicated frequency on the thumbwheel switches.

***TWO-TONE ENCODER PAD**

IC-2AT has a standard two-tone encoder pad on the front panel. The pad can be used for auto-patch, accessing to closed repeater, and/or other controls.

⑬ RF POWER SWITCH

Selects the RF output power HIGH 1.5 Watt (at 8.4V) or LOW 0.15 Watt (at 8.4V). In the LOW position, the current drain is decreased, to prolong the battery life.

⑭ DUPLEX/SIMPLEX SWITCH

Selects the operation mode DUPLEX for repeater operation, or SIMPLEX for the same receive/transmit frequency operation.

⑮ DUPLEX MODE SWITCH

In the DUPLEX mode, selects the transmitting frequency, 600KHz above or below the receiving frequency according to the desired repeater input frequency.

⑯ CHARGER CONNECTOR

Connects to the output plug of the wall charger BC-25U/E or other power source.

⑰ BATTERY CHARGE INDICATOR

Lights during battery charging.

RECEIVING

Make sure the ⑧ POWER SWITCH is in the OFF position, and before turning ON the power switch, confirm as follows:

1. Make sure the power pack is properly charged and attached to the set.
2. Make sure the supplied flexible antenna is properly set.
When an external antenna is employed, make sure the coaxial line is of the correct impedance (50 ohms) and is neither shorted nor opened, and is firmly connected to the antenna connector.

Set the controls and switches as follows:

- | | |
|---|--|
| ③ SQUELCH CONTROL | Completely counterclockwise |
| ④ VOLUME CONTROL | Completely counterclockwise |
| ⑨~⑩ THUMBWHEEL SWITCHES and ⑦ 5KHz SHIFT SWITCH | Desired frequency
(Others may be at any position or setting.) |

Set the ⑧ power switch to the ON position.

Turn the ④ VOL control clockwise to a comfortable audio level.

If no signal can be heard but only noise, turn the ③ SQL control clockwise until the noise from the speaker stops and set it just below this threshold. (When adjusting the SQL setting, if some communication signals can be heard, turn the thumbwheel switch either direction and set it where only noise can be heard.) Your transceiver will now remain silent until an in-coming signal is received which opens the squelch. If the squelch is unstable due to the reception of weak or mobile stations, adjust the squelch control further until the proper threshold is obtained.

MAIN UNIT SIDE

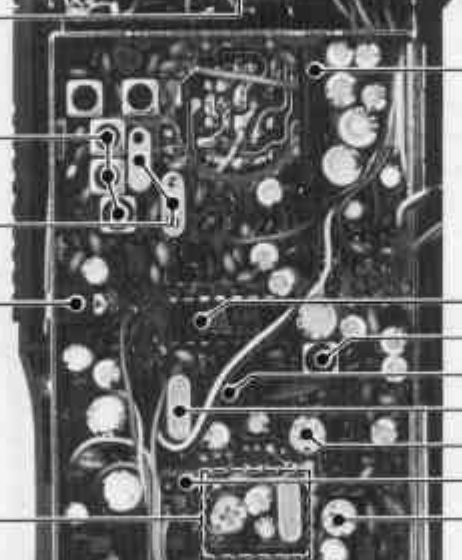
- 
- Thumbwheel Switches
 - L2 ~ L4 (RX Band-Pass Filter)
 - F11 (10.695MHz Crystal Filter)
 - S1 (PTT Switch)
 - Tone Generator circuit (IC-2E Only)
 - IC2 (BA516 AF Power Amp)
 - IC1 (MP5071 IF Circuit IC)
 - L7 (Quadrature Coil)
 - F12 (455KHz Ceramic Filter)
 - X1 (10.240MHz 2nd LO Crystal)
 - R77 (Tone Signal Level Adjust)
 - Two-Tone Encoder Connector
 - R71 (Deviation Adjust)

MAIN UNIT SIDE

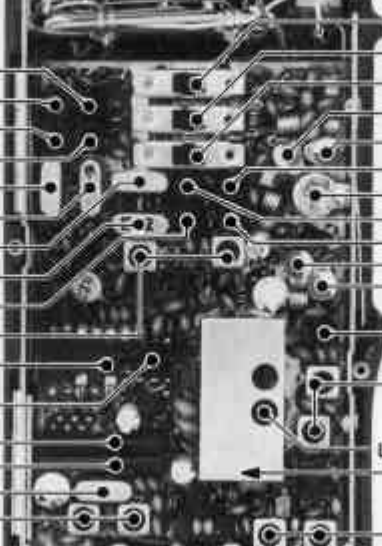
- 
- L9 (X4 0KHz Frequency Adjust)
 - L10 (X5 0KHz Frequency Adjust)
 - L14 (X5 +5KHz Frequency Adjust)
 - L13 (X4 +5KHz Frequency Adjust)
 - X5 (34.85MHz PLL - Duplex LO Crystal)
 - X4 (35.15MHz PLL + Duplex LO Crystal)
 - X3 (35.00MHz PLL Simplex LO Crystal)
 - X2 (32.32625MHz PLL RX LO Crystal)
 - L11 (X2 +5KHz Frequency Adjust)
 - L15 - L16 (PLL LO Output Filter)
 - Thumbwheel Switch Connector
 - IC1 (TC9123 Programmable Divider)
 - IC2 (TC5081 Phase Detector)
 - IC3 (TC5082L Oscillator/Divider)
 - X1 (5.12MHz Reference Frequency Crystal)
 - L17 - L18 (RX LO Band-Pass Filter)
 - S3 RF POWER SWITCH
 - S1 DUPLEX/SIMPLEX SWITCH
 - S2 DUPLEX MODE SWITCH
 - C91 (Trimmer)
 - C90 (Trimmer)
 - L8 (X3 0KHz Frequency Adjust)
 - Q13 (PA 2SC1947)
 - L12 (X3 +5KHz Frequency Adjust)
 - L7 (X2 0KHz Frequency Adjust)
 - C86 (Trimmer)
 - C85 (Trimmer)
 - Q12 (Driver 2SC2053)
 - L21 - L22 (TX Band-Pass Filter)
 - L3 (VCO Free-Run Frequency Adjust)
 - VCO Circuit
 - L19 - L20 (TX Band-Pass Filter)

TR No.	TRANSMIT				RECEIVE				REMARKS
	BASE OR GATE1	GATE2	COLLECTOR OR DRAIN	EMITTER OR SOURCE	BASE OR GATE1	GATE2	COLLECTOR OR DRAIN	EMITTER OR SOURCE	
Q17	0.6		8.4	2.0	5.0		8.4	2.0	
Q18	8.2		5.0	8.4	8.4		5.0	8.4	
Q19	0.6		8.2	GND	0.5		8.4	GND	
Q20	0.6		0.6	GND	0.6		0.5	GND	
Q21	5.7		3.4	5.0	5.8		0	5.0	
Q22	3.4		4.0	4.2	0		0	0	
Q23	4.8		3.8	3.9	3.2		1.3	5.0	
Q24	0.6		0	GND	0		4.9	GND	
Q25	2.4		4.2	2.0	0		0	0	
Q26	2.6		3.6	2.0	0		0	0	
Q27	3.6		2.6	4.1	0		0	0	
Q28	0.6		2.0	GND	0		0	GND	
Q29	2.1		4.2	1.9	0		0	0	
Q30	0/4.9		4.4/7.7	2.6/4.9	0/0		0/7.8	0/0	IC-2E/A
Q31	4.4/8.3		8.4/6.1	4.0/8.4	0/8.4		8.4/0	0/8.4	IC-2E/A
Q32	0		0.6	GND	0		0.6	GND	IC-2AT only

TR No.	TRANSMIT				RECEIVE				REMARKS
	BASE OR GATE1	GATE2	COLLECTOR OR DRAIN	EMITTER OR SOURCE	BASE OR GATE1	GATE2	COLLECTOR OR DRAIN	EMITTER OR SOURCE	
Q17	0.6		8.4	2.0	5.0		8.4	2.0	
Q18	8.2		5.0	8.4	8.4		5.0	8.4	
Q19	0.6		8.2	GND	0.5		8.4	GND	
Q20	0.6		0.6	GND	0.6		0.5	GND	
Q21	5.7		3.4	5.0	5.8		0	5.0	
Q22	3.4		4.0	4.2	0		0	0	
Q23	4.8		3.8	3.9	3.2		1.3	5.0	
Q24	0.6		0	GND	0		4.9	GND	
Q25	2.4		4.2	2.0	0		0	0	
Q26	2.6		3.6	2.0	0		0	0	
Q27	3.6		2.6	4.1	0		0	0	
Q28	0.6		2.0	GND	0		0	GND	
Q29	2.1		4.2	1.9	0		0	0	
Q30	0/4.9		4.4/7.7	2.6/4.9	0/0		0/7.8	0/0	IC-2E/A
Q31	4.4/8.3		8.4/6.1	4.0/8.4	0/8.4		8.4/0	0/8.4	IC-2E/A
Q32	0		0.6	GND	0		0.6	GND	IC-2AT only

PLL UNIT TRANSISTORS

TR No.	TRANSMIT				RECEIVE				REMARKS
	BASE OR GATE1	GATE2	COLLECTOR OR DRAIN	EMITTER OR SOURCE	BASE OR GATE1	GATE2	COLLECTOR OR DRAIN	EMITTER OR SOURCE	
Q 1	0		4.0	0.8	0		4.0	0.75	
Q 2	0.7		1.0	GND	0.7		1.0	GND	
Q 3	1.6		2.9	1.0	1.6		2.9	1.0	
Q 4	0.7		0.7	GND	0.7		0.7	GND	
Q 5	1.4		3.4	0.9	1.4		3.4	0.9	
Q 6	1.3		4.9	0.8	1.3		4.9	0.8	
Q 7	0		0	1.5	2.0		4.4	1.7	
Q 8	0.5		1.5	GND	0.5		1.7	GND	
Q 9	1.8		4.4	1.5	0		0	1.7	
Q10	0		1.2	GND	0.7		0	GND	
Q11	1.1		8.2	0.5	0		9.0	0	
Q12	0.55		8.6	0.1	0		9.0	0	Power HIGH
Q13	1.2		8.8	GND	0		9.0	GND	
Q14	4.6		0	5.0	4.6		0	5.0	

IN TRANSMIT MODE

UNIT	IC No.	PIN No.																REMARKS		
		1	2	3	4	5	6	7	8	9	10	11	12	13	14	15	16		17	18
MAIN	IC1	0	0	0	0	0	0	0	0	0	0	0	GND	0	0	0	0			
MAIN	IC2	0	0	0	0	GND	0	0	0	0										
MAIN	IC3	0.8	1.4	1.6	1.8	4.0	2.0	2.0	2.0	GND										IC-2E only
PLL	IC1	5.0	1.6	0	0	0	0	0	0	0	0	4.4	0	4.4	0	0	0	0	GND	f=145MHz
PLL	IC2	0	4.4	1.2	5.0	5.0	0	0	2.4	GND										
PLL	IC3	0.9	1.4	1.8	0	5.0	0	2.4	2.4	GND										
TOUCH TONE	IC1	6.1	5.7	6.1	6.1	6.1	GND	0	6.1	6.1	0	0	0	0	0	4.4	0			IC-2AT only

IN RECEIVE MODE

UNIT	IC No.	PIN No.																REMARKS		
		1	2	3	4	5	6	7	8	9	10	11	12	13	14	15	16		17	18
MAIN	IC1	4.2	5.0	5.3	5.6	0.9	0.9	1.1	5.6	2.9	2.0	2.1	GND	5.1	0		2.0			
MAIN	IC2	6.1	4.3	7.6	3.6	GND	3.6	3.6	3.4	3.4										SQL OPEN
MAIN	IC3	0	0	0	0	0	0	0	0	GND										IC-2E only
PLL	IC1	5.6	1.6	0	0	0	0	0	0	0	0	4.4	0	4.4	0	0	0	0	GND	f=145MHz
PLL	IC2	0	4.4	1.2	5.0	5.0	0	0	2.4	GND										
PLL	IC3	0.9	1.4	1.8	0	5.0	0	2.4	2.4	GND										
TOUCH TONE	IC1	0	0	0	0	0	GND	0	0	0	0	0	0	0	0	0	0			IC-2AT only

SECTION X BLOCK DIAGRAM

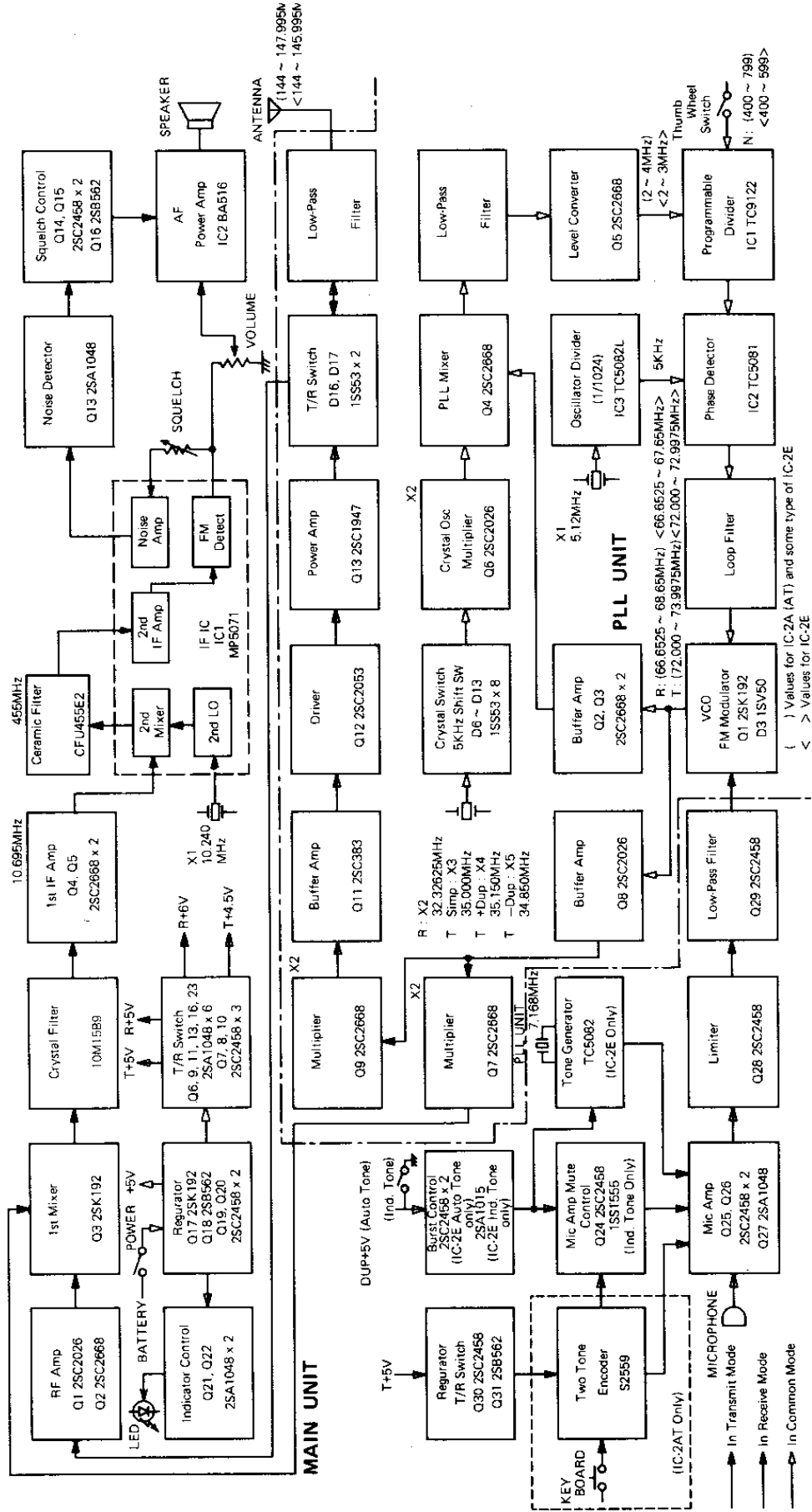



LIST OF OPTIONS

ICOM SERIES TRANSCEIVERS

Thank you for purchasing an Icom handheld transceiver.

This brochure shows various options available for Icom IC-2A/AT/E, IC-02A/AT/E, IC-03AT and IC-04AT/E handheld transceivers.

■ BATTERY PACKS

CAUTION: The use of non-Icom battery packs/chargers may impair transceiver performance and invalidate the warranty.







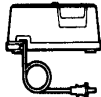

CAUTION: The BP-7 and BP-70 supplies 13.2V. This voltage exceeds the acceptable power supply voltage of the IC-2A/AT/E.

BATTERY PACKS	BP-2	BP-3	BP-4	BP-5	BP-5A	BP-7	BP-8	BP-70
CAPACITY	450 mAh	270 mAh	Battery case for AA (R6) size x 6	450 mAh	450 mAh	450 mAh	800 mAh	270 mAh
VOLTAGE	7.2V	8.4V	7.2V or 9.0V	10.8V	10.8V	13.2V	8.4V	13.2V
HEIGHT	39 mm; 1.5 in	39 mm; 1.5 in	49 mm; 1.9 in	56 mm; 2.2 in	80 mm; 3.1 in	80 mm; 3.1 in	80 mm; 3.1 in	60.5 mm; 2.4 in
CHARGING PERIOD AND USABLE CHARGERS	1.5 hrs.: BC-35, 36	15 hrs.: BC-35, 36 BC-25, 26, 27 CP-1, 11 OPC-207	NiCd batteries only* 15 hrs.: BC-35, 36	1.5 hrs.: BC-35, 36	1.5 hrs.: BC-35, 36 15 hrs.: BC-16, 17, 18 CP-1, 11 OPC-207	1.5 hrs.: BC-35, 36 15 hrs.: BC-16, 17, 18 CP-1, 11 OPC-207	3 hrs.: BC-35, 36 15 hrs.: BC-16, 17, 18 CP-1, 11 OPC-207	9 hrs.: BC-35, 36 BC-16, 17, 18 CP-1, 11 OPC-207

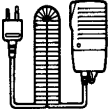
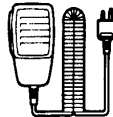
Charging periods are approximate.

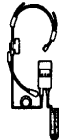
*NEVER charge dry batteries. This may cause internal liquid leakage of the batteries.

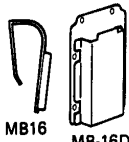
■ OPTIONS

BC-35, BC-36 DESKTOP CHARGER	BC-16U/E, BC-17, BC-18 BC-25U/E, BC-26E, BC-27 WALL CHARGER	HM-9 SPEAKER-MICROPHONE	HM-46 SPEAKER-MICROPHONE	HM-54 SPEAKER-MICROPHONE
				
Desktop charger for all battery packs.	BC-25 - 27 charge BP-3, BC-16 - 18 charge BP-5A, BP-7, BP-8 and BP-70.	Round-type speaker-microphone.	Slim-type speaker-microphone equipped with an earphone jack.	Heavy-duty type speaker-microphone.
HS-51 HEADSET	HS-10 + HS-10SA HEADSET + VOX UNIT	HS-10 + HS-10SB HEADSET + PTT SWITCH BOX	MB-16 MOBILE BRACKET MB-16D WALL BRACKET	DC-1 DC-DC CONVERTER
				
Includes VOX function and PTT switch. • IC-2A/AT/E cannot accept this option.	For automatic transmit/receive switching. • IC-2A/AT/E cannot accept this option.	For manual transmit/receive switching.	For mounting the transceiver in a vehicle or to a wall.	Allows you to operate your IC-2A/AT/E using an external 13.8V DC power source.

- **BA-10 BOTTOM CAP**
Protects terminals on the base of the IC-02A/AT/E, IC-03AT and IC-04AT/E.
- **CP-1 CIGARETTE LIGHTER CABLE**
Charges a battery pack with a 12 V cigarette lighter socket.
- **CP-10 BATTERY SEPARATION CABLE**
For separating a transceiver from the battery pack.
- **CP-11 CIGARETTE LIGHTER CABLE WITH NOISE FILTER**
Allows you to use your transceiver through a 12 V cigarette lighter socket.
- **OPC-207 DC POWER CABLE**
For operating the transceiver or charging a battery pack with an external 13.8 V DC power.

■ CARRYING CASES For the IC-02A/AT/E, IC-03AT and IC-04AT.

- **LC-11**
For use of the transceiver with the BP-2, BP-3 or BP-4.
 - **LC-12**
For use of the transceiver with the BP-5 or BP-70.
 - **LC-14**
For use of the transceiver with the BP-5A, BP-7 or BP-8.
- These carrying cases cannot be used with the IC-2A/AT/E.

IC-2A/AT/E SCHEMATIC DIAGRAM

