

ICOM

INSTRUCTION MANUAL

144 MHz FM TRANSCEIVER

IC-2GXA IC-2GXE

IC-2GXAT IC-2GXET

UHF FM TRANSCEIVER

IC-4GXA IC-4GXE

IC-4GXAT IC-4GXET

This device complies with Part 15 of the FCC Rules. Operation is subject to the following two conditions: (1) This device may not cause harmful interference, and (2) this device must accept any interference received, including interference that may cause undesired operation.



Icom Inc.

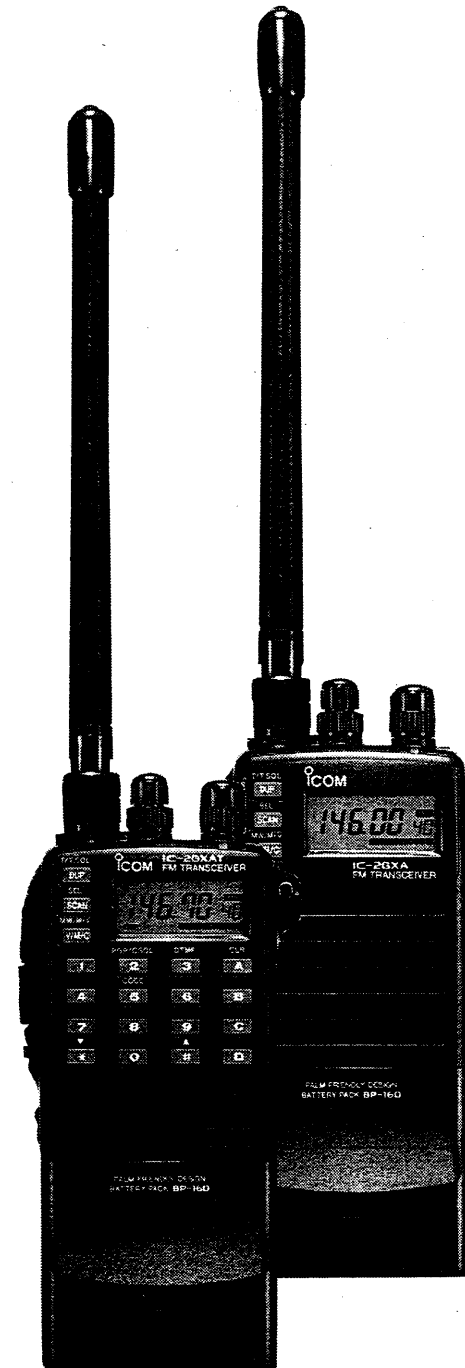

IMPORTANT

READ ALL INSTRUCTIONS carefully and completely before using the transceiver.

SAVE THIS INSTRUCTION MANUAL. This instruction manual contains important safety and operating instructions.

MANUAL NOTES

This instruction manual uses the IC-2GXAT for most of the example displays. Please note that only the frequency differs from the IC-4GXA/E or IC-4GXAT/ET.

This instruction manual distinguishes models as “T” types and “non-T” types rather than using full model names.

“T” types	IC-2GXAT, IC-2GXET, IC-4GXAT, IC-4GXET
“Non-T” types	IC-2GXA, IC-2GXE, IC-4GXA, IC-4GXE

UNPACKING

- Battery pack or battery case ... 1
- Wall charger 1
(Versions attached battery case do not included.)
- Flexible antenna 1
- Handstrap 1
- Belt clip and screws 1 set

CAUTIONS

⚠ NEVER connect the transceiver to an AC outlet or to a power source of more than 16 V DC.

⚠ NEVER connect the transceiver to a power source using reverse polarity. This connection will ruin the transceiver.

⚠ NEVER allow children to touch the transceiver.

AVOID using or placing the transceiver in areas with temperatures below -10°C ($+14^{\circ}\text{F}$) or above $+60^{\circ}\text{C}$ ($+140^{\circ}\text{F}$).

AVOID placing the transceiver in direct sunlight.

BE CAREFUL! When transmitting for a long time with high output power, the rear panel will become hot.

BE CAREFUL! During external DC power operation, connected battery pack or battery case is charged. If the BP-130A BATTERY CASE is connected, remove dry cell batteries. Otherwise, battery leakage may occur.

BE CAREFUL! The use of non-Icom battery packs and chargers may impair transceiver performance and invalidate the warranty.

TABLE OF CONTENTS

IMPORTANT	i	■ Output power selection	13	11 PAGER AND CODE SQUELCH	23 – 26
MANUAL NOTES	i	■ PTT lock	13	■ Function availability	23
UNPACKING	i	5 BASIC REPEATER OPERATION	14	■ What is the pager function?	23
CAUTIONS	i	■ Accessing	14	■ Code channels	24
TABLE OF CONTENTS	ii	6 ADVANCED REPEATER OPERATION	15 – 16	■ Code programming	25
1 PANEL DESCRIPTION	1 – 4	■ Auto repeater	15	■ Pager operation	25
■ Front, side and top panels	1	■ Offset frequency	15	■ Code squelch operation	26
■ Keyboard	3	■ Subaudible tone frequency	16	12 POCKET BEEP AND TONE SQUELCH	27
■ Function display	4	■ Tone scan operation	16	■ Function availability	27
2 PRE-OPERATION	5 – 8	7 DTMF MEMORY CHANNELS	17	■ Pocket beep operation	27
■ Battery pack charging	5	■ DTMF memory programming	17	■ Tone squelch operation	27
■ Battery pack precautions	5	■ DTMF memory transmitting	17	13 OTHER FUNCTIONS	28 – 30
■ About the battery pack	5	8 CALL CHANNEL	18	■ Power saver	28
■ Charging connections	6	■ Call channel recall	18	■ Lighting timer	28
■ Dry cell battery installation	7	■ Call channel programming	18	■ Beep tones	29
■ Accessory attachment	8	9 MEMORY CHANNELS	19 – 20	■ DTMF speed	29
3 FREQUENCY SETTING	9 – 11	■ Memory channel selection	19	■ Channel number restriction	30
■ VFO, MEMORY modes and call channel	9	■ Memory channel programming	19	■ Channel number indication	30
■ Using tuning dial	9	■ Frequency transferring	20	14 OPTIONAL UNIT INSTALLATION	31
■ Tuning step	10	10 SCANS	21 – 22	15 MODE ARRANGEMENT CHART	32
■ Display lighting	10	■ Scan types	21	16 TROUBLESHOOTING	33
■ Dial select step pre-setting	10	■ Programmed scan operation	21	17 SPECIFICATIONS	34
■ Lock function	10	■ Memory scan operation	21	18 OPTIONS	35 – 36
■ Using digit keys	11	■ Skip channel setting	22		
■ Using ▲/ ▼ keys	11	■ Scan resume condition	22		
4 RECEIVING AND TRANSMITTING	12 – 13				
■ Receiving	12				
■ Monitor function	12				
■ Transmitting	12				

1

PANEL DESCRIPTION

Front, side and top panels

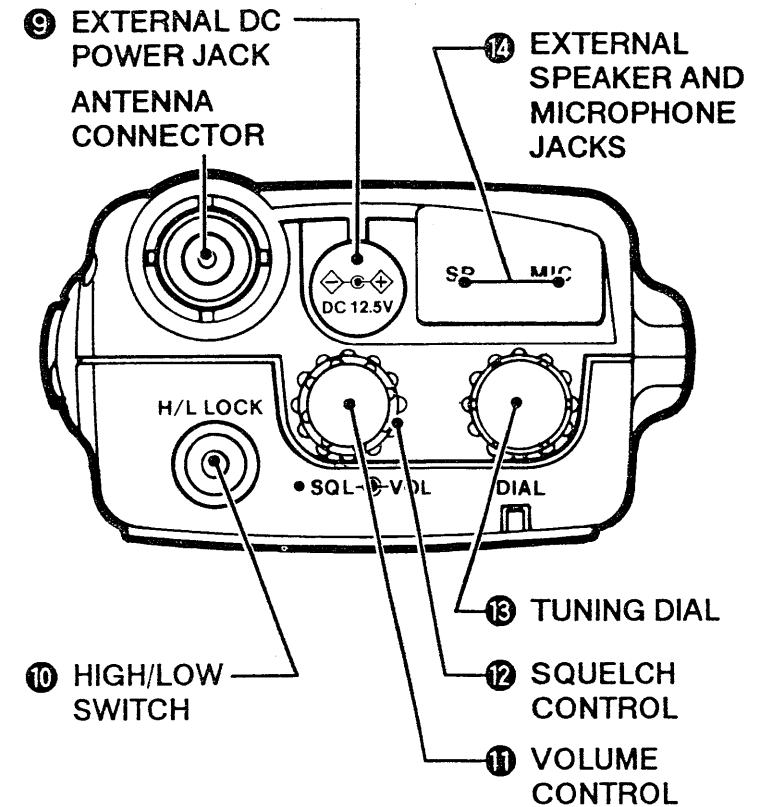
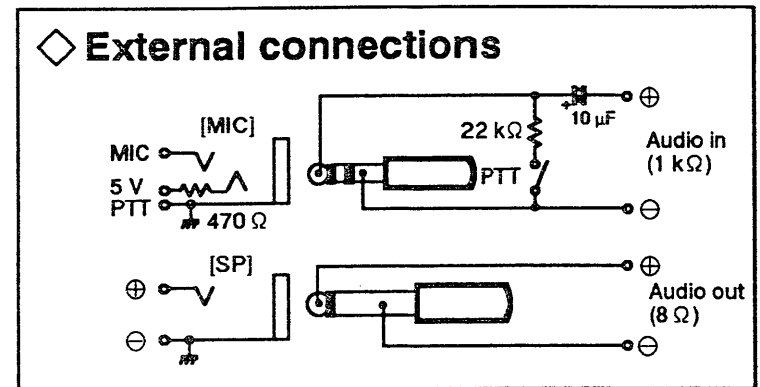
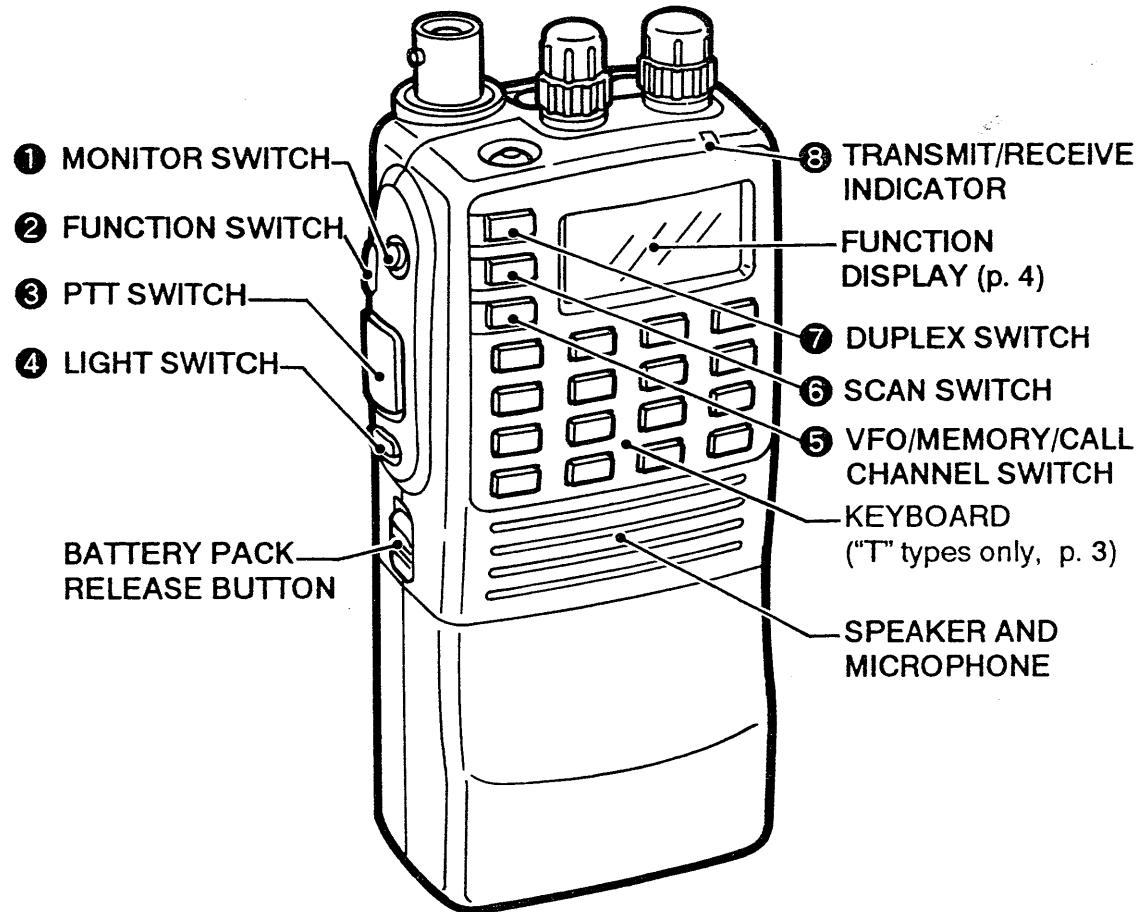

① MONITOR SWITCH [MONI]

Manually opens the squelch and monitors the transmit frequency. (pgs. 12, 14)

② FUNCTION SWITCH [F]

While pushing [F], some switches perform secondary functions.

③ PTT SWITCH [PTT]

Push and hold to transmit. (p. 12)

④ LIGHT SWITCH [LIGHT]

Turns the display lighting ON and OFF. (p. 10)

⑤ VFO/MEMORY/CALL CHANNEL SWITCH

[V/M/C • MW/M▶V]

- Selects VFO mode, MEMORY mode or a call channel in sequence. (pgs. 9, 18, 19)

- [F] + [V/M/C • MW/M▶V]

While in VFO mode: Writes VFO contents into a memory channel. (p. 19)

While in MEMORY mode: Transfers a memory channel contents into the VFO. (p. 20)

While on the call channel: Writes the VFO contents into the call channel. (p. 18)

⑥ SCAN SWITCH [SCAN • SEL]

- Activates and cancels tone scan, programmed scan or memory scan. (pgs. 16, 21)

- [F] + [SCAN • SEL]

While in VFO mode: Selects a digit for the dial select step. (p. 10)

While in MEMORY mode: Selects or cancels skip channel setting. (p. 22)

⑦ DUPLEX SWITCH [DUP • T/T.SQ]

- Selects +duplex, -duplex or simplex. (pgs. 12, 14)

- [F] + [DUP • T/T.SQ] Activates and cancels the subaudible tone encoder, tone squelch or pocket beep function. (pgs. 14, 27)

⑧ TRANSMIT/RECEIVE INDICATOR

- Lights up in green while the squelch is open. (p. 12)

- Lights up in red while transmitting. (p. 12)

⑨ EXTERNAL DC POWER JACK [DC 12.5V]

- Connects a wall charger or DC power source for charging. (p. 6)

- Connects 6-16 V DC power source for operation. (p. 35)

⑩ HIGH/LOW SWITCH [H/L • Lock]

- Selects high or low output. (p. 13)

- [F] + [H/L • Lock] Activates and cancels the lock function. (p. 10)

⑪ VOLUME CONTROL [VOL]

Turns the power ON and OFF, and adjusts audio output level. (pgs. 9, 12)

⑫ SQUELCH CONTROL [SQL]

Adjusts the squelch level. (p. 12)

⑬ TUNING DIAL [DIAL]

Selects an operating frequency, memory channel, etc. (pgs. 9, 19)

⑭ EXTERNAL SPEAKER AND MICROPHONE JACKS [SP], [MIC]

Connects an optional speaker-microphone or headset, if required. (p. 36)

1 PANEL DESCRIPTION

Keyboard ("T" types only)

	PGR/C SQL	DTMF	CLR
1	2	3	A
	CODE		
4	5	6	B
7	8	9	C
▼		▲	
*	0	#	D

Each key encodes a DTMF code while transmitting. (p. 14)

Some keys have functions as tables at right.

Key	Function
1 to 0	- While in VFO mode: Sets the operating frequency. (p. 11) - While in MEMORY mode: Sets the 1's digit of memory channel number. (p. 19)
▲ # ▼ *	- While in VFO mode: Changes operating frequency. (p. 11) - While in MEMORY mode: Sets a memory channel. (p. 19)
CLR A	- While in VFO mode: Clears frequency input before entry. (p. 11) - Cancels the tone scan, programmed scan or memory scan. (pgs. 16, 21) - While in SET mode: Sets the contents and exits SET mode.

Key	Function while pushing [F]
PGR/C SQL 2	Activates and cancels optional pager and code squelch function. (pgs. 25, 26)
DTMF 3	Allows you to select a DTMF memory channel. (p. 17)
CODE 5	Allows you to program code channels for an optional pager and code squelch functions. (p. 25)

Function display

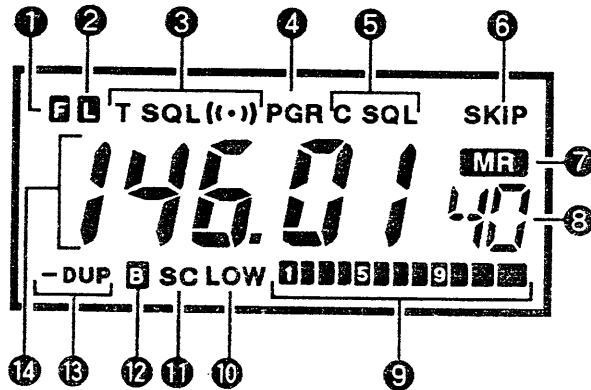

① FUNCTION INDICATOR

Appears while [F] is pushed and held.

② LOCK INDICATOR

Appears while the lock function is in use. (p. 10)

③ TONE INDICATOR

- "T" appears while the subaudible tone encoder is in use. (p. 14).
- "T SQL ((·))" appears while the pocket beep is in use. (p. 27)
- "T SQL" appears while the tone squelch is in use. (p. 27)

④ PAGER INDICATOR

Appears while an optional pager function is in use. (p. 25)

⑤ CODE SQUELCH INDICATOR

Appears while an optional code squelch function is in use. (p. 26)

⑥ SKIP INDICATOR

Appears while the memory channel is set as a skip channel. (p. 22)

⑦ MEMORY MODE INDICATOR

Appears while in MEMORY mode. (p. 19)

⑧ MEMORY CHANNEL READOUT

- While in VFO or MEMORY mode: A memory channel number appears. (p. 19)
- While on the call channel: "C" appears. (p. 18)

⑨ S/RF INDICATOR

- Shows the relative signal strength while receiving. (p. 12)
- Shows the selected output power while transmitting. (p. 12)

⑩ LOW POWER INDICATOR

Appears while low output power is selected. (p. 13)

⑪ SCAN INDICATOR

Appears during tone scan, programmed scan or memory scan. (pgs. 16, 21)

⑫ PAUSE SCAN INDICATOR

If pause 2 sec. is selected as the scan resume condition, appears during programmed scan or memory scan. (p. 22)

⑬ DUPLEX INDICATOR

"DUP" or "-DUP" appears while duplex is selected for repeater operation. (p. 14)

⑭ FREQUENCY READOUT

Shows the operating frequency.

■ Battery pack charging

(For versions that include the BP-160)

Charge the battery pack before first operating the transceiver and when the battery pack becomes exhausted.

■ Battery pack precautions

NEVER throw a battery pack into a fire.

NEVER expose the battery pack to water.

NEVER short the metal terminals.

NEVER attempt to charge dry cell batteries inside the BP-130A BATTERY CASE. For the BP-130A, charge only when Ni-Cd batteries are installed.

DO NOT charge a fully charged battery pack.

DO NOT discharge a battery pack completely.

AVOID overcharging. Disconnect the wall charger within 48 hrs.

Charging may not occur in extreme cold (under 0°C; +32°F) or extreme heat (over +40°C; +104°F).

■ About the battery pack

◇ Using your battery pack wisely

Recharging can usually be performed 300 times, but battery life can be lengthened to about 500 recharges as follows:

- Use the battery pack until it becomes almost completely exhausted under normal conditions.
- Charge as soon as transmitting becomes impossible.
- Full charge capacity may become lower when repeatedly recharging after only partial discharging. If this occurs, discharge almost completely through normal use before recharging.

◇ Operating periods

Battery pack	Voltage	Capacity	Approx. operating period*	
			IC-2GX	IC-4GX
BP-130A	Battery case R6 (AA) × 6		Varies according to installed batteries.	
BP-157A	7.2 V	900 mA	5 h 50 m	6 h 20 m
BP-160	7.2 V	700 mA	4 h 30 m	5 h
BP-174	12 V	600 mA	2 h 30 m	3 h 20 m

*Transmitting at high power for 1 min., receiving for 1 min. and standby (power saved) for 8 min. Operating periods are estimated values and vary depending on output power, temperature, etc.

■ Charging connections

◇ Regular charging with transceiver

Connect the supplied wall charger* to the [DC 12.5V] jack.

*Not supplied for some versions.

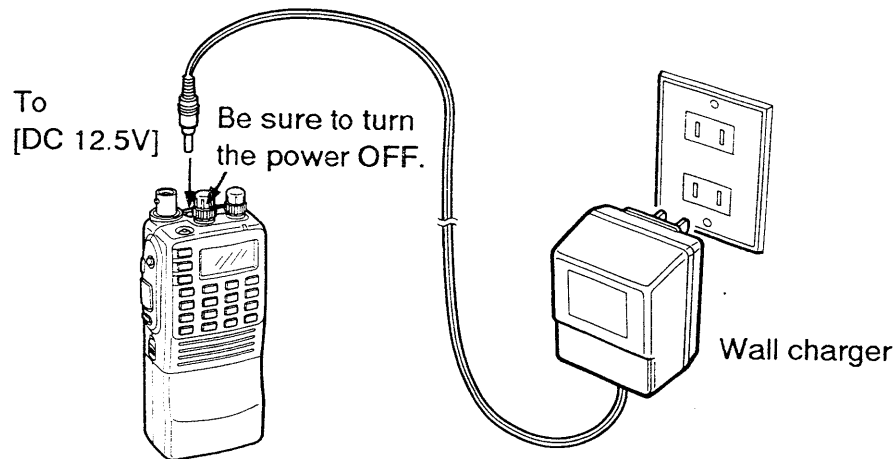

- BP-157A or BP-160
- Ni-Cd batteries in BP-130A

CAUTION:
For the BP-130A, **DO NOT** charge batteries other than Ni-Cd batteries.

- Approx. charging period: 15 hrs.
- The optional BP-174 BATTERY PACK cannot be charged via the [DC 12.5V] jack. For BP-174 charging, refer to "Rapid charging with the optional BC-79" at right, or p. 7 "Charging without transceiver."
- The optional CP-13/L CIGARETTE LIGHTER CABLE WITH NOISE FILTER or OPC-288/L DC POWER CABLE with a 12 to 16 V DC power source can also be used.

◇ Rapid charging with the optional BC-79

- ① Insert the optional AD-28 CHARGER ADAPTER into the charging slot of the BC-79 DESKTOP CHARGER.
- ② Firmly insert a battery pack into the AD-28.

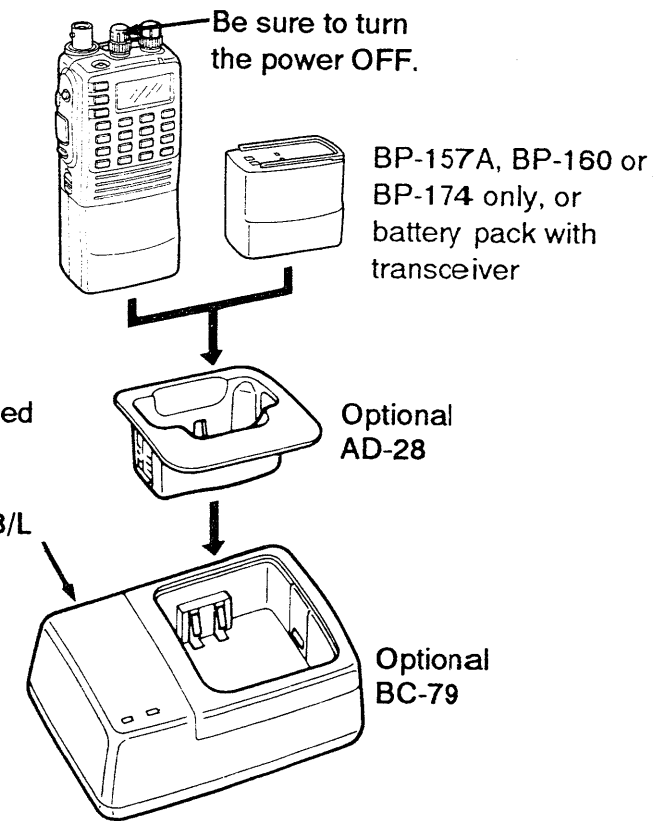

- Connect one of the following:
- AC adapter supplied with the BC-79
 - Optional CP-13/L
 - Optional OPC-288/L

- Approx. charging period
BP-157A, BP-160: 1 hr. BP-174: 1.5 hrs.

2 PRE-OPERATION

◇ Charging without transceiver

Attach an optional AD-25 BATTERY CHARGE ADAPTER to the battery pack. Connect one of the following:

- CP-13/L CIGARETTE LIGHTER CABLE WITH NOISE FILTER
- OPC-288/L DC POWER CABLE
- BC-77 or BC-105 WALL CHARGER

Optional CP-13/L

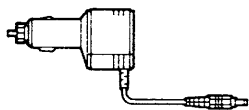

To 12 V cigarette lighter socket

Optional OPC-288/L ⊕ White

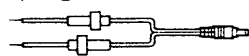

⊖ Black

To 12 - 16 V DC power source

To AC outlet

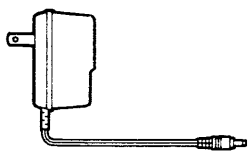

Wall charger

Optional AD-25

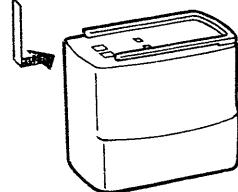
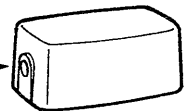

- BP-157A, BP-160 or BP-174
- Ni-Cd batteries in BP-130A

CAUTION:
For the BP-130A,
DO NOT charge batteries other than Ni-Cd batteries.

- Approx. charging period
BP-130A, BP-157A, BP-160: 15hrs. BP-174: 20 hrs.

■ Dry cell battery installation

(For versions that include the BP-130A)

- ① Push and hold the battery release button upwards, then slide the battery case to the right with the transceiver facing you. (Fig. 1)
- ② Open the battery case. (Fig. 2)
- ③ Install 6 dry cell batteries. (Fig. 3)
 - Pay attention to the polarities.

Fig. 1

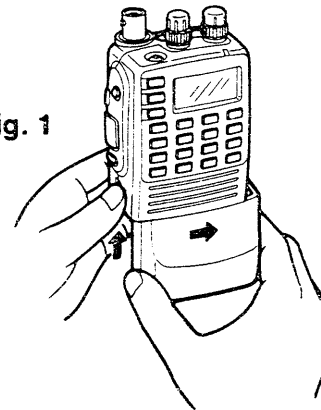

BE CAREFUL!
Before external DC power operation, remove dry cell batteries to prevent battery leakage.

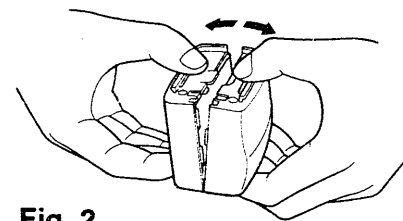

Fig. 2

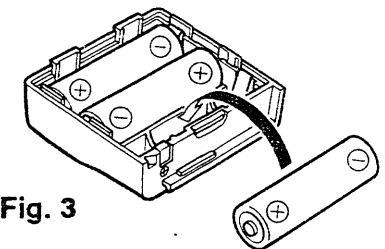
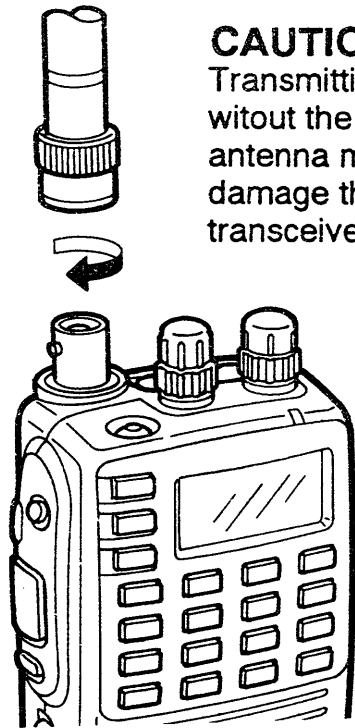

Fig. 3

■ Accessory attachment

◇ Antenna

Connect the supplied flexible antenna into the antenna connector and rotate clockwise.



CAUTION:
Transmitting without the antenna may damage the transceiver.

◇ Belt clip

Remove the plastic screws, then attach the belt clip with the supplied metal screws. Conveniently attaches to your belt.

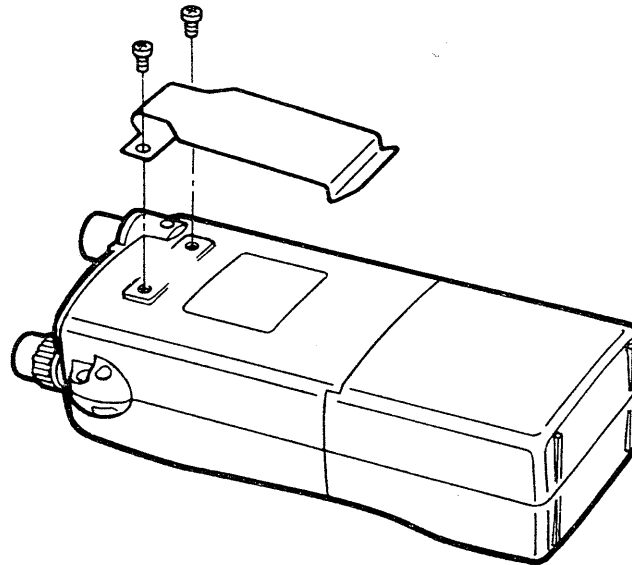

◇ Handstrap

Install the handstrap as shown in the figure below. Facilitates carrying.

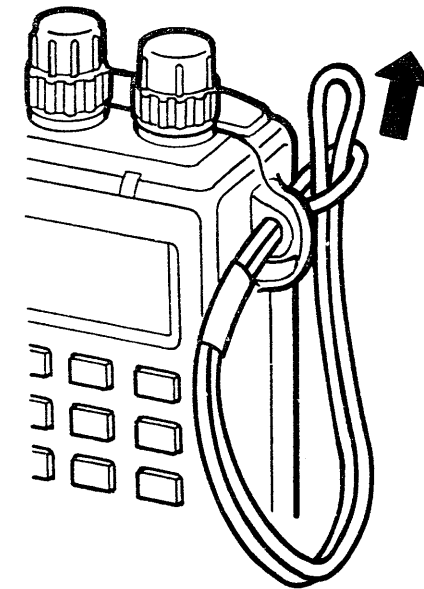

■ VFO, MEMORY modes and call channel

This transceiver has VFO mode, MEMORY mode and a call channel. Pushing [V/M/C] selects VFO mode, MEMORY mode or the call channel.

VFO mode

Used for setting an operating frequency, etc. (pgs. 9–11)

MEMORY mode

Used for memory channel operation. (p. 19)

Call channel

Used to recall the most often-used frequency. (p. 18)

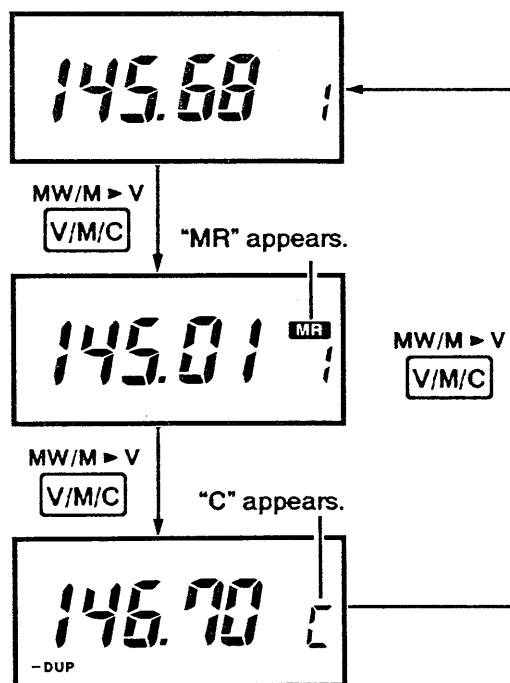

◇ What is VFO?

VFO is an abbreviation of Variable Frequency Oscillator. Frequencies for transmitting and receiving are generated and controlled by the VFO.

■ Using tuning dial

- ① Rotate [VOL] clockwise to turn the power ON.
- ② If "L" appears, push [F] + [H/L • LOCK] to cancel the lock function. (p. 10)
- ③ If "C" or "MR" appears, push [V/M/C] 1 or 2 times to select VFO mode.
- ④ Rotate [DIAL] to set the frequency.
 - Operating frequency changes according to the selected tuning step. (p. 10)

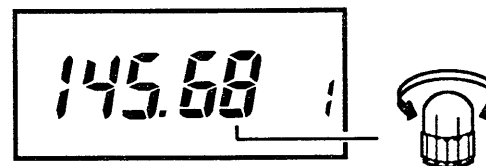

◇ Dial select step function

While pushing [F] and rotating [DIAL], 100 kHz tuning step is available for quick tuning. This is called dial select step function.

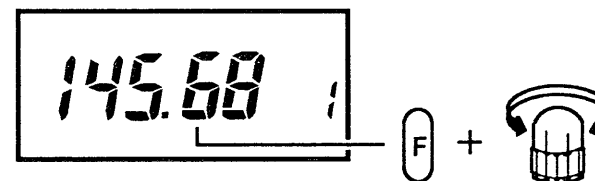

The dial step function also offers 1 MHz tuning step and memory channel number changing in VFO mode. Refer to p. 10 "Dial select step pre-setting."

Tuning step

Using *SET mode*

Select a tuning step according to your area of operation.

- ① Select VFO mode.
- ② Push and hold [H/L] to enter SET mode.
 - 3 beep tones may sound.
- ③ Push [DUP] or [SCAN] several times until "TS" appears.
- ④ Rotate [DIAL] to select the desired tuning step.
 - 5, 10, 12.5, 15, 20, 25, 30 and 50 kHz steps are available.



- ⑤ Push [H/L] or [PTT] to set the tuning step and to exit SET mode.
 - For "T" types, [A] • CLR] is also effective.

Display lighting

The transceiver has display lighting with a 5 sec. timer for night operation.

Push [LIGHT] to turn the lighting ON and OFF.

- When the switches, keyboard or [DIAL] are not operated for 5 sec., the lighting automatically turns OFF.

Dial select step pre-setting

For the dial select step function, select 100 kHz or 1 MHz digit or the memory channel number readout, if required.

- ① Select VFO mode.
- ② Push [F] + [SCAN • SEL] several times to select a blinking digit.

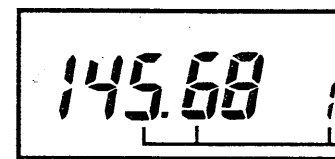

Initial setting before shipping: 100 kHz digit

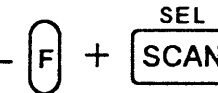

Lock function

To prevent accidental frequency changes and unnecessary function access, the lock function electronically locks [DIAL], switches on the front panel and the keyboard. Push [F] + [H/L • Lock] to activate or cancel the lock function.

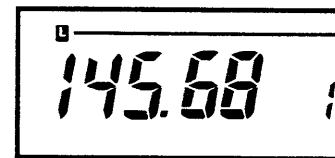

While the lock function is activated, "L" appears.

For "T" types, even while the lock function is activated, DTMF code transmitting and redialing are possible.

3 FREQUENCY SETTING

■ Using digit keys

("T" types only)

- ① Rotate [VOL] clockwise to turn the power ON.
- ② If "L" appears, push [F] + [H/L • Lock].
- ③ If "C" or "MR" appears, push [V/M/C] 1 or 2 times to select VFO mode.
- ④ Input 4 digit keys starting from the 1 MHz digit.
 - When a digit is mistakenly input, push [Ⓐ • CLR].

[Example] Setting to 145.10 MHz.

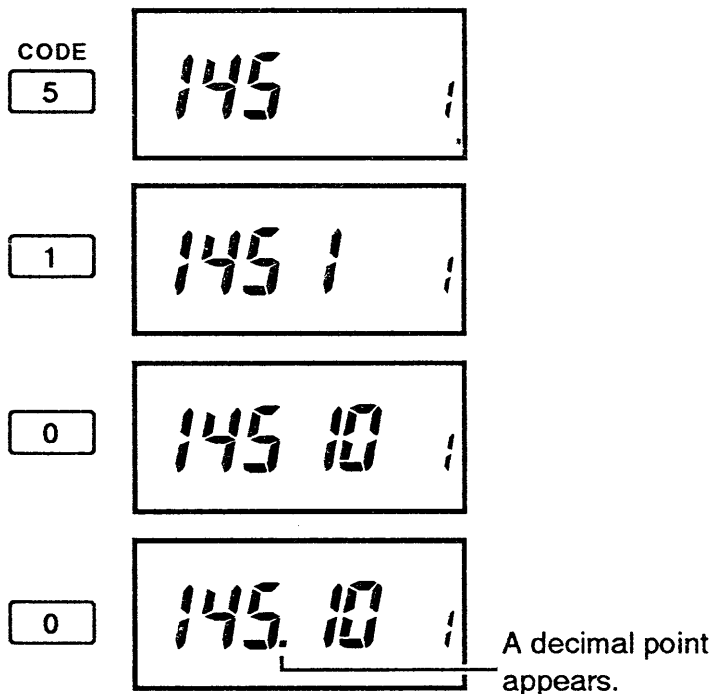

■ Using ▲ / ▼ keys

("T" types only)

- ① Rotate [VOL] clockwise to turn the power ON.
- ② If "L" appears, push [F] + [H/L • Lock].
- ③ If "C" or "MR" appears, push [V/M/C] 1 or 2 times to select VFO mode.
- ④ Push [⊕ • ▲] or [⊗ • ▼] to set the frequency.
 - Frequency changes according to selected tuning step. (p. 10)

[Example] If tuning step is 5 kHz.

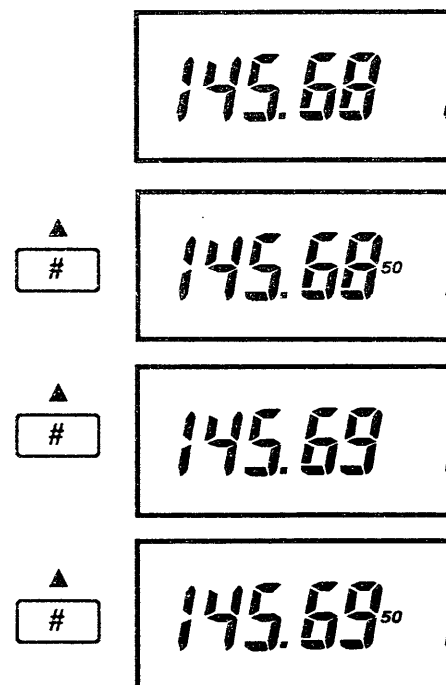

■ Receiving

- ① Rotate [SQL] maximum counterclockwise.
- ② Rotate [VOL] to adjust the desired audio output level.
- ③ Rotate [SQL] clockwise until the noise is muted while no signal is received.
 - When [SQL] is rotated extremely clockwise, the squelch may not open for weak signals.
- ④ Set the operating frequency.

◇ When a signal is received

- The transmit/receive indicator lights up in green.
- Squelch opens and audio is emitted from the speaker.



The S/RF indicator shows receive signal strength.

■ Monitor function

This function is used to listen to weak signals that repeatedly open and close the squelch. When receiving a weak signal, push and hold [MONI] to open the squelch completely.

■ Transmitting

CAUTION: Transmitting without an antenna may damage the transceiver.

- ① Set the operating frequency.
- ② If “DUP” or “-DUP” appears, push [DUP] 1 or 2 times until “DUP” or “-DUP” disappears to select simplex.
- ③ Push [H/L] to select output power, if required. (p. 13)
- ④ Push and hold [PTT] to transmit.
 - The transmit/receive indicator lights up in red.
- ⑤ Speak into the microphone at your normal voice level.
 - **DO NOT** hold the transceiver too close to your mouth or speak too loudly. This may distort the signal.
- ⑥ Release [PTT] to return to receive.



The S/RF indicator shows high or low output power level. (p. 13)

◇ What are simplex and duplex?

For normal communication, simplex is used. Simplex means transmitting and receiving on the same frequency. For communication via a repeater, duplex is used. Duplex means transmitting and receiving on different frequencies. (p. 14)

4 RECEIVING AND TRANSMITTING

■ Output power selection

Push [H/L] to select high or low output power.



While low output power is selected, "LOW" appears.

Power selection	S/RF indicator	Approx. output power	
		with 13.5 V	with 7.2 V
High	■■■■■■■■■■	7 W (2GX) 6 W (4GX)	2.5 W (2GX) 2.5 W (4GX)
Low	■	1 W	1 W

◇ If SET mode is accidentally selected

DO NOT push and hold [H/L] continuously, since SET mode may be selected. If SET mode is accidentally selected, push [H/L] or [PTT] to exit to VFO mode.

- For "T" types, [A] • CLR] is also effective.

■ PTT lock

Using *SET mode*

To prevent accidental transmission, the PTT lock function inhibits transmitting. This function is effective for both the PTT switches on the transceiver and optional speaker-microphone, etc.

- ① Select VFO mode.
- ② Push and hold [H/L] to enter SET mode.
 - 3 beep tones may sound.
- ③ Push [DUP] or [SCAN] several times until "PL" appears.
- ④ Rotate [DIAL] to select "on" or "oFF."
 - "oFF" : [PTT] is unlocked. Transmitting is possible.
 - "on" : [PTT] is electronically locked. Transmitting is impossible.

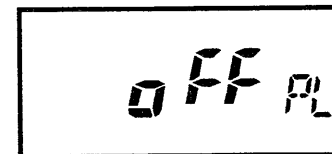

Initial setting before shipping: "oFF"

- ⑤ Push [H/L] or [PTT] to set the PTT lock function selection and to exit SET mode.
 - For "T" types, [A] • CLR] is also effective.

◇ Optional HM-46 SPEAKER-MICROPHONE

Even though the transmit indicator on the HM-46 lights up, transmitting is impossible.

■ Accessing

A repeater receives signals and re-transmits them at a different frequency. Thus, longer communication distances are available. To access a repeater that requires a tone, refer to right.

- ① Select an offset frequency matched with the repeater, if required. (p. 15)
- ② Select the repeater output frequency as your receive frequency.
- ③ Push [DUP] to select either "DUP" or "-DUP" offset direction.

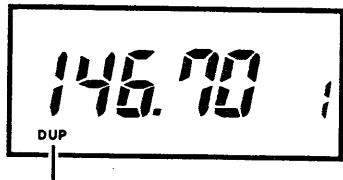

Transmitting frequency shifts in a higher direction.

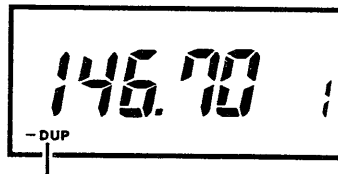

Transmitting frequency shifts in a lower direction.

- ④ Push [PTT] to access the repeater.
- ⑤ To select simplex, push [DUP] 1 or 2 times until "DUP" or "-DUP" disappears.

◇ Monitor function during repeater operation

While pushing [MONI], the transceiver receives the repeater input frequency. This function allows you to check whether the other station's signal can be received directly or not.

◇ Subaudible tone

The subaudible tone encoder function availability varies according to transceiver models and versions:

"T" types and U.S.A. version's "non-T" types	The function is built into the transceiver.
"Non-T" types (except U.S.A. versions)	An optional UT-86 TONE SQUELCH UNIT is required. (p. 31)

- ① Select a subaudible tone frequency. (p. 16)
- ② Push [F] + [DUP · T/T.SQL] 1 time.
 - "T" appears.
- ③ To cancel, push [F] + [DUP · T/T.SQL].
 - U.S.A. version's "non-T" type: 1 time.
 - Others: 3 times.

◇ DTMF code ("T" types only)

While pushing [PTT], push a key. While key pushing, transmitting continues without pushing [PTT].

◇ Redial function ("T" types only)

Previously-transmitted DTMF code can be transmitted without pushing all the keys again. While pushing [PTT], push [SCAN].

◇ 1750 Hz tone call (IC-2GXE/ET, IC-4GXE/ET only)

While pushing [PTT], push and hold [DUP] for 1 – 2 sec.

6

ADVANCED REPEATER OPERATION

Auto repeater

Using SET mode

(U.S.A. version only)

When the operating frequency is within the repeater frequency range, this function activates repeater settings.

- ① Select VFO mode.
- ② Push and hold [H/L] to enter SET mode.
 - 3 beep tones may sound.
- ③ Push [DUP] or [SCAN] several times until "Ar" appears.
- ④ Rotate [DIAL] to select "oFF," "1" or "2."
 - "oFF" : The auto repeater function is cancelled.
 - "1" : Duplex is automatically activated within repeater frequency range below.
 - "2" : Duplex and the subaudible tone encoder are automatically activated within repeater frequency range below.

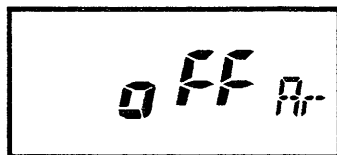

Initial setting before shipping: "oFF"

- ⑤ Push [H/L], [PTT] or [A] · CLR] to set the auto repeater function setting and to exit SET mode.

◇ Frequency range and offset direction

IC-2GXA/AT	IC-4GXA/AT
145.200 – 145.495 : –DUP	442.000 – 444.995 : DUP
146.610 – 146.995 : –DUP	447.000 – 449.995 : –DUP
147.000 – 147.395 : DUP	

Offset frequency

Using SET mode

The difference between the repeater input and output frequencies is called the offset frequency. Select an offset frequency that matches the repeater.

- ① Select VFO mode.
- ② Push and hold [H/L] to enter SET mode.
 - 3 beep tones may sound.
- ③ Push [DUP] or [SCAN] several times until "OW" appears.
- ④ Rotate [DIAL] to select the offset frequency.
 - Selectable frequency step is the same as the tuning step. (p.10)
 - To change in 100 kHz steps, while pushing [F], rotate [DIAL].

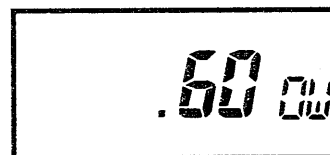

- ⑤ Push [H/L], [PTT] or [A] · CLR] to set the offset frequency and to exit SET mode.

◇ Repeater input and output frequencies

When "DUP" appears:

Input frequency = Output frequency + Offset frequency

When "–DUP" appears:

Input frequency = Output frequency – Offset frequency

■ Subaudible tone frequency Using SET mode

Select a subaudible tone frequency that matches with the repeater.

For “non-T” types, except for the U.S.A version, an optional UT-86 TONE SQUELCH UNIT is required. (p. 31)

- ① Select VFO mode.
- ② Push and hold [H/L] to enter SET mode.
 - 3 beeps may sound.
- ③ Push [DUP] or [SCAN] several times until “TO” appears.
- ④ Rotate [DIAL] to select the subaudible tone frequency.

• Subaudible tone frequency list

87.0	85.4	103.5	127.3	158.7	192.8	241.8
71.9	88.5	107.2	131.8	162.2	203.5	250.3
74.4	91.5	110.9	136.5	167.9	210.7	
77.0	94.8	114.8	141.3	173.8	218.1	
79.7	97.4	118.8	146.2	179.9	225.7	
82.5	100.0	123.0	151.4	186.2	233.6	

Unit: Hz



Initial setting before shipping: 88.5 Hz

- ⑤ Push [H/L], [PTT] or [A] • CLR] to set the subaudible tone frequency and to exit SET mode.

■ Tone scan operation

By receiving another station’s signal, the tone scan detects the subaudible tone frequency that is required for accessing. The tone scan requires the tone squelch function. Refer to p. 27 “Function availability.”

- ① If “C SQL” or “PGR” appears, push [F] + [⑤ • PGR/c SQL] 1 or 2 times to cancel them.
- ② Select VFO mode.
- ③ Set to the repeater input frequency to check the subaudible tone frequency.
- ④ Push [F] + [DUP • T/T.SQL] 3 times to activate the tone squelch function.
- ⑤ Push and hold [SCAN] to start the tone scan.
 - To change the scanning direction, rotate [DIAL].
- ⑥ To cancel the tone scan, push [SCAN] again.
- ⑦ Set to the repeater output frequency.
- ⑧ Push [DUP] to select either “DUP” or “-DUP” offset direction. (p. 14)
- ⑨ Push [F] + [DUP • T/T.SQL] 2 times to activate the subaudible tone encoder. (p. 14)

◇ When the tone frequency is matched:

- The tone scan pauses.
- The subaudible tone frequency setting at left is automatically changed to the matched tone frequency.

DTMF memory programming

The 5 DTMF memory channels are used for auto dialing.

- ① Push [F] + [③ • DTMF] to enter DTMF MEMORY mode.
- ② Rotate [DIAL] to select a DTMF memory channel.
 - Select DTMF memory channel T1, T2, T3 or T4, since T0 is used for redialing. (p. 14)
- ③ Push and hold [H/L].
 - 3 beeps may sound.
- ④ Push keys in sequence for a DTMF code.
 - Up to a 32-digit telephone number, etc. can be memorized.
 - On the function display, "E" and "F" stand for "*" and "#."
- ⑤ Push [H/L] to set the DTMF code.
 - 1 beep may sound.
- ⑥ Push [A • CLR] to return to previous operating mode.



DTMF memory transmitting

- ① Push [F] + [③ • DTMF].
- ② Rotate [DIAL] to select a DTMF memory channel.
- ③ Push [A • CLR] to return to previous operating mode.
- ④ While pushing [PTT], push [SCAN] to transmit.

◇ DTMF speed

If DTMF speed is too fast to control a repeater, etc., a slower speed is available. (p. 29)

[Example] Programming "21ABC38" into DTMF memory channel T4.

Push  + 

to select DTMF MEMORY mode.

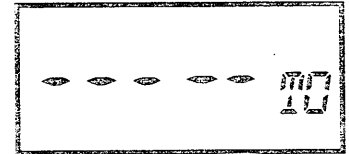

Rotate





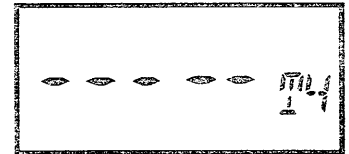



to select DTMF memory channel T4.





Push and hold 

 *Beep*
 *Beep*
3 beeps may sound.

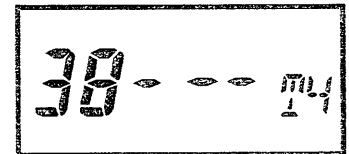

Push    
  



Push 

 *Beep*
1 beep may sound.



Push  to exit to previous operating mode.

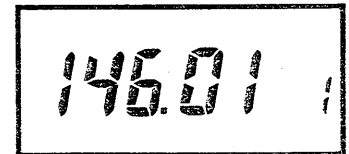

Call channel recall

A call channel stores a most-often used frequency.

- ① Push [V/M/C] 2 times to select the call channel.

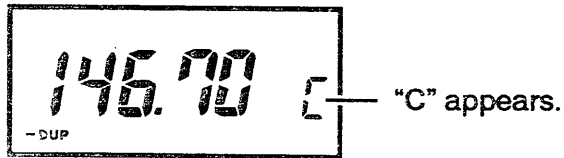

- ② Push [V/M/C] 1 time to exit to VFO mode.

Call channel programming

- ① Select VFO mode.
- ② Set the frequency, etc. to be programmed.
- ③ Push [V/M/C] 2 times to select the call channel.
- ④ Push and hold [F] + [V/M/C • MW/M ▶ V] to program.
 - 3 beeps may sound.
 - The call channel is automatically selected.

◇ Programmable contents

In step ② above, select the following settings, if required:

- Offset direction (p. 14)
- Offset frequency (p. 15)
- Subaudible tone encoder or tone squelch (pgs. 14, 27)
- Subaudible tone frequency (p. 16)

[Example] Programming 146.70 MHz with “-DUP” into the call channel.

Rotate



to select 146.70 MHz.



T/T.SQ

Push **DUP** 1 time
to select “-DUP.”

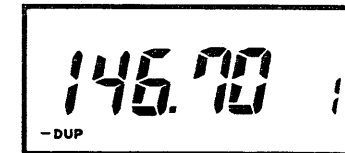

For the U.S.A. version, if the auto repeater function is in use, “-DUP” or “DUP” automatically appears within repeater frequency range. (p. 15)

MW/M ▶ V

Push **V/M/C** 2 times
to select the call channel.

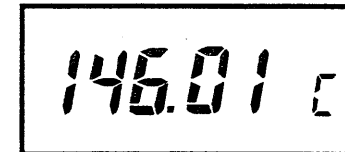

Push and hold



+

MW/M ▶ V
V/M/C

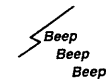

3 beeps may sound.

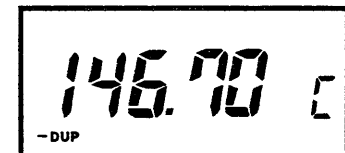

Memory channel selection

40 memory channels with a restrict function are available. In this way, you can restrict available memory channel numbers to a selected group only, providing quick channel access. (p. 30)

- ① Push [V/M/C] 1 time to select MEMORY mode.

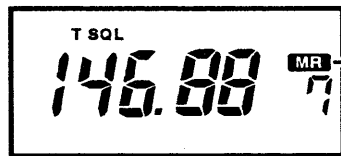

"MR" appears.

- ② Rotate [DIAL] to select a memory channel.



- ③ Push [V/M/C] 2 times to return to VFO mode.
• "MR" disappears.

◇ Selection via the keyboard ("T" types only)

- [# · ▲] and [# · ▼] select a memory channel.
- Each digit key selects the 1's digit.

[Example]

To change memory channel 7 to 15, push [9], [# · ▲] then [5].

Memory channel programming

- ① Push [V/M/C] 1 time to select MEMORY mode.
 - "MR" appears.
- ② Rotate [DIAL] to select a memory channel.
- ③ Push [V/M/C] 2 times to return to VFO mode.
- ④ Select the desired frequency, etc. to be programmed.
- ⑤ Push and hold [F] + [V/M/C · MW/M▶v] to program.
 - 3 beeps may sound.

◇ Programmable contents

In step ④ above, select the following settings, if required:

- Offset direction (p. 14)
- Offset frequency (p. 15)
- Subaudible tone encoder or tone squelch (pgs. 14, 27)
- Subaudible tone frequency (p. 16)

Each memory channel stores settings above independently.

◇ Dial select step function for memory channel number

Using the dial select step function, memory channel number is selectable in VFO mode. This is convenient to program 2 or more memory channels. (p. 10)

Frequency transferring

Memory channel contents can be transferred into the VFO.

- ① Push [V/M/C] 1 time to select MEMORY mode.
 - "MR" appears.
- ② Rotate [DIAL] to select a memory channel.
- ③ Push and hold [F] + [V/M/C • MW/M▶V] to transfer the memory channel contents into the VFO.
 - 3 beeps may sound.
 - VFO mode is automatically selected.

[Example] Transferring memory channel 15 contents into the VFO.

MW/M▶V
Push [V/M/C] 1 time
to select MEMORY mode.

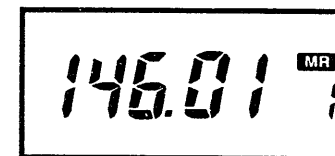

Rotate [DIAL] to select memory channel 15.

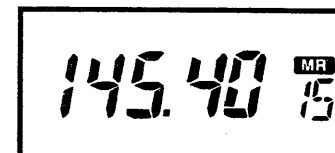

Push and hold [F] + [V/M/C • MW/M▶V] 3 beeps may sound.

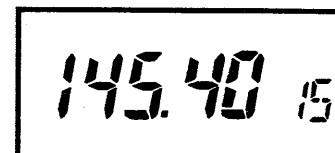

[Example] Programming 145.40 MHz into memory channel 15.

MW/M▶V
Push [V/M/C] 1 time
to select MEMORY mode.

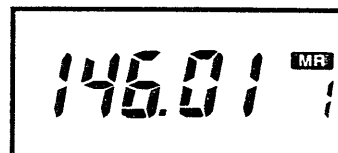

Rotate [DIAL] to select memory channel 15.

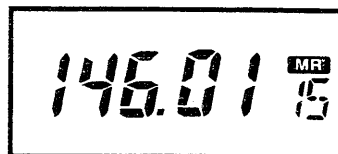

MW/M▶V
Push [V/M/C] 2 times
to select VFO mode.

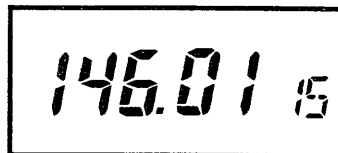

Rotate [DIAL] to select 145.40 MHz.

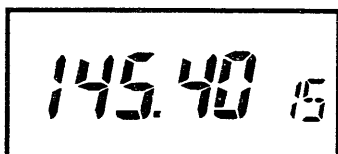

Push and hold [F] + [V/M/C • MW/M▶V] 3 beeps may sound.

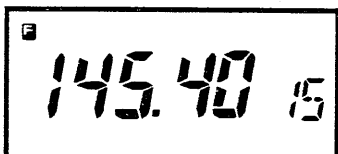

MW/M▶V
Push [V/M/C] 1 time to confirm the memory channel contents.

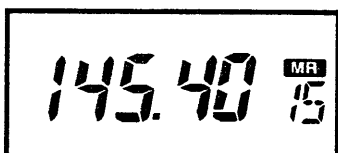

■ Scan types

◇ Programmed scan

Repeatedly scans frequencies between 2 specified frequencies in scan edge channels PA and PB. This is convenient when searching for signals over a specified range.

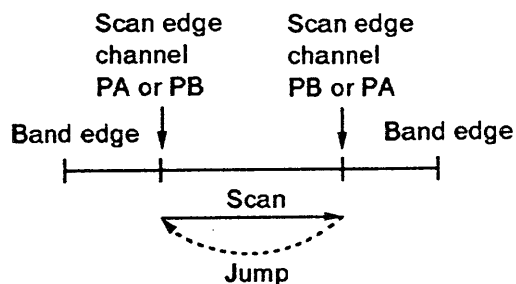

◇ Memory scan

Repeatedly scans memory channels sequentially. This is convenient when searching only for desired frequencies.

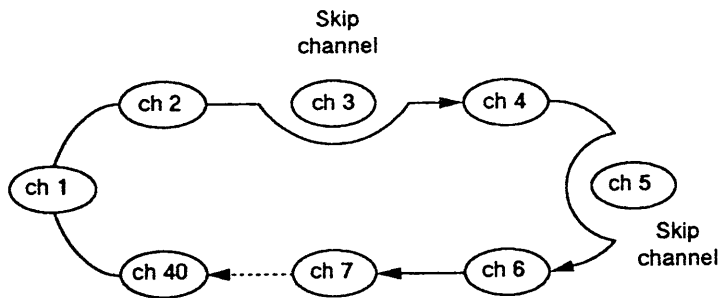

- Skip channels are skipped. (p. 22)

- By restricting memory channel numbers, memory scan interval can be sped up. (p. 30)

■ Programmed scan operation

- ① If "C SQL" or "PGR" appears for "T" types, push [F] + [5 • PGR/c SQL] 1 or 2 times to cancel them.
- ② Program scan edge frequencies into scan edge channels PA and PB in advance. (p. 19)
- ③ Select VFO mode.
- ④ Push [SCAN] to start programmed scan.
 - Frequency changes according to selected tuning step. (p. 10)
- ⑤ To cancel programmed scan, push [SCAN] again.

■ Memory scan operation

- ① If "C SQL" or "PGR" appears for "T" types, push [F] + [5 • PGR/c SQL] 1 or 2 times to cancel them.
- ② Program each memory channel in advance. (p. 19)
- ③ Select MEMORY mode.
- ④ Push [SCAN] to start memory scan.
- ⑤ To cancel memory scan, push [SCAN] again.

◇ While scanning

- "SC" appears
- The decimal point blinks.
- To change the scanning direction, rotate [DIAL].

◇ **When a signal is received:**

- Scan pauses on the frequency.
- While pausing, scan resumes 5 sec. after the signal disappears. The scan resume condition can be changed, if required. Refer to right.
- To resume the scan manually, rotate [DIAL].

■ **Skip channel setting**

Memory channels that you do not wish to scan can be specified as skip channels. This is useful to speed up the memory scan interval.

- ① Select a memory channel to be set as a skip channel. (p. 19)
- ② Push [F] + [SCAN • SEL] to set the memory channel as a skip channel.

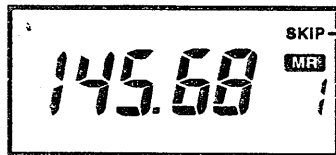

"SKIP" appears.

- ③ Repeat step ② to cancel skip channel setting.

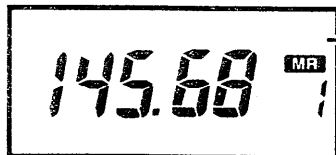

"SKIP" disappears.

■ **Scan resume condition**

Using *SET mode*

The resume condition can be selected as timer 5 sec. or pause 2 sec., if required.

- ① Select VFO mode.
- ② Push and hold [H/L] to enter SET mode.
 - 3 beeps may sound.
- ③ Push [DUP] or [SCAN] several times until "SC" appears.
- ④ Rotate [DIAL] to select "t-5" or "P-2."
 - "t-5" : Timer 5 sec. When receiving a signal, scan resumes after 5 sec.
 - "P-2" : Pause 2 sec. Scan pauses until the signal disappears and then resumes 2 sec. after that.



Initial setting before shipping: "t-5"

- ⑤ Push [H/L], [PTT] or [A • CLR] to set the scan resume condition and exit SET mode.

◇ **When "P-2" is selected:**

During programmed scan or memory scan, "B" appears.

Function availability

"T" types	An optional UT-49 DTMF DECODER UNIT is required. (p. 31)
"Non-T" types	Not available.

◇ To avoid interference to other stations

DO NOT transmit while the transmit/receive indicator lights up in green. Otherwise, your signal will interfere with other stations. Before calling a waiting station, push and hold [MONI] to listen on the frequency.

What is the pager function?

This function uses DTMF codes for paging and can be used as a "message pager" to inform you of a caller's identity even if you leave the transceiver temporarily unattended.

Personal calls and group calls are available with the pager function. Personal calls use the receiving parties' ID code for calling. The receiving parties' display shows your ID code and other stations in the party know that you called. You can also call all stations in your group using the group call.

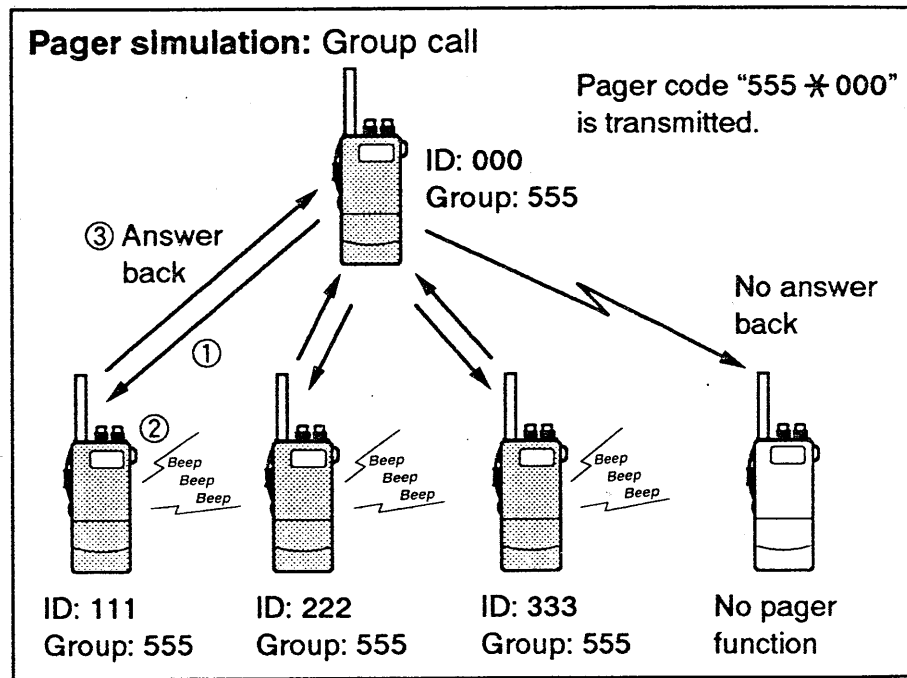
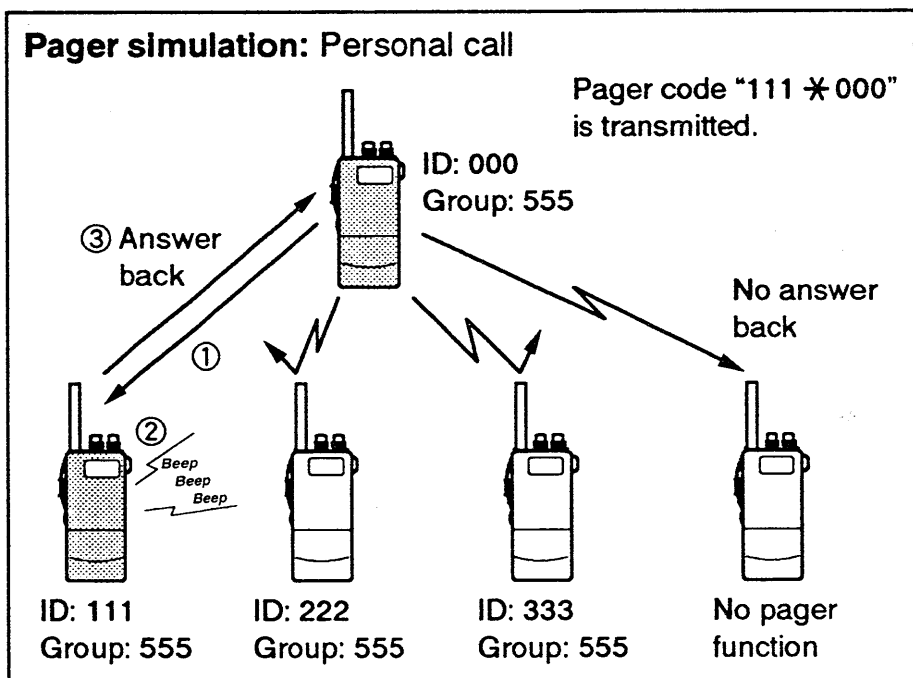

Code channels

◇ Before programming

The pager and code squelch functions require ID codes and a group code. These codes are 3-digit DTMF codes and must be written into the code channels before operation.

◇ Code channel assignment

ID or group code	Code channel number	"Receive accept" or "receive inhibit"
Your ID code	C0	"Receive accept" only.
Other parties' ID code	C1–C5	"Receive inhibit" should be programmed in each channel.
Group code	One of C1–C5	"Receive accept" must be programmed.
Memory space*	CP	"Receive inhibit" only.

* Channel CP automatically memorizes an ID code when receiving a pager call. The contents in channel CP cannot be changed manually.

"Receive accept" or "receive inhibit"

Code channels C1–C5 should be effectively programmed as "receive accept" or "receive inhibit."

- "Receive accept"
"SKIP" disappears. Accepts pager calls when the transceiver receives a signal with a code the same as that in the code channel.
- "Receive inhibit"
"SKIP" appears. Rejects calls even when the transceiver receives a signal with a code the same as that in the code channel.

[Example]

The code channel that stores the group code should be programmed as "receive accept." If the channel is programmed as "receive inhibit," you cannot receive group calls.

The code channels that store other parties' ID codes for a transmit code should be programmed as "receive inhibit." If the channels are programmed as "receive accept," personal calls for parties other than yours are received.

11 PAGER AND CODE SQUELCH (optional for "T" types only)

■ Code programming

- ① Push [F] + [⑤ • CODE] to select the setting display.
- ② Rotate [DIAL] to select a code channel C0–C5.
 - Code channel CP cannot be used for programming.
- ③ Push the digit keys to enter a 3-digit code.
 - When a digit is mistakenly input, push [A • CLR], then input again.



The display shows code channel C0 is programmed for 111.

- ④ Push [F] + [SCAN • SEL] to specify the code channels as "receive inhibit" or "receive accept." (p. 24)
 - When "receive inhibit" is specified, "SKIP" appears.
- ⑤ Push [PTT] to exit the setting display.

■ Pager operation

◇ Calling a specific station

- ① Set the operating frequency.
- ② Push [F] + [② • PGR/C SQL] 1 time.
 - "PGR" appears.
- ③ Push [F] + [⑤ • CODE].
 - **DO NOT** push digit keys while a code channel appears, since code channel contents are changed.

- ④ Rotate [DIAL] to select a code channel.
- ⑤ Push [PTT] to transmit the pager code.
- ⑥ Wait for an answer back.
 - When an answer back code is received, the other party's ID or group code appears.
- ⑦ After confirming a connection, push [PTT] to display the operating frequency.
- ⑧ Push [F] + [② • PGR/C SQL] 1 time to activate the code squelch function or 2 times to cancel the pager function.

◇ Waiting for a call from a specific station

- ① Set the operating frequency.
- ② Push [F] + [② • PGR/C SQL] 1 time.
 - "PGR" appears.
- ③ Wait for an answer back.
 - When receiving a call, other party's ID or group code appears.
- ④ Push [PTT] to send an answer back call.
 - The operating frequency appears.
- ⑤ Push [F] + [② • PGR/C SQL] 1 time to activate the code squelch function or 2 times to cancel the pager function.

Personal call

When you are called with your ID code and the calling station's ID code is 386.



Group call

When you are called with the group code, 123, and 123 is programmed into code channel C5.



Error Information

When the transceiver receives an incomplete signal, "E" appears.



Code squelch operation

The code squelch allows you communication with silent standby since the transceiver receives calls only from stations which know your ID or group code.

Code squelch simulation: ID code

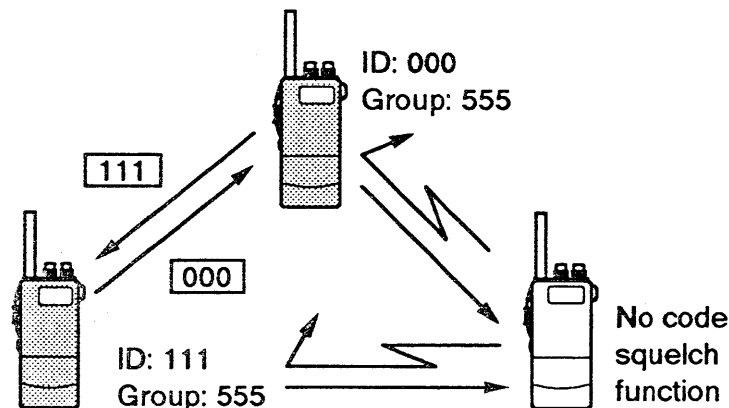

- ① Set the operating frequency.
- ② Push [F] + [② • PGR/C SQL] 2 times.
 - "C SQL" appears.
- ③ Push [F] + [⑤ • CODE].
- ④ Rotate [DIAL] to select a code channel.
- ⑤ Operate the transceiver in the normal way.
 - Prior to voice transmission, a 3-digit code is transmitted to open the receiving station's code squelch.
- ⑥ To cancel the code squelch, push [F] + [② • PGR/C SQL] 1 time.

Function availability

U.S.A. version's "non-T" types	Not available.
"Non-T" types (except U.S.A. versions)	An optional UT-86 TONE SQUELCH UNIT is required. (p. 31)
"T" types	Built into the transceiver.

◇ Through a repeater

Pocket beep and tone squelch functions may not be effective through some repeaters that filter out subaudible tone frequencies.

Pocket beep operation

This function uses a subaudible tone for calling, and informs if you are called using beep tones and "(••)" blinking.

◇ Waiting for a call from another station

- ① If "C SQL" or "PGR" appears, push [F] + [⑤ • PGR/C SQL] 1 or 2 times to cancel them.
- ② Set the operating frequency.
- ③ Program a subaudible tone frequency. (p. 16)
- ④ Push [F] + [DUP • T/T.SQL] 2 times.
 - "T SQL (••)" appears.
 - When a matched subaudible tone frequency is received, the speaker emits beep tones for 30 sec. and "(••)" blinks.

- ⑤ Push [PTT] to answer back or push [Ⓐ • CLR].
 - The beep tones and "(••)" blinking stop, then tone squelch is automatically activated.

◇ Calling a waiting station

A matched subaudible tone frequency with a waiting station is required. Use the tone squelch below.

Tone squelch operation

This function allows you to silently wait for a call from group members that use the same subaudible tone frequency.

- ① Set the operating frequency.
- ② Program the subaudible tone frequency. (p. 16)
- ③ Push [F] + [DUP • T/T.SQL] 3 times.
 - "T SQL" appears.
- ④ Operate the transceiver in the normal way.
 - When a matched subaudible tone frequency is received, the squelch opens.
- ⑤ To cancel the tone squelch function, push [F] + [DUP • T/T.SQL] 1 time.

◇ To avoid interference to other stations

DO NOT transmit while the transmit/receive indicator lights up in green. Otherwise, your signal will interfere with other stations. Before calling a waiting station, push and hold [MONI] to listen on the frequency.

■ Power saver

Using SET mode

During standby, the power saver function reduces the current drain for battery conservation. The power saver duty cycle can be selected, if required. For packet radio operation, the power saver can be cancelled.

- ① Select VFO mode.
- ② Push and hold [H/L] to enter SET mode.
 - 3 beeps may sound.
- ③ Push [DUP] or [SCAN] several times until "PD" appears.
- ④ Rotate [DIAL] to select a duty cycle or cancel the power saver.
 - "1.16" : Circuit ON 125 msec, circuit OFF 2 sec.
 - "1.4" : Circuit ON 125 msec, circuit OFF 500 msec.
 - "oFF" : The power saver is cancelled.

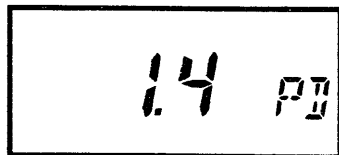

Initial setting before shipping: "1.4"

- ⑤ Push [H/L], [PTT] or [A] • CLR] to set the power saver setting and to exit SET mode.

◇ During pager or code squelch operation

(optional for "T" types only)

Even if "1.16" or "1.4" is selected, the power saver duty cycle becomes circuit ON 125 msec, circuit OFF 125 msec.

■ Lighting timer

Using SET mode

The display lighting has a 5 sec. timer. The display lighting can light up continuously, if required.

- ① Select VFO mode.
- ② Push and hold [H/L] to enter SET mode.
 - 3 beeps may sound.
- ③ Push [DUP] or [SCAN] several times until "LI" appears.
- ④ Rotate [DIAL] to select "5" or "on."
 - "5" : Lights up with 5 sec. timer.
 - "on" : Lights up continuously until [LIGHT] is pushed again.

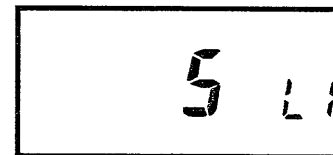

Initial setting before shipping: "5"

- ⑤ Push [H/L], [PTT] or [A] • CLR] to set lighting timer setting and to exit SET mode.

◇ While "on" is selected

- ① Push [LIGHT] to turn the lighting ON.
- ② Push [LIGHT] again to turn the lighting OFF.

To conserve battery power, turn OFF the lighting after reading the function display.

13 OTHER FUNCTIONS

■ Beep tones

Using SET mode

The speaker emits beep tones each time a switch is operated. The beep tone can be cancelled, if required.

- ① Select VFO mode.
- ② Push and hold [H/L] to enter SET mode.
 - 3 beeps may sound.
- ③ Push [DUP] or [SCAN] several times until "BE" appears.
- ④ Rotate [DIAL] to select "on" or "oFF."
 - "on" : The speaker emits beep tones.
 - "oFF" : The speaker does not emit beep tones.

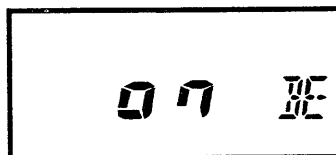

Initial setting before shipping: "on"

- ⑤ Push [H/L], [PTT] or [A] • CLR] to set the beep tone setting and to exit SET mode.

◇ Switch operation and beep tones

The speaker emits beep tones for [DUP • T/T.SQL], [SCAN • SEL], [V/M/C • MW/M▶V], [H/L • LOCK] and the keyboard for "T" types. If an operation is valid, the speaker emits high beep tones. If an operation is not valid, the speaker emits low beep tones.

■ DTMF speed

Using SET mode

("T" types only)

If a repeater etc. cannot be controlled using the redial function and DTMF memory channels, DTMF speed may be too fast. In this case, select a slower speed.

◇ Before setting

This setting is possible only when a DTMF memory channel is programmed. Transmit a DTMF code manually or program a DTMF memory channel in advance. (pgs. 14, 17)

- ① Select VFO mode.
- ② Push and hold [H/L] to enter SET mode.
 - 3 beeps may sound.
- ③ Push [DUP] or [SCAN] several times until "DT" appears.
- ④ Rotate [DIAL] to select a DTMF speed.
 - 100 msec. (5 cps), 200 msec. (2.5 cps), 300 msec. (1.6 cps) and 500 msec. (1 cps) are available. (cps=characters/sec.)



Initial setting before shipping: 100 msec.

- ⑤ Push [H/L], [PTT] or [A] • CLR] to set the DTMF speed and to exit SET mode.

■ Channel number restriction

Using *SET mode*

The usable memory channel number can be restricted, if required. This function is convenient for example:

- to select memory channels quickly.
- to speed up memory scan interval.
- in combination with the channel number indication.

- ① Select VFO mode.
- ② Push and hold [H/L] to enter SET mode.
 - 3 beeps may sound.
- ③ Push [DUP] or [SCAN] several times until "CH" appears.
- ④ Rotate [DIAL] to select "1" – "40."



*Initial setting before shipping: "40."

- ⑤ Push [H/L], [PTT] or [A] • CLR to set channel number restriction setting and exit to VFO mode.
- ⑥ To revive all memory channels, repeat steps ① – ③, and select "40" in step ④.

◇ Restricted memory channels

- Cannot be selected.
- Are not scanned during the memory scan.

■ Channel number indication

Operation can be restricted using memory channels only, and operating frequencies can be hidden, if required. This function is convenient for example:

- to keep your operating frequency secret.
- to restrict operating frequencies.

- ① Program required memory channels. (pgs 19, 20)
- ② Turn the power OFF.
- ③ While pushing [F] + [H/L] + [SCAN] + [V/M/C], turn the power ON.
 - Only a memory channel number appears.

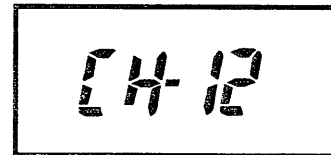

- ④ To indicate operating frequency, repeat steps ② and ③ again.

◇ Restricted functions during channel number indication

- [V/M/C] cannot be used.
- MEMORY mode operation only.
- Partial resetting (p. 33) cannot be performed.

14 OPTIONAL UNIT INSTALLATION

◇ Usable optional units

-“Non-T” types except for the U.S.A version: The UT-86 TONE SQUELCH UNIT can be installed.

-“T” types: The UT-49 DTMF DECODER UNIT can be installed.

- ① Turn the power OFF, then remove the battery pack.
- ② Unscrew 5 screws, then remove the bottom plate.

CAUTION:

Use a Phillips screw driver that matches the screw size. Otherwise, you may strip the screw head.

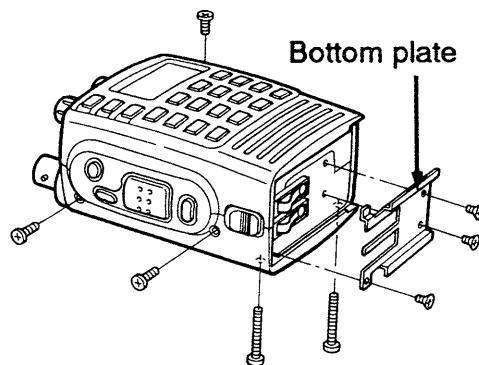

- ③ Carefully open the front and rear panels.

DO NOT lose the battery pack release button.

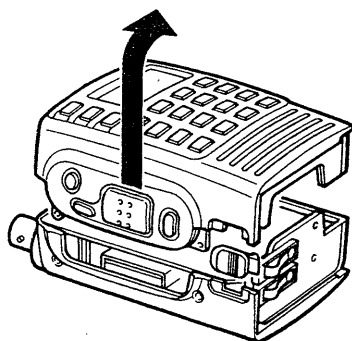

- ④ Plug in either UT-86 or UT-49.

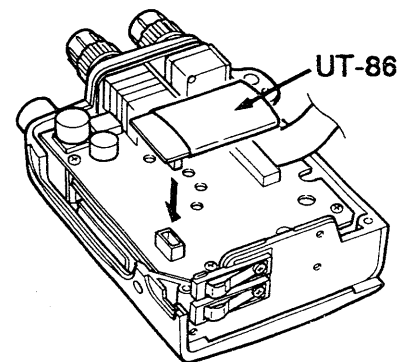

“Non-T” types except for the U.S.A. version

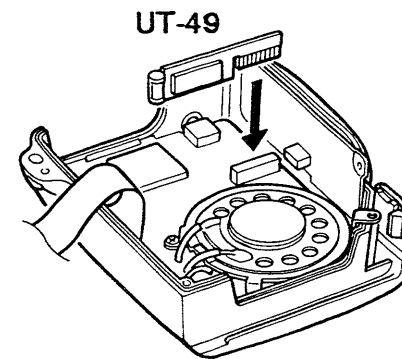

“T” types

- ⑤ Reassemble the front panel.
- ⑥ Reassemble the bottom plate.
 - Be sure the center prong is inserted into the ridge of the battery pack release button.

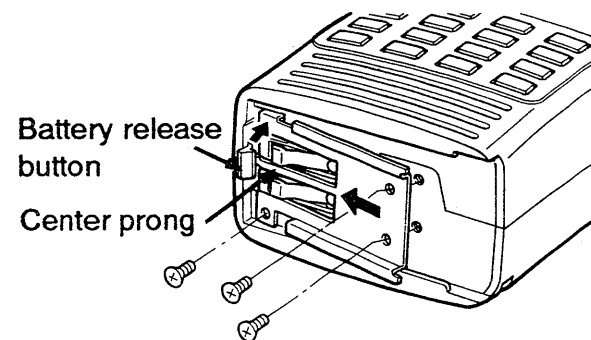

MODE ARRANGEMENT CHART 15

ENGLISH

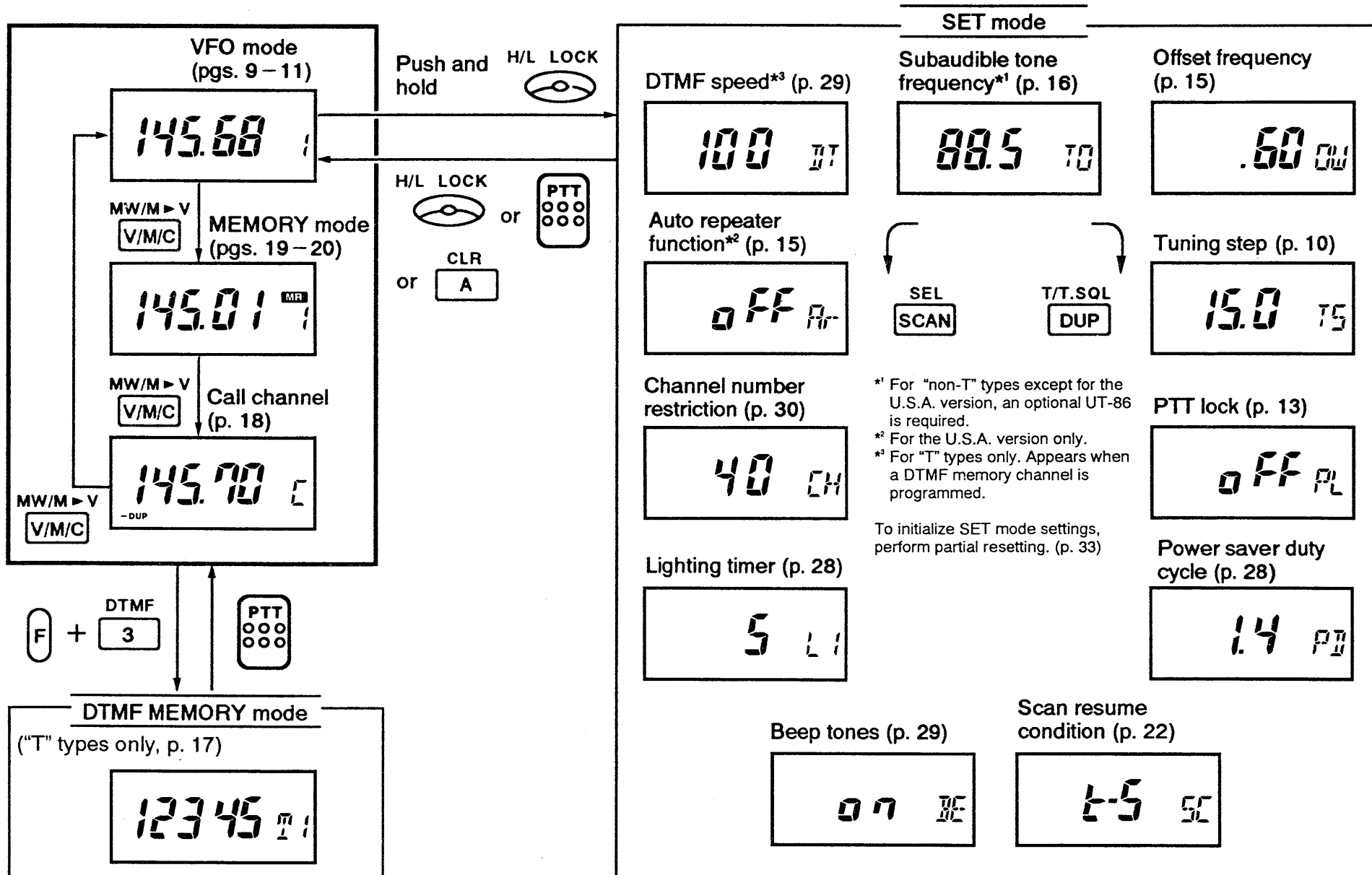

16 TROUBLESHOOTING

Problem	Possible cause	Solution	Ref.
<ul style="list-style-type: none"> No power comes ON. 	<ul style="list-style-type: none"> The batteries are exhausted. Poor plug contact to the external DC power cable. 	<ul style="list-style-type: none"> Charge the battery pack or place new dry cell batteries in the battery case. Check the connector or remove and replace the cable. 	pgs. 6, 7 —
<ul style="list-style-type: none"> No sound comes from the speaker. 	<ul style="list-style-type: none"> [SQL] is turned too far clockwise. An optional speaker-microphone or earphone is connected. The tone squelch or pocket beep is in use. 	<ul style="list-style-type: none"> Rotate [SQL] counterclockwise. Disconnect the speaker-microphone or earphone. Push [F] + [DUP · T/T.SQL] 1 or 2 times until "T SQL" or "T SQL ((•))" disappears. 	p. 12 — p. 27
<ul style="list-style-type: none"> Frequency cannot be set. 	<ul style="list-style-type: none"> The lock function is activated. The call channel or MEMORY mode is selected. 	<ul style="list-style-type: none"> Push [F] + [H/L · Lock] to cancel the lock function. Push [V/M/C] to select VFO mode. 	p. 10 p. 9
<ul style="list-style-type: none"> Some memory channels cannot be used. 	<ul style="list-style-type: none"> The usable memory channel number is restricted. 	<ul style="list-style-type: none"> Using SET mode, cancel the memory channel number restriction. 	p. 30
<ul style="list-style-type: none"> Repeater cannot be accessed. 	<ul style="list-style-type: none"> Wrong offset frequency is selected. Wrong subaudible tone frequency is selected. 	<ul style="list-style-type: none"> Correct the offset frequency. Correct the subaudible tone frequency. 	p. 15 p. 16
<ul style="list-style-type: none"> Scan cannot be started. 	<ul style="list-style-type: none"> The call channel is selected. The squelch is open. 	<ul style="list-style-type: none"> Push [V/M/C] to select VFO or MEMORY mode. Rotate [SQL] clockwise. 	p. 21 —

◇ Partial resetting

Partial resetting initializes VFO and SET mode settings only. All memory channels and the call channel contents remain unchanged. To perform partial resetting, while pushing [F] + [H/L], turn the power ON.

◇ Total resetting

CAUTION: Total resetting clears and initializes VFO, SET mode settings, all memory channels and the call channel. Only when the internal CPU malfunctions, while pushing [F] + [H/L] + [DUP] + [V/M/C] turn the power ON.

SPECIFICATIONS 17

ENGLISH

		IC-2GXAT/ET IC-2GXA/E	IC-4GXAT/ET IC-4GXA/E
Frequency coverage	U.S.A.	144–148 MHz	440–450 MHz
	Australia	144–148 MHz	430–440 MHz
	Asia	Tx: 144–148 MHz Rx: 140–150 MHz*	430–440 MHz
	Europe U.K. Thailand	144–146 MHz	430–440 MHz
	Italy	Tx: 144–148 MHz Rx: 136–174 MHz*	430–440 MHz
	Denmark	144–146 MHz	432–438 MHz
		*Specifications guaranteed 144–148 MHz.	
Tuning steps		5, 10, 12.5, 15, 20, 25, 30 or 50 kHz	
Dial select steps		100 kHz or 1 MHz	
Antenna impedance		50 Ω (nominal)	
Usable battery		BP-130A, BP-157A, BP-160, BP-174	
External DC power		6–16 V DC (negative ground)	
Current drain (at 13.5 V, typical)	Transmit	High 2.0 A Low 0.9 A	High 1.8 A Low 0.9 A
	Receive	Rated audio 250 mA Power saved Avg. 35 mA	
Usable temperature range		– 10 °C to + 60 °C + 14 °F to + 140 °F	
Frequency stability		± 5 ppm (0 °C to 50 °C)	
Dimensions (with BP-160 or BP-130A)		57(W) × 125(H) × 35(D) mm 2.2(W) × 4.9(H) × 1.4(D) in (projections not included)	

		IC-2GXAT/ET IC-2GXA/E	IC-4GXAT/ET IC-4GXA/E
General	Weight (with flexible antenna)	"T" types	355 g; 12.5 oz (with BP-160) 340 g; 12.0 oz (with BP-130A and cells)
		"Non-T" types	365 g; 12.9 oz (with BP-160) 350 g; 12.3 oz (with BP-130A and cells)
Transmitter	Approx. output power*	13.5 V	High: 7 W Low: 1 W
		7.2 V	High: 2.5 W Low: 1 W
	Max. freq. deviation*	± 5 kHz	
	Spurious emissions*	Less than – 60 dB	
	Microphone impedance	1 kΩ	
Receiver	Receive system		Double-conversion superheterodyne
	Intermediate frequencies	1st	21.7 MHz
		2nd	455 kHz
	Sensitivity*		Less than 0.18 μV (for 12 dB SINAD)
	Squelch sensitivity		Less than 0.16 μV (at threshold)
Selectivity		More than 15 kHz/ – 6 dB Less than 30 kHz/ – 60 dB	
Spurious and image rejection ratio*		More than 60 dB	
Audio output power* (at 13.5 V)		More than 300 mW (at 10% distortion with an 8 Ω load)	
Audio out impedance		8 Ω	

* Specifications guaranteed at a transceiver temperature of +25°C (+77°F).

All stated specifications are subject to change without notice or obligation.

18 OPTIONS

◇ Battery packs and chargers

Battery pack	Height	Voltage	Capacity	Carrying case	
				"Non-T" types	"T" types
BP-130A	50 mm, 2.0 in	Battery case R6 (AA) size × 6		LC-118	LC-116
BP-157A	50 mm, 2.0 in	7.2 V	900 mAh	LC-118	LC-116
BP-160	50 mm, 2.0 in	7.2 V	700 mAh	LC-118	LC-116
BP-174	78.2 mm, 3.1 in	12.0 V	600 mAh	LC-119	LC-117

CP-13/L
CIGARETTE LIGHTER
CABLE WITH NOISE FILTER
For operation and charging
with a 12 V cigarette lighter
socket.

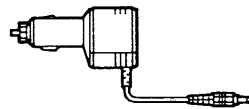

- CP-13:
straight plug
- CP-13L:
"L"-shaped plug

OPC-288/L
DC POWER CABLE
For operation and charging
with an external DC power
supply.

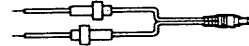

- OPC-288:
straight plug
- OPC-288L:
"L"-shaped plug

BC-77 or BC-105
WALL CHARGER
Regularly charges a battery
pack.

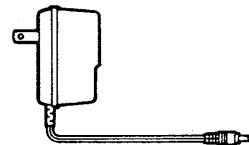

AD-25
BATTERY CHARGE
ADAPTER

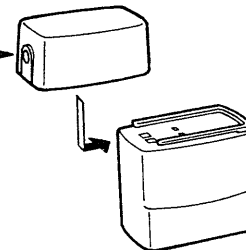

- BP-157A, BP-160 or
BP-174
- Ni-Cd batteries in
BP-130A

Approx. charging period
- BP-130A, BP-157A,
BP-160: 15 hrs.
- BP-174: 20 hrs.

BC-79 DESKTOP CHARGER + AD-28 BATTERY PACK ADAPTER

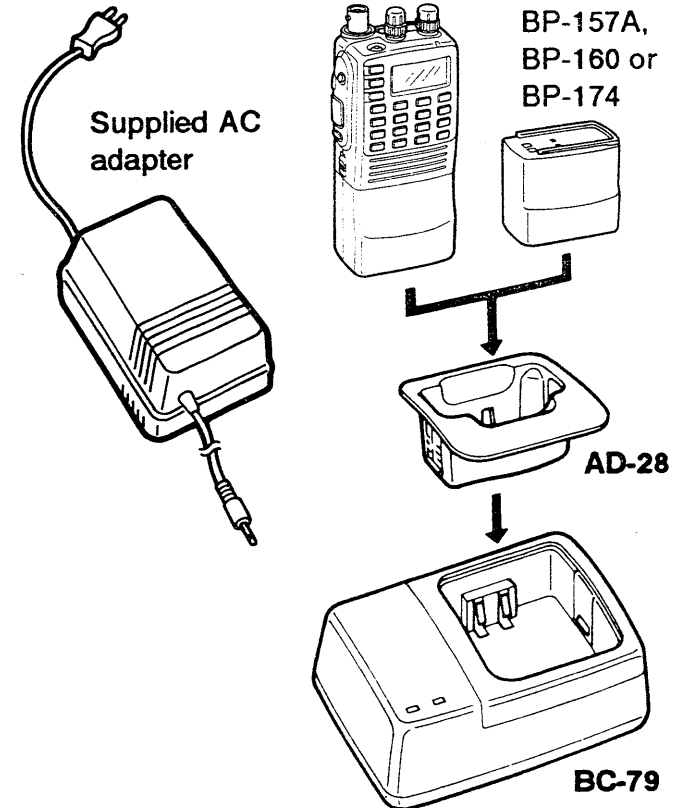

- Approx. charging period
 - BP-157A, BP-160 : 1 hr.
 - BP-174: 1.5 hrs.
- An AC adapter is packed with the BC-79.
- The CP-13/L or OPC-288/L can be used
instead of the supplied AC adapter.

◆ **Speaker-microphones and headset**

HM-46 SPEAKER-MICROPHONE
Compact and lightweight.

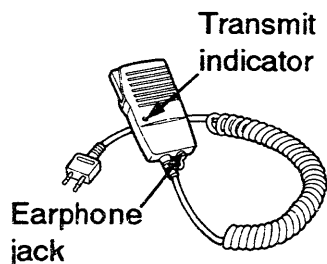

HM-54 SPEAKER-MICROPHONE
Durable and full-sized.

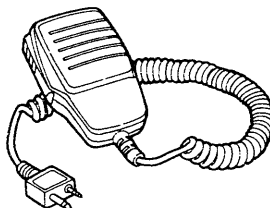

HM-55/A DTMF SPEAKER-MICROPHONE

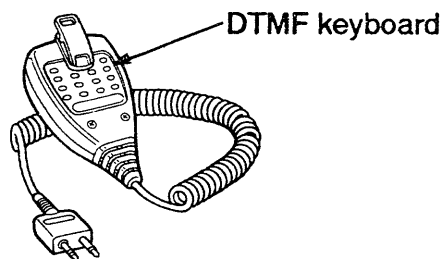

HS-51 HEADSET
Allows you hands-free operation. Includes a VOX, PTT switch and "one-touch" PTT (time-out-timer).

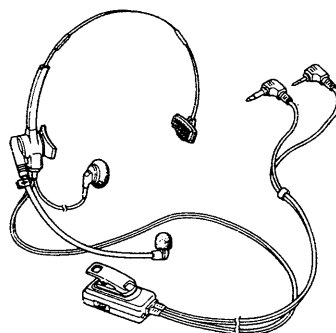

MB-30 MOUNTING BRACKET
Mounts the transceiver on a vehicle or on a wall.

When using the bracket hanger

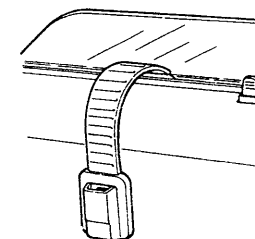

When using no bracket hanger

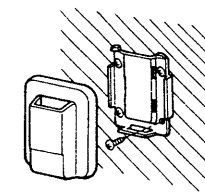

FA-B2A 144 MHz FLEXIBLE ANTENNA
The same type as supplied with the transceiver.

SP-13 EARPHONE
Provides clear receive audio in noisy environments.

UT-49 DTMF DECODER UNIT
Provides pager and code squelch functions for "T" types.

UT-86 TONE SQUELCH UNIT
Provides subaudible tone encoder, tone squelch, pocket beep and tone scan functions for "non-T" types. Cannot be installed in the U.S.A. version that has a built-in tone encoder.

Count on us!

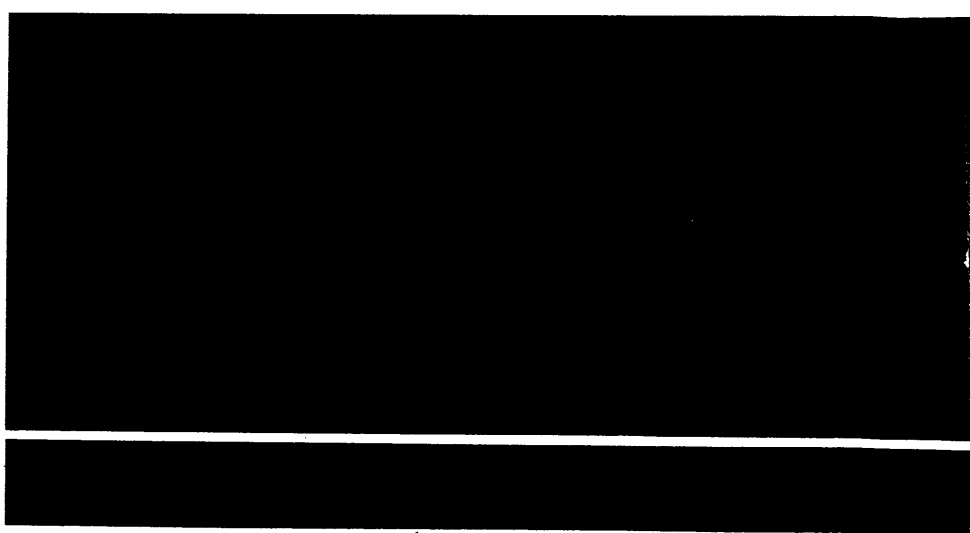

A-5302S-1EX
Printed in Japan
Copyright © 1994 by Icom Inc.

Icom Inc.
6-9-16, Kamihigashi, Hirano-ku, Osaka 547, Japan