

MAIN B UNIT

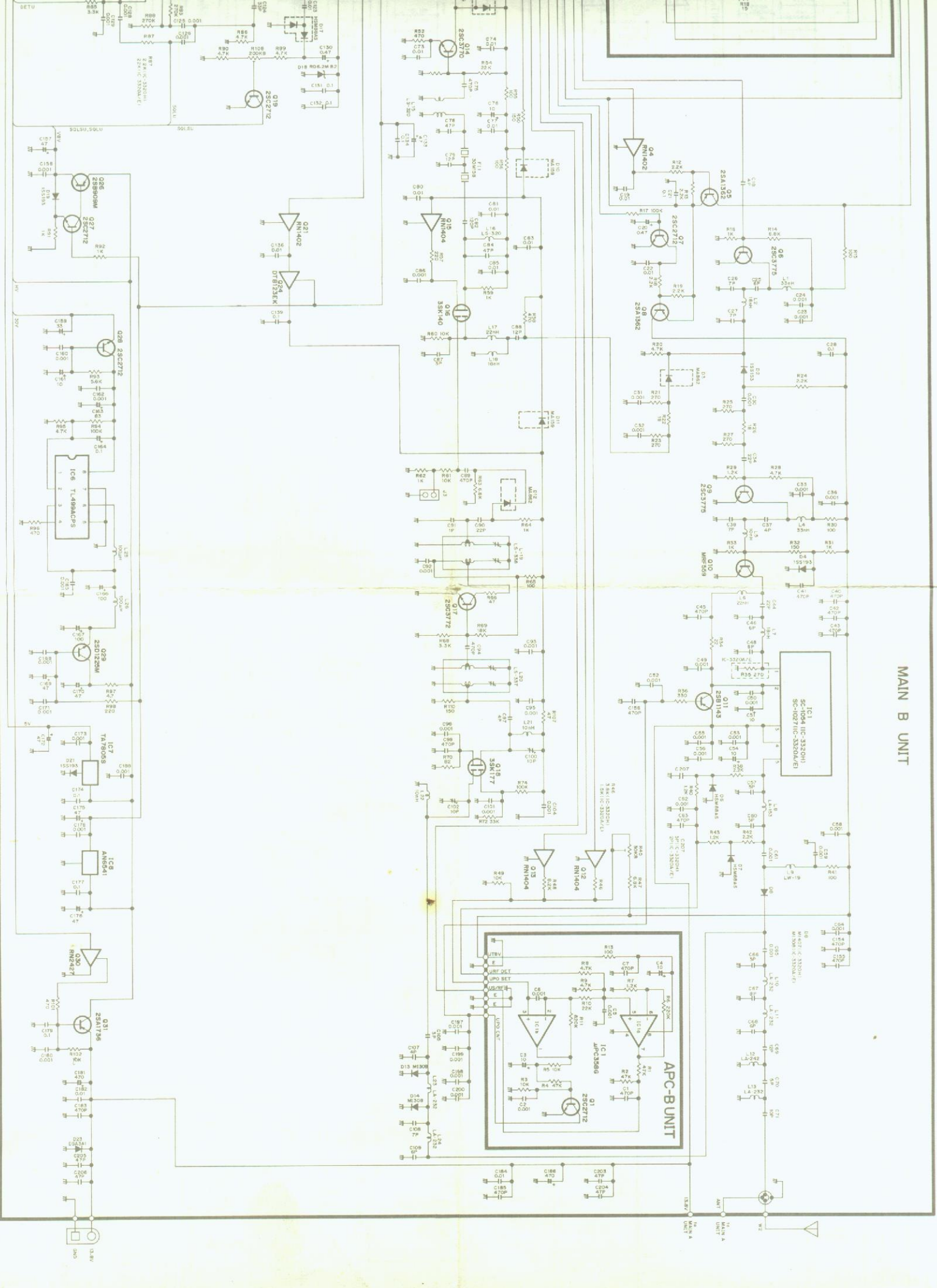

SERIAL PIN AT REAR OF IC-3220H } DATA
 118000 - 135995 R x AM.
 136000 - 174000 FM TX Y
 440000 - 474000 FM TX Y

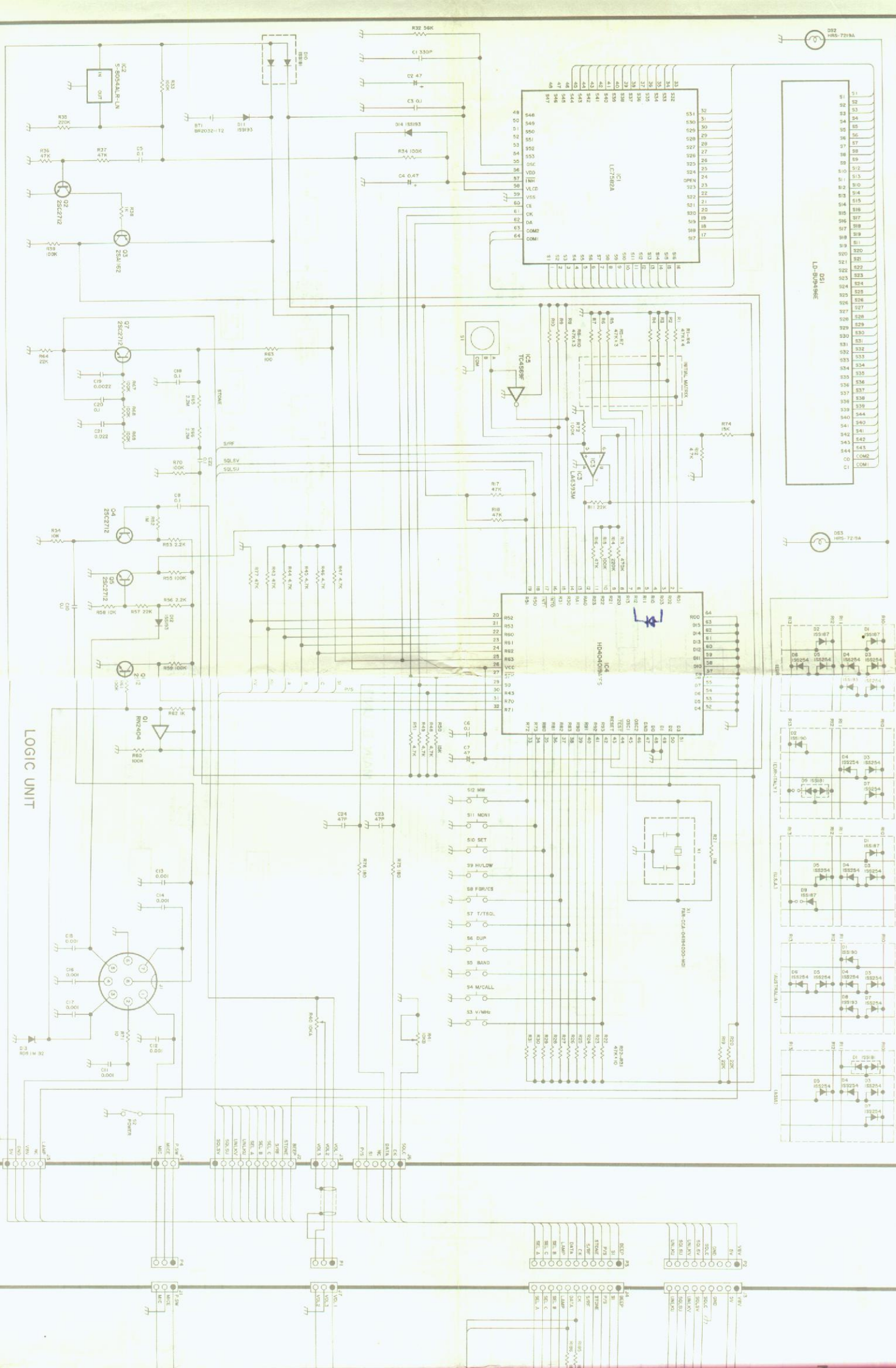

AM. TX 32X

MAIN A UNIT

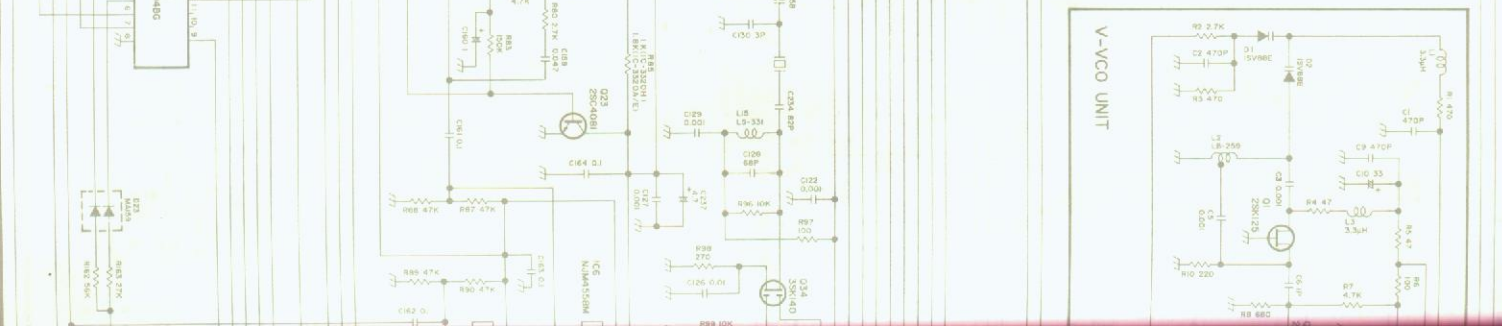
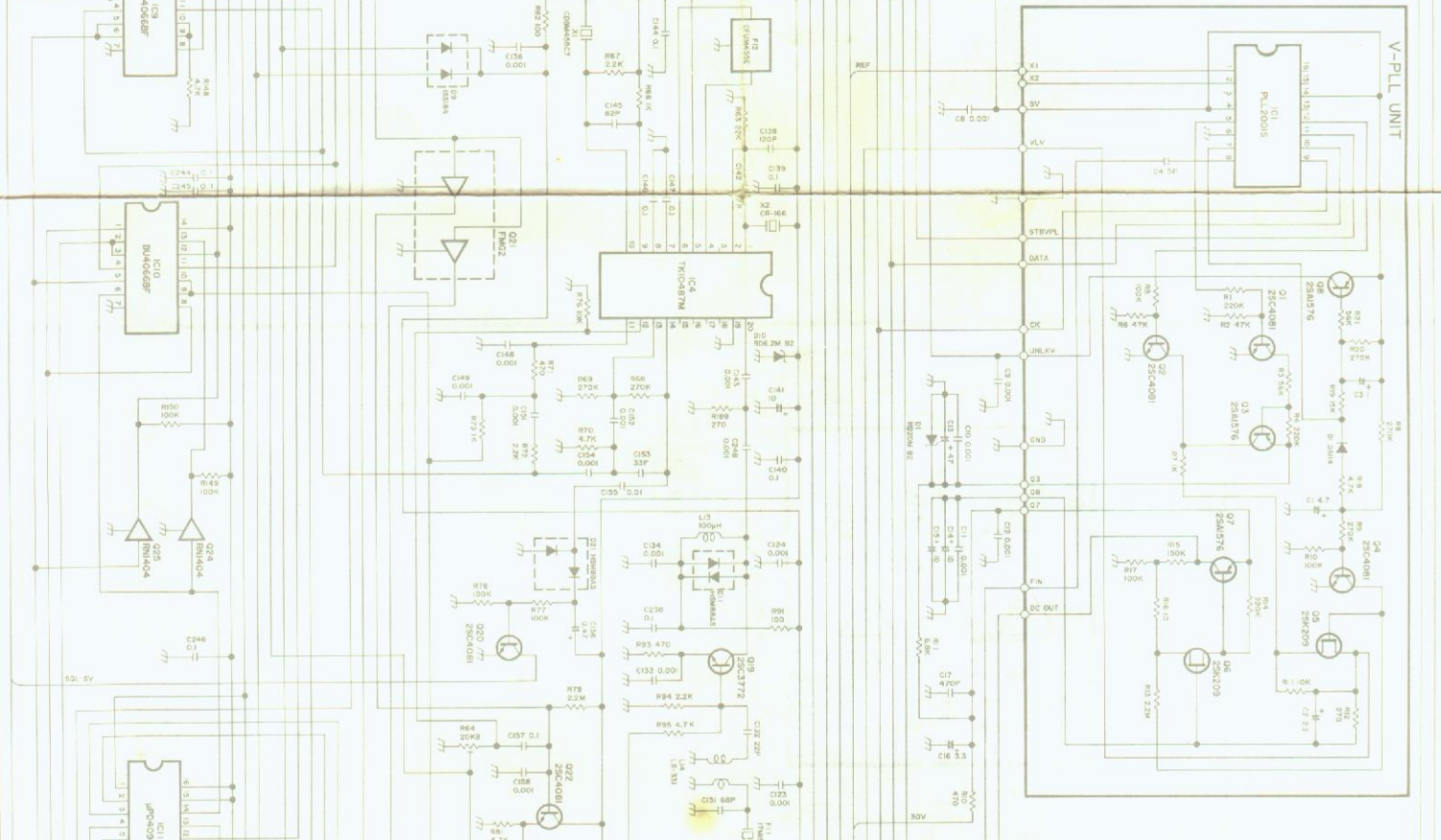
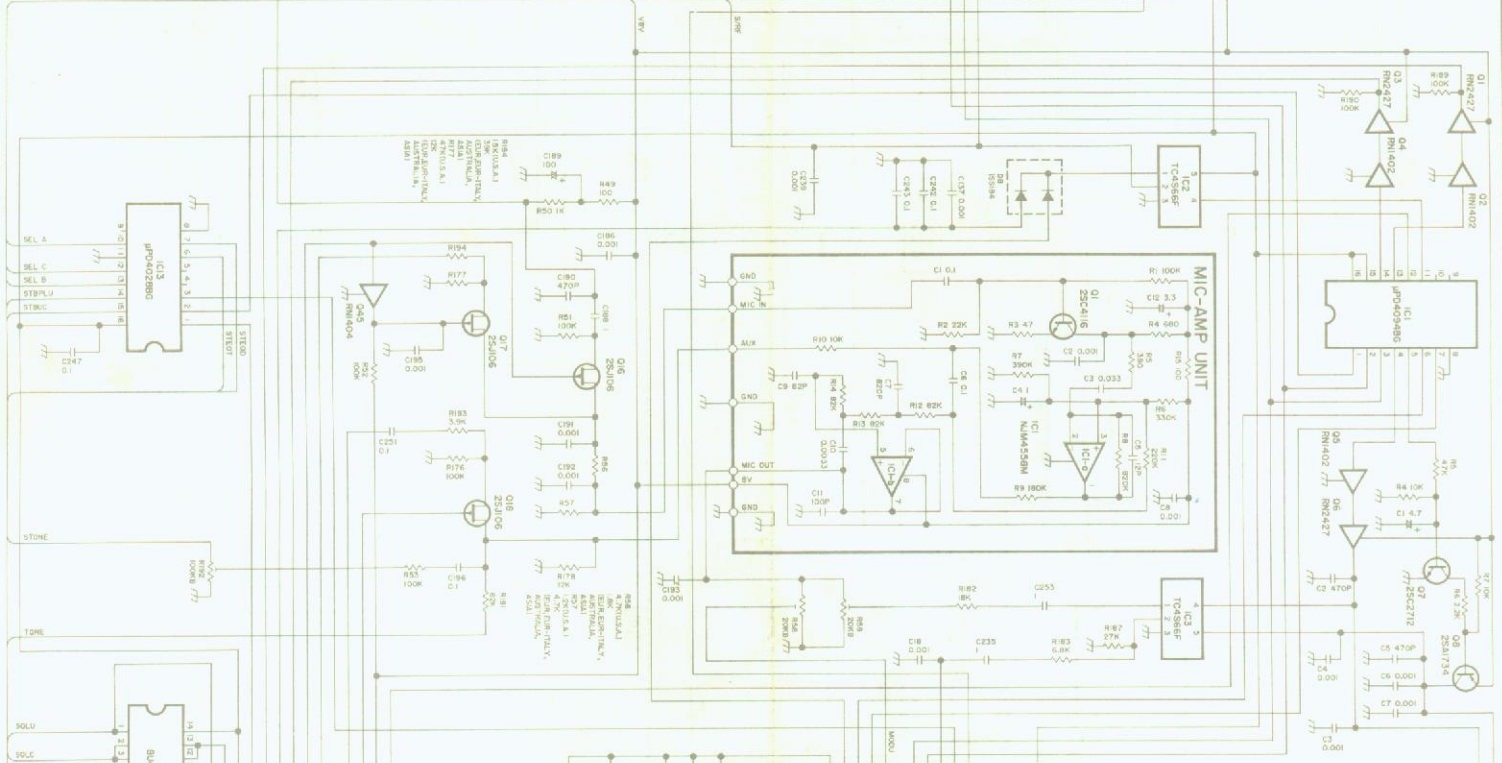
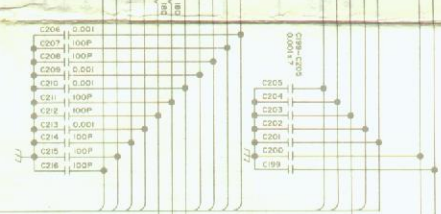

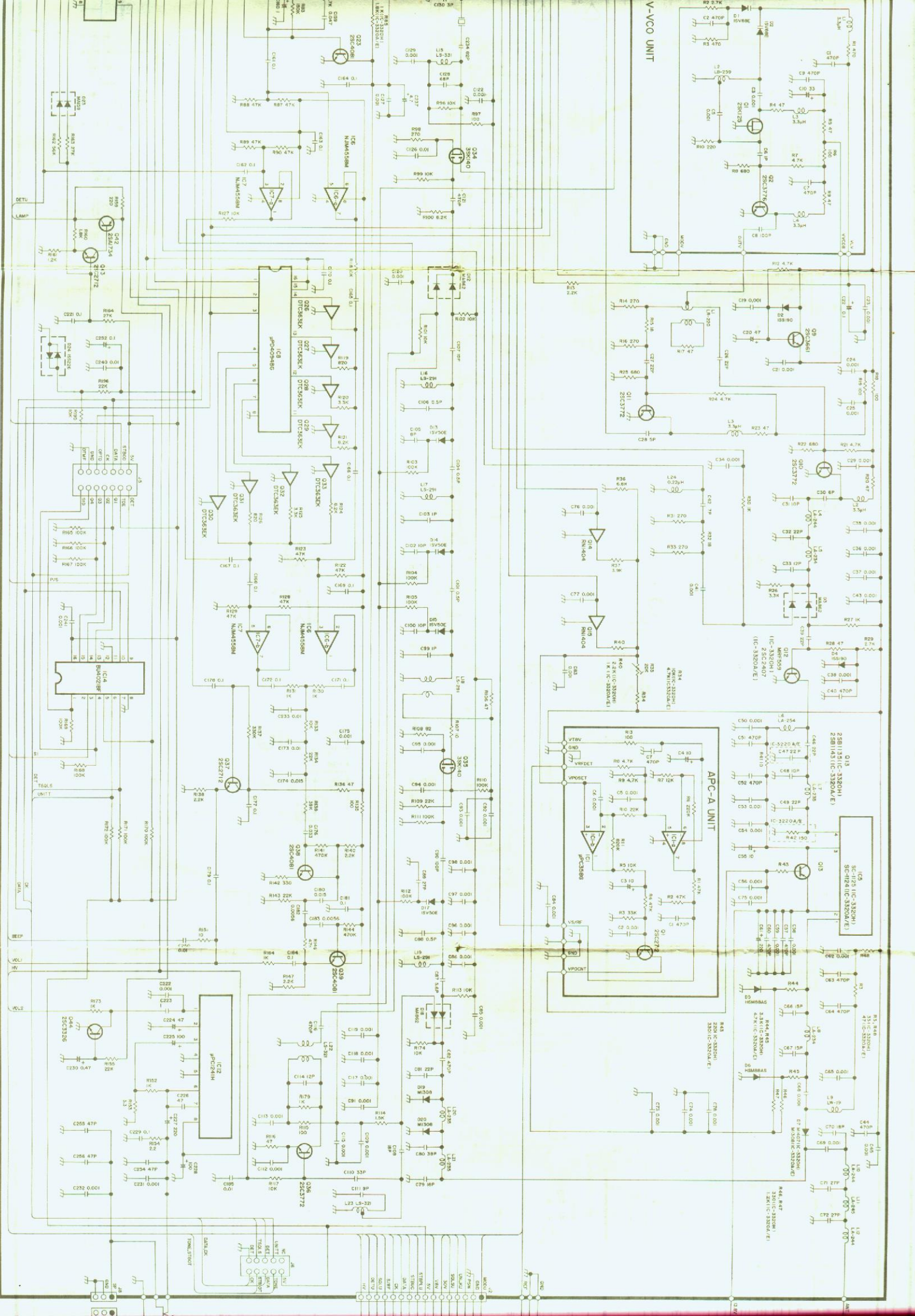

V-VCO UNIT

APC-A UNIT

VCO
VCA

APC
A

IC1
IC2
IC3
IC4
IC5
IC6
IC7
IC8

Q1
Q2
Q3
Q4
Q5
Q6
Q7
Q8
Q9
Q10

R1
R2
R3
R4
R5
R6
R7
R8
R9
R10
R11
R12
R13
R14
R15
R16
R17
R18
R19
R20
R21
R22
R23
R24
R25
R26
R27
R28
R29
R30
R31
R32
R33
R34
R35
R36
R37
R38
R39
R40
R41
R42
R43
R44
R45
R46
R47
R48
R49
R50
R51
R52
R53
R54
R55
R56
R57
R58
R59
R60
R61
R62
R63
R64
R65
R66
R67
R68
R69
R70
R71
R72
R73
R74
R75
R76
R77
R78
R79
R80
R81
R82
R83
R84
R85
R86
R87
R88
R89
R90
R91
R92
R93
R94
R95
R96
R97
R98
R99
R100

C1
C2
C3
C4
C5
C6
C7
C8
C9
C10
C11
C12
C13
C14
C15
C16
C17
C18
C19
C20
C21
C22
C23
C24
C25
C26
C27
C28
C29
C30
C31
C32
C33
C34
C35
C36
C37
C38
C39
C40
C41
C42
C43
C44
C45
C46
C47
C48
C49
C50
C51
C52
C53
C54
C55
C56
C57
C58
C59
C60
C61
C62
C63
C64
C65
C66
C67
C68
C69
C70
C71
C72
C73
C74
C75
C76
C77
C78
C79
C80
C81
C82
C83
C84
C85
C86
C87
C88
C89
C90
C91
C92
C93
C94
C95
C96
C97
C98
C99
C100

U1
U2
U3
U4
U5
U6
U7
U8
U9
U10
U11
U12
U13
U14
U15
U16
U17
U18
U19
U20
U21
U22
U23
U24
U25
U26
U27
U28
U29
U30
U31
U32
U33
U34
U35
U36
U37
U38
U39
U40
U41
U42
U43
U44
U45
U46
U47
U48
U49
U50
U51
U52
U53
U54
U55
U56
U57
U58
U59
U60
U61
U62
U63
U64
U65
U66
U67
U68
U69
U70
U71
U72
U73
U74
U75
U76
U77
U78
U79
U80
U81
U82
U83
U84
U85
U86
U87
U88
U89
U90
U91
U92
U93
U94
U95
U96
U97
U98
U99
U100

IC1
IC2
IC3
IC4
IC5
IC6
IC7
IC8

Q1
Q2
Q3
Q4
Q5
Q6
Q7
Q8
Q9
Q10

R1
R2
R3
R4
R5
R6
R7
R8
R9
R10
R11
R12
R13
R14
R15
R16
R17
R18
R19
R20
R21
R22
R23
R24
R25
R26
R27
R28
R29
R30
R31
R32
R33
R34
R35
R36
R37
R38
R39
R40
R41
R42
R43
R44
R45
R46
R47
R48
R49
R50
R51
R52
R53
R54
R55
R56
R57
R58
R59
R60
R61
R62
R63
R64
R65
R66
R67
R68
R69
R70
R71
R72
R73
R74
R75
R76
R77
R78
R79
R80
R81
R82
R83
R84
R85
R86
R87
R88
R89
R90
R91
R92
R93
R94
R95
R96
R97
R98
R99
R100

C1
C2
C3
C4
C5
C6
C7
C8
C9
C10
C11
C12
C13
C14
C15
C16
C17
C18
C19
C20
C21
C22
C23
C24
C25
C26
C27
C28
C29
C30
C31
C32
C33
C34
C35
C36
C37
C38
C39
C40
C41
C42
C43
C44
C45
C46
C47
C48
C49
C50
C51
C52
C53
C54
C55
C56
C57
C58
C59
C60
C61
C62
C63
C64
C65
C66
C67
C68
C69
C70
C71
C72
C73
C74
C75
C76
C77
C78
C79
C80
C81
C82
C83
C84
C85
C86
C87
C88
C89
C90
C91
C92
C93
C94
C95
C96
C97
C98
C99
C100

U1
U2
U3
U4
U5
U6
U7
U8
U9
U10
U11
U12
U13
U14
U15
U16
U17
U18
U19
U20
U21
U22
U23
U24
U25
U26
U27
U28
U29
U30
U31
U32
U33
U34
U35
U36
U37
U38
U39
U40
U41
U42
U43
U44
U45
U46
U47
U48
U49
U50
U51
U52
U53
U54
U55
U56
U57
U58
U59
U60
U61
U62
U63
U64
U65
U66
U67
U68
U69
U70
U71
U72
U73
U74
U75
U76
U77
U78
U79
U80
U81
U82
U83
U84
U85
U86
U87
U88
U89
U90
U91
U92
U93
U94
U95
U96
U97
U98
U99
U100

MAIN-B UNIT

TONE BOARD (U.S.A. ONLY)

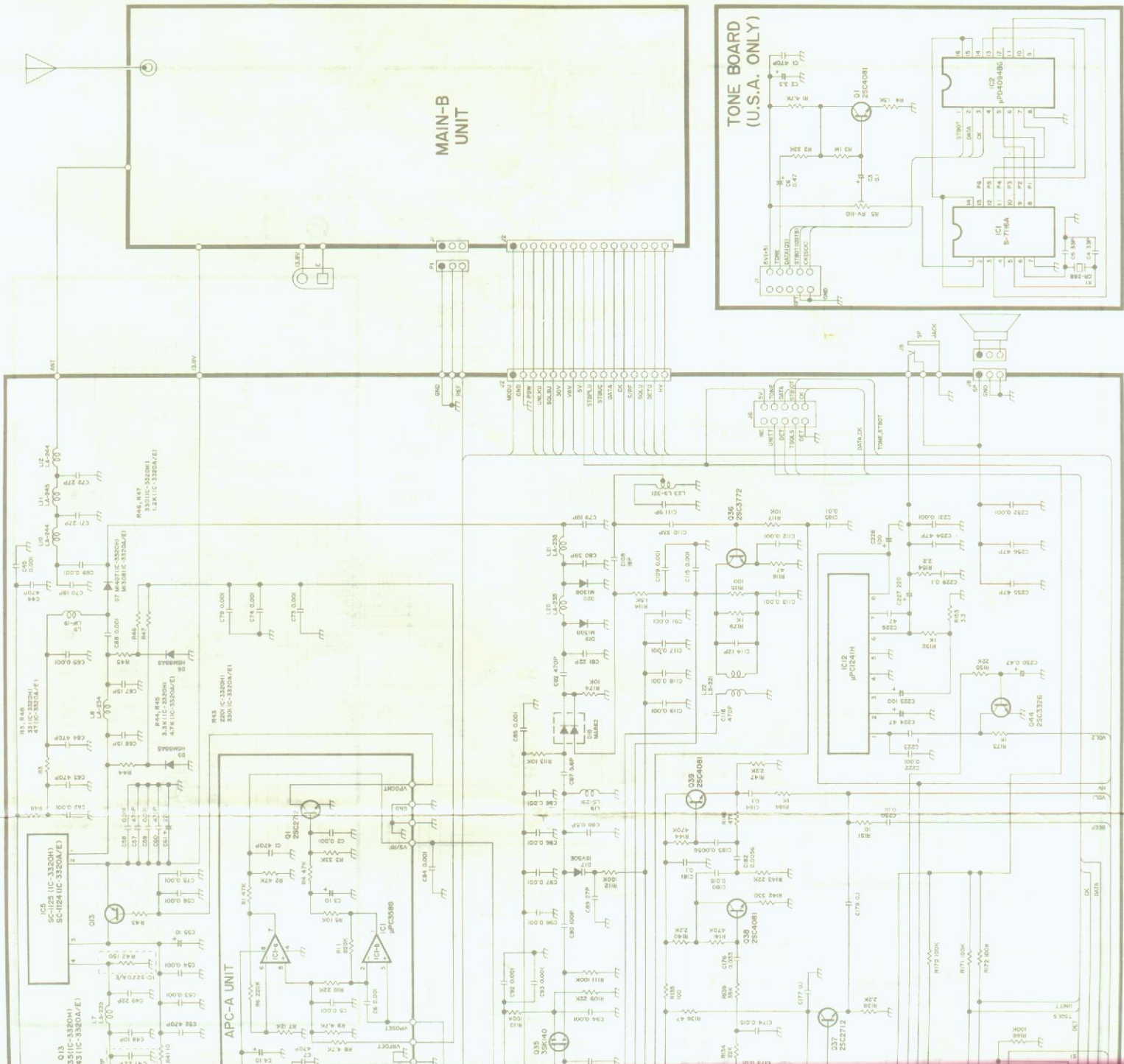

BLOCK DIAGRAM

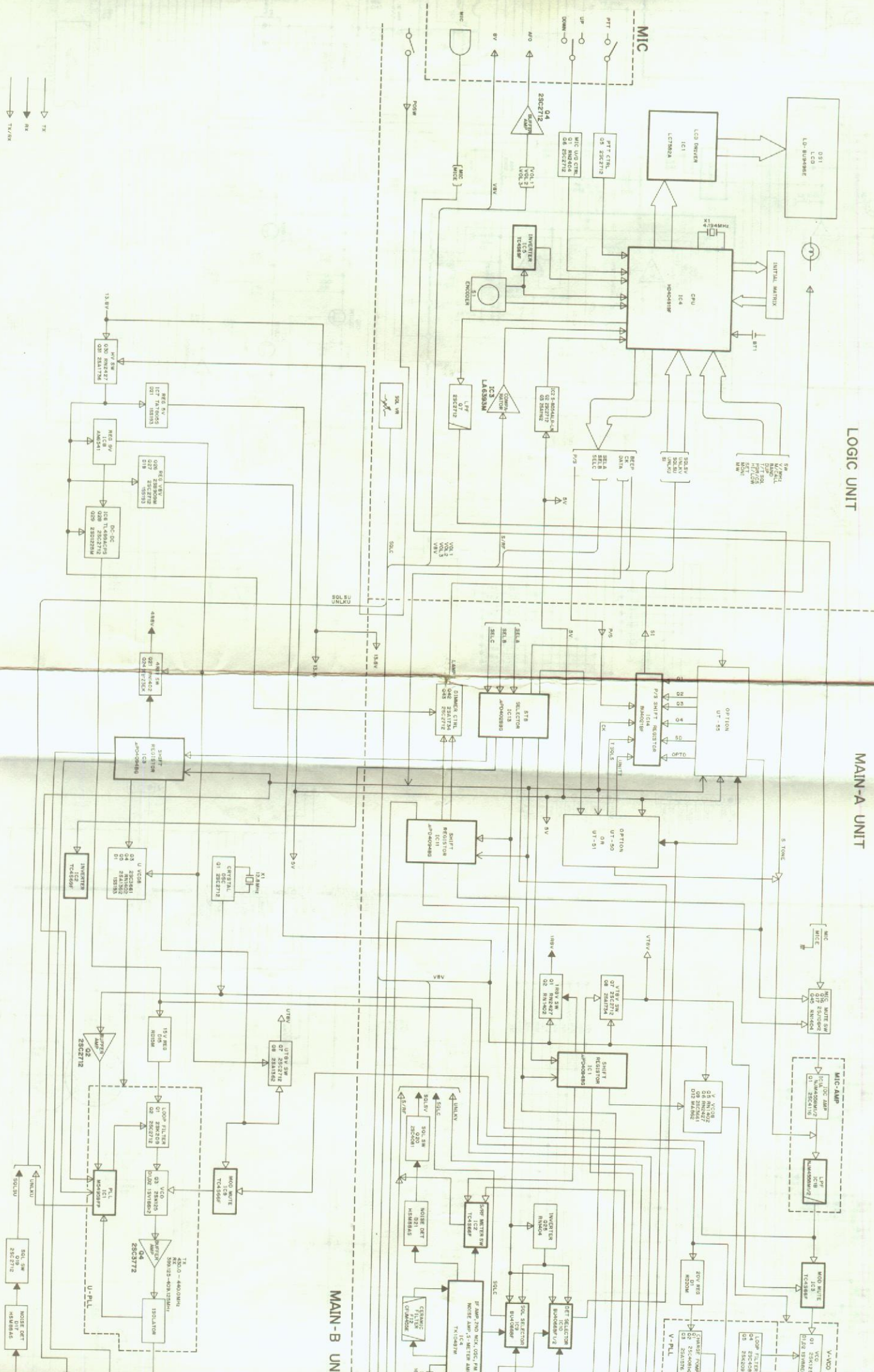

MAIN-A UNIT

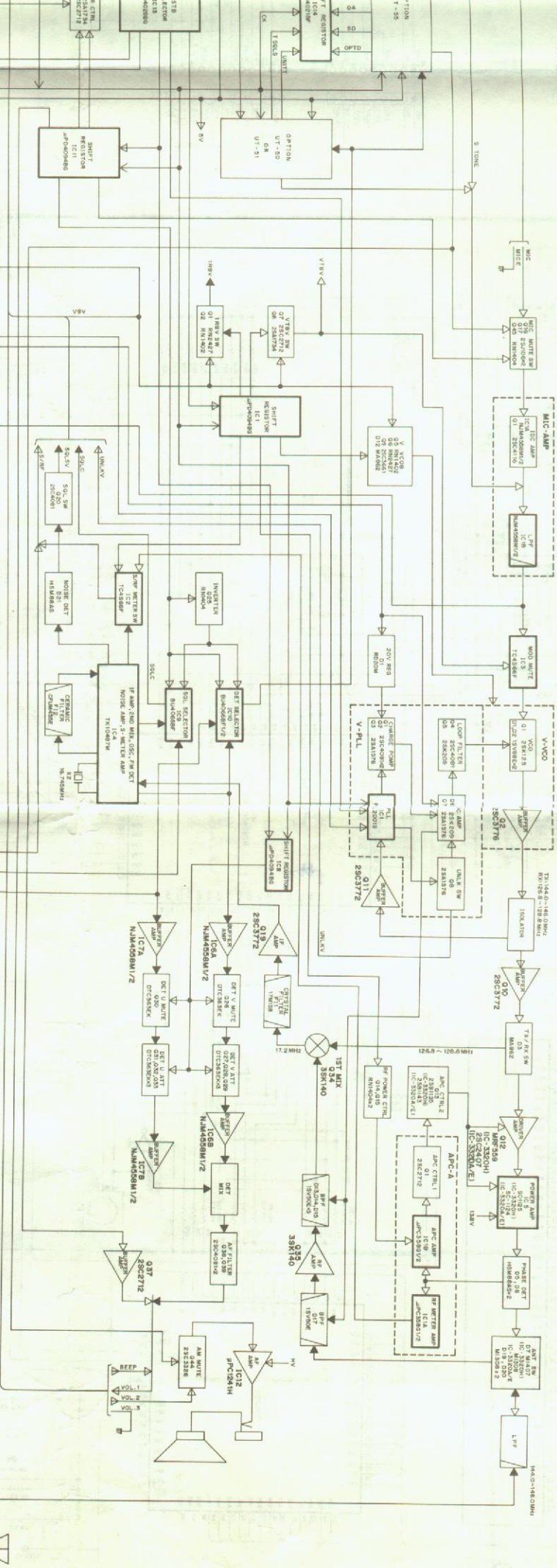

MAIN-B UNIT

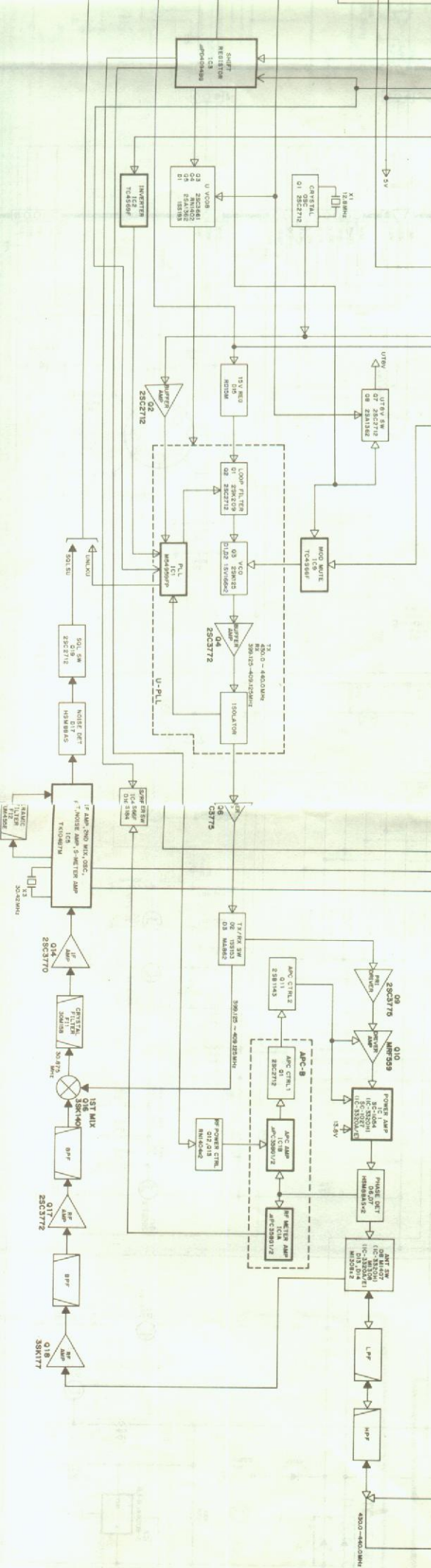

Handwritten notes and markings on the right side of the page, including:
- XT 109 000 PPT - 000 061
- 94 P 28 11
- 06 15 109 - 26-12
- 200 15

D4 Logic Board (VHF 118-135)
 D5 Logic Board (UHF)
 JUMPER LA) POINT A LA) EN LA) DE D9 (VHF)

3220E IC-3220H

SCHEMATIC DIAGRAM

CONTAR D4-D5 - POWER D9 } PARA 118 000 - 135 995 RX AM.
 SOLDAR PIN ALA) EN LA) DE D7 } LIBERAR 136 000 - 174 000 FM TX Y RX
 440 000 - 474 000 FM TX Y RX

RESETAR MICROPROCESADOR
 PREGIOLAN (SET Y MW Y ENCENDIDA EQUIPO.

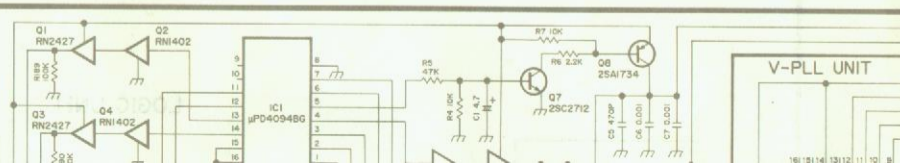
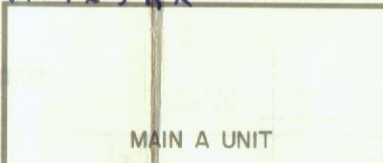
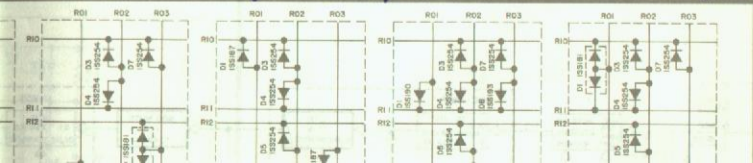

BLOCK DIAGRAM