

icom

INSTRUCTION MANUAL

245 MHz FM TRANSCEIVER

IC-3FGX

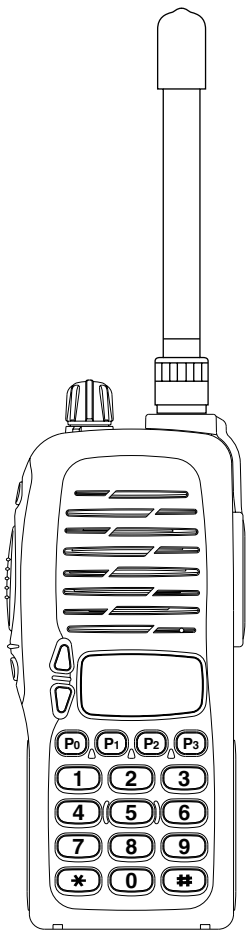

Icom Inc.

FOREWORD

Thank you for purchasing the IC-3FGX 245 MHz FM transceiver. **READ ALL INSTRUCTIONS** carefully and completely before using the transceiver.

SAVE THIS INSTRUCTION MANUAL—This instruction manual contains important operating instructions for the transceiver.

IMPORTANT

⚠ **CAUTION! NEVER** hold the transceiver so that the antenna is very close to, or touching exposed parts of the body, especially the face or eyes, while transmitting. The transceiver will perform best if the microphone is 2 to 4 in. (5 to 10 cm) away from the lips and the transceiver is vertical.

⚠ **CAUTION! NEVER** operate the transceiver with a headset or other audio accessories at high volume levels.

⚠ **CAUTION! NEVER** short the terminals of the battery pack.

DO NOT push the PTT when not actually desiring to transmit.

AVOID using or placing the transceiver in direct sunlight or in areas with temperatures below +14°F (-10°C) or above +122°F (+50°C).

DO NOT modify the transceiver for any reason.

KEEP the transceiver from the heavy rain, and **Never** immerse it in the water. The transceiver construction is **water resistant**, not water proof.

The use of non-Icom battery packs/chargers may impair transceiver performance and invalidate the warranty.

TABLE OF CONTENTS

FOREWORD	i
IMPORTANT	i
TABLE OF CONTENTS	ii
1 PANEL DESCRIPTION	1-3
■ Switches, controls, keys and connectors	1-2
■ Function display	3
2 ACCESSORIES	4
3 BATTERY PACKS	5-10
■ Battery pack replacement	5
■ Battery cautions	6
■ Battery charging	7-8
■ Charging NOTE	9
■ Battery case (Option)	10
4 PROGRAMMABLE FUNCTIONS	11-15
■ Receiving and transmitting	11
5 CONVENTIONAL OPERATION	16-18
■ Call procedure	17
■ Tx code channel selection	18
■ Manual 5-tone codes	18
■ Transmitting notes	18
6 OTHER FUNCTIONS	19
■ DTMF pager/Code squelch	19
7 MAINTENANCE	20
■ Optional UT-108/UT-109 and UT-110 installation	20
8 CLONING	21
9 CHANNEL LIST	22
10 SPECIFICATIONS	23
11 OPTIONS	24-25
12 MEMO	26-28

1 PANEL DESCRIPTION

■ Switches, controls, keys and connectors

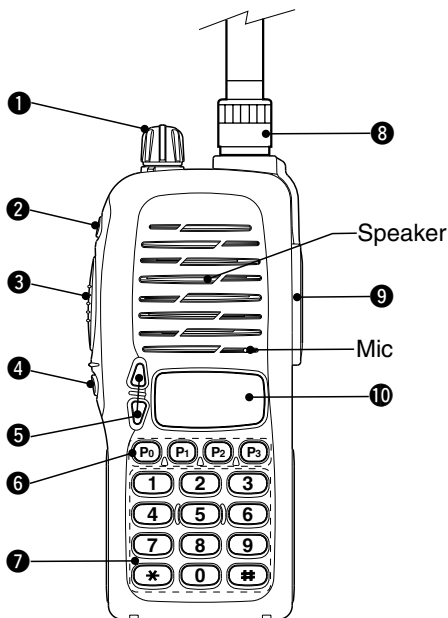

◇ Programmable key reference

S1 (Red)		P0	
S2 (Black)		P1	
▲		P2	
▼		P3	

① VOLUME CONTROL [OFF/VOL]

Turns power ON and adjusts the audio level.

② DEALER-PROGRAMMABLE KEY [S1 (Red)]**③ PTT SWITCH [PTT]**

Push and hold to transmit; release to receive.

④ DEALER-PROGRAMMABLE KEY [S2(Black)]**⑤ UP/DOWN KEYS [▲]/[▼]**

- Push to select the operating channel.

⑥ DEALER-PROGRAMMABLE KEYS [P0]/[P1]/[P2]/[P3]

Can each be programmed for one of several functions by your Icom Dealer.

⑦ 10-KEY PAD

Used to enter DTMF codes, the operating channel, etc.

⑧ ANTENNA CONNECTOR (BNC)

Connects the supplied antenna.

⑨ [SP]/[MIC] JACK

Connect optional speaker-microphone.

⑩ FUNCTION DISPLAY

Displays the following information:

- CH number.
- 5-tone indication.
- Low-battery indication.
- DTMF numbers.
- Low-power indication.
- Skip-Ch indication.
- Audible indication.

/// **NOTE:** Above functions depend on pre-setting.

1 PANEL DESCRIPTION

■ Function display

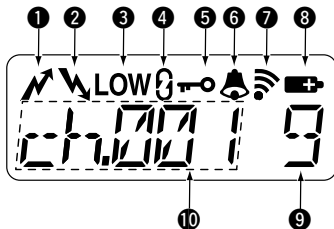

① TRANSMIT INDICATOR

Appears during PTT on.

② BUSY INDICATOR

Appears while receiving a signal or when the squelch is open.

③ LOW POWER INDICATOR (p. 12)

Appears when low output power is selected.

④ SCRAMBLER INDICATOR

Appears while the scrambler function is operating.

⑤ KEY LOCK INDICATOR (p. 11)

Appears during key lock function ON.

⑥ BELL INDICATION

Appears or blinks when the optional 5Tone call is received.

⑦ AUDIBLE INDICATOR

Appears when monitor function is turned ON. (CTCSS and DTCS mutes are released.)

⑧ LOW BATTERY INDICATOR []

-When  appears, battery

capacity is low and transmitting is impossible.

-When  flashes, battery capacity is nearly exhausted.

⑨ S-meter

Show the received signal strength

⑩ ALPHANUMERIC INDICATOR

■ Accessory attachment

◇ Supplied accessories

The transceiver comes supplied with the following accessories.

① Flexible antenna

② Belt clip

③ 2251 OPT sheet

(See p. 26)

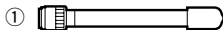

◇ Antenna

The antenna screws onto the transceiver as illustrated right.

Keep the jack cover attached when jacks are not in use to avoid bad contacts.



◇ Belt clip

Attach the belt clip to the transceiver as illustrated below.

To attach the belt-clip

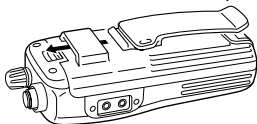

To release the belt-clip



3 BATTERY PACKS

■ Battery pack replacement

Before replacing the battery pack, the volume control **MUST** be rotated fully counterclockwise, until a click is heard, to turn the power OFF.

- Push the battery release forward, then pull the battery pack upward with the transceiver facing you.

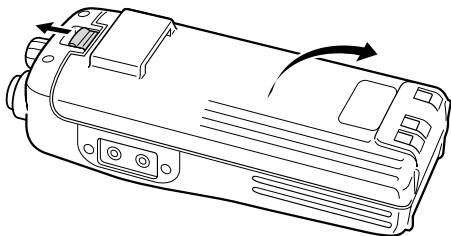

◇ BATTERY PACKS

Battery pack	Voltage	Capacity	Charging period		Operating period*1
			BC-137	BC-119 or BC-121 with AD-94	
BP-208	Battery case for AA (R6) × 6 alkaline			N/A	
BP-209R	7.2 V	1100 mAh	15 hrs	1.5 hrs	8 hrs
BP-210	7.2 V	1650 mAh	15 hrs	2.0 hrs	11 hrs

*1 Operating periods are calculated under the following conditions;
Tx : Rx : standby = 5 : 5 : 90

* Operating period depends on alkaline cells used.

■ Battery cautions

- **CAUTION! NEVER** short terminals of the battery pack (or charging terminals of the transceiver). Also, current may flow into nearby metal objects such as a necklace, so be careful when placing battery packs (or the transceiver) in handbags, etc. Simply carrying with or placing near metal objects such as a necklace, etc. causes shorting. This will damage not only the battery pack, but also the transceiver.
- **NEVER** incinerate used battery packs. Internal battery gas may cause an explosion.
- **NEVER** immerse the battery pack in water. If the battery pack becomes wet, be sure to wipe it dry **BEFORE** attaching it to the transceiver.
- **Clean** the battery terminals to avoid rust or miss contact.
- **Keep** battery contacts clean. It's a good idea to clean battery terminals once a week.

If your battery pack seems to have no capacity even after being charged, completely discharge it by leaving the power ON overnight. Then, fully charge the battery pack again. If the battery pack still does not retain a charge (or only very little charge), a new battery pack must be purchased. (P. 9)

3 BATTERY PACKS

■ Battery charging

◇ Rapid charging with the BC-119+AD-94

The optional BC-119 provides rapid charging of optional battery packs.

The following are additionally required:

- One AD-94.
- An AC adapter (may be supplied with the BC-119 depending on version).

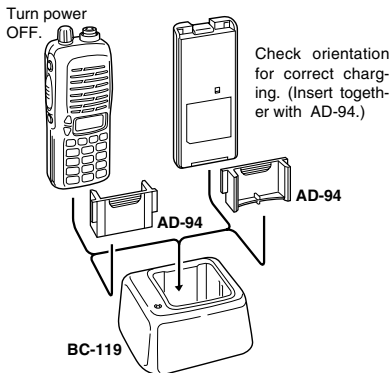

When using the BC-119 in a vehicle: If the charge indicator flashes orange, the vehicle battery voltage is low and charging may not be performed. Check the vehicle battery voltage in this case. If the charge indicator flashes red, there may be a problem with the battery pack (or charger). Re-insert the battery pack or contact your dealer.

◇ Rapid charging with the BC-121+AD-94

The optional BC-121 allows up to 6 battery packs to be charged simultaneously. The following are additionally required.

- Six AD-94s.
- An AC adapter (may be supplied with the BC-121 depending on version).

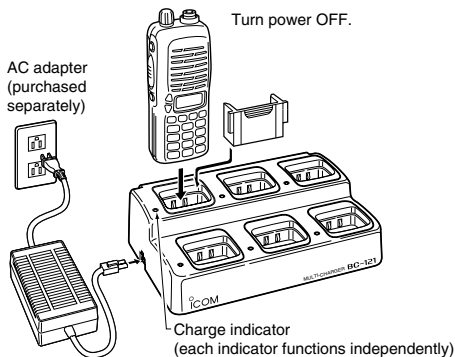

◇ Regular charging with the BC-137

The optional BC-137 provides regular charging of optional battery pack with/without transceiver.

The following is additionally required:

- An optional AC adapter. (A charger adapter is supplied with BC-137.)

Turn power OFF.

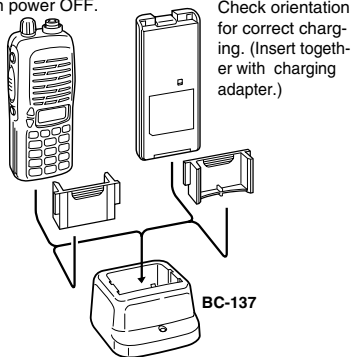

■ Charging NOTE

Prior to using the transceiver for the first time, the battery pack must be fully charged for optimum life and operation.

- Recommended temperature range for charging: +10°C to +40°C (50°F to 140°F).
- Use the supplied charger or optional charger (BC-119/BC-121 for rapid charging, BC-137 for regular charging) only. **NEVER** use other manufacturers' chargers.

The optional BP-209R or BP-210 battery packs include rechargeable Ni-Cd(Ni-MH: BP-210) batteries and can be charged approx. 300 times. Charge the battery pack before first operating the transceiver or when the battery pack becomes exhausted.

If you want to charge the battery pack more than 300 times, the following points should be observed:

- Avoid over charging. The charging period should be less than 48 hours.
- Use the battery until it becomes almost completely exhausted under normal conditions. We recommend battery charging after transmitting becomes impossible.

◆ Battery pack life

When the operating period becomes extremely short even after charging the battery pack fully, a new battery pack is needed.

■ Battery case (Option)

When using a BP-208 OPTIONAL BATTERY CASE attached to the transceiver, install 6 AA (R6) size alkaline batteries as illustrated below.

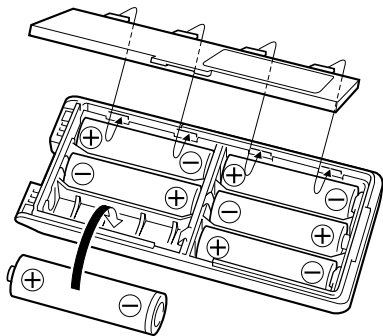

◇ CAUTIONS

- Use **ALKALINE** batteries only.
- **Make sure** all battery cells are the same brand, type and capacity.
- **Never** mix old and new batteries.
Either of the above may cause a fire hazard or damage the transceiver. If ignored.
- **Never** incinerate used battery cells since internal battery gas may cause them to rupture.
- **Never** expose a detached battery case to water.
If the battery case gets wet, be sure to wipe it dry before using.

4 PROGRAMMABLE FUNCTIONS

■ General

In the following explanations, programmable function names are bracketed, the specific switch used to activate the function depends on programming.

◇ KEYPAD LOCK FUNCTION

This function locks access to all programmable switches (except the switch assigned for the lock function).

:

Push and hold the [LOCK] switch for 1 sec. to toggle the lock function ON and OFF.

- “ ” appears while the lock function is ON.
- This function may be inhibited on some channels.

◇ PRIORITY CHANNEL

This function is used to select a pre-programmed channel at the push of a switch.

Push the [PRIORITY] switch to select the priority channel.

- “PRIO” appears briefly, then the priority channel is automatically selected.

◇ SCAN FUNCTION

The scan function allows you to search a pre-programmed group of channels for signals.

Push the [SCAN] switch to start/stop scan.

- Scan pauses on a channel when receiving a signal.
- Depending on programming, a message may appear while scanning.
- “Lockout SCAN” (pre-programmed list SCAN) or “Priority SCAN” can be pre-programmed.
- When the “Power-save function” is activated, the transceiver

checks all pre-programmed channels then returns to the “Power-save function” again.

◆ HIGH/LOW POWER OUTPUT

This function selects high or low power for a channel.

Push the [HIGH/LOW] switch to toggle between high and low power.

- “LOW” appears when low output power is selected.

◆ SCRAMBLER FUNCTION (optional UT-109 #01* or UT-110 #01* is required.)

This function provides higher communication security.

UT-109: Non-rolling type. 32 code numbers are available.

UT-110: Rolling type. 1020 (4 group × 255) code numbers are available.

Push the [SCRM] switch to toggle the function ON and OFF.

 **NOTE: NEVER use #02** High AF level versions, as they are not compatible

◆ BEEP FUNCTION

This function provides confirmation beep tones when pushing switches.

Push the [BEEP] switch to toggle the function ON and OFF.

4 PROGRAMMABLE FUNCTIONS

◆ MONITOR AUDIBLE FUNCTION

The monitor function allows you to open the transceiver's squelch manually to check whether a channel is busy or not. The transceiver has 2 conditions for receive standby:



All signals are received

Audible condition:

This condition mutes audio **ONLY** when no carrier is present. You can receive (or monitor) any signals on a channel.

- Push and hold the [MONI/AUDI], switch to select the audible condition.

Any audio mute functions are cancelled while pushing the [MONI/AUDI] switch.



Only signals containing the proper tone are received

Inaudible condition:

This condition mutes **ALL** signals except those directed to you. Therefore you should check a channel's condition (busy or not) with the monitor function before transmitting.

- Push the [MONI/AUDI] switch momentarily to select the inaudible condition.

◆ TALK AROUND

The talk around function changes duplex channels to simplex channels.

- **Duplex** allows you to contact your base station, repeaters, etc.
- **Simplex** allows you to contact other portable transceivers directly (portable-to-portable contact).

Push the [TALK AROUND] switch one or more times to toggle the function ON and OFF.

◇ DTMF TRANSMISSION

This function allows you to send a pre-programmed DTMF code to control a repeater, open another transceiver's squelch, etc.

Manual transmission:

Push desired digit keys in sequence while pushing [PTT].

- Pushing [PTT] may not be necessary depending on programming.

Automatic pre-programmed transmission:

- ① Push the [DTMF] switch to select DTMF autodial mode, then push [▲] or [▼] to select the desired channel.
- ② Push the [DTMF] switch once more to send a DTMF code.

◇ DTMF RE-DIAL FUNCTION

This function allows you to transmit the last-used DTMF code at the push of a key.

Push the [DTMF RE-DIAL] switch momentarily to activate the function.

- The previously transmitted DTMF code is automatically transmitted.
- If no code has been transmitted since turning the power ON, this function does not activate.

◇ EMERGENCY FUNCTION

The emergency function allows you to send your ID quickly and easily to your Base Station, etc. in case of emergency.

Push and hold the [EMERGENCY] switch for 1 sec. to activate the emergency function.

- The transceiver selects a pre-programmed channel, then sends an emergency signal to your Base Station.
- The pre-programmed channel remains selected until a control signal is received from the Base Station, or power is turned OFF.

4 PROGRAMMABLE FUNCTIONS

- The emergency call is repeatedly transmitted at pre-programmed intervals.

◇ DISPLAY LIGHTING

The function display has 3 backlight conditions.

OFF : No backlight is available.

AUTO : When any key is pushed, the backlight turns ON for 5 sec. automatically.

CONTINUOUS : Backlight turns ON continuously.

■ Receiving and transmitting

-  **NOTE:** Transmitting without an antenna may damage the transceiver. See p.1 for antenna attachment.
Turn power ON as described on p. 1.

Receiving:

- ① Push [▲]/[▼] to select a channel.
- ② Listen for a transmission and adjust [VOL] to a comfortable listening level.
 - When no transmission is heard, push and hold monitor while adjusting [VOL] (your transceiver may not be programmed with the monitor function).

The transceiver is now set to receive desired calls on the selected channel.

Transmitting:

Wait for the channel to become clear to avoid interference.

- ③ While pushing and holding [PTT], speak into the microphone at a normal voice level.
 - When a tone signalling system is used, the call procedure described at right may be necessary.
- ④ Release [PTT] to return to receive.

IMPORTANT: To maximize the readability of your transmitted signal, pause a few sec.. after pushing [PTT], hold the microphone 10 to 15 cm from your mouth and speak at a normal voice level.

5 CONVENTIONAL OPERATION

■ Call procedure

When your system employs tone signalling (excluding CTCSS and DTCS), the call procedure may be necessary prior to voice transmission. The tone signalling employed may be a selective calling system which allows you to call specific station(s) only and prevent unwanted stations from contacting you.

- ① Select the desired Tx code channel or 5-tone code according to your System Operator's instructions.
 - This may not be necessary depending on programming.
 - Refer to the next page for selection.
- ② Push the call switch (assigned to one of the dealer programmable switches: [P0], [P1], [P2], [P3], [S1] and [S2]).
- ③ After transmitting a 5-tone code, the remainder of your communication can be carried out in the normal fashion.

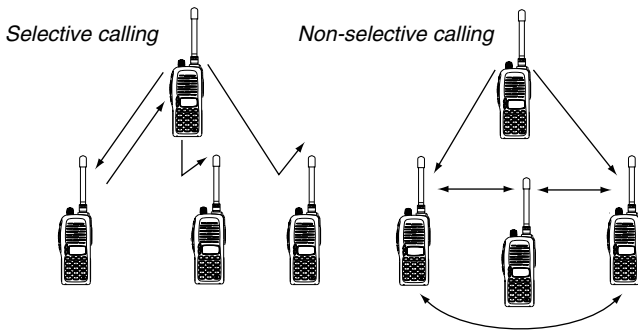

■ Tx code channel selection

Your radio may be programmed for Tx code channel selection. In this case, you can choose a Tx code channel to be transmitted when using the call function (p. 17).

Push the Tx code channel switch (assigned to one of the dealer-programmable switches) to activate the function, then enter digits via the keypad to select the desired Tx code channel.

- The selected code channel (containing a pre-programmed 5-tone code) is transmitted when using the call function.

■ Manual 5-tone codes

Depending on programming, you may be able to send 5-tone codes manually.

Push the Tx code switch to activate the function, then enter the desired transmit code (up to 7 digits) using the keypad.

- Activate the call function to transmit the 5-tone code.
- Blinking indicates keypad entry is acceptable.

■ Transmitting notes

◇ TIME-OUT TIMER

After continuous transmission for a pre-programmed period, the time-out timer is activated, causing the transceiver to stop transmitting and automatically select receive.

◇ PENALTY TIMER

Once the time-out timer is activated, transmission is further inhibited for a period determined by the penalty timer.

6 OTHER FUNCTIONS

■ DTMF PAGER/CODE SQUELCH

When you install optional the UT-108 DTMF DECODER UNIT into the transceiver, DTMF pager function or code squelch function will be available.

◇ DTMF pager

This function uses DTMF tones for calling and can be used as a “common pager” to inform you that one of your group has called even if the operator is temporarily away from the transceiver.

- When the connection code is received, a beep sounds, then “  ” flashes and shows the called stations code number.
- Called stations code number are memorised automatically, and are easy to re-call with “ID-MR select function”.

◇ Code squelch

This conveniently eliminates unwanted audio and is useful in group activities or security related activities where unwanted output can be a problem. The function is similar to a CTCSS tone squelch.

In order to use the above functions, cloning is necessary via a PC using the optional CS-3FGX cloning software. Using this software, the transceiver’s model, individual RX Code CH, TX Code CH, Special Tone Link2 (must be ‘E’) on 5Tone screen, 5Tone Signaling Form on Memory-CH screen, Log, RX C-No, Key&Display, Common AutoReset TimerB, and other settings related to operation can be set. Refer to the HELP file that comes with the CS-3FGX CLONING SOFTWARE for available settings.

■ Optional UT-96/ UT-108/ UT-109 and UT-110 installation

You can install one of the following optional signaling units in the transceiver. UT-96 2TONE/5TONE UNIT, UT-108 DTMF DECODER UNIT or UT-109/ UT-110 SCRAMBLER UNIT.

- ① Take off the optional connector access cover (named 2251 OPT sheet).
 - Insert a screwdriver into the hollow of the chassis, then lift and take away the cover. (The cover can not be used again.)

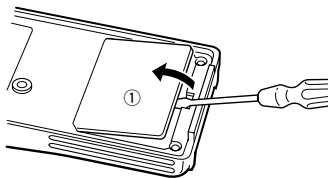

- ② Attach the desired optional unit. Insert the connector tightly to avoid bad contact.
- ③ Remove the paper backing of 2251 OPT sheet supplied as accessory.
- ④ Attach the new 2251 OPT sheet to the service window.
- ⑤ Program the necessary information with the cloning software before operation. Please ask your dealer or system operator for details.

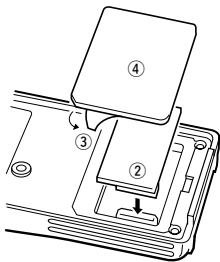

8 CLONING

■ Cloning

Cloning allows you to quickly and easily transfer the programmed contents from one transceiver to another transceiver; or data from PC to a transceiver using the optional CS-3FGX CLONING SOFTWARE.

◆ Transceiver-to-transceiver cloning

- ① Connect the optional OPC-474 CLONING CABLE with adapter plugs to the [SP] jack of the master and slave transceivers.
 - The master transceiver is used to send data to the slave transceiver.
- ② While pushing [P0] and [▲], turn the transceiver's power on to enter cloning mode (For both the master transceiver and slave transceiver).
 - "CLONE" appears and the transceiver enters the clone standby condition.
- ③ Push [PTT] on the master transceiver.
 - "CLOUT" appears in the master transceiver's display.
 - "CL IN" appears automatically in the slave transceiver's display.
 - When cloning is finished, "CLONE" appears in the master transceiver's display.

NOTE: DO NOT push the [PTT] on the slave transceiver during cloning. This will cause a cloning error.
- ④ When cloning is finished, turn power off, then on again to return to normal operation.

◆ PC-to-transceiver cloning

Please refer to the HELP file that comes with the CS-3FGX CLONING SOFTWARE.

CAUTION: Imprudent cloning operation causes a cloning error. In such a case, memory contents may be lost. Cloning must then be repeated.

CHANNEL LIST 9

CH No.	Freq.	CH No.	Freq.	CH No.	Freq.
1	245.0000	29	245.3500	57	245.7000
2	245.0125	30	245.3625	58	245.7125
3	245.0250	31	245.3750	59	245.7250
4	245.0375	32	245.3785	60	245.7375
5	245.0500	33	245.4000	61	245.7500
6	245.0625	34	245.4125	62	245.7625
7	245.0750	35	245.4250	63	245.7750
8	245.0875	36	245.4375	64	245.7875
9	245.1000	37	245.4500	65	245.8000
10	245.1125	38	245.4625	66	245.8125
11	245.1250	39	245.4750	67	245.8250
12	245.1375	40	245.4875	68	245.8375
13	245.1500	41	245.5000	69	245.8500
14	245.1625	42	245.5125	70	245.8625
15	245.1750	43	245.5250	71	245.8750
16	245.1875	44	245.5375	72	245.8785
17	245.2000	45	245.5500	73	245.9000
18	245.2125	46	245.5625	74	245.9125
19	245.2250	47	245.5750	75	245.9250
20	245.2375	48	245.5875	76	245.9375
21	245.2500	49	245.6000	77	245.9500
22	245.2625	50	245.6125	78	245.9625
23	245.2750	51	245.6250	79	245.9750
24	245.2875	52	245.6375	80	245.9875
25	245.3000	53	245.6500	Unit: MHz	
26	245.3125	54	245.6625		
27	245.3250	55	245.6750		
28	245.3375	56	245.6875		

10 SPECIFICATIONS

GENERAL

- Frequency coverage : 245.0000 to 245.9875 MHz
- Mode : FM (8K50F3E)
- Channel spacing : 12.5 kHz
- No. of operating ch. : 80 (simplex)
- Power supply requirement: 7.2 V DC nominal
- Current drain :
 - Transmit Hi 1.7 A
 - Transmit low 0.7 A
 - Receive stand-by 70 mA
 - Receive max. audio 250 mA
- Operating temp. range : -10°C to $+60^{\circ}\text{C}$ ($+14^{\circ}\text{F}$ to $+140^{\circ}\text{F}$)
- Dimensions : 54(W) \times 132(H) \times 35(D) mm
(projections not included)
- Weight : 370 g (with BP-209R)

TRANSMITTER

- Output power : 5 W
- Maximum deviation : ± 2.5 kHz
- Spurious emissions : 70 dB Typ.
- Ext. mic. connector : 3-conductor 2.5 (d) mm/2.2 k Ω

RECEIVER

- Receive system : Double-conversion superheterodyne
- Sensitivity : 0.25 μV Typ.
(12 dB SINAD)
- Selectivity : More than 8.5 kHz/ -6 dB
- Spurious response : 70 dB Typ.
- Adjacent ch. selectivity : 65 dB Typ.
- Intermodulation rejection ratio: 70 dB Typ.
- Audio output power : More than 500 mW at 10 %
distortion with an 8 Ω load
- Ext. speaker connector : 2-conductor 3.5 (d) mm/8 Ω

All stated specifications are subject to change without notice or obligation.

■ Options

◇ BATTERY PACKS

- **BP-208 BATTERY CASE**

Allows a set of Alkaline batteries to operate the handheld when charging rechargeable battery or in emergencies, etc. 6 AA (R6) cells are required.

- **BP-209R Ni-Cd BATTERY PACK**

7.2 V/1100 mAh Ni-Cd battery pack, allows more than 8 hours operation.

- **BP-210 Ni-MH BATTERY PACK**

7.2 V/1650 mAh Ni-MH battery pack, allows approx. 11 hours operation.

◇ CHARGER

- **BC-119 DESKTOP CHARGER**

For rapid charging of battery packs. An AC adapter is supplied with the charger. Charging time: 1.5 to 2 hrs.

- **BC-121 MULTI-CHARGER**

For rapid charging up to 6 battery packs simultaneously. An AC adapter may be supplied depending on version. Six AD-94's are necessary. Charging time: 1.5 to 2 hrs.

- **AD-94 CHARGER ADAPTOR**

- **BC-137 DESKTOP CHARGER**

For regular charging of BP-209R (Ni-Cd) and BP-210 (Ni-MH).

11 OPTIONS

◆ OTHER OPTIONS

- **UT-96 2/5TONE UNIT**
Provides 2/5Tone capabilities.
- **UT-108 DTMF DECODER UNIT**
Provides ANI operation.
- **UT-109/UT-110 SCRAMBLER UNIT**
Non-rolling type(UT-109)/ Rolling type voice scrambler unit provides higher communication security.
- **HM-46L/HM-75A SPEAKER-MICROPHONES**
Combination speaker-microphone that provides convenient operation while hanging the transceiver from your belt.
- **HS-51 HEAD SET**
Allows you hands-free operation. Includes VOX, PTT and TOT.
- **SP-13 EARPHONE**
Provides clear receive audio in noisy environments.
- **MB-74 BELT CLIP**
Exclusive alligator-type belt clip for IC-3FGX.
- **CS-3FGX CLONING SOFTWARE**
Allows you to clone the memory contents of an IC-3FGX by PC editing.
- **OPC-474 CLONING CABLE**
Cloning cable for transceiver to transceiver
- **OPC-478 CLONING CABLE**
Cloning cable for PC to transceiver.

ALL stated specifications are subject to change without notice or obligation.

Count on us!



A-6002X-1THA

© 2000 Icom Inc. Japan

Icom Inc.

6-9-16 Kamihigashi, Hirano-ku, Osaka 547-0002 Japan
