

# IC-40

## UHF CITIZEN RADIO SERVICE HANDHELD TRANSCEIVER

### INSTRUCTION MANUAL

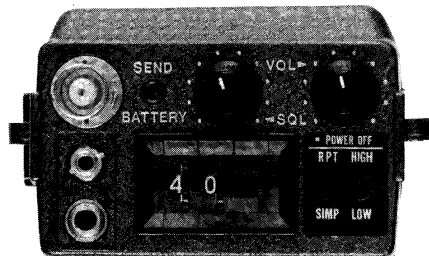

DOC APPROVAL NO.: 250028



## TABLE OF CONTENTS

I. INTRODUCTION .....	1
II. SPECIFICATIONS .....	2
III. ACCESSORIES.....	4
IV. PRE-OPERATION .....	5
V. CONTROL FUNCTIONS.....	10
VI. OPERATION .....	14
VII. TROUBLESHOOTING.....	16
VIII. OPTIONS .....	19
IX. FREQUENCY CHART .....	22

## **SECTION I INTRODUCTION**

### **SYNTHESIZED HANDHELD TRANSCEIVER**

The ICOM IC-40 is a compact UHF synthesized handheld transceiver especially designed to operate on any of the 40 frequencies designated as citizen radio channels. Offering rugged construction, extreme reliability and channel frequency stability, the IC-40 will provide years of trouble free operation.

### **VARIOUS POWER PACKS AVAILABLE**

The Power Pack is slipped onto the base of the radio very easily and various nickel-cadmium battery packs are also available to suit your needs for minimum size, higher power, or longer usage.

### **HIGHLY EFFICIENT FLEXIBLE ANTENNA**

A highly efficient flexible antenna is supplied with the set. Since the IC-40 uses a standard BNC type connector, an external antenna may be easily fitted to improve the set's range and efficiency.

### **DUAL POWER LEVEL**

Transmitter output can be switched easily to either of two levels; HIGH for long distances, and LOW for short distances.

Battery consumption is minimized in the Low Power Mode. The IC-BP5 Power Pack as an option gives 3W output.

## SECTION II SPECIFICATIONS

### GENERAL

Number of Semiconductors	Transistors	37
	FET	2
	IC	8
	Diodes	21
Number of Channels	40 channels Operation: Simplex, Semi-Duplex	
Channel Spacing	25KHz	
Frequency Stability	0.0005 Percent	
Usable Temperature	-10 Degrees C to 60 Degrees C (-14 Degrees F to 140 Degrees F)	
Antenna Impedance	50 ohms Unbalanced	
Power Supply Requirement	DC 8.4V; with attendant power pack IC-BP3	
	DC 6 to 12V negative ground is acceptable	
Current Drain at 8.4V	Transmitting	
	At HI (2 watts) output	Approx. 700mA
	(3 Watts output (with IC-BP5)	approx. 900mA)
	At LOW (0.15 watts) output	Approx. 300mA
	Receiving	
At max audio output	Approx. 170mA	
Squelched	Approx. 25mA	
Dimensions	116.5mm(H) x 65mm(W) x 45mm(D) without power pack	
	Attendant power pack, IC-BP3: 39mm(H) x 65mm(W) x 35mm(D)	
Weight	510g including power pack, IC-BP3 and flexible antenna	

## RECEIVER

Frequency Range	476.425MHz ~ 477.400MHz
Receiving System	Double-conversion superheterodyne
Modulation Acceptance	16F3 (F3E 16K0) $\pm 7.5$ KHz
Intermediate Frequency	1st: 21.800MHz 2nd: 455KHz
Sensitivity	Less than $0.5\mu\text{V}$ for 20dB Noise quieting Less than $0.4\mu\text{V}$ for 12dB SINAD
Squelch Sensitivity	Less than $0.4\mu\text{V}$
Spurious Response Rejection Ratio	More than 60dB
Selectivity	More than 65dB at adjacent channel
Intermodulation Rejection Ratio	More than 60dB
Audio Output Power	More than 400mW
Audio Output Impedance	8 ohms

## TRANSMITTER

Frequency Range	476.425MHz ~ 477.400MHz
Output Power	Hi: 2 watts, Low: 0.15 watts (Hi: 3 watts, Low: 0.25 watts with IC-BP5 10.8V battery)
Emission Mode	16F3 (F3E 16K0)
Modulation System	Variable reactance frequency modulation
Max. Frequency Deviation	$\pm 5$ KHz
Spurious Emission	More than 70dB below carrier
Microphone	Built-in Electret condenser microphone; Optional Speaker-microphone (IC-HM9) can be used.

## SECTION III ACCESSORIES

Carefully remove your transceiver from the packing carton and examine it for signs of shipping damage. Should any be apparent, notify the dealer immediately, stating the full extent of the damage. It is recommended you keep the shipping cartons. In the event that storage, moving, or reshipment becomes necessary, they come in handy. Various accessories are packed with the transceiver. Make sure you have not overlooked anything.

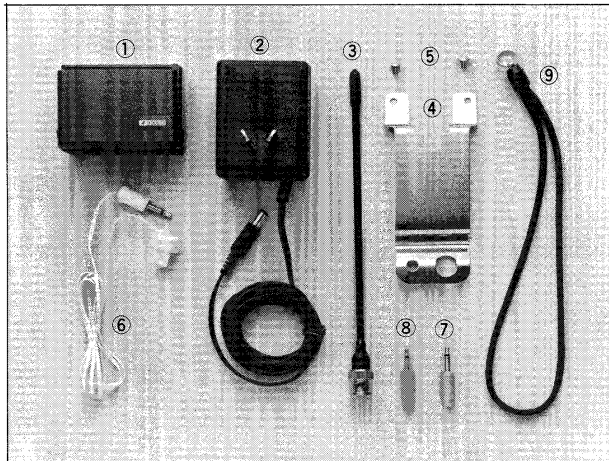

- |   |   |
|---|---|
| 1. Power Pack IC-BP3 . . . . .          | 1 |
| (Attached to the set)                   |   |
| 2. Wall Charger BC-27 . . . . .         | 1 |
| 3. Flexible antenna . . . . .           | 1 |
| 4. Belt Clip . . . . .                  | 1 |
| 5. Belt Clip retaining screws . . . . . | 2 |
| 6. Earphone . . . . .                   | 1 |
| 7. Earphone plug . . . . .              | 1 |
| 8. Microphone plug . . . . .            | 1 |
| 9. Hand-strap . . . . .                 | 1 |

## SECTION IV PRE-OPERATION

### BATTERY INSTALLATION

#### When using Nickel-Cadmium power pack IC-BP3:

The IC-BP3 is rechargeable Nickel-Cadmium power pack, and it can be slipped onto or off the set very easily. It has a connector for a charger, charge-current control circuit, reverse polarity protection circuit and charge indicator LED in its own pack. You can use the BC-27 wall charger supplied, or a car battery by using optional cable IC-CP1 for recharging. Before use, the power pack should be charged about 15 hours, because the battery may have discharged.

After charging is completed, the batteries can be used in the same manner as dry cells. However, the voltage of Nickel-Cadmium batteries drops rapidly just before they are exhausted, so when the transmit indicator LED of the transceiver goes out, be sure to immediately stop using it, and recharge the batteries.

#### HOW TO CHARGE (When using Nickel-Cadmium power pack IC-BP3)

1. Use the supplied wall charger BC-27 or a regulated power source with an output voltage of DC 13.8V and current capacity over 50mA, or use a 12V car battery with optional charger cable IC-CP1. (Output voltage of 12 ~ 15V can be used, but output voltage near the specified voltage should be used.)
2. The power switch of the transceiver must be OFF, or remove the power pack from the transceiver.

3. Connect the output plug of the wall charger, or alternate power source, to the charger socket of the power pack. (When charging Nickel-Cadmium batteries in the IC-BP4 power pack, you should use the BC-36 charger only.)

The charge indicator LED of the power pack will glow, showing that the charger is working.

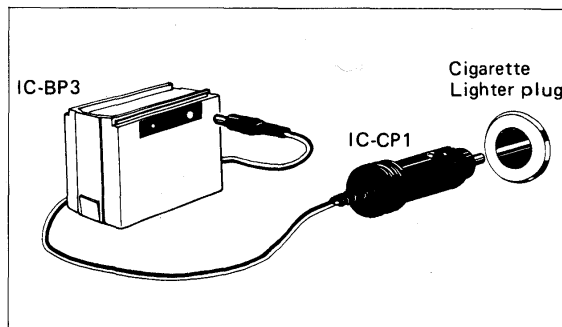
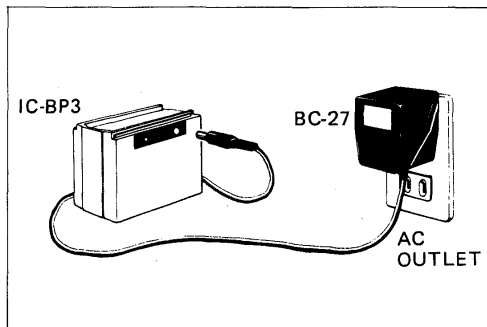

4. It takes about 15 hours to charge the batteries fully. This charger is designed for 0.1C (10-hour rate current), but charge for 15 hours in order to compensate for any unbalance of the batteries. You should charge the batteries for 15 hours when you have not used them for a long time or after purchase.
5. Charge between 0°C and 40°C.
6. Avoid overcharging. If excess charging is repeated, efficiency of the power pack is reduced.
7. After charging, unplug the power source from the charger socket of the power pack. The transmitter and the power pack are now ready for operation.



### When using the alkaline power pack IC-BP4 (option)

Place the power switch in the OFF position. Remove the power pack from the bottom of the set by pushing the pack in the indicated direction. Separate the pack into two parts (chassis and case) as follows:

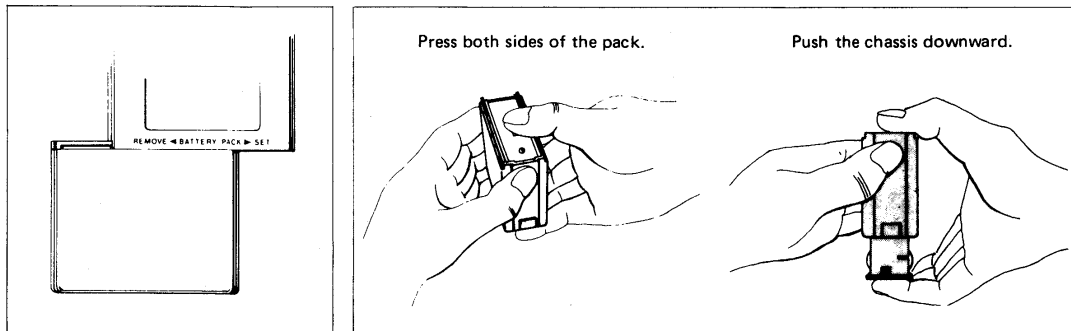

The chassis holds six AA type batteries. Install batteries into each holder, according to indicated polarity. With the batteries properly in place, carefully replace the pack and slip it onto the set with the reverse procedures.

AA type Nickel-Cadmium, rechargeable batteries can also be used.

### WHEN TO REPLACE BATTERIES (When using alkaline batteries)

When the Transmit Indicator LED does not light up during transmission, the batteries are exhausted. Replace worn batteries with a complete new set. If used with old batteries, the life of new ones

might be shortened. Battery life is shortened more by transmitting than by receiving, since several times more current is drawn during transmission. To prolong battery life, try to:

- \* Minimize the transmit period.
- \* Reduce volume during reception.
- \* Turn power off when the set is not in use.

More working hours are available if high performance batteries are employed.

## **FOR USE**

1. Attach the supplied power pack. (Refer to "BATTERY INSTALLATION")
2. Attach the supplied hand strap and belt clip through the fixture on the body (as shown in the drawings on page 9).
3. Attach the flexible rubber antenna or connect an external antenna.

## **EXTERNAL ANTENNA**

1. Select a high performance antenna and set it up in the highest possible position.
2. Use a 50 ohm antenna and coaxial cable.
3. On UHF the power loss in the antenna cable is considerable so use a cable with the lowest possible loss and make it as short as possible.
4. Use a BNC plug for connection to the unit.

## ATTACHMENT OF HAND STRAP AND BELT CLIP

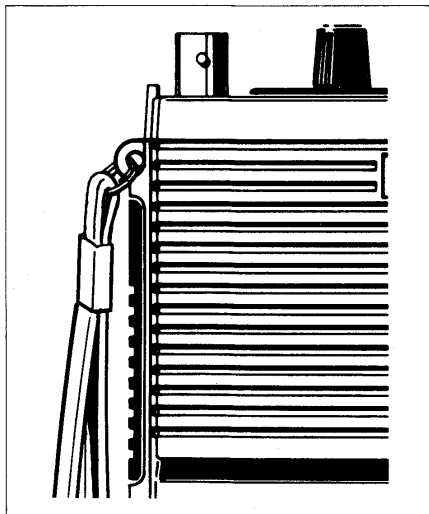

- Attach the belt clip on the back cover with the 2 screws supplied.

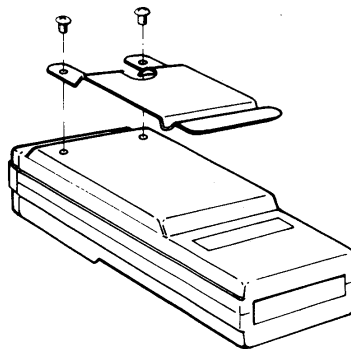

## SECTION V CONTROL FUNCTIONS

### TOP PANEL

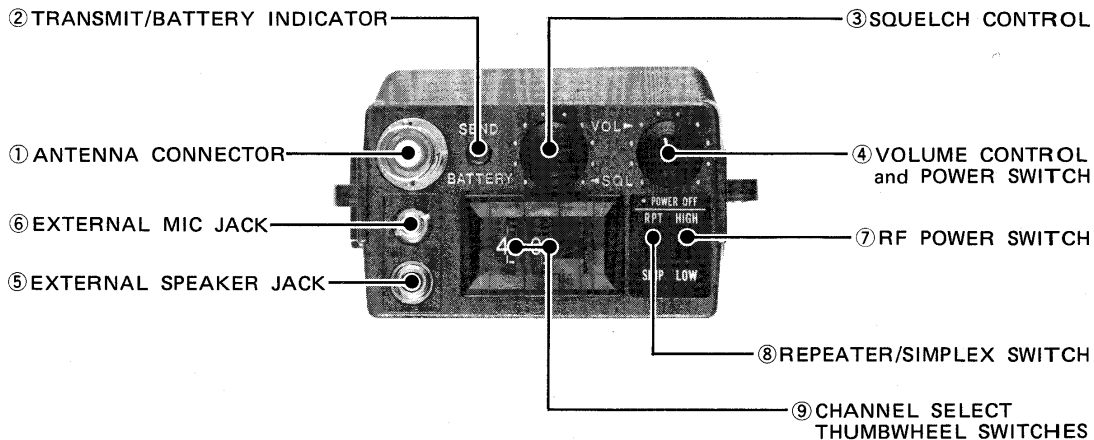

FRONT PANEL

REAR PANEL

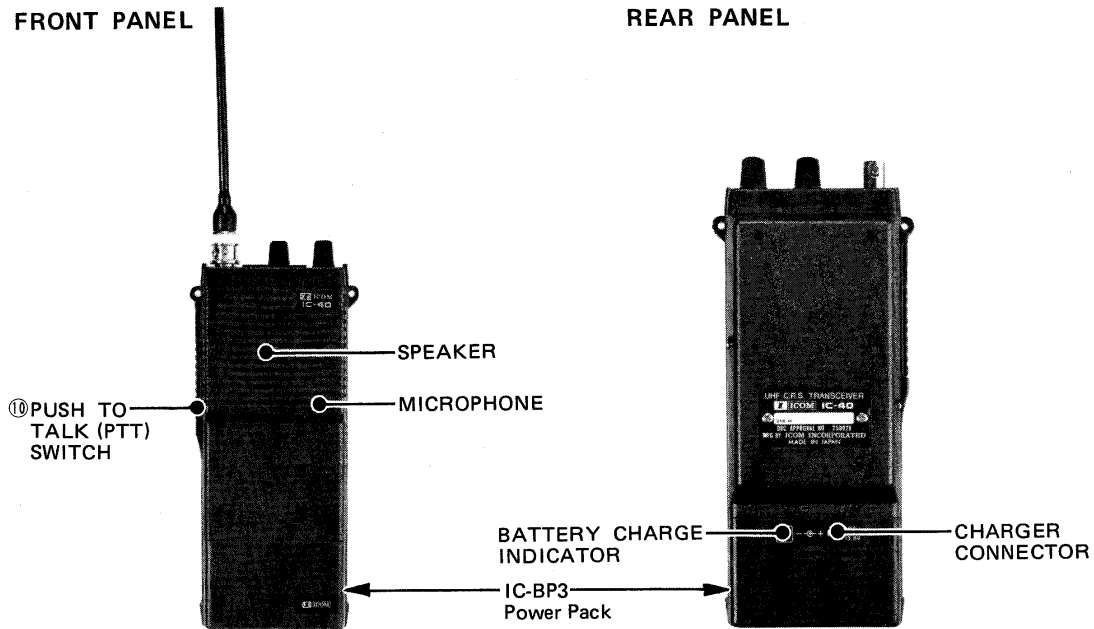

① **ANTENNA CONNECTOR**

Connect the supplied flexible antenna. An external antenna can be used, using a BNC connector.

② **TRANSMIT/BATTERY INDICATOR**

Illuminates in the transmit mode. It also indicates the battery condition during transmission. The voltage of Nickel-Cadmium batteries drops rapidly just before they are exhausted, so when this indicator goes out, be sure to immediately stop using it, and charge the batteries.

③ **SQUELCH CONTROL**

Sets the squelch threshold level. To turn OFF the squelch, rotate this control completely anti-clockwise. To set the threshold level higher, rotate the control clockwise.

④ **VOLUME CONTROL and POWER SWITCH**

When the control is turned completely anti-clockwise, the power is OFF. By turning the control clockwise beyond the "click", the unit is turned ON and the audio level increases by further rotating it clockwise.

⑤ **EXTERNAL SPEAKER JACK**

When an external speaker (or an earphone) is used, connect it to this jack. Use a speaker with an impedance of 8 ohms.

When the external speaker is connected the built-in speaker does not function.

⑥ **EXTERNAL MIC JACK**

When an external microphone is used, connect it to this Jack.

When the external microphone is connected the built-in microphone does not function. The IC-HM9 optional speaker-microphone can also be used.

**⑦ RF POWER SWITCH**

Selects the RF output power HIGH 2 watts or LOW 0.15 watts at 8.4V. (HIGH 3 watts or LOW 0.25 watts at 10.8V.)

**⑧ REPEATER/SIMPLEX SWITCH**

In the Repeater (RPT) mode, the set will transmit 750KHz above the receive frequency, which will enable you to access the many repeaters available. For simplex operation, i.e. without repeaters, select the 'SIMP' setting.

**⑨ CHANNEL SELECT THUMBWHEEL SWITCHES**

Selection can be made of any of the 40 channels available by dialling up the appropriate channel number, e.g. 01, 02, 11 etc.

**NOTE:** When the switches are set at other channel numbers than 01 to 40, the radio does not work (neither audio in the receive mode nor output in the transmit mode).

**⑩ PUSH TO TALK (PTT) SWITCH**

For transmission, press this switch and talk into the microphone with a normal voice. The internal microphone is an electret condenser type, and provides good pickup for all voice levels.

## SECTION VI OPERATION

### RECEIVING

Before turning the power switch ON, make sure that:-

1. The power pack is properly charged and attached to the set.
2. The supplied flexible antenna is properly connected. When an external antenna is used ensure the coaxial line is of the correct impedance (50 ohms), and is firmly connected to the antenna connector.

Set the controls and switches as follows:

- |                                      |                           |
|--------------------------------------|---------------------------|
| ③ SQUELCH CONTROL                    | Completely anti-clockwise |
| ④ VOLUME CONTROL                     | Completely anti-clockwise |
| ⑨ CHANNEL SELECT THUMBWHEEL SWITCHES | Desired channel           |

(Others may be at any position or setting.)

Turn the ④ VOL control clockwise to click on and further for a comfortable audio level.

If only noise can be heard and no signal, turn the ③ SQL control clockwise until the noise from the speaker stops and set it just below this threshold. (When adjusting the SQL setting, if some communication signals can be heard, turn the thumbwheel switch either direction and set it where only noise can be heard.) Your transceiver will now remain silent until an incoming signal is received which opens the squelch. If the squelch is unstable due to the reception of weak or mobile stations, adjust the squelch control further until the proper threshold is obtained.



## TRANSMITTING

Set the controls and switches as follows:

- |                           |           |
|---------------------------|-----------|
| ⑧ REPEATER/SIMPLEX SWITCH | See below |
| ⑦ RF POWER SWITCH         | HIGH      |

For simplex operation, set ⑧ REPEATER/SIMPLEX switch at the SIMPLEX (SIMP) position.

For repeater operation, set ⑧ REPEATER/SIMPLEX SWITCH at REPEATER (RPT) position.

Hold the transceiver fairly close to your mouth. Depress the ⑩ PTT switch and speak in clear, natural voice. When you have finished your conversation, release the PTT switch, and the radio will receive.

## SECTION VII TROUBLESHOOTING

Your IC-40 has been tested very carefully at the factory before shipping. The chart below has been designed to help you correct any problems which are not equipment malfunctions. If you are not able to locate the problems and/or solve it through use of this chart, please contact your dealer or ICOM for assistance.

PROBLEM	POSSIBLE CAUSE	SOLUTION
<p>1. Power does not come ON when the switch is turned.</p>	<p>Bad connection of the power pack.</p> <p>Reverse polarity of the battery (when using IC-BP4).</p> <p>The battery has been exhausted.</p>	<p>Check the connection of the power pack and correct any problems.</p> <p>Make sure of the polarity of each battery and replace them into the pack.</p> <p>Replace the battery with a new one or recharge it.</p>
<p>2. No sound comes from the speaker.</p>	<p>VOLUME CONTROL knob is completely anti-clockwise.</p> <p>The unit is in the transmit mode, by the PTT switch.</p> <p>Channel number is set at other than 01 to 40.</p>	<p>Turn the knob clockwise to a suitable level.</p> <p>Put the unit in the receive mode.</p> <p>Set the channel number to your desired one.</p>

PROBLEM	POSSIBLE CAUSE	SOLUTION
<p>2. No sound comes from the speaker. (Continued)</p>	<p>SQUELCH setting is turned too far clockwise.</p> <p>External speaker (or earphone) is in use.</p> <p>The battery has been exhausted.</p>	<p>Turn the SQUELCH CONTROL anti-clockwise until noise can be heard and reset it just below the threshold.</p> <p>Check if the external speaker plug is inserted properly or if the external speaker cable is cut.</p> <p>Replace the battery with a new one or recharge it.</p>
<p>3. Sensitivity is low and only strong signals are audible.</p>	<p>Bad connection of the flexible antenna.</p> <p>The antenna feed line is cut or shorted. (When using an external antenna).</p>	<p>Check the connection of the antenna and correct any problems.</p> <p>Check the feed line and correct any problems.</p>
<p>4. Low or No RF output.</p>	<p>RF POWER switch is set at the Low position.</p> <p>The battery has been exhausted.</p> <p>The antenna feed line is cut or shorted. (When using an external antenna).</p>	<p>Set the RF POWER switch to the High position.</p> <p>Replace the battery with a new one or recharge it.</p> <p>Check the antenna feed line and correct any problems.</p>

PROBLEM	POSSIBLE CAUSE	SOLUTION
<p>5. No modulation. (When using external microphone).</p>	<p>Bad connection of the MIC connector.</p> <p>The MIC cable is cut.</p>	<p>Check the connection of the MIC connector and correct any problems.</p> <p>Repair the disconnected or cut wire.</p>
<p>6. The receive mode functions properly and your signals are transmitted, but you are unable to make contact with another station. (When desiring REPEATER mode.)</p> <p>(When desiring, SIM- PLEX mode.)</p>	<p>The REPEATER/SIMPLEX Switch is in the SIMP position.</p> <p>The REPEATER/SIMPLEX Switch is in the RPT position.</p>	<p>Set the REPEATER/SIMPLEX Switch in the RPT position.</p> <p>Set the REPEATER/SIMPLEX Switch in the SIMP position.</p>

## SECTION VIII OPTIONS

ICOM has a variety of options for the IC-40 in order to expand its use:-

**1. BC-36 Nickel-Cadmium Battery Charger**

A convenient set-in type charger for Nickel-Cadmium power packs. Two charging rates provided high speed and regular rate. The charger is compatible with any type of Nickel-Cadmium power packs.

**2. IC-BP2 Nickel-Cadmium Power Pack**

This power pack has six AA type 400mAH Nickel-Cadmium batteries and provides 1.5W output power for the IC-40 with longer attendant use capability. Recharge time, when using the BC-36 is 1-1/2 hours.

**3. IC-BP4 Battery Case**

This case will accept dry batteries, zinc or alkaline, for 2W output, or Nickel-Cadmium for 1.5W output power. It holds six cells. When Nickel-Cadmium are installed the BC-36 can be used to recharge the batteries.

**4. IC-BP5 Nickel-Cadmium Power Pack**

This power pack has nine AA type 400mAH Nickel-Cadmium batteries and provides 3W output power, plus longer operating capability. It can be recharged by the BC-36 in 1-1/2 hours.

**5. IC-BP8 Nickel-Cadmium Power Pack**

This power pack has seven AA type 800mAH Nickel-Cadmium batteries and provides 2 watts output power, plus extra longer operating capability. It can be either recharged by the BC-36 in 2-3 hours or BC-27 in 15 hours.

**6. IC-CP1 Cigarette Lighter Recharger for IC-BP3**

A handy way to recharge the Nickel-Cadmium packs while mobile - plus in the cigarette lighter.

**7. IC-HM9 Speaker/Microphone**

A handy speaker and microphone in one unit. Clips on the clothing and operates as both speaker and microphone when plugged in the unit.

**8. IC-DC1 DC Regulator**

Allows direct operation from car battery with IC-CP1.

**9. IC-MB16**

A convenient drop in mounting bracket for mobile use.

**10. HS-10 Headset**

Headphone boom mike for "hands free" operation.

**11. HS-10SB Switchbox**



Switchbox for use with HS-10.

**12. Leather Case**

To protect your unit.

**13. Shoulder Strap**

## POWER PACK SPECIFICATIONS

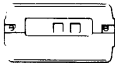
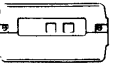
	IC-BP2	IC-BP3	IC-BP4	IC-BP4	IC-BP5	IC-BP8
Cells [CAPACITY]	N-425AR (X 6) [400mAH]	N-250AA (X 7) [250mAH]	AA Size Alkaline (X 6)	AA Size Nickel Cadmium (X 6)	N-425AR (X 9) [400mAH]	N-800AR (X 7) [800mAH]
Voltage	7.2V	8.4V	9.0V	7.2V	10.8V	8.4V
RF Output	1.5W	2.0W	2.0W	1.5W	3.0W	2.0W
Charging	Rapid	Normal		Normal	Rapid	Rapid/Normal
Charging Time	1 ~ 1.5H	15H		15H	1 ~ 1.5H	2-3H/15H
Suitable Charger	BC-36	BC-36 BC-27 CP-1		BC-36	BC-36	BC-36 BC-27
Charging Current	600mA	25mA		45mA	600mA	600mA/80mA
Ambient Temp	+10°~+40°C	0°~+45°C		0°~+45°C	+10°~+40°C	+10°~+40°C
Overcharge Protect	○	X		X	○	○
Current Selector						
Height	39m/m	39m/m	49m/m	49m/m	60m/m	80m/m
Battery	X	X	○	○	X	X

## SECTION IX FREQUENCY CHART

### CITIZENS BAND FREQUENCY CHART

Channel	Channel Frequency in MHz	Channel	Channel Frequency in MHz
1	476.425	21	476.925
2	476.450	22	476.950
3	476.475	23	476.975
4	476.500	24	477.000
5	476.525	25	477.025
6	476.550	26	477.050
7	476.575	27	477.075
8	476.600	28	477.100
9	476.625	29	477.125
10	476.650	30	477.150
11	476.675	31	477.175
12	476.700	32	477.200
13	476.725	33	477.225
14	476.750	34	477.250
15	476.775	35	477.275
16	476.800	36	477.300
17	476.825	37	477.325
18	476.850	38	477.350
19	476.875	39	477.375
20	476.900	40	477.400



### REPEATER OPERATING FREQUENCIES

CHANNEL	RECEIVER
CH1	476.425MHz
CH2	476.450
CH3	476.475
CH4	476.500
CH5	476.525
CH6	476.550
CH7	476.575
CH8	476.600

CHANNEL	TRANSMIT
CH31	477.175MHz
CH32	477.200
CH33	477.225
CH34	477.250
CH35	477.275
CH36	477.300
CH37	477.325
CH38	477.350



**ICOM INCORPORATED**  
6-9-16, KAMIHIGASHI, HIRANO-KU,  
OSAKA 547, JAPAN

A-0627  
Printed in Japan