



INSTRUCTION MANUAL

UHF C.R.S. TRANSCEIVER
IC-41S

Icom Inc.



IMPORTANT

READ ALL INSTRUCTIONS carefully and completely before using the transceiver.

SAVE THIS INSTRUCTION MANUAL — This instruction manual contains important operating instructions for the **IC-41S UHF C.R.S. TRANSCEIVER**.

EXPLICIT DEFINITIONS

WORD	DEFINITION
⚠ WARNING	Personal injury, fire hazard or electric shock may occur.
CAUTION	Equipment damage may occur.
NOTE	If disregarded, inconvenience only. No risk of personal injury, fire or electric shock.

Icom, Icom Inc. and the  ICOM logo are registered trademarks of Icom Incorporated (Japan) in the United States, the United Kingdom, Germany, France, Spain, Russia and/or other countries.

PRECAUTIONS

⚠ CAUTION! NEVER hold the transceiver so that the antenna is very close to, or touching exposed parts of the body, especially the face or eyes, while transmitting. The transceiver will perform best if the microphone is 5 to 10 cm away from the lips and the transceiver is vertical.

⚠ CAUTION! NEVER operate the transceiver with a headset or other audio accessories at high volume levels.

⚠ CAUTION! NEVER short the terminals of the battery pack.

DO NOT push [PTT] when not actually desiring to transmit.

AVOID using or placing the transceiver in direct sunlight or in areas with temperatures below -30°C or above $+60^{\circ}\text{C}$.

The basic operations, transmission and reception of the transceiver are guaranteed within the specified operating temperature range. However, the LCD display may not be operate correctly, or show an indication in the case of long hours of operation, or after being placed in extremely cold areas.

DO NOT modify the transceiver for any reason.

KEEP the transceiver from the heavy rain, and **never** immerse it in the water. The transceiver construction is **water resistant**, not waterproof.

The use of non-Icom battery packs/chargers may impair transceiver performance and invalidate the warranty.



N33

This device complies with Standard Australia Specification No. AS/NZS 4365-2002 and AS/NZS 4295: 2004.

TABLE OF CONTENTS

IMPORTANT	i
EXPLICIT DEFINITIONS	i
PRECAUTIONS	i
TABLE OF CONTENTS	iii
1 ACCESSORIES	1–3
■ Supplied accessories	1
■ Accessory attachments	1
2 PANEL DESCRIPTION	4–9
■ Front panel	4
■ Function display	6
■ Programmable function keys	8
3 BASIC OPERATION	10–15
■ Turning power ON	10
■ Channel selection	11
■ Receiving and transmitting	11
■ Priority channel setting	13
■ Monitor function	14
■ Lock function	14
■ Adjusting the squelch level	14
■ Display backlighting	15
■ Set mode	15
4 REPEATER OPERATION	16
■ Repeater operation	16
■ Accessing a repeater	16
5 SCAN OPERATION	17–21
■ Scan types	17
■ Scanning preparation	18
■ Open scan	19
■ Group and priority scans	20
■ Repeater search scan	21
6 TONE SQUELCH OPERATION	22–24
■ Tone squelch operation	22
■ Pocket beep operation	24
7 SELCALL OPERATION	25–29
■ General	25
■ Calling operation	25
■ When receiving a call	28
■ The quiet mode operation	29
■ Stun function	29
8 OTHER FUNCTIONS	30–33
■ Smart-Ring and ATS (Automatic Transponder System)	30
■ RX frequency setting (for RX channels only)	31
■ Wide/Narrow function	33
■ PTT hold function	33
9 SET MODE	34–38
■ Set mode	34
■ Set mode items	35
10 BATTERY CHARGING	39–43
■ Caution	39
■ Battery chargers	41
11 BATTERY CASE	44
■ Optional battery case (BP-240)	44
12 OPTIONAL SWIVEL BELT CLIP	45–46
■ MB-93 contents	45
■ Attaching	45
■ Detaching	46
13 OPTIONS	47–48
14 SPECIFICATIONS	49
15 WARRANTY	50

■ Supplied accessories

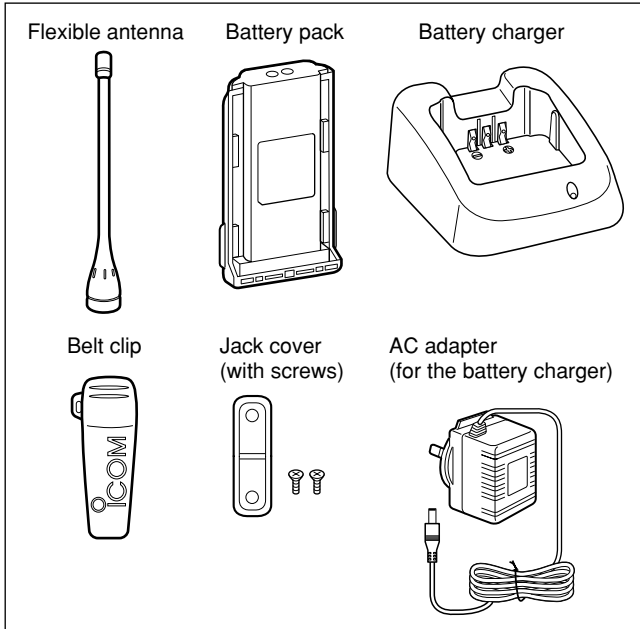

■ Accessory attachments

◇ Flexible antenna

Connect the supplied flexible antenna to the antenna connector.

CAUTION!

- **NEVER HOLD** the antenna when carrying the transceiver.
- Transmitting without an antenna may damage the transceiver.

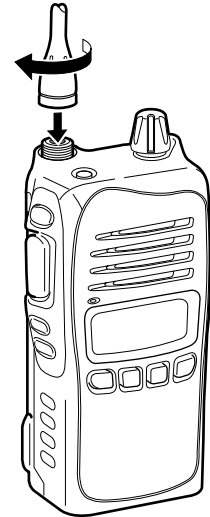

1 ACCESSORIES

◇ Battery pack

To attach the battery pack:

Slide the battery pack in the direction of the arrow (❶), then lock it with the battery release button.

- Slide the battery pack until the battery release button makes a 'click' sound.

To release the battery pack:

Push the battery release button in the direction of the arrow (❷). Then slide the battery pack in the direction opposite to the arrow (❶).

/// **NEVER** release or attach the battery pack when the transceiver is wet or soiled. This may result water or dust getting into the transceiver/battery pack and may result in the transceiver being damaged.

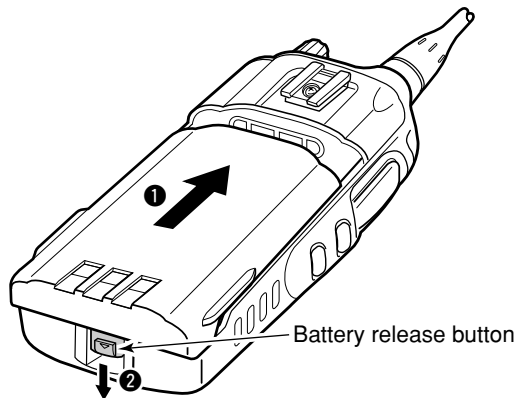

◇ Belt clip

To attach the belt clip:

- ❶ Release the battery pack if it is attached.
- ❷ Slide the belt clip in the direction of the arrow until the belt clip is locked and makes a 'click' sound.

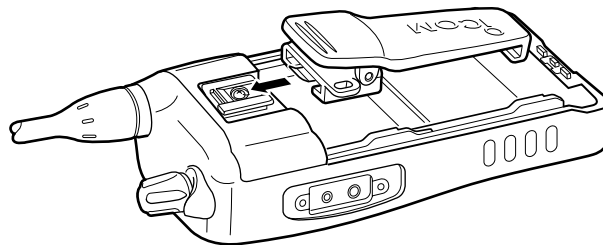

To detach the belt clip:

- ❶ Release the battery pack if it is attached.
- ❷ Pinch to lift the clip (❶), and slide the belt clip in the direction of the arrow (❷).

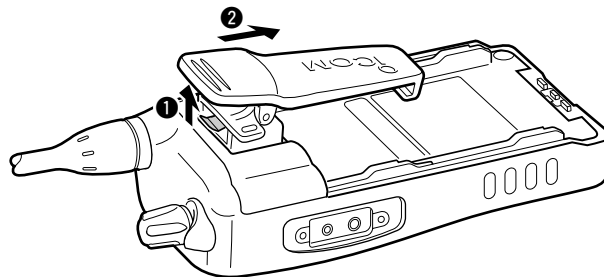

◇ Jack cover

Attach the jack cover when the optional speaker-microphone or headset is not used.

To attach the jack cover:

- 1 Attach the jack cover to the [MIC/SP] jack.
- 2 Tighten the screws using a Phillips screwdriver.

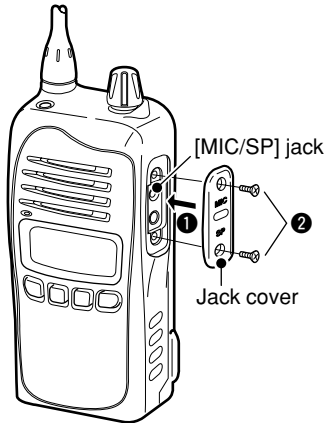

To detach the jack cover:

- 1 Unscrew the screws using a Phillips screwdriver.
- 2 Detach the jack cover for the optional speaker-microphone or headset connection.

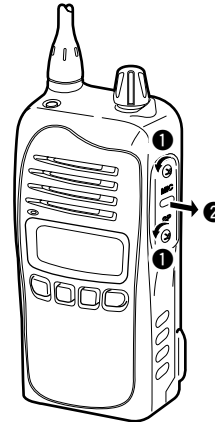

CAUTION!
Use the supplied screws only.

■ Front panel

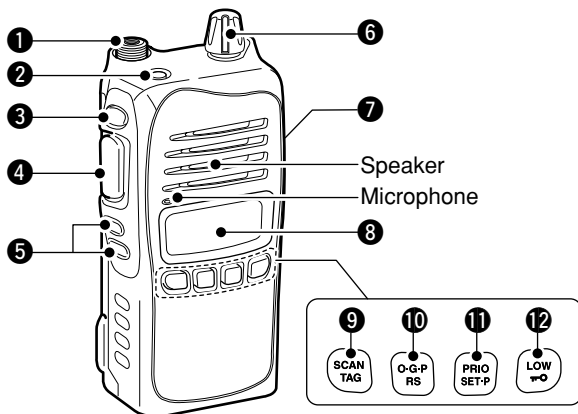

Information: Up to four desired functions, one each for Normal and Function mode, can be re-assigned to **[Top]**, **[Side1]**, **SCAN TAG**, **O-G-P RS**, **PRIORITY SET-P** and **LOW** keys with the optional CS-41S CLONING SOFTWARE. (p. 8)
The default setting is used in this instruction manual, for description.

[N] : Stands for Normal mode operation.
[F] : Stands for Function mode operation. (Push **[Top]** (Function) to enter Function mode.)

① ANTENNA CONNECTOR

Connects the supplied antenna.

② TOP KEY* [Top]

[N] (Function/Set Mode)

- Push to turn Function mode ON.
 - “**[F]**” appears when Function mode is turned ON.
- Push and hold for 2 sec. to enter Set mode. (p. 34)



[F] (Function/RX VFO)

- Push to turn the Function mode OFF.
 - “**[F]**” disappears when Function mode is turned OFF.
- Push and hold for 2 sec. to enter RX VFO mode. (RX channel ‘RX-XX’ operation only) (p. 31)

NOTE: Returns to the Normal mode automatically after 30 sec. when no key operation is performed in Function or Set mode.

③ SIDE1 KEY* [Side1]

[N] (Monitor/TSQL)

- Push to toggle the monitor function ON or OFF. (p. 14)
- Push and hold for 2 sec. to activate the following functions in order.
 - Subaudible tone encoder and Tone squelch/DTCS squelch (“**T SQL**” appears) (p. 23)
 - Pocket beep (“**T SQL** ” appears) (p. 24)
 - No tone operation (“**T SQL** ” disappears)

[F] (SQL/ATS)

- Push to enter the squelch level setting mode, then push **[CH Up]** or **[CH Down]** to set the squelch level. (p. 14)
- Push and hold for 2 sec. to turn the ATS (automatic transponder system) function ON or OFF. (p. 30)

4 PTT SWITCH [PTT] (p. 12)

Push and hold to transmit; release to receive.

5 CH UP/CH DOWN KEYS [CH UP]/[CH DOWN]

Push to select an operating channel, set mode setting, etc. (pgs. 11, 34)

6 VOLUME CONTROL [VOL] (pgs. 10, 11)

Rotate to turn the power ON/OFF and adjusts the audio level.

7 EXTERNAL MICROPHONE/SPEAKER JACK

Connect an optional speaker-microphone or headset.

NOTE: Connect or disconnect the optional equipment after the transceiver is turned OFF.



Jack cover

NOTE: Attach the jack cover when the optional equipment is not used. See (p. 3) for details.

8 FUNCTION DISPLAY (p. 6)

Displays a variety of information such as an operating channel number/name, SelCall code, selected function, etc.

9 SCAN/TAG KEY* 

 (Scan/Scan Tag)

➔ Push to start or stop the scan. (pgs. 19, 20)

➔ Push and hold for 2 sec. to set or clear the displayed channel as a TAG (scanned) channel. (p. 18)

• “**S**” appears when the selected channel is tagged.

 (TX Code CH/Call)

➔ Push to enter the SelCall TX code channel selection mode, then push **[CH Up]** or **[CH Down]** to select. (CB channel operation only) (p. 25)

➔ Push and hold for 2 sec. to transmit to the SelCall TX code channel. (CB channel operation only) (p. 27)

10 O•G•P/RS KEY* 

 (Scan Mode/Rpt Scan)

➔ Push to select the scan type from open scan, group scan and priority scan in order. (p. 18)

• “**OS**” appears when the open scan is selected, “**GS**” appears when the group scan is selected, and “**PS**” appears when the priority scan is selected.

➔ Push and hold for 2 sec. to start the repeater scan. (p. 21)

• Repeater output channel ‘CB-R1’ to ‘CB-R8’ operation only

 (Quiet/ID-MR)

➔ Push to toggle the quiet function ON or OFF. (CB channel ‘CB-XX’ operation only) (p. 29)

• “**Q**” appears when the quiet function is turned ON.

➔ Push and hold for 2 sec. to enter the received ID code history indication mode. (p. 28)

• “**NO ID**” is displayed when no ID code is memorized.

2 PANEL DESCRIPTION

11 PRIO/SET•P KEY*

[N] (PRIO/PRIO Set)

- ➔ Push to select the priority channel. (p. 13)
- ➔ Push and hold for 2 sec. to set the displayed channel as the priority channel. (p. 13)



[F] (S-Ring/PRIO Clear)

- ➔ Push to transmit the Smart-Ring signal. (p. 30)
 - When RX channel is selected, “N/A” appears.
- ➔ Push and hold for 2 sec. to cancel the priority channel setting. (p. 13)

12 LOW/“” KEY*

[N] (RF Power/Lock)

- ➔ Push to toggle the transmit output power level. (p. 11)
- ➔ Push and hold for 2 sec. to electronically lock all keys except the following (p. 14):

[PTT], **[Side1]** (Monitor), **[Top]** (Function),  (Call) and  (Lock)

Push and hold for 2 sec. again to turn the lock function OFF.

[F] (Dup/Zone)

- ➔ Push to toggle the selected channel between duplex or simplex operation. (Depending on pre-setting)
 - Duplex operation can be selected in ‘CB-R1’ to ‘CB-R8’ only.
- ➔ Push and hold for 2 sec., then select the desired zone with **[CH Up]** or **[CH Down]**. (p. 11)
 - Available only when more than two zones are set.

■ Function display

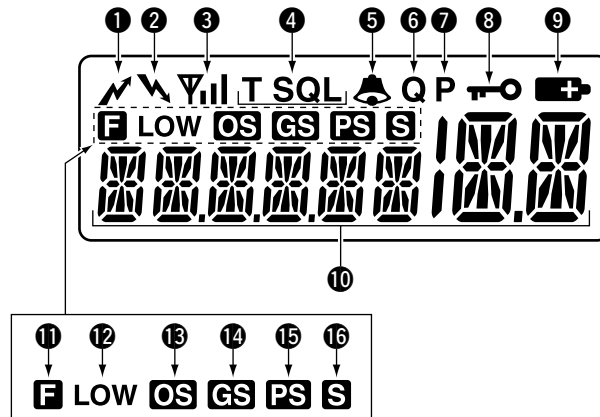

1 TRANSMIT INDICATOR

Appears while transmitting.

2 BUSY INDICATOR

Appears while the channel is busy.

3 SIGNAL STRENGTH INDICATOR

Indicates relative signal strength level.

- “∇” blinks when the ATS function is in use. (p. 30)

4 TONE INDICATORS (p. 23)

- ➔ “T” appears while the Subaudible tone encoder is in use.
- ➔ “T SQL” appears while the Tone squelch/DTCS squelch function is in use.

5 BELL INDICATOR

- Appears when the pocket beep function is in use. (p. 24)
- Blinks when the specified SelCall or Smart Ring call is received. (pgs. 28, 30)

6 QUIET INDICATOR (p. 29)

Appears when the Quiet function is ON (SelCall mute is activated.)

7 PRIORITY CHANNEL INDICATOR (p. 13)

Appears when the priority channel is set.

8 KEY LOCK INDICATOR (p. 14)

Appears during the key lock function is ON.

9 BATTERY INDICATOR

Appears or blinks when the battery capacity decreases to a specified level.

10 ALPHANUMERIC DISPLAY

The operating channel number, channel name, Set mode contents etc. is displayed.

11 FUNCTION INDICATOR

- Appears during the Function mode is ON.
- A secondary function of the key can be access.

12 LOW POWER INDICATOR (p. 11)

- Appears when low output power or dry battery mode is selected.
- When the battery power decreases to a specified level, low power is selected automatically.

13 OPEN SCAN INDICATOR (p. 19)

Appears when the 'Open scan' is selected.

14 GROUP SCAN INDICATOR (p. 20)

Appears when the 'Group scan' is selected.

15 PRIORITY SCAN INDICATOR (p. 20)

Appears when the 'Priority scan' is selected.

16 SCAN CHANNEL INDICATOR

Appears when the selected channel is specified as a tag (scanned) channel.

Information:

"N/A" appears when the pushed key is not available.

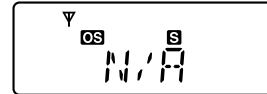

■ Programmable function keys

The following functions can be assigned to **[Top]**, **[Side1]**, **SCAN TAG**, **O-G-P RS**, **PRIO SET:P** and **LOW** programmable function keys with the optional CS-41S CLONING SOFTWARE.

The key function activates after pushing **[Function]** when the programmable function key is assigned to the function mode operation.

If the programmable function names are bracketed in the following explanations, the specific key is used to activate the function depends on the programming.

Scan/Scan Tag

- Push to start/stop the scan.
- Push and hold for 2 sec. to set or clear the displayed channel as a TAG channel.

Scan Mode/Rpt Scan

- Push to select the scan mode.
- Push and hold for 2 sec. to start repeater scan.

PRIO/PRIO Set

- Push to select the priority channel.
- Push and hold for 2 sec. to set the displayed channel as the priority channel.

S-Ring/PRIO Clear

- Push to transmit the Smart-Ring call.
 - When RX channel is selected, "N/A" appears.
- Push and hold for 2 sec. to cancel the priority channel setting.

Monitor/TSQL

(This key function can be assigned in the Normal mode only.)

- Push to toggle the monitor function ON or OFF.
- Push and hold for 2 sec. to activate the following functions in order.
 - Subaudible tone encoder and Tone squelch/DTCS squelch
 - Pocket beep
 - No tone operation.

RF Power/Lock

- Push to toggle the transmit output power level.
- Push and hold for 2 sec. to toggle key lock function ON and OFF.

TX Code CH/Call

- Push to enter the TX code channel selection mode, then push **[CH Up]** or **[CH Down]** to select the desired channel (CB channel operation only).
- Push and hold for 2 sec. to transmit the specified SelCall TX code in the selected channel (CB channel operation only).

Quiet/ID-MR

- Push to quiet function ON or OFF (CB channel operation only).
- Push and hold for 2 sec. to enter the received ID code history indication mode.

SQL/ATS

- Push to enter the squelch level setting mode, then push **[CH Up]** or **[CH Down]** to set the squelch level.
- Push and hold for 2 sec. to turn the ATS (Automatic Transponder System) function ON and OFF.

Dup/Zone

- Push to set the selected channel as Duplex or Simplex operation.
 - Duplex channel can be selected in 'CB-R1' to 'CB-R8' only.
- Push and hold this key for 2 sec. then push **[CH Up]** or **[CH Down]** to select the desired zone. (Available only when more than two zones are set.)

Function/Set Mode

(This key function can be assigned to the **[Top]** key only.)

- Push to turn Function mode ON or OFF.
- Push and hold for 2 sec. to the Set mode ON or OFF.
 - After entering the Set mode, push this key momentarily to select the item, and push **[CH Up]** or **[CH Down]** to change the setting.

Function/RX VFO

(This key function can be assigned to the **[Top]** key only.)

- Push to turn Function mode ON or OFF.
- Push and hold for 2 sec. to enter the RX VFO mode.
 - In RX VFO mode, the operating frequency and the channel spacing setting can be changed.

SQL/Set Mode

(This key function can be assigned to the **[Top]** key only.)

- Push to enter the squelch level setting mode, then push **[CH Up]** or **[CH Down]** to set the squelch level.
- Push and hold for 2 sec. to the Set mode ON or OFF.
 - After entering the Set mode, push this key momentarily to select the item, and push **[CH Up]** or **[CH Down]** to change the setting.

■ Turning power ON

▨ Prior to using the transceiver for the first time, the battery pack must be fully charged for optimum life and operation. (p. 39)

- ① Rotate [VOL] to turn the power ON.
- ② If the transceiver is programmed for a start up password, input the digit codes as directed by your dealer.
 - The keys in the table below can be used for password input:
 - The transceiver detects numbers in the same block as identical. Therefore “01234” and “56789” are the same.

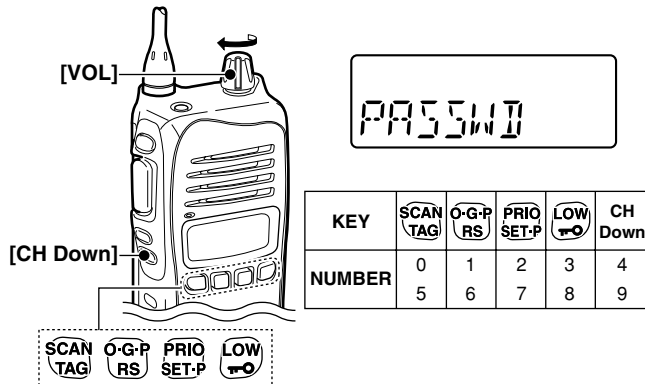

- ③ When the “PASSWD” indication does not clear after inputting 4 digits, the input code number may be incorrect. Turn the power off and start over in this case.

◇ Battery type selection

The battery type **MUST** be selected according to the type of battery attached when turning the transceiver ON. Ask your dealer for details.

▨ **NOTE:** When the selected battery type is not matched to the attached battery, the transceiver does not work correctly.

- ① Turn the power OFF in advance.
- ② While pushing and holding [Top] and [PTT], rotating [VOL] to turn power ON to toggle the attaching battery type.
 - After the display appears, release [Top] and [PTT].
 - “DRY” is displayed for about 3 sec. then “LOW” appears when the Alkaline battery operation is selected. In this case, the transmit output power is low.
 - “LI-ION” is displayed for about 3 sec. when the Lithium-ion battery operation is selected.

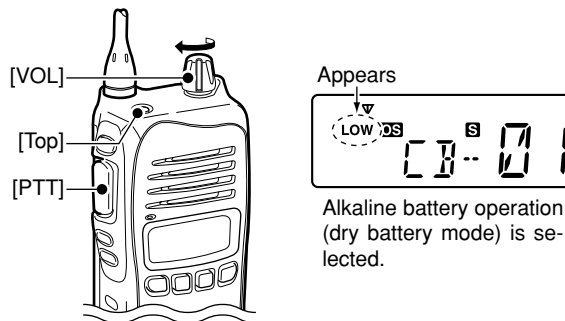

■ Channel selection

- Push **[CH Up]** or **[CH Down]** to select the desired channel.
 - While pushing and holding **[CH Up]** or **[CH Down]**, the displayed channel changes continuously until channel 1 is selected.
 - When channel 1 is selected, beeps are emitted.
 - ‘CB-XX’ appears when the CB channel is selected and ‘RX-XX’ appears when the RX channel is selected.

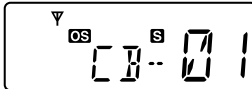

◇ Zone type selection

(Available only when more than two zones are set.)

- ① Push **[Top]** (Function) to enter the function mode, and push and hold  (Zone) for 2 sec. to enter the zone select mode.

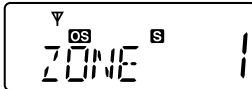

- ② Push **[CH Up]** or **[CH Down]** to select the desired zone, then push  (Zone) again to set.



NOTE:

- The selected channel is retained even when the transceiver is turned off.
- ‘CB-05,’ ‘CB-R5’ and ‘CB-35’ channels are used for the emergency. And ‘CB-22’ and ‘CB-23’ channels are used for telemetry and telecommand applications, so the voice communications are not available on these channels.

■ Receiving and transmitting

NOTE: Transmitting without an antenna may damage the transceiver. See page 1 for accessory attachments.

Receiving:

- ① Rotate **[VOL]** to turn the power ON.
 - If “**T SQL**” appears on the display, push and hold **[Side1]** for 2 sec. once or twice to cancel the tone squelch or pocket beep. (pgs. 23, 24)
- ② Select the desired operating channel as at left.
 - When receiving a signal, “” appears and audio is emitted from the speaker.
 - Further adjustment of **[VOL]** may be necessary at this point.
 - Push **[Side1]** to toggle the monitor function ON and OFF.
- ③ Push  (RF Power) to select the output power if necessary.
 - “**LOW**” appears when low power is selected.
 - Choose low power to conserve battery power, choose high power for longer distance communications.

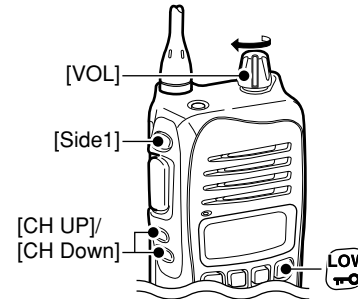

3 BASIC OPERATION

Transmitting:

Wait for the channel to become clear to avoid interference.

- ① While pushing and holding **[PTT]**, speak into the microphone at a normal voice level.
 - “**M**” appears.
 - A PTT hold function is available. See p. 33 for details.
- ② Release **[PTT]** to return to receive.

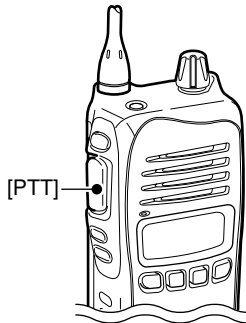

IMPORTANT: To maximize the readability of your signal;

1. Pause briefly after pushing **[PTT]**.
2. Hold the microphone 5 to 10 cm from your lips, then speak into the microphone at a normal voice level.

◇ **Transmitting notes**

• **Transmit inhibit function**

The transceiver has several inhibit functions which restrict transmission under the following conditions:

- The channel is busy or un-matched CTCSS/DTCS is received. (Depending on the transmission lockout function setting.)
- The selected channel is a 'receive only' channel.

• **Time-out timer**

After continuous transmission for the pre-programmed time period, the time-out timer is activated, causing the transceiver to stop transmitting.

• **Penalty timer**

Once the time-out timer and lockout is activated, transmission is further inhibited for a period determined by the penalty timer.

Priority channel setting

The priority channel, simply recalled by pushing $\overline{\text{PRIO SET:P}}$ (PRIO), and also is automatically monitored during the priority scan. You can set the only one channel as the priority channel. "P" appears when the priority channel is set.

◆ The priority channel selection

- Push $\overline{\text{PRIO SET:P}}$ (PRIO) to select the priority channel.
 - "N/A" appears when the priority channel is not set.

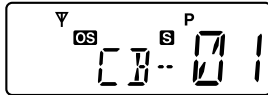

The priority channel is selected.

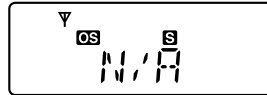

When the priority channel is not set.

◆ Set the priority channel

- ① Select the desired channel. (p. 11)
- ② Push and hold $\overline{\text{PRIO SET:P}}$ (PRIO Set) for 2 sec. to set the displayed channel as the priority channel.

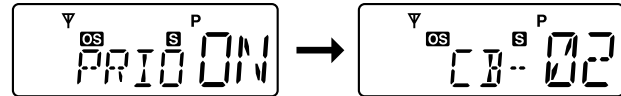

The selected channel is set to the priority channel.

◆ Cancel the priority channel setting

- Push [Top] (Function) to enter the function mode, then push and hold $\overline{\text{PRIO SET:P}}$ (PRIO Clear) for 2 sec. to cancel the priority channel setting.
 - "P" disappears.

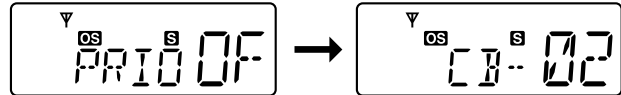

The priority channel is cancelled.

3 BASIC OPERATION

■ Monitor function

This function is used to listen to weak signal or to open the tone squelch manually.

- ➔ Push **[Side1]** (Monitor) to toggle the monitor function ON and OFF.
 - “” blinks when the monitor function is in use.

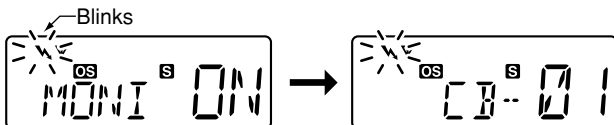

■ Lock function

This function electronically locks all keys except for **[PTT]**, **[Side1]** (Monitor), **[Top]** (Function), **SCAN TAG** (Call) and **LOW** (Lock) to prevent accidental channel changes and function access.

- ➔ Push and hold **LOW** (Lock) for 2 sec. to toggle the lock function ON and OFF.
 - “” appears when the lock function is in use.

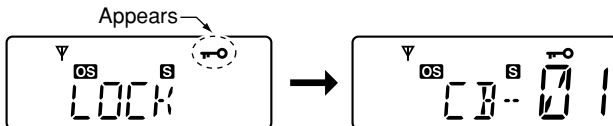

■ Adjusting the squelch level

In order to receive signals properly, the squelch must be adjusted to the proper level.

- ① Push **[Top]** (Function) to enter the function mode, then push **[Side1]** (SQL) to enter the squelch level setting mode.
- ② Push **[CH Up]** or **[CH Down]** to adjust the squelch level within 0 to 9 ranges.
- ③ Push **[Side1]** (SQL) to exit the squelch level setting mode.



■ Display backlighting USING SET MODE

The transceiver has display backlight for night-time operation.

- ① Push and hold **[Top]** (Set Mode) for 2 sec. to enter set mode.
- ② Push **[Top]*** several times until “**LIGHT**” appears.
- ③ Push **[CH Up]** or **[CH Down]** to select the display backlight condition.
 - **ON** : Backlight lights continuously.
 - **A2** : Lights for 5 sec. when any key except **[PTT]** is pushed, or the LCD indication is changed.
 - **AT** : Lights for 5 sec. when any key except **[PTT]** is pushed or the Selcall signal is transmitted/received.
 - **OF** : Backlight never lights.

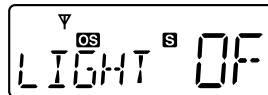
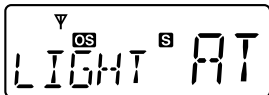
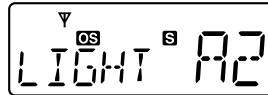
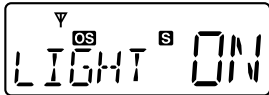

- ④ Rotate **[VOL]** to turn the power OFF, or push and hold **[Top]** (Set Mode) for 2 sec. to exit set mode.

*Regardless of the assigned key function.

■ Set mode

Set mode is accessed at power ON and allows you to set seldom-changed settings. In this case you can “customize” the transceiver operation to suit your preferences and operating style. See p. 34 for set mode items detail.

Entering the set mode:

- ① While pushing and holding **[CH Up]** and **[CH Down]**, rotate **[VOL]** to turn the power ON. Then, push and hold **[Top]** (Set Mode) for 2 sec. to enter set mode.
- ② Push **[Top]*** several times to select the appropriate item. Then push **[CH Up]** or **[CH Down]** to set the desired level/condition.
 - Available set mode functions are **SQL Level, CTCSS tone/DTCS code, Auto power OFF, Backlight, Beep, Beep Level, Mic Gain, Battery Voltage, Signal Moni, Power Save, TOT, Lock-out, Scan Stop Timer, Scan Restart, Roger Beep and Own ID.**
- ③ Rotate **[VOL]** to turn the power OFF, or push and hold **[Top]** (Set Mode) for 2 sec. to exit set mode.

NOTE: Set mode can be accessed via the **[Top]** (Set Mode) key operation only (p. 34.) In this case, set mode allows quicker item selection. Set “Enable” to the most often used items with the CS-41S CLONING SOFTWARE.

*Regardless of the assigned key function.

■ Repeater operation

Repeaters allow you to extend the operational range of your radio.

Normally, a repeater has independent frequencies for receive and transmit.

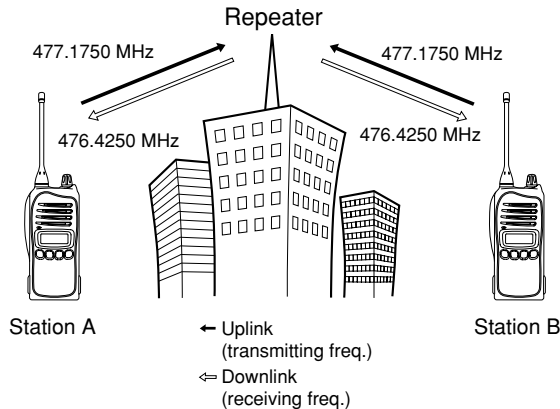

■ Accessing a repeater

A repeater amplifies received signals and re-transmits them on a different frequency, allowing you to communicate over greater distances with improved reliability. When using a repeater, the repeater output channel ('CB-R1' to 'CB-R8') must be selected.

You can search the accessible repeater in your local area using the Repeater search scan function (p. 21).

- ① Select the desired repeater output channel ('CB-R1' to 'CB-R8'). (p. 11)
- ② While pushing and holding **[PTT]**, speak into the microphone at your normal voice level.
 - "↗" appears.

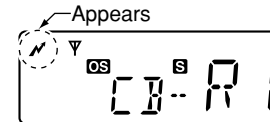

- ③ Release **[PTT]** to receive.

■ Scan types

The transceiver has 4 scan types, tag function and 4 resume conditions providing scanning versatility.

Tag channels are independently set for open, group and priority scans. Initially, all channels may be set as tag channels for all scans.

OPEN SCAN

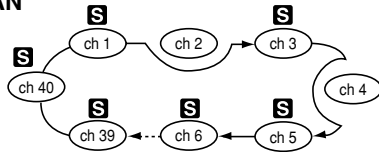

Repeatedly scans all tag channels in sequence.

GROUP OR PRIORITY SCAN

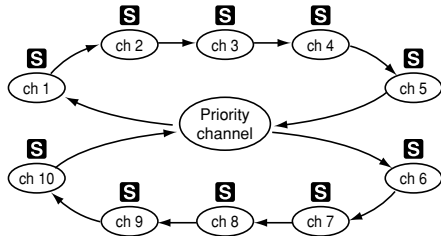

Repeatedly watches a designated priority channel after scanning 5 tagged channels.

REPEATER SEARCH SCAN

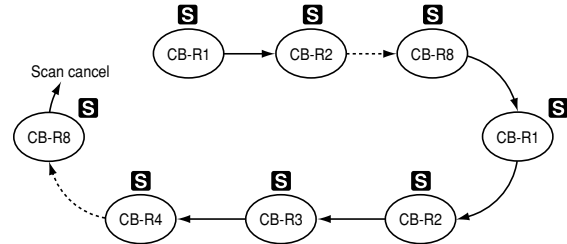

Scans all repeater channels ('CB-R1' to 'CB-R8') in sequence. If there are no busy channels after scanning channels 'CB-R1' to 'CB-R8,' it begins scanning from 'CB-R1' again, then the transceiver transmits a signal to search for a repeater while the scanning.

5 SCAN OPERATION

■ Scanning preparation

IC-41S scans all tagged channels, and can be selected so the scan resume condition is a pause or timer scan.

Therefore, these items must be set before starting a scan (except the repeater search scan). These items must be set for each scan type (open, group and priority) independently.

◇ Scan type selection

➔ Push  (Scan Mode) several times to select the desired scan type.

- Open, group and priority scans are available.
- “OPEN”, “GROUP” or “PRIO” is displayed for 1 sec. when each scan type is selected.

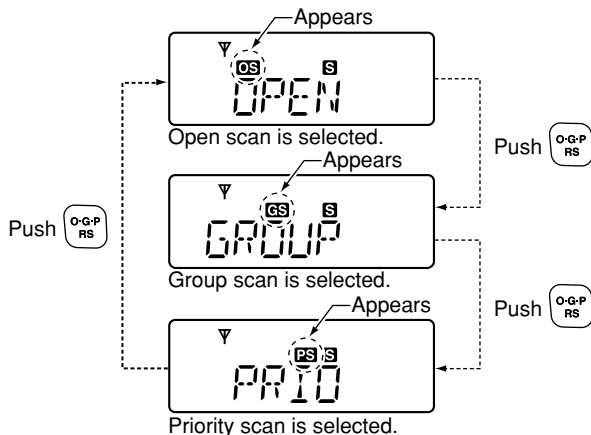

◇ Tag channel setting

- ① Select the desired scan type. (See at left.)
- ② Select the desired channel. (p. 11)
- ③ Push and hold  (Scan Tag) for 2 sec. to toggle the tag channel setting ON and OFF.
 - “S” appears when the tag setting is ON (The channel is set as a scan channel).

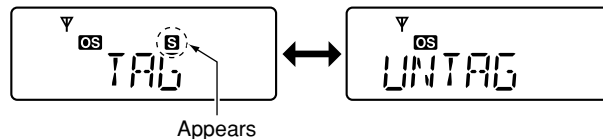

▨ To speed up scanning:

For open scan, cancel the tag channel setting to skip undesired channels such as usually busy channels.

For group scan, set only often-used channels as tag channels.

All memory channels may be set as tag channels by default.

◆ **Setting scan resume condition** USING SET MODE

- ① Push and hold **[Top]** (Set Mode) for 2 sec. to enter set mode.
- ② Push **[Top]*** several times until “S-TIME” appears.
- ③ Push **[CH Up]** or **[CH Down]** to select the scan timer.
 - **5** : Scan pauses for 5 sec. then resumes.
 - **10** : Scan pauses for 10 sec. then resumes.
 - **15** : Scan pauses for 15 sec. then resumes.
 - **P5** : Scan pauses until the signal disappears, then resumes 5 sec. after the signal disappears.

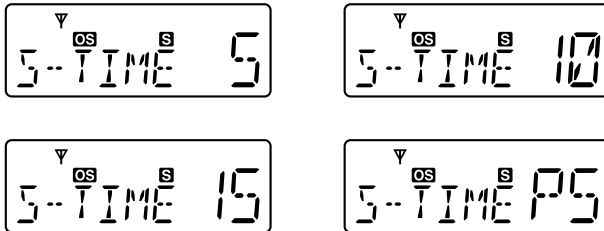

- ④ Rotate **[VOL]** to turn the power OFF, or push and hold **[Top]** (Set Mode) for 2 sec. to exit set mode.

■ **Open scan**

Open scan searches for being transmitted signals automatically and makes it easier to locate new stations for contact or listening purposes.

IMPORTANT!

During open scan, transmission is inhibited except on a busy channel.

- ① Push **[OS/RS]** (Scan Mode) several times to select the open scan. (p. 18)
 - “**OS**” appears.

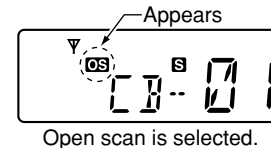

- ② Push **[SCAN TAG]** (Scan) to start the open scan.

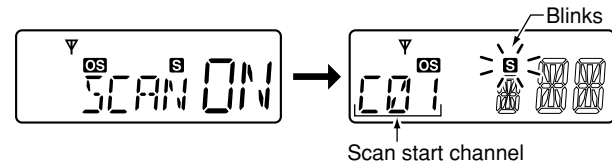

- ⑤ When receiving a signal, scan pauses and resumes according to the selected scan resume condition. (p. 19)
- ⑥ Push **[OS/RS]** (Scan) to cancel the scan.

5 SCAN OPERATION

■ Group and priority scans

Group and priority scans repeatedly watch a priority channel while scanning specified channels. This is useful when waiting for a call on the priority channel or several specified channels.

Group and priority scans behave differently when transmitting. Group scan can only transmit on a busy channel, and priority scan can only transmit on a priority channel or start channel.

- ① Push  (Scan Mode) several times to select the group or priority scan. (p. 18)
 - “GS” appears when the group scan is selected, and “PS” appears when the priority scan is selected.

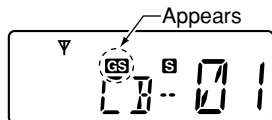

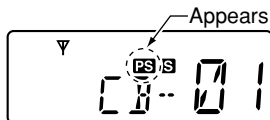

Group scan is selected.

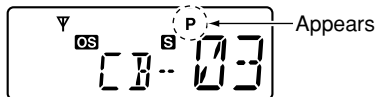

Priority scan is selected.

- ② Set the priority channel if desired when the priority scan type is selected in step ①. (p. 13)
 - When the priority channel is not set, scan start channel is monitored during the priority scan.



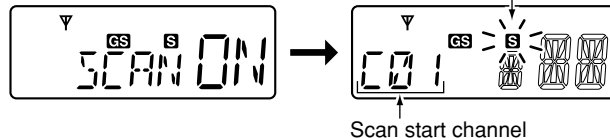

- ③ Push  (Scan) to start the scan.

Group scan starts.

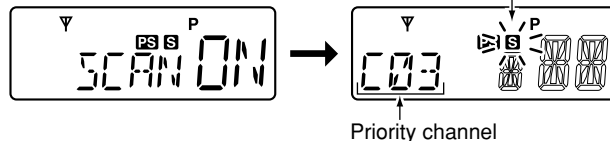

Priority scan starts.



- ④ When receiving a signal, the scan pauses and resumes according to the selected scan resume condition. (p. 19)
- ⑤ Push  (Scan) to cancel the scan.

■ Repeater search scan

The repeater search scan is not only searching for a signal on the repeater channels, but also access a repeater by transmitting automatically in sequence.

Thus the repeater search scan function searches an available repeater in the area even if the repeater is not in use.

▨ The repeater search scan detects a signal on the repeater output channels (CB-R1 to CB-R8) only. Therefore, repeater availability cannot be guaranteed even the repeater scan is stopped, because the scan will stop if any activity is detected. (The scan is cancelled when receiving a signal, such as stations communicating in simplex operation on a repeater output channel.)

- ① Select the desired repeater output channel ('CB-R1' to 'CB-R8'), and push and hold  (Rpt Scan) for 2 sec. to start the repeater search scan.
 - See the flow as described at right for repeater search scan details.

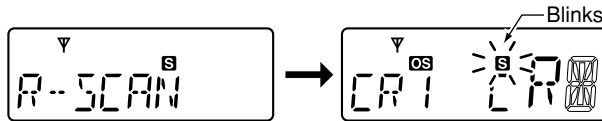

- ② When receiving a signal on the repeater channel, scan stops.
 - During second cycle scanning, 3 high beeps sound when receiving a signal, and 3 low beeps sound when no signal receiving.
- ③ Push  (Scan Mode) to cancel the scan manually.
 - During transmitting, the repeater scan cannot be cancelled.

◇ Repeater search scan flow

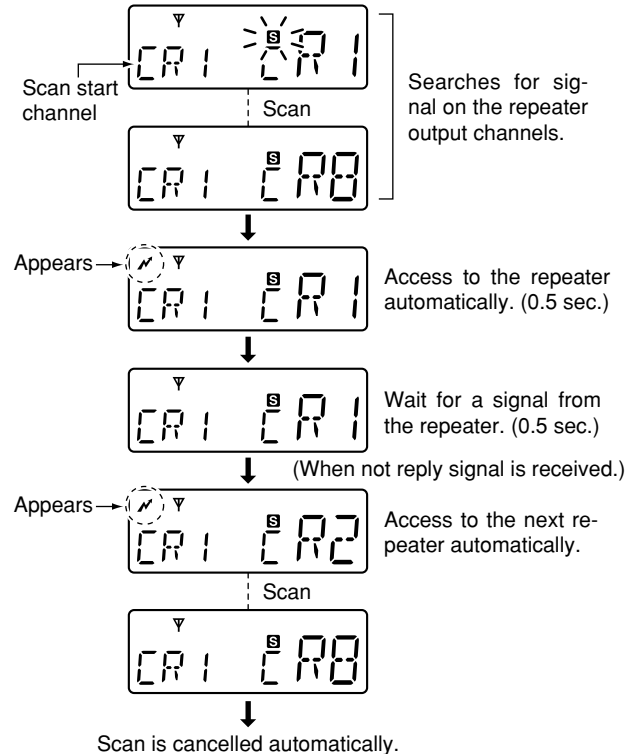

■ Tone squelch operation

The transceiver is equipped with 51 CTCSS tone frequencies, 104 DTCS codes. CTCSS/DTCS operation provides communication with silent standby since you will only receive calls from group members using the same CTCSS tone frequency/DTCS code.

/// **NOTE:** Channels 5 and 35 are used for the emergency channels, and CTCSS/DTCS operation is not available on these channels.

◇ Setting CTCSS tone frequency/ DTCS code

USING SET MODE

- ① Select the desired channel except for channels 5 and 35. (p. 11)
- ② Push and hold **[Top]** (Set Mode) for 2 sec. to enter set mode.
- ③ Push **[Top]** several times until "C" appears.
- ④ Push **[SCAN TAG]** to toggle the CTCSS tone frequency/DTCS code setting mode.
- ⑤ Push **[CH Up]** or **[CH Down]** to set the desired CTCSS tone frequency/DTCS code.

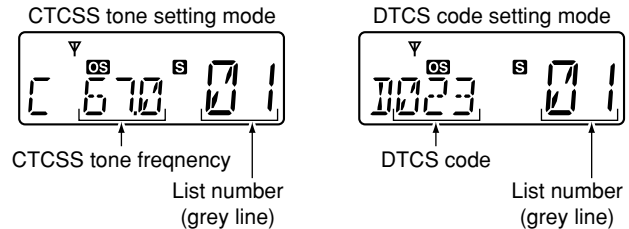

- ⑥ Rotate **[VOL]** to turn the power OFF, or push and hold **[Top]** (Set Mode) for 2 sec. to exit set mode.

• Available CTCSS tone frequency list (Hz)

No.	Freq.	No.	Freq.	No.	Freq.	No.	Freq.	No.	Freq.
01	67.0	12	94.8	23	136.5	34	177.3	45	218.1
02	69.3	13	97.4	24	141.3	35	179.9	46	225.7
03	71.0	14	100.0	25	146.2	36	183.5	47	229.1
04	71.9	15	103.5	26	151.4	37	186.2	48	233.6
05	74.4	16	107.2	27	156.7	38	189.9	49	241.8
06	77.0	17	110.9	28	159.8	39	192.8	50	250.3
07	79.7	18	114.8	29	162.2	40	196.6	51	254.1
08	82.5	19	118.8	30	165.5	41	199.5		
09	85.4	20	123.0	31	167.9	42	203.5		
10	88.5	21	127.3	32	171.3	43	206.5		
11	91.5	22	131.8	33	173.8	44	210.7		

/// **NOTE:** The transceiver has 51 tone frequencies and consequently their spacing is narrow compared with units having 38 tones. Therefore, some tone frequencies may receive interference from adjacent tone frequencies.

• Available DTCS code list

No.	Code	No.	Code	No.	Code	No.	Code	No.	Code
01	023	22	131	43	251	64	371	85	532
02	025	23	132	44	252	65	411	86	546
03	026	24	134	45	255	66	412	87	565
04	031	25	143	46	261	67	413	88	606
05	032	26	145	47	263	68	423	89	612
06	036	27	152	48	265	69	431	90	624
07	043	28	155	49	266	70	432	91	627
08	047	29	156	50	271	71	445	92	631
09	051	30	162	51	274	72	446	93	632
10	053	31	165	52	306	73	452	94	654
11	054	32	172	53	311	74	454	95	662
12	065	33	174	54	315	75	455	96	664
13	071	34	205	55	325	76	462	97	703
14	072	35	212	56	331	77	464	98	712
15	073	36	223	57	332	78	465	99	723
16	074	37	225	58	343	79	466	100	731
17	114	38	226	59	346	80	503	101	732
18	115	39	243	60	351	81	506	102	734
19	116	40	244	61	356	82	516	103	743
20	122	41	245	62	364	83	523	104	754
21	125	42	246	63	365	84	526		

◇ Turning ON the tone squelch operation

- ① Select the desired channel except for channels 5 and 35. (p. 11)
- ② Set the desired CTCSS tone frequency/DTCS code in set mode. (See at left page)
- ③ Push and hold **[Side1]** (TSQL) for 2 sec. several times until **"T SQL"** appears.
- ④ When the received signal includes a matching tone or code, squelch opens and the signal can be heard.
 - When the received signal is not matched, tone squelch does not open, however, "🔊" appears.
 - To open the squelch manually, push **[Side1]**.

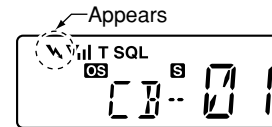

- ⑤ Operate the transceiver in the normal way.
- ⑥ To cancel the tone squelch operation, push and hold **[Side1]** (TSQL) for 2 sec. several times until **"T SQL"** disappears.

/// **NOTE:** CTCSS tone frequency/DTCS code and tone squelch ON/OFF settings are automatically stored in memory channels for easy recall.

6 TONE SQUELCH OPERATION

■ Pocket beep operation

This function uses CTCSS (subaudible) tones and DTCS code for calling and can be used as a “common pager” to inform you that someone has called while you were away from the transceiver.

◇ Waiting for a call from a specific station

- ① Select the desired channel except for channels 5 and 35.
(p. 11)
- ② Set the desired CTCSS tone/DTCS code in set mode.
(pgs. 22, 35)
- ③ Push and hold **[Side1]** (TSQL) for 2 sec. several times until “**T SQL** 📞” appears to activate the pocket beep.
- ④ When the received signal includes a matching tone or code, the transceiver emits beep tones every 10 sec. and “📞” blinks.

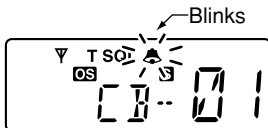

- ⑤ Push **[PTT]** to answer and to stop blinking.
 - Tone squelch is automatically selected.

■ General

In addition to the tone squelch operation for silent stand-by, the SelCall operation is available. SelCall is an abbreviation for “Selective Calling.” In tone squelch operation, there are 155 ways to make an individual call with CTCSS tone frequencies/DTCS codes versus 100,000 ways to make an individual call with SelCall using 5tone.

SelCall allows you to selectively call another unit that is operating on the same channel.

SelCall can also call the entire group on that channel using tone squelch code.

The caller station code/name, status message, Answer Back function, automatic scan start function, etc. are available with SelCall operation. A variety of functions are available depending on the setting with the CS-41S CLONING SOFTWARE. See the help file for setting details.

NOTE:

- Channels 5 and 35 are used for the emergency channels, and SelCall operation is not available on these channels.
- SelCall transmission is restricted for total of 3 sec. in a minute. If you try to transmit over 3 sec., “N/A” appears (when  (Call) is pushed,) or error beep is emitted (when **[PTT]** is pushed.)

■ Calling operation

◇ TX code channel selection

 (TX Code CH) enables you to change the TX code channel with **[CH Up]** or **[CH Down]**.

 **TX code** means the Transmitting SelCall code. Max. 32 TX code channels can be pre-programmed into the transmitter using the optional CS-41S CLONING SOFTWARE.

To select a TX code channel:

- ① Select the desired CB channel (‘CB-XX’) except for channels 5 and 35. (p. 11)
- ② Push **[Top]** (Function) to enter the function mode, then push  (TX Code CH) to enter the TX code channel selection mode.
 - The channel name is displayed instead of the TX code, if the channel name is programmed.

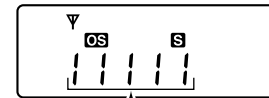

TX code

- ③ Push **[CH Up]** or **[CH Down]** to select the desired TX code channel.

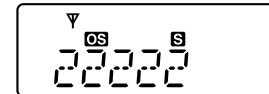

7 SELCALL OPERATION

- ④ Push **[PTT]** to transmit to the selected TX code channel, or push **SCAN TAG** (TX Code CH) to set the selected TX code channel and return to the stand-by mode.

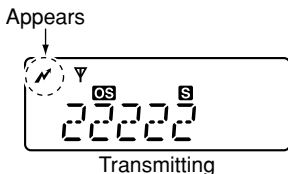

✓ CONVENIENT!

The TX code channel name can be assigned to the all 32 TX code channel via the optional CS-41S CLONING SOFTWARE. The TX code channel name allows you to easy to select the channel, find the channel user, and so on.

◇ TX code number edit

SCAN TAG (TX Code CH) enables you to change the TX code contents within the allowable digits.

The group call function works by allowing you to edit a special 'group code' into the last 2 digits position of the SelCall ID code.

To edit a TX code:

- ① Select the desired CB channel ('CB-XX') except for channels 5 and 35. (p. 11)
- ② Push **[Top]** (Function) to enter the function mode, then push **SCAN TAG** (TX Code CH) to enter the TX code channel selection mode.
 - Push **[CH Up]** or **[CH Down]** to select the desired TX code channel, if desired.
- ③ Push and hold **SCAN TAG** (TX Code CH) for 2 sec. again to enter the TX code edit mode.

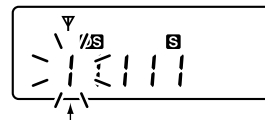

The editable digit starts blinking

- ④ Push **SCAN TAG** (TX Code CH) to select the desired digit to be edited.

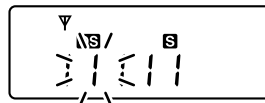

- ⑤ Push **[CH Up]** or **[CH Down]** to set the desired code.
 • Select “*” when group code is set.

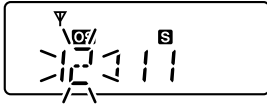

- ⑥ Push **[SCAN TAG]** (TX Code CH) to set the digit and the editable digit move to right automatically.

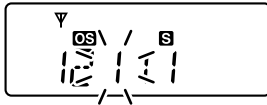

- ⑦ Repeat step ⑤ and ⑥ to input all allowed digits.
 ⑧ After setting the last digit, push **[SCAN TAG]** (TX Code CH) to set the code and return to the TX code channel selection mode.

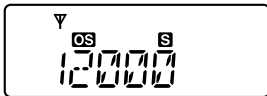

- ⑨ Push **[PTT]** to transmit to the selected TX code channel, or push **[SCAN TAG]** (TX Code CH) to set the selected TX code channel and return to the stand-by mode.

Appears

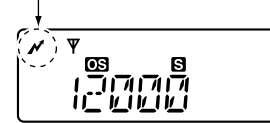

Transmitting

/// **NOTE:** The TX code editable digit can only be set/changed with the optional CS-41S CLONING SOFTWARE.

◇ Transmitting an individual call

- Push **[Top]** (Function) to enter the function mode, then push and hold **[SCAN TAG]** (Call) for 2 sec. to transmit.

Appears

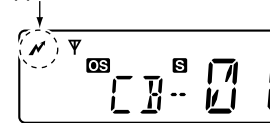

Transmitting

■ When receiving a call

◇ Receiving an individual call

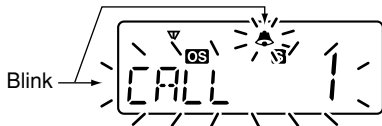

- ① When receiving an individual call (default setting);
 - “PiRo” beeps sound.
 - The received code channel name is displayed.
 - “📞” and the displayed channel name blink, and the SelCall mute is released when the quiet mode is activated.
- ② While pushing and holding [PTT], speak into the microphone at a normal voice level.



NOTE: When the ID decode function is turned ON, the received ID code is displayed instead of the channel name, and memorised into the transceiver. The ID decode function can be turned ON using the optional CS-41S CLONING SOFTWARE.

- **RX code** means the Receiving SelCall code. Max. 8 RX code channels can be pre-programmed into the transceiver using the CS-41S.
- You can set the transceiver's condition when receiving an individual call using the CS-41S. See the help file for setting details.

Recall the memorised RX code:

- ① Push [Top] (Function) to enter the function mode, then push and hold  (ID-MR) for 2 sec. to display the memorised RX code.
- ② Push [CH Up] or [CH Down] to select the desired RX code.
- ③ Push [Top] (Function) to enter the function mode, then push and hold  (Call) for 2 sec. to transmit the code on the selected channel.

◇ Receiving a group call

- ① When receiving a group call (default setting);
 - “PiPi” beep sounds.
 - “📞” and “GROUP” blink, and the SelCall mute is released when the quiet mode is activated.
- ② While pushing and holding [PTT], speak into the microphone at a normal voice level.

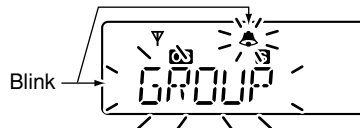

You can set the transceiver's condition when receiving a group call with the CS-41S. See the help file for setting details.

■ The quiet mode operation

When the quiet mode operation is turned ON, the SelCall mute is activated and allows the silent operation until receiving a SelCall.

- Push **[Top]** (Function) to enter the function mode, then push  (Quiet) to toggle the quiet mode ON and OFF.
 - “Q” appears when the quiet mode is in use.

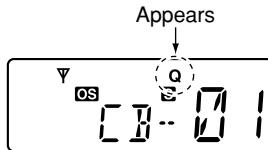

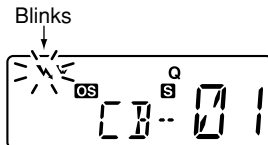

To monitor the channel:

- Push **[Side1]** (Monitor) to release the mute (audio is emitted.)
 - “” blinks when the monitor function is in use.



To enable SelCall mute:

- When “” blinks, push **[Side1]** (Monitor) to mute the channel.
 - “” disappears.

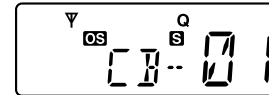

NOTE: The unmute condition may automatically return to the mute condition after a specified time period depending on the pre-setting.

■ Stun function

When the specified ID, set as a killer ID, is received, the stun function is activated. (PC programming is required.)

When the killer ID is received, the transceiver switches to the password required condition. Entering of the password via the keypad is necessary to operate the transceiver again in this case. (p. 10)

Smart-Ring and ATS (Automatic Transponder System)

These functions have an answer back feature, and allow you to confirmation of whether or not a call has reached the receiving party even if the operator is temporarily away from the transceiver. The Smart-Ring is for manual, and the ATS is for automatic confirmation.

Smart-Ring

- Set the same CTCSS tone frequency for all of the group transceivers and turn the tone squelch ON. (pgs. 22, 34)
- Push **[Top]** (Function) to enter the function mode, then push **PRIG SET-P** (S-Ring) to send the Smart-Ring call.
 - “**↗**” appears.
 - When a member of a specific group answers a call, “**🔔**” and “**FOUND**” blink.
 - When no answer back is received, the transceiver emits short failure beep tones and “**FAILED**” appears.

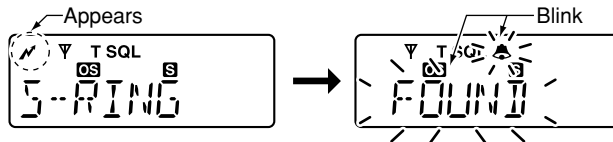

- Push **[PTT]** to answer and to stop blinking.

NOTE: The Smart-Ring function is available only when the called station has set the same CTCSS tone frequency and the same operating channel as you.

NOTE:

- The setting at left is for the calling station only. A called party automatically sends an answer back signal without any pre-settings. All IC-41S's operating on the same operating channel will answer back to the call in the surroundings communications area.
- When RX channel is selected, “**N/A**” appears.

ATS

- Push **[Top]** (Function) to enter the function mode, then push and hold **[Side1]** (ATS) for 2 sec. to turn the ATS function ON.
 - When RX channel is selected, error beep is emitted.
 - The transceiver starts to send a searching signal every 60 sec.
 - “**↗**” appears and “**▽**” starts blinking on the display when the function is activated.
 - When the transceiver receives an answer back signal, “**▽**” stays on the display until the next search transmit.
 - If no reply is received, “**▽**” blinks until the next search transmit.

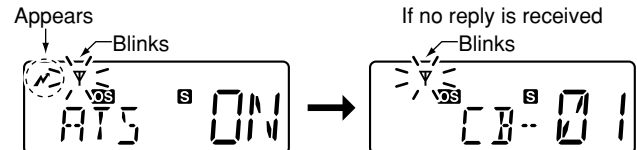

- Push **[Top]** (Function) to enter the function mode, then push and hold **[Side1]** (ATS) for 2 sec. to turn the ATS function OFF.

■ RX frequency setting (for RX channels only)

The receive frequency in the RX channels can be re-programmed within 450 to 520 MHz frequency range depending on the setting.

◇ RX channel setting

The RX channels does not appear on the LCD (default; “Inhibit” setting) and you cannot select it. So the RX channels should be set to “Enable” before programming the RX frequency.

- ① While pushing and holding SCAN TAG^* and LOW^* , turn power ON to indicate all pre-programmed RX channels (including the inhibited channels.)
- ② Select the desired channel with **[CH Up]** or **[CH Down]**, then push SCAN TAG^* to set the displayed channel “Enable.”

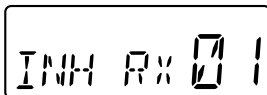

“Inhibit” setting



“Enable” setting

- ③ Turn the power OFF, then ON.
 - The “Enable” channels appear on the LCD, and can be selected with **[CH Up]**/**[CH Down]**.

◇ RX frequency programming

- ① Select the desired RX channel (‘RX-XX’). (See at left)
- ② Push **[Top]** (Function) to enter the function mode, then push and hold **[Top]** (RX VFO) for 2 sec. to enter the RX VFO mode.
 - Push LOW^* to toggle the bandwidth between wide or narrow.

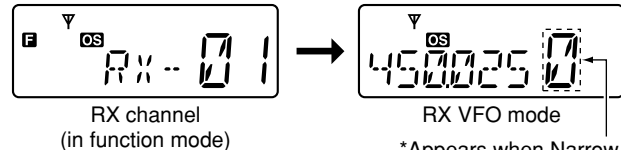

RX channel
(in function mode)

RX VFO mode

*Appears when Narrow channel spacing is set.

- ③ Push **[CH Up]** or **[CH Down]** several times to select the desired frequency.
 - The frequency changes according to the Wide/Narrow setting. (p. 33)

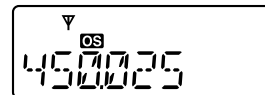

Wide channel spacing
(25 kHz steps)

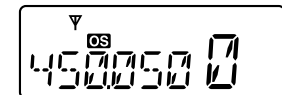

Narrow channel spacing
(12.5 kHz steps)

*Regardless of the assigned key function.

8 OTHER FUNCTIONS

- ④ Push **[SCAN TAG]*** to select the desired digit to be edited.

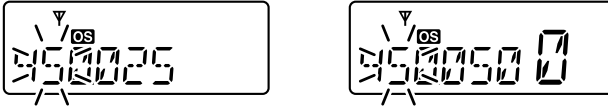

- ⑤ Set the desired digit via **[CH Up]** or **[CH Down]**.

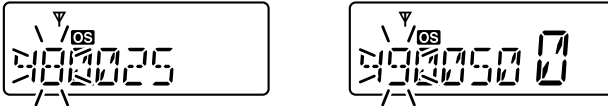

- ⑥ Push **[SCAN TAG]*** to set the digit and the editable digit move to right automatically.

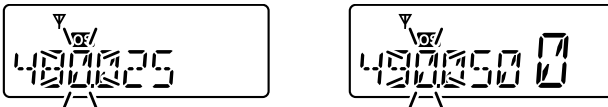

- ⑦ Repeat steps ⑤ and ⑥ to input the desired frequency.



- ⑧ Push and hold **[Top]*** for 2 sec. to return to the normal operation condition.

- RX frequency setting is memorized to the channel.
- Pushing **[Top]*** also returns to the normal operation condition. In this case, the RX frequency setting is not memorized to the channel. (temporary operation)

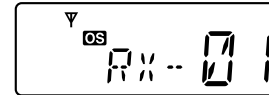

*Regardless of the assigned key function.

Wide/Narrow function

This function temporarily/permanently changes the bandwidth between wide or narrow on the RX channel only.

- ① Select the desired RX channel. (p. 31)
- ② Enter the RX VFO mode. (p. 31)
- ③ Push * to toggle the bandwidth between wide or narrow.

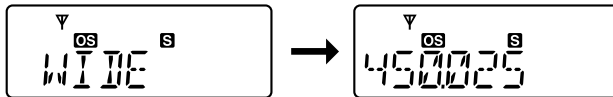

Wide channel spacing is selected

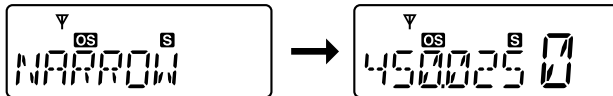

Narrow channel spacing is selected

- ④ Push and hold **[Top]*** for 2 sec. to return to the normal operation condition.
 - The bandwidth setting is memorized to the channel.
 - Pushing **[Top]*** also returns to the normal operation condition. In this case, the bandwidth setting is not memorized to the channel. (temporary operation)

*Regardless of the assigned key function.

PTT hold function

The PTT switch can be operated as a one-touch PTT switch (each push toggles between transmit/receive). Using this function you can transmit without pushing and holding the PTT switch.

To prevent accidental, continuous transmission with this function, the time-out timer function is automatically set to the transceiver. See p. 12 for details.

- ① Turn the power OFF.
- ② While pushing and holding **[PTT]**, rotate **[VOL]** to turn power ON to turn the PTT hold function ON.
 - "P-HOLD ON" is displayed for 1 sec.

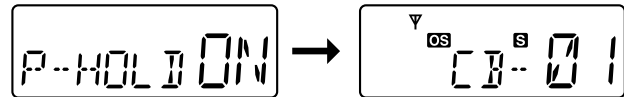

- ③ Push **[PTT]** to transmit and push again to receive.
 - "⚡" appears while transmitting.
- ④ Repeat steps ① and ② to turn the PTT hold function OFF.

NOTE for the optional microphone operation:

This function does not activate when the PTT switch on the optional microphone is pushed. And even if the transceiver transmits with this function, the PTT switch on the optional microphone must be pushed to speak.

■ Set mode

Set mode allows you to change seldom used common setting for the transceiver, or individual setting for the operating channel. In this case you can “customize” transceiver operation to suit your preferences and operating style.

Available functions may differ depending on the pre-setting via the optional CS-41S CLONING SOFTWARE.

NOTE: Set mode can be accessed via the **[Top]** (Set Mode) key operation after turning power ON with **[CH Up]** and **[CH Down]** (p. 15.) In this case, all set mode items are available.

◇ Set mode operation

- ① Push and hold **[Top]** (Set Mode) for 2 sec. to enter Set mode.
 - When no key is pushed for 30 sec. the transceiver returns to normal operation.
- ② Push **[Top]*** to select the desired item, if necessary.
- ③ Push **[CH Up]** or **[CH Down]** to select the desired condition of the item.
- ④ Rotate **[VOL]** to turn the power OFF, or push and hold **[Top]** (Set Mode) for 2 sec. to exit set mode.

*Regardless of the assigned key function.

◇ Set mode construction

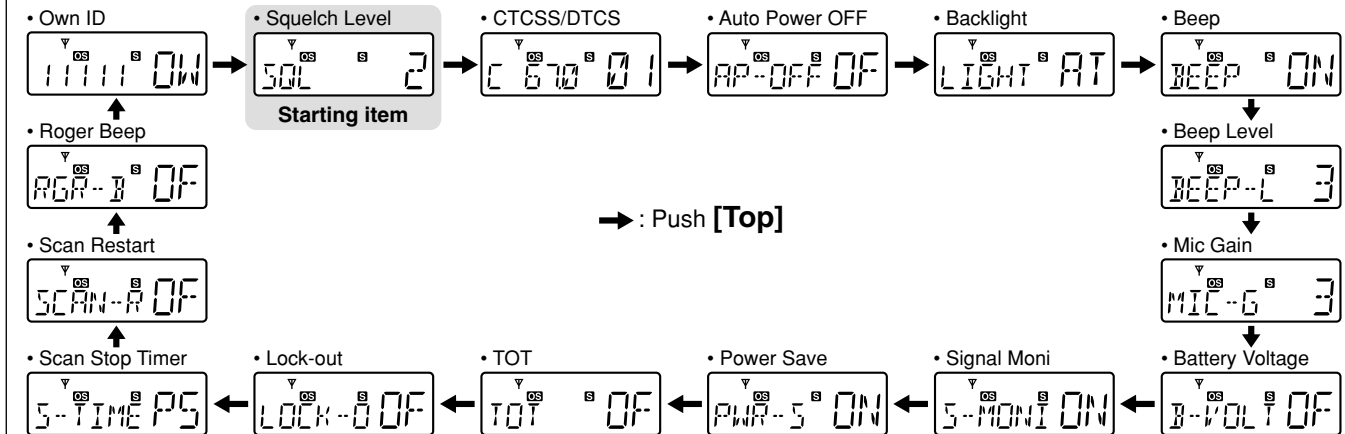

■ SET mode items

◇ Squelch level

Select the noise squelch threshold level within 0 to 9 ranges.

- There are 10 squelch levels to choose from 0 is completely open; 9 is tight squelch; 1 is loose squelch level.

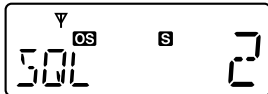

Squelch level 2 (default)

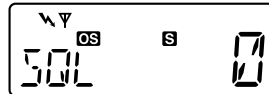

Squelch level 0 ("V" appears)

◇ CTCSS tone frequency/DTCS code

Select the desired CTCSS tone frequency or DTCS code.

Pushing toggles the CTCSS/DTCS setting mode.

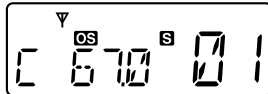

CTCSS tone frequency setting mode (default)

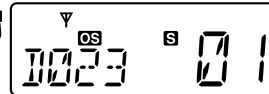

DTCS code setting mode

◇ Auto Power OFF

The transceiver can be set to automatically turn OFF after this set period has passed when no key operation is performed.

- 0.5 to 4.0 hours (0.5 hours steps) and OFF can be specified.

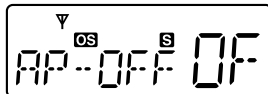

Auto power OFF is OFF (default)

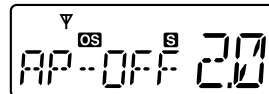

2.0 hours setting

◇ Backlight condition

The transceiver has display backlight for night-time operation.

ON : Backlight turns ON continuously.

A2 (Auto2) : Lights for 5 sec. when any key except [PTT] is pushed, or the LCD indication is changed.

AT (Auto) : Lights for 5 sec. when any key except [PTT] is pushed or the SelCall signal is transmitted/received.

OF (OFF) : No backlight available.

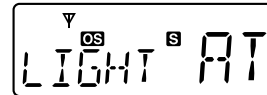

Backlight Auto (default)

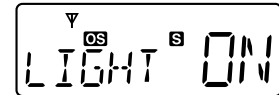

Backlight ON

◇ Beep tone

You can select silent operation by turning key-touch beep tones OFF, or you can have confirmation beeps sound at the push of a key by turning beep tones ON.

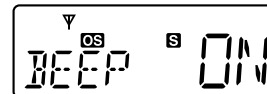

Beep tone ON (default)

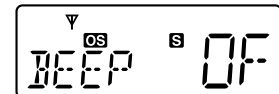

Beep tone OFF

9 SET MODE

◇ Beep level

Set the key-touch beep output level from 1 to 5.

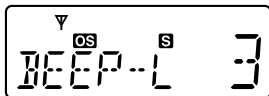

Beep level 3 (default)

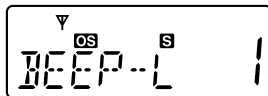

Beep level 1

◇ Microphone gain level

Set the microphone gain level from 1 (Min) to 5 (Max).

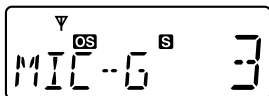

Mic gain level 3 (default)

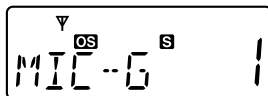

Mic gain level 1

◇ Battery voltage indicator

This function controls display or non-display settings of the connected battery pack's voltage when the power is ON.

- The voltage of the connected battery pack is displayed for 2 sec. after power is turned ON.

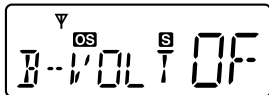

Battery voltage
OFF (default)

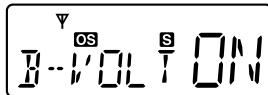

Battery voltage ON

◇ Signal Monitor function

This function controls the mute condition. The mute is released (audible) during SelCall code signal and roger beep emission.

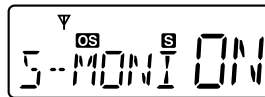

Signal monitor ON (default)

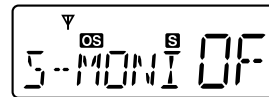

Signal monitor OFF

◇ Auto power save function

The auto power save function reduces current drain by deactivating the receiver circuit for preset interval.

This function will activate when no signal is received, and no operation is performed for 5 sec.

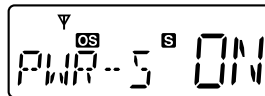

Power save ON (default)

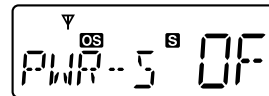

Power save OFF

◇ **Time-Out timer (TOT)**

The Time-Out Timer (TOT) function limits continuous transmission to prevent accidental prolonged transmission, etc. This timer cuts a transmission OFF after 1 min. of continuous transmission.



TOT OFF (default)

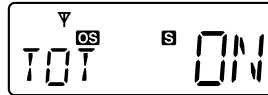

TOT ON

◇ **Lockout function**

Select the transmission lockout (temporary transmission inhibit) capability.

RP (Repeater Lockout) : Transmission is permitted only while receiving a matched CTCSS tone, or receiving no signal.

BU (Busy Lockout) : Transmission is inhibited while receiving a signal.

OF (OFF) : No restriction for receiving a signal.

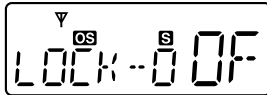

Lockout OFF (default)

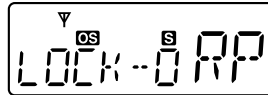

Repeater lockout setting

◇ **Scan resume timer**

The scan resume condition can be set as a pause (P5) or timer scan (15/10/5). When a signal disappears, scan resumes after 5 sec. has passed regardless of the setting.

15/10/5 : Scan pauses for 15, 10 or 5 sec. when a signal is detected, then resumes after that.

P5 : Scan pauses until the signal disappears and then resumes after 5 sec.

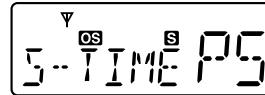

Scan resume timer
P5 (default)

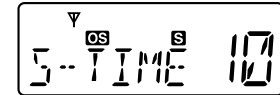

10 sec. setting

◇ **Scan restart function**

This function starts the scan after the transmission is performed during scan and 10 sec. has passed.



Scan restart timer
OFF (default)



Scan restart timer ON

9 SET MODE

◇ Roger Beep

This function emits a beep on the communication party to inform the transmission is finished.

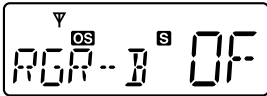

Roger beep OFF (default)

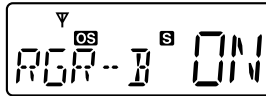

Roger beep ON

◇ Own ID

This function allows you to edit the Own ID.

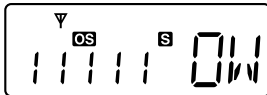

Own ID '11111'

To edit the Own ID:

- ① Push and hold **[Top]** (Set Mode) for 2 sec. to enter Set mode.
- ② Push **[Top]*** to select the "Own ID" item.
- ③ Push and hold **[SCAN TAG]*** for 2 sec. to enter the Own ID edit mode.

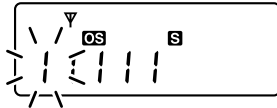

- ④ Push **[CH Up]** or **[CH Down]** several times to select the desired digit.

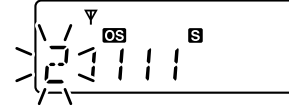

- ⑤ Push **[SCAN TAG]*** to set the digit and the editable digit move to right automatically.

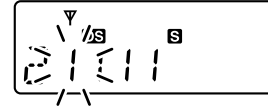

- ⑥ Repeat steps ④ and ⑤ to input the desired ID code.
- ⑦ After setting the last digit, push **[SCAN TAG]*** to set the Own ID code.

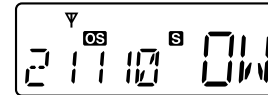

*Regardless of the assigned key function.

■ Caution

Misuse of Lithium-Ion batteries may result in the following hazards: smoke, fire, or the battery may rupture. Misuse can also cause damage to the battery or degradation of battery performance.

⚠ **DANGER!** Use and charge only specified Icom battery packs with Icom radios or Icom charger. Only Icom battery packs are tested and approved for use and charge with Icom radios or Icom charger. Using third-party or counterfeit battery packs or charger may cause smoke, fire, or cause the battery to burst.

◆ Battery caution

⚠ **DANGER! DO NOT** hammer or otherwise impact the battery. Do not use the battery if it has been severely impacted or dropped, or if the battery has been subjected to heavy pressure. Battery damage may not be visible on the outside of the case. Even if the surface of the battery does not show cracks or any other damage, the cells inside the battery may rupture or catch fire.

⚠ **DANGER! NEVER** use or leave battery packs in areas with temperatures above +60°C. High temperature buildup in the battery, such as could occur near fires or stoves, inside a sun heated car, or in direct sunlight may cause the battery to rupture or catch fire. Excessive temperatures may also degrade battery performance or shorten battery life.

⚠ **DANGER! DO NOT** expose the battery to rain, snow, seawater, or any other liquids. Do not charge or use a wet battery. If the battery gets wet, be sure to wipe it dry before using. The battery is not waterproof.

⚠ **DANGER! NEVER** incinerate used battery packs since internal battery gas may cause them to rupture, or may cause an explosion.

⚠ **DANGER! NEVER** solder the battery terminals or NEVER modify the battery pack. This may cause heat generation, and the battery may rupture, emit smoke or catch fire.

⚠ **DANGER!** Use the battery only with the transceiver for which it is specified. Never use a battery with any other equipment, or for any purpose that is not specified in this instruction manual.

⚠ **DANGER!** If fluid from inside the battery gets in your eyes, blindness can result. Rinse your eyes with clean water, without rubbing them, and see a doctor immediately.

10 BATTERY CHARGING

WARNING! Immediately stop using the battery if it emits an abnormal odor, heats up, or is discolored or deformed. If any of these conditions occur, contact your Icom dealer or distributor.

WARNING! Immediately wash, using clean water, any part of the body that comes into contact with fluid from inside the battery.

WARNING! NEVER put the battery in a microwave oven, high-pressure container, or in an induction heating cooker. This could cause a fire, overheating, or cause the battery to rupture.

CAUTION! Always use the battery within the specified temperature range for the transceiver (−30°C to +60°C) and the battery itself (−20°C to +60°C). Using the battery out of its specified temperature range will reduce the battery's performance and battery life.

CAUTION! Shorter battery life could occur if the battery is left fully charged, completely discharged, or in an excessive temperature environment (above +45°C) for an extended period of time. If the battery must be left unused for a long time, it must be detached from the radio after discharging. You may use the battery until the battery capacity becomes about half, then keep it safely in a cool dry place with the temperature between −20°C to +25°C.

◇ Charging caution

△ **DANGER! NEVER** charge the battery pack in areas with extremely high temperatures, such as near fires or stoves, inside a sun heated car, or in direct sunlight. In such environments, the safety/protection circuit in the battery will activate, causing the battery to stop charging.

WARNING! DO NOT charge or leave the battery in the battery charger beyond the specified time for charging. If the battery is not completely charged by the specified time, stop charging and remove the battery from the battery charger. Continuing to charge the battery beyond the specified time limit may cause a fire, overheating, or the battery may rupture.

WARNING! NEVER insert the transceiver (battery attached to the transceiver) into the charger if it is wet or soiled. This could corrode the battery charger terminals or damage the charger. The charger is not waterproof.

CAUTION! DO NOT charge the battery outside of the specified temperature range: BC-160 (0°C to +45°C). Icom recommends charging the battery at +20°C. The battery may heat up or rupture if charged out of the specified temperature range. Additionally, battery performance or battery life may be reduced.

■ Battery chargers

◇ Rapid charging with the BC-160

The BC-160 provides rapid charging of optional Li-Ion battery packs.

- An AC adapter (may be supplied with BC-160 depending on version) or the DC power cable (OPC-515L/CP-17L) is additionally required.
- **Charging period:** Approx. 3 hours (with BP-232N)

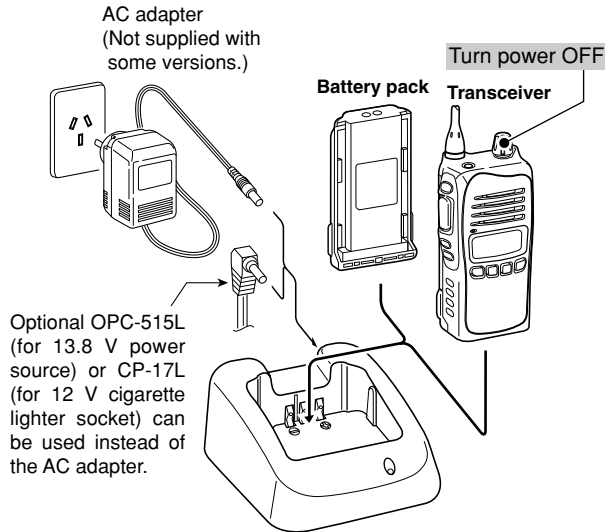

◇ AD-106 installation

- ① Install the AD-106 desktop charger adapter into the holder space of the BC-119N/BC-121N.
- ② Connect the plugs of the BC-119N/BC-121N to the AD-106 desktop charger adapter with the connector, then install the adapter into the charger with the supplied screws.

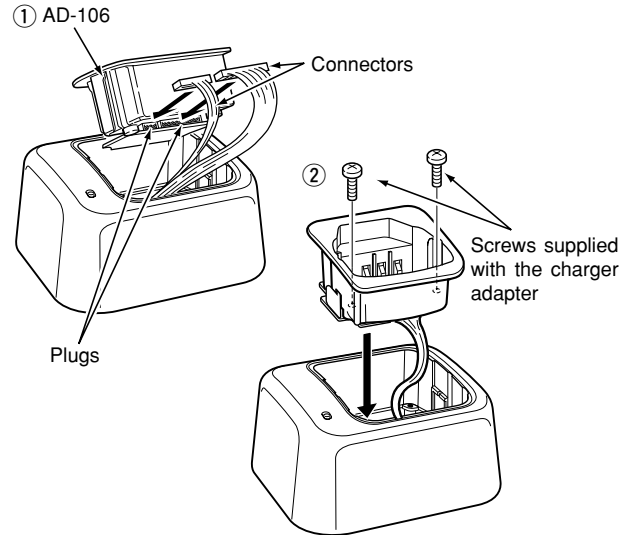

10 BATTERY CHARGING

◇ Rapid charging with the BC-119N+AD-106

The optional BC-119N provides rapid charging of battery packs. The following items are additionally required.

- AD-106 charger adapter
- An AC adapter (may be supplied with BC-119N depending on version) or the DC power cable (OPC-515L/CP-17L).
- **Charging period:** Approx. 3 hours (with BP-232N)

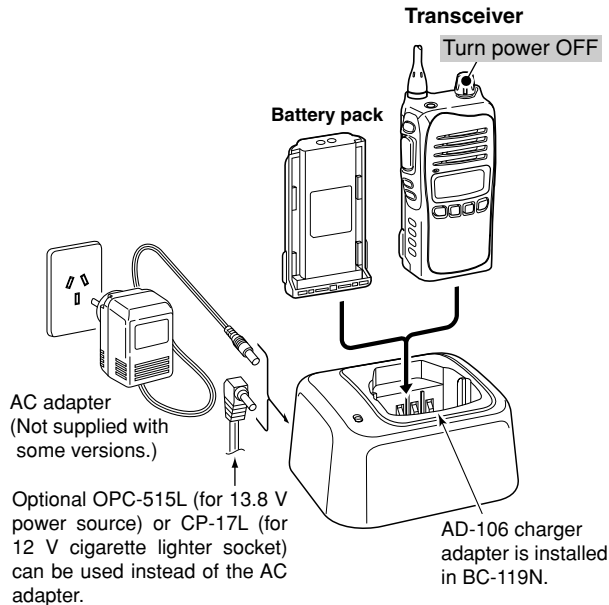

◇ Rapid charging with the BC-121N+AD-106

The optional BC-121N allows up to 6 battery packs to be charged simultaneously. The following items are additionally required.

- Six AD-106 charger adapters
- An AC adapter (BC-157) or the DC power cable (OPC-656)
- **Charging period:** Approx. 3 hours (with BP-232N)

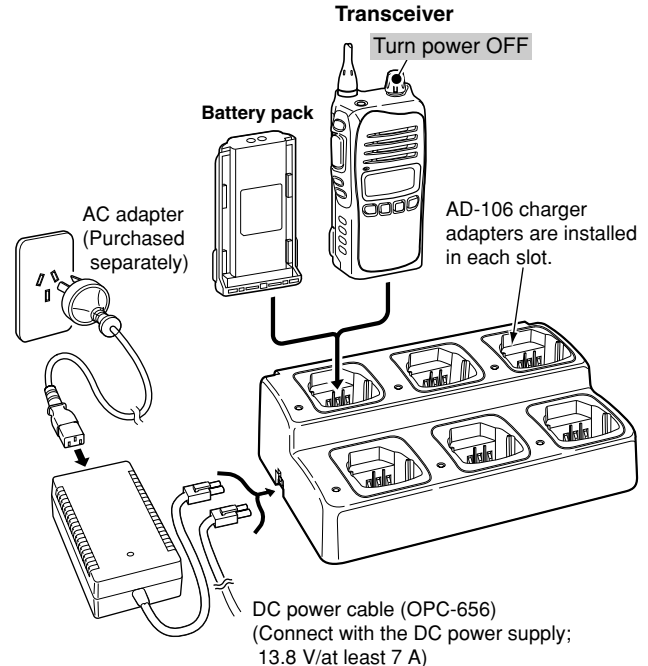

IMPORTANT!: Battery charging caution

Ensure the guide lobs on the battery pack are correctly aligned with the guide rails inside the charger adapter.
(This illustration is described with the BC-160.)

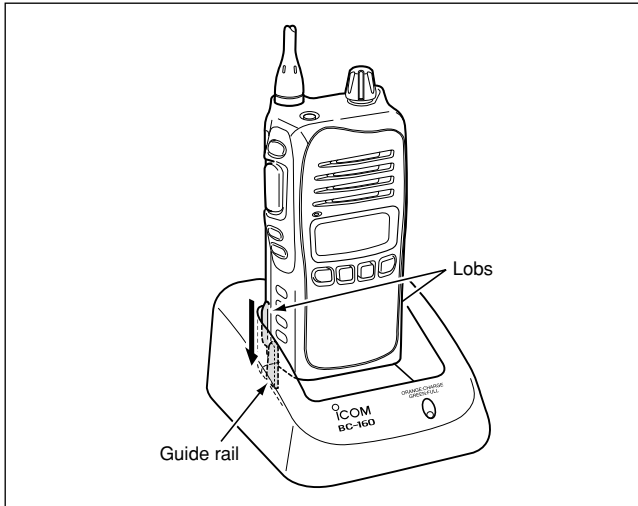

11 BATTERY CASE

■ Optional battery case (BP-240)

When using the optional battery case, install 6 × AAA (LR03) size alkaline batteries as illustrated at right.

- ① Unhook the battery cover release hook (①), and open the cover in the direction of the arrow (②). (Fig.1)
- ② Then, install 6 × AAA (LR03) size alkaline batteries. (Fig.2)
 - Install the alkaline batteries only.
 - Be sure to observe the correct polarity.
 - Do not pin the ribbon under the batteries.
- ③ Fit the cover in the direction of the arrow (③), then close (④). And hook the battery cover release hook until it makes a 'click' sound (⑤). (Fig.3)

CAUTION:

- When installing batteries, make sure they are all the same brand, type and capacity. Also, do not mix new and old batteries together.
- Keep battery contacts clean. It's a good idea to clean battery terminals once a week.
- Never incinerate used battery cells since internal battery gas may cause them to rupture.
- Never expose a detached battery case to water. If the battery case gets wet, be sure to wipe it dry before using it.

NOTE: When the optional battery case is attached, the battery type must be selected to dry battery mode when turning the transceiver ON. (p. 10)

Fig.1

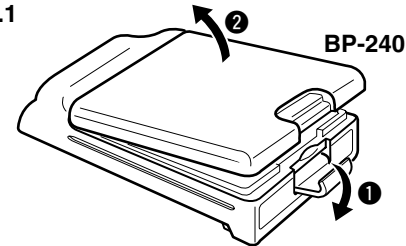

Fig.2

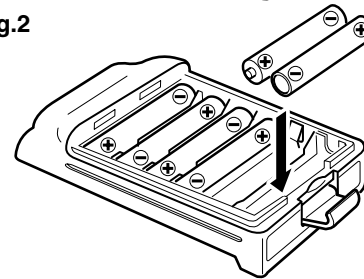
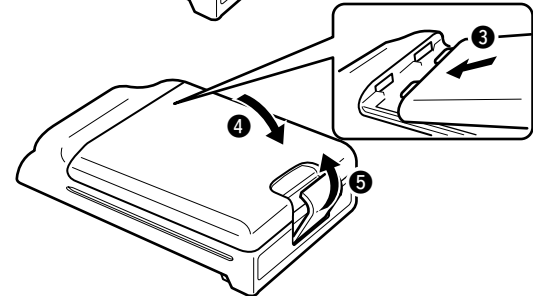

Fig.3



OPTIONAL SWIVEL BELT CLIP 12

■ MB-93 contents

- | | Qty. |
|-------------------|------|
| ① Belt clip | 1 |
| ② Base clip | 1 |

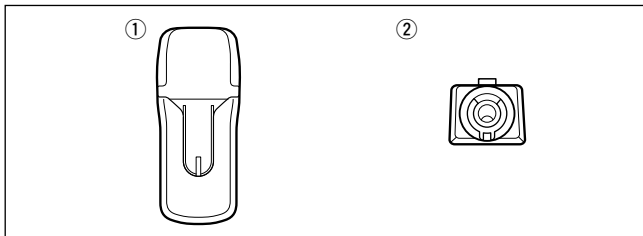

■ Attaching

- ① Release the battery pack if it is attached. (p. 2)
- ② Slide the base clip in the direction of the arrow until the base clip is locked and makes a 'click' sound.

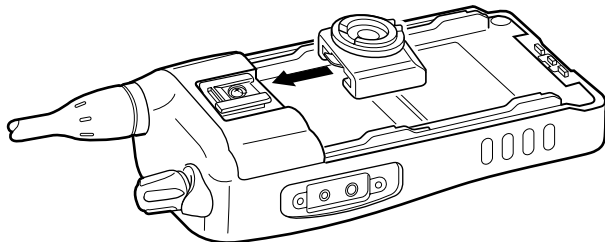

- ③ Clip the belt clip to a part of your belt. And insert the transceiver into the belt clip until the base clip inserted fully into the groove.

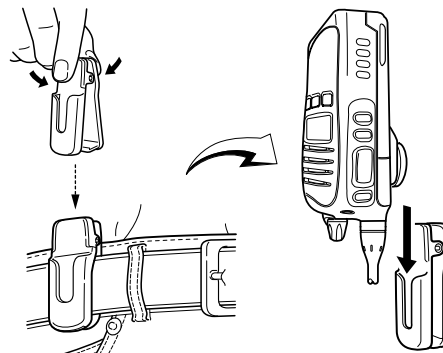

- ④ Once the transceiver is locked in place, it swivels as illustrated below.

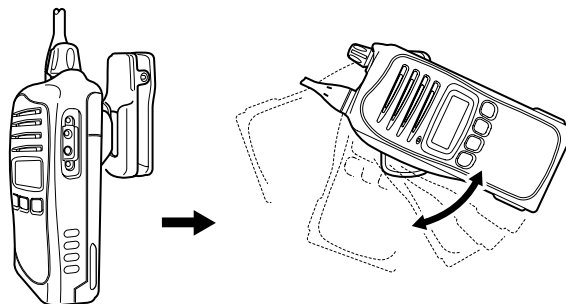

Once the transceiver is locked in place, it will swivel 360 degrees.

12 OPTIONAL SWIVEL BELT CLIP

■ Detaching

- ① Turn the transceiver upside down in the direction of the arrow and pull out from the belt clip.

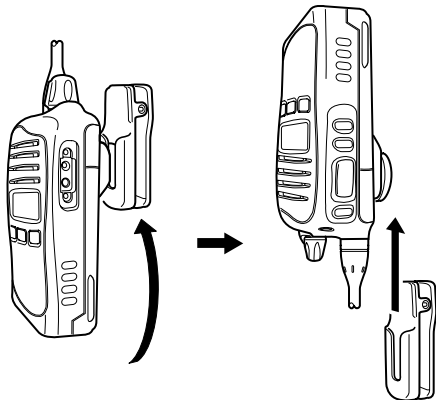

- ② Release the battery pack if it is attached. (p. 2)
- ③ Pinch the clip (①), and slide the base clip in the direction of the arrow (②).

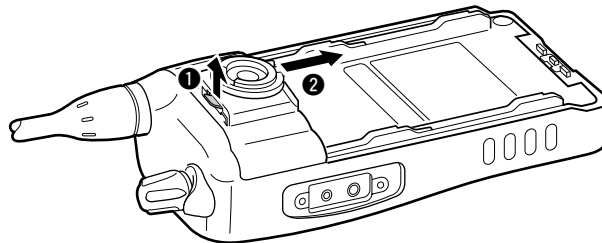

CAUTION!

HOLD THE TRANSCEIVER TIGHTLY, WHEN HANGING OR DETACHING THE TRANSCEIVER FROM THE BELT CLIP.

Otherwise the transceiver may not be attached to the holder or swivel properly if the transceiver is accidentally dropped and the base clip is scratched or damaged.

◇ BATTERY PACK

Battery pack	Voltage	Capacity	Battery life* ¹
BP-232N	7.4 V	2000 mAh	13.5 hrs.
BP-240	Battery case for AAA (LR03) × 6 alkaline		—* ²

*¹ When the power save function is turned ON, and the operating periods are calculated under the following conditions;

TX : RX : standby = 5 : 5 : 90

*² Operating period depends on the alkaline cells used.

◇ CHARGERS

- **BC-119N** DESKTOP CHARGER + **AD-106** CHARGER ADAPTER
+ **BC-145V** AC ADAPTER

For rapid charging of battery packs. An AC adapter is supplied with the charger.

Charging time: approx. 3 hours when BP-232N is attached.

- **BC-121N** MULTI-CHARGER + **AD-106** CHARGER ADAPTER (6 pcs.)
+ **BC-157** AC ADAPTER

For rapid charging of up to 6 battery packs (six AD-106's are required) simultaneously. An AC adapter should be purchased separately.

Charging time: approx. 3 hours when BP-232N is attached.

- **BC-160** DESKTOP CHARGER + **BC-145V** AC ADAPTER

For rapid charging of battery packs. An AC adapter is supplied with the charger.

Charging time: approx. 3 hours when BP-232N is attached.

◇ BELT CLIPS

- **MB-93** SWIVEL BELT CLIP
- **MB-94** BELT CLIP

Exclusive alligator-type belt clip. The same as supplied with the transceiver.

- **MB-96N/96F** LEATHER BELT HANGER

◇ DC CABLES

- **CP-17L** CIGARETTE LIGHTER CABLE

Allows charging of the battery pack through a 12 V cigarette lighter socket. (For BC-119N/BC-160)

- **OPC-515L/OPC-656** DC POWER CABLES

Allows charging of the battery pack using a 13.8 V power source instead of the AC adapter.

OPC-515L: For BC-119N

OPC-656 : For BC-121N

13 OPTIONS

◇ OTHER OPTIONS

- **SP-13** EARPHONE
Provides clear receive audio in noisy environment.
- **HM-153L** EARPHONE-MICROPHONE
- **HM-158L/159L** SPEAKER-MICROPHONE
Combination speaker-microphone that provides convenient operation while hanging the transceiver from your belt.
- **HS-94/HS-95/HS-97** HEADSET + **VS-1L** VOX/PTT CASE
HS-94: Ear-hook type
HS-95: Neck-arm type
HS-97: Throat microphone
VS-1L: VOX/PTT switch box for hands-free operation, etc.
- **FA-SC72U** ANTENNA
470–520 MHz
- **FA-SC73US** STUBBY ANTENNA
450–490 MHz
- **AD-98FSC** ANTENNA CONNECTOR ADAPTER
- **CS-41S** CLONING SOFTWARE

Some options may not be available in some countries. Ask your dealer for details.

◆ General

- Frequency coverage
 - TX : 450–480 MHz
(includes all 40 CB channels)
 - RX : 450–520 MHz
- Mode : 16K0F3E (FM)
- Channel spacing
 - CB channel : 25 kHz
 - Private channel : 12.5/25 kHz
- Current drain (at 7.2 V) : TX (at 5 W) 1.9 A
Max. audio 300 mA max.
- Power supply requirement : 7.2 V DC nominal*
(negative ground)
*Specified Icom's battery pack only
- Frequency stability : ±2.5 ppm
(–30°C to + 60°C)
- Antenna impedance : 50 Ω nominal
- Dimensions : 53.0(W) × 120.0(H) × 32.5(D) mm
(Projections not included)
- Weight : Approx. 320 g (including BP-232N)

◆ Transmitter

- Output power : 5 W
- Modulation system : Variable reactance frequency modulation
- Max. frequency deviation : ±5.0 kHz
- Spurious emissions : 70 dB min
- Adjacent channel power : 75 dB (typical)
- External mic. connector : 3-conductor 2.5 (d) mm/2.2 kΩ

◆ Receiver

- Receive system : Double conversion
superheterodyne
- Sensitivity (12 dB SINAD) : –12 dBμ (typical)
- Squelch sensitivity : –12 dBμ (typical; Threshold)
- Intermodulation rejection ratio : 74 dB (typical)
- Spurious response rejection ratio : 70 dB min
- Adjacent channel selectivity : 75 dB (typical)
- Audio output power : 0.5 W (typical) at 5% distortion
with an 8 Ω load
- External speaker connector : 2-conductor 3.5 (d) mm/8 Ω

All stated specifications are subject to change without notice or obligation.

15 WARRANTY

Icom Limited Warranty

Icom Incorporated is proud of the technology within, and the quality of workmanship of its products.

Icom (Australia) Pty. Ltd., the authorised Icom Distributor, warrants this Icom product to be free from defects in material or workmanship for the applicable period indicated below:

Radios: Two (2) years from the date of purchase, (excluding accessories), from an Australian authorised Icom Dealers.

Accessories (i.e. battery, antenna, battery chargers, etc.):

Six (6) months from the date of purchase, from an Australian authorised Icom Dealer.

Icom (Australia) Pty. Ltd. will, at its discretion, and subject to the terms and conditions stated below, repair or replace any goods or component part thereof which its examination shall disclose to be defective. Unless otherwise expressly provided, any fault arising from defective workmanship or material shall be rectified by Icom where the equipment is returned freight prepaid to Icom at Unit 1/103 Garden Road, Clayton, Victoria, 3168.

This warranty shall not apply:

- (a) To an Icom Product which has failed due to improper installation, misuse, accident, alteration or unauthorised repair or modification.
- (b) If any serial number or identification plate attached to the goods has been altered, rendered illegible, or removed.
- (c) If the goods have been damaged by corrosion, deterioration or the like contributed to abnormal temperatures; the influence of foreign matter or energy or physical or chemical properties of water, steam or chemical compounds.

The benefits conferred by this warranty are in addition to all implied warranties, other rights and remedies in respect of the product which the consumer has under the Trade Practices Act and similar State and Territory Laws.

WARRANTY SERVICE INSTRUCTIONS

1. If you have difficulty, send your equipment to Icom (Australia) Pty. Ltd., preferably in the original carton, without accessories, prepaid, with a brief explanation of the difficulty you have experienced.
2. Include accessories only if your specific situation indicates an accessory related difficulty exists, otherwise Icom (Australia) Pty. Ltd. shall assume no liability for the loss or safe return of an accessory item. Itemise these accessories on the note of explanation.
3. If the requested repairs or services are within the terms of the warranty, your equipment will be returned after repair, prepaid, to any designated point within Australia.
4. If the requested repairs or services are not within the terms of the warranty if you fail to provide acceptable evidence of the date of purchase, return freight will be charged.

Model : **IC-41S**

Date of purchase :

Serial Number :

Dealer Name :

Authorized Icom Distributor

Icom (Australia) Pty. Ltd.
Unit 1/103 Garden Road,
Clayton, 3168, VIC.

Count on us!

A-6547H-1AU
Printed in Japan
© 2006 Icom Inc.

Icom Inc.
1-1-32 Kamiminami, Hirano-ku, Osaka 547-0003, Japan