

# IC-48A/E

UHF FM TRANSCEIVER

## INSTRUCTION MANUAL



## FOREWORD

Congratulations for choosing this technically-advanced ICOM product.

The IC-48A/E UHF FM transceiver is the latest addition to the ICOM system of Amateur radio equipment. Included in the IC-48A/E design is provision for use of the newly developed Digital Code Squelch System. Digital Code Squelch uses the latest digital techniques to create a communications system capable of dramatically reducing the inconvenience of heavily populated Amateur bands.

Use the IC-48A/E with the knowledge that this transceiver, and every ICOM product, is supported by a world-wide network of authorized service centers and dealers ready to provide assistance efficiently.

## UNPACKING

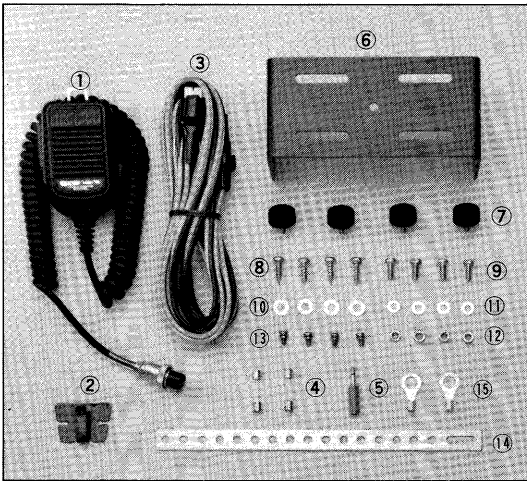

IC-48A/E ACCESSORIES SUPPLIED	QTY.
1. *Microphone . . . . .	1
2. Microphone hanger . . . . .	1
3. Power cable . . . . .	1
4. Fuses (15A) . . . . .	1
5. External speaker plug. . . . .	1
6. Mounting bracket . . . . .	1
7. Mounting bracket knobs . . . . .	4
8. Mounting screws (self-tapping) . . . . .	4
9. Mounting screws . . . . .	4
10. Flat washers (large) . . . . .	4
11. Flat washers (small) . . . . .	4
12. Nuts . . . . .	4
13. Screws/spring washers . . . . .	4
14. Support bracket. . . . .	1
15. Cable lugs . . . . .	2
* U.S.A. and Australia versions : HM-12	
Europe version : HM-15	

## TABLE OF CONTENTS

<b>SECTION</b>	<b>1 SPECIFICATIONS</b> .....	<b>1</b>
	1-1 GENERAL.....	1
	1-2 TRANSMITTER.....	1
	1-3 RECEIVER.....	1
<b>SECTION</b>	<b>2 FEATURES</b> .....	<b>2</b>
<b>SECTION</b>	<b>3 CONTROL FUNCTIONS</b> .....	<b>3</b>
	3-1 FRONT PANEL.....	3
	3-2 LCD READOUT .....	6
	3-3 REAR PANEL.....	8
<b>SECTION</b>	<b>4 INSTALLATION</b> .....	<b>9</b>
	4-1 MOBILE INSTALLATION.....	9
	4-2 FIXED INSTALLATION.....	11
<b>SECTION</b>	<b>5 OPERATION</b> .....	<b>13</b>
	5-1 BASIC OPERATION.....	13
	5-2 MEMORY MODE.....	15
	5-3 SCAN FUNCTIONS.....	17
	5-4 DUPLEX MODE .....	19
	5-5 CALL CHANNEL FUNCTION.....	23
	5-6 MICROPHONE.....	23
	5-7 BACKUP BATTERY.....	24
	5-8 RESETTING INTERNAL MICROCOMPUTER (CPU).....	24
	5-9 OPTIONAL UNITS.....	25
<b>SECTION</b>	<b>6 INSIDE VIEWS</b> .....	<b>28</b>
	6-1 TOP VIEW (MAIN UNIT) .....	28
	6-2 BOTTOM VIEW (RX UNIT).....	28
<b>SECTION</b>	<b>7 MAINTENANCE</b> .....	<b>29</b>
<b>SECTION</b>	<b>8 BLOCK DIAGRAM</b> .....	<b>31</b>
<b>SECTION</b>	<b>9 OPTIONS</b> .....	<b>32</b>
<b>SECTION</b>	<b>10 SCHEMATIC DIAGRAM</b> .....	<b>SEPARATE</b>

## SECTION 1 SPECIFICATIONS

### 1 - 1 GENERAL

Frequency coverage	:	IC-48A U.S.A. version	440 ~ 450MHz
		IC-48A Australia version	430 ~ 440MHz
		IC-48E Europe version	430 ~ 440MHz
Frequency resolution	:	IC-48A	5, 10, 15, 20 or 25kHz (programmable)
		IC-48E	12.5 or 25kHz (programmable)
Frequency control	:	CPU based 5kHz (or 6.25kHz) step digital PLL synthesizer Simplex and semi-duplex capability (programmable offset)	
Memory channels	:	21 channels	
Usable temperature range	:	-10°C ~ +60°C (+14°F ~ +140°F)	
Power supply requirement	:	13.8V DC ±15% (negative ground) AC power supply is available for AC operation.	
Current drain (at 13.8V DC)	:	Transmit	
		HIGH (25W)	Maximum 7.5A
		LOW (5W)	Approx. 3.5A
		Receive	
		Max. audio output	Approx. 800mA
		Squelched	Approx. 450mA
Antenna impedance	:	50 ohms unbalanced	
Dimensions	:	140(140)mm(W) x 50(50)mm(H) x 155(171)mm(D) Bracketed values include projections.	
Weight	:	1.2kg	

### 1 - 2 TRANSMITTER

Output power	:	HIGH 25W	LOW 5W
Emission mode	:	16K0F3E (16K0F2D: When operating with an optional UT-28)	
Modulation system	:	Variable reactance frequency modulation	
Max. frequency deviation	:	±5.0kHz	
Spurious emission	:	More than 60dB below carrier	
Microphone	:	600 ohm electret condenser with push-to-talk and scanning switches (IC-48E: 1750Hz tone burst switch)	

### 1 - 3 RECEIVER

Receive system	:	Double-conversion superheterodyne	
Modulation acceptance	:	16K0F3E	
Intermediate frequencies	:	1st 23.15MHz	2nd 455kHz
Selectivity	:	More than 12.5kHz at -6dB Less than 25.0kHz at -60dB	
Sensitivity	:	Less than 0.18μV for 12dB SINAD	
Audio output	:	More than 2.4 watts at 10% distortion with 8 ohm load	
Audio output impedance	:	4 ~ 8 ohms	

\*All stated specifications are approximate and subject to change without notice or obligation.

## SECTION 2 FEATURES

- **COMPACT AND HIGH OUTPUT POWER**

Smaller than many conventional automobile broadcast band transceivers, the sophisticated IC-48A/E transceiver provides 25W of powerful output on any frequency in the 70cm band and contains an internal speaker as well.
- **SIMPLE PANEL DESIGN**

Front panel layout is extremely simple in spite of the great number of functions available. The total number of controls on the front panel is significantly fewer than other models currently available while, at the same time, new features have been added resulting in a mobile unit that is safe and easy to use while driving without sacrificing performance.
- **HIGHLY VISIBLE LCD READOUT**

The LCD front panel readout features a particularly wide viewing angle designed to enable the driver to easily see the display, even in bright daylight, without changing position.
- **AUTOMATIC DIMMER CIRCUIT**

Variations in ambient light conditions pose no problems when using the IC-48A/E since the built-in light sensor automatically adjusts a dimmer circuit to control the backlighting of the display to suit the time of day or night that you are operating. This feature is particularly convenient for night operation to reduce eye fatigue caused by overly bright displays.
- **21 MEMORY CHANNELS**

The IC-48A/E introduces a large capacity memory with 21 fully programmable memory channels. These memory channels place a variety of communications functions at the fingertips of the driver.
- **DUAL SCANNING FUNCTIONS**
  - **FREQUENCY SCAN:**

The entire band is searched continuously with frequency increments specified by the operator.
  - **MEMORY SCAN:**

All memory channels are continuously checked.
- **SUBAUDIBLE TONE ENCODER STANDARD**

With 38 different subaudible tones standard on the IC-48A (U.S.A. version), maximum communications coverage is assured by allowing full access to all your local repeaters.
- **SQUELCH OPTIONS**

Two new optional units specially designed for the IC-48A/E are ideal for handling the crowded band conditions found in many locations. Either the UT-28 or the UT-29 may be installed.

  - **UT-28 DIGITAL CODE SQUELCH UNIT:**

Incorporating a system of digital coding and decoding, the UT-28 option allows a "personalized" squelch to be programmed using 1 of 100,000 different code numbers.
  - **UT-29 TONE SQUELCH UNIT:**

The UT-29 is a subaudible tone encoder/decoder which may be installed as an alternative to the UT-28 Digital Code Squelch Unit.

# SECTION 3 CONTROL FUNCTIONS

## 3 - 1 FRONT PANEL

The diagram shows the IC-48A U.S.A. version.

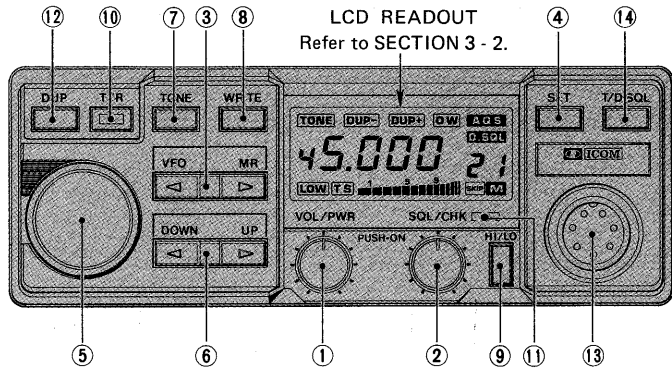

### ① VOLUME CONTROL/POWER SWITCH [VOL/PWR]

Push this control to turn the power ON and OFF. Turn the control clockwise to increase the audio level. Refer to SECTION 5 - 1 (1) RECEIVING.

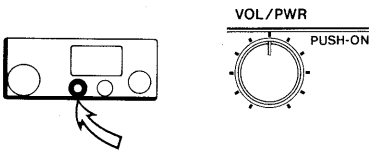

### ② SQUELCH CONTROL/CHECK SWITCH [SQL/CHK]

The squelch circuit quiets the noise from the transceiver while no signals are being received. While monitoring a vacant channel, turn the control clockwise until the green [T/R] LED goes out. Refer to SECTION 5 - 1 (1) RECEIVING.

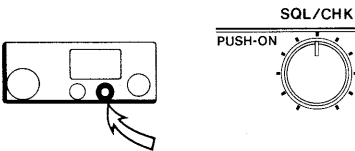

### ③ VFO/MEMORY READ SWITCH [VFO/MR]

Push to select either the VFO mode or the MEMORY mode of operation. When the MEMORY mode is selected, the letter "M" appears under the memory channel number on the LCD readout. Refer to SECTIONS 5 - 1 (1) RECEIVING and 5 - 2 (1) MEMORY READING.

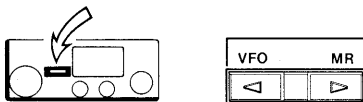

### ④ SET SWITCH [SET]

This is a multi-function switch which operates in different ways depending on which mode is currently selected with the IC-48A/E.

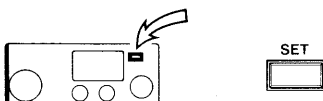

In the VFO mode, the [SET] SWITCH permits programming of the subaudible tone encoder on the IC-48A U.S.A. version, the transmit offset frequency and the tuning step size of the TUNING CONTROL. Refer to SECTIONS 5 - 1 (1) RECEIVING, and 5 - 4 (1) DUPLEX PROGRAMMING and (2) SUBAUDIBLE TONE ENCODER.

In the MEMORY mode, the [SET] SWITCH controls the skip function. The skip function allows memory channels to be deleted from the normal scanning sequence when memories are being scanned. Refer to SECTION 5 - 3 (2) MEMORY CHANNEL SCANNING.

**⑤ TUNING CONTROL**

The function of this control is affected by the mode of operation being used.

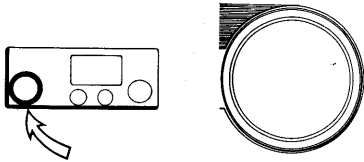

- In the VFO mode, turn clockwise to increase the operating frequency and counterclockwise to decrease it. After pushing the [SET] SWITCH, the TUNING CONTROL is used to select the subaudible tone number on the IC-48A (U.S.A. version), to set the amount of transmit offset when using the duplex mode and to select the tuning step size for frequency changes with the TUNING CONTROL. Refer to SECTIONS 5 - 1 (1) RECEIVING, and 5 - 4 (1) DUPLEX PROGRAMMING and (2) SUBAUDIBLE TONE ENCODER.

- In the MEMORY mode, turn clockwise to increase the selected memory channel and counterclockwise to decrease it. Refer to SECTION 5 - 2 (1) MEMORY READING.

**⑥ DOWN/UP SWITCH [DOWN/UP]** This switch operates differently depending on the setting of the [VFO/MR] SWITCH.

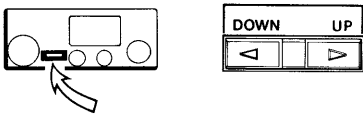

In the VFO mode, push to change the selected operating frequency in 1MHz increments. In the MEMORY mode, push to change the selected memory channel in one channel increments. Refer to SECTIONS 5 - 1 (1) RECEIVING and 5 - 2 (1) MEMORY READING.

**⑦ TONE SWITCH [TONE] (IC-48A U.S.A. version)**

The name and function of this switch varies depending on the version of transceiver.

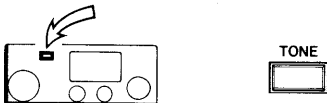

- [TONE] SWITCH:  
Push to turn ON and OFF the subaudible tone encoder when using the duplex mode. The word "TONE" appears when the tone encoder is turned ON. Refer to SECTION 5 - 4 (2) SUBAUDIBLE TONE ENCODER.

**CALL SWITCH [CALL] (except U.S.A. version)**

- [CALL] SWITCH:  
Push to select the call channel which has been programmed in memory channel 21. The letter "C" appears in place of the memory channel number when the call function is activated. Refer to SECTION 5 - 5 CALL CHANNEL FUNCTION.

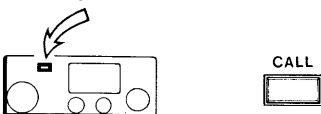

### ⑧ WRITE SWITCH [WRITE]

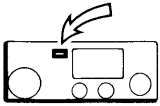

This switch works differently depending on the setting of the [VFO/MR] SWITCH.

- In the VFO mode, push to store the displayed frequency on the LCD readout in the memory channel represented by the memory channel number also displayed. Refer to SECTION 5 - 2 (2) MEMORY PROGRAMMING.
- In the MEMORY mode, push to transfer the displayed frequency, which is the contents of the selected memory channel to the VFO. After the transfer, the IC-48A/E changes to the VFO mode. Refer to SECTION 5 - 2 (3) MEMORY CHANNEL TO VFO TRANSFERS.

### ⑨ HIGH/LOW SWITCH [HI/LO]

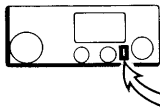

Push to change between the HIGH (25W) and LOW (5W) transmit output power. The word "LOW" appears when LOW power is selected.

### ⑩ TRANSMIT/RECEIVE INDICATOR [T/R]

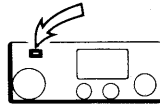

This two-color LED indicates whether the IC-48A/E is in the transmit or receive mode. The LED is red while transmitting and green while receiving with the squelch circuit open. The indicator is OFF when the squelch circuit is closed and the receiver is muted.

### ⑪ DISPLAY DIMMER SENSOR

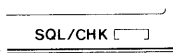
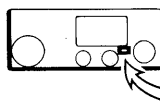

This sensor measures ambient light and controls the dimmer circuit which varies the intensity of the LCD backlighting.

### ⑫ DUPLEX SWITCH [DUP]

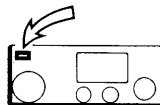

Push to select simplex or duplex operation:

- The transmit frequency is LOWER than the receive frequency by 5MHz (7.6MHz) or by the programmed offset amount when "DUP-" appears on the display.
- The transmit frequency is HIGHER than the receive frequency by 5MHz (7.6MHz) or by the programmed offset amount when "DUP+" appears on the display.
- When neither "DUP-" nor "DUP+" appear on the display, the IC-48A/E is in the simplex mode. The transmit and receive frequencies are equal at this time. Refer to SECTION 5 - 4 DUPLEX MODE.

**NOTE:** Bracketed values show offset frequencies for IC-48E Europe version.



**13 MIC CONNECTOR**

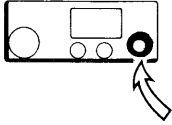

Connect the supplied microphone to this connector. Refer to SECTIONS 4 - 1 FOR MOBILE USE, 4 - 2 FOR FIXED USE and 5 - 6 MICROPHONE.

**FRONT VIEW**

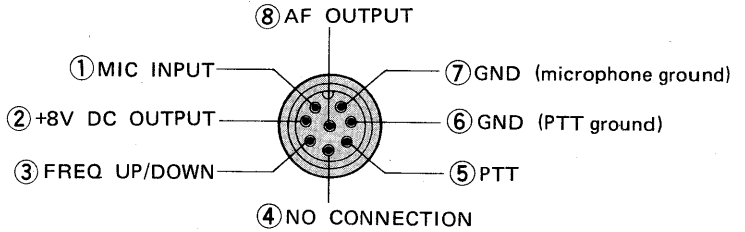

**14 TONE SQUELCH SWITCH  
DIGITAL SQUELCH SWITCH  
[T/D.SQL]**

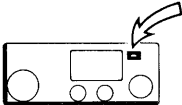
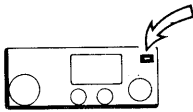

This switch turns ON and OFF the optional squelch systems:

**• TONE SQUELCH SYSTEM**

When activated, "TONE" and "D.SQL" appear on the display. Push the [SET] SWITCH in order to program the desired subaudible tone numbers. Refer to SECTION 5 - 9 OPTIONAL UNITS.

**• DIGITAL CODE SQUELCH SYSTEM**

When activated, "D.SQL" appears on the display. Push the [SET] SWITCH in order to program the desired group code. Refer to SECTION 5 - 9 OPTIONAL UNITS.

**NOTE:** This switch has no function when neither option is installed.

**3 - 2 LCD READOUT**

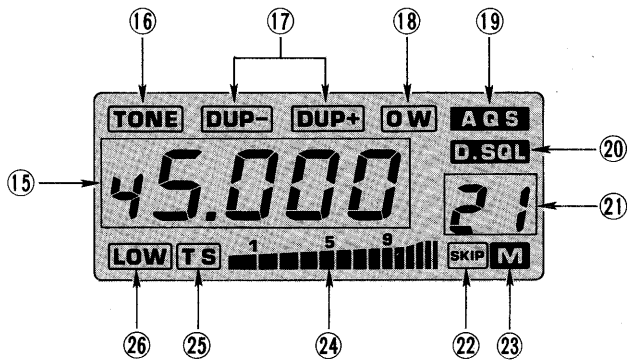

**15 FREQUENCY**



The operating frequency is displayed with digits representing the 10MHz, 1MHz, 100kHz, 10kHz and 1kHz positions. Additionally, the IC-48E displays the 100Hz digit.

The decimal point on the display flashes during scanning operations. Also, the subaudible tone number, the transmit offset, the tuning step size, and the group code for the optional digital code squelch are displayed on the LCD readout.

⑩ SUBAUDIBLE TONE INDICATOR "TONE"



Appears when the subaudible tone encoder is activated. Also, appears when the optional UT-29 Tone Squelch unit is activated. Refer to SECTIONS 5 - 4 (2) SUBAUDIBLE TONE ENCODER and 5 - 9 OPTIONAL UNITS.

⑪ DUPLEX MODE INDICATORS "DUP-", "DUP+"



Appear while the IC-48A/E is being operated in the duplex mode (the transmit frequency is different from the receive frequency). Both indicators disappear while operating in the simplex mode. Refer to SECTION 5 - 4 (1) DUPLEX PROGRAMMING.

⑫ OFFSET WRITE INDICATOR "OW"

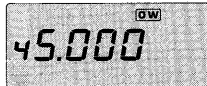

Flashes when the IC-48A/E is ready to have the transmit offset programmed for duplex operation. Refer to SECTION 5 - 4 (1) DUPLEX PROGRAMMING.

⑬ GROUP CODE INDICATOR "AQS"

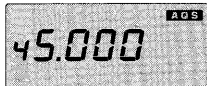

Flashes when the IC-48A/E is ready to have the group code programmed when using the optional UT-28 Digital Code Squelch unit. Refer to SECTION 5 - 9 OPTIONAL UNITS.

⑭ SQUELCH SYSTEM INDICATOR "D.SQL"



Appears when either the optional tone squelch or optional digital code squelch system is activated. Flashes with the "TONE" INDICATOR when the IC-48A/E is ready to have the subaudible tone number for the tone squelch programmed. Refer to SECTION 5 - 9 OPTIONAL UNITS.

⑮ MEMORY CHANNEL NUMBER

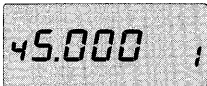

This area displays various symbols:

- Selected memory channels "1" to "21".
- Offset programming symbol "F" or "P".
- Call channel function "C".  
IC-48A/E except U.S.A. version.
- Subaudible tone encoder memory number "1", "2" or "3".  
IC-48A U.S.A. version only.

⑯ MEMORY MODE INDICATOR "M"



Appears when the MEMORY mode is selected with the [VFO/MR] SWITCH. Refer to SECTION 5 - 2 (1) MEMORY READING.

⑰ MEMORY CHANNEL SKIP INDICATOR "SKIP"



Appears when a particular memory channel has been programmed with the [SET] SWITCH to be excluded from the memory scan operation. Refer to SECTION 5 - 3 (3) MEMORY SKIP FUNCTION.

②④ "S/RF" INDICATOR



In the receive mode, this indicator operates as an S-meter showing the receive signal level. In the transmit mode, the relative output power of the transmitter is indicated as follows:

- LOW power : 5 segments appear.
- HIGH power : All segments appear.

②⑤ TUNING STEP INDICATOR "TS"

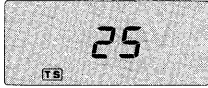

Flashes when the IC-48A/E is ready for programming of the VFO step size. Use the TUNING CONTROL to select a desired step size. Refer to SECTION 5 - 1 (2) SELECTING A FREQUENCY.

②⑥ OUTPUT POWER INDICATOR "LOW"



Appears when LOW power is selected with the [HI/LO] SWITCH. The indicator does not appear when HIGH power is used. Refer to SECTION 5 - 1 (4) SELECTING OUTPUT POWER.

3-3 REAR PANEL

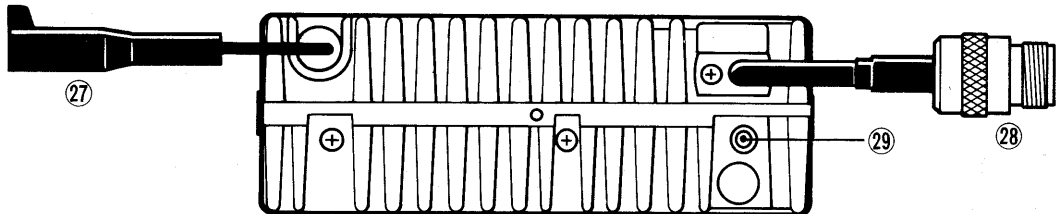

②⑦ POWER CONNECTOR

Connect 13.8V DC  $\pm 15\%$  from a stable power source to this connector. Refer to SECTION 4 INSTALLATION.

②⑧ ANTENNA CONNECTOR

Connect a 50 ohm antenna with a Type-N connector on the feedline to this connector. Refer to SECTION 4 INSTALLATION.

②⑨ EXTERNAL SPEAKER JACK

Connect a 4 ~ 8 ohm speaker to this jack, if required. Connecting the external speaker automatically disconnects the internal speaker. Refer to SECTION 4 INSTALLATION.

## 4 - 1 MOBILE INSTALLATION

### (1) INSTALLATION

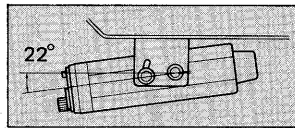
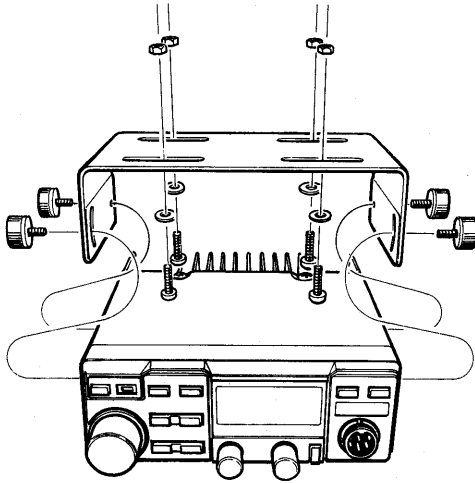

- Avoid locations where hot or cold air can blow directly on the unit or where there are large temperature variations.
- Avoid mounting the transceiver where it will hinder the normal operation of the vehicle.
- Securely mount the transceiver with the supplied bracket to minimize vibration.

### (2) CONNECTIONS

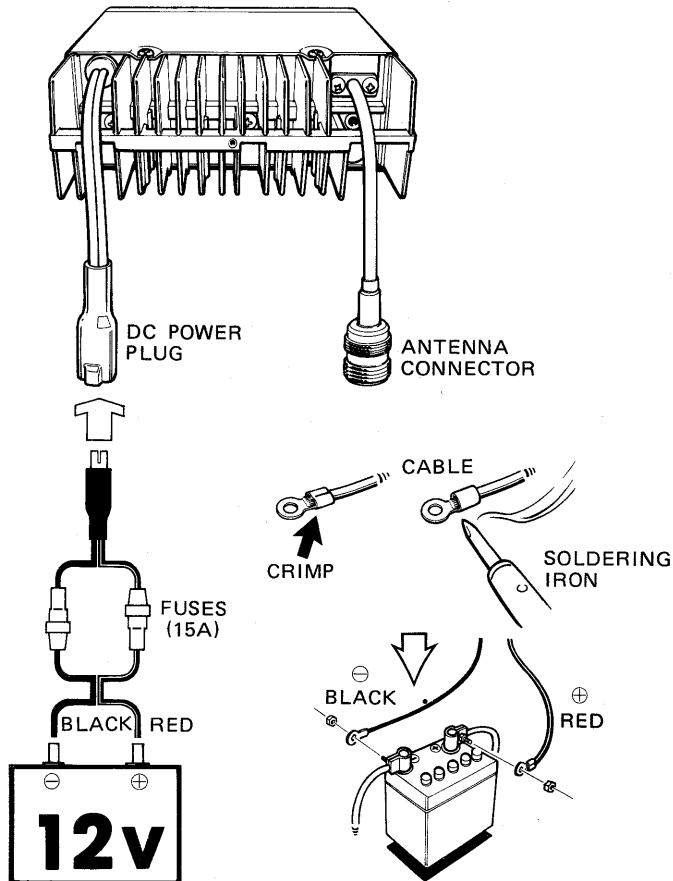

**NOTE:**  
 Insulate the power cable using rubber or electrician's tape where it passes through holes in the vehicle body.

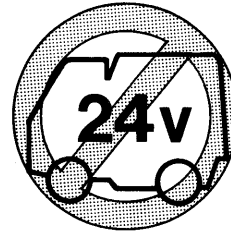

- Do not connect directly to a 24V battery.

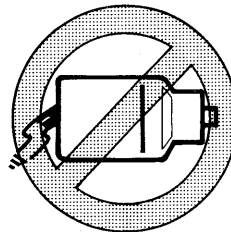

- Do not use the cigarette lighter socket for power connections.

(3) ANTENNA

Transceiver performance largely depends on the quality of the antenna used. Select a high-quality antenna and use it as recommended by the manufacturer.

(4) COAXIAL CABLE

Use a large diameter 50 ohm coaxial cable. The added efficiency of the large cable is important in the UHF spectrum to reduce cable loss.

(5) ANTENNA LOCATION

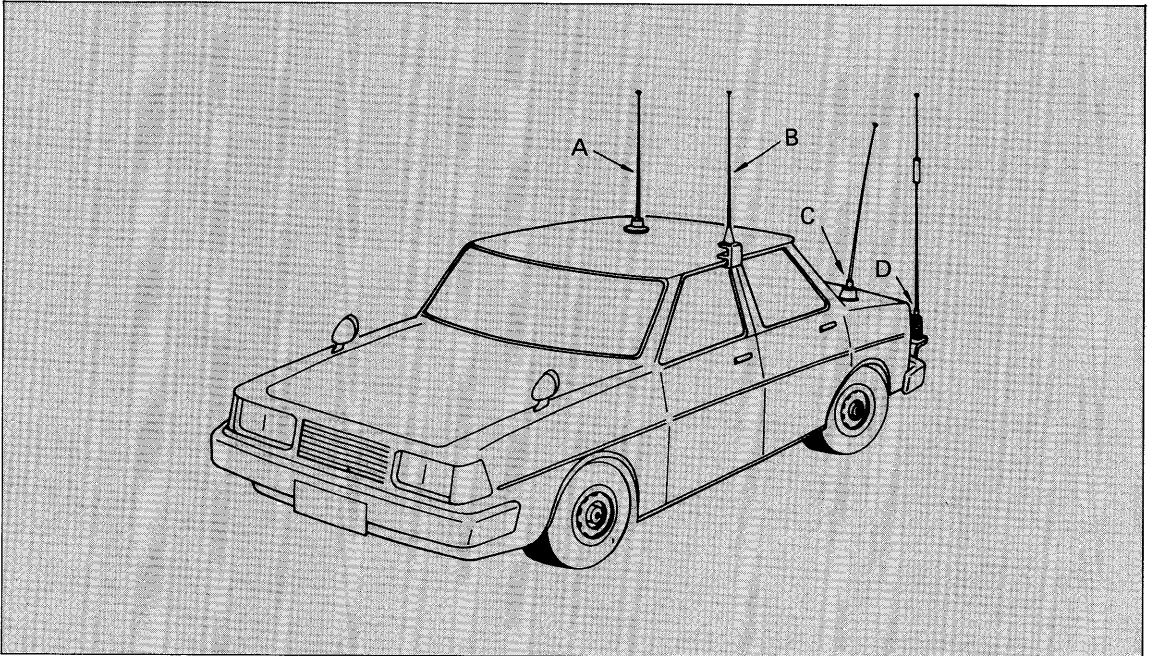

- A: Roof-mount antenna
  - Best location for a good radiation pattern.
  - Drill a hole in the roof, or use a magnetic antenna base.
- B: Gutter-mount antenna
- C: Trunk-mount antenna
- D: Bumper-mount antenna
  - Best location for longer antennas.

(6) MICROPHONE

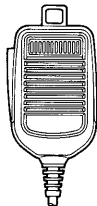

A high-quality electret condenser microphone is supplied with the IC-48A/E. Plug it directly into the jack on the front panel of the transceiver.

Optional microphones are available for mobile use with the IC-48A/E.

- IC-HM14: DTMF Microphone
- IC-HM16: Speaker-microphone (IC-48A)
- IC-HM17: Speaker-microphone (IC-48E)
- HS-15 : Flexible Mobile Microphone
- HS-15SB: Switch Box for HS-15

## (7) EXTERNAL SPEAKER

An external speaker plug is supplied with the IC-48A/E for use with an optional external speaker if you feel you require one. The external speaker impedance should be 4 ~ 8 ohms. The internal speaker is disconnected when the external speaker is connected.

The SP-10 Mobile Speaker is recommended for mobile use with the IC-48A/E.

## 4-2 FIXED INSTALLATION

### (1) CONNECTIONS

A stable AC power supply with a protective circuit is required for fixed station use.

The PS-45 AC Power Supply is available for operating the IC-48A/E.

**CAUTION:** Voltages greater than 16 volts DC will damage your transceiver. Check the source voltage before connecting the power cord.

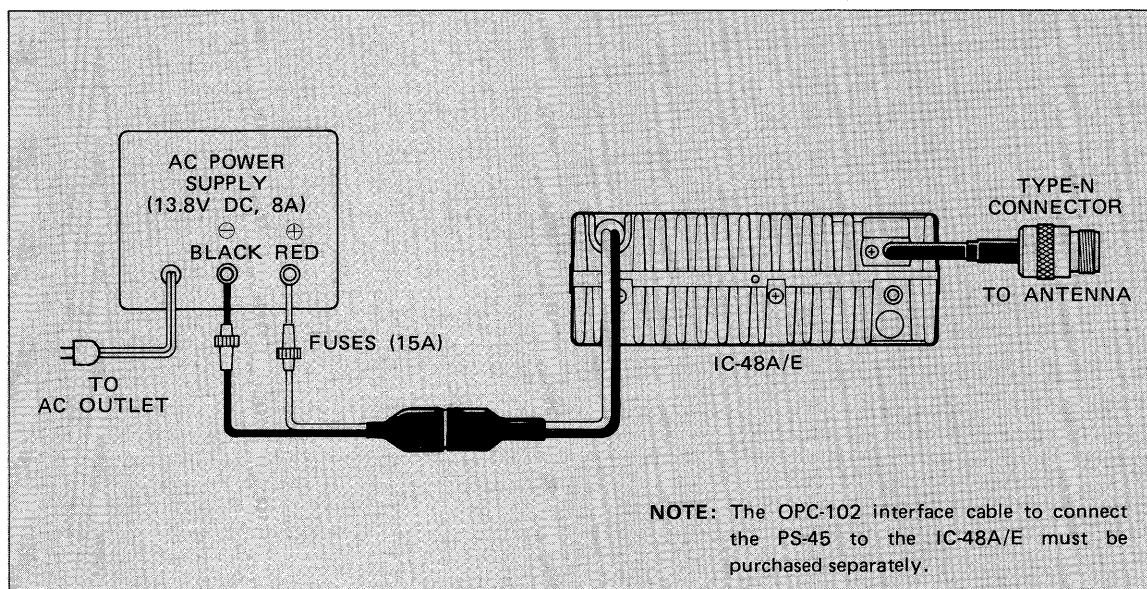

### (2) ANTENNA

Antenna performance is crucial for reliable radio communications. For this reason, a 50 ohm directional antenna is well worth the extra investment. A tremendous variety of fixed location antennas is available from various manufacturers. Choose an antenna most suited to your needs.

### (3) COAXIAL CABLE

Particularly in a location where feedline lengths are much longer than in a mobile installation, it is best to use a coaxial cable with the lowest loss available.

At 430MHz or 440MHz, a 50-foot-length of military grade RG-58A causes a loss of approximately 19 watts due to cable loss when using the IC-48A/E. An equal length of military grade RG-8A causes only approximately 10 watts loss due to cable loss. Therefore, simply by using a better quality cable, the power reaching the antenna will be about 15 watts instead of 6 watts.

#### (4) TYPE-N CONNECTOR INSTALLATION

A TYPE-N connector should be used on the feedline to minimize power loss at UHF frequencies. Follow the instructions below for best results when installing the connector.

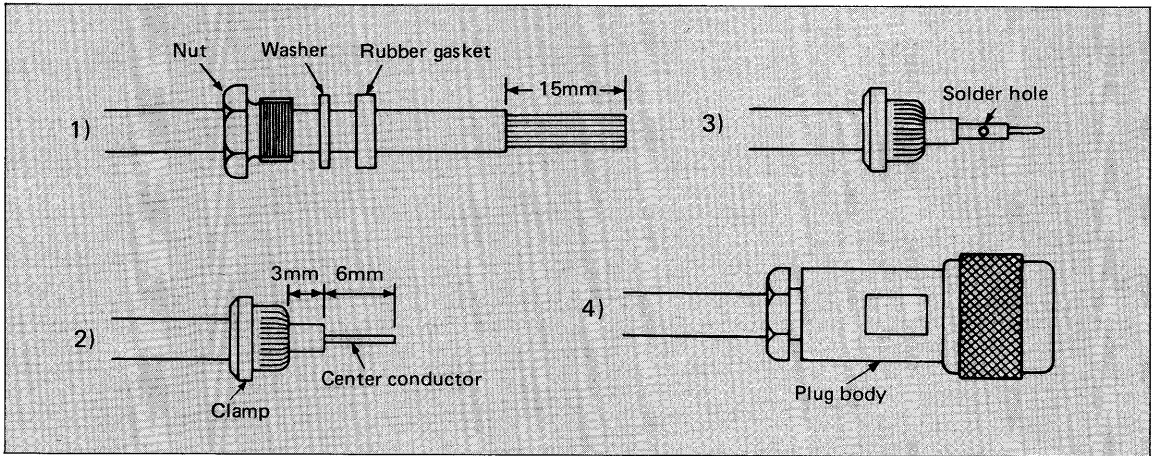

1) Slide the nut, washer, and rubber gasket over the coaxial cable and cut the end of the cable evenly.

2) Cut and remove 15mm of the outer vinyl jacket, and fold the braid back over the clamp. The clamp end should be flush with the end of the vinyl jacket. Evenly trim the braid ends.

Cut and remove 6mm of the dielectric (the center conductor insulation).

3) Soft-solder the center conductor. Install a center conductor pin and solder it.

4) Carefully slide the plug body into place aligning the center conductor pin on the cable with the hole in the insulator inside the plug body.

Complete the assembly by screwing the nut into the plug body.

#### (5) MICROPHONE

In addition to the microphones suggested in SECTION 4 - 1 (7) MICROPHONE, also useful for fixed operation are the following:

- SM-8 : Desk Microphone
- SM-10: Compressor/Graphic Equalizer Microphone

#### (6) EXTERNAL SPEAKER

In addition to the SP-10 mentioned in SECTION 4 - 1 (8) EXTERNAL SPEAKER, the SP-7 Base Speaker is another optional speaker which is best for operation from a fixed location.

- Optional speakers



SP-10

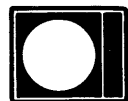

SP-7

## SECTION 5 OPERATION

### 5-1 BASIC OPERATION

#### (1) RECEIVING

1) Push [VOL/PWR] CONTROL.

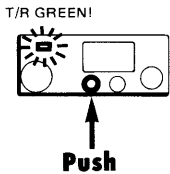

2) Adjust volume level.

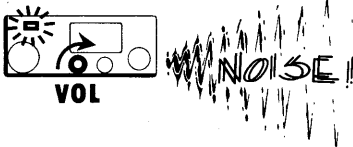

3) Adjust squelch level.

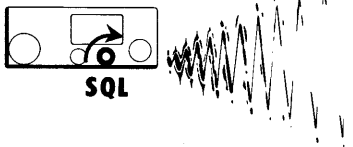

4) Select operating frequency.

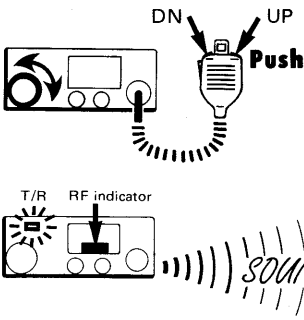

CONTROL	INITIAL SETTINGS
VOL/PWR	COUNTERCLOCKWISE
SQL/CHK	COUNTERCLOCKWISE

1) Push the VOL/PWR CONTROL to turn ON the power.

- The green [T/R] INDICATOR lights and the LCD READOUT displays the frequency and memory channel number last used.
- If the MEMORY mode was being used immediately prior to turning off the power to the IC-48A/E, the MEMORY mode is retained and the last used memory channel number and contents of that memory appear.

2) Turn the [VOL/PWR] CONTROL clockwise until an adequate sound level is obtained.

3) Slowly turn the [SQL/CHK] CONTROL clockwise until the received noise is quieted.

- Perform this setting only on a vacant frequency (no received signal).
- The green [T/R] INDICATOR goes out.
- Setting the squelch in this manner mutes all sound from the speaker until a signal is received. On receiving a signal, it opens the squelch circuit and the signal is audible.
- Do not advance the [SQL/CHK] CONTROL beyond the point where the green [T/R] INDICATOR goes out or weak signals will not be heard.

4) Select the desired operating frequency by using either the TUNING CONTROL, or the [UP] or [DN] SWITCH on the microphone.

- If the letter "M" appears on the display below the memory channel number, push the [VFO] side of the [VFO/MR] SWITCH to clear the MEMORY mode.
- When a signal is received, the green [T/R] INDICATOR lights, the "S/RF" INDICATOR displays the signal strength and the audio is heard from the speaker.



## (2) SELECTING A FREQUENCY

### (A) USING THE TUNING CONTROL

1) Select the VFO mode.

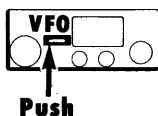

2) Use [DOWN/UP] SWITCH.

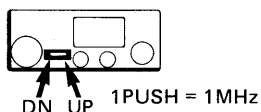

3) Set tuning step size.

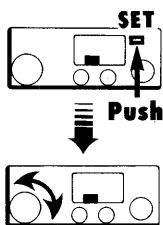

4) Select VFO mode.

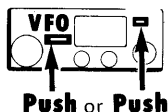

5) Select frequency.

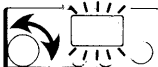

1) Select the [VFO] side of the [VFO/MR] SWITCH.

2) Use the [DOWN/UP] SWITCH on the front panel to select the desired MHz range.

- Each time this switch is pushed, the frequency changes by 1MHz down or up.

3) Push the [SET] SWITCH repeatedly until the "TS" INDICATOR appears flashing on the display.

- The currently programmed tuning step size also appears:  
U.S.A. and Australia versions : 5, 10, 15, 20 or 25kHz  
Europe version : 12.5 or 25kHz

- To change the tuning step size, turn the TUNING CONTROL until the desired step size appears.

4) Push the [SET] SWITCH or [VFO] side of the [VFO/MR] SWITCH to select the VFO mode.

5) Use the TUNING CONTROL to select the exact frequency desired.

- As the TUNING CONTROL is turned, the frequency changes in increments as set in step 3).

### (B) USING THE MICROPHONE

1) Select desired MHz range and set tuning step size.

2) Push [UP] or [DN] SWITCH on microphone.

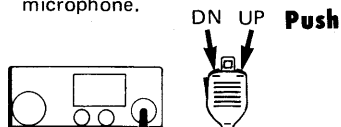

1PUSH = 1STEP  
1PUSH > 0.5 sec → SCAN STARTS  
1PUSH  
SCAN STOPS

1) Follow steps 1) through 4) under (A) USING THE TUNING CONTROL.

2) Push the [UP] SWITCH or [DN] SWITCH on the microphone until the correct frequency appears on the display.

- Each time the [UP] SWITCH or [DN] SWITCH is pushed, the frequency changes by one increment.

- If these switches are held down for longer than about 1/2 second, the frequency scan function begins. Refer to SECTION 5 - 3 (1) FREQUENCY SCANNING.

### (3) TRANSMITTING

- 1) Push and hold [PTT] SWITCH on microphone.

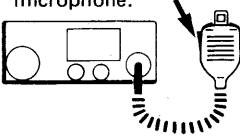

- 2) Speak into microphone.



- 3) Release [PTT] SWITCH.

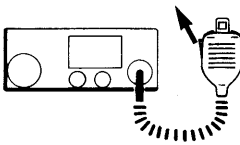

- (4) SELECTING OUTPUT POWER Push the [HI/LO] SWITCH to alternately change between HIGH and LOW transmit power.

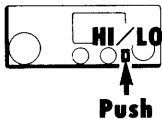

**NOTE:** When using HIGH power, the IC-48A/E may become warm. This is normal.

Before transmitting, ensure your transmit frequency is not being used by other stations.

- 1) Push and hold the [PTT] SWITCH on the microphone to activate the transmitter.

- The red [T/R] INDICATOR lights and the "S/RF" INDICATOR shows the relative output power of the transmitter.

- 2) Speak into the microphone using your normal voice level.

- Do not hold the microphone too closely to your mouth or speak too loudly. This may cause a distorted signal.

- 3) Release the [PTT] SWITCH to stop transmitting.

- The red [T/R] INDICATOR goes out.

- The receive mode is restored.

HIGH POWER: 25W

LOW POWER : 5W

### 5-2 MEMORY MODE



- (1) MEMORY READING

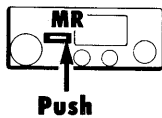

Memory channels 1 through 21 are useful for storing often-used frequencies. On all versions of the IC-48A/E except the U.S.A. version, channel 21 is reserved for the call function frequency. Refer to SECTION 5-5 CALL CHANNEL FUNCTION.

Push the [MR] side of the [VFO/MR] SWITCH to select the MEMORY mode.

- The letter "M" appears below the small memory channel number on the right side of the display to indicate the MEMORY mode is selected.

- (A) USING THE TUNING CONTROL

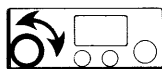

Turn the TUNING CONTROL clockwise or counterclockwise to select the desired memory channel.

- The selected memory channel number and contents of the memory appear on the display.

- This method is useful when a specific memory channel is desired.

**NOTE:** The microphone SCAN SWITCH must be ON. See page 23 for more information.

**Ⓑ USING THE DOWN/UP SWITCH**

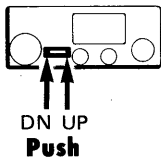

Push the [DOWN] or [UP] side of the front panel [DOWN/UP] SWITCH to individually step through the memory channels.

- Each memory channel number and contents of its memory appear on the display as the IC-48A/E steps through the memory channels.
- This method is useful when wishing to slowly check several or all of the programmed memory channels.

**Ⓒ USING THE MICROPHONE**

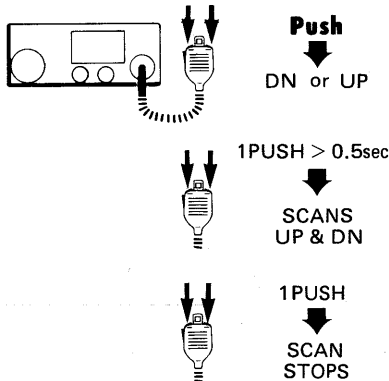

Push the [UP] SWITCH or [DN] SWITCH on the microphone to step through the memory channels.

- Each memory channel number and contents of its memory appear on the display.
- This method is useful to monitor all channels since holding these switches down for longer than about 1/2 second causes the memory scan function to begin. Refer to SECTION 5 - 3 (2) MEMORY CHANNEL SCANNING.

**NOTE:** The microphone SCAN SWITCH must be ON.

**(2) MEMORY PROGRAMMING**

Example: Store 444.950MHz in memory channel 10.

Use the following procedure to store operating frequencies plus duplex and memory skip information in memory channels. The duplex and memory skip functions are described in later sections.

- 1) Select memory channel 10.

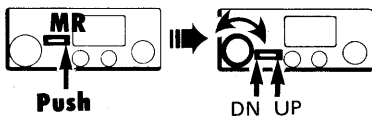

- 1) Select the memory channel to be programmed by using the MEMORY READING procedure as described in SECTION 5 - 2 (1) MEMORY READING.

- 2) Select VFO mode.

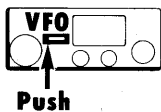

- 2) Push the [VFO] side of the [VFO/MR] SWITCH.

- 3) Select 444.950MHz.



- 3) While in the VFO mode, select the information you wish to write into a memory channel:
- a) operating frequency (SECTION 5 - 1)
  - b) duplex and subaudible tone programming (SECTION 5 - 4)
  - c) memory skip programming (SECTION 5 - 3)

- 4) Push [WRITE] SWITCH.

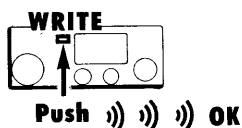

- 4) Push and hold the [WRITE] SWITCH for about 1/2 second.

- The 3 short tones indicate that the information selected in step 3) is now stored in the memory channel. Do not release the [WRITE] SWITCH until the 3 tones are heard.
- Push the [MR] side of the [VFO/MR] SWITCH to confirm the memory channel has the correct information stored.

### (3) MEMORY CHANNEL TO VFO TRANSFERS

Example: Transfer the contents of memory channel 15 to the VFO.

- 1) Select memory channel 15.

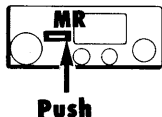

- 2) Push and hold [WRITE] SWITCH.

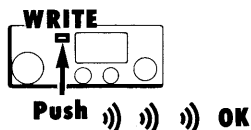

At times it may be desirable to transfer the contents of a memory channel to the VFO. Perform the following steps:

- 1) Select the memory channel containing the information to be transferred.

- Refer to SECTION 5 - 2 (1) MEMORY READING for information on selecting memory channels.

- 2) Push and hold the [WRITE] SWITCH for about 1/2 second.

- The 3 short tones indicate that the information contained in the memory channel has been transferred to the VFO. Do not release the [WRITE] SWITCH until the 3 tones are heard.

- After the transfer is completed, the IC-48A/E changes to the VFO mode and the MEMORY mode "M" disappears from the display.

- This transfer function does not affect the contents of the memory channel.

### 5 - 3 SCAN FUNCTIONS

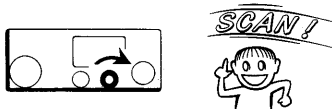

- (1) FREQUENCY SCANNING

Both frequency and memory scanning on the IC-48A/E are controlled from the microphone. Before attempting to use either scan function, set the [SQL/CHK] CONTROL as below:

- [SQL/CHK] CONTROL : Speaker noise quieted
- [T/R] INDICATOR : OFF

When using the frequency scan, the entire frequency range is automatically searched by the IC-48A/E using the programmed size of frequency steps (SECTION 5 - 1 (2) SELECTING A FREQUENCY). The receiver only stops on frequencies where a signal is present.

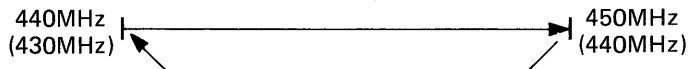

( ): Australia, Europe versions

- 1) Select VFO mode.

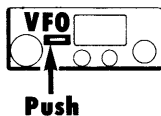

- 1) Push the [VFO] side of the [VFO/MR] SWITCH.

- 2) Push [UP] or [DN] SWITCH to start scan.

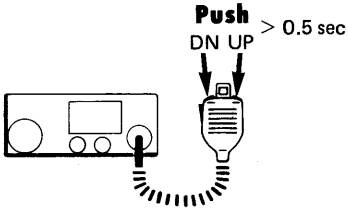

**NOTE:** The microphone SCAN SWITCH must be ON.

- 3) Push [UP] SWITCH or [DN] SWITCH to cancel scan.

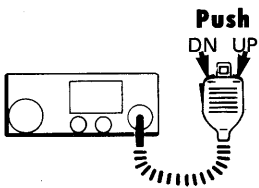

**(2) MEMORY CHANNEL SCANNING**

- 1) Select MEMORY mode.

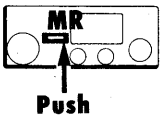

- 2) Push [UP] or [DN] SWITCH to start and stop scan.

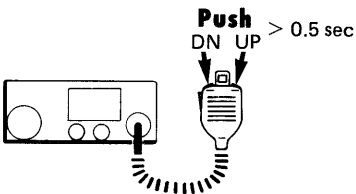

- 3) Push [UP] or [DN] SWITCH.

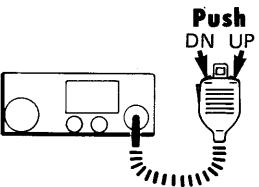

- 2) Push and hold the [UP] SWITCH or [DN] SWITCH on the microphone for about 1/2 second.

- The decimal point on the display begins to blink indicating the scan has started.
- The receiver scans in ascending order if the [UP] SWITCH is pushed, or in descending order if the [DN] SWITCH is pushed. The frequency on the display changes to indicate each frequency checked as the scan progresses.
- When a signal opens the receiver squelch circuit (i.e. the green [T/R] INDICATOR lights), the scan stops and the receiver monitors the signal. The scan begins again about 3 seconds after the frequency is clear of the signal, or about 15 seconds after the scan stops.

- 3) Push either the [UP] SWITCH or [DN] SWITCH on the microphone in order to cancel the scan function.

The memory channel scan is similar to the frequency scan except that all of the memory channels are checked repeatedly for signals.

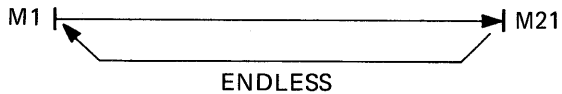

- 1) Push the [MR] side of the [VFO/MR] SWITCH.

- 2) Follow step 2) in FREQUENCY SCANNING above.

- 3) Push either the [UP] SWITCH or [DN] SWITCH on the microphone in order to cancel the scan function.

### (3) MEMORY SKIP FUNCTION

Memory channels which are not required to be scanned may be eliminated from the memory channel scan by the following procedure:

- 1) Select MEMORY mode.

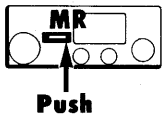

- 2) Select channel to be skipped.

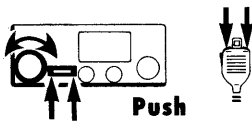

- 3) Push [SET] SWITCH.

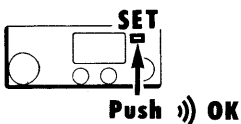

- 4) Push [SET] SWITCH to cancel skip function.

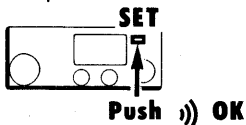

### 5-4 DUPLEX MODE

#### (1) DUPLEX PROGRAMMING

Example: Program the following frequencies:

Receive : 444.75MHz  
Transmit: 445.35MHz

- 1) Select VFO mode.

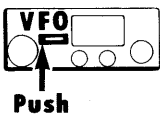

- 2) Select the receive frequency.



- 1) Push the [MR] side of the [VFO/MR] SWITCH.

- 2) Select the channel which is not required in the memory channel scan. Refer to SECTION 5 - 2 (1) MEMORY READING.

- 3) Push the [SET] SWITCH.

- The "SKIP" INDICATOR appears on the display.
- The selected channel will now be skipped when using the memory channel scan.

- 4) Push the [SET] SWITCH again to cancel the skip function on this channel.

**NOTE:** The memory channel scan will not operate if all memory channels are programmed to be skipped.

The duplex mode allows operation with a transmit frequency which is different from the receive frequency. This is necessary when operating through repeaters. When the receive and transmit frequencies are identical, this is referred to as the simplex mode.

**NOTE:** Transmit offset refers to the frequency difference between the receive and transmit frequencies when using the duplex mode.

- 1) Push the [VFO] side of the [VFO/MR] SWITCH.

- 2) Turn the TUNING CONTROL to select the receive frequency. Refer to SECTION 5 - 1 (2) SELECTING A FREQUENCY.

3) Push the [SET] SWITCH.

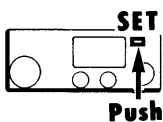

4) Select 5MHz transmit offset.

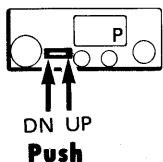

5) Select VFO mode.

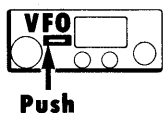

6) Push [DUP] SWITCH.

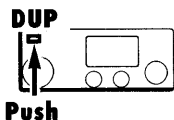

7) Push [SQL/CHK] CONTROL to check transmit frequency.

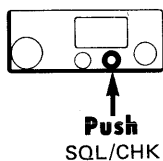

3) Push the [SET] SWITCH repeatedly until the "OW" INDICATOR appears flashing on the display.

- The current transmit offset and the offset programming symbol ("F" or "P") also appear.

DISPLAYED SYMBOL	MODEL	SYMBOL MEANING	OFFSET VALUE
"F"	IC-48A	FIXED Offset	5MHz
	IC-48E	FIXED Offset	7.6MHz
"P"	IC-48A	PROGRAMMABLE	0~7.99MHz
	IC-48E	Offset	0~9.9875MHz

4) Push the front panel [DOWN/UP] SWITCH to select one of the two methods for programming the transmit offset.

- The usual position is "F" since most repeaters operate with a 5MHz or 7.6MHz split between the receive and transmit frequencies.
- If the "P" position is selected, use the TUNING CONTROL to choose your required transmit offset value.

5) Push the [VFO] side of the [VFO/MR] SWITCH.

6) Push the [DUP] SWITCH to select either the DUPLEX (-) or DUPLEX (+) condition.

- DUP (-): The transmit frequency is lower than the receive frequency by the offset amount.
- DUP (+): The transmit frequency is higher than the receive frequency by the offset amount.
- Neither DUP (-) nor DUP (+) displayed:  
The IC-48A/E is in the simplex mode with both receive and transmit frequencies equal.

7) Push the [SQL/CHK] CONTROL in order to monitor the transmit frequency when operating with the duplex mode.

- This allows checking of the signal strength of your contacted station directly without going through a repeater. If the signal is received strongly enough directly, both stations should move to a simplex frequency.

(2) SUBAUDIBLE TONE ENCODER  
(IC-48A U.S.A. version)

The supplied tone encoder allows access to repeaters which require a subaudible tone superimposed on the transmit signal in order to open the squelch circuit of the receiver at the repeater station. Without this tone being present, the repeater cannot be used.

●PROGRAMMING THE SUBAUDIBLE TONE ENCODER

Example: Program 88.5Hz in subaudible tone memory 3.

- 1) Select VFO mode.

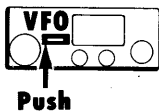

- 2) Push [SET] SWITCH.

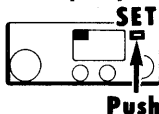

- 3) Push [DOWN/UP] SWITCH.

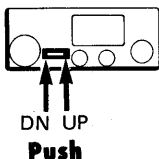

- 4) Turn TUNING CONTROL.



- 5) Select the VFO mode.

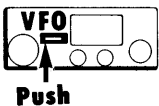

- 6) Select the duplex mode.

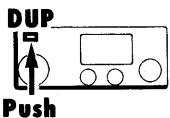

- 7) Activate tone encoder.



- 1) Push the [VFO] side of the [VFO/MR] SWITCH.

- 2) Push the [SET] switch repeatedly until the "TONE" INDICATOR appears flashing on the display.

- 3) Push the front panel [DOWN/UP] SWITCH to select one of the tone memories.

**NOTE:** In this mode, the IC-48A U.S.A. version can store a total of three tone numbers in the three tone memories. The tone memories are named "1", "2" and "3" and are designated with small numbers on the right side of the display.

- 4) Use the TUNING CONTROL to select a subaudible tone number.

- Refer to the SUBAUDIBLE TONE FREQUENCY CHART on page 22 to determine the number to select for your required tone frequency.

- 5) Push the [VFO] side of the [VFO/MR] SWITCH.

- 6) Push the [DUP] SWITCH to select DUPLEX (-) or DUPLEX (+).

- 7) Push the [TONE] SWITCH to turn the subaudible tone encoder ON or OFF.

- The "TONE" INDICATOR appears when the tone encoder is activated.
- The subaudible tone will be transmitted each time a transmission is made.
- The tone encoder does not function when the simplex mode is used.



●SUBAUDIBLE TONE ENCODER FREQUENCY CHART

(For using IC-48A U.S.A. version with repeaters)

TONE NUMBER	FREQUENCY (Hz)	TONE NUMBER	FREQUENCY (Hz)	TONE NUMBER	FREQUENCY (Hz)
01	67.0	15	110.9	29	179.9
02	71.9	16	114.8	30	186.2
03	74.4	17	118.8	31	192.8
04	77.0	18	123.0	32	203.5
05	79.7	19	125.3	33	210.7
06	82.5	20	131.8	34	218.1
07	85.4	21	136.5	35	225.7
08	88.5	22	141.3	36	233.6
09	91.5	23	146.2	37	241.8
10	94.8	24	151.4	38	250.3
11	97.4	25	156.7	39	-----
12	100.0	26	162.2	40	-----
13	103.5	27	167.9	41	-----
14	107.2	28	173.8	42	-----

(3) 1750Hz TONE BURST FUNCTION (IC-48E version only)

An audible tone burst may be generated for the purpose of accessing repeaters by the following method:

1) Select duplex mode.

1) Adjust the IC-48E for operation in the duplex mode as described in SECTION 5-4 (1) DUPLEX PROGRAMMING.

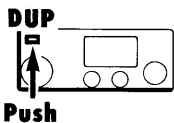

2) Push [TONE] SWITCH, then release it.

2) Push the [TONE] SWITCH on the back of the supplied microphone to generate the tone, then release it.

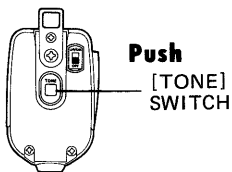

• It is usually best to transmit the tone at the beginning of each transmission for a period of approximately 300 milliseconds.

3) Transmit.

3) Push the [PTT] SWITCH on the microphone and transmit in the usual manner.

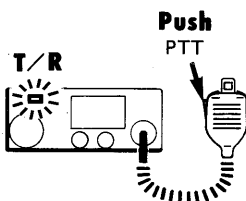

## 5-5 CALL CHANNEL FUNCTION

(except IC-48A U.S.A. version)

### (1) USING THE CALL FUNCTION

1) Push [CALL] SWITCH.

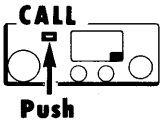

2) Push [CALL] SWITCH again.

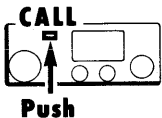

### (2) PROGRAMMING THE CALL CHANNEL

## 5-6 MICROPHONE

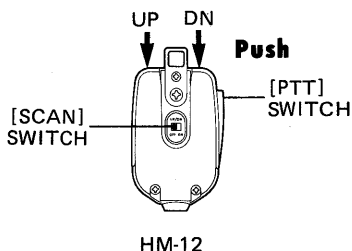

HM-12

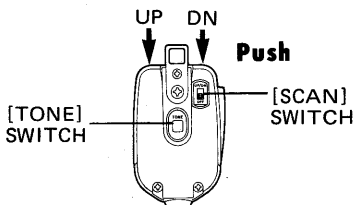

HM-15

**NOTE:** When scanning, the [SCAN] SWITCH must remain ON at all times.

Your highest priority or most frequently used channel should be stored as the call channel. The contents of memory channel 21 are reserved for the call channel function.

1) Push the [CALL] SWITCH while in either the VFO or MEMORY mode.

- The IC-48A/E immediately selects the frequency stored in memory channel 21.

- The call channel symbol "C" also appears on the display.

2) Push the [CALL] SWITCH again when finished with the call function.

- The IC-48A/E returns to the function in use before the call function was selected.

- The "C" disappears from the display.

- The [VFO/MR] SWITCH may also be used to return directly to either the VFO or MR mode.

To program the call channel, follow the same procedure for programming memory channel 21. Refer to SECTION 5-2 (2) MEMORY PROGRAMMING.

[PTT] SWITCH:

Push this switch to turn the transmitter ON and OFF.

[UP] SWITCH and [DN] (down) SWITCH (on the top):

Push either of these switches in the VFO mode to change the operating frequency in the direction indicated on the switch by one step. Hold either switch down to start the frequency scan (SECTION 5-3 (1) FREQUENCY SCANNING).

In the MEMORY mode, the switches change the selected memory channels one channel at a time. Hold either switch down to start the memory channel scan (SECTION 5-3 (2) MEMORY CHANNEL SCANNING).

[SCAN] SWITCH:

- OFF: The [UP] SWITCH and [DN] SWITCH on the microphone are disabled to eliminate the chance of accidental frequency or memory channel changes.

- ON: The [SCAN] SWITCH must be ON for the [UP] SWITCH and [DN] SWITCH to function as described above.

## 5-7 BACKUP BATTERY

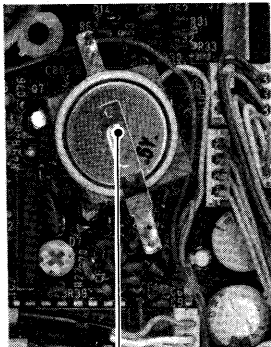

LITHIUM BATTERY

The IC-48A/E contains a lithium battery as a backup for the internal microcomputer memory in the transceiver for times when the external power source is removed or interrupted. The lithium battery is a reliable backup device which has been proven to last for more than five years under actual operating conditions.

After using the IC-48A/E for five years, monitor the transceiver operation carefully and replace the battery if there are repeated cases of display malfunction.

**NOTE:** Battery replacement should be done by your nearest authorized ICOM dealer or ICOM service center.

## 5-8 RESETTING INTERNAL MICROCOMPUTER (CPU)

Occasionally, the LCD READOUT may display erroneous information either during operation or when first applying power. This may, for example, be due to an external cause such as static electricity.

When this sort of problem is encountered, turn OFF the power to the IC-48A/E, wait a few seconds, and turn the power ON again. If the problem persists, perform the following procedure:

- 1) Turn ON the power to the IC-48A/E.
- 2) Locate the RESET HOLE in the bottom cover of the transceiver.
- 3) Insert a non-metallic probe through the hole and push the RESET SWITCH.
- 4) The microcomputer in the IC-48A/E is now reset and the following parameters are automatically set as shown in the chart below.

**NOTE:** After resetting the CPU, all memory channels must be re-programmed.

### ●INITIAL INDICATION

TRANSCEIVER	VFO FREQUENCY and MEMORY CHANNELS	TUNING STEPS	OPERATING MODE	TRANSMIT OFFSET
U.S.A. version	440.000MHz	25kHz	VFO/SIMPLEX	5MHz
Australia version	430.000MHz	25kHz	VFO/SIMPLEX	5MHz
Europe version	430.000MHz	25kHz	VFO/SIMPLEX	7.6MHz

## 5-9 OPTIONAL UNITS

The following are descriptions for the operation of two optional units which provide alternative squelch circuits. Refer to the INSTRUCTION sheets which accompany each unit for installation instructions and additional information.

### (1) PROGRAMMING THE UT-28 DIGITAL CODE SQUELCH UNIT

1)

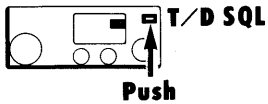

1) Push the [T/D.SQL] SWITCH.

- "D.SQL" appears on the display.

2)

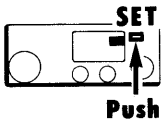

2) Push the [SET] SWITCH.

- "D.SQL" begins flashing on the display.
- A five digit group code and the memory in which it is stored appear. There are three memories reserved for storing group codes.

**NOTE:** The group code is a five digit number which must be programmed identically in both the transmitting and receiving radios in order for the digital code squelch system to function. Any number from 00000 to 99999 inclusive may be programmed.

3)

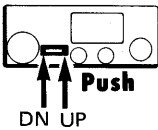

3) Use the front panel [DOWN/UP] SWITCH to select the desired group code memory.

4)

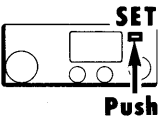

4) Push the [SET] SWITCH again.

- "AQS" begins flashing on the display and "D.SQL" disappears.
- A single digit in the group code also begins flashing.

AQS refers to Amateur Quinmatic System which includes digital code squelch as one feature. The digital code squelch used in AQS is not compatible with some other commercially available digital squelch systems.

5)



5) Turn the TUNING CONTROL to set the flashing digit to the number desired.

6)

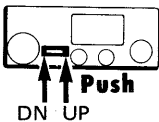

6) Use the front panel [DOWN/UP] SWITCH to select another digit in the group code.

- The newly selected digit begins flashing and the digit may be set with the TUNING CONTROL.

8)

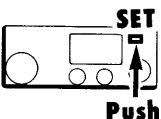

7) Set the three remaining group code digits in a similar manner.

8) Push the [SET] SWITCH.

(2) PROGRAMMING THE UT-29  
TONE SQUELCH UNIT

1) **DUP**

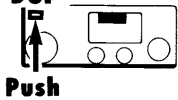

1) Use the [DUP] SWITCH to select the simplex mode.

- "DUP-" or "DUP+" should not appear on the display.

2)

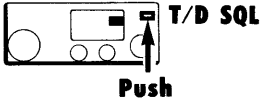

2) Push the [T/D.SQL] SWITCH.

- "D.SQL" and "TONE" appear on the display.

3)

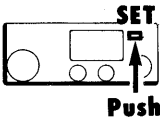

3) Push the [SET] SWITCH.

- "D.SQL" and "TONE" begin flashing on the display.
- A tone number and the memory in which it is stored appear. There are three memories reserved for storing tone numbers.
- Refer to the chart below for the correlation between the tone numbers and their associated frequencies.

4)

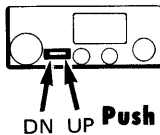

4) Use the front panel [DOWN/UP] SWITCH to select the desired tone memory.

5)



5) Turn the TUNING CONTROL to choose the required tone number.

6)

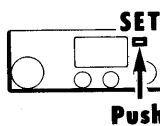

6) Push the [SET] SWITCH.

• UT-29 TONE SQUELCH UNIT  
SUBAUDIBLE FREQUENCIES

TONE NUMBER	FREQ. (Hz)	TONE NUMBER	FREQ. (Hz)	TONE NUMBER	FREQ. (Hz).
01	67.0	15	131.8	29	218.1
02	71.9	16	136.5	30	225.7
03	77.0	17	141.3	31	233.6
04	82.5	18	146.2	32	241.8
05	88.5	19	151.4	33	250.3
06	94.8	20	156.7	34	67.0
07	100.0	21	162.2	35	71.9
08	103.5	22	167.9	36	74.4
09	107.2	23	173.8	37	77.0
10	110.9	24	179.9	38	79.7
11	114.8	25	186.2	39	82.5
12	118.8	26	192.8	40	85.4
13	123.0	27	203.5	41	88.5
14	127.3	28	210.7	42	91.5

(3) OPTIONAL SQUELCH UNIT  
OPERATION

Complete the above programming before attempting to use either optional squelch unit.

1)

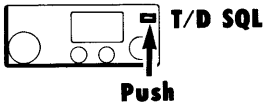

1) Push the [T/D.SQL] SWITCH to activate the squelch unit.

- UT-28: "D.SQL" appears on the display.
- UT-29: "D.SQL" and "TONE" appear on the display.  
(The simplex mode must be used.)

2) Operate the IC-48A/E in the usual manner as explained in the previous sections of this manual.

- Turn the optional squelch unit OFF with the [T/D.SQL] SWITCH in order to program the subaudible tone encoder, the transmit offset or the tuning steps.
- 3) When operating with the Digital Code Squelch Unit, confirm that the station with which you intend to communicate is using the same group code and an AQS system.
- 4) The scanning function cannot be used when the UT-28 Digital Code Squelch Unit is activated.

See UT-28 or UT-29 INSTRUCTIONS for further information.

## SECTION 6 INSIDE VIEWS

### 6-1 TOP VIEW (MAIN UNIT)

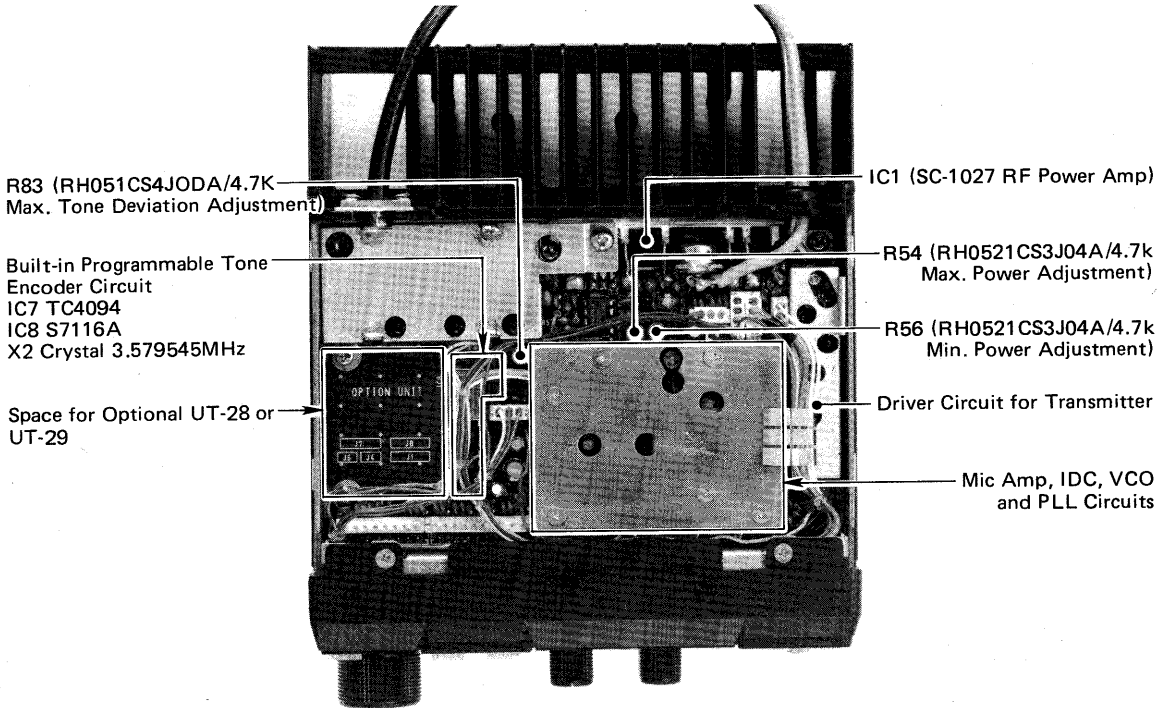

### 6-2 BOTTOM VIEW (RX UNIT)

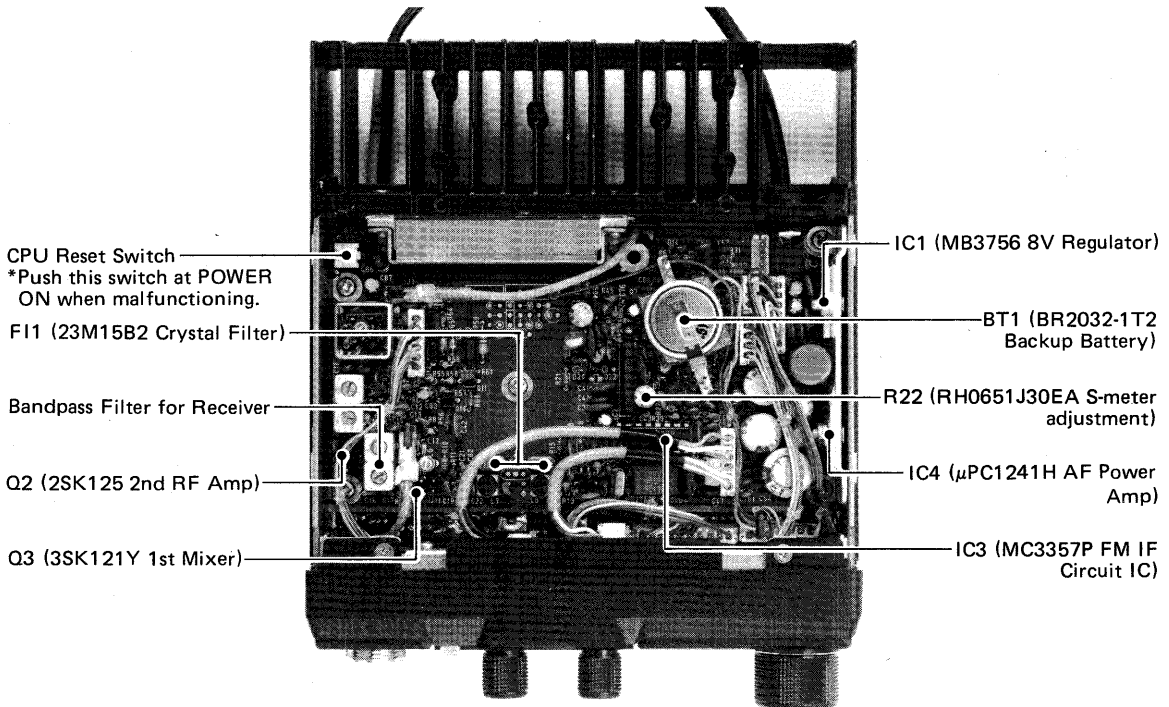

## SECTION 7 MAINTENANCE

### (1) OPERATING ENVIRONMENT



The IC-48A/E is a sensitive electronic device which should not be abused. Avoid using the IC-48A/E in excessively hot, humid or dusty environments. Do not subject the transceiver to strong vibrations or install it where water damage could result.

### (2) ADJUSTMENTS



No internal adjustment of the transceiver is required since all variable components have been set correctly by the factory. Misadjusting certain components may damage the transceiver.

### (3) MALFUNCTIONS



A variety of apparent problems can be solved by simply resetting the internal microcomputer in the IC-48A/E. Refer to SECTION 5-8 RESETTING INTERNAL MICROCOMPUTER (CPU) for detailed instructions.

### (4) CLEANING

The IC-48A/E will eventually require cleaning after sitting in your ham shack for a period of time. Remove the three knobs from the front panel and use a soft cloth with a mild, soapy solution. Do not use strong chemicals or cleaning solvents. Wipe dry before replacing the knobs on the panel.

### (5) FUSES

Locate the cause for a blown fuse before replacing it and attempting to operate the IC-48A/E again. The IC-48A/E uses 15 ampere fuses in the DC power cable.

#### ●CHANGING A FUSE

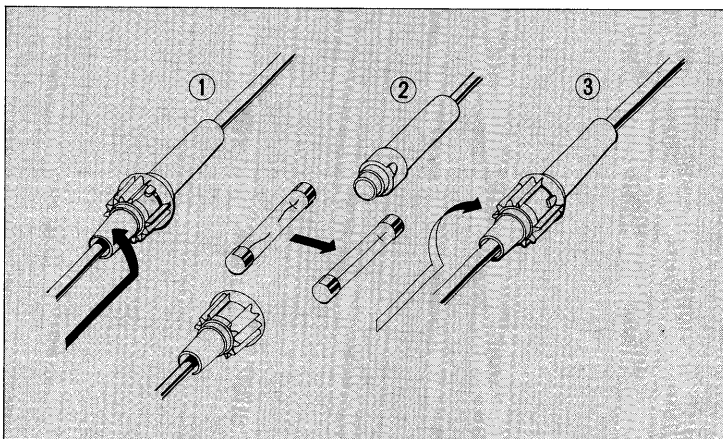



## ■ TROUBLESHOOTING

The following chart is designed to help you correct problems which are not equipment malfunctions. If you are not able to locate the cause of the problem or to solve it through the use of this chart, contact your nearest ICOM service center or dealer.

PROBLEM	POSSIBLE CAUSE	SOLUTION
1. Power does not come on when the [VOL/PWR] CONTROL is pushed ON.	<ul style="list-style-type: none"> <li>• Power cable is improperly connected.</li> <li>• Power connector is making poor contact.</li> <li>• Polarity of the power connection is wrong.</li> <li>• Blown fuse.</li> </ul>	<ul style="list-style-type: none"> <li>• Carefully reconnect power cable.</li> <li>• Check the connector pins.</li> <li>• Disconnect the power cable, replace the blown fuse, then reconnect the power cable observing proper polarity.</li> <li>• Check for the cause, then replace the fuse.</li> </ul>
2. No sound comes from the speaker.	<ul style="list-style-type: none"> <li>• Volume setting is too low.</li> <li>• [SQL/CHK] CONTROL is set incorrectly.</li> <li>• External speaker is connected.</li> </ul>	<ul style="list-style-type: none"> <li>• Set volume to an appropriate level.</li> <li>• Adjust squelch so the noise from the speaker is just quieted while receiving no signal.</li> <li>• Check that the external speaker plug is inserted properly, and that the external speaker cable is not cut.</li> </ul>
3. Sensitivity is low and only strong signals are audible.	<ul style="list-style-type: none"> <li>• Antenna feedline is cut or shortcircuited.</li> </ul>	<ul style="list-style-type: none"> <li>• Check, and if necessary, replace the feedline.</li> </ul>
4. No or low RF output.	<ul style="list-style-type: none"> <li>• The LOW position is selected with the [HI/LO] SWITCH.</li> <li>• [PTT] SWITCH on the microphone is not operating due to poor connection of the MIC CONNECTOR.</li> </ul>	<ul style="list-style-type: none"> <li>• Push the [HI/LO] SWITCH to select the HIGH output power position.</li> <li>• Check the connector pins on the MIC CONNECTOR.</li> </ul>
5. No modulation of the transmitter.	<ul style="list-style-type: none"> <li>• Poor connection of the MIC CONNECTOR.</li> </ul>	<ul style="list-style-type: none"> <li>• Check the connector pins on the MIC CONNECTOR.</li> </ul>
6. Frequency does not change when the TUNING CONTROL is turned.	<ul style="list-style-type: none"> <li>• MEMORY mode is selected.</li> </ul>	<ul style="list-style-type: none"> <li>• Push the [VFO] side of the [VFO/MR] SWITCH.</li> </ul>
7. An abnormal, out-of-band frequency is displayed on the LCD READOUT.	<ul style="list-style-type: none"> <li>• CPU malfunction.</li> <li>• Lithium backup battery is exhausted.</li> </ul>	<ul style="list-style-type: none"> <li>• Reset the CPU (microcomputer). Refer to SECTION 5 - 8.</li> <li>• Take your IC-48A/E to an authorized ICOM dealer or service center.</li> </ul>
8. Scan functions do not stop even when signals are received.	<ul style="list-style-type: none"> <li>• [SQL/CHK] CONTROL is set incorrectly.</li> </ul>	<ul style="list-style-type: none"> <li>• Adjust squelch so the noise from the speaker is just quieted while receiving no signal.</li> </ul>
9. Memory channel frequencies change after resetting the CPU.	<ul style="list-style-type: none"> <li>• All memories are initialized after the CPU is reset.</li> </ul>	<ul style="list-style-type: none"> <li>• Re-program the memory channels after the CPU is reset.</li> </ul>



## SECTION 9 OPTIONS

AC POWER SUPPLY  
(13.8V DC, 8A maximum)

PS-45

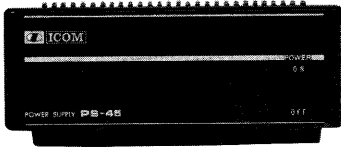

The OPC-102 interface cable to connect the PS-45 to the IC-48A/E must be purchased separately.

MOBILE SPEAKER

SP-10

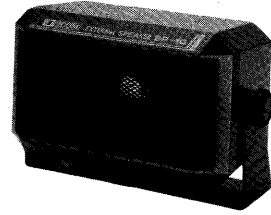

FLEXIBLE MOBILE MICROPHONE

HS-15

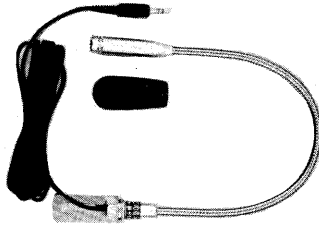

SWITCH BOX FOR HS-15

HS-15SB

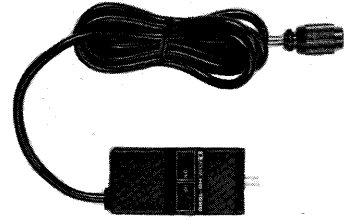

COMPRESSOR/GRAPHIC  
EQUALIZER MICROPHONE

SM-10



DESK MICROPHONE

SM-8

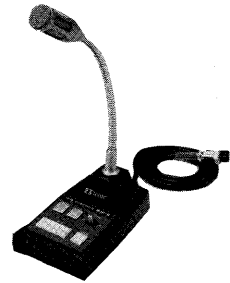

DIGITAL CODE SQUELCH UNIT

UT-28

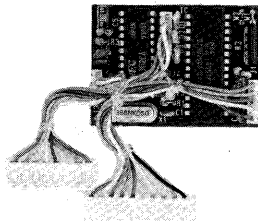

TONE SQUELCH UNIT

UT-29

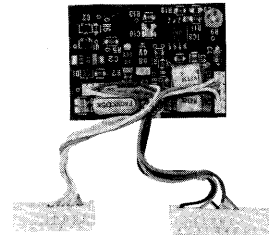

IC-HM14	DTMF MICROPHONE
SP-7	BASE SPEAKER
IC-HM16	SPEAKER-MICROPHONE (IC-48A)
IC-HM17	SPEAKER-MICROPHONE (IC-48E)



**ICOM INCORPORATED**

1-6-19, KAMI KURATSUKURI, HIRANO-KU,  
OSAKA 547, JAPAN

A-0791  
Printed in Japan