

iCOM

INSTRUCTION MANUAL

144 MHz FM TRANSCEIVER

IC-2iA

IC-2iE

UHF FM TRANSCEIVER

IC-4iA

IC-4iE

Icom Inc.

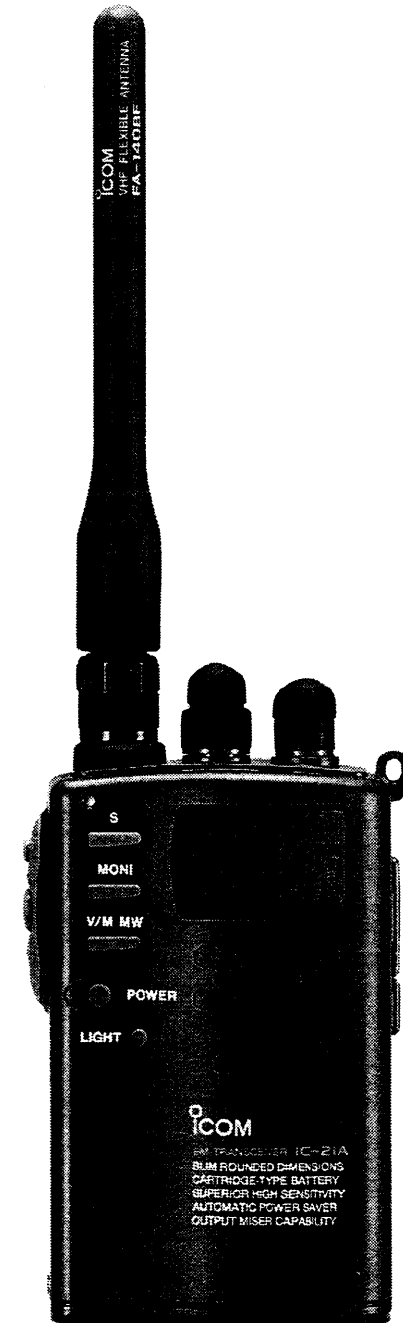

IMPORTANT

READ ALL INSTRUCTIONS carefully and completely before using the transceiver.

SAVE THIS INSTRUCTION MANUAL

— This instruction manual contains important safety and operating instructions for the IC-2iA/E and IC-4iA/E.

Note that this instruction manual applies only to those functions accessible in its factory-shipped state. For operating more advanced functions, a booklet titled "Tech Talk" is available from your Icom Dealer.

EXPLICIT DEFINITIONS

CAUTION : Equipment damage may occur.

NOTE : If disregarded, inconvenience only. No risk of personal injury, fire or electric shock.

WHEN FIRST APPLYING POWER

◇ Battery pack charging

Connect the supplied charger to the transceiver as shown in the figure below.

- DO NOT turn power ON while charging.
- Charging period is approx. 15 hrs.
- The internal rechargeable backup battery will be charged at the same time.

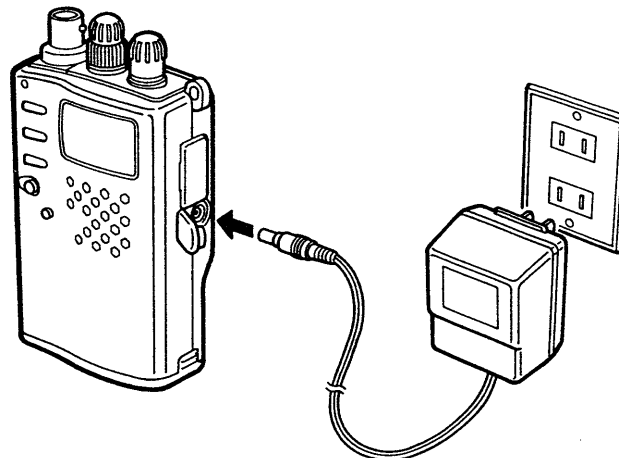

◇ Installing batteries into the battery case

Install six dry cell batteries as shown in the figures below.

- Pay attention to the polarities.

(Fig. 1)

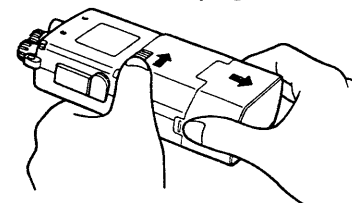

(Fig. 2)

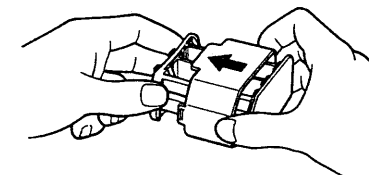

(Fig. 3)

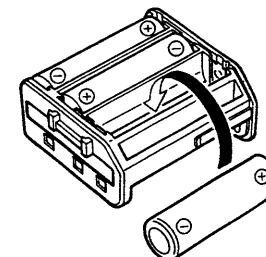

◆ Power ON

Push and hold [POWER] for 1 sec. to turn power ON.

The power key may not function when the transceiver has not been operated for 2 months or more as the internal rechargeable backup battery may have become empty. In this case, activate the CPU as described below.



Push and hold [POWER] for 1 sec. again to turn power OFF.

◆ Resetting the transceiver

Reset the transceiver before operating for the first time, or when the internal CPU malfunctions.

- ① Turn power OFF.
- ② While pushing [MONI] and [LIGHT], push and hold [POWER] for 1 sec. to reset the CPU.

• Activating the CPU (when the power does not come on)

For the battery pack type:

While pushing the [FUNC] key, insert the DC plug of the supplied charger into a [DC12.5V] jack.

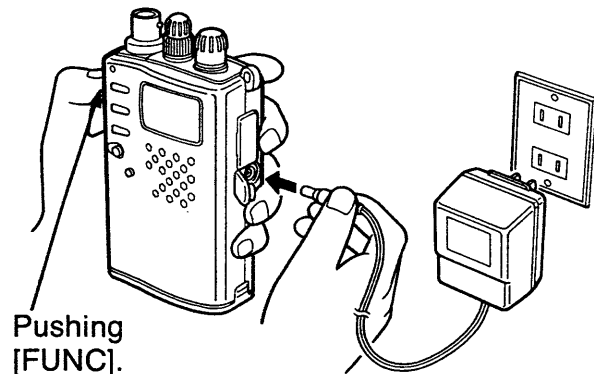

For the battery case type:

While pushing the [FUNC] key, attach the battery case.

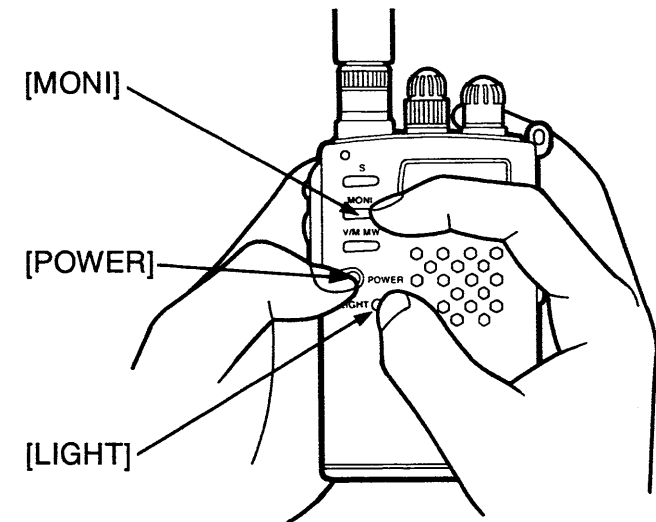
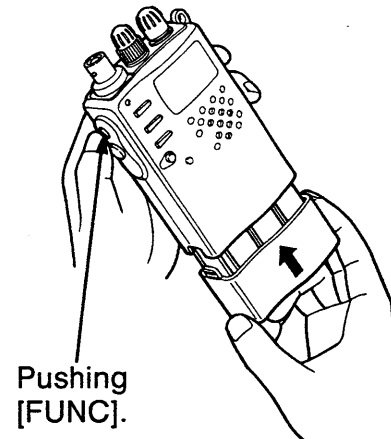

CAUTIONS

NEVER connect the transceiver to an AC outlet or to a power source of more than 16 V DC.

NEVER connect the transceiver to a power source using reverse polarity. This connection will ruin the transceiver.

NEVER allow children to touch the transceiver.

AVOID using or placing the transceiver in direct sunlight or in areas with temperatures below -10°C ($+14^{\circ}\text{F}$) or above $+60^{\circ}\text{C}$ ($+140^{\circ}\text{F}$).

BE CAREFUL! When transmitting for a long time with high output power, the rear panel may become hot.

The use of non-Icom battery packs/chargers may impair transceiver performance and invalidate the warranty.

Even when the transceiver power is OFF, a slight current still flows in the circuits. Remove the battery pack or case from the transceiver when not using the transceiver for a long time. Otherwise, the battery pack or installed dry cell batteries in the battery case will become exhausted.

UNPACKING

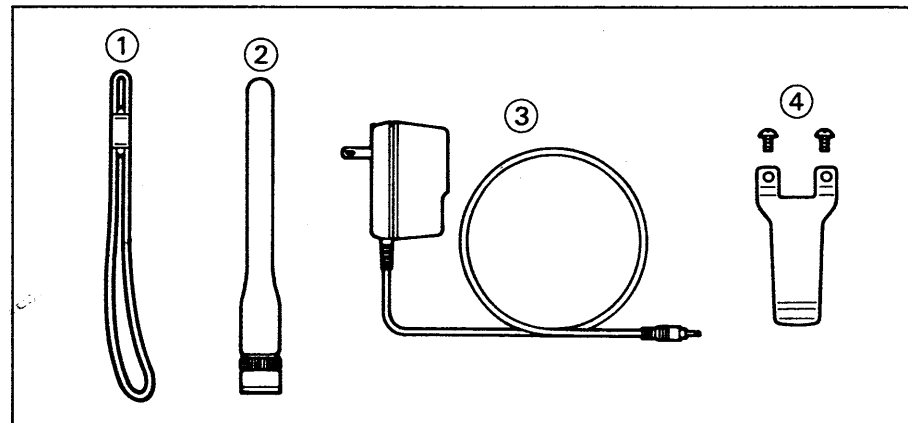

Accessories included with the transceiver:	Qty.
① Handstrap	1
② Antenna	1
③ Wall charger*	1
④ Beltclip and screws	1 set
Battery pack (BP-121) or battery case (BP-120) (attached with the transceiver)	1

*Not included with versions which have a battery case.

This instruction manual uses the IC-2iA/E for the example displays. Please note that only the frequency differs from the IC-4iA/E.

TABLE OF CONTENTS

IMPORTANT	i	4 FUNCTIONS	11 ~ 14
EXPLICIT DEFINITIONS	i	■ Selecting a memory channel	11
WHEN FIRST APPLYING POWER	i ~ ii	■ Programming a frequency into a memory channel	11
CAUTIONS	iii	■ Transferring a programmed frequency to VFO	12
UNPACKING	iii	■ Scan types	13
TABLE OF CONTENTS	iv	■ Programmed scan	13
1 PANEL DESCRIPTION	1 ~ 3	■ Memory scan	13
■ Panel description	1	■ Adjusting the clock	14
■ Function display	3	5 REPEATER OPERATION	15 ~ 20
2 BATTERY PACK CHARGING	4 ~ 6	■ Easy mode and multi-function mode	15
■ Battery pack charging	4	■ Settings for repeater use	15
■ Charging precautions	4	■ Repeater operation	20
■ About the battery pack	4	6 TROUBLESHOOTING	21
■ Charging examples	5	7 SPECIFICATIONS	22
3 OPERATION	7 ~ 10	SCHEMATIC AND BLOCK DIAGRAMS	SEPARATE
■ Accessory attachment	7		
■ Setting a frequency	8		
■ Receiving	10		
■ Transmitting	10		

PANEL DESCRIPTION

■ Panel description

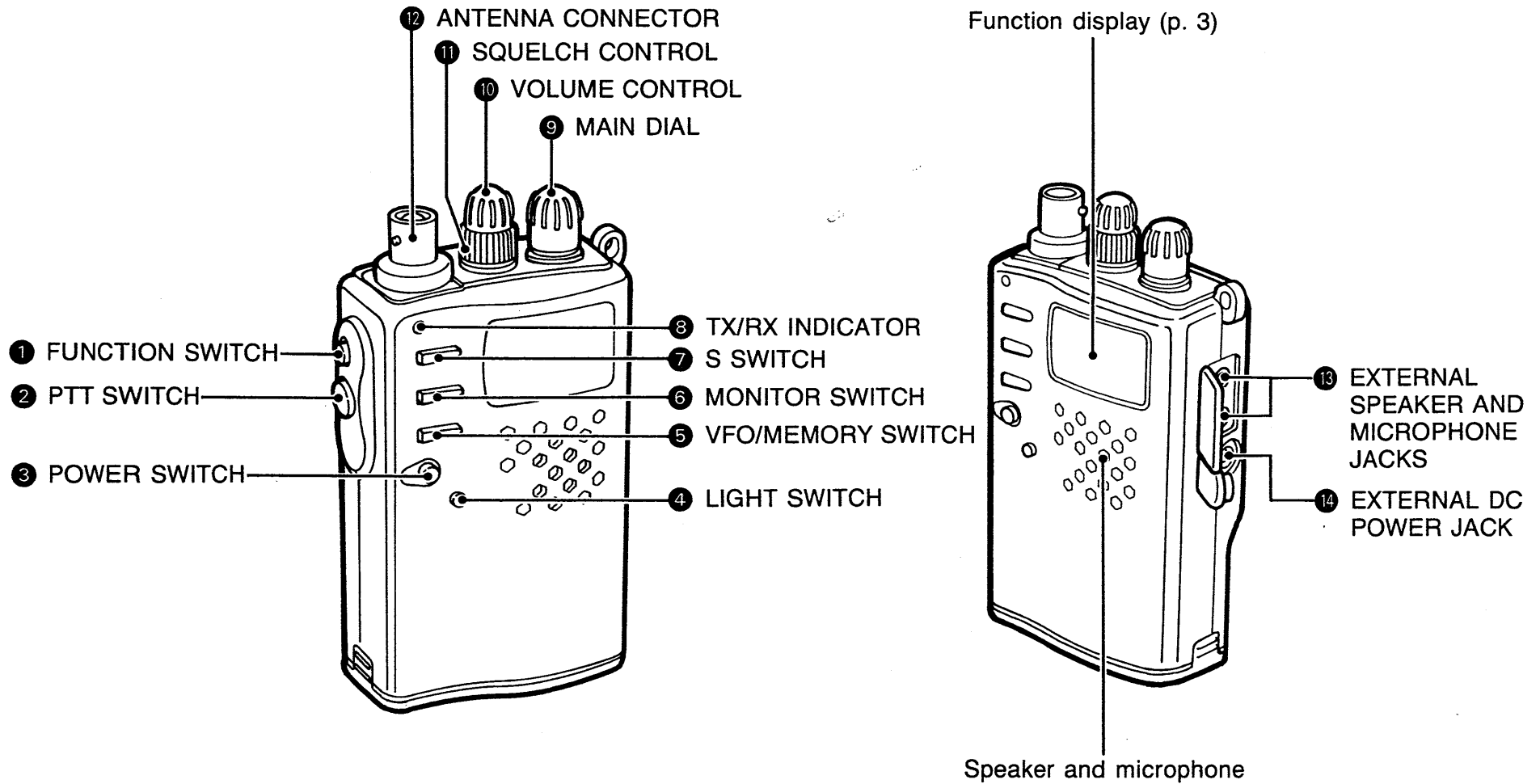

1 FUNCTION SWITCH [FUNC]

While pushing this switch, other switches and the main dial perform secondary functions.

- “Push [FUNC] + [LIGHT]” means “while pushing the [FUNC] switch, push the [LIGHT] switch.”

2 PTT SWITCH [PTT] (p. 10)

Push and hold to transmit; release to receive.
Selects high or low output powers while pushing [FUNC].

3 POWER SWITCH [POWER] (p. ii)

Turns power ON and OFF when pushed for 1 sec.

4 LIGHT SWITCH [LIGHT] (p. 9)

Turns the LCD lighting ON and OFF.
Turns the lock function ON and OFF while pushing [FUNC].

5 VFO/MEMORY SWITCH [V/M MW]

Changes the mode, VFO and MEMORY. (p. 8)
Programs the displayed frequency into a memory channel while pushing [FUNC] in VFO mode. (pgs. 11, 12)
Transfers a programmed frequency to VFO while pushing [FUNC] in MEMORY mode. (p. 12)

6 MONITOR SWITCH [MONI]

Manually opens the squelch and monitors the transmit frequency. (p. 10)
Alters the dial select tuning step while pushing [FUNC]. (p. 9)

7 S SWITCH [S] (pgs. 13, 14)

Starts and stops scanning.
Enters the clock setting condition while pushing [FUNC].

8 TX/RX INDICATOR

Lights up in green while the squelch is open. Lights up in red while transmitting.

9 MAIN DIAL [DIAL] (pgs. 8, 9)

Selects operating frequency, memory channel etc.

10 VOLUME CONTROL [VOL] (p. 10)

Adjusts the audio output level.

11 SQUELCH CONTROL [SQL] (p. 10)

Varies the squelch threshold point for noise mute.

12 ANTENNA CONNECTOR (p. 7)

Connects the supplied antenna.

13 EXTERNAL SPEAKER AND MICROPHONE JACKS [MIC]/[SP]

Connect an optional speaker-microphone or headset, if desired. The internal speaker and microphone will not function when either is connected.

14 EXTERNAL DC POWER JACK [DC12.5V] (pgs. 5, 6)

Connects the supplied wall charger for charging the battery pack.
Allows operation with a 12.5 V DC power source using the optional cables, CP-13L or OPC-288L.

1 PANEL DESCRIPTION

■ Function display

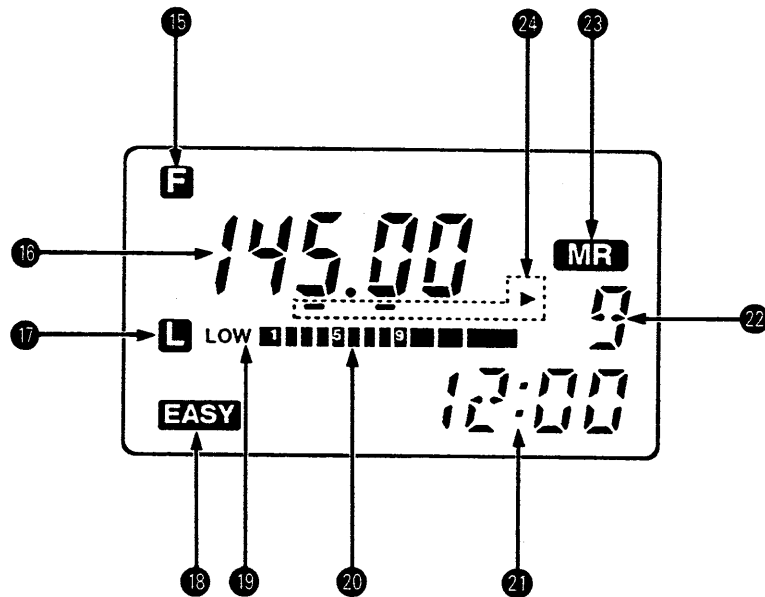

- ⑮ **FUNCTION INDICATOR**
Appears while the [FUNC] switch is pushed.
- ⑯ **FREQUENCY READOUT**
Shows the operating frequency.
- ⑰ **LOCK INDICATOR** (p. 9)
Appears while the lock function is activated.
- ⑱ **EASY MODE INDICATOR**
Constantly displayed during regular use of the transceiver.
- ⑲ **LOW POWER INDICATOR** (p. 10)
Appears while low output power is selected.
- ⑳ **S/R F INDICATOR** (p. 10)
Shows the relative signal strength while receiving.
Shows the selected output power while transmitting.
- ㉑ **CLOCK INDICATOR** (p. 14)
Shows the time.
- ㉒ **MEMORY CHANNEL READOUT** (p. 11)
Indicates a memory channel number or scan edge channel number.
- ㉓ **MEMORY MODE INDICATOR** (p. 8)
Appears while MEMORY mode is selected.
- ㉔ **DIAL SELECT TUNING INDICATORS** (p. 9)
One indicator appears while the [FUNC] switch is pushed.
It shows the selected dial select tuning step.

■ Battery pack charging

The supplied* BP-121 BATTERY PACK includes rechargeable NiCd batteries and can be charged 300 times (approx.). Charge the battery pack before first operating the transceiver or when the battery pack becomes empty (p. 5)

* Optional for versions which come with the BP-120 BATTERY CASE.

■ Charging precautions

NEVER attempt to charge dry cell batteries. This will cause internal liquid leakage and damage the transceiver.

NEVER connect two or more chargers at the same time.

Turn the transceiver power OFF during charging.

Charging may not occur in extreme cold (under 0°C; +32°F) or extreme heat (over +40°C; +104°F).

■ About the battery pack

◇ Using your battery pack wisely

Although battery packs may not be damaged by charging periods of one week or more, overcharging and complete discharging shorten the life of a battery pack. Recharging can usually be performed 300 times, but battery life can be lengthened to about 500 recharges as follows:

1. Avoid overcharging. The charging period should be less than 48 hours.
2. Use the battery until it becomes almost empty under normal conditions. We recommend battery charging as soon as transmitting becomes impossible.

◇ Operating period

The operating period listed below are calculated values for your reference.

BATTERY PACK	OUTPUT VOLTAGE	OPERATING PERIOD (Approx.)	
		IC-2iA/E	IC-4iA/E
BP-121	7.2 V	3 h 40 m	3 h 30 m
BP-122	7.2 V	6 h 20 m	5 h 50 m
BP-123	7.2 V	11 h	10 h 20 m
BP-124	12.0 V	2 h 40 m	2 h 20 m

Operating condition: Transmitting at high power for 1 min., receiving for 1 min. and standby (power saved) for 8 min.

Operating period varies depending on other factors such as output power, temperature, etc.

2 BATTERY PACK CHARGING

■ Charging examples

◇ Regular charging

(For the BP-120 with NiCd batteries, BP-121, BP-122 and BP-123)

Connect the supplied wall charger to the [DC12.5V] jack as shown in the figure below.

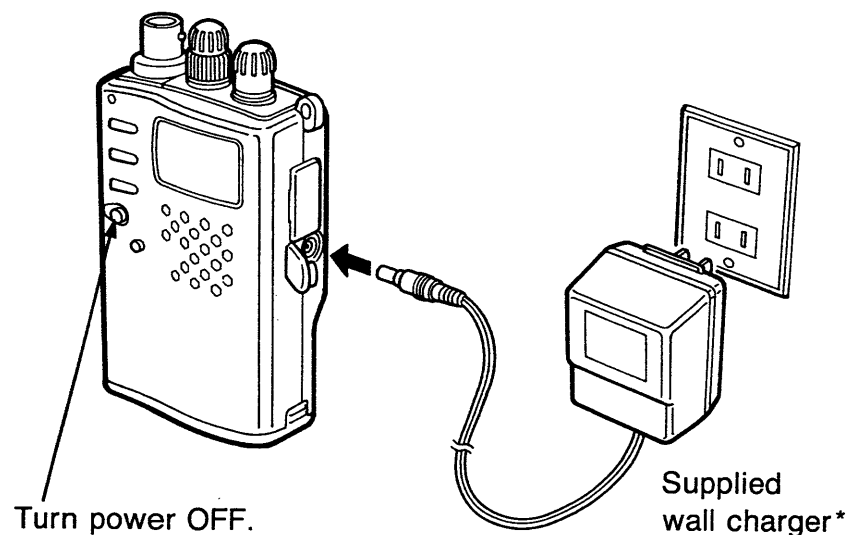

- BC-77A/E/D/V can charge BP-121 ~ 124 or NiCd batteries with BP-120.
- BC-78E/D is for charging the BP-121 only.
- * Optional for the versions which include the BP-120.

Charging period: 15 hrs. (approx.)

◇ Rapid charging with the optional BC-79 (For the BP-121, BP-122, BP-123 and BP-124)

- ① Insert the optional AD-26 CHARGER ADAPTER into the charging slot of the BC-79.
- ② Firmly insert a battery pack into the AD-26.

The BP-120 BATTERY CASE cannot be charged with the BC-79 even when NiCd batteries are installed.

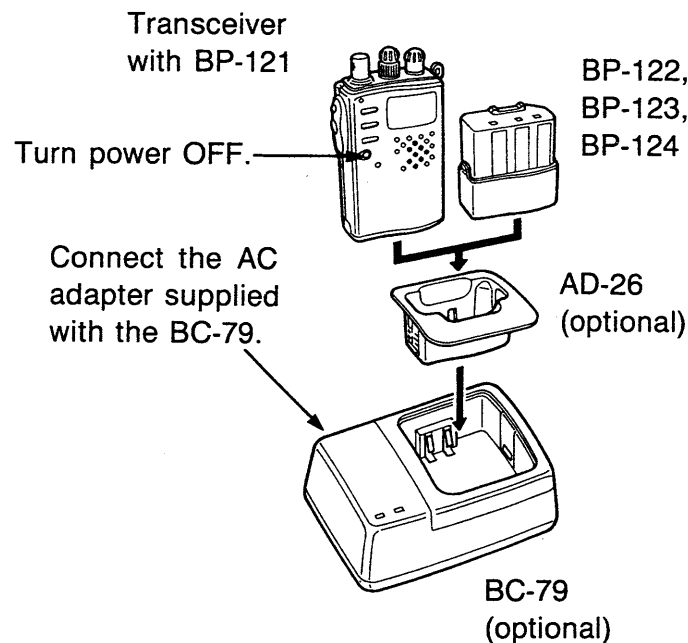

Charging period: 1 ~ 2 hrs. (approx.)

◇ Charging with an optional charger or cable (For the BP-120 with NiCd batteries, BP-121, BP-122, BP-123 and BP-124)

- To charge the BP-121 ~ BP-123 or NiCd batteries with the BP-120, connect the charger or cables to the [DC12.5V] jack on the transceiver's side panel.
- To charge the BP-124, connect the charger or cables to the charging jack on the BP-124's side panel.

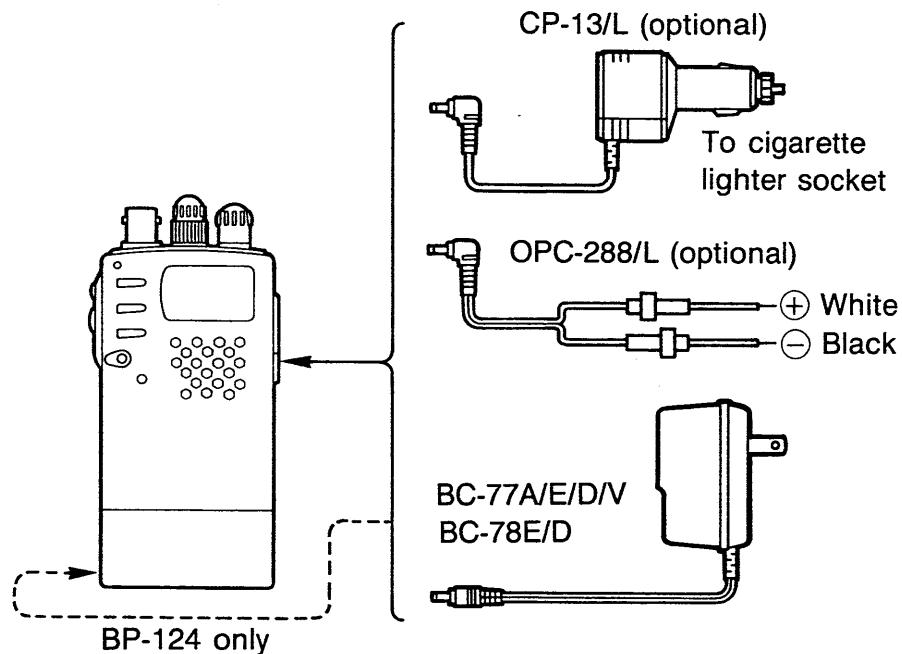

Charging period: 15 hrs. (approx.)

◇ When the battery pack becomes empty:

- Transmitting is interrupted even while the [PTT] switch is continuously pushed.
- Function display becomes dark.
- The transceiver emits a battery alarm sound.
- The [POWER] switch does not function to turn power OFF.

As you cannot turn the transceiver power OFF when the battery pack becomes empty, connect the charger to the transceiver at first; then, turn power OFF and continue to charge the battery pack.

◇ Battery pack life

When the operating period becomes extremely short even after charging the battery pack fully, the battery pack needs replacing with a new one.

CAUTION: If you operate the transceiver using an external power source for a long time, the connected battery pack is constantly charged resulting in over charging. This will shorten the battery pack life.

■ Accessory attachment

◇ Antenna

Attach the supplied antenna to the antenna connector.

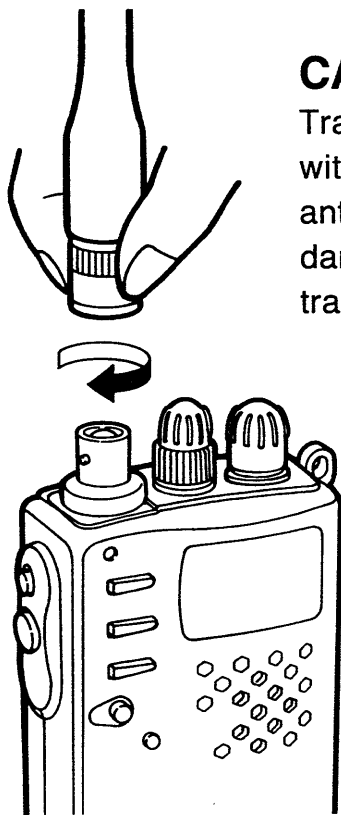

CAUTION:

Transmitting without the antenna may damage the transceiver.

◇ Belt clip

Remove the plastic screws, then attach the belt clip with the supplied metal screws. Conveniently attaches to your belt.

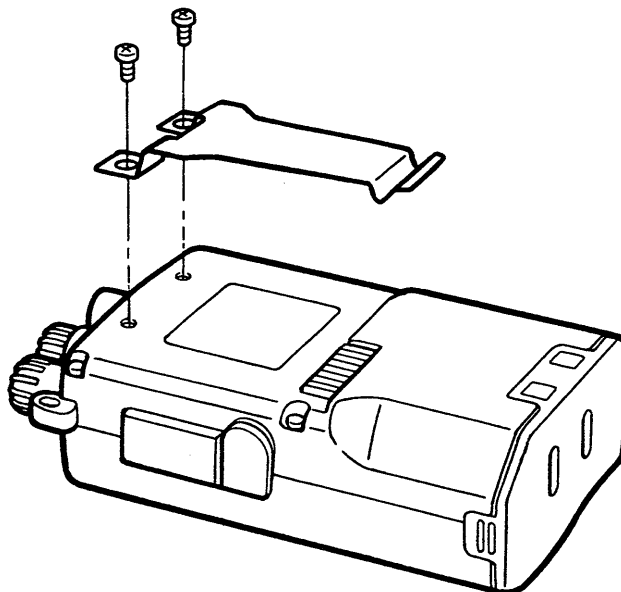

◇ Handstrap

Install the handstrap as shown in the figure below. Facilitates carrying.

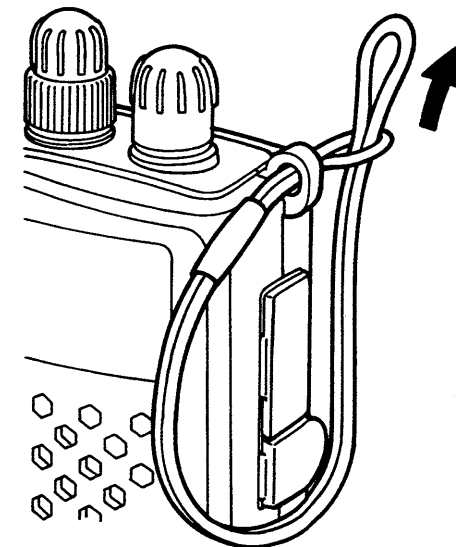

■ Setting a frequency

- ① Turn power ON.
- ② Select VFO mode if MEMORY mode has been selected.
 - Push [V/M MW] to select VFO mode.
 - See the box at right for more about VFO mode.
- ③ Rotate the main dial to set the frequency.
 - For quick tuning, rotate the main dial while pushing [FUNC]. (dial select tuning p. 9)
 - When “**L**” is indicated in the function display, the lock function has been activated and a frequency cannot be set. To cancel the lock function, push [FUNC] + [LIGHT]. (While pushing [FUNC], push [LIGHT].) (p. 9)

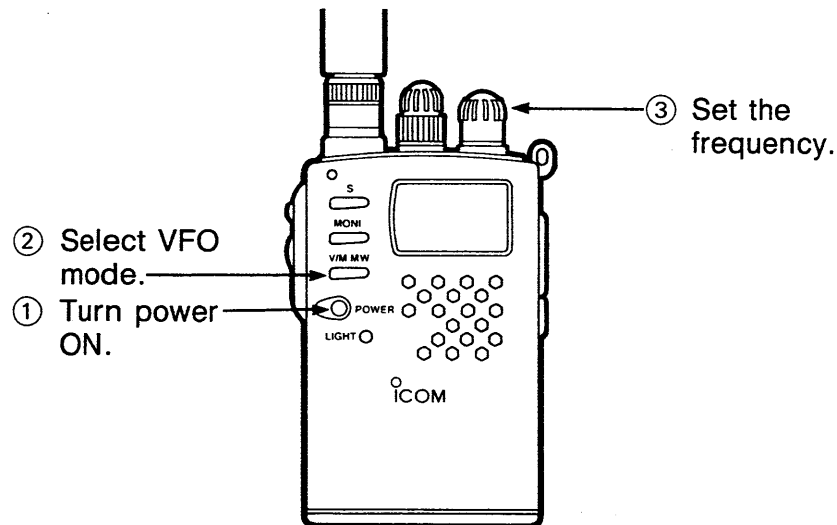

◇ VFO and MEMORY mode

This transceiver has 2 operating modes: VFO mode and MEMORY mode.

VFO mode (for setting a frequency):

This mode is used for setting a desired frequency within the entire band.

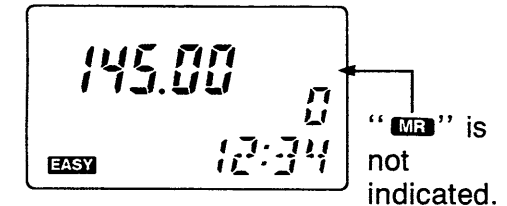

MEMORY mode:

This mode is used for operation of memory channels which have programmed frequencies. 10 memory channels are available to store 10 separate frequencies.

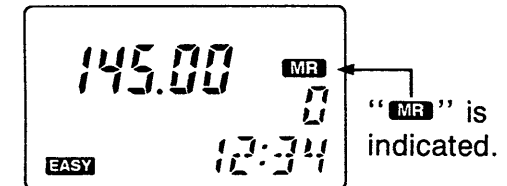

What is VFO?

VFO is an abbreviation of Variable Frequency Oscillation. Required frequencies for transmitting and receiving are controlled by the VFO.

3 OPERATION

◇ Dial select tuning

In VFO mode, [FUNC] + [DIAL] changes the frequency in 100 kHz steps or 1 MHz steps, or the memory channel number. This function is useful for quick tuning or memory channel selection in VFO mode such as when programming 2 or more memory channels.

- ① Select VFO mode.
- ② Push [FUNC] + [MONI] one or more times.
 - A “bar” appears under the selected digit (100 kHz or 1 MHz).
 - If “▶” appears instead of the “bar,” the memory channels are selected.
- ③ While pushing [FUNC], rotate [DIAL] to change the frequency or memory channel.

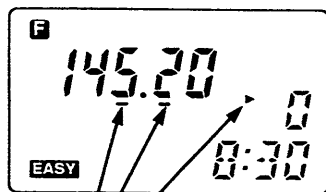

One of these indicators appears while pushing [FUNC] to show the selected step.

◇ Lock function

The lock function prevents accidental frequency changes, and accidental function activation.

- ① Push [FUNC] + [LIGHT] to turn the function ON.
 - “L” appears.
- ② To turn the function OFF, repeat step 1 above.
 - “L” disappears.

“L” appears to show the lock function is activated.

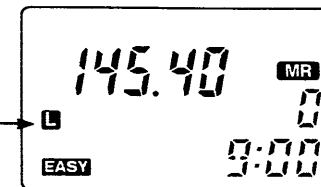

◇ LCD lighting

For easy viewing at nighttime, the transceiver has an LCD lighting function with a 5 sec. timer.

- ① Push [LIGHT] to turn the lighting ON.
- ② The lighting will automatically turn OFF when no switches or controls have been operated for 5 sec.
- ③ To turn OFF the lighting manually, push [LIGHT] again.

■ Receiving

- ① Turn power ON.
- ② Rotate [SQL] maximum counterclockwise.
- ③ Rotate [VOL] to adjust the desired audio output level.
- ④ Rotate [SQL] clockwise until noise is muted.
- ⑤ Set the frequency.

When a signal is received:

- The T/R indicator lights up in green.
- Squelch opens and audio is emitted from the speaker.
- The S/RF indicator shows the relative signal strength.

◇ Monitor function

This function is used to listen to weak signals without disturbing the squelch setting.

When receiving a signal that is too weak to open the squelch completely, push and hold [MONI].

■ Transmitting

CAUTION: Transmitting without an antenna may damage the transceiver.

NOTE: Before transmitting, listen on the frequency first to prevent interference to other stations.

- ① Set the operating frequency.
- ② Push and hold [PTT] to transmit.
 - The T/R indicator lights up in red.
 - The S/RF indicator shows the selected output power.
- ③ Speak into the microphone using your normal voice level.
 - DO NOT hold the transceiver too close to your mouth or speak too loudly. This may distort the signal.
- ④ Release [PTT] to receive.

◇ Output power selection

SELECTING HIGH OR LOW

Push [FUNC] + [PTT].

- “LOW” appears when low power is selected.

SETTING LOW OUTPUT POWER

- ① Push [FUNC] + [PTT].
- ② Continue holding [PTT], then release [FUNC] and rotate [DIAL] to select the desired low power level.

POWER SELECTION	S/RF INDICATOR	OUTPUT POWER (approx.)	
		with 13.8 V	with 7.2 V
HIGH		5.0 W	1 W
LOW 3	LOW	2.5 W	1 W
LOW 2	LOW	500 mW	500 mW
LOW 1	LOW	20 mW	20 mW

■ Selecting a memory channel

10 memory channels are available to store your desired frequencies. In addition, the transceiver has 2 scan edge channels, "PA" and "PB," for storing scan edge frequencies.

- ① Push [V/M MW] to select MEMORY mode.
 - "MR" appears.
- ② Rotate [DIAL] to select the desired memory channel.
- ③ Push [V/M MW] to return to VFO mode.
 - "MR" disappears.

MEMORY CHANNEL ARRANGEMENT

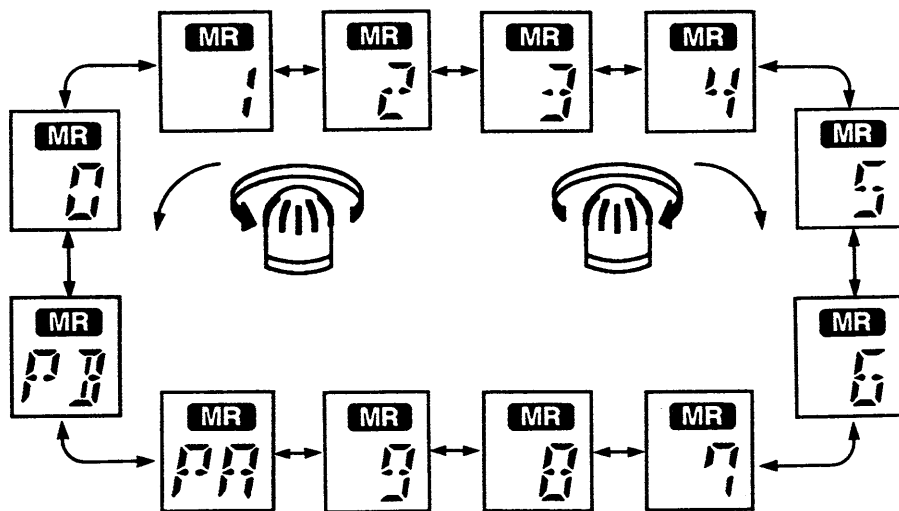

■ Programming a frequency into a memory channel

- ① Push [V/M MW] to select MEMORY mode.
 - "MR" appears.
- ② Rotate [DIAL] to select the memory channel to be programmed.
- ③ Push [V/M MW] to return to VFO mode.

[EXAMPLE]: Programming 145.40 MHz into memory channel 1.

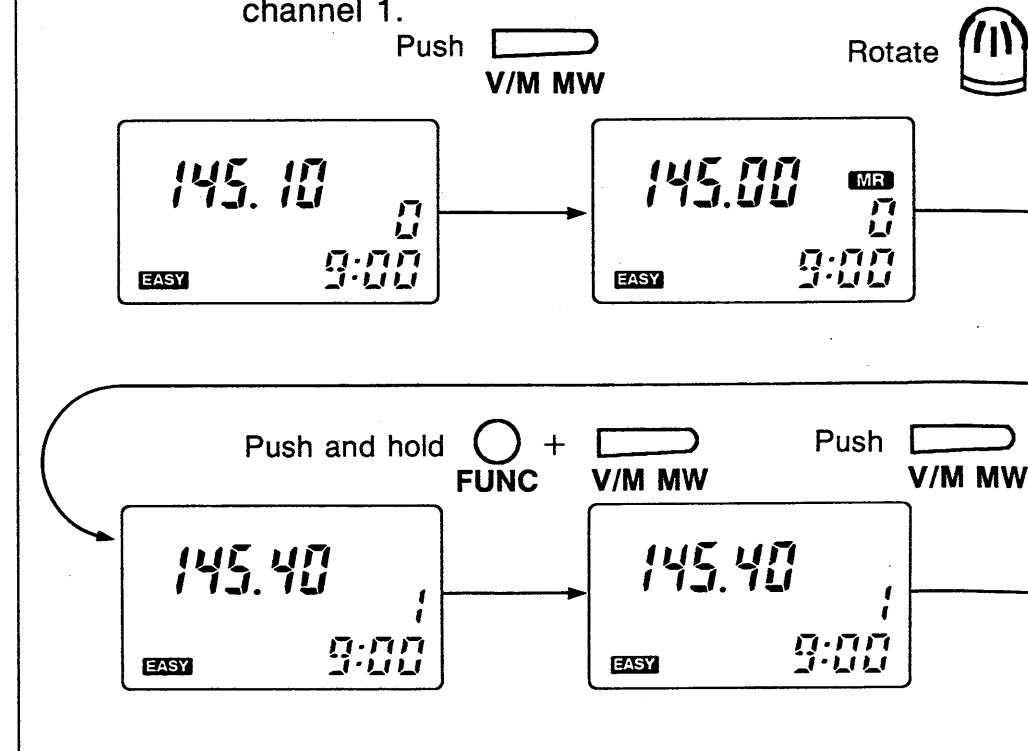

- ④ Set the desired frequency to be programmed by [DIAL].
- ⑤ Push and hold [FUNC] + [V/M MW] until 3 beeps are emitted.
- ⑥ Push [V/M MW] to select MEMORY mode and confirm the programmed frequency.

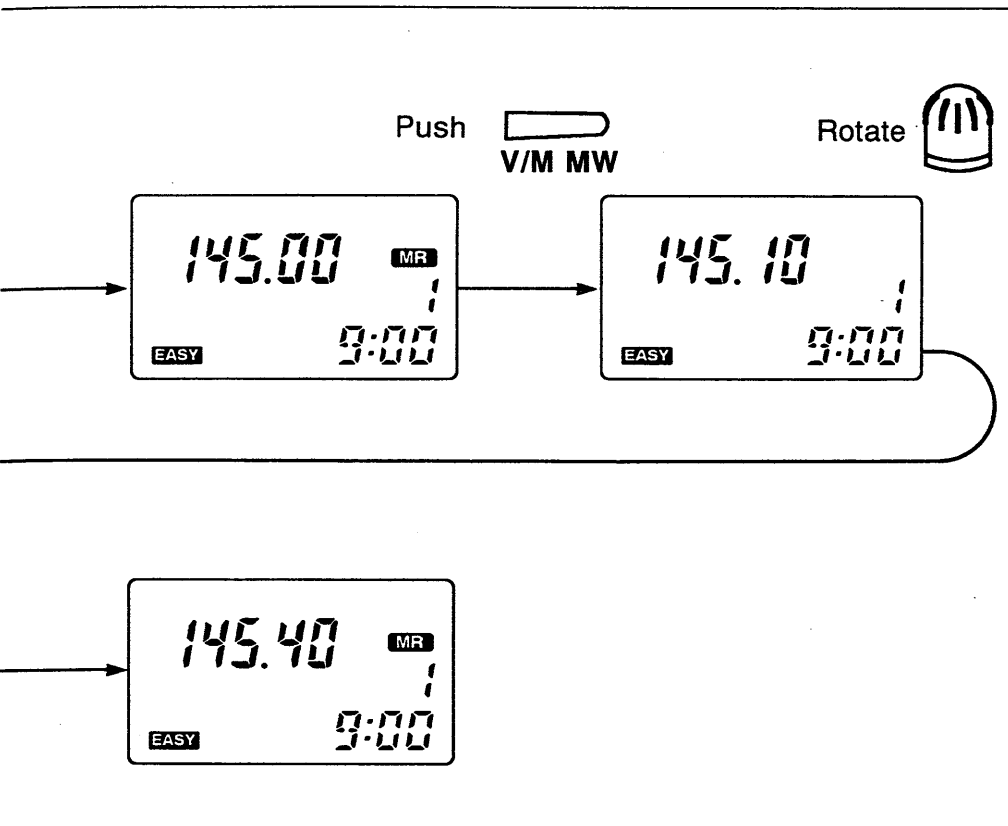

■ Transferring a programmed frequency to VFO

A programmed frequency can be transferred to VFO mode.

- ① Push [V/M MW] to select MEMORY mode.
 - “ MR ” appears.
- ② Rotate [DIAL] to select the memory channel to be transferred.
- ③ Push and hold [FUNC] + [V/M MW] until 3 beeps are emitted.

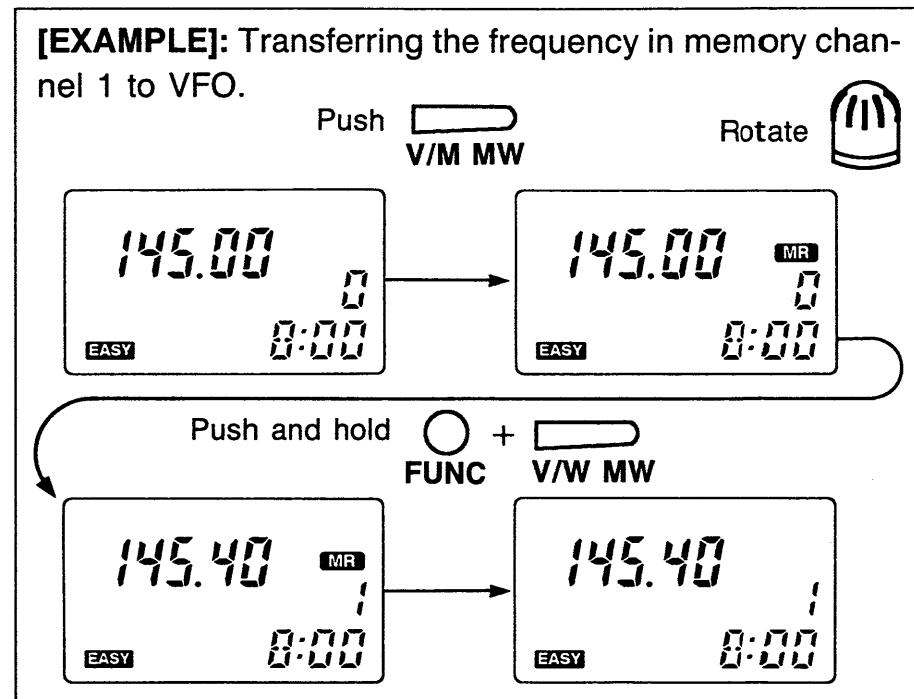

4 FUNCTIONS

■ Scan types

Scan is convenient for searching used frequencies and for finding new signals. 2 scan types are available for your convenience.

◇ Programmed scan

Repeatedly scans all frequencies between 2 specified frequencies. This scan is convenient for searching signals in a determined range such as the repeater band.

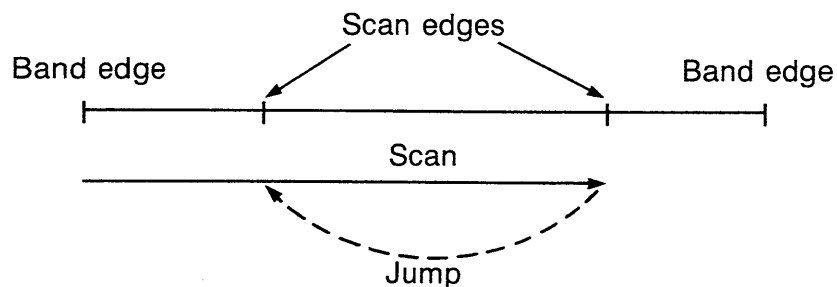

◇ Memory scan

Repeatedly scans memory channels 0 ~ 9 sequentially. This scan searches only for your desired frequencies.

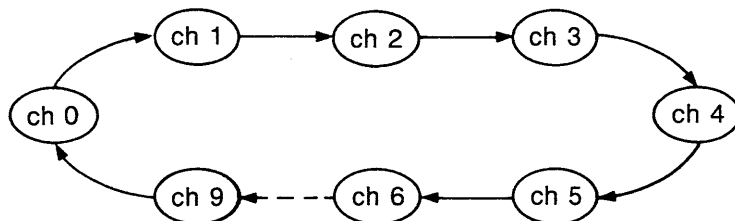

Always close the squelch (rotate [SQL] until noise disappears) before starting a scan.

■ Programmed scan

Scan edge frequencies should be programmed into the scan edge channels "PA" and "PB" in advance. (pgs. 11, 12)

- ① Select VFO mode using the [V/M MW] switch.
- ② Push [S] to start the scan.
 - To change the scanning direction, rotate [DIAL].
- ③ To stop the scan, push [S] again.

■ Memory scan

Scanning frequencies should be programmed into memory channels in advance. (pgs. 11, 12)

- ① Select MEMORY mode using the [V/M MW] switch.
- ② Push [S] to start the scan.
 - To change the scanning direction, rotate [DIAL].
- ③ To stop the scan, push [S] again.

◇ When the scan detects a signal:

- Scan pauses on the frequency for 10 sec. and then resumes.
- If the signal disappears while pausing, scan resumes 2 sec. after the signal disappears.
- To resume the scan manually, rotate [DIAL].
- In programmed scan, the detected frequency can be programmed into a memory channel by [FUNC] + [V/M MW].

■ Adjusting the clock

The transceiver has an internal clock which is indicated in the function display.

NOTE: Set the time using the 24-hour system.

- ① Push [FUNC] + [S].
 - The hour digits blink.
- ② Rotate [DIAL] to set the hour.
- ③ Push [S].
 - The minute digits blink.
- ④ Rotate [DIAL] to set the minutes.
- ⑤ Push [FUNC] to set the clock.
 - The time is now programmed.

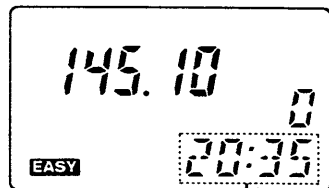

Clock indication

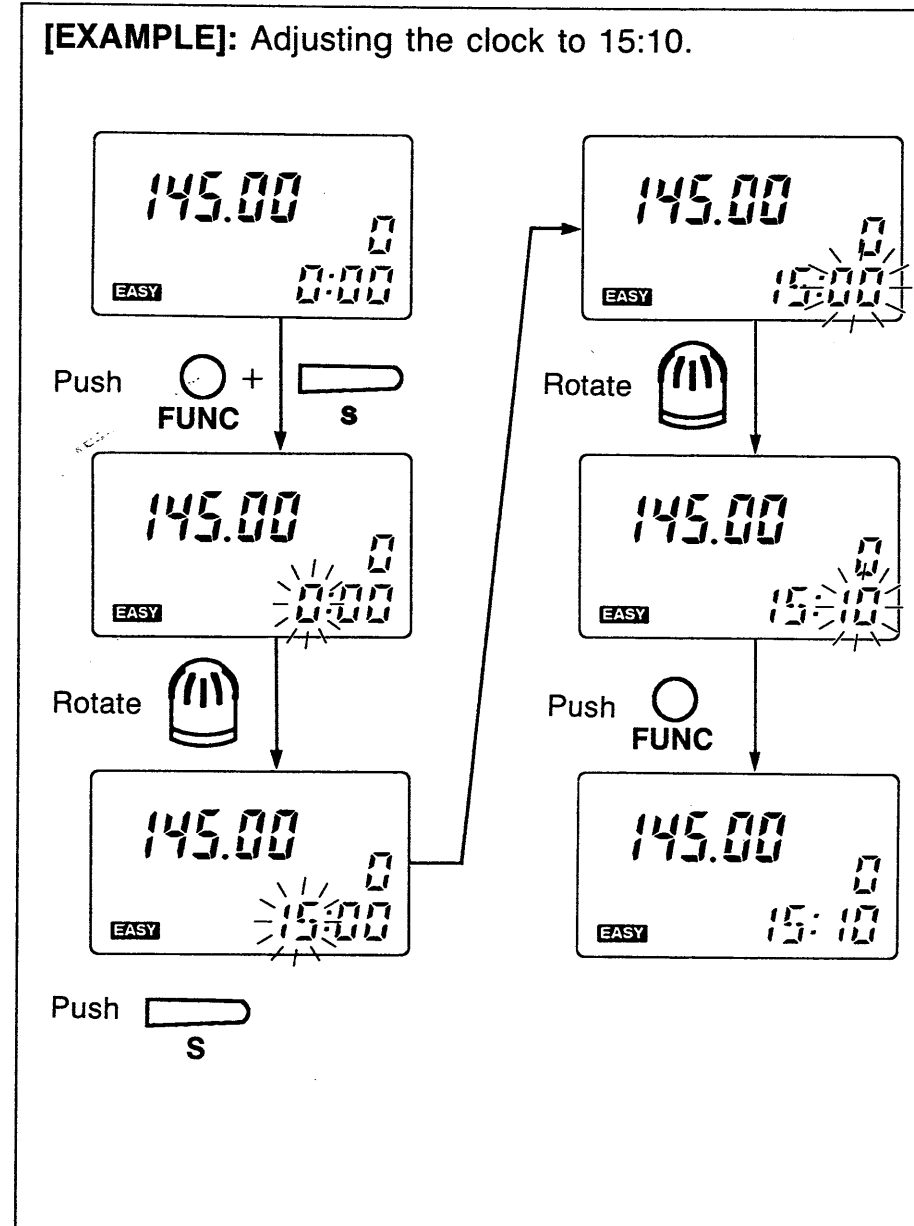

Easy mode and multi-function mode

This transceiver has an EASY mode and a MULTI-FUNCTION mode. The EASY mode has only a few functions for basic operation of the transceiver while the MULTI-FUNCTION mode has many functions for advanced operation.

To use the transceiver with a repeater: duplex ON/OFF, offset frequency, subaudible tone frequency, etc. must be set. However, these settings cannot be set in the EASY mode — you must set these settings in the MULTI-FUNCTION mode.

In the MULTI-FUNCTION mode, you can store the above settings and a frequency in a memory channel. Once all settings for repeater operation have been programmed in a memory channel, you can use the transceiver with a repeater in the EASY mode.

Except for repeater operation, this instruction manual only explains EASY mode operations. For MULTI-FUNCTION mode details, see the separate “Tech Talk.”

Settings for repeater use

To set the transceiver for repeater use, follow instructions **1**~**6**.

- If you lose your way while in the MULTI-FUNCTION mode, refer to “Tech Talk” to escape the condition, or reset the transceiver (p. ii) and then, start again from **1**.

1 Entering the MULTI-FUNCTION mode

- ① Push and hold [POWER] to turn power OFF.

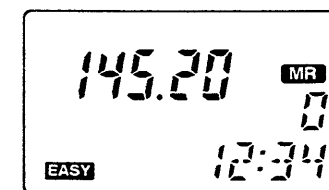

- Both VFO mode and MEMORY mode can be used.

2 Confirming AI type in the MULTI-FUNCTION mode

- ① Push and hold the [S] switch.

- ② Confirm that “ALL” appears instead of a frequency while pushing the [S] switch.

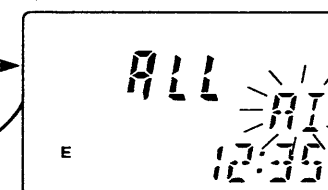
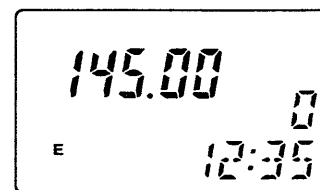

- ④ If you confirm “ALL,” advance to **3** on p. 17.

- ③ Release the [S] switch.

- “ALL” shows the all-function type AI is selected.

② While pushing and holding [V/M MW] and [LIGHT], push and hold [POWER] to turn power ON.

③ Select VFO mode if MEMORY mode has been selected.

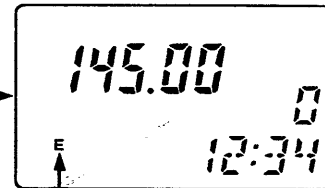
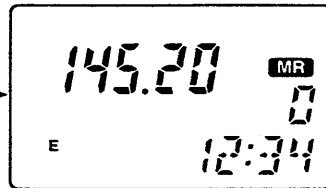
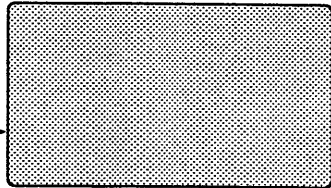

- The transceiver enters the MULTI-FUNCTION mode.
- "EASY" disappears.

- "E" or other letters may appear in the MULTI-FUNCTION mode.

If "SEL" or "auto" appears while pushing the [S] switch:

NOTE: There are 3 AI types, "ALL," "SEL" and "auto," in the MULTI-FUNCTION mode.

1) Push and hold [POWER] to turn power OFF.

2) While pushing and holding [S] and [V/M MW], push and hold [POWER] to turn power ON.

3) Rotate [DIAL] to select "ALL."

4) Push [PTT] to exit the AI type selection condition.

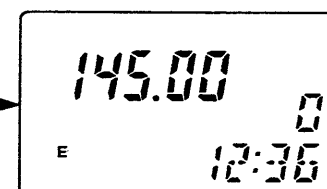
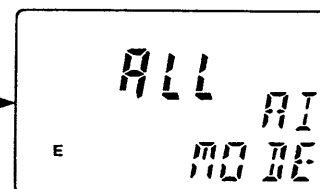
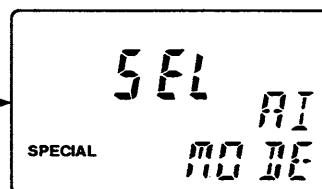
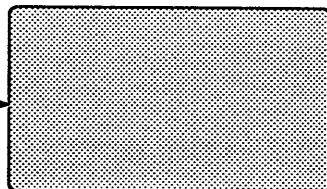
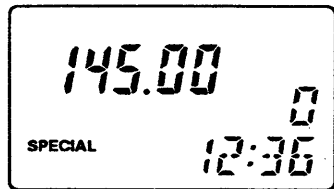

- The transceiver enters the AI type selection condition.

5 REPEATER OPERATION

3 Duplex and offset frequency setting

① While pushing the [S] switch, rotate [DIAL] until "DUP" appears.

② Release [S].

③ Push [S] once for the - DUP setting, or push [S] twice for the + DUP setting.

④ Push [FUNC] + [S].

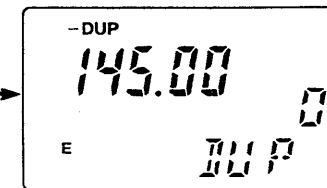
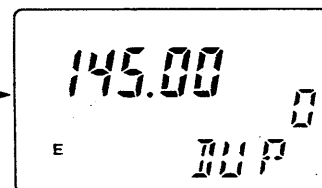
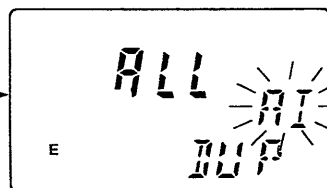
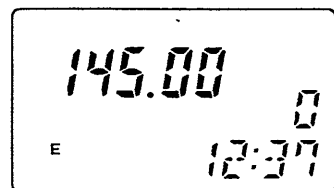

• If "ALL" and "AI" do not appear, push [PTT], then repeat from step ①.

• Normal repeater uses - DUP (minus shift) system.
• Pushing [S] selects the duplex direction in this sequence: - DUP → + DUP → simplex.

4 Subaudible tone frequency setting

(U.S.A. version only)

When a subaudible tone is not necessary to access a repeater, skip these steps and continue from 5.

① While pushing the [S] switch, rotate [DIAL] until "TONE" appears.

② Release [S].

③ Push [S].

④ Push [FUNC] + [S].

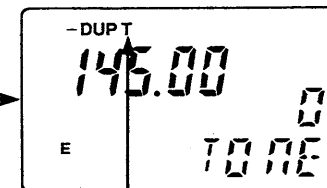
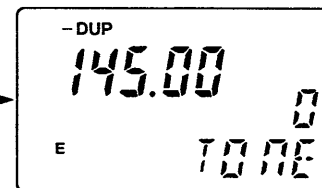
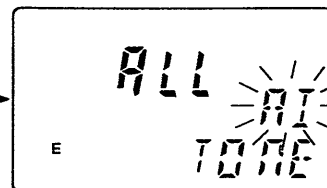
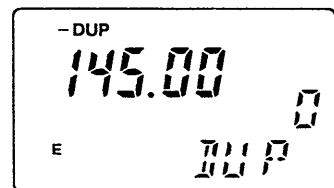

Except for the U.S.A. versions, an optional UT-72 TONE SQUELCH UNIT is required. If your transceiver does not include the UT-72, a subaudible tone cannot be set.

• "T" appears. If "T SQL ((•))" or "T SQL" is indicated, push [S] several times until only "T" is indicated.

⑤ Rotate [DIAL] to set the desired offset frequency.

⑥ Push [S] to return to the frequency display.

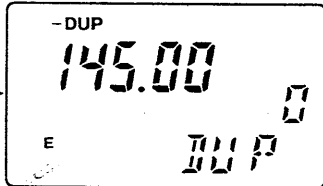
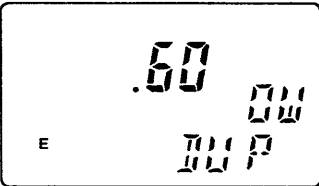
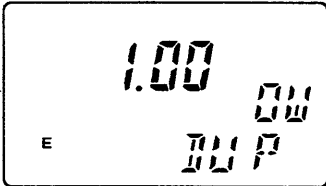

• "OW" and previously set offset frequency appear.

⑤ Rotate [DIAL] to select the required subaudible tone frequency.

⑥ Push [S] to return to the frequency display.

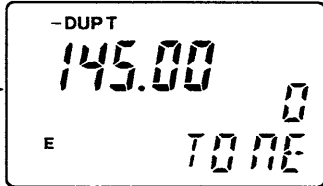
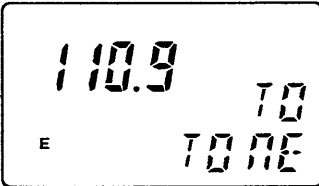
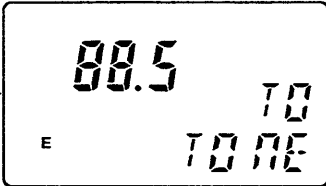

• "TO" and previously selected subaudible tone frequency appear.

5 REPEATER OPERATION

5 Programming all settings into a memory channel

① Push [V/M MW] to select MEMORY mode.

② Rotate [DIAL] to select the memory channel to be programmed. ("0" ~ "9")

③ Push [V/M MW] to return to VFO mode.

④ Rotate [DIAL] to set the repeater output frequency.

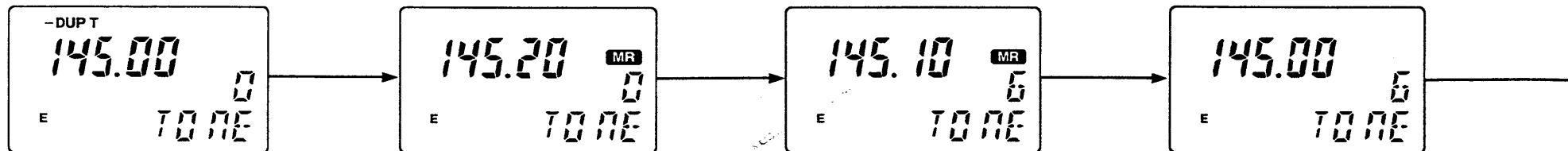

• In the MULTI-FUNCTION mode, 100 memory channels, "0" ~ "99," are available. However, when you return to the EASY mode, memory channels "10" ~ "99" cannot be used. Therefore, do not program into memory channels "10" ~ "99."

6 Returning to the EASY mode

① Push and hold [POWER] to turn power OFF.

② While pushing and holding [V/M MW] and [LIGHT], push and hold [POWER] to turn power ON.

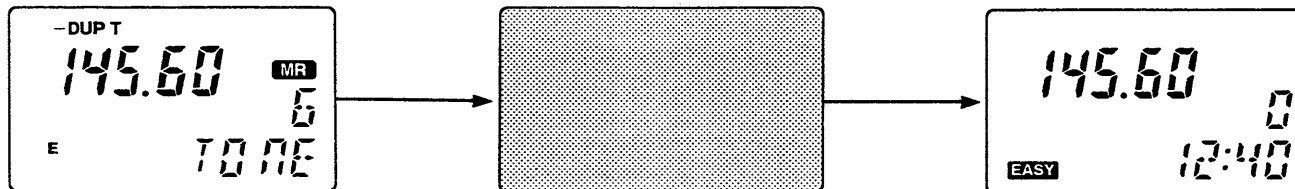

• The transceiver enters the EASY mode.
• "EASY" appears.

⑤ Push and hold [FUNC] + [V/M MW] to program the frequency and settings for a repeater.

⑥ To confirm, push [V/M MW].

For programming frequency and settings for other repeaters, repeat ④ and ⑤ (or ③, ④ and ⑤ when changing the offset frequency).

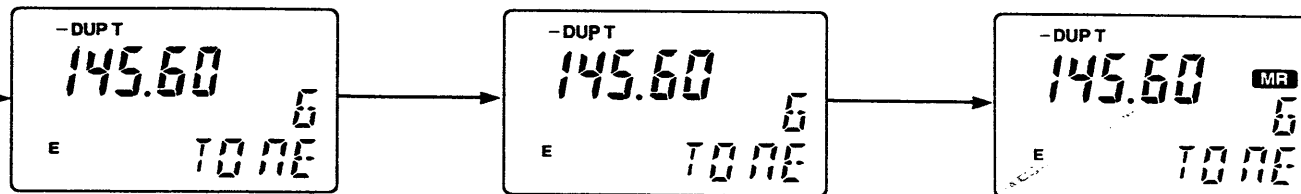

■ Repeater operation

- ① Select MEMORY mode if VFO mode has been selected.
- ② Rotate [DIAL] to select a memory channel which is programmed for repeater use.
 - “DUP” or “-DUP” appears.
- ③ Push and hold [PTT] to access the repeater.
 - When a 1750 Hz tone is necessary to access a European repeater, quickly push and release [PTT], then push and hold [PTT] a second time to generate the 1750 Hz tone before transmitting. Pushing [PTT] + [LIGHT] also generates the 1750 Hz tone. The IC-2iE (Europe and Italy versions) has 1750 Hz tone capability.

- When a DTMF tone is necessary to access a repeater, use the keypad on the optional HM-55 or HM-55A DTMF SPEAKER-MICROPHONE. This transceiver includes a DTMF encoder/decoder and 16 DTMF memories for storing DTMF codes. See “Tech Talk” to use the DTMF memory.

- ④ Release the [PTT] to receive.

Push and hold [MONI] to check whether the other station’s signal on the repeater input frequency can be directly received or not.

6

TROUBLESHOOTING

If your transceiver seems to be malfunctioning, please check the following points before sending it to a service center.

PROBLEM	POSSIBLE CAUSE	SOLUTION	REF.
<ul style="list-style-type: none"> No power comes on. 	<ul style="list-style-type: none"> The battery is exhausted. (A slight current flows in the circuits even when the power is OFF.) Poor plug connection to the external DC power cable. 	<ul style="list-style-type: none"> Charge the battery pack or place new dry cell batteries in the battery case. (Remove the battery pack if you will not be using the transceiver for a long time.) Check the connector or remove and replace the cable. 	<p>p. i</p> <p>—</p>
<ul style="list-style-type: none"> Power cannot be turned OFF. 	<ul style="list-style-type: none"> The battery became exhausted during operation. 	<ul style="list-style-type: none"> Charge the battery pack or place new dry cell batteries in the battery case, then, turn the power OFF. 	<p>p. i</p>
<ul style="list-style-type: none"> No sound comes from the speaker. 	<ul style="list-style-type: none"> [SQL] is turned too far clockwise. An external speaker or earphone is connected. 	<ul style="list-style-type: none"> Rotate [SQL] counterclockwise. Unplug the speaker or earphone. 	<p>p. 10</p> <p>—</p>
<ul style="list-style-type: none"> Transmitting is impossible. 	<ul style="list-style-type: none"> The battery is exhausted. 	<ul style="list-style-type: none"> Charge the battery pack or place new dry cell batteries in the battery case. 	<p>p. i</p>
<ul style="list-style-type: none"> Frequency cannot be set. 	<ul style="list-style-type: none"> MEMORY mode is selected. The lock function is activated. 	<ul style="list-style-type: none"> Push [V/M MW] to select VFO mode. Push [FUNC] + [LIGHT] to deactivate the lock function. 	<p>p. 8</p> <p>p. 9</p>
<ul style="list-style-type: none"> Scan cannot be activated. 	<ul style="list-style-type: none"> The squelch is open. 	<ul style="list-style-type: none"> Rotate the [SQL] control clockwise until noise disappears. 	<p>p. 13</p>
<ul style="list-style-type: none"> The contents of the memories are erased. 	<ul style="list-style-type: none"> The internal memory backup battery is exhausted because no charging has been performed for a long time. 	<ul style="list-style-type: none"> Charge the battery pack or place new dry cell batteries in the battery case. The memory backup battery is simultaneously charged. 	<p>p. i</p>

SPECIFICATIONS

7

GENERAL				
		IC-2iA · IC-2iE	IC-4iA · IC-4iE	
Frequency coverage (IC-2iA/E guaranteed range: 144 ~ 148 MHz)	U.S.A.	144 ~ 148 MHz (Tx) 138 ~ 174 MHz (Rx)	440 ~ 450 MHz	
	Australia	144 ~ 148 MHz	430 ~ 440 MHz	
	Asia	144 ~ 148 MHz (Tx) 138 ~ 174 MHz (Rx)	430 ~ 440 MHz	
	Europe	144 ~ 146 MHz	430 ~ 440 MHz	
	Italy	144 ~ 148 MHz (Tx) 138 ~ 174 MHz (Rx)	Not applicable	
	Taiwan	145 ~ 146 MHz	430 ~ 432 MHz	
Number of memory channels		10 plus 2 scan edge channels		
Default tuning step	U.S.A., and Asia	5 kHz	25 kHz	
	Others	25 kHz		
Usable temperature range		-10°C ~ +60°C; +14°F ~ +140°F		
Usable battery packs		BP-121 ~ BP-124 BATTERY PACKS, BP-120 BATTERY CASE with six R6(AA) size dry cell or NiCd batteries		
External DC power supply		6 ~ 16 V DC (negative ground)		
Current drain (typical; at 13.8 V)	Transmit	High	1.4 A	1.4 A
		Low 1	100 mA	100 mA
	Receive	Rated audio output	150 mA	160 mA
		Power saved	16 mA (average)	18 mA (average)
Frequency stability		± 10 ppm (at 0°C ~ +50°C; +32°F ~ +122°F)		
Dimensions (projections not included)	with BP-121	58(W) × 91(H) × 30(D) mm 2.3(W) × 3.6(H) × 1.2(D) in		
	with BP-120	58(W) × 114(H) × 30(D) mm 2.3(W) × 4.5(H) × 1.2(D) in		
Weight	with BP-121	260 g; 9.1 oz		
	with BP-120 and 6 dry cell batteries	320 g; 11.3 oz (varies depending on the battery type)		

TRANSMITTER			
		IC-2iA · IC-2iE	IC-4iA · IC-4iE
Output power* (approx.; at 13.8 V)	High	5 W	
	Low-3	2.5 W	
	Low-2	500 mW	
	Low-1	20 mW	
Modulation system		Variable reactance frequency modulation	
Spurious emissions*	High	Less than -60 dB	
	Low-1	Less than -40 dB	
Max. frequency deviation*		± 5.0 kHz	
Microphone impedance		2 kΩ	

RECEIVER			
		IC-2iA · IC-2iE	IC-4iA · IC-4iE
Rreceive system		Double-conversion superheterodyne	
Intermediate frequencies	1st	30.85 MHz	35.80 MHz
	2nd	455 kHz	
Sensitivity*		Less than 0.18 μV for 12 dB SINAD	
Selectivity		More than 15 kHz/-6 dB Less than 30 kHz/-60 dB	
Squelch sensitivity		Less than 0.16 μV at threshold	
Spurious response rejection ratio*		More than 60 dB	
Audio output power* (at 13.8 V)		More than 200 mW at 10% distortion with an 8 Ω load	
Audio output impedance		8 Ω	

*Specifications guaranteed at a transceiver temperature of 25°C (+77°F).

All stated specifications are subject to change without notice or obligation.

Count on us!



A-5212S-1EX
Printed in Japan
Copyright © 1992 by Icom Inc.

Icom Inc.
6-9-16, Kamihigashi, Hirano-ku, Osaka 547, Japan