

ICOM

INSTRUCTION MANUAL

HF TRANSCEIVER

IC-737A



Icom Inc.

IMPORTANT

READ THIS INSTRUCTION MANUAL CAREFULLY before attempting to operate the transceiver.

SAVE THIS INSTRUCTION MANUAL — This instruction manual contains important safety and operating instructions for the **IC-737A**:

PRECAUTIONS

NEVER apply AC or more than 16 V DC to the [DC13.8V] socket on the transceiver rear panel. This could cause a fire or ruin the transceiver.

NEVER allow children to touch the transceiver.

NEVER let metal, wire or other objects touch any internal part or connectors on the rear panel of the transceiver. This will cause electric shock.

NEVER expose the transceiver to rain, snow or any liquids.

AVOID using or placing the transceiver in areas with temperatures below -10°C ($+14^{\circ}\text{F}$) or above $+60^{\circ}\text{C}$ ($+140^{\circ}\text{F}$).

AVOID placing the transceiver in excessively dusty environments or in direct sunlight.

AVOID placing the transceiver against walls or putting anything on top of the transceiver. This will obstruct heat dissipation.

In any mobile operation, **DO NOT** operate the transceiver without running the vehicle's engine. The vehicle's battery will quickly run out if the transceiver power is ON while your vehicle's engine is OFF.

Make sure the transceiver power is OFF before starting the vehicle. This will avoid possible damage to the transceiver by ignition voltage spikes.

In maritime mobile operation, keep the transceiver and microphone as far away as possible from the magnetic navigation compass to prevent erroneous indications.

BE CAREFUL! The heatsink will become hot when operating the transceiver continuously for long periods.

EXPLICIT DEFINITIONS

WORD	DEFINITION
WARNING	Personal injury, fire hazard or electric shock may occur.
CAUTION	Equipment damage may occur.
NOTE	If disregarded, inconvenience only. No personal injury, risk of fire or electric shock.

The explicit definitions described at left apply to this instruction manual.

UNPACKING

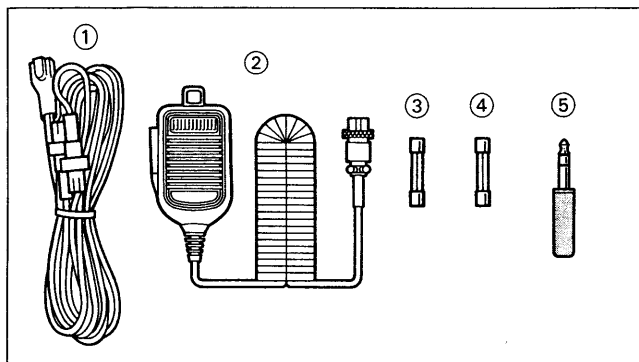

Accessories included with the IC-737A:	Qty.
① DC power cable (OPC-025A)	1
② Hand microphone (HM-36)	1
③ Spare fuse (20 A)	1
④ Spare fuse (4 A)	1
⑤ CW keyer plug	1

1 PANEL DESCRIPTION

■ Front panel

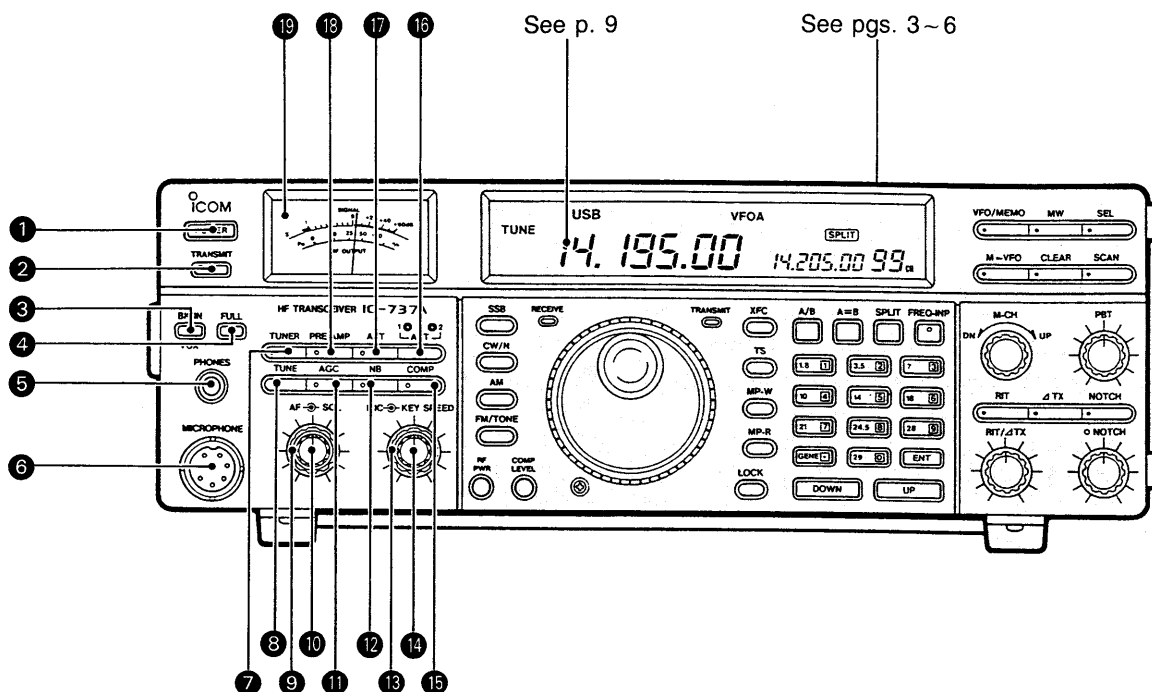

- 1 POWER SWITCH [POWER]** (pgs. 23, 25)
Turns power ON and OFF.



- 2 TRANSMIT SWITCH [TRANSMIT]** (p. 25)
Selects transmitting or receiving.

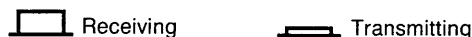

- 3 BREAK-IN/VOX SWITCH [BK-IN VOX]**
(pgs. 25, 30)

- For CW operation: Turns the break-in function ON and OFF.
- For voice operation: Turns the VOX (voice-operated relay) function ON and OFF.



FUNCTION

- The **CW break-in function** starts transmitting while keying. Returns to receiving you quit keying.
- The **VOX function** starts transmitting when you speak into the microphone. Returns to receiving when you quit speaking.

- 4 FULL BREAK-IN SWITCH [FULL]** (p. 25)

Selects full break-in (QSK) or semi break-in operation for the break-in function



See pgs. 3~6

See p. 9

FUNCTION

- The **full break-in (QSK)** allows you to receive signals between transmitted keying pulses.
- The **semi break-in** allows you to receive signals after the transmit-to-receive switching delay time elapses from the end of keying. See 54 for the delay time.

- 5 HEADPHONE JACK [PHONES]** (p. 23)

Accepts headphones with 4~16 Ω impedance.

- When headphones are connected, no receive audio comes from the speaker.

- 6 MICROPHONE CONNECTOR [MICROPHONE]**

Accepts the supplied microphone.

- An optional desktop microphone can be used.
- See p. 10 for microphone connector information.

- 7 ANTENNA TUNER SWITCH [TUNER]** (pgs. 35, 36)

Turns the antenna tuner ON or OFF (bypass).

- An optional AH-3 HF AUTOMATIC ANTENNA TUNER can also be controlled.

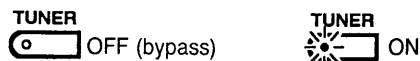

- 8 TUNING SWITCH [TUNE]** (pgs. 35, 36)

Tunes the connected antenna manually.

- 9 **SQUELCH CONTROL [SQL]**(outer control) (p. 23)
Adjusts the squelch threshold level.

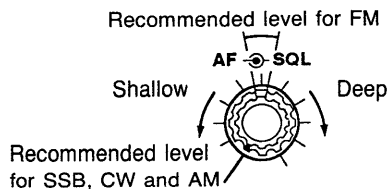

FUNCTION

The **squelch** removes noise output from the speaker (closed condition) when no signal is received. The squelch is particularly effective for FM. It is also available for other modes.

SETTING PROCEDURE

Squelch setting: When operating in FM, first rotate the control fully counterclockwise. Then, rotate the control clockwise to the point where the noise just disappears. This is the best position. The squelch does not open for weak signals when it is set too deep.

- 10 **AF GAIN CONTROL [AF]**(inner control) (p. 23)
Varies the audio output level from the speaker.

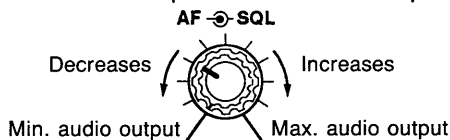

- 11 **AGC SWITCH [AGC]** (p. 23)
Changes the time constant of the AGC circuit.

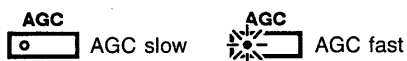

FUNCTION

The **AGC** controls receiver gain to produce a constant audio output level even when the received signal strength is varied by fading, etc. Use AGC slow for normal operation and select AGC fast depending on the receiving condition. AGC does not function in FM mode.

- 12 **NOISE BLANKER SWITCH [NB]** (p. 23)
Turns the noise blanker ON and OFF.



FUNCTION

The **noise blanker** reduces pulse-type noise such as that generated by automobile ignition systems. This function is not available for AM and FM, or non-pulse-type noise.

- 13 **ELECTRONIC CW KEYER SPEED CONTROL [KEY SPEED]**(outer control) (p. 25)
Adjusts the internal electronic CW keyer's speed.

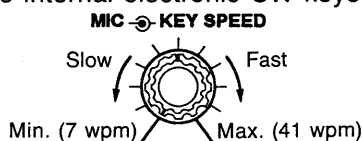

- 14 **MIC GAIN CONTROL [MIC]**(inner control) (p. 25)
Adjusts microphone input gain.

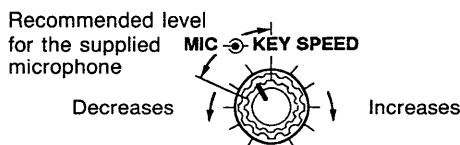

- 15 **SPEECH COMPRESSOR SWITCH [COMP]** (p. 25)
Turns the speech compressor ON and OFF.

• The compressing level must be adjusted properly. See 21 for details.



FUNCTION

The **speech compressor** compresses the transmitter audio input to increase the average audio output level. Therefore talk power is increased. This function is effective for long distance communication or when propagation conditions are poor.

- 16 **ANTENNA SWITCH [ANT]** (pgs. 32, 34)
Selects antenna 1 or 2.

• Initially, to prevent non-load transmission, this switch does not function. See p. 32.

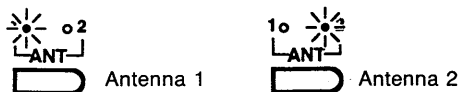

- 17 **ATTENUATOR SWITCH [ATT]** (p. 23)
Turns the 20 dB attenuator ON and OFF.



FUNCTION

The **attenuator** prevents the desired signal from distorting when very strong signals are near the desired frequency or when very strong electric fields from a broadcasting station are near your location.

- 18 **PREAMP SWITCH [PRE AMP]** (p. 23)
Turns the preamp ON and OFF.



FUNCTION

The **preamp** amplifies received signals in the front end circuit to improve the S/N ratio and sensitivity. Turn this function ON when receiving weak signals.

- 19 **S/R F METER** (pgs. 23, 25)
Shows the signal strength while receiving. Shows the relative output power while transmitting.

1 PANEL DESCRIPTION

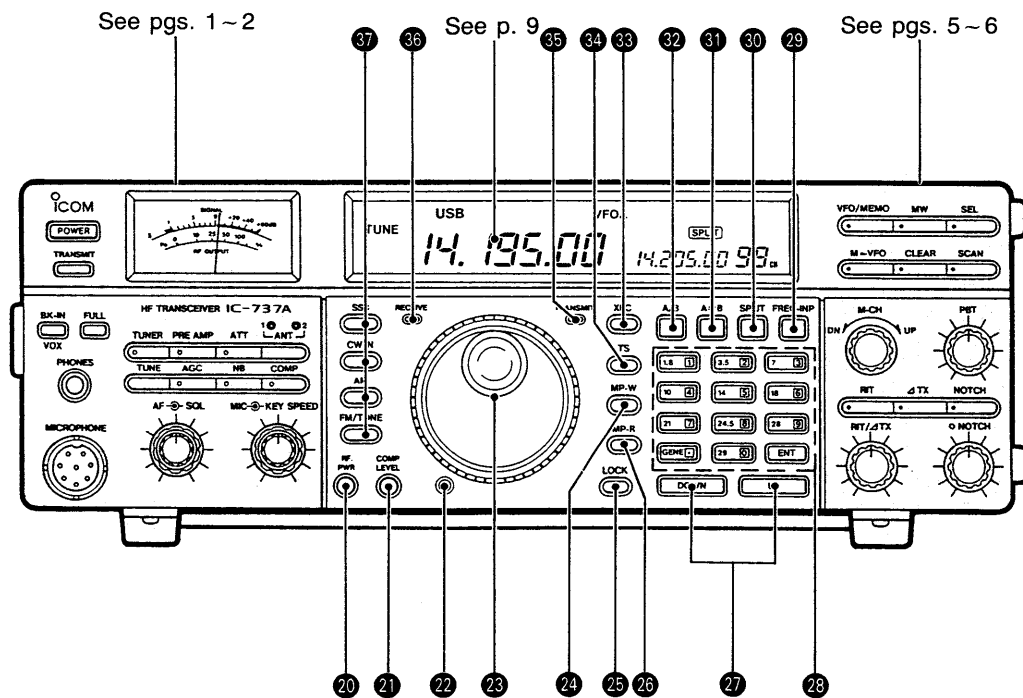

20 RF POWER CONTROL [RF PWR] (p. 25)

Continuously varies the RF output power from minimum to maximum.

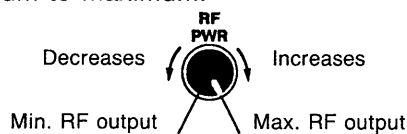

- Maximum and minimum output powers

MODE	Max. RF output	Min. RF output
SSB	100 W	10 W
CW	100 W	10 W
FM	100 W	10 W
AM	40 W	10 W

21 SPEECH COMPRESSION LEVEL CONTROL [COMP LEVEL] (p. 25)

Adjusts the compression level.

- This control is available only when the speech compressor is ON.

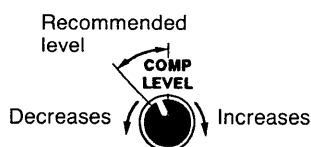

22 BRAKE ADJUSTMENT SCREW (p. 48)

Adjusts the main dial tension.



23 MAIN DIAL (p. 21)

Changes the displayed frequency.

24 MEMO PAD-WRITE SWITCH [MP-W] (p. 27)

Programs the displayed frequency and operating mode into a memo pad.

- The 5 most recent entries remain in memo pads.
- The memo pad capacity can be expanded from 5 to 10 in the SET mode for your convenience. (p. 32)

25 DIAL LOCK SWITCH [LOCK] (pgs. 23, 25)

Turns the dial lock function ON and OFF.

- The dial lock function electronically locks the main dial.
- "LOCK" appears on the function display while the function is ON.

26 MEMO PAD-READ SWITCH [MP-R] (p. 27)

Each push calls up a frequency and operating mode in a memo pad. The 5 most recently programmed frequencies and operating modes can be recalled, starting from the most recent.

- The memo pad capacity can be expanded from 5 to 10 in the SET mode for your convenience. (p. 32)

27 UP/DOWN TUNING SWITCHES [UP]/[DOWN]

(p. 22)
Changes the displayed frequency up or down in programmed steps (1 kHz ~ 1 MHz).

28 KEYPAD (pgs. 21, 22)

- Pushing a key selects the operating band.
 - [GENE] selects the general coverage band.
- Pushing the same key twice calls up another stacking frequency in the band.
 - Icom's DBSR (Double Band Stacking Register) memorizes 2 frequencies in each band. (p. 21)
- After pushing [FREQ-INP], enters your desired frequency. Pushing [ENT] is necessary at the end. (e.g. to enter 14.195 MHz, push [FREQ-INP][1][4][.] [1][9][5][ENT].)

29 FREQUENCY-INPUT SWITCH [FREQ-INP]

(p. 22)
Enables the keyboard to input frequency.

- The red indicator on the switch lights when pushed. While the red indicator lights, the keyboard can be used to enter a frequency directly.
- To cancel the frequency input, push this switch again. The red indicator is turned OFF.

30 SPLIT SWITCH [SPLIT] (p. 28)

- Turns the split frequency function ON and OFF when pushed momentarily.
 - Transmit frequency and "SPUR" are indicated when the function is ON.
- Turns the split frequency function ON and equalizes the transmit frequency to the receive frequency when pushed for 1 sec.

31 VFO EQUALIZATION SWITCH [A = B] (p. 28)

Equalizes the frequency and operating mode of the two VFOs when pushed for 1 sec.

- The rear (undisplayed) VFO frequency and operating mode are equalized to the front (displayed) VFO frequency and operating mode.
- This switch can be used even when the split frequency function is ON. In this case, the transmit frequency and operating mode are equalized to the receive frequency and operating mode.

32 VFO SWITCH [A/B] (p. 19)

- Toggles between VFO A and VFO B in the VFO mode.
- Toggles between transmission VFO and reception VFO when the split frequency function is ON.
- Toggles between the transmit frequency and operating mode and the receive frequency and operating mode in the split memory channels (memory channels 90 ~ 99).

33 TRANSMIT FREQUENCY CHECK SWITCH [XFC]

(p. 28)
Monitors the transmit frequency while pushing this switch when the split frequency function is ON.

- While pushing this switch, the transmit frequency can be changed with the dial, the [MP-R] switch, or the [UP]/[DOWN] switches.

34 QUICK TUNING SWITCH [TS] (p. 22)

Turns the quick tuning step ON and OFF.

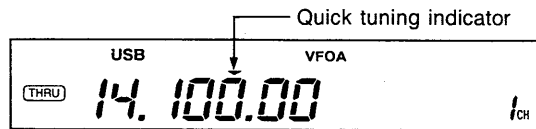

- While this indicator is displayed, the main dial changes the displayed frequency in programmed kHz steps.

35 TRANSMIT/ALC INDICATOR [TRANSMIT]

(p. 25)
Lights while transmitting.

- While ALC is activated, the LED brightness increases.

FUNCTION





The **ALC circuit** automatically limits RF output power by controlling the input level of the RF power amplifier. This prevents transmitting distorted signals when the input signal level exceeds the allowable level.

36 RECEIVE INDICATOR [RECEIVE] (p. 23)

Lights during receiving when the squelch is open.

37 MODE SWITCHES (pgs. 18, 21)

Select the desired operating mode.

- SSB**  selects USB and LSB alternately.
- CW/N**  selects "normal CW" and "CW-Narrow*" alternately.
*An optional CW filter is necessary.
- AM**  selects AM.
- FM/TONE**  selects FM and FM with a subaudible tone alternately.
 - To transmit a subaudible tone, an optional UT-30 PROGRAMMABLE TONE ENCODER UNIT is required.
 - "FM-T" shows the subaudible tone encoder is ON.

FUNCTION

Subaudible tones are used to access a repeater which requires such tones. The UT-30 offers you 38 kinds of subaudible tone frequencies to match your needs.

1 PANEL DESCRIPTION

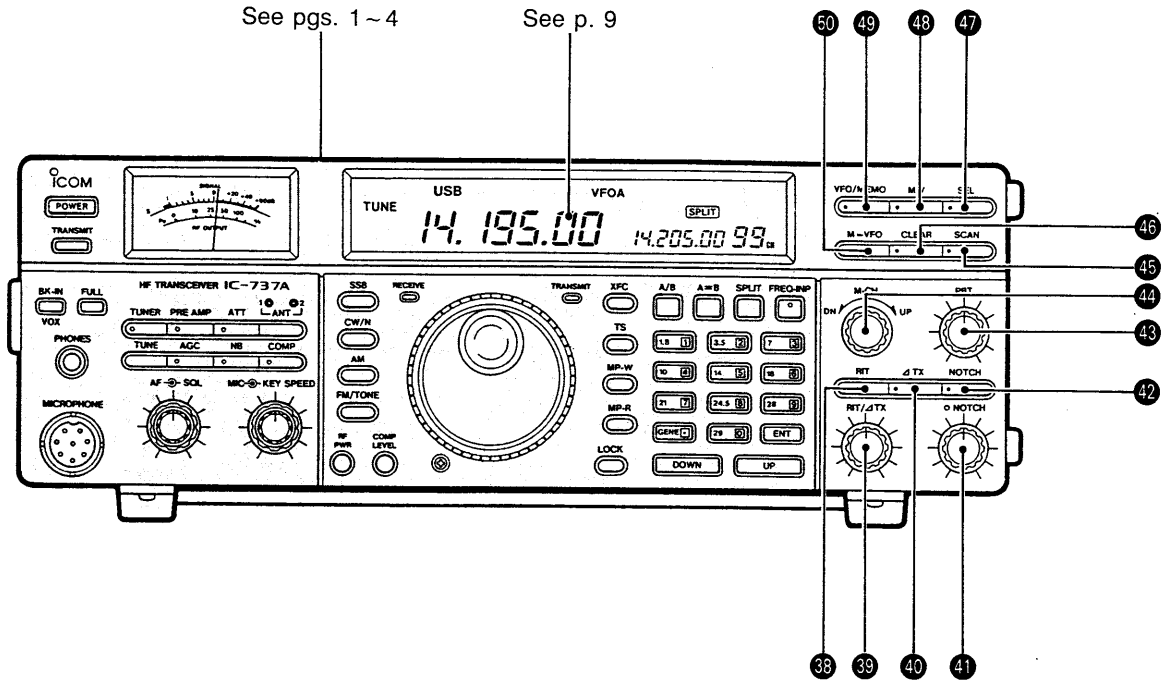

38 RIT SWITCH [RIT] (p. 29)

Turns the RIT function ON and OFF.

- "RIT" is indicated when the function is ON.
- Use the [RIT/ΔTX] control to vary the RIT frequency.
- The RIT function can be turned ON even when the ΔTX function is ON.
- The max. RIT range can be expanded from ± 1.25 kHz to ± 2.5 kHz in the SET mode. (p.31)

FUNCTION

The RIT (Receiver Incremental Tuning) shifts the receive frequency up to ± 1.25 kHz (or ± 2.5 kHz) in 10 Hz steps without shifting the transmit frequency.

This is useful for fine tuning stations which called you on an off-frequency or when you prefer to listen to slightly different-sounding voice characteristics, etc.

39 RIT/ΔTX CONTROL [RIT/ΔTX] (p. 29)

Shifts the receive and/or transmit frequency while the RIT and/or ΔTX functions are ON.

- Rotate the control clockwise to increase the receive/transmit frequency, or rotate the control counterclockwise to decrease the receive/transmit frequency.

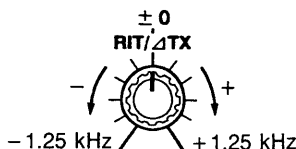

40 ΔTX SWITCH [ΔTX] (p. 29)

Turns the ΔTX function ON and OFF.

- "ΔTX" is indicated when the function is ON.
- Use the [RIT/ΔTX] control to vary the ΔTX frequency.
- The ΔTX function can be turned ON even when the RIT function is ON.
- The max. ΔTX range can be expanded from ± 1.25 kHz to ± 2.5 kHz in the SET mode. (p. 31)

FUNCTION

The ΔTX shifts the transmit frequency up to ± 1.25 kHz (or ± 2.5 kHz) in 10 Hz steps without shifting the receive frequency. This is useful for simple split frequency operation on CW, etc.

41 NOTCH CONTROL [NOTCH] (p. 30)

Adjusts the notch filtering frequency while the notch function is ON.

- Rotate the control clockwise or counterclockwise to shift the center of notch filtering frequency.

[Simplified example of the notch function]

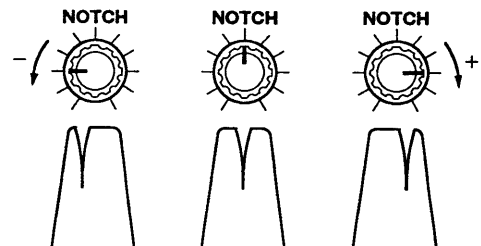

42 NOTCH SWITCH [NOTCH] (p. 30)

Turns the notch function ON and OFF.

- The red indicator for the notch lights when the function is ON.
- Use the notch control to vary the filtering frequency.



FUNCTION

The **notch** function eliminates unwanted CW or AM carrier tones while preserving the desired signal's audio response. The filtering frequency must be adjusted to effectively eliminate an unwanted tone. The AF-type notch is adopted in the IC-737A.

43 PASSBAND TUNING CONTROL [PBT] (p. 30)

Adjusts the receiver's "passband width" of the IF filter.

- Set to the center position when not in use.

FUNCTION

The **PBT** function electronically narrows the IF passband width to reject interference. The PBT is especially effective in SSB operation and not available in FM operation.

[Simplified example of the PBT function]

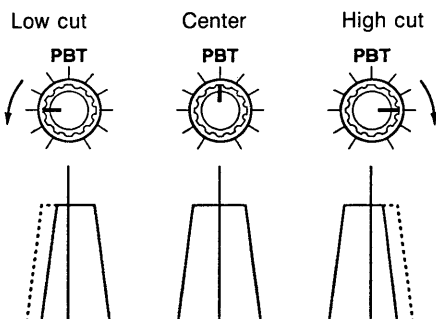

44 MEMORY CHANNEL SELECTOR [M-CH] (p. 37)

Selects a memory channel both in the VFO mode and the memory mode.

45 SCAN SWITCH [SCAN] (p. 44)

Starts and stops a scan.

- In the VFO mode, starts and stops programmed scan.
- In the memory mode, starts and stops memory scan.

46 CLEAR SWITCH [CLEAR] (p. 39)

Clears memory channel contents when pushed for 1 sec. in the memory mode.

- The channel will be a blank channel and "BLANK" appears.
- This switch does not function in the VFO mode.

47 SELECT SWITCH [SEL] (p. 43)

- In the memory mode, designates or cancels the displayed memory channel as a selected memory channel for selected memory scan when pushed momentarily.

- "SELECT" appears when the displayed channel is a selected memory channel.

- Cancels all selected memory channels when pushed for 1 sec.

- "SELECT" disappears from all selected memory channels.

48 MEMORY WRITE SWITCH [MW]

(pgs. 38, 40, 42)

Stores the displayed frequency and operating mode into the displayed memory channel when pushed for 1sec.

- This switch is available both in the VFO mode and memory mode.

49 VFO/MEMORY SWITCH [VFO/MEMO] (p. 19)

Toggles VFO mode and the memory mode.

50 MEMORY TRANSFER SWITCH [M►VFO]

(pgs. 39, 41)

Transfers the frequency and operating mode in a memory channel to a VFO when pushed for 1 sec.

- This switch is available both in the VFO mode and memory mode.

1 PANEL DESCRIPTION

■ Rear panel

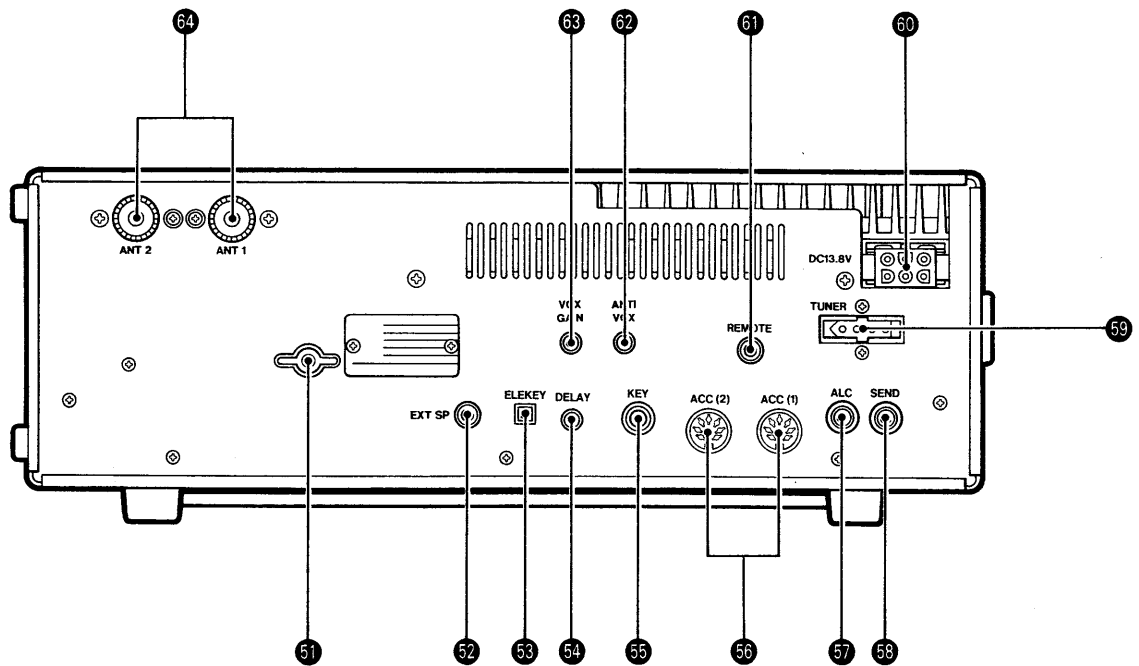

51 GROUND TERMINAL (p. 11)

Connect this terminal to a ground to prevent electrical shocks, TVI, BCI and other problems.

52 EXTERNAL SPEAKER JACK [EXT SP] (p. 12)

Accepts a 4 ~ 16 Ω speaker.

53 ELECTRONIC KEYSwitch [ELEKEY]

Turns the internal electronic keyer ON and OFF.



When not using the internal keyer.

For straight key, semi-automatic keyer, external electronic keyer, etc.

When using the internal keyer.

Connect a paddle to the [KEY] jack.

If you use an external electronic keyer, make sure the voltage retained by the keyer is less than 0.4 V when the key is ON.

54 DELAY TIME CONTROL [DELAY]

(pgs. 1, 26, 30)

Adjusts the transmit-to-receive switching delay time for CW semi break-in or VOX operation.



- Set delay time depending on the keying speed or your preference.

55 CW KEY JACK [KEY] (p. 12)

Accepts a keyer or a paddle with the supplied CW keyer plug.

When connecting a keyer

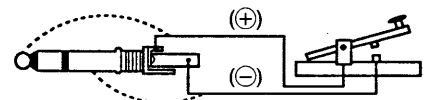

When connecting a paddle

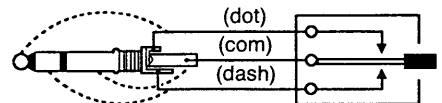

56 ACCESSORY SOCKETS [ACC(1)], [ACC(2)]

Enable connection to external equipment such as a linear amplifier, an automatic antenna selector/tuner, TNC for data communications.

- See the page at right for socket information.

57 ALC INPUT JACK [ALC] (p. 14)

Connects to the ALC output jack of a non-Icom linear amplifier.

- See p. 4 for the ALC function.

58 SEND CONTROL JACK [SEND] (p. 14)

Goes to ground while transmitting to control external equipment such as a linear amplifier.

59 AH-3 CONTROL SOCKET [TUNER] (p. 15)

Accepts the control cable from an optional AH-3 HF AUTOMATIC ANTENNA TUNER.

- 60 **DC POWER SOCKET [DC13.8V]** (p. 13)
Accepts 13.8 V DC through the supplied DC power cable.

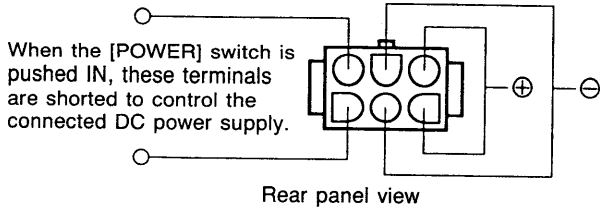

- 61 **CI-V REMOTE CONTROL JACK [REMOTE]** (p. 34)
Designed for use with a personal computer for remote operation of transceiver functions.
- 62 **ANTI VOX CONTROL [ANTI VOX]** (p. 30)
Adjusts anti VOX level to prevent the receive audio activates the VOX.

- 63 **VOX GAIN CONTROL [VOX GAIN]** (p. 30)
Adjusts the VOX sensitivity.

- 64 **ANTENNA CONNECTORS [ANT 1], [ANT 2]** (p. 12)
Accepts a 50 Ω antenna with a PL-259 plug to each connector.
 - When using only one antenna: Be sure to connect the antenna to the [ANT 1] connector.
 - When using two antennas: Remove the connector cover from the [ANT 2] connector and connect the antennas to the connectors.

CAUTION: DO NOT transmit when only one antenna is connected to the [ANT 2] connector and the [ANT 1] connector is selected from the [ANT] switch. The transceiver may be damaged.

TECHNICAL INFORMATION

Rear panel view

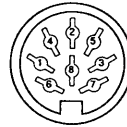

ACC(1) SOCKET



ACC(2) SOCKET

ACC(1) SOCKET

PIN NO.	PIN NAME	DESCRIPTION	SPECIFICATIONS
1	NC	No connection.	—
2	GND	Connects to ground.	Connected in parallel with ACC(2) pin 2.
3	SEND	Input/output pin. Goes to ground when transmitting. When grounded, transmits.	Ground level : -0.5~0.8 V Input current : Less than 20 mA Connected in parallel with ACC(2) pin 3.
4	MOD	Modulator input. Connects to a modulator.	Input impedance : 10 kΩ Input level : Approx. 100 mV rms.
5	AF	AF detector output. Fixed, regardless of [AF] position.	Output impedance : 4.7 kΩ Output level : 100~350 mV rms
6	SQLS	Squelch output. Goes to ground when squelch opens.	SQL open : Less than 0.3 V, 5 mA SQL closed : More than 6.0 V, 100 μA
7	13.8 V	13.8 V output when power is ON.	Output current : Max. 1 A Connected in parallel with ACC(2) pin 7.
8	ALC	ALC voltage input.	Control voltage : -4~0 V Input voltage : More than 10 kΩ Connected in parallel with ACC(2) pin 5.

ACC(2) SOCKET

PIN NO.	PIN NAME	DESCRIPTION	SPECIFICATIONS
1	8 V	Regulated 8 V output.	Output voltage : 8 V ± 0.3 V Output current : Less than 10 mA
2	GND		Same as ACC(1) pin 2.
3	SEND		Same as ACC(1) pin 3.
4	BAND	Band voltage output. (Varies with amateur band)	Output voltage : 0~8.0 V
5	ALC		Same as ACC(1) pin 8.
6	NC	No connection.	—
7	13.8 V		Same as ACC(1) pin 7.

1 PANEL DESCRIPTION

■ Function display

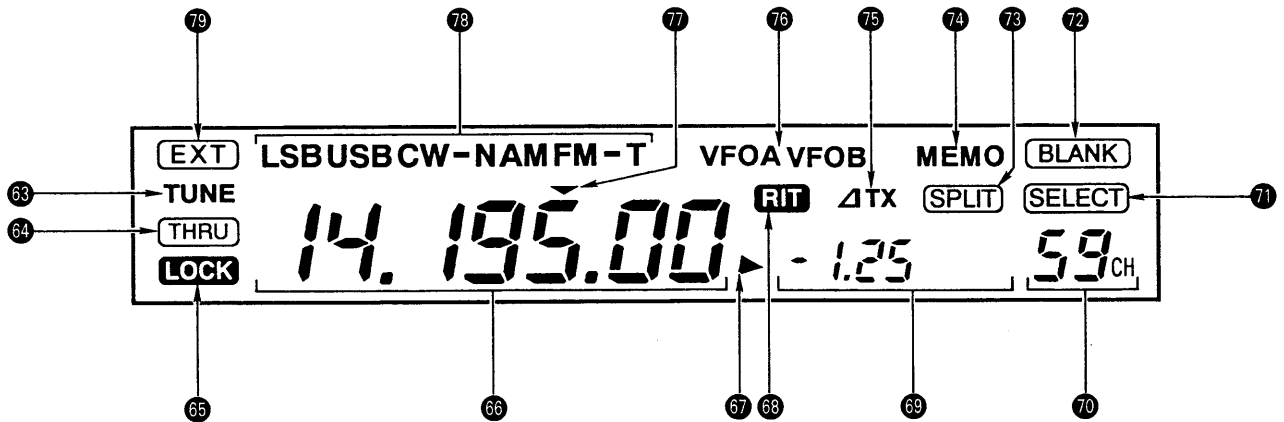

- 63 TUNING INDICATOR**
Shows that the antenna tuner is ON.
 - Appears when the antenna tuner is ON.
 - Blinks when the antenna is being tuned.
- 64 THROUGH INDICATOR**
Shows that the antenna tuner is bypassed.
 - Appears when the antenna tuner is manually bypassed or when the tuner cannot match the connected antenna.
- 65 DIAL LOCK INDICATOR**
Shows that the dial lock function is activated.
- 66 FREQUENCY READOUT**
Shows the operating frequency.
- 67 SUB VFO CONTROL INDICATOR**
Shows that the main dial, mode switches, keypad, etc. control the sub VFO (for transmitting on the split frequency) setting.
 - Appears when the split frequency function is ON and [XFC] is pushed or when transmitting.
- 68 RIT INDICATOR**
Shows that the RIT function is ON.
- 69 RIT/ΔTX FREQUENCY READOUT**
 - Shows the RIT and/or ΔTX variable frequency when operating in simplex.
 - When the split function is ON, the sub VFO's frequency indication has priority.
 - Shows the sub VFO's frequency for split frequency operation.
 - Appears when the split frequency function is ON or a programmed split memory channel is selected.
- 70 MEMORY CHANNEL NUMBER READOUT**
Shows the selected memory channel number.
- 71 SELECT INDICATOR**
Shows that the displayed memory channel is designated as a selected memory channel.
- 72 BLANK INDICATOR**
Shows that the displayed memory channel is a blank channel (and that it has not been programmed).
 - This indicator appears even in the VFO mode.
- 73 SPLIT INDICATOR**
Shows that split frequency function is activated.
 - Also appears when a programmed split memory channel is selected.
- 74 MEMORY INDICATOR**
Shows that the memory mode is selected.
- 75 ΔTX INDICATOR**
Shows that the ΔTX function is ON.
- 76 VFO INDICATORS**
Show that the VFO mode is selected.
 - Selected VFO (VFO A or VFO B) is indicated.
- 77 QUICK TUNING INDICATOR**
Shows that the quick tuning step is ON.
- 78 MODE INDICATORS**
Show the operating mode.
- 79 EXT INDICATOR**
Shows that an optional AH-3 is connected to the [ANT 1] connector and [ANT 1] is selected.

Microphone (HM-36)

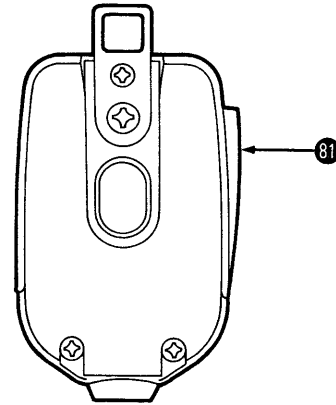
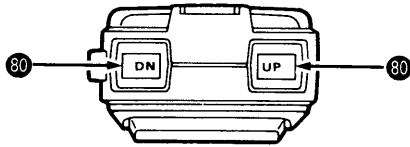

80 UP/DOWN SWITCHES [UP]/[DN]

- Change the operating frequency or memory channel.
- Continuous pushing changes the frequency or memory channel number continuously.

81 PTT SWITCH

Push and hold to transmit; release to receive.

TECHNICAL INFORMATION

• MICROPHONE CONNECTOR

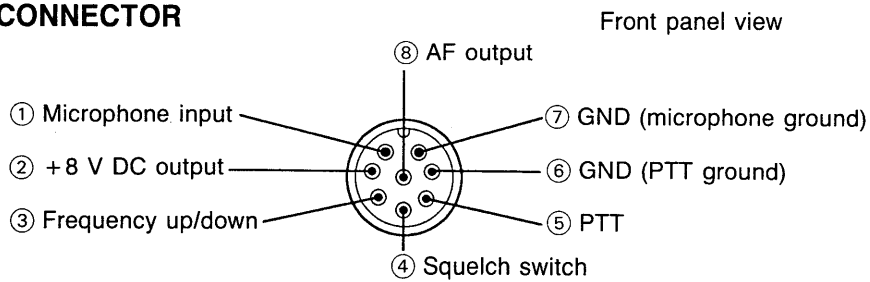

PIN. NO	FUNCTION	DESCRIPTION
2	+8 V DC output	Max. 10 mA
3	Frequency up	Ground
	Frequency down	Ground through 470 Ω
4	Squelch open	"LOW" level
	Squelch closed	"HIGH" level

CAUTION: DO NOT short pin 2 to ground as this can damage the internal 8 V regulator.

• HM-36 SCHEMATIC DIAGRAM

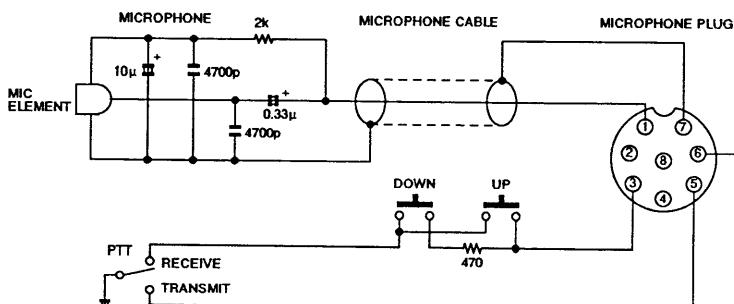

■ Unpacking

After unpacking, immediately report any damage to the delivering carrier or dealer. Keep the shipping cartons.

■ Mounting the transceiver

Select a location for the transceiver that allows adequate air circulation, free from extreme heat, cold, or vibrations, and away from TV sets, radios and other electro-magnetic sources.

ADJUSTMENT ANGLES

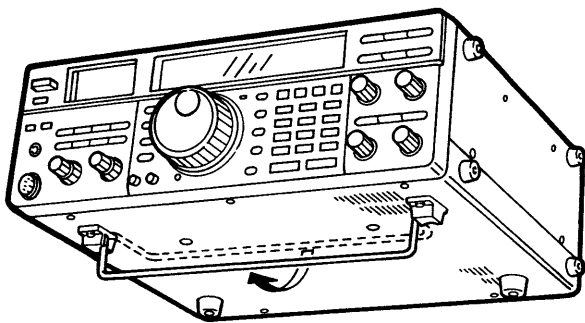

The stand on the bottom of the IC-737A provides two operating angles.

For a description and a diagram of accessory equipment included with the IC-737A, see UNPACKING on the inside front page (p. i) of this manual.

For mobile installations, an optional MB-49 MOBILE MOUNTING BRACKET is available. Select a location which can support the weight of the transceiver and that does not interfere with the operation of the vehicle.

WIRING THE DC POWER CABLE IN YOUR CAR

Attach a rubber grommet to the DC power cable to prevent shorting.

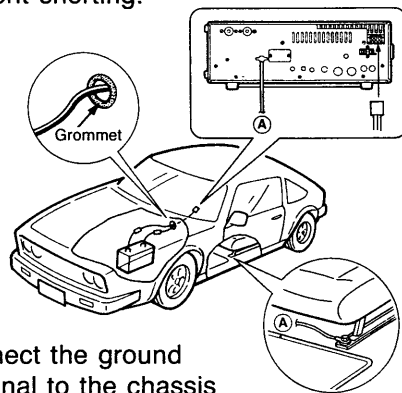

Connect the ground terminal to the chassis ground.

Make sure that the ground point is connected to the chassis ground with a multi-meter.

■ Antenna

Select an antenna, such as a well-matched 50 Ω antenna and feedline. The transmission line should be a coaxial cable. 1.5 : 1 or better of Voltage Standing Wave Ratio (VSWR) is recommended with an accurate SWR meter.

When using 1 antenna, use the [ANT 1] connector.

CAUTION: Protect your transceiver from lightning by using a lightning arrestor.

PL-259 CONNECTOR INSTALLATION

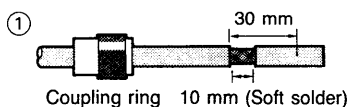

Slide the coupling ring down. Strip the cable jacket and soft solder.

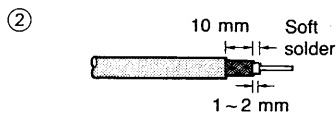

Strip the cable as shown at left. Soft solder the center conductor.

(10 mm \approx 3/8 in)

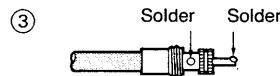

Slide the connector body on and solder it.

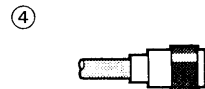

Screw the coupling ring onto the connector body.

GROUNDING

To prevent electrical shock, television interference (TVI), broadcast interference (BCI) and other problems, ground the transceiver through the GROUND terminal on the rear panel.

For best results, connect a heavy gauge wire or strap to a long earth-sunk copper rod. Make the distance between the GROUND terminal and ground as short as possible.

■ Connections chart

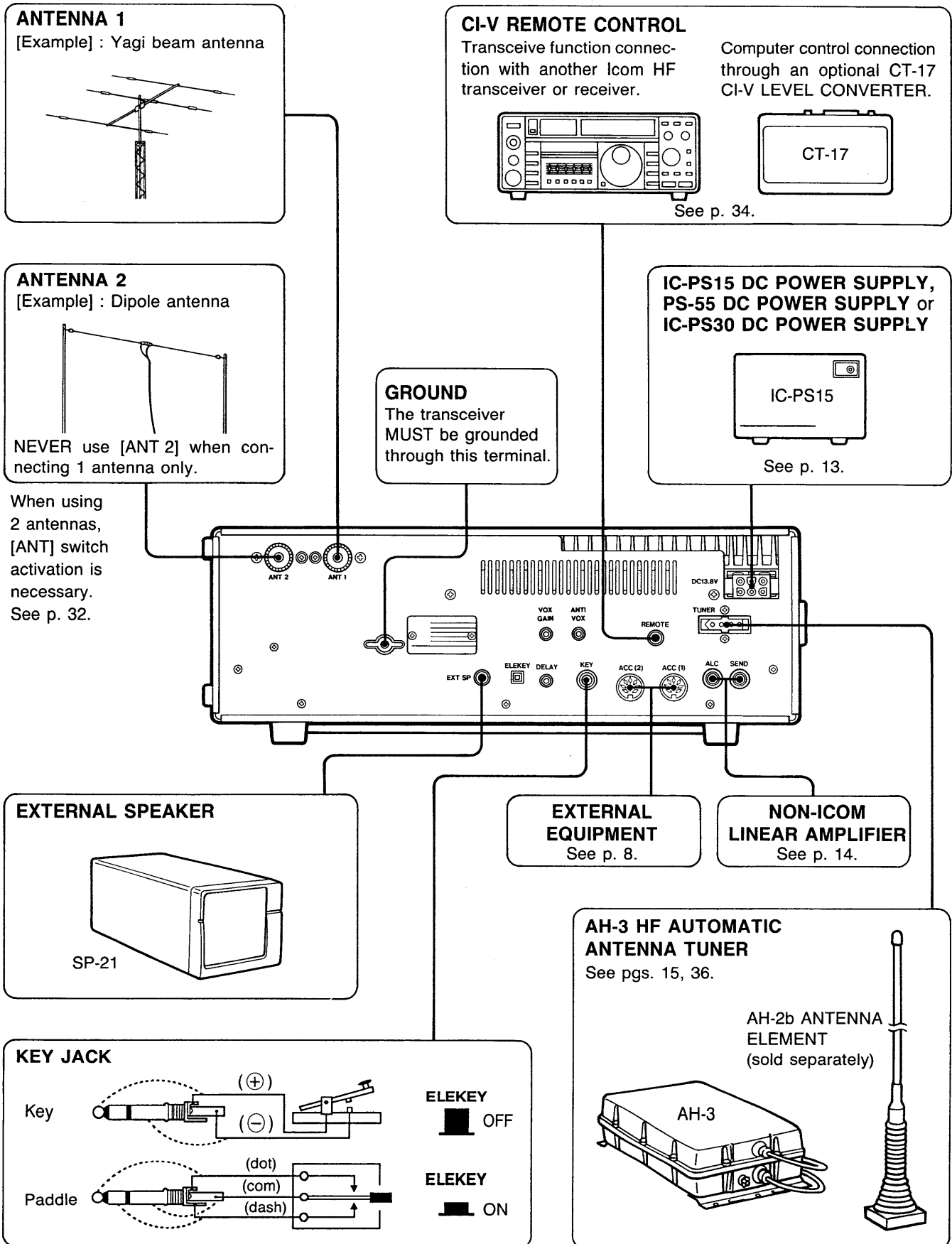

2 INSTALLATION AND CONNECTIONS

■ Power supply connections

Use an optional IC-PS15, IC-PS30 or PS-55 DC POWER SUPPLY when operating the IC-737A with AC power. Refer to the diagram below.

CAUTION: Before connecting the DC power cable, check the following important items. Make sure:

- The [POWER] switch is OFF.
- Output voltage of the power source is 12~15 V when you use a non-Icom power supply.
- DC power cable polarity is correct.
Red : positive ⊕ terminal
Black : negative ⊖ terminal

CONNECTING AN ICOM DC POWER SUPPLY

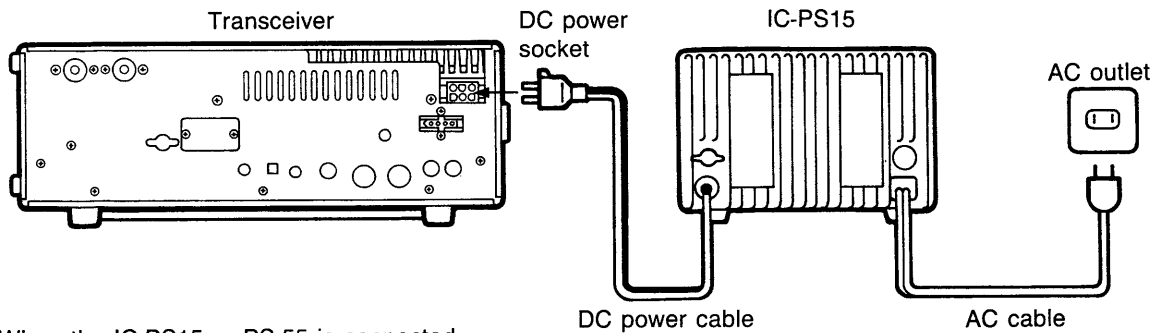

When the IC-PS15 or PS-55 is connected, the power supply's power is synchronized with the [POWER] switch of the IC-737A.

CONNECTING A NON-ICOM DC POWER SUPPLY

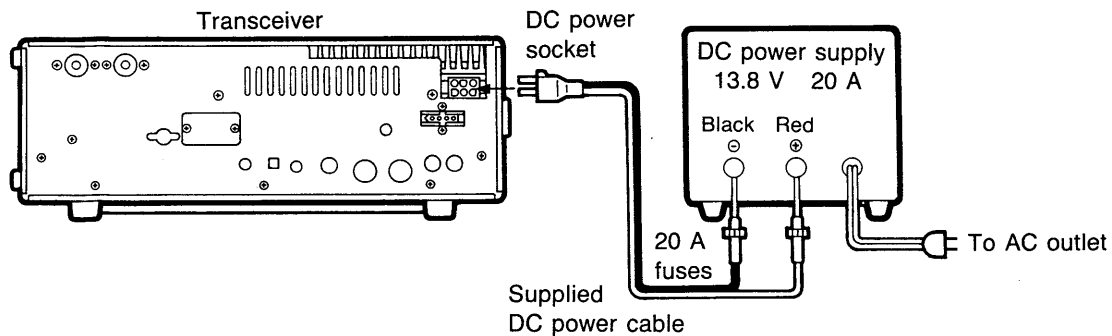

CONNECTING A VEHICLE BATTERY

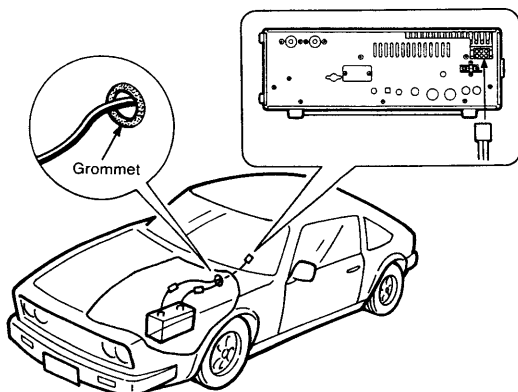

NEVER connect to a 24 V battery.

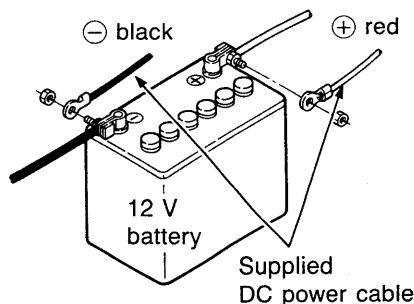

NOTE: Use terminals for the cable connections.

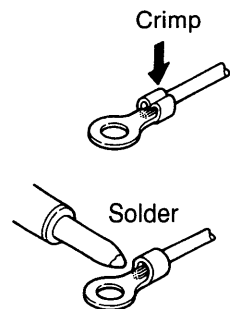

Linear amplifier connections

Use the [ANT 1] connector when connecting a linear amplifier.

CONNECTING THE IC-2KL

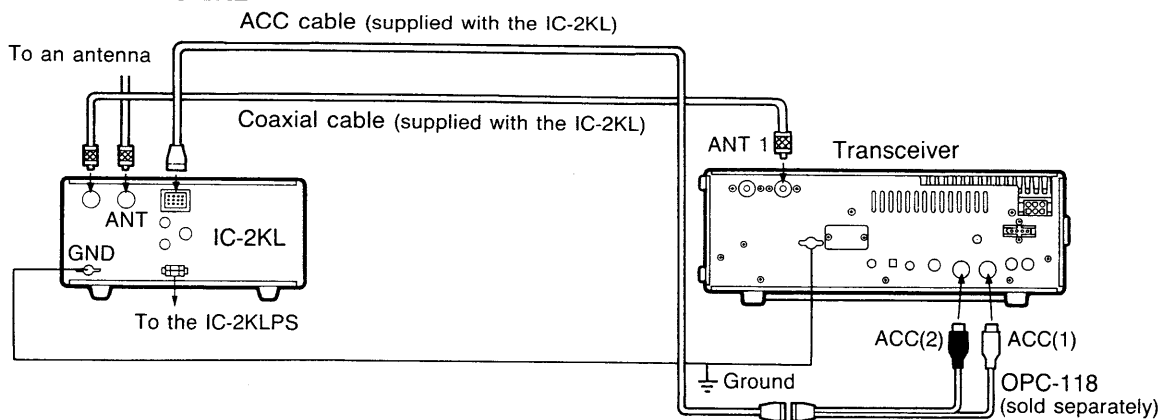

CONNECTING THE IC-4KL

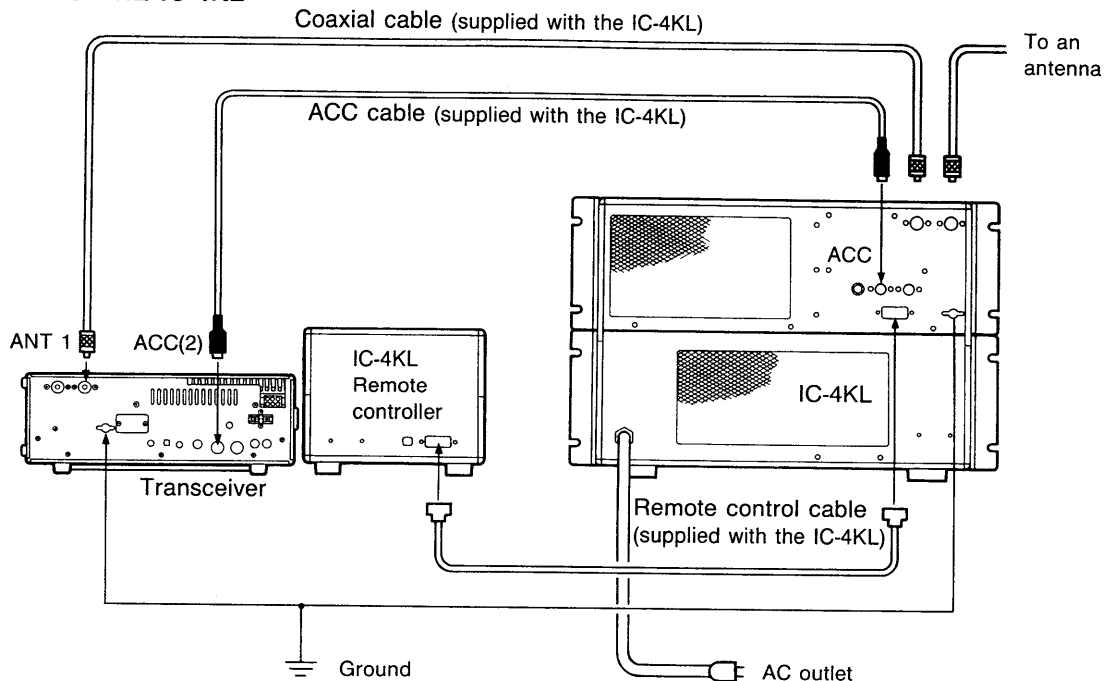

CONNECTING A NON-ICOM LINEAR AMPLIFIER

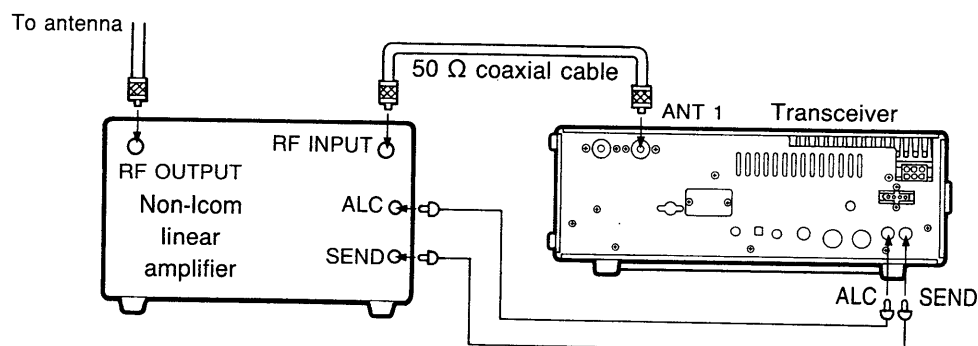

NOTE 1: The specifications for the SEND relay are 16 V DC 2 A. If this level is exceeded, a large external relay must be used.

NOTE 2: The ALC output level of the linear amplifier must be in the range 0 V ~ 4 V, and the IC-737A does not accept positive voltage.

2 INSTALLATION AND CONNECTIONS

External antenna selector or antenna tuner connections

CONNECTING THE EX-627

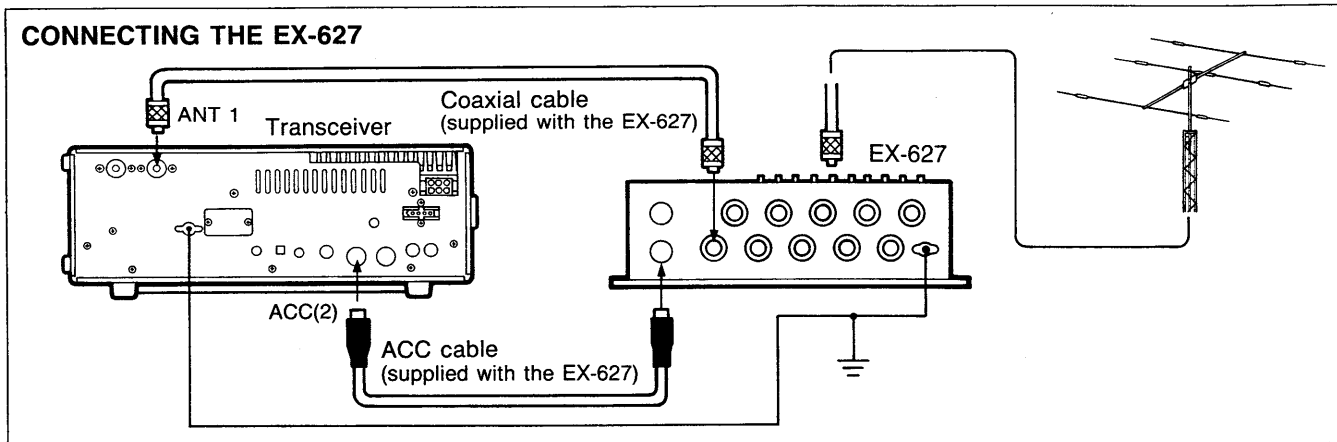

CONNECTING THE AH-3

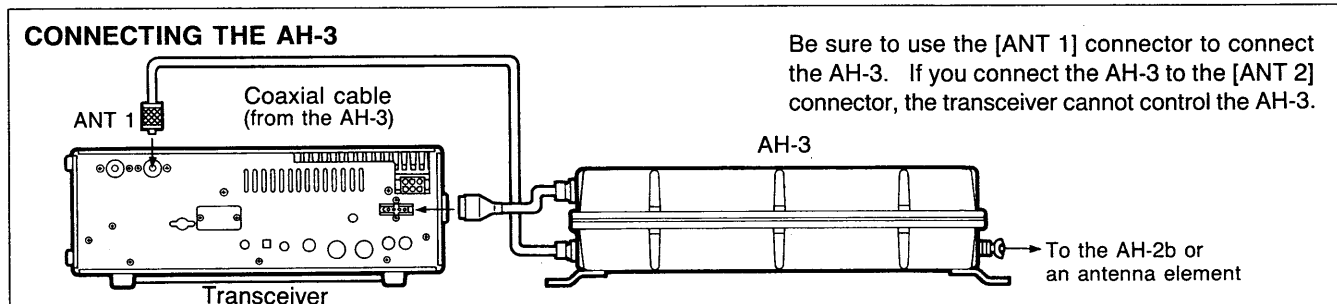

CONNECTING THE AT-150

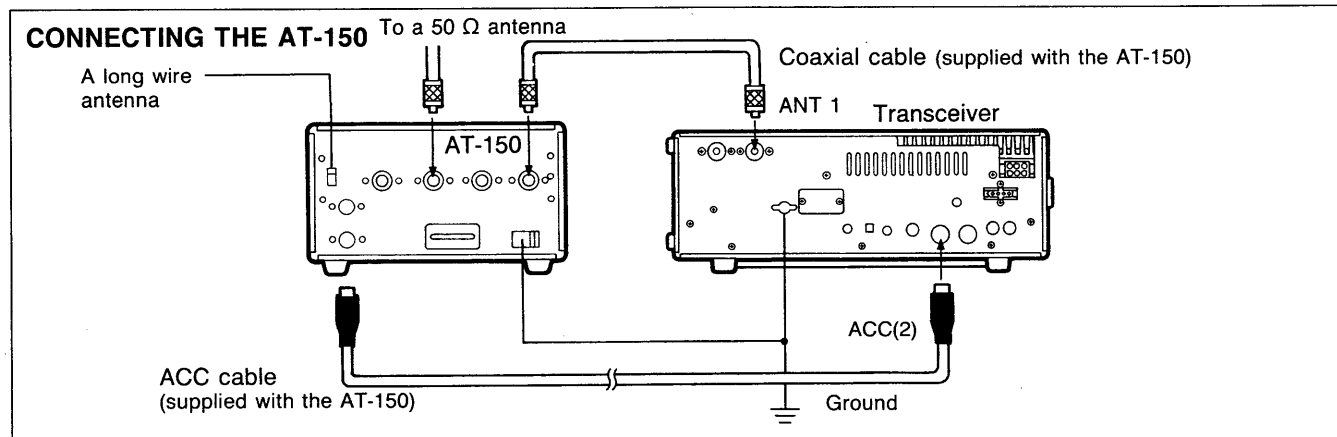

CONNECTING THE IC-AT500 THROUGH THE IC-2KL

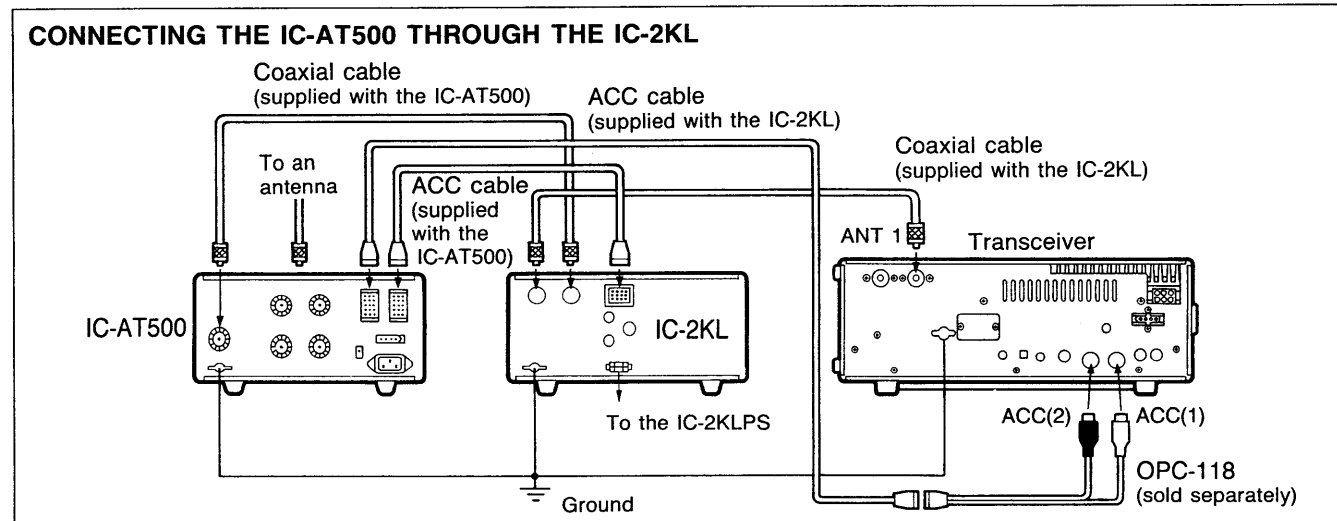

■ AFSK terminal unit connections

The IC-737A does not have FSK mode for RTTY, AMTOR, packet, etc., however, you can operate these using AFSK in SSB or FM mode.

Refer to pgs. 8 and 10 for [ACC(1)] socket information and [MICROPHONE] connector information.

When operating AFSK, connect external equipment to the [ACC(1)] socket on the rear panel or to the [MICROPHONE] connector on the front panel as in the diagram below.

USING THE ACC(1) SOCKET

(Rear panel view)

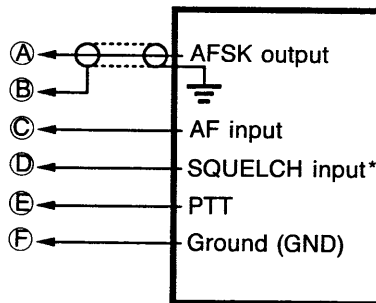
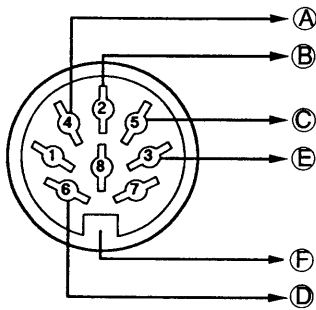

AFSK terminal unit or TNC
(Terminal Node Controller)

USING THE MICROPHONE CONNECTOR

(Front panel view)

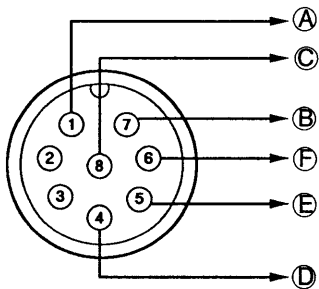

*Connect the SQUELCH line
(D) when required.

■ When first applying power

Before first applying power, make sure all connections required for your system are complete by referring to section 2. Then, reset the transceiver using the following procedure.

NOTE: Resetting CLEARS all programmed contents in memory channels and returns programmed values in the set mode to default values.

- ① Make sure the transceiver power is OFF.
- ② While pushing [CLEAR] and [ENT], push IN [POWER] to turn power ON.
 - The internal CPU is reset.
 - The display at right appears when resetting is complete.

[CPU RESETTING]

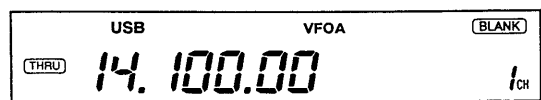
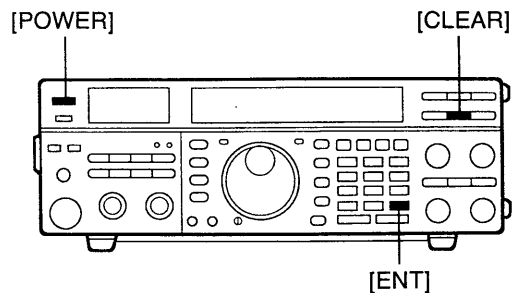

■ Initial settings

After resetting the transceiver, set controls and switches as shown in the figure below.

: Set these switches and controls.
 : Make sure that these functions are not activated.

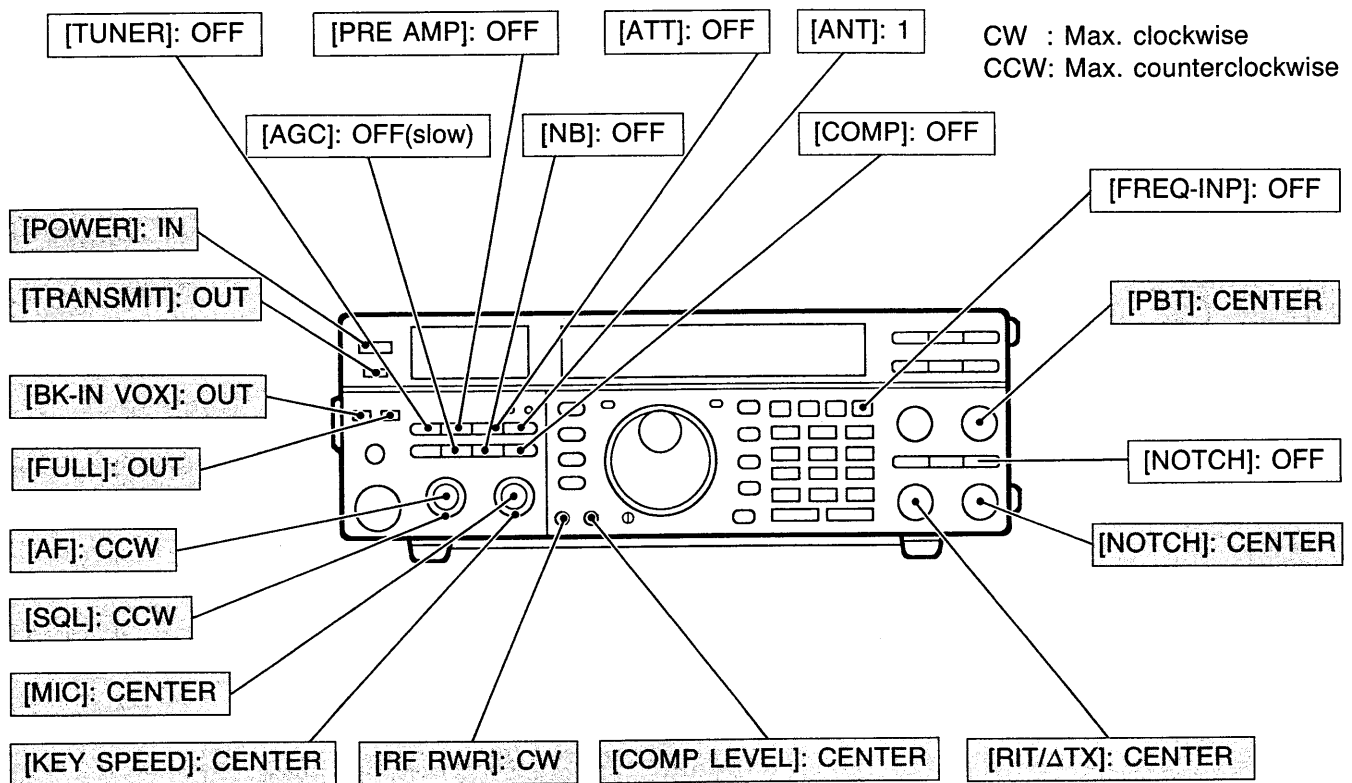

Make sure the following indicators do NOT appear.

- RIT indicator, " ."
- ΔTX indicator, " ."
- Split indicator, " ."
- Dial lock indicator, " ."
- Quick tuning step indicator, " ."

- To turn the RIT indicator OFF, push [RIT].
- To turn the ΔTX indicator OFF, push [ΔTX].
- To turn the split indicator OFF, push [SPLIT].
- To turn the dial lock indicator OFF, push [LOCK].
- To turn the quick tuning step indicator OFF, push [TS].

Basic operation

•Phone (SSB, AM or FM) operation

- ① Make sure the initial settings are complete.

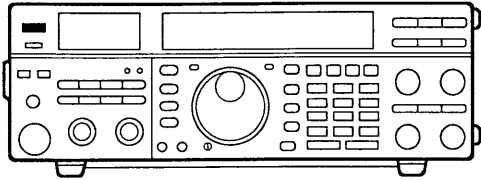

- ② Rotate the main dial to set the desired frequency.
• See pgs. 21 ~ 22 for frequency setting details.

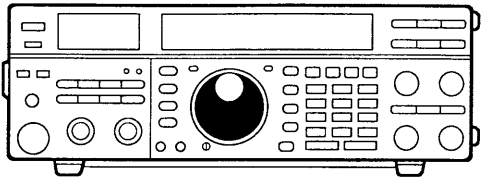

- ③ Select the desired operating mode with [SSB], [AM] or [FM/TONE].

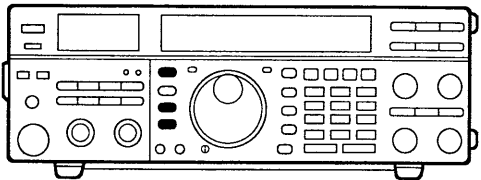

- ④ Push [TUNE] to tune the antenna.
• "TUNE" appears when tuning is complete.
• "THRU" appears after 20 sec. of attempted tuning, if the tuner cannot tune the connected antenna. In this case, check the antenna and the feed line.

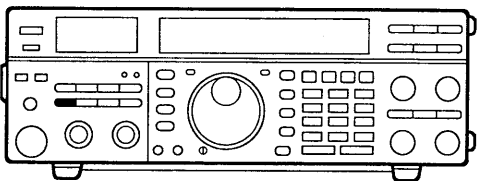

- ⑤ Rotate [AF] clockwise to adjust the desired audio output level.

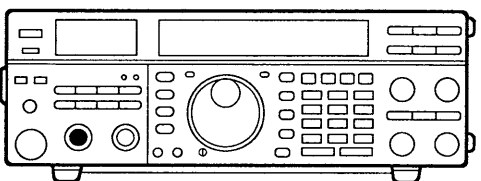

- ⑥ Push the PTT switch on the microphone to transmit. Then, release the PTT switch to return to receive.

To eliminate noise, rotate [SQL] clockwise until the noise disappears.

• If [SQL] is rotated too deeply clockwise, the squelch will not open for weak signals.

•CW operation

- ① Make sure the initial settings are complete.
• A CW key or paddle must be connected. (p. 12)

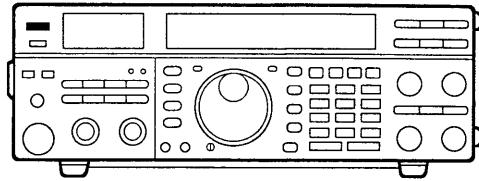

- ② Rotate the main dial to set the desired frequency.
• See pgs. 21 ~ 22 for frequency setting details.

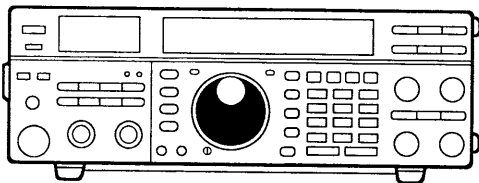

- ③ Select the CW mode with [CW/N].
• If an optional CW narrow filter is installed, you can select the "CW-Narrow" mode.

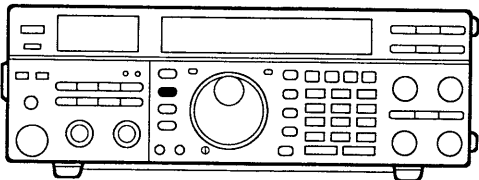

- ④ Push [TUNE] to tune the antenna.
• "TUNE" appears when tuning is complete.
• "THRU" appears after 20 sec. of attempted tuning, if the tuner cannot tune the connected antenna. In this case, check the antenna and the feed line.

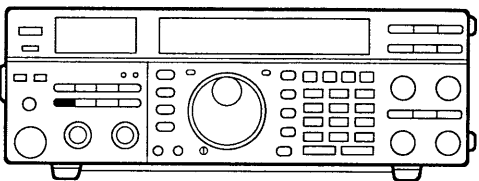

- ⑤ Rotate [AF] clockwise to adjust the desired audio output level.

- ⑥ Push [BK-IN VOX] IN to set the CW semi break-in operation.

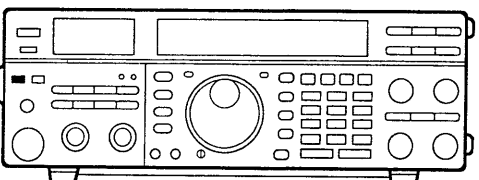

- ⑦ Push the key down and start transmitting.
• The transceiver returns to receive after your transmission ends.

■ VFO description

VFO is an abbreviation of Variable Frequency Oscillator, and traditionally refers to an oscillator.

The IC-737A's VFO is somewhat different. The VFO of the IC-737A acts like a computer's window and can show one frequency and one operating mode.

You can call up a desired frequency to a VFO with the keypad, memo pad-read switch (see p. 27) or the memory transfer switch (see p. 39). You can also change the frequency with the main dial and select operating mode with the mode switches.

The IC-737A has two VFOs, specially suited for split frequency operation. The VFOs are called VFO A and VFO B. You can use the desired VFO to call up a frequency and operating mode for your operation.

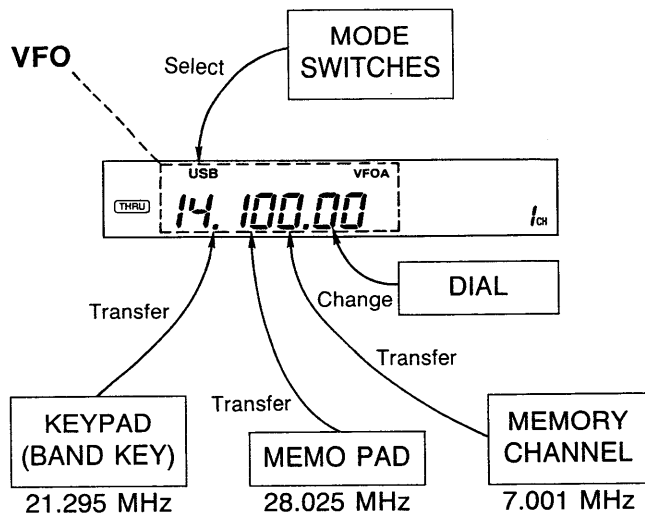

■ VFO mode and memory mode

The IC-737A has 2 major modes, the VFO mode and the memory mode. You can set a frequency and operate the transceiver in either mode, however, use the VFO mode for most normal operations. This is because temporarily set frequencies do not remain in the memory mode. See the next page for mode difference details.

The IC-737A has 101 tunable memory channels in the memory mode for storing your often-used frequencies and operating modes. See pgs. 37~42 for the memory mode operation.

See the following diagram for the mode construction.

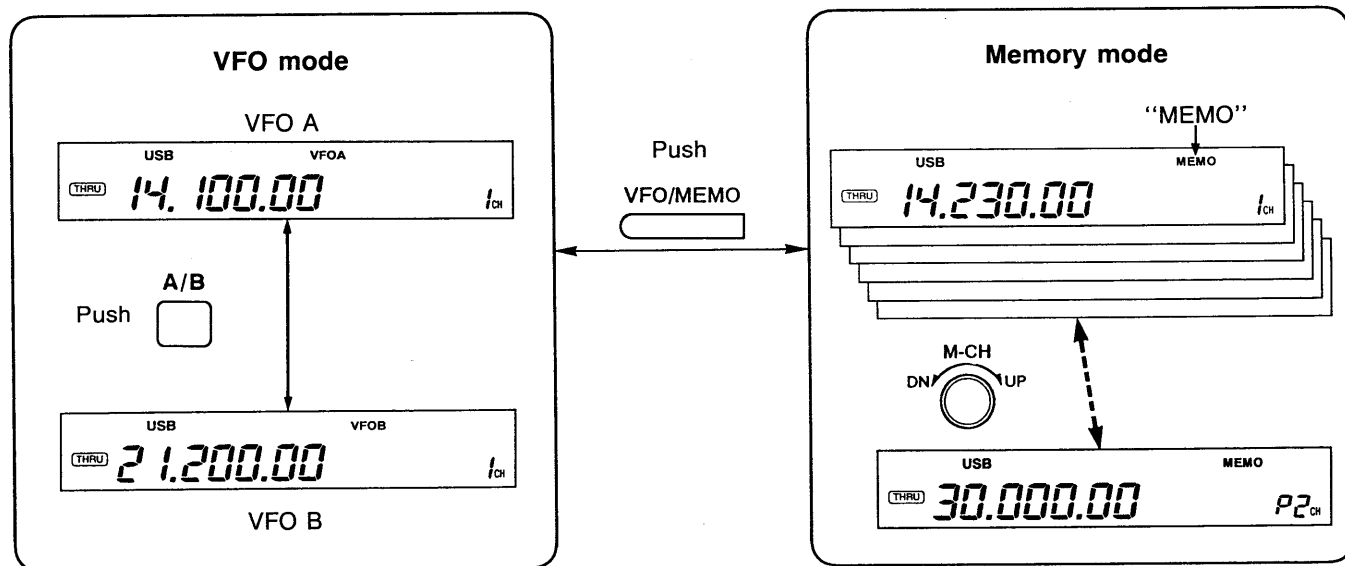

• The differences between the VFO mode and the memory mode

VFO MODE

Each VFO shows a frequency and operating mode. If the frequency or operating mode is changed, the VFO automatically memorizes the new frequency or new operating mode.

When the VFO is selected from another VFO or the memory mode, the last used frequency and operating mode for that VFO appear.

[EXAMPLE]

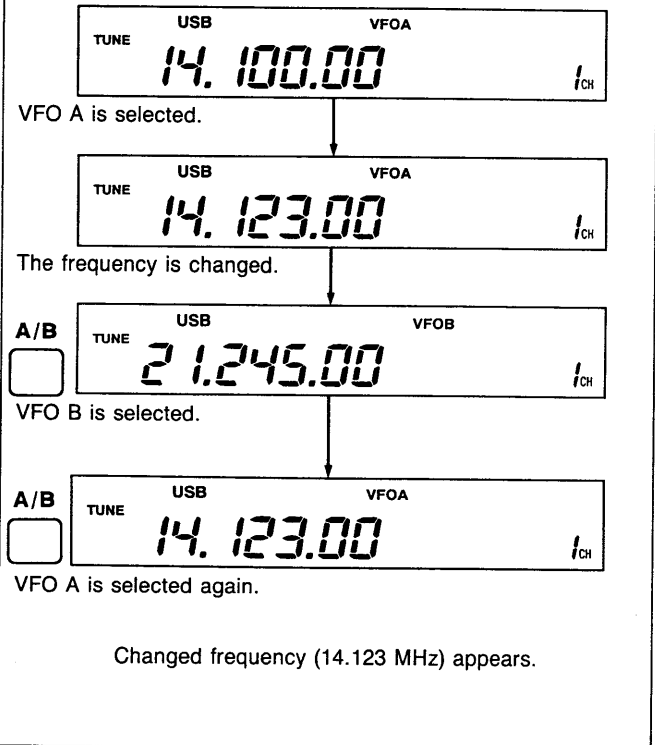

MEMORY MODE (pgs. 37 ~ 42)

Each memory channel shows a frequency and operating mode like a VFO. Even if the frequency or mode is changed, the memory channel does not memorize the new frequency or operating mode.

When the memory channel is selected from another memory channel or VFO mode, the memorized frequency and operating mode appear.

[EXAMPLE]

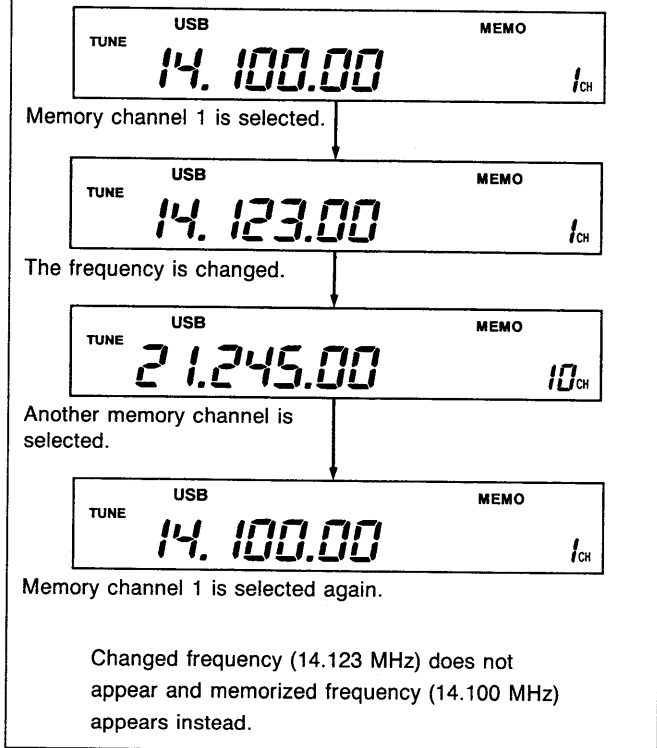

■ Frequency setting with the main dial

• For ham band use

- Push [VFO/MEMO] to select the VFO mode if the memory mode has been selected.
 - Then, push [A/B] to select the desired VFO, VFO A or VFO B.

“VFO A” or “VFO B” appears.



- Push the desired band key on the keypad once or twice.
 - 2 different frequencies can be selected on each band with the band key. (See DBSR in the box below.)

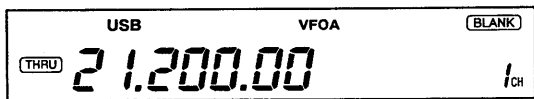

- Rotate the main dial to set the desired frequency.

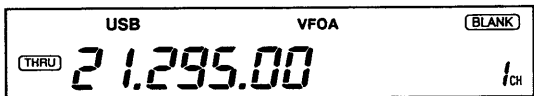

- Select the desired operating mode with the mode switches.

• For general coverage receiver use

- Push [VFO/MEMO] to select the VFO mode if the memory mode has been selected.
 - Then, push [A/B] to select the desired VFO, VFO A or VFO B.

“VFO A” or “VFO B” appears.

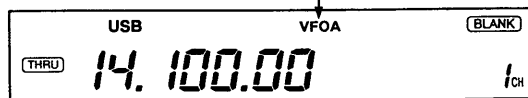

- Push [GENE] on the keypad once or twice.
 - The [GENE] key calls up a frequency for the general coverage receiver use.

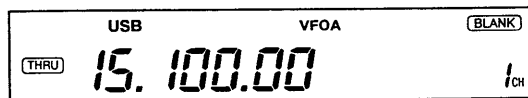

- Rotate the main dial to set the desired frequency.
 - For quick tuning, use [UP]/[DOWN] switches or quick tuning step function (p. 22)

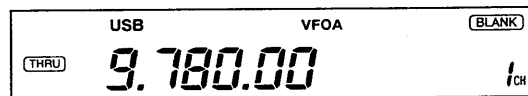

- Select the desired operating mode with the mode switches.

NOTE 1: If the dial lock function is activated, “**LOCK**” is indicated and the main dial does not function. In this case, push [LOCK] to deactivate the dial lock function.

NOTE 2: When changing ham bands with the antenna tuner ON (“TUNE” is indicated), the antenna tuner presets for the band. Therefore the antenna tuner may flutter for a while.

FUNCTION

The **DBSR (Double Band Stacking Register)** provides 2 memories in one band. 2 sets of a frequency and an operating mode on each band are automatically stored when used.

If one of the band keys in the keypad is pushed once, the last used frequency and operating mode for the newly selected band are called up. When the key is pushed again, another stored frequency and operating mode are called up.

This function is convenient when you operate 2 modes in a band or when you frequently change bands such as in a contest. If you are a CW and SSB operator, use one register for storing a CW frequency and another register for an SSB frequency.

[DBSR EXAMPLE]

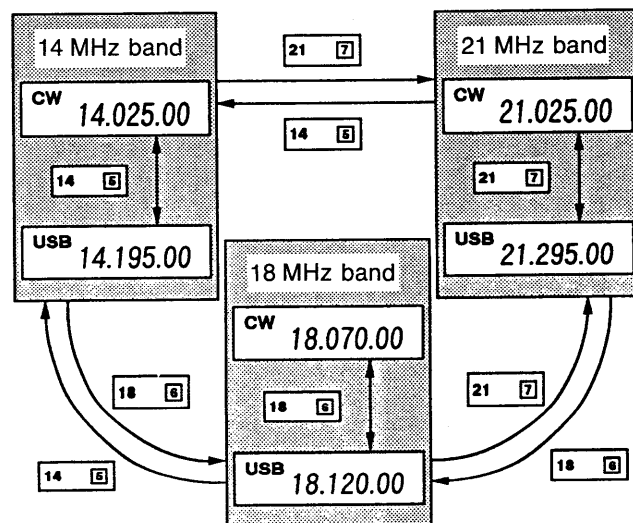

Direct frequency entry with the keypad

The IC-737A has a keypad for direct frequency entry. Follow the steps as described below.

- ① Push [FREQ-INP].
 - The red indicator on the switch lights.
- ② Input the desired frequency.
 - Input “.” (decimal point) between MHz unit and kHz unit.
- ③ Push [ENT] to enter the input frequency.
 - When input is complete, the red indicator on [FREQ-INP] is turned OFF.
 - To cancel input, push [FREQ-INP] instead of [ENT].

[EXAMPLES]

- To enter 14.025 MHz, push [FREQ-INP][1][4][.][0][2][5][ENT].
- To enter 18.0725 MHz, push [FREQ-INP][1][8][.][0][7][2][5][ENT].
- To enter 729 kHz, push [FREQ-INP][0][.][7][2][9][ENT].
- To enter 9.780 MHz, push [FREQ-INP][9][.][7][8][ENT].
- To enter 5.000 MHz, push [FREQ-INP][5][ENT].
- To enter 21.245 MHz when 21.280 has been selected, push [FREQ-INP][.][2][4][5][ENT].

Advanced tuning functions

QUICK TUNING STEP

The operating frequency can be changed in kHz steps (1 ~ 10 kHz programmable) for quick tuning.

- ① Push [TS] to display the quick tuning indicator.

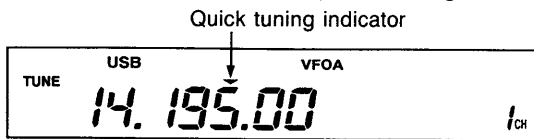

- ② Rotate the main dial to change the frequency in programmed kHz steps.
- ③ Push [TS] again to turn OFF the indicator.
- ④ Rotate the main dial for fine tuning if required.

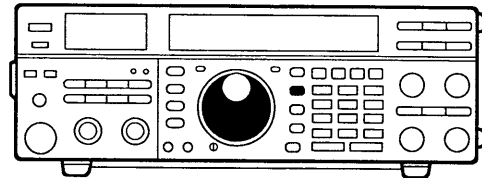

Programming kHz step

- ① Push [FREQ-INP].
- ② Enter the desired kHz step with the digit key(s), [1] ~ [1][0].
- ③ Push [TS] to set the entered kHz step.

(e.g. For 9 kHz step, push [FREQ-INP][9][TS].)

[UP]/[DOWN] SWITCH TUNING

The [UP]/[DOWN] switch changes the frequency in programmed steps for large frequency changes. You can set this tuning step from 1 kHz ~ 1 MHz (in 1 kHz intervals).



Programming [UP]/[DOWN] switch tuning step

- ① Push [FREQ-INP].
- ② Enter the desired step with the digit key(s), [1] ~ [1][0][0][0].
- ③ Push [UP] or [DOWN].

(e.g. For 5 kHz step, push [FREQ-INP][5][UP].
For 1 MHz step, push [FREQ-INP][1][0][0][0][UP].)

CHANGING THE MINIMUM TUNING STEP

The transceiver's minimum tuning step default setting is 10 Hz. However, this can be changed to 20 Hz or 50 Hz as follows.

- For 10 Hz step, push [FREQ-INP][0][.][1][TS].
- For 20 Hz step, push [FREQ-INP][0][.][2][TS].
- For 50 Hz step, push [FREQ-INP][0][.][5][TS].

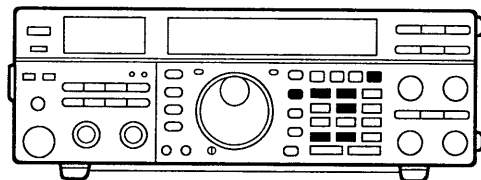

AUTO TUNING STEP FUNCTION

When selecting AM or FM, the quick tuning step indicator is automatically selected by the auto tuning step function. This function can be turned ON and OFF for your convenience in the set mode. (p. 31)

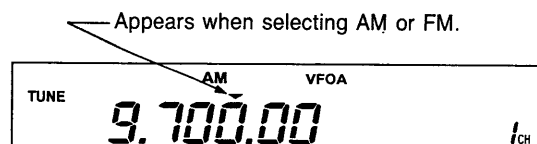

Receiving

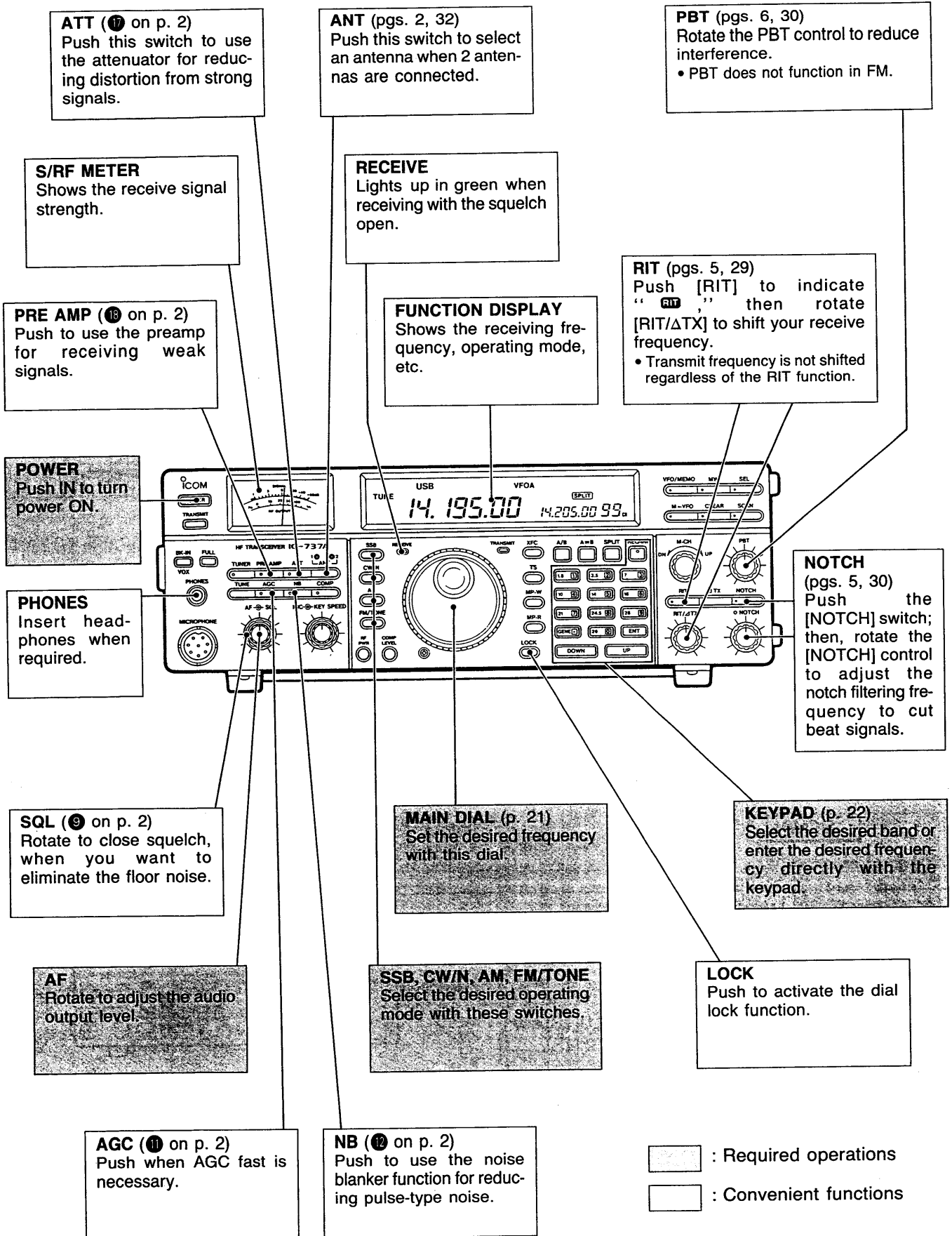

SSB RECEIVING

- ① Turn power ON with [POWER].
- ② Set the desired frequency.
- ③ Select USB or LSB with [SSB].
 - The [SSB] switch selects USB and LSB alternately.
 - USB is normally used in ham bands above 10 MHz, and LSB is normally used in ham bands below 10 MHz.
- ④ Adjust the audio output level with [AF].

Convenient functions for SSB receiving

- NB (Noise Blanker)
- ATT (Attenuator)
- PRE AMP (Pre-amplifier)
- AGC (Auto Gain Control)
- PBT (Passband Tuning)
- RIT (Receiver Incremental Tuning)
- NOTCH
- LOCK (Dial lock)
- SQUELCH

CW RECEIVING

- ① Turn power ON with [POWER].
- ② Set the desired frequency.
- ③ Select CW with [CW/N].
 - The [CW/N] switch selects normal CW or CW-Narrow (CW-N) alternately.
- ④ Adjust the audio output level with [AF].

Convenient functions for CW receiving

- NB (Noise Blanker)
- ATT (Attenuator)
- PRE AMP (Pre-amplifier)
- AGC (Auto Gain Control)
- PBT (Passband Tuning)
- RIT (Receiver Incremental Tuning)
- NOTCH
- LOCK (Dial lock)
- SQUELCH
- CW-Narrow mode (An optional CW filter is necessary.)

AM RECEIVING

- ① Turn power ON with [POWER].
- ② Set the desired frequency.
- ③ Select AM with [AM].
- ④ Adjust the audio output level with [AF].

Convenient functions for AM receiving

- ATT (Attenuator)
- PRE AMP (Pre-amplifier)
- AGC (Auto Gain Control)
- RIT (Receiver Incremental Tuning)
- NOTCH
- LOCK (Dial lock)
- SQUELCH
- NB (Noise Blanker)
- AUTO TUNING STEP (p. 22)

FM RECEIVING

- ① Turn power ON with [POWER].
- ② Set the desired frequency.
- ③ Select FM with [FM/TONE].
- ④ Adjust audio output level with [AF].
- ⑤ Rotate [SQL] clockwise until noise disappears.

Convenient functions for FM receiving

- ATT (Attenuator)
- PRE AMP (Pre-amplifier)
- RIT (Receiver Incremental Tuning)
- NOTCH
- LOCK (Dial lock)
- AUTO TUNING STEP (p. 22)

AFSK (RTTY, AMTOR, PACKET, etc.) RECEIVING

(External equipment is necessary.)

- ① Turn power ON with [POWER].
- ② Set the desired frequency.
- ③ Select LSB, USB or FM.
 - LSB is normally used.
 - FM is used for packet on 29 MHz.
- ④ Adjust the audio output level with [AF].
 - Use [SQL] when required.

Operating notes for RTTY and AMTOR receiving

- RTTY or AMTOR operating frequency in LSB mode differs from the displayed frequency.

[Your operating freq.] = [Displayed freq.] – 2125 Hz
(when the frequencies of the RTTY demodulator in your TU or TNC are mark = 2125 Hz and space = 2295 Hz.)

Operating notes for PACKET receiving

- Packet operating frequency in LSB mode differs from the displayed frequency.

[Your operating freq.] = [Displayed freq.] – 2215 Hz
(when the frequencies of the packet demodulator in your TNC are 2115 Hz/2315 Hz.)

■ Transmitting

NOTE: Transmission is possible only within the range defined in the specifications on p. 57.

ANT (pgs. 2, 32)
Push to select the antenna when 2 antennas are connected.

COMP/LEVEL (16, 21) on pgs. 2, 3
Push [COMP] then, adjust the compression level with [COMP LEVEL] to use the speech compressor for increasing the level of average talk power.

SETTING PROCEDURE

Compression level setting: Rotate [COMP LEVEL] to get adequate compression but not distortion while monitoring your transmitting voice signal with another HF receiver.

S/RF METER
Shows the relative output power.

SSB, CW/N, AM FM/TONE (p. 4)
Select the desired operating mode.

FUNCTION DISPLAY
Shows the transmitting frequency, operating mode, etc.

TUNER/TUNE (pgs. 1, 37)
Push [TUNER] to turn the antenna tuner ON.
• When tuning the antenna manually, push [TUNE].

TRANSMIT (p. 4)
Lights up in red when transmitting. Intensifies when the ALC is activated.

ΔTX (pgs. 5, 29)
Push [ΔTX] to indicate "ΔTX," then rotate [RIT/ΔTX] to shift your transmit frequency.
• Receive frequency is not shifted regardless of the ΔTX function.

POWER
Push IN to turn power ON.

TRANSMIT
Push IN to transmit and push OUT to receive.
• Same function as the PTT on the microphone.

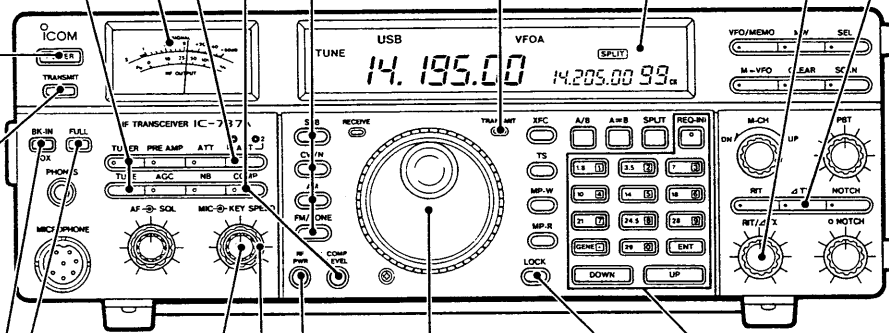

BK-IN VOX, FULL (p. 1)
Push [BK-IN VOX] IN to use the break-in or VOX function.

[FULL]
- Push IN for the full break-in (QSK) function.
- Push OUT for the semi break-in function.

• For the semi break-in or VOX function, adjust [DELAY] on the rear panel.

MAIN DIAL (p. 21)
Set the desired frequency with this dial.

KEYPAD (p. 22)
Select the desired band or enter the desired frequency directly with the keypad.

RF PWR (p. 3)
Rotate to set the desired RF output power.

LOCK (p. 3)
Push to activate the dial lock function

KEY SPEED (p. 2)
Rotate to adjust the internal electronic keyer when used.

■ : Required operations
□ : Convenient functions

SETTING PROCEDURE

MIC GAIN (p. 2)
Set to the 10~12 o'clock position when using the supplied microphone.

Mic gain setting: While transmitting in SSB mode, rotate [MIC GAIN] to adjust the mic gain so that the ALC indicator ([TRANSMIT]) sometimes intensifies with your normal voice level.

SSB TRANSMITTING

- ① Set for SSB (USB or LSB) receiving.
- ② Set the frequency within your allowed frequency range for SSB transmitting.
- ③ Set the desired RF output power with [RF PWR].
- ④ Push and hold the PTT switch on the microphone and speak into the microphone.

Operating notes for SSB transmitting

- [MIC] should be set correctly. When using a non-Icom microphone, set [MIC] referring to "SETTING PROCEDURE" described on the page at left.

Convenient functions for SSB transmitting

- COMP (Speech compressor)
- ΔTX (p. 29)
- VOX (p. 30)

CW TRANSMITTING

(An external CW keyer or a paddle is necessary.)

- ① Set for CW receiving.
- ② Set the frequency within your allowed frequency range for CW transmitting.
- ③ Set the desired RF output power with [RF PWR].
- ④ Push [BK-IN VOX] IN.
- ⑤ Push [FULL] IN or OUT.
 - IN : For full break-in (QSK).
 - OUT : For semi break-in.
- ⑥ Start keying.

Operating notes for CW transmitting

- The break-in function automatically starts transmitting when the key is down, and then returns to receive. If you want to switch transmitting/receiving manually, turn the break-in function OFF. You can use the [TRANSMIT] switch to change between transmitting and receiving.

Convenient functions for CW transmitting

- Full or semi break-in
- Semi break-in delay control
- Internal electronic keyer with keying speed control
- Side tone level preset (p. 49)
- ΔTX (p. 29)

AM TRANSMITTING

- ① Set for AM receiving.
- ② Set the frequency within your allowed frequency range for AM transmitting.
- ③ Set the desired RF output power with [RF PWR].
- ④ Push and hold the PTT switch on the microphone and speak into the microphone.

Operating notes for AM transmitting

- [MIC] should be set correctly. When using a non-Icom microphone, set [MIC] by monitoring another HF receiver.

Convenient functions for AM transmitting

- COMP (Speech compressor)
- ΔTX (p. 29)
- VOX (p. 30)

FM TRANSMITTING

- ① Set for FM receiving.
- ② Set the frequency within your allowed frequency range for FM transmitting.
- ③ Set the desired RF output power with [RF PWR].
- ④ Push and hold the PTT switch on the microphone and speak into the microphone.

Operating notes for FM transmitting

- [MIC] should be set correctly. When using a non-Icom microphone, set [MIC] by monitoring another HF receiver.

Convenient functions for FM transmitting

- COMP (Speech compressor)
- FM TONE (Subaudible tone; an optional UT-30 is necessary.)
- ΔTX (p. 29)
- VOX (p. 30)

AFSK TRANSMITTING

(External equipment is necessary.)

- ① Set for AFSK receiving. (LSB is normally used.)
- ② Set the frequency within your allowed frequency range for AFSK transmitting.
- ③ Set the desired RF output power with [RF PWR].
 - When using the [MICROPHONE] connector for the external equipment connection, [MIC GAIN] should be adjusted.
- ④ Push [TRANSMIT] IN or send a TX control signal from the external terminal unit or TNC; then, start transmitting your AFSK signal.

Operating notes for AFSK transmitting

- AFSK operating frequency differs from the displayed frequency. Refer to the formula described on p. 24.

Frequency setting example for AFSK transmitting

- When operating RTTY at 14.090 MHz: Set "LSB 14.09212 MHz" (if you use mark = 2125 Hz/ space = 2295 Hz.)
- When operating packet at 14.110 MHz: Set "LSB 14.11221 MHz" (if you use 2115 Hz/2315 Hz.)

■ Memo pad operation

The IC-737A has a memo pad function to store frequency and operating mode for easy write and recall. The memo pads are separate from memory channels.

The default number of memo pads is 5, however this can be increased to 10 in the set mode if needed. (p. 32).

The memo pad function is convenient when you want to memorize a frequency and operating mode temporarily, such as when you find a DX station in a pile-up or when a desired station is busy for a long time and you want to search for other stations.

Use these memo pads instead of paper memo pads for writing frequencies.

• Writing frequencies and operating modes into memo pads

You can simply write the displayed frequency and operating mode by pushing the [MP-W] switch.

When you write a 6th frequency and operating mode, the oldest written frequency and operating mode are automatically erased to make room for the new settings.

NOTE: Each memo pad must have its own unique combination of frequency and operating mode, memo pads containing identical settings cannot be written.

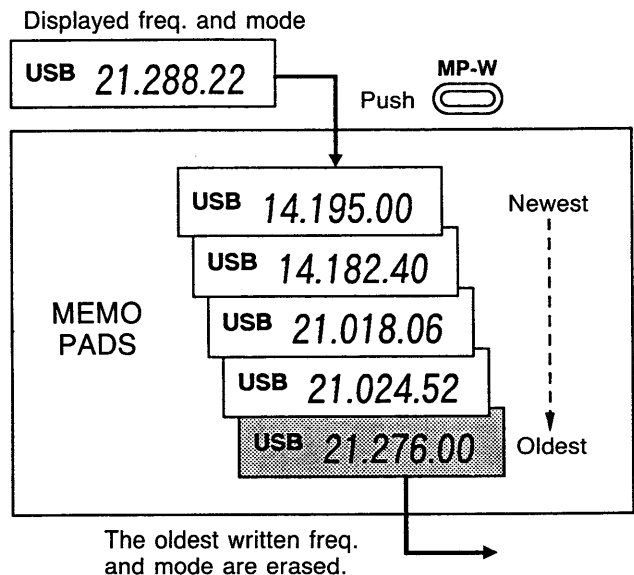

• Calling up a frequency from a memo pad

You can simply call up the desired frequency and operating mode of a memo pad by pushing the [MP-R] switch one or more times.

- Both the VFO and memory modes can be used.
- The frequency and operating mode are called up, starting from the most recently written.

When you call up a frequency and an operating mode from memo pads with [MP-R], the previously displayed frequency and operating mode are automatically stored in a temporary pad. The frequency and operating mode in the temporary pad can be recalled by pushing [MP-R] one or more times.

- You may think there are 6 memo pads because 6 different frequencies: 5 are in memo pads and 1 is in the temporary pad.

NOTE: If you change the frequency or operating mode called up from a memo pad with the main dial, etc., the frequency and operating mode in the temporary pad are erased.

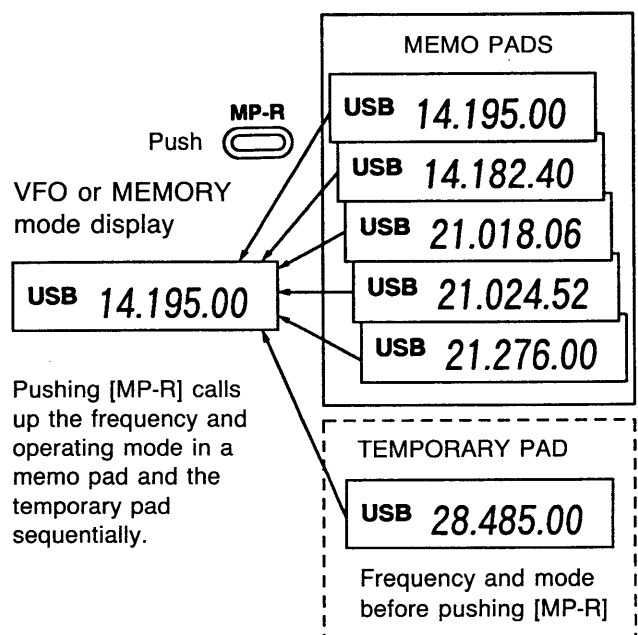

Split frequency operation

Split frequency operation allows you to transmit and receive on two different frequencies.

The split frequency operation is basically performed using 2 frequencies on 2 VFOs.

Following is an example of setting 21.290 MHz for receiving and 21.310 MHz for transmitting.

- ① Set 21.290 MHz (USB) in the VFO mode.
 - Both VFO A and VFO B can be used.



- ② Push and hold [SPLIT] for 1 sec.
 - When the quick split function (see below) is OFF, push [SPLIT]; then, push and hold [A=B] for 1 sec.
 - Equalized transmit frequency and "SPLIT" appear.

"SPLIT" appears.



- ③ While pushing [XFC], rotate the main dial to set the transmit frequency to 21.310 MHz.

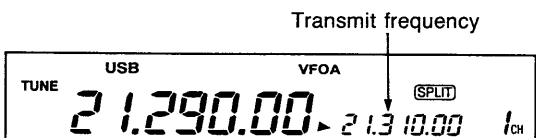

Now you can receive on 21.290 MHz and transmit on 21.310 MHz.

- "▶" appears while transmitting. It indicates the sub VFO frequency (21.310 MHz) is being used for transmitting.

To change the transmit and receive frequencies, push [A/B] to exchange VFOs.

NOTE: The IC-737A has 10 split memory channels (memory channels 90 ~ 99) which store 2 frequencies for split frequency operation. See pgs. 40 ~ 41 for details.

PRACTICAL EXAMPLE

When you find a DX station on 14.195 MHz/USB and the station says "UP 10 kHz" for his receiving frequency:

- ① Push and hold [SPLIT] for 1 sec.
 - The sub VFO frequency is equalized to the main VFO frequency and they appear with "SPLIT."
- ② While pushing [XFC], rotate the main dial to set the sub VFO frequency to 14.205 MHz.
 - 14.195 MHz + 10 kHz = 14.205 MHz.
 - If you have programmed 5 kHz for the [UP]/[DOWN] switch tuning step, push [UP] twice while pushing [XFC].
 - While pushing [XFC], you can monitor the sub VFO frequency.
- ③ Push and hold the PTT switch and call while the DX station is standing by.

PRACTICAL EXAMPLE

When you receive a pile-up and you want to start split frequency operation to simplify picking out stations:

- ① Announce your receive frequency; then, push and hold [SPLIT] for 1 sec.
 - The sub VFO frequency is equalized to the main VFO frequency and they appear with "SPLIT."
- ② Rotate the main dial to set your receive frequency in the main VFO.
- ③ Push and hold the PTT switch and respond after you catch one of the calling station's call signs.
 - While pushing [XFC], you can monitor your transmit frequency.

QUICK SPLIT FUNCTION

The [SPLIT] switch can be used to set split frequency operation and equalize VFO frequencies at the same time with the quick split function.

When you push and hold the [SPLIT] switch, split frequency operation is turned ON and the sub VFO frequency and operating mode are equalized to the main VFO frequency and operating mode.

SPLIT



= [SPLIT] + [A=B]

Push and hold.

This shortens the time needed to start split frequency operation.

The quick split function is ON by default. For your convenience, it can be turned OFF in the set mode. In this case, the [SPLIT] switch does not equalize the VFO frequencies. (p. 33)

4 FUNCTION OPERATION

■ RIT and ΔTX

• RIT function

The RIT function shifts the receive frequency up to ± 1.25 kHz in 10 Hz steps without moving the transmit frequency.

- See 30 on p. 5 for function description.
- See p. 31 to expand the RIT range to ± 2.5 kHz. In this case, the RIT frequency varies in 20 Hz steps.

- 1 Push the [RIT] switch.

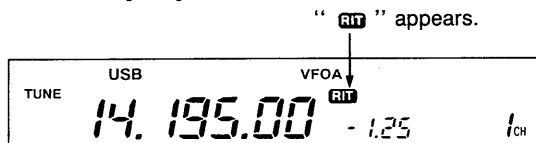

- 2 Rotate the [RIT/ΔTX] control.

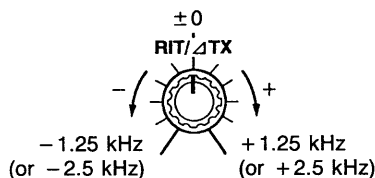

- 3 To cancel the RIT function, push [RIT] again.
 - "RIT" disappears.

[RIT VARIABLE RANGE]

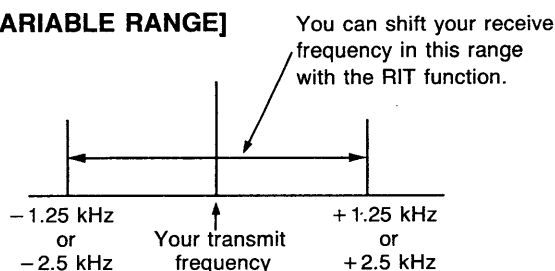

• "ΔTX" function

The ΔTX function shifts the transmit frequency up to ± 1.25 kHz in 10 Hz steps without moving the receive frequency.

- See 40 on p. 5 for function description.
- See p. 31 to expand the ΔTX range to ± 2.5 kHz. In this case, the ΔTX frequency varies in 20 Hz steps.

- 1 Push the [ΔTX] switch.

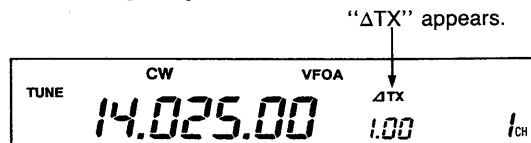

- 2 Rotate the [RIT/ΔTX] control.

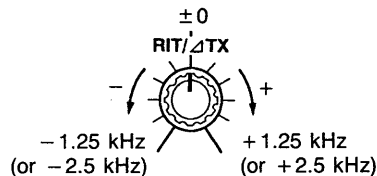

- 3 To cancel the ΔTX function, push [ΔTX] again.
 - "ΔTX" disappears.

[ΔTX VARIABLE RANGE]

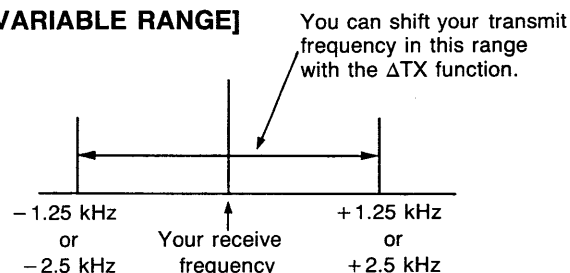

When RIT and ΔTX are ON at the same time, the [RIT/ΔTX] control shifts both the transmit and receive frequencies from the displayed frequency at the same time.

PRACTICAL EXAMPLE

When you find a DX station on 21.025 MHz/CW and the station is picking up stations transmitting slightly up from 21.025 MHz.

- 1 Push [RIT] to turn the RIT function ON.
- 2 Rotate [RIT/ΔTX] to find the DX station's receiving frequency.
- 3 When you find the DX station's receiving frequency, push [RIT] to turn the RIT function OFF; then, push [ΔTX] to turn the ΔTX function ON.
 - Now you can transmit the DX station's receiving frequency and receive the DX station's transmit frequency (21.025 MHz.)
- 4 Start transmitting while the station is standing by.

PRACTICAL EXAMPLE

You find a DX station operating in simplex, however, you have not yet tuned your antenna (or your linear amplifier), and you do not want to transmit your tuning tone on the DX station's frequency.

- 1 Push [ΔTX] to turn the ΔTX function ON.
- 2 Rotate [RIT/ΔTX] to max. counterclockwise (or clockwise).
- 3 Push [TUNE] to tune your antenna.
 - Or, tune your linear amplifier with key ON in the CW mode.
- 4 Push [ΔTX] to turn the ΔTX function OFF.
- 5 Start transmitting while the station is standing by.

■ VOX operation

The VOX (voice-operated relay) function allows you handsfree transmit/receive switching.

- ① Push the [BK-IN VOX] switch IN.
- ② Rotate the [DELAY] control on the rear panel max. counterclockwise.
- ③ Rotate the [VOX GAIN] control on the rear panel max. counterclockwise.

- ④ While speaking into the microphone, rotate the [VOX GAIN] control clockwise until the transceiver transmits.
- ⑤ Rotate the [DELAY] control to adjust the transmit-to-receive switching delay time.
 - A short transmit-to-receive switching delay time clips your transmitted voice.
- ⑥ While receiving, rotate the [ANTI VOX] control to adjust so that the speaker audio does not activate the VOX.

■ PBT operation

The PBT (passband tuning) function electronically narrows the IF passband width to reduce interference.

NOTE: When PBT is used, the audio tone may be changed. Set the [PBT] control in the center position when there is no interference.

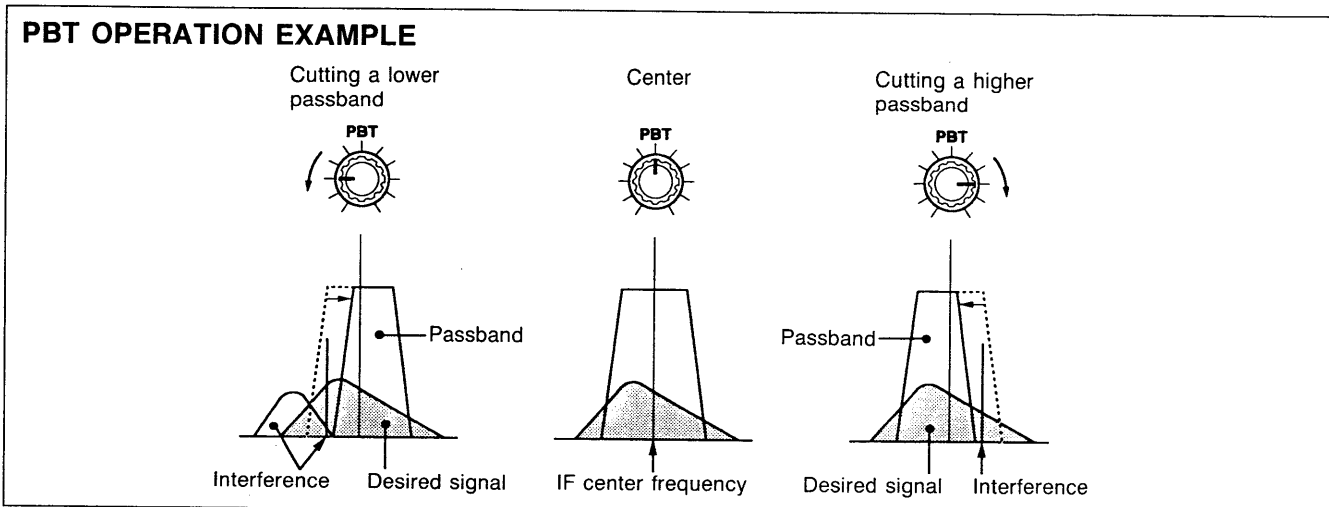

■ Notch operation

The notch function attenuates max. 20 dB at the center of filtering frequency to eliminates unwanted tones in all operating modes.

NOTE: Turn the notch function OFF when there are no unwanted tones.

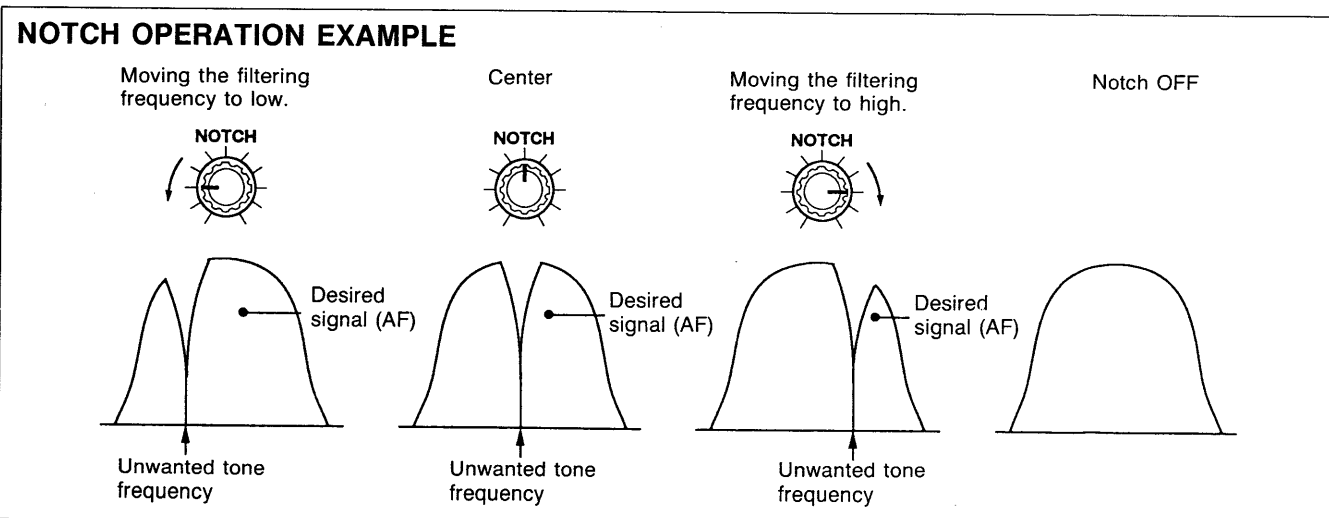

4 FUNCTION OPERATION

■ Set mode operation

The set mode is used for programming infrequently changed values or conditions of functions. This transceiver's set mode has 13 items.

• Set mode operation

- ① Push [POWER] OUT to turn power OFF.
- ② While pushing [FREQ-INP] and [ENT], push [POWER] IN to turn power ON.
 - Now the set mode is selected and one of its items appears.
- ③ Push [UP] or [DOWN] several times until the desired item appears.
- ④ Rotate the main dial to set the values or conditions for the selected item.
- ⑤ Repeat steps ③ and ④ to set other items.
- ⑥ After all items you selected are set, push [POWER] OUT to turn power OFF.
- ⑦ Push [POWER] IN to turn power ON.
 - Now the set values or conditions are effective.

When you want to set an item to the default setting (initialized condition), push [CLEAR] after selecting the desired item.

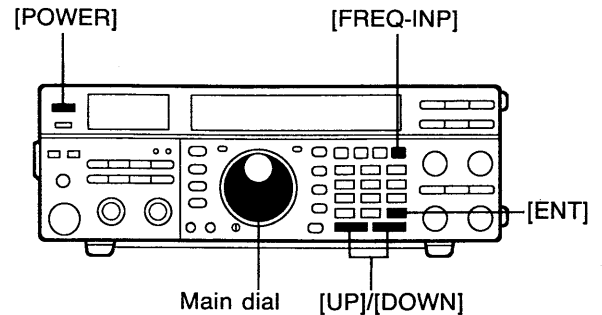

[DISPLAY EXAMPLE IN THE SET MODE]

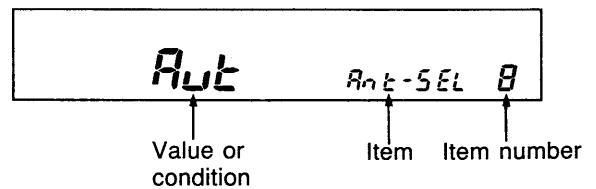

(1) Confirmation beep "bEEP"

A beep sounds each time a switch is pushed to confirm it. This confirmation beep can be turned OFF for silent operation.

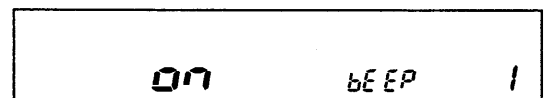

Confirmation beep ON (default)

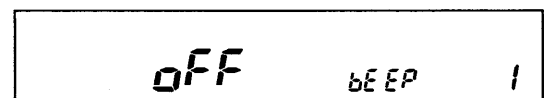

Confirmation beep OFF

(2) Auto tuning step function "tS-Aut"

When selecting AM or FM, the quick tuning step is automatically selected by the auto tuning step function. This function can be turned OFF for your convenience.

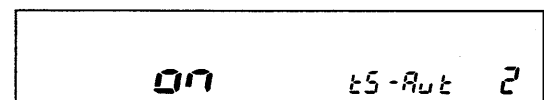

Auto tuning step function ON (default)

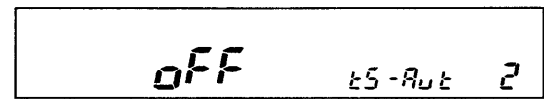

Auto tuning step function OFF

(3) RIT and ΔTX variable range "rit"

You can select ± 1.25 kHz or ± 2.5 kHz for the max. variable range of the RIT and Δ TX function.

When you select 2.5 kHz, you can vary RIT and Δ TX frequency over a large range.

When you select 1.25 kHz, fine tuning the RIT and Δ TX frequency is possible.

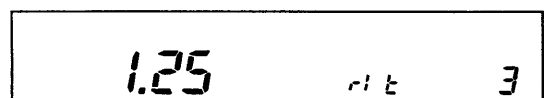

± 1.25 kHz range (default)

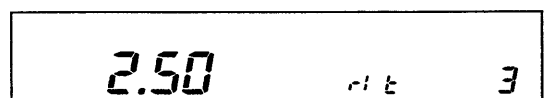

± 2.5 kHz range

(4) Scan resume "SC-rES"

You can select scan resume or cancel for when an operating scan detects a signal.

When selecting resume (ON), the scan pauses 10 sec. on the detected signal, then it resumes. If the signal disappears while the scan is paused, the scan resumes 2 sec. later to search for other signals.

When selecting cancel (OFF), the scan stops and turns OFF after detecting a signal.

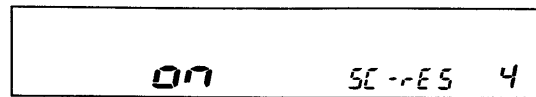

Resume (default)

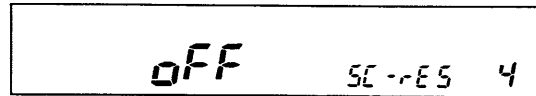

Cancel

(5) Scan speed "SC-SPd"

You can select high or low for the scanning speed.

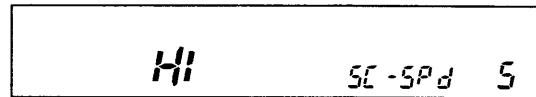

High speed (default)

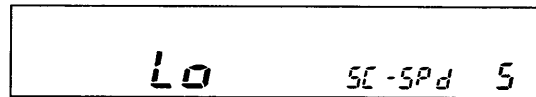

Low speed

(6) Microphone up/down speed "UP-SPd"

When you push and hold the microphone [UP]/[DOWN] switches, you can change the frequency continuously.

You can select high or low speed tuning for the microphone [UP]/[DOWN] switches.



High speed (default)



Low speed

(7) Memo pad capacity "PAAd-CH"

You can select the number of memo pads, 5 or 10, for your convenience.

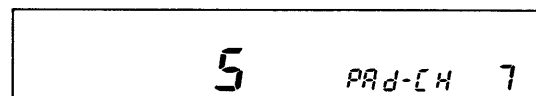

5 memo pads (default)

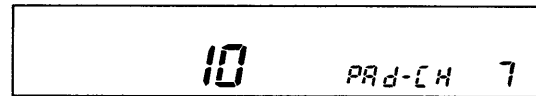

10 memo pads

(8) Antenna switch "Ant SEL"

When you connect 2 antennas to this transceiver, you must activate the antenna switch.

When "oFF" is selected, the [ANT] switch is not activated and does not function.

When "on" is selected, the [ANT] switch is activated and selects an antenna manually.

When "Aut" is selected, the [ANT] switch is activated and the band memory memorizes the selected antenna. See p. 34 for details.

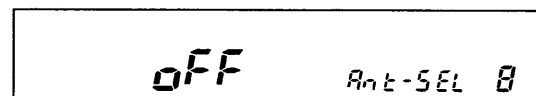

Antenna switch OFF (default)

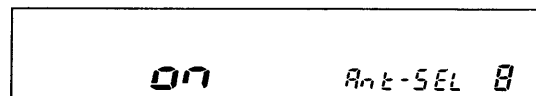

Antenna switch ON

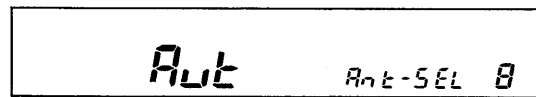

Antenna switch Auto

4 FUNCTION OPERATION

(9) Quick split function "q-SPLIT"

The [SPLIT] switch can be used to set split frequency operation and VFO frequency equalization simultaneously.

When "on" is selected, the [SPLIT] switch equalizes VFO frequencies and operating modes when pushed and held.

When "off" is selected, the [SPLIT] switch cannot equalize VFO frequencies and operating modes.

on q-SPLIT 9

Quick split function ON (default)

off q-SPLIT 9

Quick split function OFF

(10) CI-V address "CI-Addr"

To distinguish equipment, each CI-V transceiver has its own Icom standard address in hexadecimal code. The IC-737A has Icom standard address 3CH.

When 2 or more IC-737A's are connected to an optional CT-17 CI-V LEVEL CONVERTER, rotate the main dial to select a different address for each IC-737A in the range from 01H to 7FH.

3CH CI-Addr 10

Address of 3CH (IC-737A default)

7FH CI-Addr 10

Address of 7FH

(11) CI-V baud rate "CI-bAud"

Baud rate is the data transfer rate. Icom standard baud rate is 1200 bps.

If you want to change the baud rate, rotate the main dial to select the desired baud rate from 300, 1200, 4800 or 9600 bps. Each CI-V equipment's baud rate **MUST** be equal.

1200 CI-bAud 11

1200 bps (CI-V standard, default)

9600 CI-bAud 11

9600 bps

(12) CI-V transceive "CI-trn"

Transceive operation is possible with the IC-737A connected to other Icom HF transceivers or receivers.

When "on" is selected, changing the operating frequency, operating mode, etc. on the IC-737A automatically changes those of connected transceivers (or receivers) and vice versa.

on CI-trn 12

Transceive ON (default)

off CI-trn 12

Transceive OFF

(13) CI-V operating frequency data length "CI-731"

When connecting the IC-737A to the IC-735 for transceive operation, you must change the operating frequency data length to 4 bytes.

- This setting **MUST** be set "on" only when operating transceive with the IC-735.

When "off" is selected, the operating frequency data length is sent in 5 bytes.

When "on" is selected, the operating frequency data length is sent in 4 bytes.

off CI-731 13

5 bytes of frequency data (default)

on CI-731 13

4 bytes of frequency data

■ Band memory (for automatic antenna selection)

The IC-737A covers 0.5~30 MHz with 13 bands. Each band has a band memory which can memorize a selected [ANT 1] or [ANT 2] connector. When you change the operating frequency beyond a band, the previously used antenna connector is automatically selected for the new band. This function is convenient when you use 2 antennas.

To use the band memory, enter the set mode and select "Aut" in the antenna switch item (item number 8 on p. 32).

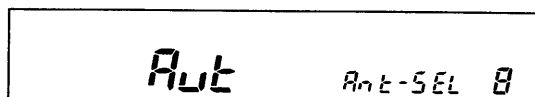

- When "off" is selected, the [ANT] switch does not function.
- When "on" is selected, you can use the [ANT] switch, however, band memory does not function. In this case, you must select an antenna manually.

When "Aut" is selected, the antenna tuner ON/OFF condition is consistent with the [ANT] switch.

BAND	FREQUENCY RANGE	HAM BAND
1	0.5~1.59999 MHz	
2	1.6~1.99999 MHz	160 m band
3	2.0~2.99999 MHz	
4	3.0~3.99999 MHz	80 m band
5	4.0~5.99999 MHz	
6	6.0~7.99999 MHz	40 m band
7	8.0~10.99999 MHz	30 m band
8	11.0~13.99999 MHz	
9	14.0~14.99999 MHz	20 m band
10	15.0~20.99999 MHz	17 m band
11	21.0~21.99999 MHz	15 m band
12	22.0~24.99999 MHz	12 m band
13	25.0~30.00000 MHz	10 m band

As all ham bands are separated as shown above, you can designate [ANT 1] or [ANT 2] connector individually for each ham band.

[ANTENNA SWITCH SELECTION EXAMPLE]

Under the following conditions, "Aut" should be selected in the antenna switch set mode item.

- When you use 2 antennas.
- When you use an optional AH-3 HF AUTOMATIC ANTENNA TUNER and a 50 Ω antenna.

Under the following conditions, "off" should be selected in the antenna switch set mode item.

- When using 1 antenna.
- When using a linear amplifier.
- When using the EX-627 HF AUTOMATIC ANTENNA SELECTOR for more than 3 antenna connections.
- When using the AT-150 or IC-AT500 HF AUTOMATIC ANTENNA TUNER.

■ Remote jack (CI-V) information

The IC-737A can be connected through an optional CT-17 CI-V LEVEL CONVERTER to a personal computer equipped with an RS-232C port. Icom Communication Interface-V (CI-V) controls frequency, operating mode, memory channels, etc.

Up to four Icom CI-V transceivers or receivers can be connected to a personal computer equipped with an RS-232C port.

See the page at left for setting the CI-V condition. (Set mode items No. 10~No. 13)

To control the transceiver, see the CT-17 instruction manual or CI-V reference manual for details.

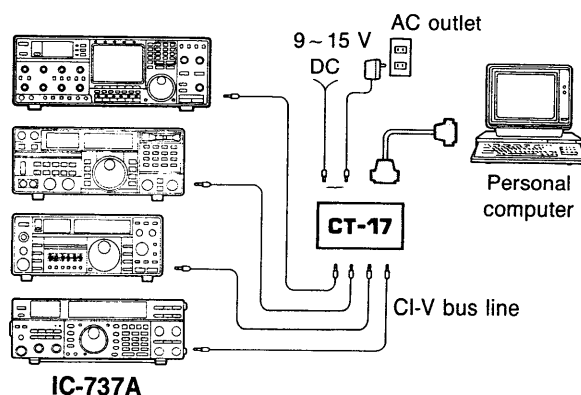

■ Antenna tuner operation

The internal automatic antenna tuner matches the IC-737A to the connected antenna automatically. Once the tuner matches an antenna, the variable capacitor angles are memorised as a preset point for each band (p. 34). Therefore, when you change the band, the variable capacitors are automatically preset for the newly selected band. This shortens the tuning period.

CAUTION: NEVER transmit with the tuner ON when no antenna is connected. This will damage the transceiver. Be careful of the antenna switch ([ANT]) selection.

NOTE: The automatic antenna tuner in the IC-737A passes the transmitted signal through the tuning circuit of course, however, received signals from an antenna connector bypass the tuning circuit.

Turn the tuner ON and OFF

Push [TUNER] to pass the transmit signal through the tuner (tuner ON) or to bypass the transmit signal around the tuner (tuner OFF).

- When the tuner is ON, the tuner automatically presets for the band, "TUNE" appears and the red indicator on the [TUNER] switch lights.
- When the tuner is OFF, "THRU" appears.

When you start transmitting with the tuner ON, the tuner automatically performs fine tuning in a very short period.

- "TUNE" blinks while tuning.
- "TUNE" continuously lights when tuning is complete.

If the "TUNE" indicator continues to blink after more than 30 sec., the tuner cannot tune the connected antenna. In this case, stop transmission; then, push [TUNER] to turn the tuner OFF.

- Check the antenna connection.
- Check the antenna and feed line.
- Check the antenna selection.

NOTE: If the "Antenna switch" item in the set mode is set to "Aut," the tuner ON/OFF condition is consistent with the antenna switch ([ANT]) selection.

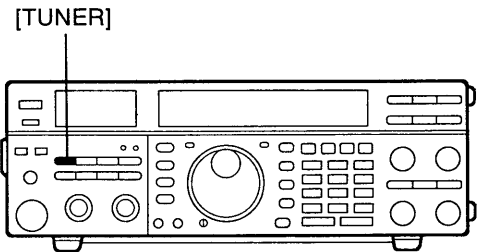

"TUNE" lights.



Tuner ON

"TUNE" blinks. "CW" or "CW-N" appears.



While tuning

"THRU" lights.



Tuner OFF

Manual tuning start

To tune the antenna manually, push [TUNE].

- The tuner starts tuning in CW mode.
- "TUNE" blinks and a side tone sounds while tuning.
- "TUNE" continuously lights and the side tone stops sounding when tuning is complete, then the previous mode is re-selected.
- Outside of the ham bands, tuning is not performed even if you push [TUNE].

If the tuner cannot tune the antenna after 20 sec., the tuner is automatically bypassed and "THRU" appears.

- Check the antenna connection.
- Check the antenna and feed line.
- Check the antenna selection.

[TUNE]

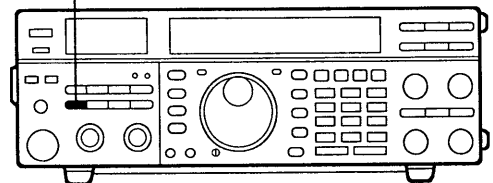

Optional external antenna tuner operation

AH-3 HF AUTOMATIC ANTENNA TUNER

The AH-3 matches the IC-737A to a long wire antenna more than 3 m/10 ft long (3.5 MHz and above) or more than 12 m/40 ft long (1.8 MHz and above).

- See p. 15 for the transceiver and AH-3 connection.
- See the AH-3 instruction manual for AH-3 installation and antenna connection details.
- See p. 58 for AH-3 and AH-2b details.

AH-3 setting example:

For mobile operation

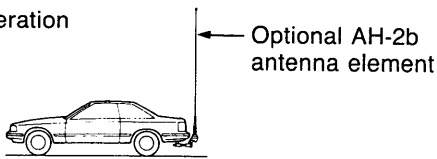

For outdoor operation

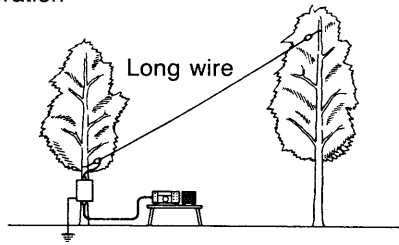

WARNING: HIGH VOLTAGE!

NEVER touch the antenna element while tuning or transmitting.

CAUTION: Make sure the antenna switch selection is [ANT 1]. If "Aut" has been selected at the antenna switch item in the set mode (p. 32), the previously used antenna connector is selected when changing operating band.

NEVER operate the AH-3 without an antenna wire. The tuner and transceiver will be damaged.

NEVER operate the AH-3 when it is ungrounded.

Transmitting before tuning or transmitting while the "THRU" indicator lights may damage the transceiver.

NOTE: When connecting the AH-3, the internal antenna tuner is bypassed for the antenna 1 connector ([ANT 1]) even when [TUNER] is pushed.

AH-3 operation

Tuning is necessary for each frequency. **Be sure** to re-tune the antenna before transmitting when you change the operating frequency, even a little bit.

- ① Select antenna 1 with [ANT] if you connect the AH-3 and another antenna.
 - "EXT" appears.



- ② Set the desired frequency in a ham band.
 - The AH-3 will not operate on frequencies outside of ham bands.

- ③ Push [TUNE] or [TUNER].

- "TUNE" blinks and "CW" appears while tuning.

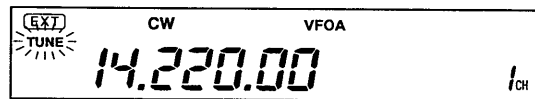
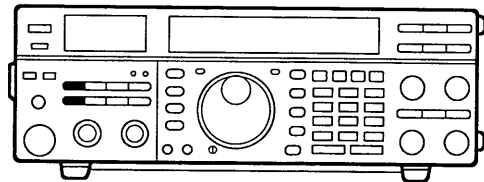

- ④ - "TUNE" lights constantly when tuning is complete.



- "THRU" appears when the AH-3 cannot tune the connected antenna wire after 20 sec.



- When "THRU" appears, the AH-3 is bypassed and the antenna wire is connected to the antenna connector on the transceiver directly.

To bypass the AH-3 manually, push [TUNER].

- "THRU" appears.

AT-150 AUTOMATIC ANTENNA TUNER IC-AT500 AUTOMATIC ANTENNA TUNER

At first, tune the antenna with the external antenna tuner, AT-150 or IC-AT500; then, when required, turn the internal antenna tuner ON.

NEVER turn the internal antenna tuner ON, until the external antenna tuner finishes tuning the antenna.

We recommend using the [ANT 1] connector with the antenna select switch in set mode item set to "OFF."

See the instruction manual included with each antenna tuner for their respective operations.

Memory channels

The IC-737A has 101 memory channels. The memory mode is very useful for quickly changing to often used frequencies.

All 101 memory channels are tunable which means the programmed frequency can be tuned temporarily with the main dial, etc. in the memory mode.

Memory channels 1 ~ 89 can be programmed with one frequency and one mode each. Memory channels 90 ~ 99, P1 and P2 also have special functions described in the table below.

MEMORY CHANNEL	MEMORY CHANNEL NUMBER	CAPABILITY	TRANSFER TO VFO	OVER-WRITING	CLEAR
Regular memory channels	1 ~ 89	One frequency and one mode in each memory channel.	Yes	Yes	Yes
Split memory channels	90 ~ 99	Independent transmit and receive frequencies and operating modes in each channel for split frequency operation.	Yes	Yes	Yes
Scan edge memory channels	P1, P2	One frequency and one mode in each memory channel as scan edges for programmed scan.	Yes	Yes	No

Memory channel selection

- ① Push [VFO/MEMO] to select the memory mode.
 - "MEMO" appears.
- ② Rotate [M-CH] to select the desired memory channel.
 - [UP] and [DN] on the microphone also select memory channels.
- ③ To return to the VFO mode, push [VFO/MEMO] again.

[EXAMPLE] : Selecting memory channel 17.

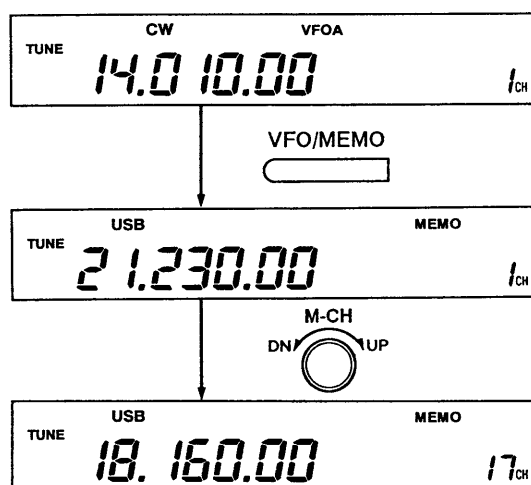

Memory channel programming

Memory channel programming can be performed either in the VFO mode or in the memory mode.

Programming in the VFO mode

- ① Set the desired frequency and operating mode in the VFO mode.
- ② Rotate [M-CH] to select the desired memory channel to be programmed.
 - To confirm the memory channel contents, push [VFO/MEMO]; then push [VFO/MEMO] again to return to the VFO mode.
 - “[BLANK]” appears if the selected memory channel is a blank channel (and does not have contents).
- ③ Push and hold [MW] for 1 sec. to program the displayed frequency and operating mode into the memory channel.

To check the programmed contents, push [VFO/MEMO] to select the memory mode.

[EXAMPLE]: Programming 7.088 MHz/LSB into memory channel 12.

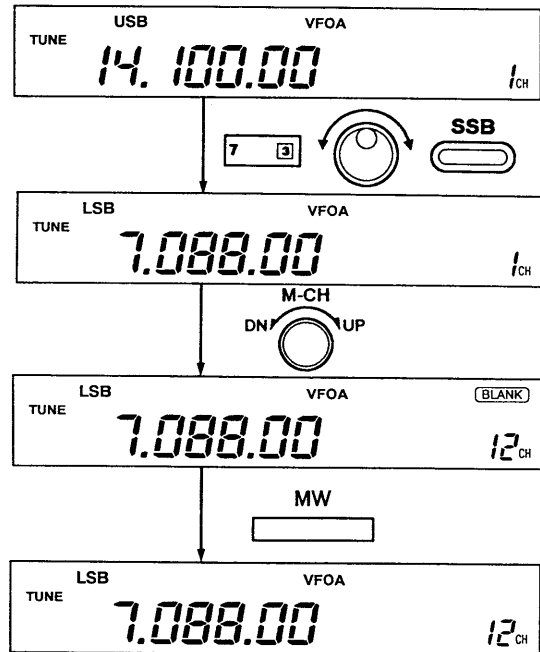

Programming in the memory mode

- ① Select the desired memory channel to be programmed with [M-CH] in the memory mode.
- ② Set the desired frequency and operating mode in the memory mode.
 - To program a blank channel, use direct frequency entry with the keypad. (p. 22)
- ③ Push and hold [MW] for 1 sec. to program the displayed frequency and operating mode into the memory channel.

[EXAMPLE]: Programming 21.280 MHz/USB into memory channel 18.

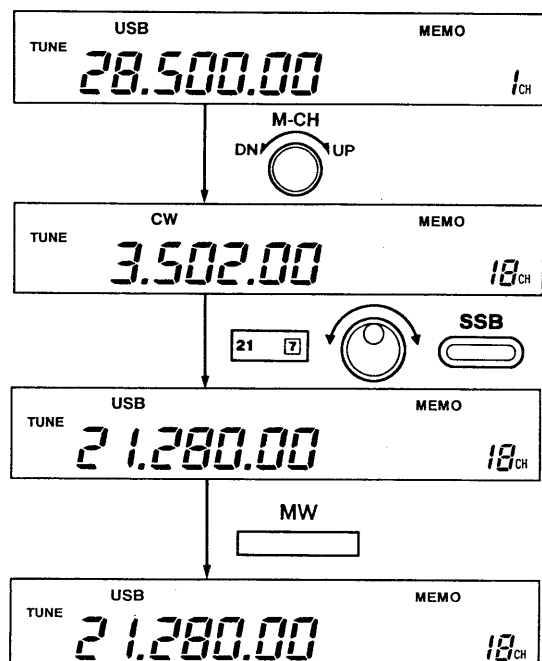

5 MEMORY CHANNELS

■ Frequency transferring

The frequency and operating mode in a memory channel can be transferred to a VFO.

The frequency transferring can be performed in either the VFO mode or in the memory mode.

• Transferring in the VFO mode

This is useful for transferring programmed contents to VFO.

- ① Select VFO A or VFO B with [A/B] in the VFO mode.
- ② Select a memory channel with [M-CH].
 - To confirm the memory channel contents, push [VFO/MEMO]; then push [VFO/MEMO] again to return to the VFO mode.
 - “(BLANK)” appears if the selected memory channel is a blank channel (and does not have contents). In this case transferring is impossible.
- ③ Push and hold [M▶VFO] for 1 sec. to transfer the frequency and operating mode.
 - Transferred frequency and operating mode appear on the display.

TRANSFERRING EXAMPLE IN THE VFO MODE

Operating frequency : 21.320 MHz/USB (VFO A)
Contents of MEMO 16 : 14.020 MHz/CW

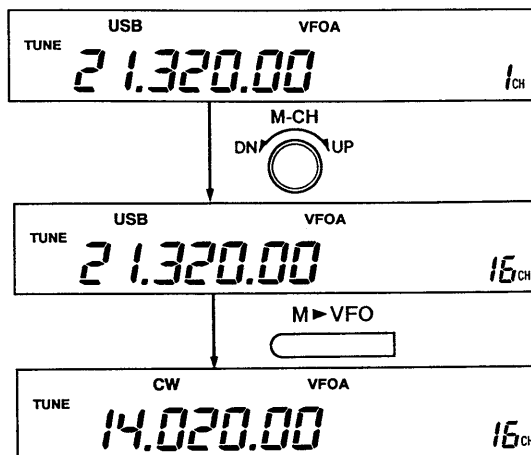

• Transferring in the memory mode

This is useful for transferring frequency and operating mode while operating in the memory mode.

NOTE: When you have changed the frequency or operating mode in the selected memory channel:

- **Displayed** frequency and mode are transferred.
- **Programmed** frequency and mode are not transferred, and they remain in the memory channels.

- ① Select a memory channel with [M-CH] in the memory mode.
 - And, set the frequency or operating mode if required.
- ② Push and hold [M▶VFO] for 1 sec. to transfer the frequency and operating mode.
 - Displayed frequency and operating mode are transferred to the previously used VFO.
- ③ To return to the VFO mode, push [VFO/MEMO].

TRANSFERRING EXAMPLE IN THE MEMORY MODE

Operating frequency : 14.028 MHz/CW (MEMO 19)
Previously used VFO : VFO A

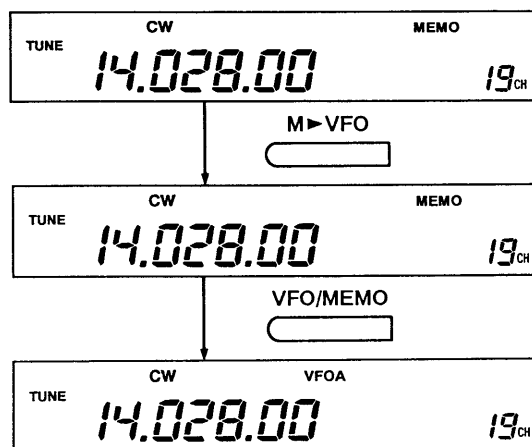

■ Memory clearing

Any unnecessary memory channels can be cleared. The cleared memory channels become blank channels.

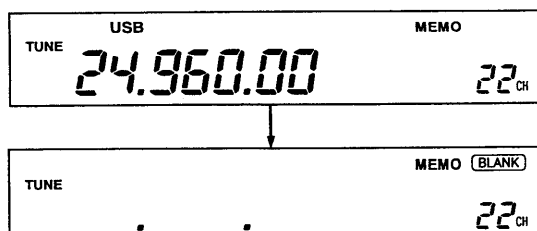

- ① Select the memory mode with [VFO/MEMO].
- ② Select a memory channel to be cleared with [M-CH].
- ③ Push and hold [CLEAR] for 1 sec. to clear the contents.
 - The programmed frequency and operating mode disappear and “(BLANK)” appears.
- ④ To clear other memory channels, repeat steps ② and ③.

■ Split memory channels (for accessing a repeater)

Memory channels 90~99 are split memory channels and can be programmed for both transmit and receive frequencies and operating modes.

These memory channels are especially useful for repeater operation.

• Split memory channel selection

Select a memory channel in the range between 90~99 with [M-CH] in the memory mode.

- “**[SPLIT]**” and 2 frequencies appear if split frequencies have been programmed in that channel.
- “**[SPLIT]**” does not appear if only 1 frequency has been programmed in that channel.
- “**[BLANK]**” appears if the selected memory channel is a blank channel (and does not have contents).

[SPLIT MEMORY CHANNEL DISPLAY EXAMPLE]



Split frequencies are programmed.



Simplex frequency is programmed.

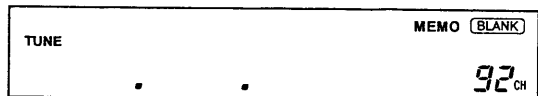

No frequency is programmed.

• Split memory channel programming

2 frequencies can be programmed in a split memory channel when “**[SPLIT]**” and sub VFO frequencies are indicated on the function display.

Following is a programming example of 29.680 MHz/FM for receiving and 29.580 MHz/FM for transmitting in memory channel 95.

- ① Select VFO mode with [VFO/MEMO].
 - Both VFO A and VFO B can be used.

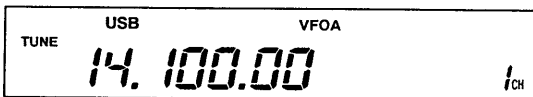

- ② Set 29.680 MHz (RX freq.).

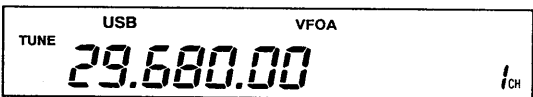

- ③ Select FM mode with [FM/TONE].

• A subaudible tone can be programmed if you install an optional UT-30 PROGRAMMABLE TONE ENCODER UNIT. To program subaudible tone information, select “FM-T” by pushing [FM/TONE] twice.



- ④ Push and hold [SPLIT] for 1 sec.
 - When the quick split function is OFF (p. 33), push [SPLIT]; then, push and hold [A=B] for 1 sec.

Sub VFO frequency and “**[SPLIT]**” appear.



- ⑤ While pushing [XFC] rotate the main dial to set the sub VFO frequency to 29.580 MHz (TX freq.).



- ⑥ Select memory channel 95 with [M-CH] in the VFO mode.



- ⑦ Push and hold [MW] for 1 sec. to program the frequencies.



To check the programmed contents, push [VFO/MEMO] to select the memory mode.



5 MEMORY CHANNELS

• Split memory channel operation

When one of the memory channels 90 ~ 99 is selected and the memory channel has been programmed with 2 frequencies, split frequency operation is automatically selected.

- ① Select the memory mode.
- ② Select a programmed split memory channel.
- ③ Transmit.
 - “▶” appears while transmitting.
- ④ Return to receive.
 - “▶” disappears while receiving.

When “FM-T” is programmed as an operating mode in the memory channel, a subaudible tone is automatically superimposed over your transmission.

- An optional UT-30 is necessary to generate a tone.

- To exchange the transmit and receive frequencies, push [A/B].
- To monitor the transmit frequency, push and hold [XFC].
- To turn the split frequency operation OFF, push [SPLIT].

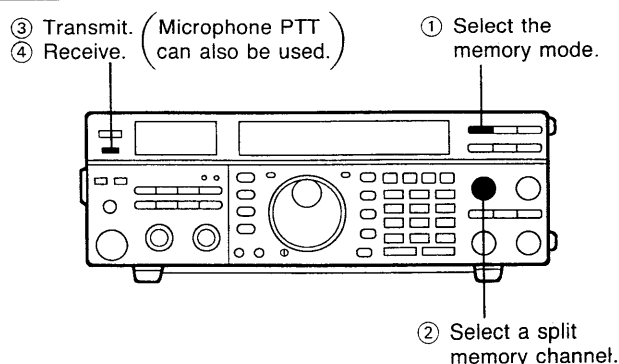

[DISPLAY EXAMPLE]

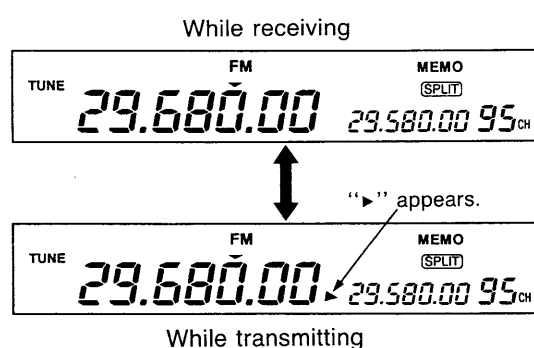

• Split frequency transferring

The split frequency data in split memory channels can be transferred into a VFO. Transferring split memory channels is different in the VFO mode and the memory mode.

- When the selected memory channel has been programmed with only 1 frequency and 1 mode, transferring is the same as transferring from a regular memory channel. (p. 39)

IN THE MEMORY MODE

In the memory mode, 2 frequencies and modes with “**SPLIT**” information are transferred.

- ① Select a programmed split memory channel with [M-CH] in the memory mode.
- ② Push and hold [M▶VFO] for 1 sec. to transfer the frequencies and operating mode.
 - Displayed frequencies, operating mode and “Split ON” are transferred to VFOs.
- ③ To return to the VFO mode, push [VFO].

[DISPLAY EXAMPLE]

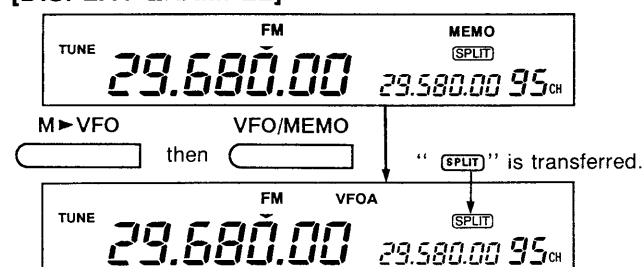

IN THE VFO MODE

In the VFO mode, only the receive frequency and operating mode are transferred.

- ① Select VFO A or VFO B with [A/B] in the VFO mode.
- ② Select a programmed split memory channel with [M-CH].
 - To confirm the memory channel contents, push [VFO/MEMO]; then push [VFO/MEMO] again to return to the VFO mode.
- ③ Push and hold [M▶VFO] for 1 sec. to transfer the receive frequency and operating mode.

[DISPLAY EXAMPLE]

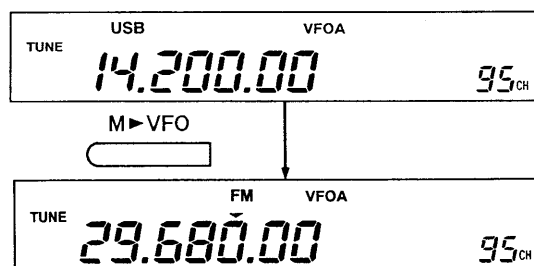

NOTE: When the split function is turned ON before pushing [M▶VFO], you can transfer 2 frequencies and modes into the VFOs.

■ Scan edge memory channels

Memory channels P1 and P2 are scan edge memory channels. These memory channels are used to program scan edge frequencies for programmed scan. (p. 44)

Scan edge memory channels can be programmed for 1 frequency and 1 operating mode like regular memory channels. However, memory clearing is impossible. Only overwriting is possible for scan edge memory channels.

• Scan edge memory channel selection

- ① Push [VFO/MEMO] to select the memory mode.
 - "MEMO" appears.
- ② Rotate [M-CH] to select the desired scan edge memory channel.
 - [UP] and [DN] on the microphone also select memory channels.
- ③ To return to the VFO mode, push [VFO/MEMO] again.

You can transmit and receive using the programmed frequency and operating mode in the scan edge memory channels.

[EXAMPLE] : Selecting scan edge memory channel P1.

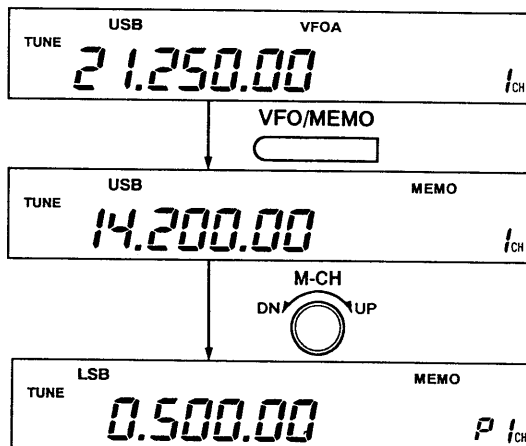

• Scan edge memory channel programming

A scan edge memory channel can be programmed in either the VFO or memory mode the same way as regular memory channel programming.

Following is an example of programming 28.000/28.050 MHz into scan edge memory channels P1/P2 in the VFO mode.

- ① Set 28.000 MHz in the VFO mode.
 - An operating mode can also be programmed, however, the programmed operating mode does not affect programmed scan.



- ② Rotate [M-CH] to select the scan edge memory channel P1.

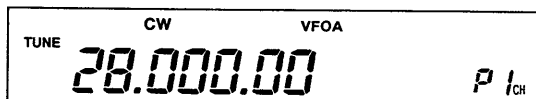

- ③ Push and hold [MW] for 1 sec. to program 28.000 MHz into the scan edge memory channel P1.



- ④ Change the displayed frequency to 28.050 MHz.

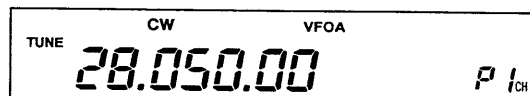

- ⑤ Rotate [M-CH] to select the other scan edge memory channel, P2.

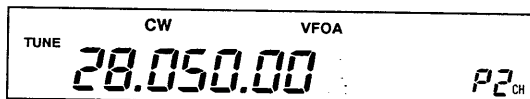

- ⑥ Push and hold [MW] for 1 sec. to program 28.050 MHz into the scan edge memory channel P2.



To check the programmed contents, push [VFO/MEMO] to select the memory mode, then select P1 or P2 with [M-CH].

■ Scan types

The IC-737A has 3 types of scan functions which provide tremendous scanning versatility at the touch of a few switches.

Select the scan which matches your operating needs.

PROGRAMMED SCAN

Repeatedly scans between two scan edge frequencies (scan edge memory channels P1 and P2).

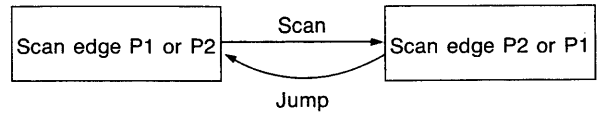

This scan operates in the VFO mode.

MEMORY SCAN

Repeatedly scans all programmed memory channels.

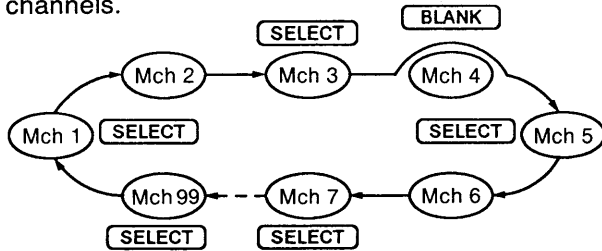

This scan operates in the memory mode.

SELECTED MEMORY SCAN

Repeatedly scans all selected memory channels.

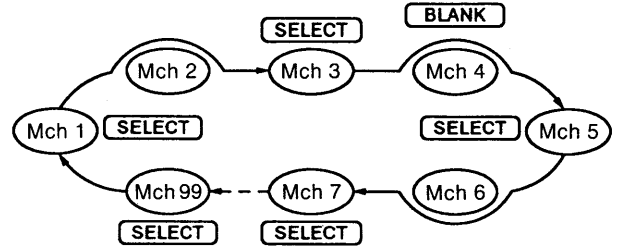

This scan operates in the memory mode.

■ Pre-operation

• Presetting

Program the memory channels before operating a scan as follows:

SCAN TYPE	REQUIRED PRE-OPERATION
PROGRAMMED SCAN	Program scan edge frequencies into scan edge memory channels P1 and P2. (p. 42)
MEMORY SCAN	Program desired scan frequencies into 2 or more memory channels.
SELECTED MEMORY SCAN	Designate 2 or more memory channels as selected memory channels with the [SEL] switch.

• Scan resume ON/OFF

You can select the scan to resume or cancel when detecting a signal. Scan resume ON/OFF must be set before operating scan. See p. 32 for ON/OFF setting and scan resume condition details.

• Squelch condition

Before starting a scan, open or close the squelch as described below.

SCAN STARTS WITH	PROGRAMMED SCAN	MEMORY SCAN
SQUELCH OPEN	The scan continues until it is stopped manually, and does not pause even if it detects signals.	Not applicable.
SQUELCH CLOSED	The scan is stopped when it detects signals. If you set the scan resume "ON" in the set mode, the scan pauses for 10 sec. when it detects signals, then resumes. When a signal disappears while scan is paused, it resumes 2 sec. later.	

• Scan speed

Scan speed can be selected from 2 levels, high or low, in the set mode. See p. 32 for details.

Programmed scan operation

- ① Select the VFO mode.
- ② Select the desired operating mode.
 - The operating mode can be changed even while scanning.
- ③ Set [SQL] open or closed.
 - See page at left for scan condition.
- ④ Push [SCAN] to start the scan.
 - Decimal points blink while scanning.
- ⑤ When the scan detects a signal, the scan stops, pauses or ignores it depending on the resume setting and the squelch condition.
 - During scan the [TS] switch can be used.
- ⑥ To cancel the scan, push [SCAN].

NOTE: If the same frequencies are programmed into the scan edge memory channels P1 and P2, programmed scan does not start.

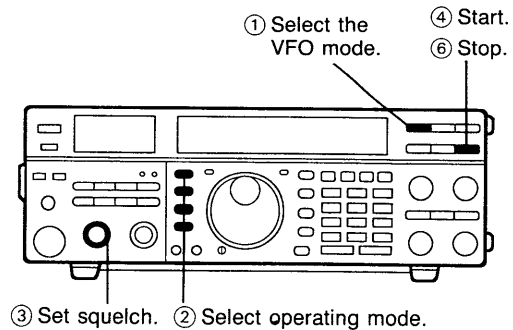

[DISPLAY EXAMPLE DURING THE SCAN]

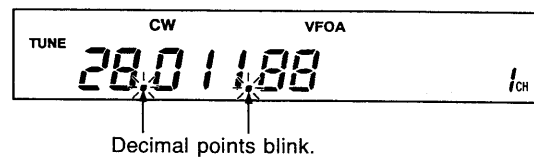

Memory scan operation

- ① Select the memory mode.
- ② Close the squelch with [SQL].
- ③ Push [SCAN] to start the scan.
 - Decimal points blink while scanning.
- ④ When the scan detects a signal, the scan stops or pauses depending on the scan resume setting.
- ⑤ To cancel the scan, rotate the main dial, or push [SCAN].

NOTE: 2 or more memory channels must be programmed for memory scan to start.

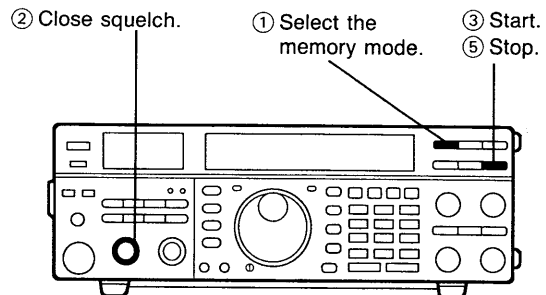

Selected memory scan operation

- ① Select the memory mode.
- ② Close the squelch with [SQL].
- ③ Push [SCAN] to start the memory scan.
 - Decimal points blink while scanning.
- ④ Push [SEL] to activate the selected memory scan.
 - "[SELECT]" continuously lights during selected memory scan.
- ⑤ When the scan detects a signal, the scan stops or pauses depending on the scan resume setting.
- ⑥ To cancel the scan, rotate the main dial, or push [SCAN].

NOTE: 2 or more memory channels must be designated as selected memory channels for selected memory scan to start.

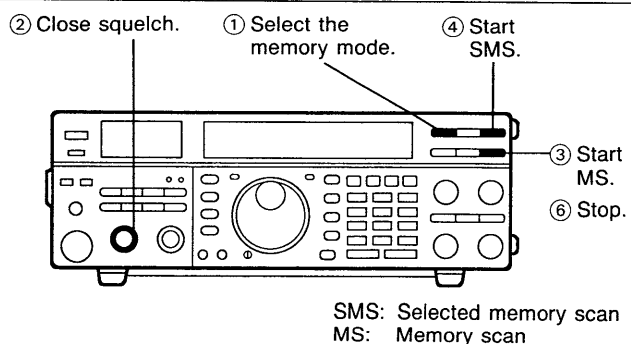

[DISPLAY EXAMPLE DURING THE SCAN]

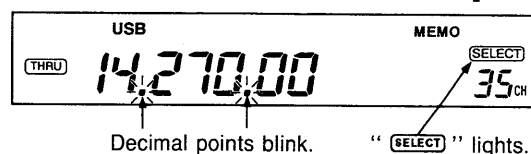

■ Disassembling the transceiver

Follow the transceiver disassembly procedures shown here when you want to install an optional unit, adjust the internal units, or to replace an internal fuse, etc.

CAUTION: DISCONNECT the DC power cable from the transceiver before performing any work on the transceiver.

Ⓐ REMOVING COVERS

To remove top and bottom covers, unscrew the 19 screws as shown in the figure below.

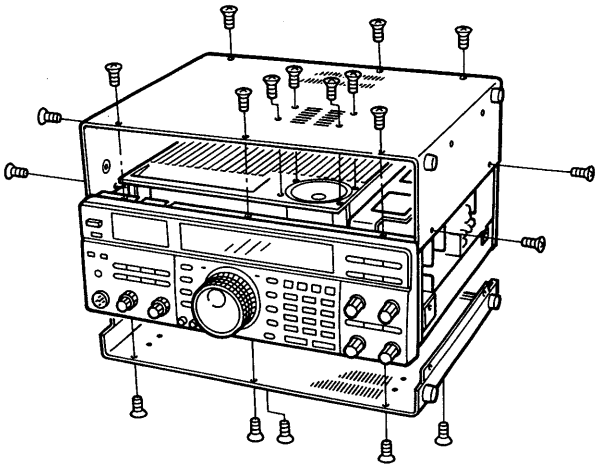

Ⓑ PREPARING FOR THE PA UNIT REMOVAL-1

Unscrew the 9 screws as shown in the figure below.

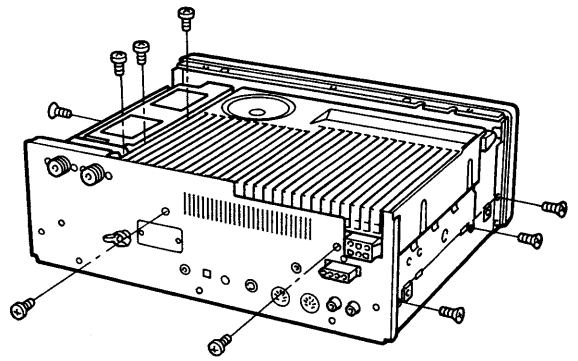

Ⓒ PREPARING FOR THE PA UNIT REMOVAL-2

- ① Disconnect the coaxial cable from J11.
- ② Disconnect the 7-pin connector from J34.
- ③ Disconnect the 3-pin connector from J13.

- ④ Disconnect the coaxial cable from J20 on the tuner unit as shown in the figure below.

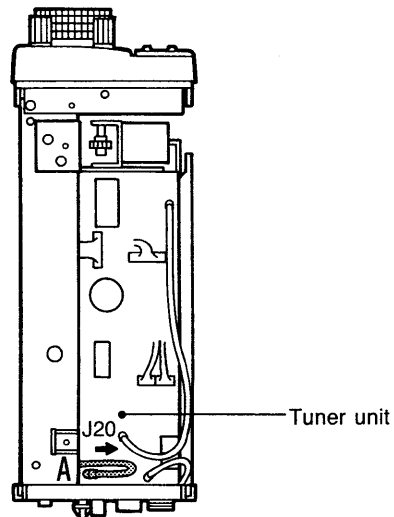
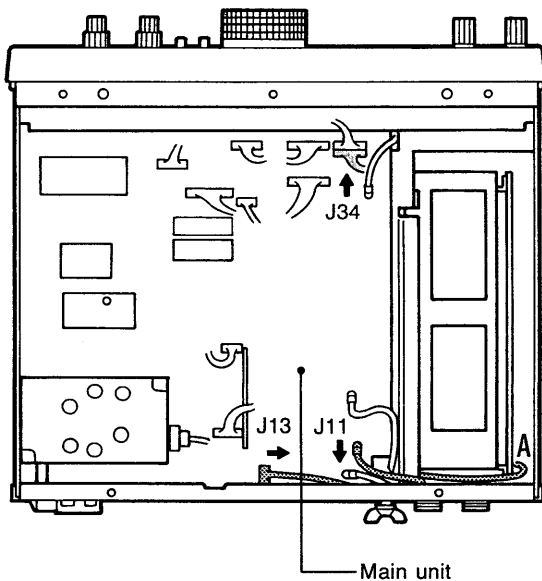

D REMOVING THE PA UNIT

- ① Pull the front unit forward.
- ② Disconnect the 6-pin plug from P13.
- ③ Disconnect the 3-pin plug from Q1.
- ④ Disconnect the 4-pin plug from J2.
- ⑤ Remove the PA unit as shown in the figure below.

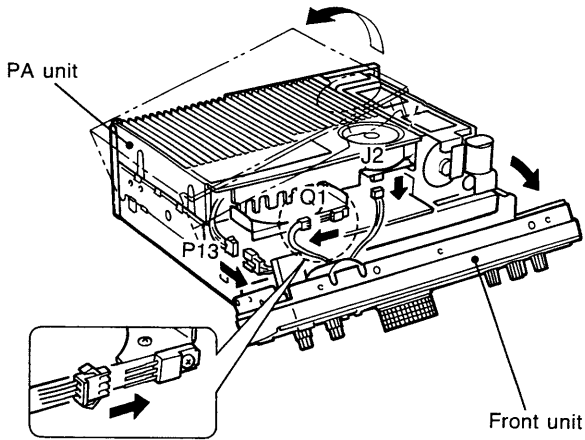

Pay attention to connector orientation when reconnecting to Q1.

E OPENING THE PA UNIT

- ① Remove the PA unit as shown in the box at left.
- ② Unscrew the 16 screws to remove the PA unit shield cover as shown in the figure below.

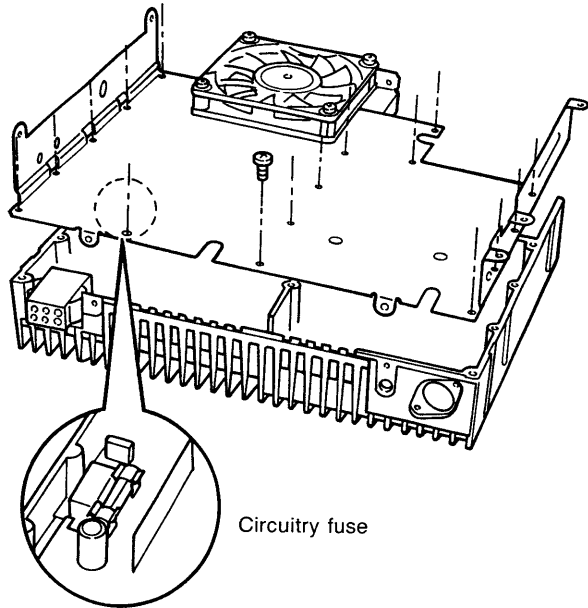

Circuitry fuse

F PREPARING FOR THE PLL UNIT REMOVAL

Disconnect the 2 coaxial cables from J4 and J5.

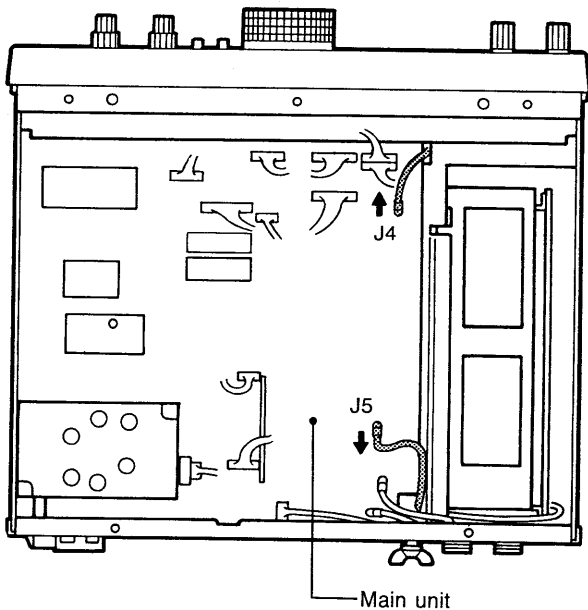

■ Fuse replacement

If a fuse blows or the transceiver stops functioning, try to find the source of the problem, and replace the damaged fuse with a new, rated fuse.

CAUTION: DISCONNECT the DC power cable from the transceiver when changing a fuse.

The IC-737A has 2 types of fuses installed for transceiver protection.

- DC power cable fuses 20 A
- Circuitry fuse F. G. M. B. 125 V, 4 A

DC POWER CABLE FUSE REPLACEMENT

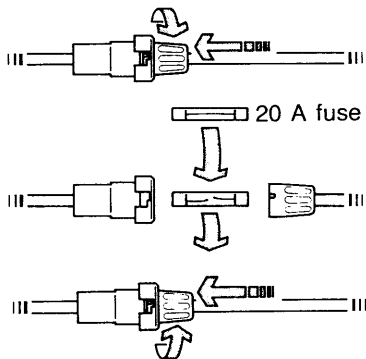

CIRCUITRY FUSE REPLACEMENT

The 13.8 V DC from the DC power cable is applied to all units in the IC-737A, except for the power amplifier, through the circuitry fuse. This fuse is installed in the PA unit.

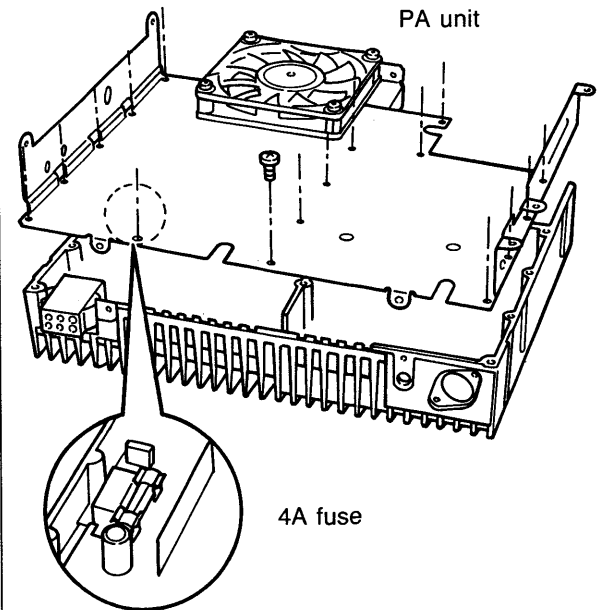

■ CPU backup batteries

The IC-737A has 2 lithium backup batteries on the logic and tuner units for retaining memory information. The usual life of a backup battery is approximately 5 years.

When the backup battery on the PLL unit is exhausted, the transceiver transmits and receives normally but cannot retain memory information. When the backup battery on the tuner unit is exhausted, the antenna tuner cannot memorize the preset point, resulting in long tuning times.

CAUTION: Backup batteries should be replaced by an authorized Icom Dealer or Service Center.

BACKUP BATTERY ON THE LOGIC UNIT

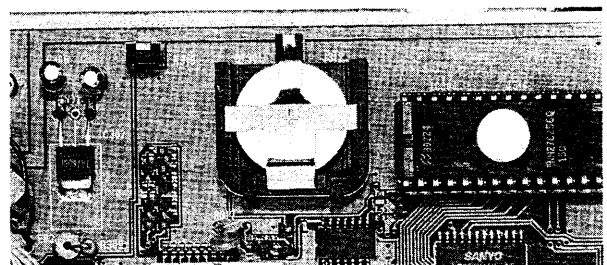

■ Cleaning

If the transceiver becomes dusty or dirty, wipe it clean with a dry, soft cloth.

AVOID the use of strong chemical solvents such as thinner, benzene or alcohol to clean the cabinet, as they may damage the transceiver's surfaces.

Frequency calibration (approximate)

A very accurate frequency counter is required to calibrate the frequency of the IC-737A. However, a rough check may be performed by receiving radio station WWV, or other standard frequency signals.

The calibration can be performed in each operating mode. The calibration range is ± 1.25 kHz in 10 Hz step.

CAUTION: Your IC-737A has been thoroughly adjusted and checked at the factory before being shipped. You should not calibrate the frequency, except for special reasons.

- ① Set the displayed frequency to 10.000.00 MHz/USB or 15.000.00 MHz/USB to receive a standard frequency station.
 - Other standard frequencies can also be used.
- ② Turn the transceiver power OFF.
- ③ While pushing and holding [RIT] and [ENT], turn power ON.

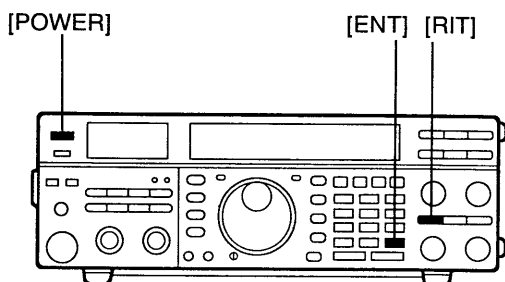

- ④ Release [RIT] and [ENT].
 - “RIT” and “ΔTX” blink, and the calibration mode is selected.



- ⑤ Rotate the [RIT/ΔTX] control for a zero beat.
- ⑥ Push and hold [MW] for 1 sec. to memorize the USB calibration value.
- ⑦ Push [SSB] to select LSB.
- ⑧ Rotate the [RIT/ΔTX] control for a zero beat.
- ⑨ Push and hold [MW] for 1 sec. to memorize the LSB calibration value.
- ⑩ Push [CW/N] to select CW.
- ⑪ Rotate the [RIT/ΔTX] control for a zero beat.
- ⑫ Push and hold [MW] for 1 sec. to memorize the CW calibration value.
- ⑬ Push [RIT] or [Δ/TX] to exit the calibration mode.
 - “RIT” and “ΔTX” disappear.



- Calibration for AM or FM can also be performed, but an accurate frequency counter is necessary.
- The calibrated values are effective after exit from the calibration mode.
- To clear the calibrated values, push and hold [CLEAR] for 1 sec. in the calibration mode.
 - The calibrated values are cleared and all values return to the default settings.

Main dial brake adjustment

The tension of the main dial may be adjusted to suit your preference.

The brake adjustment screw is located on the lower left side of the main dial. See the figure at right.

Turn the brake adjustment screw clockwise or counterclockwise to a comfortable tension level while turning the main dial continuously and evenly in one direction.

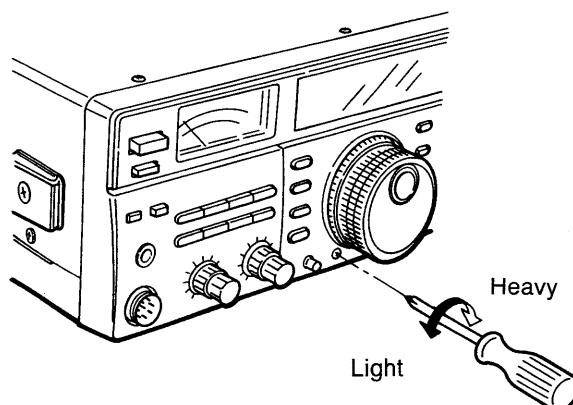

■ CW side tone level preset

CW side tone output can be controlled by [AF GAIN]. If you want to change the basic CW side tone level, perform the procedure described at right.

- ① Remove the top and bottom covers. (p. 45)
- ② Adjust R238 as shown in the diagram at left.
- ③ Replace the top and bottom covers.

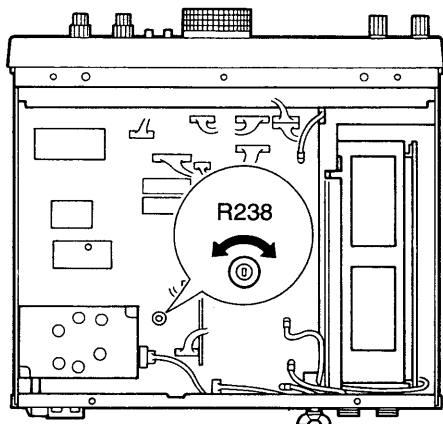

■ BFO adjustment

BFO adjustment requires an accurate frequency counter (less than ± 1 ppm).

Connect the frequency counter to R184 on the main unit. See p. 56 for the exact location.

Make the adjustments in the table at right in the order shown.

	MODE	FREQUENCY	ADJUSTMENT
1	USB	9.01300 MHz	C294
2	CW transmit	9.01060 MHz	L83
3	LSB	9.01000 MHz	L82
4	CW receive	9.00980 MHz	Verify
5	AM	No oscillation	—

■ RIT/ Δ TX adjustment

When the RIT/ Δ TX control center position (RIT/ Δ TX = ± 0) is shifted, it can be adjusted with an internal variable resistor.

- ① Remove the top and bottom covers and turn power ON.
- ② Set the [RIT/ Δ TX] control to the center.
- ③ Push [RIT] to turn the RIT function ON.
- ④ Adjust R319 on the PLL unit, as shown in the figure at left, to set the displayed RIT frequency to "0.00."
- ⑤ Push [RIT] to turn the RIT function OFF.
- ⑥ Replace the top and bottom covers.

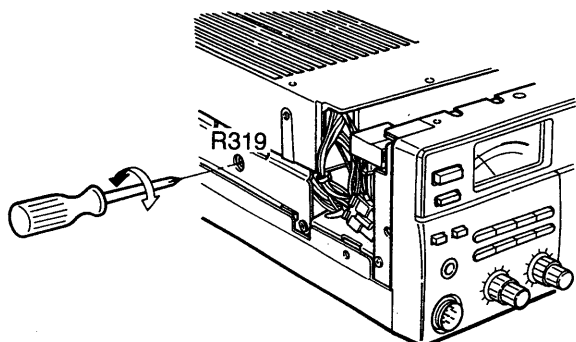

■ PA idling current adjustment

The PA unit operates with a linear amplifier and requires some idling current to flow through the driver and final transistors to obtain bias voltage.

PA UNIT

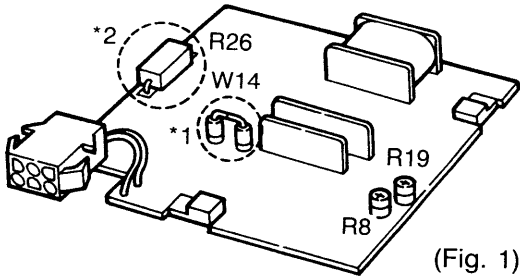

DRIVER TRANSISTORS IDLING CURRENT

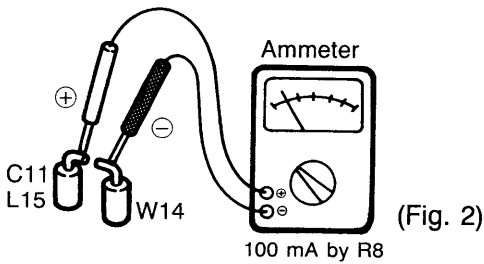

FINAL TRANSISTORS IDLING CURRENT

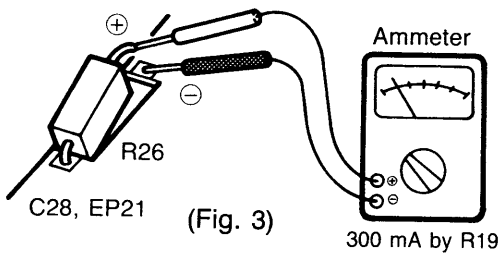

- ① Preparation:
 - [POWER] : OFF
 - [MIC] : Max. counterclockwise
 - [RF PWR] : Max. counterclockwise
 - Microphone : Disconnect
 - Ammeter : 500 mA range
- ② Remove the covers and open the PA unit following the disassembly procedures (A) ~ (E) on pgs. 45 ~ 46.
- ③ Unsolder points indicated by *1 and *2 in figure 1.
- ④ Properly connect test leads to points. See figure 2 for the driver amplifier and figure 3 for the final amplifier adjustments.
- ⑤ Turn transceiver power ON.
- ⑥ Push [SSB] to select LSB or USB.
- ⑦ Push [TRANSMIT] IN to transmit.
- ⑧ - Adjust R8 to set 100 mA for the driver amplifier.
- Adjust R19 to set 300 mA for the final amplifier.
- ⑨ Turn transceiver power OFF.
- ⑩ Re-solder the de-solder points.
- ⑪ Reassemble the transceiver.

■ LCD dimmer adjustment

The LCD dimmer can be adjusted for your preference.

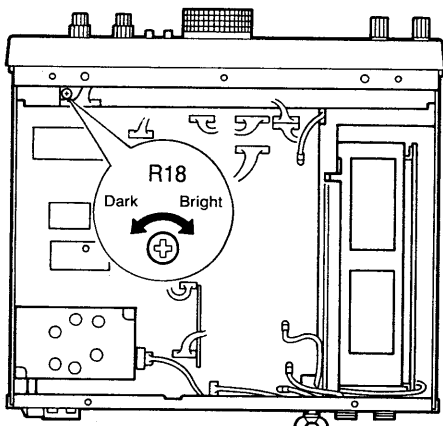

- ① Remove the top and bottom covers (p. 45) and turn power ON.
- ② Adjust R18 on the front unit as shown in the figure at left.
- ③ Replace the top and bottom covers.

■ CW narrow filters

The IC-737A has a CW-narrow mode to provide better S/N (signal to noise ratio), or to reject nearby interference. To use the CW-narrow mode, optional CW filters are necessary.

1 or 2 CW narrow filters can be installed in the IF circuits.

- FL-100 or FL-101 can be installed in the 2nd IF circuit.
- FL-52A or FL-53A can be installed in the 3rd IF circuit.

When 2 filters are installed, the passband width characteristic acquires more shape than when 1 filter is installed, moreover, the PBT function can be used in the CW-narrow mode with 2 filters.

	Passband width	Center frequency
FL-52A	500 Hz/ -6 dB	455 kHz (3rd IF)
FL-53A	250 Hz/ -6 dB	455 kHz (3rd IF)
FL-100	500 Hz/ -6 dB	9.0106 MHz (2nd IF)
FL-101	250 Hz/ -6 dB	9.0106 MHz (2nd IF)

If you install 2 filters, the same passband width CW narrow filters should be installed.

- If you want to use a 500 Hz passband width for CW-narrow mode, you should install FL-100 and FL-52A.
- If you want to use a 250 Hz passband width for CW-narrow mode, you should install FL-101 and FL-53A.

If you want to install 1 filter, a 3rd IF filter (FL-52A or FL-53A) is recommended because of the filters' characteristics.

- ① Remove the top and bottom covers. (p. 45)
- ② Insert the filter(s) at the proper position. The locations are shown in the figure below.
 - The FL-52A or FL-53A must be installed in the proper direction.
 - The FL-100 or FL-101 works regardless of the direction it is installed in.
- ③ - When FL-52A or FL-53A is installed, turn S4 ON as shown in the figure below.
 - When FL-100 or FL-101 is installed, turn S5 ON as shown in the figure below.
 - When 2 filters are installed, turn both S4 and S5 ON.
 - If the switch(es) are not correctly set, the received signal does not pass through the filter(s) even when CW-narrow mode is selected.
- ④ Replace the top and bottom covers.

FL-52A or FL-53A installation

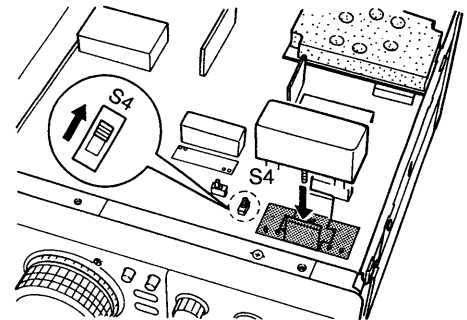

FL-100 or FL-101 installation

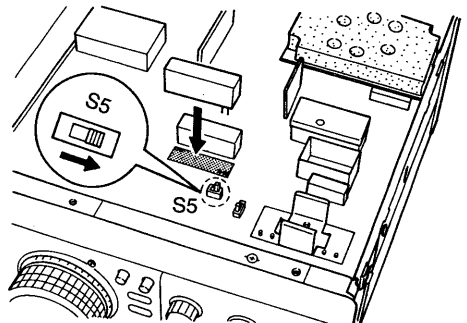

■ UT-30 programmable tone encoder unit

The UT-30 has 38 subaudible tones available.

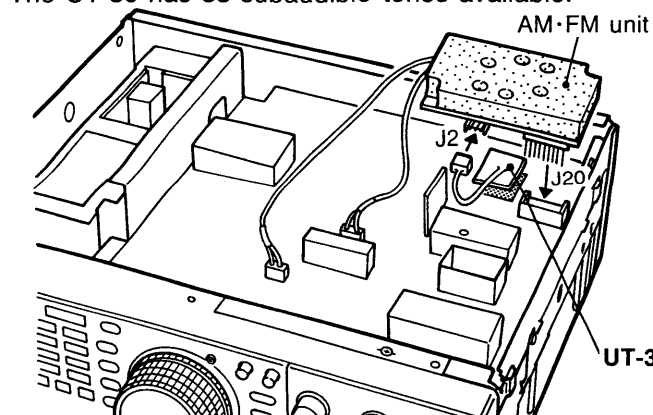

Before unit installation, tone frequency programming is necessary on the UT-30.

- ① Remove the top and bottom covers. (p. 45)
- ② Disconnect J20 to remove the AM-FM unit from the main unit.
- ③ Remove the protective paper from the back of the UT-30 to expose the adhesive strip.
- ④ Attach the UT-30 in the location marked on the main unit.
- ⑤ Connect all wires and cables as shown in the figure at left.
- ⑥ Replace the AM-FM unit on the main unit.
- ⑦ Replace the top and bottom covers.

■ CR-282 high-stability crystal unit

By replacing the original crystal unit with this unit, the total frequency stability of the transceiver will be improved.

CR-282 frequency stability: ± 0.5 ppm
 ($-30^{\circ}\text{C} \sim +60^{\circ}\text{C}$;
 $-22^{\circ}\text{F} \sim +140^{\circ}\text{F}$)

(Fig. 1)

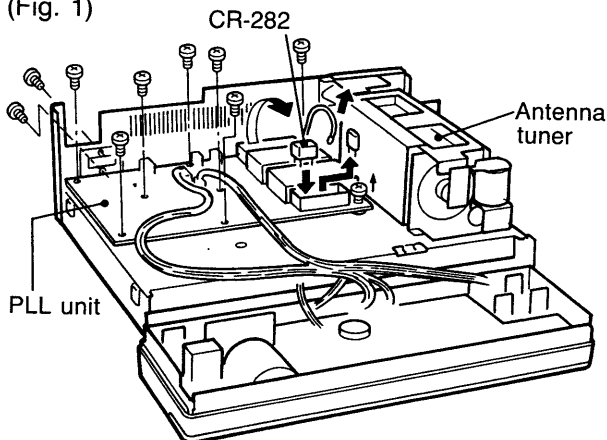

(Fig. 2)

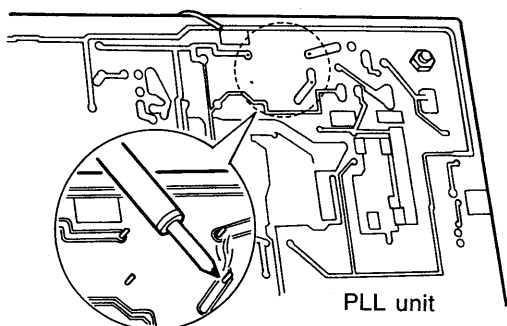

- ① Remove the top and bottom covers and the PA unit; then, prepare the PLL unit removal following the disassembly procedures (A) ~ (F) on pgs. 45 ~ 46.
- ② Remove the PLL unit as shown in figure 1 at left.
- ③ Remove the regular crystal and jumper cable which is soldered to the regular crystal from the PLL unit.
- ④ Unsolder the 4 positions on the PLL unit where the CR-282 will be installed.
 - Use a de-soldering braid.
- ⑤ Install the CR-282 in the PLL unit, paying attention to orientation.
 - Symbols on the bottom of the CR-282 must be identically matched with symbols on the P.C. board.
- ⑥ Bend the leads of the CR-282 at the foil side of the P.C. board and solder them as shown in figure 2 at left.
- ⑦ Trim the leads even with the solder points.
- ⑧ Replace the PLL unit and covers.

After changing the crystal unit, frequency adjustment is necessary with C94 on the PLL unit.

• Ask your Icom Dealer or Icom Service Center for details.

NOTE: The CR-282 is an oven-heat-type crystal unit, and the specified frequency stability described above is guaranteed 1 min. after power ON.

■ MB-49 mobile mounting bracket

The MB-49 mobile mounting bracket allows you to install the IC-737A in your mobile, boat, etc.

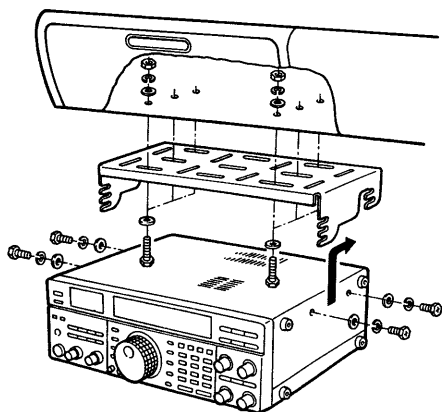

- ① Select a location which can support the weight of the transceiver and that does not interfere with the operation of the vehicle.
- ② Align the MB-49 with the chosen location; then, mark the required hole positions for bracket attachment.
- ③ Remove the MB-49; then, drill holes.
- ④ Fix the bracket with the supplied bolts, nuts and washers.
- ⑤ Attach the IC-737A to the bracket with the 4 sets of supplied bolts and washers.
 - You can select one out of six angles by setting the 4 side bolts' positions on the MB-49.

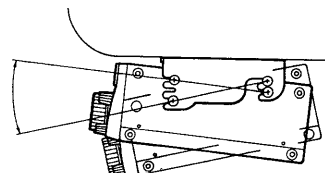

■ Troubleshooting

The following chart is designed to help you correct problems which are not equipment malfunctions.

If you are not able to locate the cause of a problem or solve it through the use of this chart, contact your nearest Icom Dealer or Service Center.

	PROBLEM	POSSIBLE CAUSE	SOLUTION	REF.
POWER SUPPLY	Power does not come on when the [POWER] switch is pushed.	<ul style="list-style-type: none"> • DC power cable is improperly connected. • Fuse is blown. • Battery is exhausted if you use a 12 V battery as a power source. 	<ul style="list-style-type: none"> • Reconnect the power cable correctly. • Check for the cause, then replace the fuse with a spare one. (Fuses are installed in two places. One is installed in the DC power cable and the other is installed in the PA unit.) • Check the battery voltage with the [POWER] switch pushed IN. 	<p>pgs. 8, 13</p> <p>p. 47</p> <p>—</p>
	No sound comes from the speaker.	<ul style="list-style-type: none"> • Volume level is too low. • The squelch is closed. • The transceiver is in the transmitting condition. • An external speaker or headphones are connected. 	<ul style="list-style-type: none"> • Rotate [AF] clockwise to obtain a suitable listening level. • Rotate [SQL] counterclockwise to open the squelch. • Push [TRANSMIT] OUT or check the SEND line of the external unit, if connected. • Check the external speaker or headphone plug connection. • Check the speaker ON/OFF switch or speaker A/B switch, when an optional SP-20 EXTERNAL SPEAKER is in use. 	<p>p. 2</p> <p>p. 2</p> <p>p. 2</p> <p>p. 17</p> <p>—</p>
RECEIVE	Sensitivity is low.	<ul style="list-style-type: none"> • The antenna is not connected properly. • The antenna feed line is cut or shorted. • The antenna for another band is selected. • The antenna is not properly tuned. • The attenuator function is activated. 	<ul style="list-style-type: none"> • Reconnect to the antenna connector. • Check the feed line and correct any improper conditions. • Select an antenna suitable for the operating frequency. • Push [TUNE] to manually tune the antenna. • Push [ATT] to turn the function OFF. 	<p>p. 12</p> <p>—</p> <p>p. 2</p> <p>p. 35</p> <p>p. 2</p>
	Receive audio is distorted.	<ul style="list-style-type: none"> • The operating mode is not selected correctly. • PBT function is activated. 	<ul style="list-style-type: none"> • Select a suitable operating mode. • Set [PBT] to the center position. 	<p>p. 4</p> <p>pgs. 6, 30</p>
	Receive signal is distorted with strong signals.	<ul style="list-style-type: none"> • Noise blanker function is activated. • Preamp is activated. 	<ul style="list-style-type: none"> • Push [NB] to turn the function OFF. • Push [PRE AMP] to turn the function OFF. 	<p>p. 2</p> <p>p. 2</p>
	Antenna switch, ([ANT]), does not function.	<ul style="list-style-type: none"> • The antenna switch has not been activated. 	<ul style="list-style-type: none"> • Set the antenna switch in the set mode to "on" or "Aut." 	<p>p. 32</p>

	PROBLEM	POSSIBLE CAUSE	SOLUTION	REF.
TRANSMIT	Transmitting is impossible.	<ul style="list-style-type: none"> The operating frequency is not set to a ham band. 	<ul style="list-style-type: none"> Set the frequency to a ham band. 	p. 21
	Output power is too low.	<ul style="list-style-type: none"> [RF PWR] is set too far counterclockwise. [MIC] is set too far counterclockwise. The antenna is not connected properly. The antenna feed line is cut or shorted. An antenna for another band is selected. The antenna is not properly tuned. 	<ul style="list-style-type: none"> Rotate [RF PWR] clockwise. Set [MIC] to a suitable position. Reconnect the antenna connector. Check the feed line and correct any improper conditions. Select an antenna suitable for the operating frequency. Push [TUNE] to manually tune the antenna. 	<p>p. 3</p> <p>pgs. 2, 25</p> <p>p. 12</p> <p>—</p> <p>p. 2</p> <p>p. 35</p>
	No contact possible with another station.	<ul style="list-style-type: none"> RIT function is activated. ΔTX function is activated. Split function is activated. 	<ul style="list-style-type: none"> Push [RIT] to turn the function OFF. Push [ΔTX] to turn the function OFF. Push [SPLIT] to turn the function OFF. 	<p>p. 5</p> <p>p. 5</p> <p>pgs. 4, 28</p>
	Repeater cannot be accessed.	<ul style="list-style-type: none"> Split function is not activated. An incorrect transmit frequency is set. Subaudible tone encoder has been turned OFF to access a repeater which requires a tone for access. Programmed subaudible tone frequency is wrong. 	<ul style="list-style-type: none"> Push [SPLIT] to turn the function ON. Set the proper frequencies into VFO A and B or into one of the split memory channels, 90~99. Push [FM/TONE] to select "FM-T." (An optional UT-30 is necessary to generate the subaudible tone.) Reset the frequency referring to the UT-30 instruction manual. 	<p>pgs. 4, 28</p> <p>pgs. 28, 40</p> <p>pgs. 4, 40</p> <p>—</p>
	Transmitted signals are distorted.	<ul style="list-style-type: none"> [MIC] is rotated too far clockwise. [COMP LEVEL] is rotated too far clockwise with the speech compressor ON. 	<ul style="list-style-type: none"> Set [MIC] to a suitable position. Set [COMP LEVEL] to a suitable position. 	<p>pgs. 2, 25</p> <p>pgs. 3, 25</p>
	The displayed frequency does not change properly.	<ul style="list-style-type: none"> The dial lock function is activated. The internal CPU has malfunctioned. 	<ul style="list-style-type: none"> Push [LOCK] to deactivate the function. Perform CPU resetting. (While pushing and holding [CLEAR] and [ENT], turn power ON.) 	<p>p. 3</p> <p>p. 17</p>
SCAN	Programmed scan does not stop.	<ul style="list-style-type: none"> Squelch is open. 	<ul style="list-style-type: none"> Set [SQL] to the threshold point. 	p. 2
	Programmed scan does not start.	<ul style="list-style-type: none"> The same frequencies have been programmed in scan edge memory channels P1 and P2. 	<ul style="list-style-type: none"> Program different frequencies into scan edge memory channels P1 and P2. 	p. 42
	Memory scan does not start.	<ul style="list-style-type: none"> 2 or more memory channels have not been programmed. 	<ul style="list-style-type: none"> Program 2 or more memory channels. 	p. 38
	Selected memory scan does not start.	<ul style="list-style-type: none"> 2 or more memory channels have not been designated as selected channels. 	<ul style="list-style-type: none"> Designate 2 or more memory channels as selected channels for the scan. 	p. 43

■ Main unit

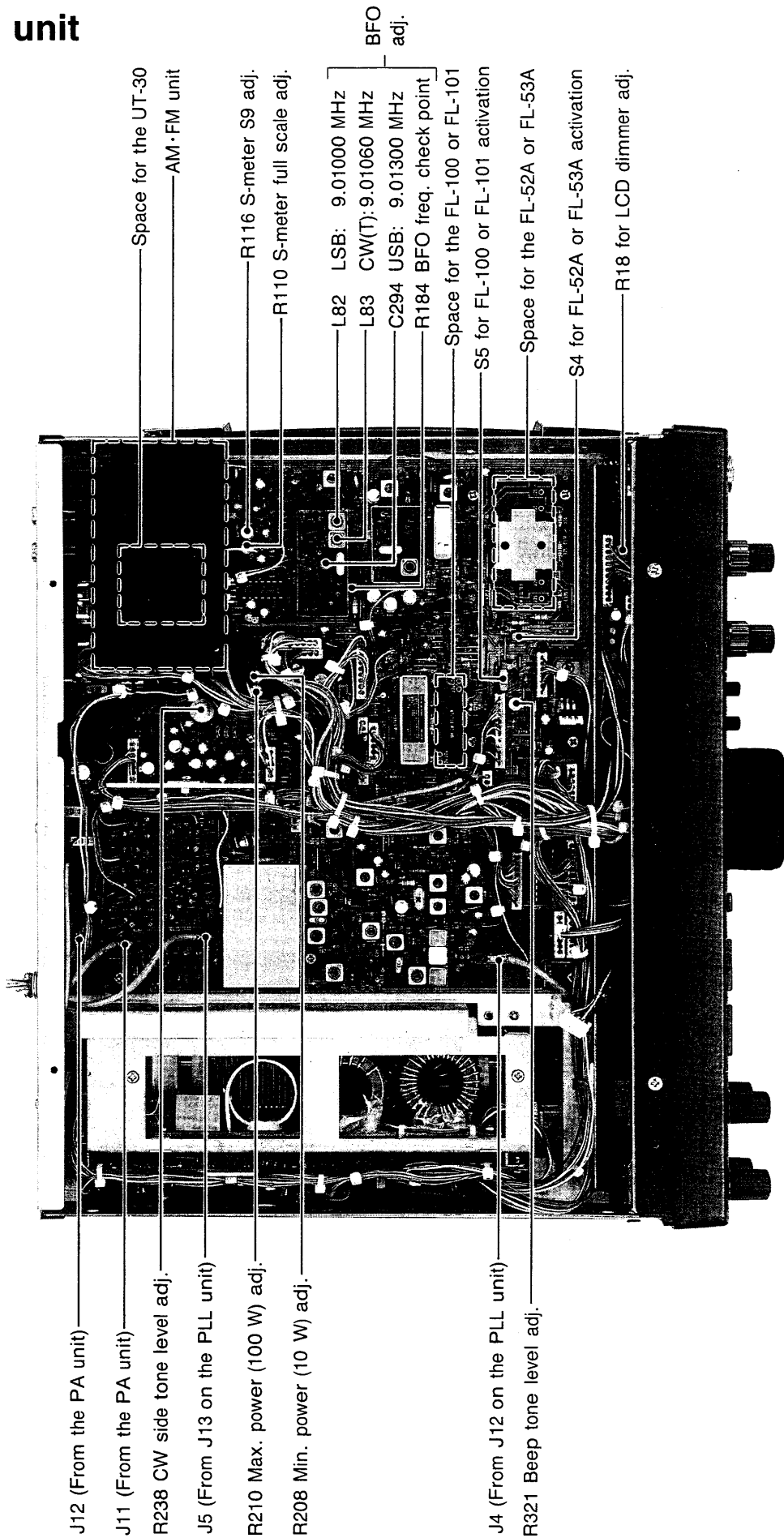

J12 (From the PA unit)

J11 (From the PA unit)

R238 CW side tone level adj.

J5 (From J13 on the PLL unit)

R210 Max. power (100 W) adj.

R208 Min. power (10 W) adj.

J4 (From J12 on the PLL unit)

R321 Beep tone level adj.

Space for the UT-30

AM-FM unit

R116 S-meter S9 adj.

R110 S-meter full scale adj.

L82 LSB: 9.01000 MHz

L83 CW(T): 9.01060 MHz

C294 USB: 9.01300 MHz

R184 BFO freq. check point

Space for the FL-100 or FL-101

S5 for FL-100 or FL-101 activation

Space for the FL-52A or FL-53A

S4 for FL-52A or FL-53A activation

R18 for LCD dimmer adj.

BFO
adj.

■ PLL unit

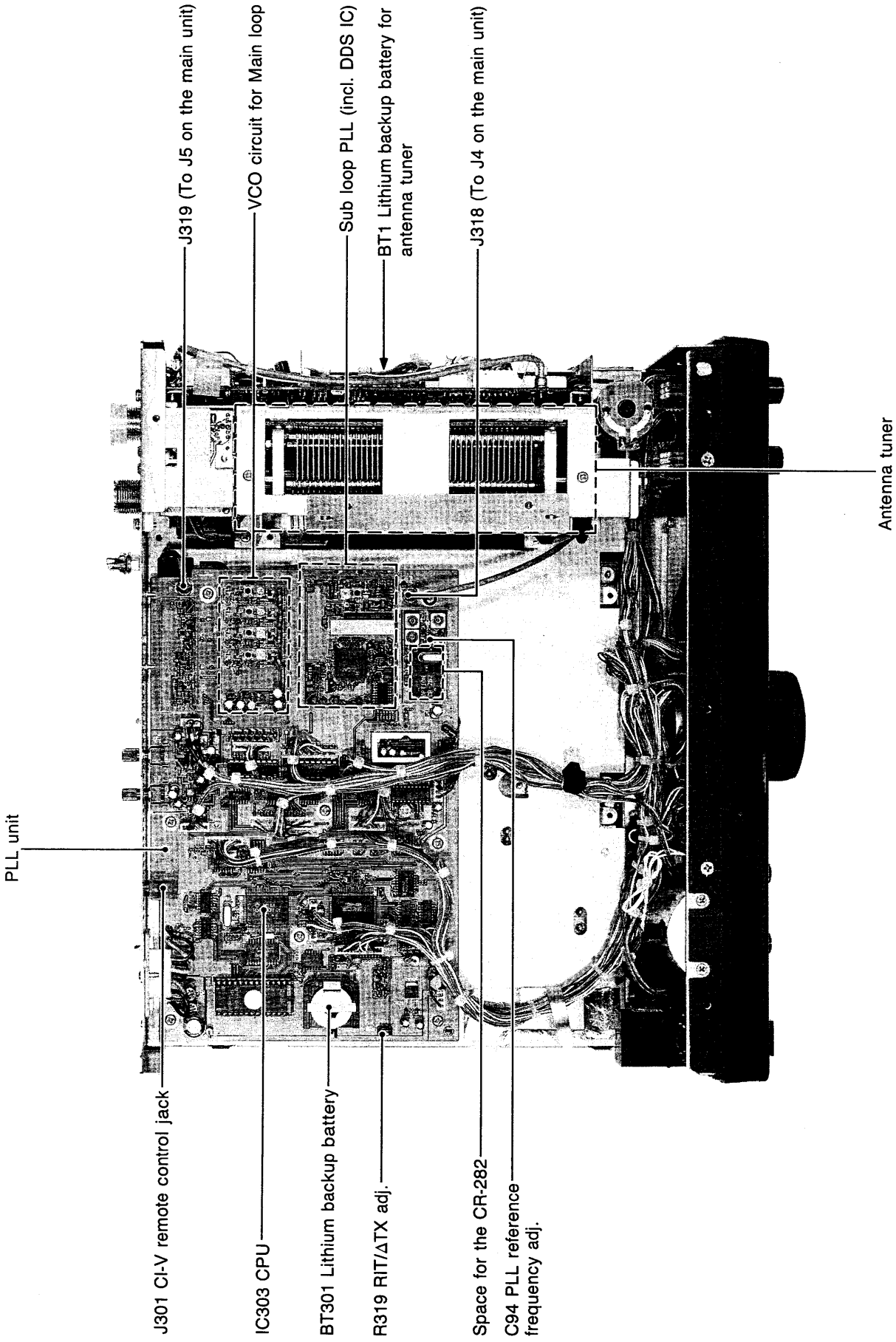

PLL unit

J301 CI-V remote control jack

IC303 CPU

BT301 Lithium backup battery

R319 RIT/ΔTX adj.

Space for the CR-282

C94 PLL reference frequency adj.

J319 (To J5 on the main unit)

VCO circuit for Main loop

Sub loop PLL (incl. DDS IC)

BT1 Lithium backup battery for antenna tuner

J318 (To J4 on the main unit)

Antenna tuner

11 SPECIFICATIONS

■ GENERAL

- Frequency coverage: Receive
500 kHz ~ 29.995 MHz
- Transmit
 - 1.800 ~ 1.99999 MHz
 - 3.500 ~ 4.000 MHz
 - 7.000 ~ 7.300 MHz
 - 10.100 ~ 10.150 MHz
 - 14.000 ~ 14.350 MHz
 - 18.068 ~ 18.168 MHz
 - 21.000 ~ 21.450 MHz
 - 24.890 ~ 24.990 MHz
 - 28.000 ~ 29.700 MHz
- Mode : SSB, CW, AM, FM
- Number of memory : 101 channels
- Antenna impedance : 50 Ω nominal
- Usable temperature : - 10°C ~ + 60°C ; range + 14°F ~ + 140°F
- Frequency stability : Less than ± 200 Hz from 1 min. to 60 min. after power ON. After that, rate of stability change is less than ± 30 Hz/hr. at + 25°C; + 77°F. Temperature fluctuations (0°C ~ + 50°C; + 32°F ~ + 122°F) less than ± 350 Hz.
- Power supply requirement : 13.8 V DC $\pm 15\%$ (20A)
- Current drain : Transmit 20 A
Receive squelched 1.6 A
max. audio output 2.1 A
- Dimensions : 330(W) \times 111(H) \times 285(D) mm
13.0(W) \times 4.4(H) \times 11.2(D) in
(projections not included)
- Weight : 8.1 kg; 17.9 lb

■ TRANSMITTER

- Output power : SSB, CW, FM 10 ~ 100 W
AM 10 ~ 40 W
(continuously adjustable)
- Spurious emissions : Less than - 50 dB
- Carrier suppression : More than 40 dB
- Unwanted sideband : More than 50 dB
- Microphone impedance : 600 Ω

■ RECEIVER

- Receive system : Triple-conversion superheterodyne
- Intermediate frequencies:

MODE	1st	2nd	3rd
SSB	69.0115 MHz	9.0115 MHz	455 kHz
CW	69.0106 MHz	9.0106 MHz	455 kHz
AM, FM	69.0100 MHz	9.0100 MHz	455 kHz

- Sensitivity (Pre-amp ON):
 - 0.5 ~ 1.8 MHz AM
Less than 13.0 μ V for 10 dB S/N
 - 1.8 ~ 29.995 MHz SSB, CW
Less than 0.16 μ V for 10 dB S/N
AM
Less than 2.0 μ V for 10 dB S/N
FM (28 ~ 29.7 MHz)
Less than 0.5 μ V for 12 dB SINAD
- Squelch sensitivity : SSB
Less than 5.6 μ V at threshold
FM
Less than 0.3 μ V at threshold
- Selectivity : SSB, CW
More than 2.1 kHz / - 6 dB
Less than 4.0 kHz / - 60 dB
AM
More than 6.0 kHz / - 6 dB
Less than 20.0 kHz / - 40 dB
FM
More than 12.0 kHz / - 6 dB
Less than 30.0 kHz / - 50 dB
- Spurious and image : More than 70 dB rejection ratio
- Audio output power : More than 2.6 W with a 10% distortion and an 8 Ω load
- RIT/ Δ TX : ± 2.5 kHz max.
variable range

■ ANTENNA TUNER

- Matching impedance range : 16.7 ~ 150 Ω unbalanced
(less than VSWR 3:1)
- Min. operating input power : 8 W
- Waiting time for band changing : Less than 3 sec.
- Tuning time : Less than 7 sec.
- Tuning accuracy : VSWR 1.5:1 or less
- Insertion loss (after tuning) : Less than 1.0 dB

All stated specifications are subject to change without notice or obligation.

IC-4KL 1 KW HF LINEAR AMPLIFIER

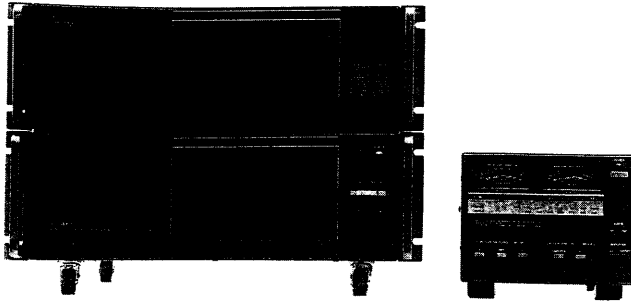

This is an all solid-state full-duty 1 kW linear amplifier including an automatic antenna tuner. The IC-4KL is fully controlled from the IC-737A. No need to tune and no need to switch the operating band. Full break-in (QSK) operation is possible. The amplifier/power supply unit and the remote control unit are separated. Place the amplifier/power supply unit under you operating desk.

IC-2KL 500 W HF LINEAR AMPLIFIER

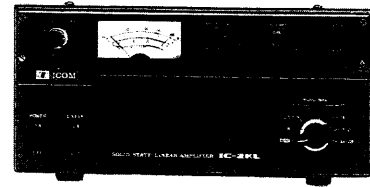

This is an all solid-state 500 W linear amplifier. The power amplifier unit can be separately set-up from the power supply unit.

IC-AT500 HF AUTOMATIC ANTENNA TUNER

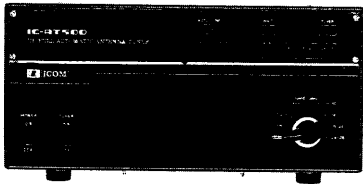

500 W automatic antenna tuner, best match for the IC-737A with the IC-2KL.
Includes an automatic antenna selector for 4 separate antennas.

AT-150 HF AUTOMATIC ANTENNA TUNER

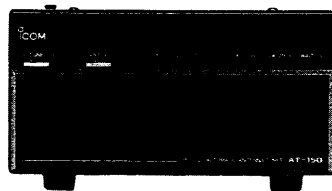

Includes an automatic antenna selector for 3 separate antennas, moreover, a long wire antenna can be tuned.

EX-627 HF AUTOMATIC ANTENNA SELECTOR

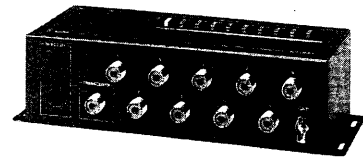

Automatically selects the antenna for the selected ham band. Manual selection is also possible.
• Max. input power : 1000 W PEP

AH-3 HF AUTOMATIC ANTENNA TUNER

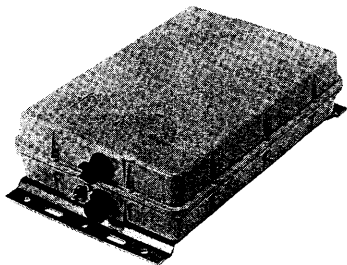

Specially designed to tune a long wire antenna for portable or mobile operation. The IC-737A includes the control circuit for the AH-3.
• Input power rating : 150 W

AH-2b ANTENNA ELEMENT

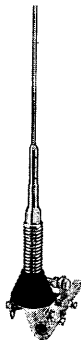

A 2.5 m long antenna element for mobile operation with the AH-3.
• Frequency coverage:
3.5 ~ 28 MHz band with the AH-3

IC-PS15 DC POWER SUPPLY

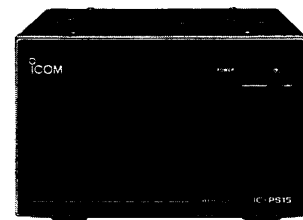

Heavy-duty power transformer system power supply. Style and size are matched with the IC-737A.
• Output voltage : 13.8 V DC
• Max. current drain: 20 A

IC-PS30 DC POWER SUPPLY

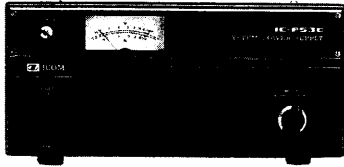

A lightweight switching regulator system power supply equipped with 2 DC power cables and 3 extra output connectors.

- Output voltage : 13.8 V DC
- Max. current drain: 25 A

PS-55 DC POWER SUPPLY



A heavy-duty power transformer system power supply. Built-in cooling fan for full-duty operation.

- Output voltage : 13.8 V DC
- Max. current drain: 20 A

IC-SP3 EXTERNAL SPEAKER

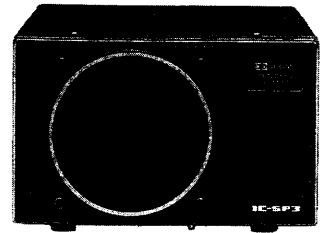

External speaker designed for base station operation.

- Input impedance : 8 Ω
- Max. input power : 4 W

SP-7 EXTERNAL SPEAKER

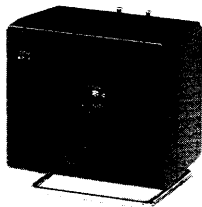

Compact speaker for base station operation. Height can be adjusted for your convenience.

- Input impedance : 8 Ω
- Max. input power : 5 W

SP-20 EXTERNAL SPEAKER

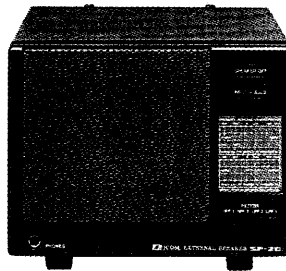

Designed for base station operation. Equipped with 4 types of audio filters, a headphone jack and can be connected to 2 transceivers.

- Input impedance : 8 Ω
- Max. input power : 5 W

SP-21 EXTERNAL SPEAKER

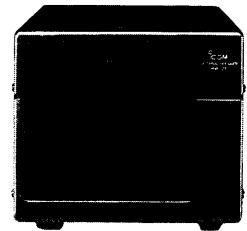

Designed for base station operation. Style and size are matched with the IC-737A.

- Input impedance : 8 Ω
- Max. input power : 5 W

SM-6 DESKTOP MICROPHONE



Electret condenser-type desktop microphone for base station operation.

SM-8 DESKTOP MICROPHONE

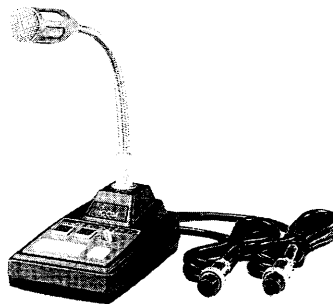

Electret condenser-type desktop microphone including 2 connection cables for simultaneous connection of 2 transceivers. [UP]/[DOWN] switches also come with the microphone.

SM-20 DESKTOP MICROPHONE



Unidirectional, electret microphone for base station operation.

Includes [UP]/[DOWN] switches and a low cut function.

CT-16 SATELLITE INTERFACE UNIT

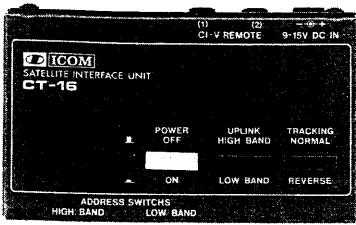

Easy tuning for instant satellite communications.

CT-17 CI-V LEVEL CONVERTER

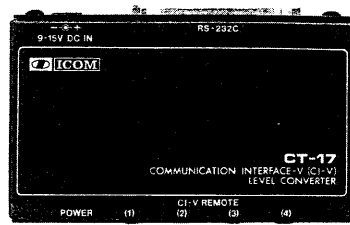

For remote transceiver control using a personal computer equipped with an RS-232C port. You can change frequencies, operating mode, memory channels, etc., via your computer keyboard.

CR-282 HIGH-STABILITY CRYSTAL UNIT

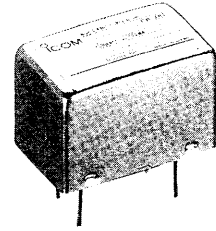

Contains a temperature-compensating oven heater and crystal unit for improved frequency stability.
 • Frequency stability : 0.5 ppm
 (−30°C ~ +60°C; −22°F ~ +140°F)

9 MHz CW NARROW FILTERS

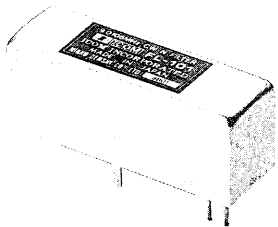

Have good shape factor and provide you with better CW reception during crowded band conditions.
 Passband width:
 • FL-100 : 500 Hz/−6 dB
 • FL-101 : 250 Hz/−6 dB

455 kHz CW NARROW FILTERS

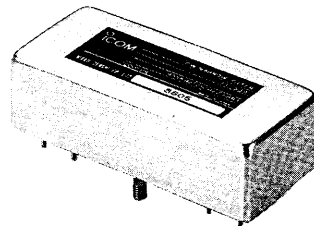

Have good shape factor and provide you with better CW reception during crowded band conditions.
 Passband width:
 • FL-52A : 500 Hz/−6 dB
 • FL-53A : 250 Hz/−6 dB

UT-30 PROGRAMMABLE TONE ENCODER UNIT

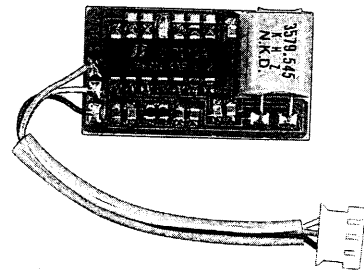

Allows you to access a repeater that requires a subaudible tone. Provides 38 programmable subaudible tones.

MB-49 MOBILE MOUNTING BRACKET

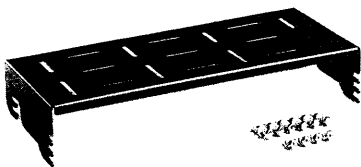

Firmly supports the transceiver for mobile operation.

HM-36 HAND MICROPHONE

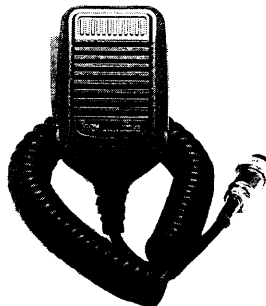

Same type as supplied with the IC-737A.

OPC-025A DC POWER CABLE

Same type as supplied with the IC-737A.

Count on us!

