

ICOM

INSTRUCTION MANUAL

V/UHF MULTI BAND
ALL MODE TRANSCEIVER

IC-970A
IC-970E
IC-970H

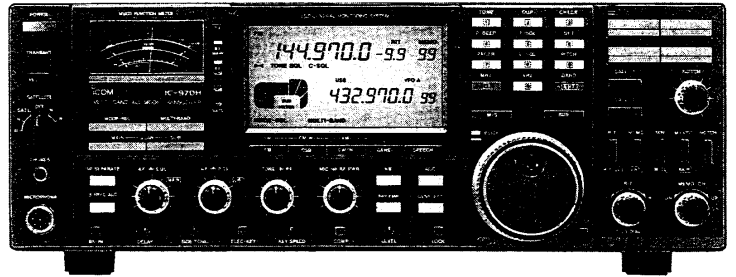

Icom Inc.

IMPORTANT

- (1) **READ THIS INSTRUCTION MANUAL CAREFULLY** before attempting operation. If you have any questions regarding the operation of the IC-970A/E/H, feel free to contact your nearest authorized Icom Dealer or Service Center.
- (2) **SAVE THIS INSTRUCTION MANUAL** — This instruction manual contains important safety and operating instructions for the IC-970A/E/H.

EXPLICIT DEFINITIONS

The following explicit definitions apply to this instruction manual.

WORD	DEFINITION
WARNING	Personal injury, fire hazard or electric shock may occur.
CAUTION	Equipment damage may occur.
NOTE	If disregarded, inconvenience only. No personal injury or risk of electric shock.

UNPACKING

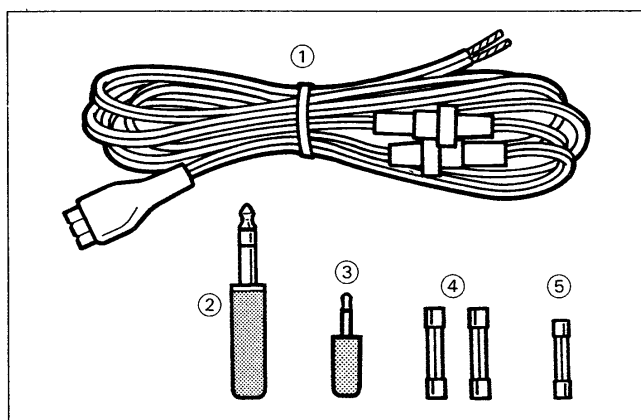

Accessories included with the IC-970A/E/H	Qty.
① DC power cable (OPC-025A)*	1
② Keyer plug (AP-330)	1
③ External speaker plug (AP-313)	1
④ Spare fuses (for DC power cable; FGB 20 A)	2
⑤ Spare fuse (for internal circuitry; 5 A)	1

* Some versions include an AC power cable instead of a DC power cable.

INTRODUCTION

Thank you for purchasing the IC-970A/E/H MULTI BAND ALL MODE TRANSCEIVER.

Icom's advanced IC-970A/E/H is designed to meet the increasing demand of today's amateur radio operators for high precision, sophisticated radio communications. Two bands with multi-mode and additional band capability. Moreover, a wideband receiver unit can be installed. Serious satellite operators and V/UHF band enthusiasts will love the multi-function capability of this state-of-the-art rig.

FEATURES

- Separate receiver on the MAIN and SUB bands
- Expansion capability with 1200 MHz and wideband receiver
- Perfect satellite communication
- Multiple-action scan functions
- Large multi-function display
- 99 memory channels in each band
- Selective calling system
- Dial click function
- DDS (Direct Digital Synthesizer) System
- Notch filter and speech compressor
- CW break-in and optional electronic keyer

PRECAUTIONS

- (1) **NEVER** connect the DC power cable to an AC outlet. This will ruin the transceiver.
- (2) **NEVER** apply more than 16 V DC to the DC power socket on the transceiver rear panel. Check the power source voltage before connecting the power cable.
- (3) **NEVER** allow metal, wire or other objects to touch any internal part of the transceiver. Risk of electric shock could occur.
- (4) **NEVER** allow children to touch the transceiver.
- (5) **NEVER** expose the transceiver to rain, snow or any liquid.
- (6) **AVOID** to use of strong chemical agents for cleaning such as benzine or alcohol. Use a dry, soft cloth only.

TABLE OF CONTENTS

IMPORTANT	i	7. GENERAL COVERAGE RECEIVING	24
EXPLICIT DEFINITIONS	i	8. MEMORY CHANNEL OPERATION	25
UNPACKING	i	9. CALL CHANNEL OPERATION	28
INTRODUCTION	i	10. SCAN OPERATION	29
FEATURES	i	11. SATELLITE OPERATION	31
PRECAUTIONS	i	12. PAGER AND CODE SQUELCH	33
TABLE OF CONTENTS	ii	13. POCKET BEEP AND TONE SQUELCH	35
FRONT PANEL INDEX	ii	14. OPTIONAL UNIT INSTALLATION	37
1. CONTROL FUNCTIONS	1	15. ADJUSTMENT AND SETTING	41
2. BASIC CONNECTIONS	8	16. MAINTENANCE	43
3. ADVANCED CONNECTIONS	11	17. INSIDE VIEWS	45
4. FREQUENCY SETTINGS	15	18. SPECIFICATIONS	46
5. AMATEUR BAND RECEIVING	19	19. OPTIONS	47
6. TRANSMITTING	21		

FRONT PANEL INDEX

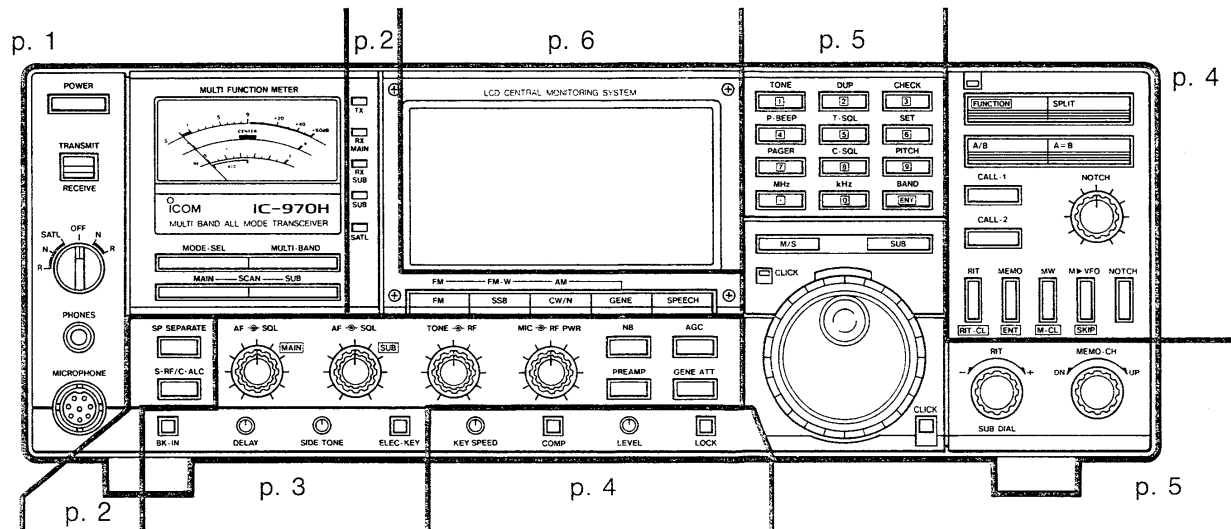

Front panel

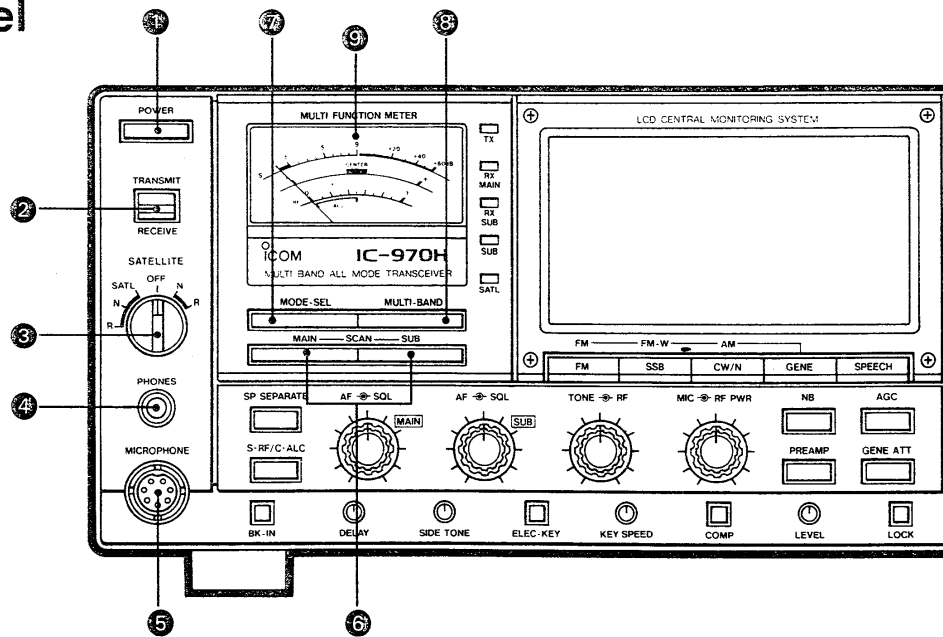

- 1 POWER SWITCH [POWER]**
Turns power ON and OFF.

- 2 TRANSMIT/RECEIVE SWITCH [TRANSMIT/RECEIVE]** (p. 21)
Selects transmit or receive.

- 3 SATELLITE SWITCH [SATELLITE]** (p. 31)
Allows tracking operation for satellite communications.

- **OFF**

For normal operation. The MAIN and SUB bands have no frequency tracking relation.

- **N (NORMAL)**

The MAIN and SUB band frequencies simultaneously change in the same direction. (Normal tracking)

- **R (REVERSE)**

The MAIN and SUB band frequencies simultaneously change in the opposite direction each other. (Reverse tracking)

- **SATL (SATELLITE)**

Enters SATELLITE MEMORY mode. The [MEMO-CH] selector is used for satellite memory channel selection.

Use for programming frequencies. The MAIN and SUB band frequencies have no tracking relation.

- **SATL-N (NORMAL)**

When the [SUB] switch is ON: The MAIN band frequency simultaneously changes with the SUB band frequency in the same direction each other.

When the [SUB] switch is OFF: Only MAIN band frequency changes.

- **SATL-R (REVERSE)**

When the [SUB] switch is ON: The MAIN band frequency simultaneously changes with the SUB band frequency in the opposite direction.

When the [SUB] switch is OFF: Only the MAIN band frequency changes.

- 4 HEADPHONES JACK [PHONES]** (p. 11)
Accepts a standard 1/4 inch plug from 4 ~ 16 Ω mono or stereo headphones.

- 5 MICROPHONE CONNECTOR** (p. 9)
Accepts an optional microphone described on p. 47.

- 6 SCAN SWITCHES** (p. 29)

- **MAIN BAND SCAN SWITCH [MAIN-SCAN]**

Starts and stops a scan function in the MAIN band.

- **SUB BAND SCAN SWITCH [SCAN-SUB]**

Starts and stops a scan function in the SUB band.

- 7 MODE SELECT SWITCH [MODE-SEL]** (pgs. 25, 29)
Activates the mode-select function.

- [MEMO-CH] selects only the same mode memory channels as currently displayed mode.

- The mode-select scan is selected instead of the memory scan.

- 8 MULTI-BAND SWITCH [MULTI-BAND]** (pgs. 25, 29)
Activates the multi-band memory function.

- [MEMO-CH] selects SUB band and undisplayed band memory channels (except the general coverage receiver band).

- The multi-band memory scan is selected instead of the memory scan.

The function can be used when an optional band unit is installed.

- 9 MULTI-FUNCTION METER** (pgs. 19, 20)

Acts for the MAIN band. Functions as an S-meter (signal strength meter) or center meter while receiving and an RF meter or ALC meter while transmitting. See item 18 for selection.

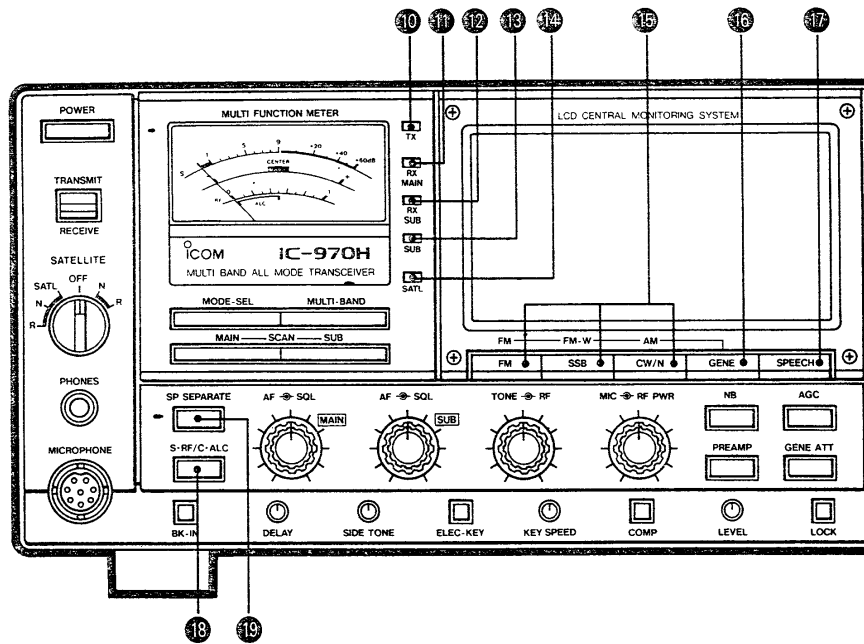

- ⑩ **TRANSMIT INDICATOR [TX]** (p. 21)
Lights up in red while transmitting.
- ⑪ **MAIN BAND RECEIVE INDICATOR [RX MAIN]**
(p. 19)
Lights up in green while the MAIN band is in receive with the squelch open.
- ⑫ **SUB BAND RECEIVE INDICATOR [RX SUB]** (p. 19)
Lights up in green while the SUB band is in receive with the squelch open.
- ⑬ **SUB BAND INDICATOR [SUB]** (p. 16)
Lights up in red when the SUB band control is selected.
- ⑭ **SATELLITE INDICATOR [SATL]** (p. 31)
Lights up in red when a satellite memory is used and lights up in green when the tracking operation is in the MAIN and SUB bands.
- ⑮ **MODE SWITCHES** (pgs. 19, 24)
Select the desired operating mode.

FM wide (FM-W) and AM modes can be selected when an optional UX-R96 RECEIVE UNIT is installed.
- ⑯ **GENERAL COVERAGE SWITCH [GENE]** (p. 24)
Selects an optional UX-R96 RECEIVER UNIT.
- ⑰ **SPEECH SWITCH [SPEECH]**
Activates an optional UT-36 VOICE SYNTHESIZER UNIT for announcing the selected band (MAIN or SUB) frequency in English.

- ⑱ **METER FUNCTION SWITCH [S-RF/C-ALC]**
(pgs. 20, 22)
Selects the function of the multi-function meter ⑨ for the MAIN band as follows:

MODE	FM		SSB/CW	
	RECEIVE	TRANSMIT	RECEIVE	TRANSMIT
S-RF (OUT)	S-meter	RF meter	S-meter	RF meter
C-ALC (IN)	Center meter	ALC meter	S-meter	ALC meter

- ⑲ **SPEAKER SEPARATE SWITCH [SP SEPARATE]**
(p. 11)
Selects the internal and external speaker combination as follows:

[SP SEPARATE] SWITCH	ON (IN)	OFF (OUT)
When no external speaker is connected.	The internal speaker outputs the MAIN band audio only.	The internal speaker outputs both MAIN and SUB bands audio.
When an external speaker is connected.	The internal speaker outputs the MAIN band audio. The external speaker outputs the SUB band audio.	The external speaker outputs both MAIN and SUB bands audio.
When stereo headphones are connected.	The left speaker outputs MAIN band audio. The right speaker outputs SUB band audio.	The left and right speakers output mixed audios.

1 CONTROL FUNCTIONS

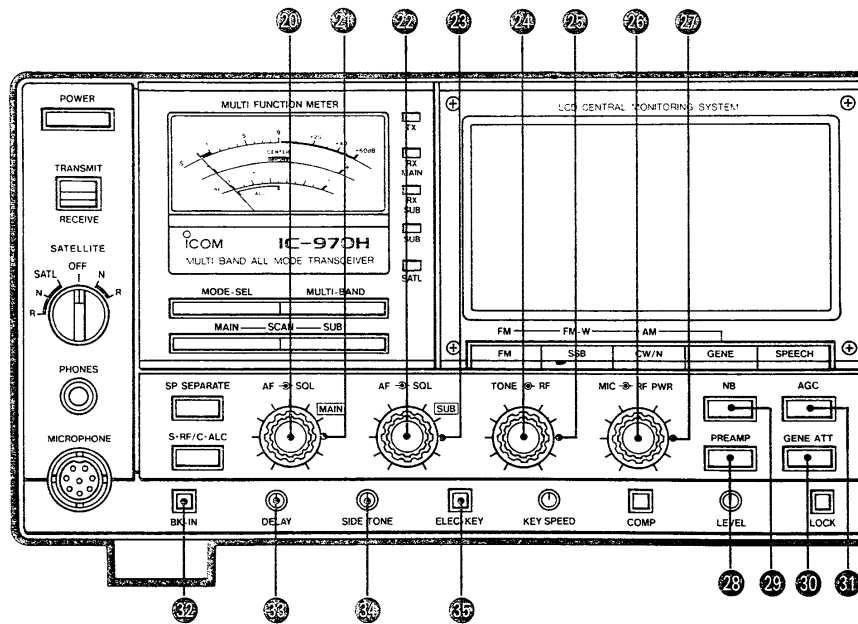



- 20 MAIN BAND AF CONTROL [AF]** (p. 19)
Adjusts the MAIN band audio level.
- 21 MAIN BAND SQUELCH CONTROL [SQL]** (p. 19)
Adjusts the MAIN band squelch threshold level.
- 22 SUB BAND AF CONTROL [AF]** (p. 19)
Adjusts the SUB band audio level.
- 23 SUB BAND SQUELCH CONTROL [SQL]** (p. 19)
Adjusts the SUB band squelch threshold level.
- 24 TONE CONTROL [TONE]**
Adjusts the receive audio frequency response of the MAIN band.

The SUB band frequency response is fixed.
- 25 RF GAIN CONTROL [RF]** (p. 20)
Adjusts gain at the MAIN band receiver RF stage.

The SUB band RF gain is fixed.
- 26 MIC GAIN CONTROL [MIC]**
Adjusts the microphone input gain. See p. 22 RF and ALC meter for adjusting details.
- 27 RF POWER CONTROL [RF PWR]** (p. 22)
Adjusts transmit output power.
- 28 PREAMP SWITCH [PREAMP]** (pgs. 20, 42)
Activates an optional external preamplifiers.
- 29 NOISE BLANKER SWITCH [NB]** (p. 20)
Blanks pulse-type noise such as vehicle ignition noise from the receiving audio.

Noise blanker activates in SSB, CW and AM (optional) modes on both MAIN and SUB bands.
- 30 GENERAL COVERAGE BAND ATTENUATOR SWITCH [GENE ATT]** (p. 24)
Attenuates receiving signals with 20 dB attenuation when an optional UX-R96 RECEIVER UNIT is selected.
- 31 AGC (Auto Gain Control) SWITCH [AGC]** (p. 20)
Selects the time constant of the AGC circuit.

 : AGC slow
 : AGC fast

 The SUB band AGC time constant is fixed as "slow" for SSB mode and "fast" for CW mode.
- 32 CW SEMI BREAK-IN SWITCH [BK-IN]** (p. 23)
Activates the CW semi break-in function.
- 33 CW BREAK-IN DELAY CONTROL [DELAY]** (p. 23)
Adjusts the transmit-to-receive switching delay time for CW semi break-in operation.

To activate this control, push IN [BK-IN] .
- 34 CW SIDE TONE CONTROL [SIDE TONE]** (p. 23)
Adjusts the CW side tone level regardless of the [AF] control position.
- 35 ELECTRONIC KEYSER SWITCH [ELEC-KEY]** (pgs. 23, 40)
Activates an optional IC-EX243 ELECTRONIC KEYSER UNIT.

NOTE: The antenna connectors of the displayed band frequencies output DC voltages when [PREAMP] is pushed IN. **BE CAREFUL** when connecting a non-Icom preamplifier or linear amplifier. See p. 42 for control voltage information.

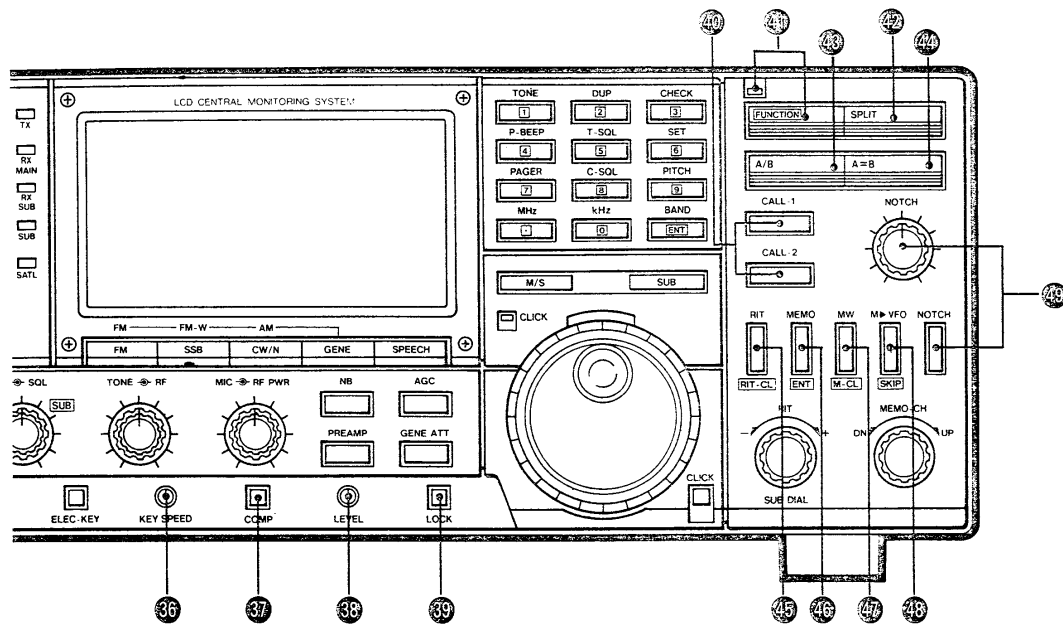

36 KEYING SPEED CONTROL [KEY SPEED] (p. 23)
Adjusts the keying speed when operating in CW mode with an optional IC-EX243.

To activate this control, push IN [ELEC-KEY] **35**.

37 SPEECH COMPRESSOR SWITCH [COMP] (p. 22)
Activates the built-in speech compressor.

38 COMPRESSOR LEVEL CONTROL [LEVEL] (p. 22)
Adjusts the speech compressor level.

To activate this control, push IN [COMP] **37**.

39 LOCK SWITCH [LOCK] (p. 18)
Deactivates the main dial and electrically locks the currently displayed frequencies.

40 CALL SWITCHES [CALL-1]/[CALL-2] (p. 28)
Call up a user-programmable call channel.

- **[CALL-1]**

The call-1 channel remains on one frequency in all bands.

- **[CALL-2]**

The call-2 channel remains on a frequency in each band.

41 FUNCTION SWITCH AND INDICATOR [FUNCTION] (pgs. 17, 27, 28)
The switch activates the secondary function of switches **45** ~ **48** and the keyboard for digit entry.
The red indicator lights up when the switch is pushed.

42 SPLIT SWITCH [SPLIT] (p. 22)
Selects split operation — Receiving on VFO A and transmitting on VFO B or vice versa.

43 VFO SWITCH [A/B] (p. 17)
Selects VFO mode and changes VFO A and B.

44 VFO EQUALIZING SWITCH [A = B] (p. 17)
Equalizes contents of the undisplayed VFO to the displayed VFO.

45 RIT SWITCH [RIT] (p. 20)
Activates the RIT (Receive Incremental Tuning) function.
After pushing [FUNCTION], this switch clears the displayed RIT shift frequency.

46 MEMORY SWITCH [MEMO] (pgs. 25, 26)
Selects MEMORY mode.
After pushing [FUNCTION] and digit keys, this switch selects the memory channel directly.

47 MEMORY WRITE SWITCH [MW] (pgs. 26, 27)
Stores the displayed frequency, mode and repeater information into the displayed memory channel.
After pushing [FUNCTION], this switch clears the displayed memory contents.

48 FREQUENCY TRANSFER SWITCH [M → VFO] (pgs. 27, 28)
Transfer the displayed memory or call channel information into a VFO.
After pushing [FUNCTION], this switch sets the skip function into the displayed memory channel.

49 NOTCH FILTER CONTROL AND SWITCH [NOTCH] (p. 20)
• **NOTCH SWITCH**
Activates the notch filter function to reduce an interference signal.
• **NOTCH CONTROL**
Adjusts the center frequency of the notch filter.

The notch filter functions in the MAIN band only.

1 CONTROL FUNCTIONS

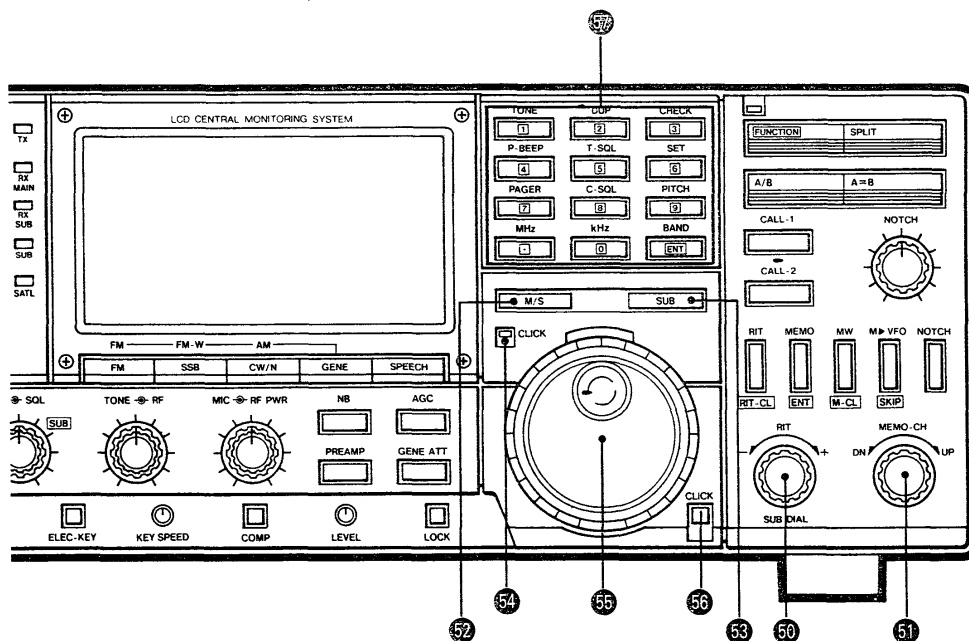

50 RIT CONTROL [RIT] (p. 20)
 When “RIT” appears on the MAIN band display:
 Sets the RIT shift frequency.

When “RIT” does not appear: Sets the SUB band frequency.

51 MEMORY CHANNEL SELECTOR [MEMO-CH]
 (pgs. 25, 32)
 Selects the memory channel.

52 MAIN/SUB BAND SWITCH [M/S] (p. 16)
 Exchanges the MAIN and SUB bands.

53 SUB BAND SWITCH [SUB] (p. 16)
 Accesses the SUB band for tuning purposes.

54 CLICK INDICATOR [CLICK] (pgs. 18, 42)
 Lights up while operating the dial click function.

55 MAIN DIAL (p. 18)
 Sets the displayed frequency.

56 CLICK SWITCH [CLICK] (p. 18)
 Activates the dial click function.
 The dial click function may not operate depending on the condition such as operating mode, internal S1 switch position, etc. See p. 42 for details.

57 KEYBOARD (p. 17)
 After pushing [FUNCTION], the keyboard functions as digit keys.

When [FUNCTION] has not been pushed, a key has its own function.

	Turns ON and OFF the subaudible tone encoder. Functions in FM only.	p. 22
	Selects – duplex, + duplex and simplex in sequence.	p. 22
	Checks the transmit frequency when duplex is selected.	p. 21
	Turns ON and OFF the pocket beep function. Functions in FM only.	p. 36
	Turns ON and OFF the optional tone squelch function. Functions in FM only.	p. 36
	Sets the offset frequency, tone frequency and DTMF code.	pgs. 22
	Turns ON and OFF the pager function. Functions in FM only.	p. 33
	Turns ON and OFF the code squelch function. Functions in FM only.	p. 33
	Sets the tuning pitch. Functions in FM only.	p. 18
	Sets the tuning steps at 1 MHz.	p. 18
	Sets the tuning steps at 1 kHz.	p. 18
	Selects the operating band when an optional band unit is installed.	p. 16

Function display

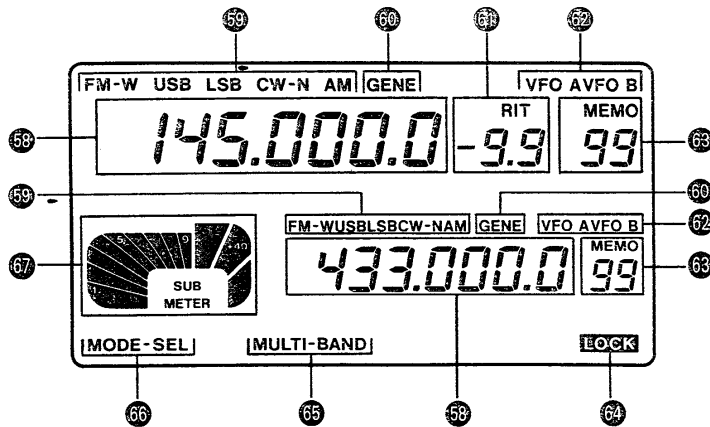

58 FREQUENCY READOUTS

Display the operating frequency from the 100 Hz unit.

59 MODE INDICATORS

Indicate the operating mode.

60 GENERAL COVERAGE INDICATORS (p. 24)

Appear when an optional general coverage receiver band is selected.

61 RIT INDICATOR (p. 20)

Appears when the RIT function is activated and displays shift frequency up to ± 9.9 kHz.

The RIT function operates in the MAIN band only with ± 9.99 kHz.

62 VFO INDICATORS (p. 17)

Indicate VFO mode and show the selected VFO.

63 MEMORY INDICATORS (p. 25)

“MEMO” appears when MEMORY mode is selected. Shows the selected memory channel number.

64 LOCK INDICATOR (p. 15)

Appears when the [LOCK] switch 39 is ON.

65 MULTI-BAND INDICATOR (pgs. 25, 30)

Appears when the [MULTI-BAND] switch 18 is ON.

66 MODE SELECT INDICATOR (pgs. 25, 30)

Appears when the [MODE-SEL] switch 7 is ON.

67 SUB BAND METER (p. 19)

Acts for the SUB band S-meter (signal strength meter).

The transceiver has a large function display to display the MAIN and SUB band information simultaneously.

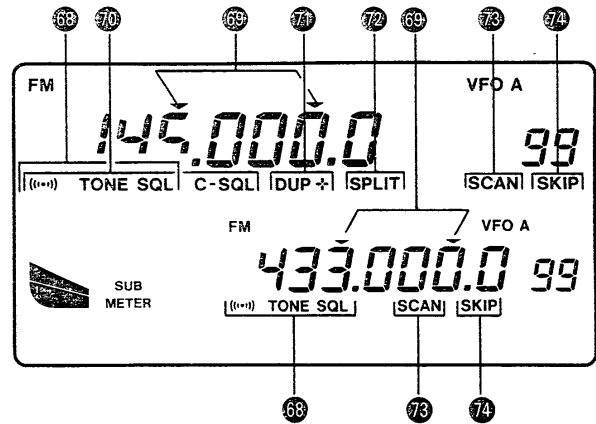

68 TONE/TONE SQUELCH/POCKET BEEP INDICATORS (p. 35)

- “TONE” appears when the subaudible tone encoder is turned ON.
- “TONE SQL” appears when the optional tone squelch is turned ON. An optional UT-34 TONE SQUELCH UNIT is necessary.
- “((•••))” and “TONE SQL” appear when the pocket beep function is activated. The pocket beep function operates with or without an optional UT-34.

69 TUNING DIGIT INDICATORS (p. 18)

Point to the lowest tuning digit.

70 CODE SQUELCH/PAGER INDICATORS (p. 33)

- “C-SQL” appears when the code squelch is activated.
- “((•••))” and “C-SQL” appear when the pager function is activated.

71 DUPLEX INDICATOR (p. 21)

“DUP - ” appears when selecting - duplex or “DUP + ” appears when selecting + duplex.

72 SPLIT INDICATOR (p. 22)

Appears when operating split function using 2 VFOs.

73 SCAN INDICATORS (p. 29)

Appears while scanning.

74 MEMORY SKIP INDICATORS (p. 29)

Indicates the skip function being set on the displayed memory channel. The memory channel is skipped during memory scan.

1 CONTROL FUNCTIONS

■ Rear panel

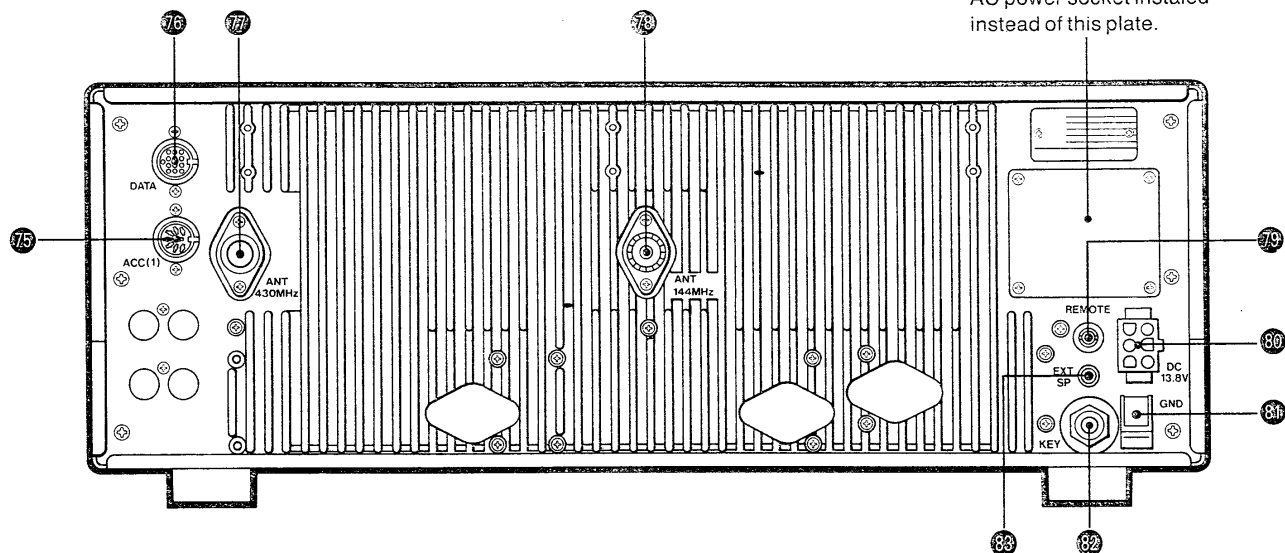

75 ACC SOCKET [ACC (1)] (p. 13)
Used for external equipment connections. This connector includes MAIN band output ports.

76 DATA SOCKET [DATA] (p. 13)
Used for external equipment connections. This connector includes MAIN and SUB band output ports.

77 430 MHz ANTENNA CONNECTOR [ANT 430MHz]
(pgs. 8, 9)
Connects a 430 MHz band antenna with a Type-N connector

78 144 MHz ANTENNA CONNECTOR [ANT 144 MHz]
(pgs. 8, 9)
Connects a 144 MHz band antenna with a PL-259 connector.

79 CI-V REMOTE CONTROL JACK [REMOTE] (p. 14)
Designed for use with a personal computer for remote operation of transceiver functions.

80 DC POWER SOCKET [DC13.8V] (p. 9)
Accepts 13.8 V DC using the supplied DC cable.
The connector is already used on some versions.

81 GROUND TERMINAL [GND] (p. 9)
To prevent electrical shock, TVI, BCI and other related problems, connect this terminal to ground.

82 CW KEY JACK [KEY] (pgs. 9, 23)
Accepts straight key or electronic keyer with the supplied key plug.

An Iambic keyer paddle is also acceptable when an optional IC-EX243 ELECTRONIC KEYSER UNIT is installed.

83 EXTERNAL SPEAKER JACK [EXT SP] (p. 11)
Accepts a 4 ~ 16 Ω speaker. External speaker may be convenient for simultaneously receiving. See [SP SEPARATE] 41 for details.

■ Unpacking

After unpacking, immediately report any damage to the delivering carrier or dealer. Keep the shipping cartons. For a description and a diagram of accessories included with the IC-970A/E/H, see UNPACKING on the inside front cover (p. i).

■ Antenna

For radio communications, the antenna is one of the important factors along with output power and sensitivity. Select good antennas and mounting locations. The transceiver accepts a 50 Ω antenna and less than 3:1 of VSWR.

The IC-970A/E/H requires 2 antennas for 144 and 430 MHz operation. If you install optional band units, additional antennas are necessary.

■ Setting location

Select a location for the transceiver that allows good ventilation and access to the front panel. Keep the transceiver away from extreme heat, cold, vibrations, TV sets, TV antenna elements, radios and electromagnetic sources.

• Selectable angles

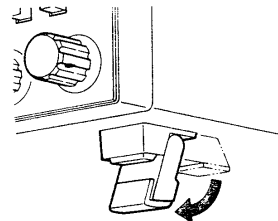

The rubber stands on the bottom of the IC-970A/E/H give the transceiver 2 selectable angles.

■ Antenna connectors

• PL-259 connector installation

① Slide the coupling ring. Strip the cable jacket and soft solder.

② Strip the cable as shown at left. Soft solder the center conductor.

(10 mm \approx 3/8 inch)

③ Slide the connector body and solder it.

④ Screw the coupling ring onto the connector body.

• Type-N connector installation

① Slide parts as shown at left. Cut the end of the cable evenly.

② Strip the cable and fold the braid over the clamp. Evenly trim the braid ends.

(10 mm \approx 3/8 inch)

③ Soft solder the center conductor. Install the pin and solder it.

④ Slide the plug body and tighten the nut.

2 BASIC CONNECTIONS

■ Required connections

• Front panel

MICROPHONE

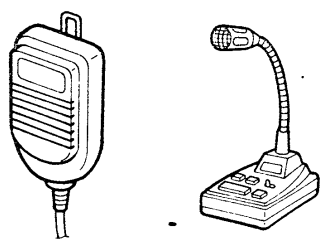

For FM and SSB operation, connect a microphone to this connector. See p. 47 for optional microphone details.

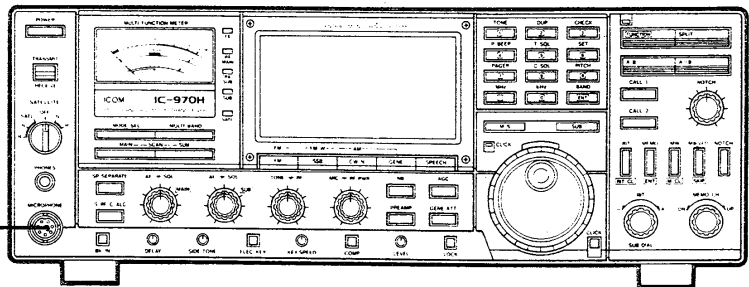

• Rear panel

430 MHz ANTENNA

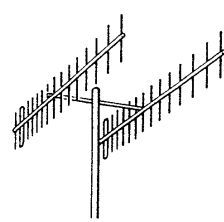

144 MHz ANTENNA

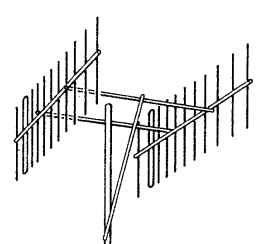

POWER SUPPLY

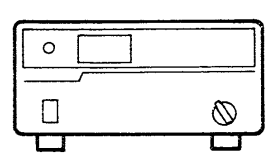

See the page at right for details.

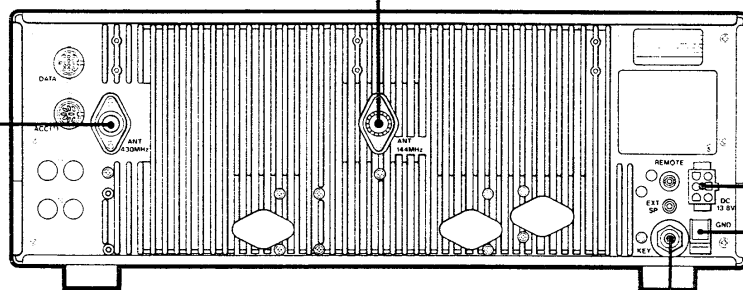

KEY JACK

For CW operation, the transceiver accepts a straight key or external electronic keyer.

An iambic key paddle can be used when an optional IC-EX243 ELECTRIC KEYSER UNIT is installed.

STRAIGHT KEY CONNECTION

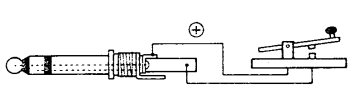

IAMBIC KEY PADDLE CONNECTION

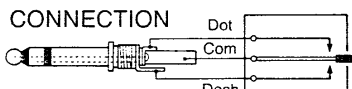

GROUNDING

Use the heaviest gauge wire or strap available and make the connection as short as possible.

Grounding prevents electrical shocks, TVI and other problems.

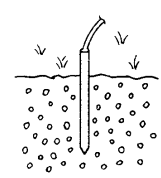

■ Power supply connection

CAUTION: Turn the transceiver [POWER] switch OFF before connecting a power cable.

- Using the IC-PS35 internal power supply
(Some versions already include the IC-PS35)

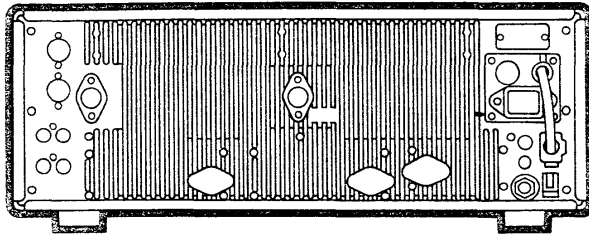

See p. 37 for the IC-PS35 installation.

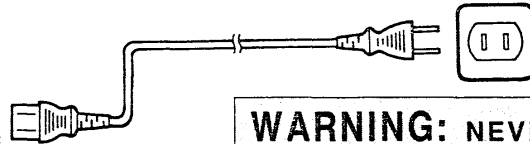

WARNING: NEVER connect the AC power cable to the [DC 13.8 V] connector. The AC socket is supplied with the IC-PS35.

- Using an Icom AC power supply, IC-PS15 or PS-55

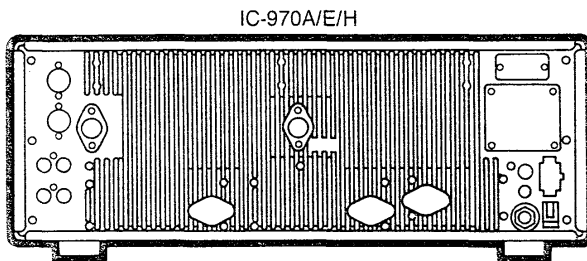

The [POWER] switch of the transceiver synchronizes the IC-PS15 or PS-55 with the transceiver.

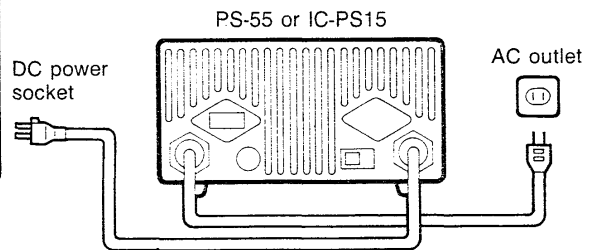

- Using a non-Icom AC power supply

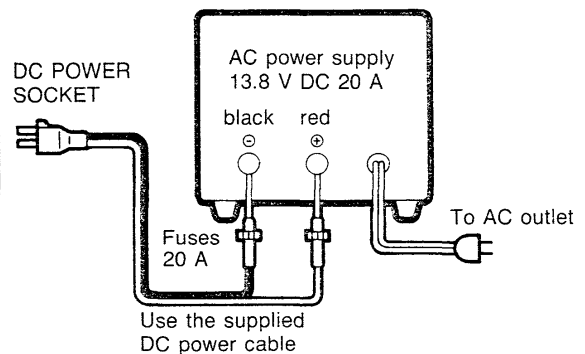
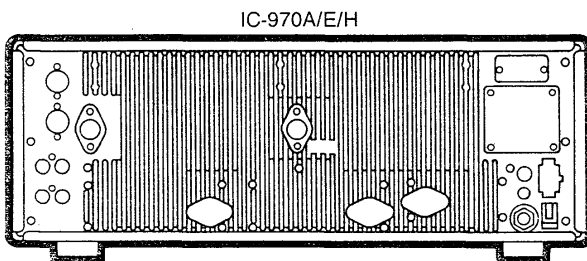

CAUTION: Check the following points before connecting the DC power cable:

- Output voltage of the power source is 12 ~ 15V when you want to use a non-Icom power supply.
- DC power cable polarity is correct.
red → positive ⊕ terminal
black → negative ⊖ terminal

Optional connections

• Front panel

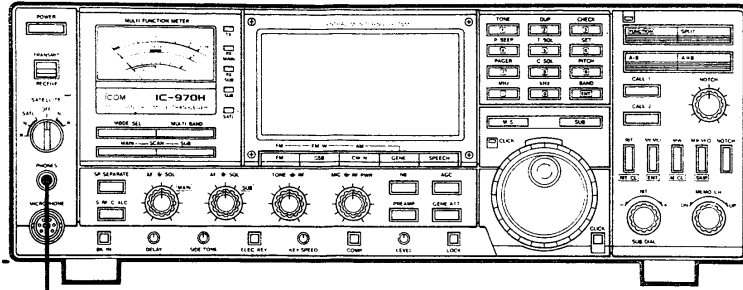

MB-19 RACK MOUNTING HANDLES

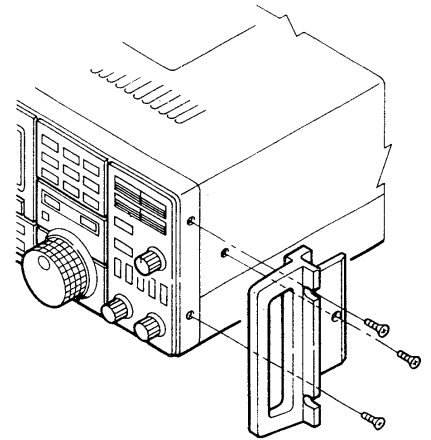

HEADPHONES

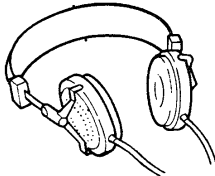

HP-2
Monaural headphones

When using stereo headphones, the MAIN and SUB band audio can be separately heard.

• Rear panel

DATA COMMUNICATIONS TERMINAL UNIT (p. 12)

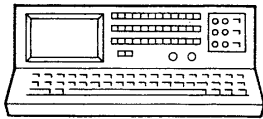

COMPUTER CONTROL AND TRANSCEIVE (p. 14)

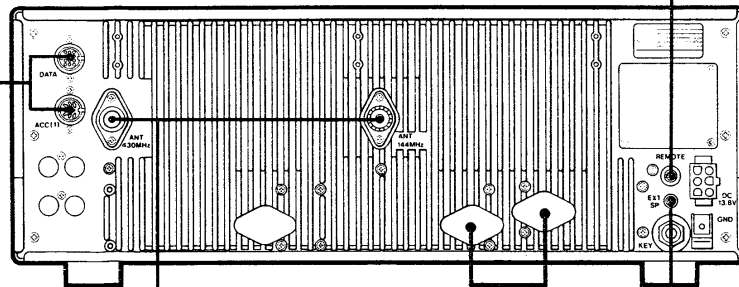
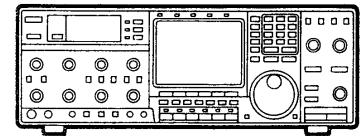
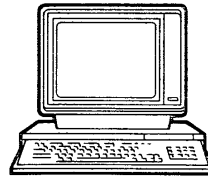

ANTENNA MOUNTING TYPE PREAMPLIFIER

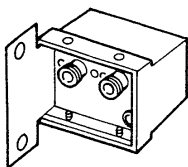

- AG-25 (144 MHz band)
- AG-35 (430 MHz band)
- AG-1200 (1200 MHz band)

OPTIONAL ANTENNA CONNECTORS

Use when installing an optional UX-97 1200 MHz BAND UNIT or UX-R96 RECEIVER UNIT.

EXTERNAL SPEAKER

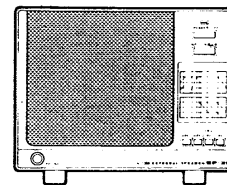

SP-20

Use with the [SP SEPARATE] switch for the MAIN and SUB band audios, combined or separate output

■ Linear amplifier connections

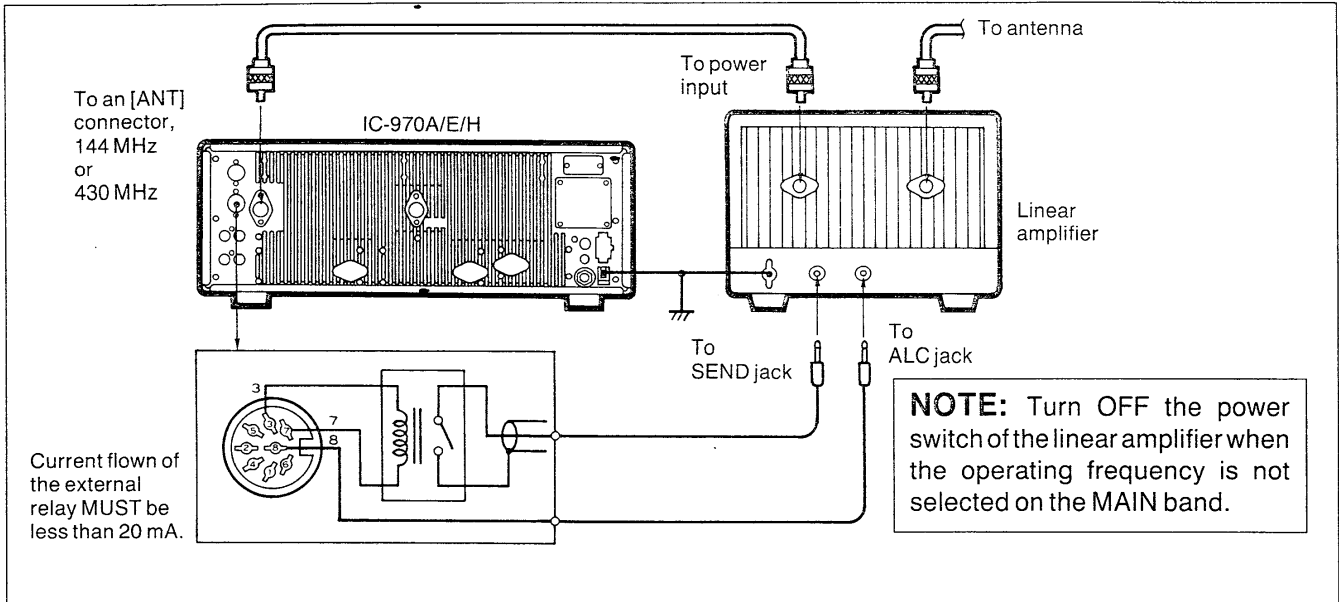

■ Data communications

When operating AFSK, AMTOR or packet, connect external equipment to the [DATA] or [ACC(1)] socket on the rear panel.

Read the instruction manual of an external unit for the detail connection.

• Using the [DATA] socket

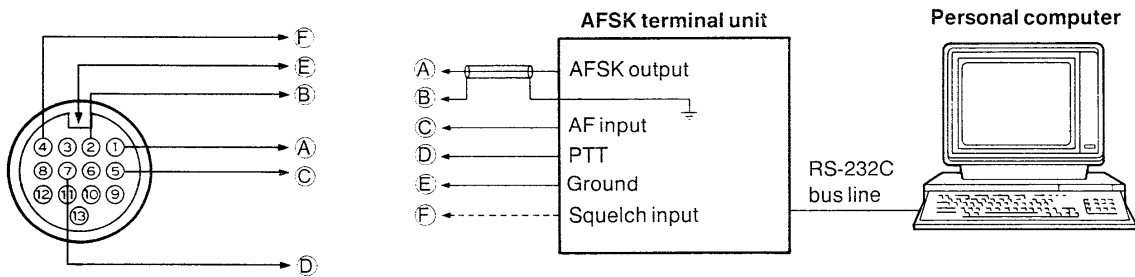

■ Microphone connector

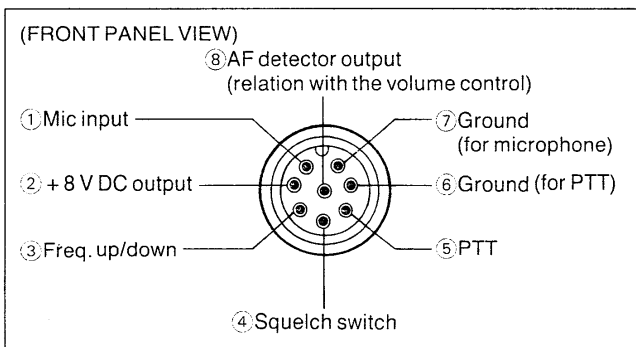

PIN NO.	FUNCTION	DESCRIPTION
②	+8 V DC output	Max. 10 mA
③	Frequency up	Ground
	Frequency down	Ground via 470 Ω
④	Squelch open	“LOW” level
	Squelch closed	“HIGH” level

CAUTION: DO NOT short pin ② to ground as this can damage the internal 8 V regulator.

3 ADVANCED CONNECTIONS

■ Accessory socket information

• DATA socket

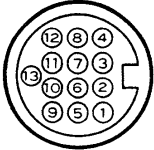
	PIN NO.	PIN NAME	DESCRIPTION		SPECIFICATIONS		
	①	MOD	Modulation input. Connected to a modulator. Regardless of [MIC] control. Selectable input level.	S1 (VR UNIT)	100 mV (Default)	Input impedance : 10 kΩ Input level : 100 mV (RMS)	
						3 mV	Input impedance : 600 Ω Input level : 3 mV (RMS)
	②	MOD (E)	Used as ground for modulation input.				
	③	ALC	ALC voltage input.			Control voltage : - 4 ~ 0 V Input impedance : More than 10 kΩ Connected in parallel with ACC (1) pin 8	
	④	SQL (M)	Squelch output. Goes to ground when MAIN band squelch opens.			Squelch open : 0.3 V/5 mA Squelch closed : 6.0 V/100 μA	
	⑤	AF (M)	Main band AF detector output. Regardless of [AF] control.			Output impedance : 4.7 kΩ Output level : 100 ~ 300 mV (RMS)	
	⑥	NC	No connection.				
	⑦	SEND	Input/output pin. Goes to ground when transmitting. When grounded, transmits.			Ground level : - 0.5 ~ + 0.8 V Input current : Less than 20 mA Connected in parallel with ACC(1) pin 3.	
	⑧	U/D	Frequency or memory channel control input.			When grounded directly, functions as UP. When grounded via 470 Ω, functions as DOWN.	
	⑨	AF (E)	Used as ground for AF output.				
	⑩	AF (S)	SUB band AF detector output. Regardless of [AF] control.			Output impedance : 4.7 kΩ Output level : 100 ~ 300 mV (RMS)	
	⑪	NC	No connection.				
	⑫	SQL (S)	Squelch output. Goes to ground when SUB band squelch opens.			Squelch open : 0.3 V/5 mA Squelch closed : 6.0 V/100 μA	
⑬	13.8 V	13.8 V output when power is ON.			Output voltage : 13.8 V DC Max. output current : 1 A		

• ACC(1) socket

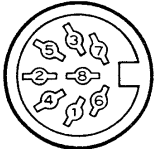
	PIN NO.	PIN NAME	DESCRIPTION	SPECIFICATIONS	
	①	ATV (M)	Microphone signal output to an external ATV unit.		
	②	ATVM (E)	Used as ground for ATV (M) output.		
	③	SEND	Input/output pin. Goes to ground when transmitting. When grounded, transmits.	Ground level : - 0.5 ~ 0.8 V Input current : Less than 20 mA Connected in parallel with [DATA] pin 7.	
	④	MOD	Modulation input. Connected to a modulator. Regardless of [MIC] control. Selectable input level.	Input impedance : 10 kΩ Input level : 100 mV (RMS)	
	⑤	AF (M)	Main band AF detector output. Regardless of [AF] control.	Output impedance : 4.7 kΩ Output level : 100 ~ 300 mV (RMS)	
	⑥	SQL (M)	Squelch output. Goes to ground when MAIN band squelch opens.	Squelch open : 0.3 V/5 mA Squelch closed : 6.0 V/100 μA	
	⑦	13.8 V	13.8 V output when power is ON.		Output voltage : 13.8 V DC Max. output current : 1 A
	⑧	ALC	ALC voltage input.		Control voltage : - 4 ~ 0 V Input impedance : More than 10 kΩ Connected in parallel with [DATA] pin 3.

Remote jack (CI-V)

CI-V connection example

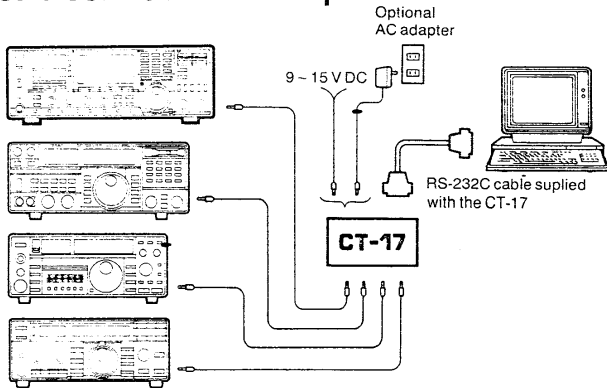

The transceiver can be connected through an optional CT-17 CI-V LEVEL CONVERTER to a personal computer equipped with an RS-232C I/O port. Icom Communication Interface-V (CI-V) controls frequency, mode, memory channels, etc.

The CT-17 allows up to 4 Icom CI-V transceivers or receivers for personal computer connections.

The CT-17 instruction manual describes some sample programs for controlling frequency, mode, memory channels, etc.

CI-V internal condition

To use the CI-V system, the following data are set with jumper leads on the LOGIC unit. They can be selected inside the transceiver for special settings while power is ON.

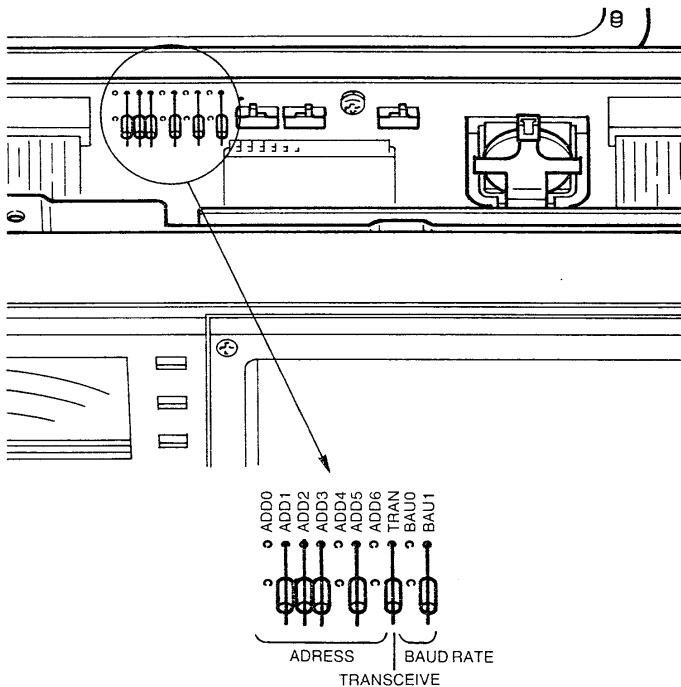

BAUD RATE

Baud rate is the data transfer rate. The standard Icom CI-V baud rate is 1200 bps.

BAUD RATE	BAU0	BAU1
300 bps	Insert	Insert
1200 bps	—	Insert
4800bps	Insert	—
9600bps	—	—

TRANSCEIVER ADDRESS

When the transceiver is controlled through the CI-V, the transceiver requires an independent address.

The IC-970A/E/H has the address of 2EH (46) as a default value. Figure marked with an H is hexadecimal and bracketed figures () are decimals.

ADD0 (1)	ADD1 (2)	ADD2 (4)	ADD3 (8)	ADD4 (16)	ADD5 (32)	ADD6 (64)
—	Insert	Insert	Insert	—	Insert	—

TRANSCEIVE

Transceive operation is possible using the IC-970A/E/H with another Icom CI-V transceiver or receiver. Either transceiver can be used as the transmitter or receiver.

TRANSCEIVE	TRAN
ON	Insert
OFF	—

CI-V external setting

Transceive ON/OFF and the baud rate can be temporarily changed without removing the top and bottom covers.

While pushing the [FUNCTION] switch and one of numeral keys listed in the table at right turn power ON to change the CI-V condition.

ITEM	SETTING OPERATION
Transceive OFF	[FUNCTION] + [2]
Transceive ON	[FUNCTION] + [3] or [4]
Baud rate 9600 bps	[FUNCTION] + [5]
Baud rate 4800 bps	[FUNCTION] + [6]
Baud rate 1200 bps	[FUNCTION] + [7]
Baud rate 300 bps	[FUNCTION] + [8]
Equals the LOGIC unit settings.	[FUNCTION] + [1]

Mode types

The transceiver has 3 different modes on the MAIN and SUB bands and 1 mode on both bands for versatile, multi-function operations.

• VFO mode (p. 17)

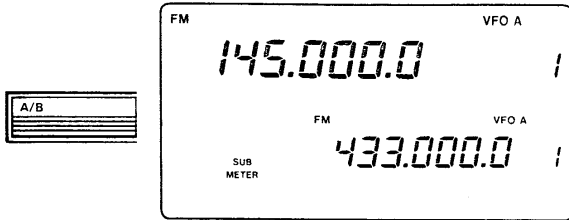

This mode is used for general operation. The transceiver has 2 VFOs, VFO A and VFO B, for storing 2 frequencies/modes separately.

- To select VFO mode and to change VFO A and B, push [A/B].

• MEMORY mode (p. 25)



This mode is used for operating the transceiver using memory channel contents.

- To select MEMORY mode, push [MEMO].
- The transceiver has 99 memory channels and 2 programmed scan edge channels.
- Each memory channel can store an operating frequency, mode, offset and subaudible tone frequencies.

• CALL CHANNEL mode (p. 28)

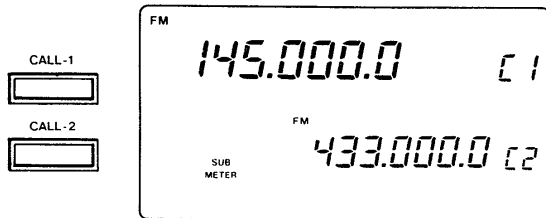

This mode provides a one-touch access call channel. The transceiver has one call-1 channel and call-2 channels separate from the memory channels. The call-1 channel can be quickly called up from any band and a call-2 channel is provided on each band.

- To access the call-1 channel, push [CALL-1].
- To access the call-2 channel, push [CALL-2].

• SATELLITE mode (p. 31)

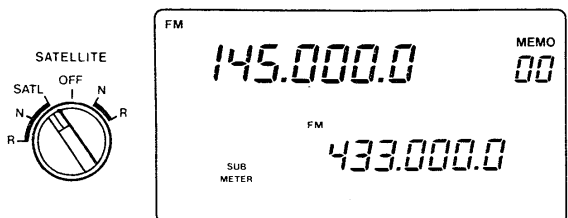

This mode is used for satellite operation with a satellite memory channel or with the displayed VFO or memory contents.

- To use SATELLITE mode with satellite memory, set the [SATELLITE] selector to [SATL] or the left side [N] or [R].
- To use SATELLITE mode without satellite memory, set the [SATELLITE] selector to the right side [N] or [R].
- [N] tracks in the same direction and [R] tracks in the opposite direction.

Initial settings

Be sure the following indicators disappear before reading this section.

The [kHz] or [MHz] keys turn off these indicators.

The [RIT] switch turns off this indicator.

The [MEMO] switch turns off these indicators.

The [LOCK] switch turns off this indicator.

[SUB]: The [SUB] switch turns off this indicator.

[SATL]: The [SATELLITE] switch turns off this indicator.

[kHz][MEMO]
[MHz]

[SATELLITE]

[SUB] [RIT]

[LOCK]

■ Exchanging the displayed MAIN and SUB bands

The function display shows both the MAIN and SUB band frequencies simultaneously.

Each push of [M/S] alternately exchanges the MAIN and SUB bands.

NOTE: The transceiver receives MAIN and SUB band frequencies simultaneously. However, the transceiver transmits only the frequency on the MAIN band display.

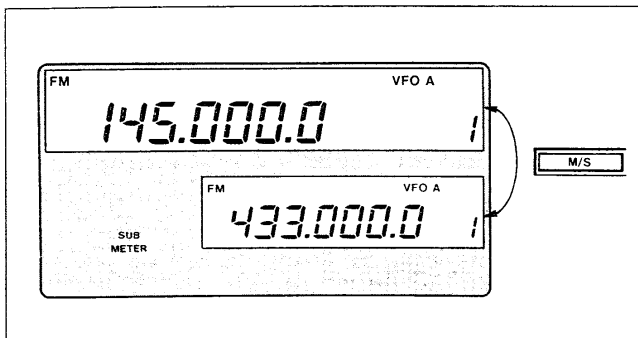

■ Selecting the SUB band

Frequency control, scanning, memory selection, etc., any functions can be operated on the MAIN band. They can also be used on the SUB band when the SUB band is selected.

SUB band selection is useful when receiving on the MAIN and SUB bands simultaneously and you want to temporarily receive only on the SUB band.

- 1) Push [SUB] to select the SUB band.
 - The red [SUB] indicator lights up.
- 2) Each push of [SUB] alternately selects the SUB and MAIN bands.

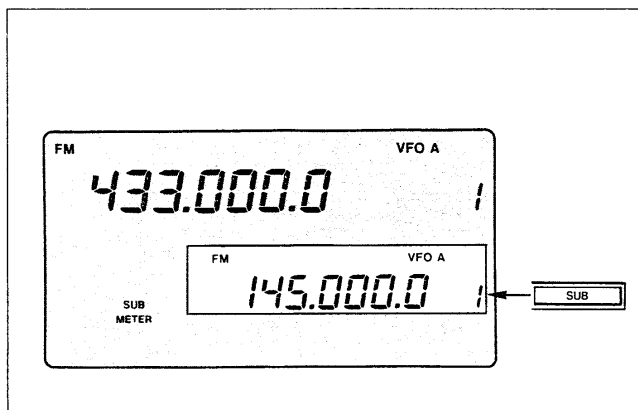

■ Selecting an operating band (optional)

When an optional band unit is installed, the band unit operation is retrieved as the MAIN or SUB band.

- 1) Push [M/S] to select the MAIN or SUB band for the band unit you wish to retrieve.
- 2) Push [BAND] to select an optional band unit.
- 3) Push [GENE] to select an optional UX-R96 RECEIVER UNIT.

NOTE1: When general coverage "GENE" is selected, [BAND] does not function.

NOTE2: The same operating band cannot be selected on the MAIN and SUB bands.

NOTE3: The same operating band can be used when selecting an operating band with an optional receiver unit.

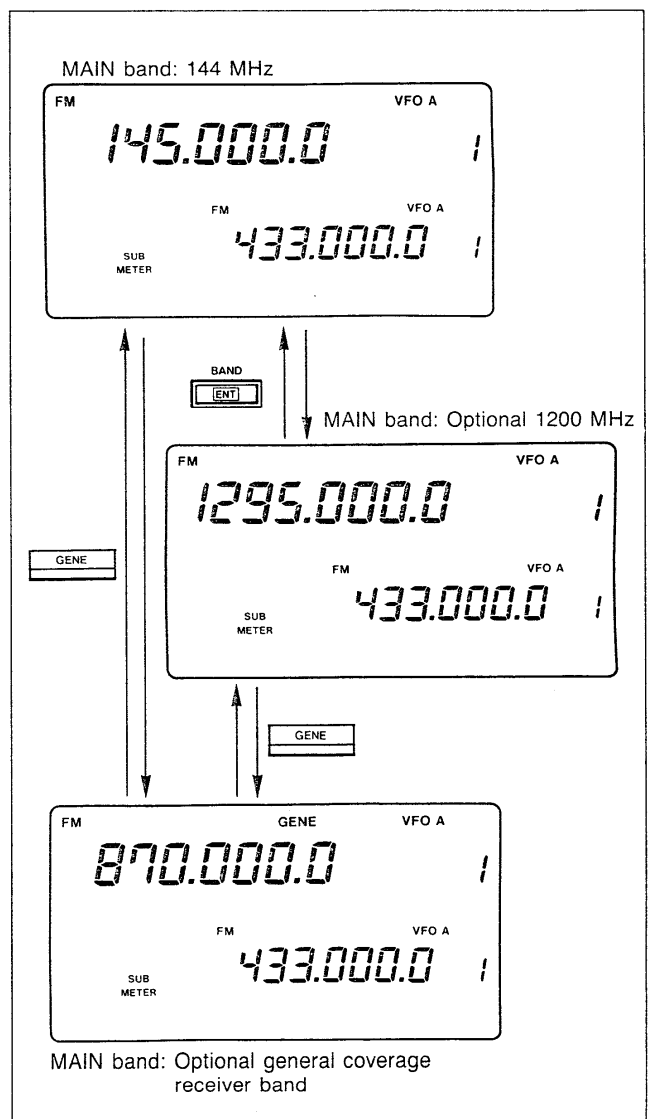

4 FREQUENCY SETTINGS

■ VFO operation

Each band has 2 VFOs for storing and retrieving the desired frequency instantly.

- 1) Push [A/B] to select VFO mode.
- 2) Push [A/B] again to change VFO A and B.
- 3) Push and hold [A = B] to equalize the undisplayed VFO to the displayed VFO.

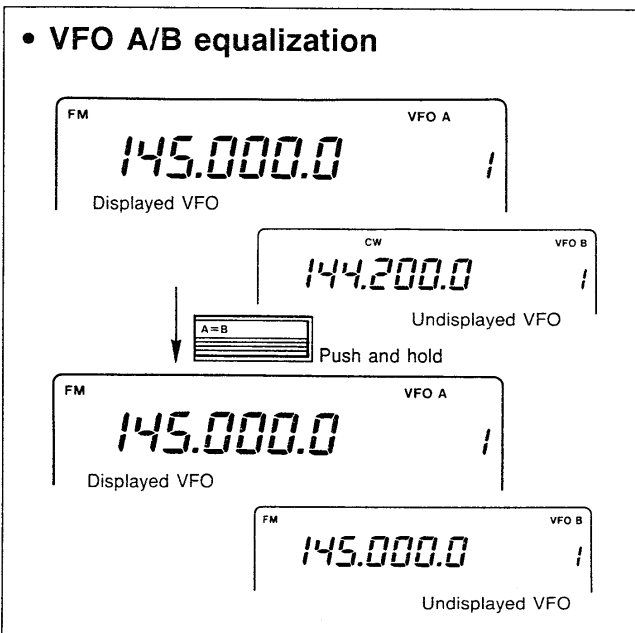
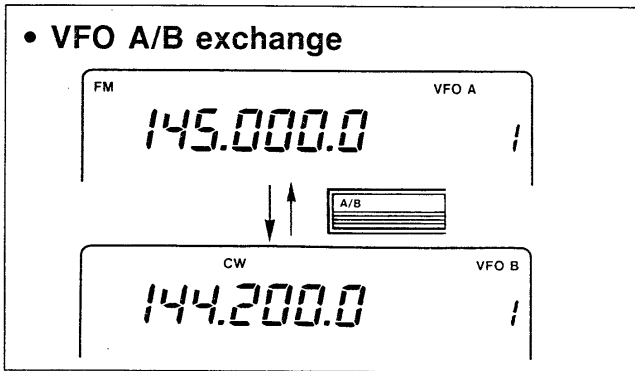

CONVENIENT

Use two VFOs as a quick memory

When you find a new station but you wish to continue searching, the twin VFO system is comfortable for quick memory.

- 1) Push and hold [A = B] to store the displayed frequency to another VFO.
- 2) Search a station to continue.
- 3) Push [A/B] to retrieve the stored frequency.
- 4) To continue searching push [A/B] again.
- 5) When you wish to keep the frequency, write the frequency into a memory channel.

■ Setting frequency with the keyboard

Direct frequency entry can be performed from the keyboard. When an optional band unit is installed, the direct entry can call up the undisplayed band frequency.

- 1) Push [M/S] or [SUB] to select the desired band.
 - The red indicator lights up.
- 2) Push [FUNCTION].
 - The red indicator lights up.
- 3) Enter the desired frequency with numeral keys.
 - Push the [.] key after entering a 1 MHz unit and before entering a 100 kHz unit.
- 4) Push the [ENT] key to enter the frequency.
 - Below the 1 MHz unit, successive "0" entry can be omitted with the [ENT] key.

EXAMPLES:

• Setting frequency at 145.00 MHz

Push keys:

Frequency readout: . 14.5 145. 145.000.0

• Setting frequency at 145.5 MHz

Push keys:

Frequency readout: . 14.5 145. 145.500.0

• Changing frequency from 145.5 MHz to 145.62 MHz

Push keys:

Frequency readout: 145. 145. 6.2 145.620.0

■ Setting frequency with the main dial

- 1) Push [M/S] or [SUB] to select the desired band.
- 2) Push the [kHz] or [MHz] key if you desire quick dialing.
 - “▼” appears on the 1-MHz digit or 1 kHz digit.
 - Push the same key again to clear “▼”
- 3) Rotate the main dial to set the desired frequency.

NOTE: In MEMORY mode, the displayed frequency can be changed with the main dial. However, the frequency may clear when changing memory channels or exiting MEMORY mode. To store the changed frequency into a VFO, push and hold [M▶VFO].

• Selecting the tuning pitch (tuning step)

A variety of tuning pitches can be used in FM mode or optional FM-W and AM modes. A tuning pitch can be separately programmed on each band.

- 1) Push [BAND] or [GENE] then push [M/S] or [SUB] to select the desired band.
- 2) Push [FM] to select FM mode.
 - When selecting the general coverage band, each mode can program a tuning pitch separately.
- 3) Push [9](PITCH) to select the tuning pitch setting display.
- 4) Rotate the main dial to select the desired tuning pitch.
- 5) Push [9](PITCH) again to return the display to the previous one.

TUNING PITCH LIST

AMATEUR BAND	GENERAL COVERAGE (OPTIONAL)	
	FM MODE	AM MODE
	FM/FM-W MODE	AM MODE
0.1 kHz	5.0 kHz	2.5 kHz
5.0 kHz	10.0 kHz	5.0 kHz
10.0 kHz	12.5 kHz	10.0 kHz
12.5 kHz	20.0 kHz	12.5 kHz
20.0 kHz	25.0 kHz	25.0 kHz
25.0 kHz	100.0 kHz	100.0 kHz
100.0 kHz		

• Pitch remainder hold

The frequency below the tuning pitch (remainder) is cleared when rotating the main dial normally. However, the remainder can be held, if you desire.

- 1) Push [9](PITCH) to select the tuning pitch setting display.
- 2) Push [0](kHz) to select the remainder clear or hold.
 - “oFF” appears for remainder hold.
 - “oFF” disappears for remainder clear.

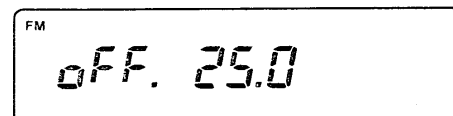

- 3) Push [9](PITCH) again to return the display to the previous one.

• Dial click function

The transceiver has a dial click function that makes the main dial click when rotating the main dial in greater than 5 kHz tuning steps.

- 1) Push the [CLICK] switch IN to set the click function in the auto position.
 - When the tuning steps are greater than 5 kHz, the [CLICK] indicator lights up and the function is activated.
- 2) Push [CLICK] OUT to turn OFF the click function.

NOTE: The click active condition can be changed by the internal switch under the top cover. See p. 42 for details.

• Dial lock function

The dial lock function deactivates the following switches and controls to prevent accidental frequency change during operation.

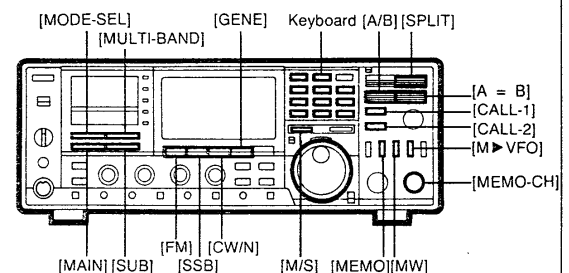

■ Initial settings

Set the switches and controls as below before reading this section.

• Switches

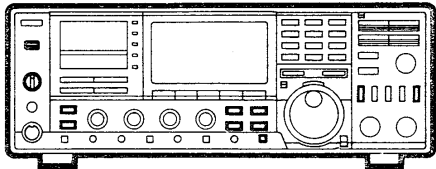

SWITCH	POSITION	SWITCH	POSITION
TRANSMIT/RECEIVE	RECEIVE	AGC	SLOW (OUT)
SATELLITE	OFF	GENE ATT	OFF (OUT)
SP SEPARATE	OFF (OUT)	LOCK	OFF (OUT)
S·RF/C·ALC	OFF (OUT)	RIT	OFF
NB	OFF (OUT)	NOTCH	OFF (OUT)
PREAMP	OFF (OUT)		

• Controls

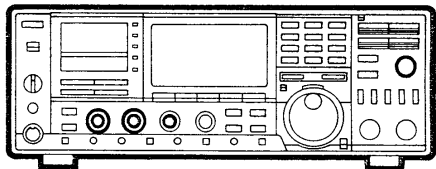

CONTROL	POSITION	CONTROL	POSITION
AF MAIN	Max. CCW	SQL SUB	Max. CCW
SQL MAIN	Max. CCW	TONE	Center
AF SUB	Max. CCW	NOTCH	Center

CCW: Counterclockwise

■ Basic receiving

The transceiver has dual watch capability that receives the MAIN and SUB band frequencies simultaneously. When you operate only 1 band, keep the SUB [AF] control to the maximum counterclockwise position.

- 1) Push [POWER] IN to turn ON power.
- 2) Push [M/S] to select the desired band for 144 MHz, or 430 MHz as the MAIN band frequency.
 - When an optional band unit is installed, push [BAND] to select the optional band.
 - If an optional general coverage band is selected, push [GENE] at fast. See p. 24 for details.
- 3) Push a mode switch [FM], [SSB] or [CW/N] to select the desired operating mode.
 - To select the operating mode in the SUB band, push [SUB] before pushing a mode switch.
 - To select LSB mode, push [SSB] 2 times.
 - To select CW narrow mode, push [CW/N] 2 times. An optional CW narrow filter is necessary. See p. 39 for installations.
- 4) Rotate the MAIN and SUB [AF] controls to obtain suitable audio listening levels.
- 5) Rotate the MAIN and SUB [SQL] controls clockwise if you want to mute the audio without a signal.
- 6) Push [SUB] to select the control band, MAIN or SUB.
 - The [SUB] indicator lights up while the SUB band is selected.
- 7) Set the desired receive frequencies on the MAIN and SUB bands using the keyboard or the main dial. See pgs. 17 and 18 for details.
 - When the RIT function is OFF, the [RIT] control activates as a SUB dial for sub frequency change.

• When receiving a signal

- Squelch opens and received audio is heard.
- An RX indicator lights up.
- An S-meter shows relative signal strength.

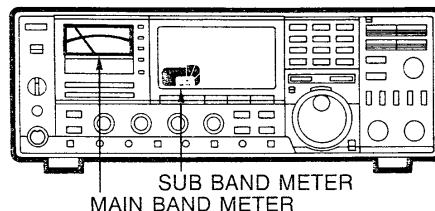

• To turn OFF the power

Push [POWER] OUT to turn OFF power then unplug the DC power cable or AC power cable (when using an optional IC-PS35 internal power supply). DO NOT unplug the cable before turning OFF the [POWER] switch.

■ High-quality receiving

• Center meter (MAIN band only)

Use a Center meter for fine tuning since the meter shows the signal deviation from the center frequency.

- Push [S-RF/C-ALC] IN for the center meter.
- Push [S-RF/C-ALC] OUT for the S-meter.

Center meter activates in FM only.

• Speaker separate function

The MAIN and SUB band audios can be separated. See p. 2 for details.

• RIT function (MAIN band only)

Use the RIT function when compensating for off frequencies of the communicating station.

The function shifts the receive frequency only up to ± 9.99 kHz in 10 Hz steps without moving the transmit frequency.

- 1) Push the [RIT] switch to activate the RIT function.
- 2) Rotate the [RIT] control to adjust the shift frequency.
- 3) To clear the shift frequency, push [FUNC] then [RIT].
- 4) To turn OFF the function, push [RIT] again.

When the RIT function is not used, the control can be used as the SUB band dial.

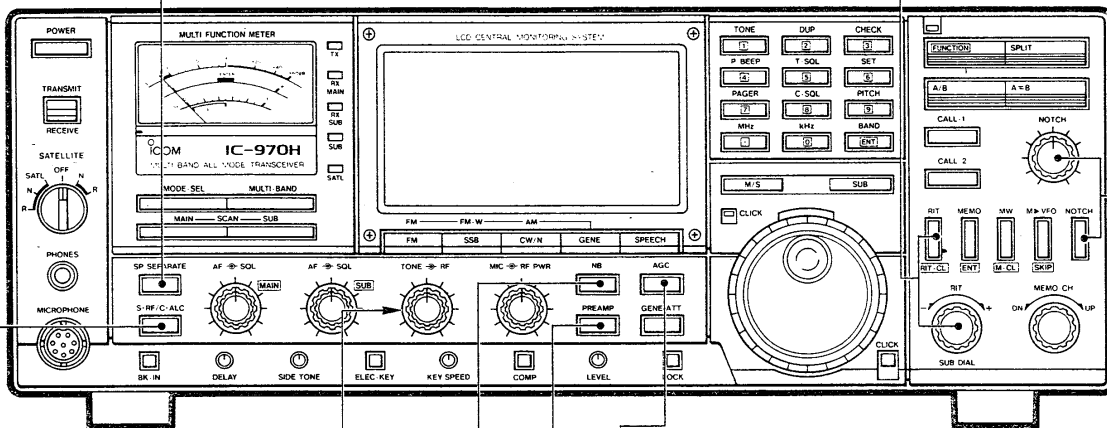

• RF gain (MAIN band only)

Rotate to counterclockwise when receiving a strong signal.

The control decreases amplifier gain in SSB and CW mode, or attenuates the receive signal before the front end stage in FM mode.

• Notch filter (MAIN band only)

The notch filter attenuates a particular frequency in the IF passband, such as that of an interfering signal.

- 1) Push the [NOTCH] switch.
- 2) Adjusts the [NOTCH] control to minimize interference.

• Noise blanker

Use the noise blanker while pulse-type

• AGC (MAIN band only)

■ Initial settings

Set the switches and controls as below before reading this section.

• Switches

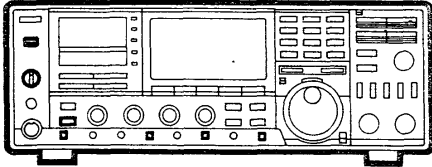

SWITCH	POSITION	SWITCH	POSITION
TRANSMIT/RECEIVE	RECEIVE	ELEC-KEY	OFF (OUT)
SATELLITE	OFF	COMP	OFF (OUT)
S·RF/C·ALC	OFF (OUT)	LOCK	OFF (OUT)
BK-IN	OFF (OUT)		

• Controls

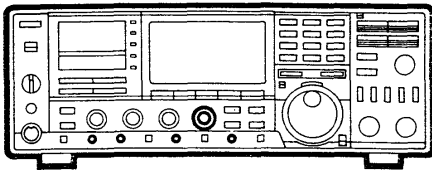

CONTROL	POSITION	CONTROL	POSITION
RF PWR	Max. CCW	SIDE TONE	Center
MIC	Center	KEY SPEED	Max. CCW
DELAY	Center	LEVEL	Max. CCW

■ Transmitting at FM or SSB

CAUTION: Transmitting without an antenna or when the antenna is in bad connection may damage the transceiver.

NOTE: The transceiver can transmit only on the MAIN band frequency.

- 1) Set the switches and controls as described above.
- 2) Push [M/S] to select the desired band.
- 3) Push a mode switch to select the operating mode.
 - To select LSB mode, push [SSB] 2 times.

- 4) Set the operating frequency in the MAIN band.
- 5) Push and hold the PTT switch on the microphone or set the [TRANSMIT/RECEIVE] switch upward to transmit.
 - The [TX] indicator lights up in red.
- 6) Adjust [RF PWR] to obtain desired output power.
- 7) Speak into the microphone using your normal voice level.
- 8) Adjust [MIC], if needed. See RF and ALC meter on the page at right.
- 9) Release the PTT switch or set the [TRANSMIT/RECEIVE] switch downward to receive.

■ Operating through a repeater

When operating through an FM repeater, set the transceiver to duplex.

- 1) Push [FM], then set the frequency to the desired repeater output frequency on the MAIN band display.
- 2) Push the [2](DUP) key to select the – duplex or push [2] again to select the + duplex.
 - “DUP – ” or “DUP + ” appears on the function display.
 - Refer to the page at right for offset frequency setting.
- 3) Turn ON the subaudible tone encoder or transmit a 1750 Hz tone corresponding to a repeater. See below for details.
- 4) Push and hold the PTT switch to transmit.
 - After speaking, release the PTT switch to return to receive.
- 5) To check the transmit frequency (repeater input frequency), push [3](CHECK).
 - This allows checking of the signal strength of your connected station directly without going through a repeater.

• Subaudible tone encoder (IC-970A/H only)
Push the [1](TONE) key to turn ON and OFF the tone encoder. For setting a tone frequency, see right page for details.
Pushing [FM] twice can select the – duplex and subaudible tone encoder simultaneously.

• 1750 Hz tone call (IC-970E/H only)
Push and hold the [1](TONE) key for 1 ~ 3 sec. to transmit a 1750 Hz tone before transmitting a voice signal.

Efficient transmitting

• Speech compressor (SSB only)

The speech compressor increases average output power, improving signal strength and intelligibility in SSB.

- 1) Set the switches and controls.
 [COMP] : IN
 [LEVEL] : Center
 [S-RF/C-ALC] : IN (ALC)
 [MIC] : See RF and ALC meter below
- 2) Speak naturally into the microphone and adjust the compressor [LEVEL] control so that the ALC meter needle sometimes moves.

• RF and ALC meter

The function meter can be selected to act as an RF meter or an ALC meter while transmitting.

The RF meter shows the relative output power and the ALC meter shows the ALC activating level. Adjust the [MIC] control so that the ALC meter needle sometimes moves with your normal voice level.

• Split operation

The split (duplex) function uses 2 VFOs as transmit and receive frequencies for separated frequency operation.

- 1) Set the transmit frequency in a VFO.
- 2) Push [A/B] to select the other VFO.
- 3) Set the receive frequency.
- 4) Push [SPLIT].
 • "SPLIT" appears on the function display.
- 5) Push and hold the PTT switch on the microphone to transmit.
 • The function display shows the transmit frequency.
- 6) To monitor the transmit frequency, push and hold [CHECK].

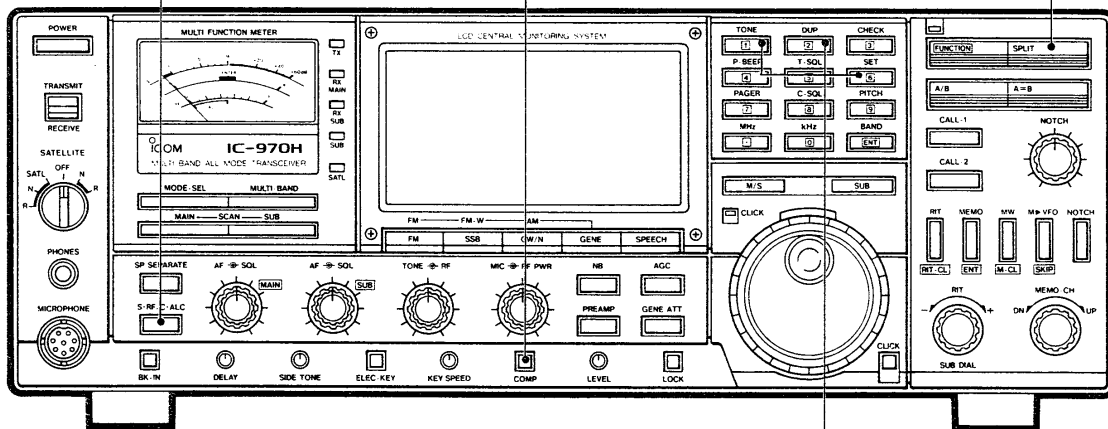

• Setting offset and subaudible tone frequencies

- 1) Push the [2](DUP) or [1](TONE) key to set an offset or subaudible tone* frequency respectively.
 * IC-970A/H only.
- 2) Push the [6](SET) key to select a frequency setting display as at right.
- 3) Rotate the main dial to select the desired frequency.
- 4) Push the [6](SET) key to exit or advance the setting display.

OFFSET FREQUENCY

0.600.0
DUP --

(The above shows 600 kHz of offset)

SUBAUDIBLE TONE FREQUENCY

. 88.5
STONE

(The above shows 88.5 Hz tone.)

■ Transmitting in CW mode

Plug a CW key into the [KEY] jack on the rear panel. The transceiver accepts a straight key or an electric keyer.

An iambic keyer paddle can also be used when an optional IC-EX243 ELECTRONIC KEYSER UNIT is installed.

- 1) Set the switches and controls as described on p. 21.
- 2) Push [M/S] to select the desired band.
- 3) Push [CW/N] to select CW mode.
 - To select an optional CW narrow mode, push [CW/N] 2 times.
- 4) Set the operating frequency in the MAIN band.
- 5) Set the [TRANSMIT/RECEIVE] switch upward.
- 6) Operate the CW key.
- 7) Adjust [RF PWR] to obtain desired output power.
- 8) Adjust [SIDE TONE] to the desired monitor level.
- 9) Set the [TRANSMIT/RECEIVE] switch downward to return to receive.

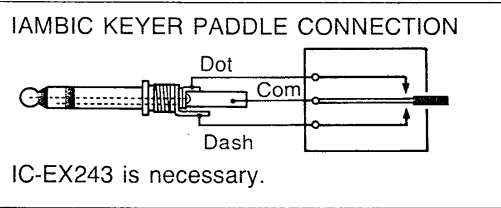
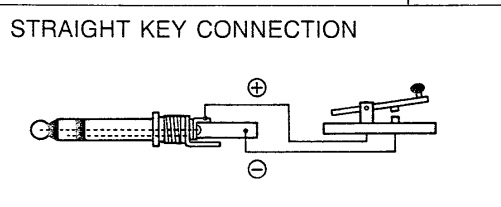
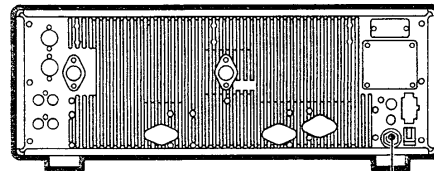

• **Split operation**
See p. 22 for details.

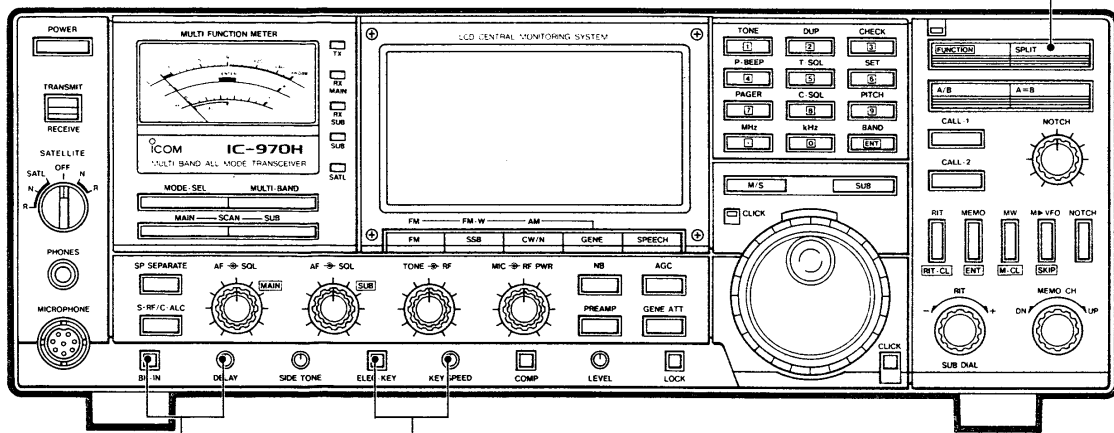

• **Break-in operation**
Automatic transmit selection can be performed with the break-in operation. Operate a CW key while receiving.

- 1) Push [BK-IN] IN.
- 2) Adjust [DELAY] while operating the CW key.

• **Optional electric keyer**
When an optional IC-EX243 ELECTRIC KEYSER UNIT is installed, [ELEC-KEY] and [KEY SPEED] can be used.

- 1) Plug an iambic keyer paddle into the [KEY] jack.
- 2) Push [ELEC-KEY] IN.
- 3) Adjust [KEY SPEED] while operating the key paddle.

UX-R96 specifications

An optional UX-R96 RECEIVER UNIT is necessary for general coverage receiving. See p. 38 for unit installation.

Frequency coverage	50.00 ~ 905.00 MHz
Mode	FM, FM wide (FM-W), AM
Tuning steps	2.5 kHz (AM only), 5.0 kHz, 10 kHz, 12.5 kHz, 20 kHz, 25 kHz, 100 kHz

NOTE: AVOID to transmit on the same frequency as displayed general coverage receiver frequency.

Operation

- 1) Push [POWER] IN to turn ON power.
- 2) Push [GENE] to retrieve the general coverage receiver band.
 - "GENE" appears on the function display.
- 3) Push [M/S] to select the MAIN or SUB band for the receiver band in use.
- 4) Push [SUB] when the receiver band is selected as the SUB band.
- 5) Push a mode switch to select the desired mode, FM, AM or FM-W.
- 6) Set the desired frequency using the keyboard with [FUNCTION] or the main dial.

• RF gain

Does not act in the receiver band.

• AGC

AGC is selected in "fast" regardless of the switch positions in the receiver band.

• Notch filter

Not effective in the receiver band.

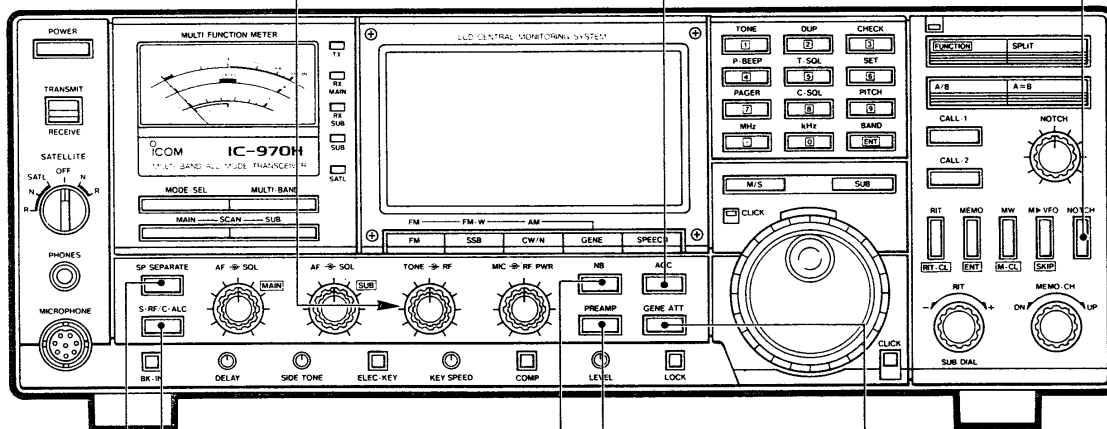

• Speaker separate function

The MAIN and SUB band audios can be separated. See p. 2 for details.

• Noise blanker

Reduces pulse-type noise in AM mode. Audio level may decrease when using the noise blanker.

• Attenuator

[GENE ATT] acts in the receiver band. Use the attenuator when background noise increases or a very strong signal appears near your receiving frequency.

• Center meter

The Center meter does not act in the receiver band.

• Preamp

Increases the receiver sensitivity. Preamp gain is approx. 15 dB. Note that the intermodulation and cross modulation characteristics may decrease while activating the preamplifier.

Memory mode

The MAIN and SUB bands can be selected in VFO or MEMORY mode separately. Each band has 99 memory channels and 2 scan edge channels, a total of 202 memory channels can be used even when no optional band unit is installed.

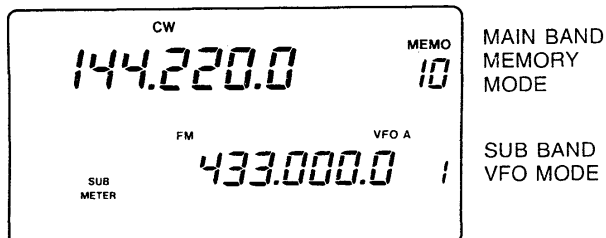
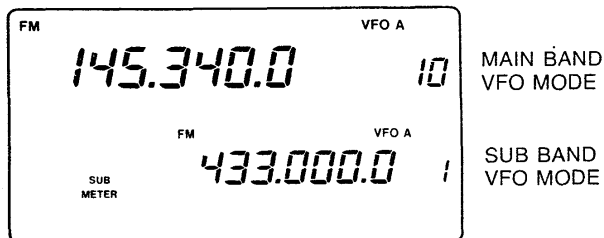
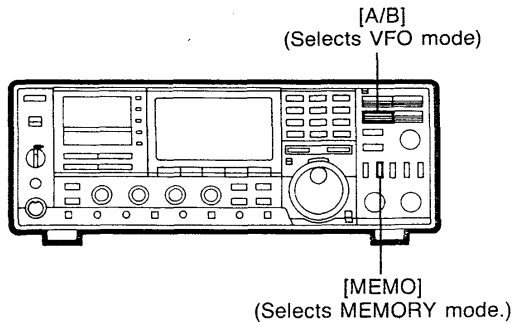

Memory channel selection

Using the [MEMO-CH] selector for memory channel selection.

- 1) Push [MEMO] to select MEMORY mode.
 - "MEMO" appears on the selected band, MAIN or SUB.
- 2) Rotate the [M-CH] selector to select the desired memory channel.
 - When a blank channel (memory contents not yet programmed) is selected, only the decimal points appear.
 - The [MODE-SEL] and [MULTI-BAND] switches allow unique memory selection. See below for details.
- 3) Push [A/B] to return to VFO mode.

Using the keyboard for memory channel selection.

- 1) Push [MEMO] to select MEMORY mode.
- 2) Push [FUNCTION].
 - The indicator above [FUNCTION] lights up.
- 3) Push digit keys to enter the memory channel number.
- 4) Push [MEMO] to select the memory channel.
 - The [FUNCTION] switch indicator goes off.

The mode-select function

The mode-select function selects only the same mode programmed memory channels when using the [MEMO-CH] selector. This function allows you quick memory channel selection in your desired mode.

- 1) Push [MEMO] to select MEMORY mode.
- 2) Push [MODE-SEL] to set the mode-select function.
 - "MODE-SEL" appears on the function display.
- 3) Push the appropriate mode switch to select your desired mode for the mode-select function.
- 4) Rotate the [MEMO-CH] selector to select memory channels programmed only in the same operating mode.
- 5) Push [MODE-SEL] to cancel the mode-select function.

The multi-band memory function (SUB band only)

When an optional band unit is installed, all memory channels in the SUB band and undisplayed band can be selected with the [MEMO-CH] selector. Memory channels in an optional general coverage receiver band cannot be selected.

- 1) Push [SUB] to select the SUB band.
- 2) Push [MEMO] to select MEMORY mode.
- 3) Push [MULTI-BAND] to set the the multi-band memory function.
 - "MULTI-BAND" appears on the function display.
- 4) Rotate the [MEMO-CH] selector to select all memory channels in the SUB band and undisplayed band.
 - Blanked memory channels do not appear.
- 5) Push [MULTI-BAND] to cancel the multi-band memory function.

Memory writing

Each memory channel memorizes an operating frequency, mode and offset, subaudible tone encoder and optional tone squelch frequencies. Memory writing can be performed from both VFO and MEMORY mode.

1) Select the memory channel you wish to memorize with the [MEMO-CH] selector or the keyboard.

2) Set the frequency and mode. If desired, set the required repeater frequency such as offset and subaudible tone.

- When a blank memory channel is selected on MEMORY mode, push [A/B] to set the frequency, etc.

3) Push and hold [MW] for 1 sec. to program the contents into the memory channel.

- 3 beeps alert you that the contents are programmed.

EXAMPLE:

Writing 145.6 MHz/FM with –duplex into memory channel 88.

Changing contents in memory channel 89 from 145.8 MHz/FM to 145.7 MHz/FM.

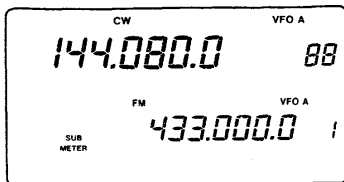

Push [A/B].
Rotate [MEMO-CH] to select Mch 88.

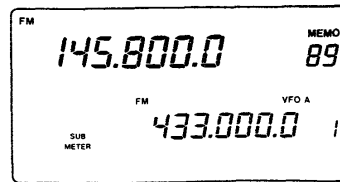

Push [MEMO].
Rotate [MEMO-CH] to select Mch 89.

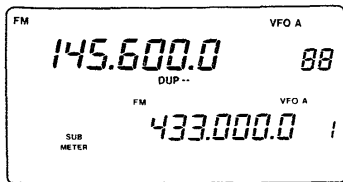

Set as follows:
Freq.: 145.6 MHz
Mode: FM
Dup: – Duplex

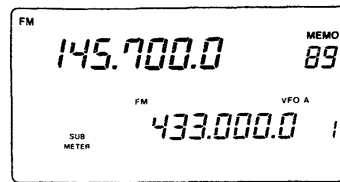

Rotate the main dial to change the freq. to 145.7 MHz.

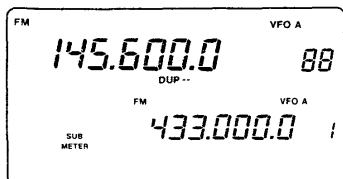

Push and hold [MW].

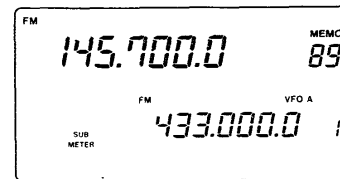

Push and hold [MW].

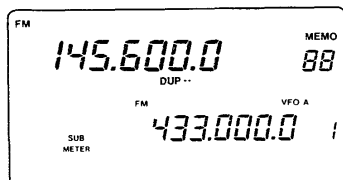

To confirm, push [MEMO].

8 MEMORY CHANNEL OPERATION

■ Memory transferring

The selected memory contents in a memory channel can be transferred to a VFO. The transferring can be performed in both VFO and MEMORY mode.

When transferring from MEMORY mode, the previously selected VFO, A or B receives the memory contents.

- 1) Select the memory channel you wish to transfer into a VFO.
- 2) Push and hold [M▶VFO] for 1 sec.
 - 3 beeps alert you that the contents are transferred.
 - When the selected memory channel is a blank channel, transferring cannot be performed and the transceiver emits only 1 beep.

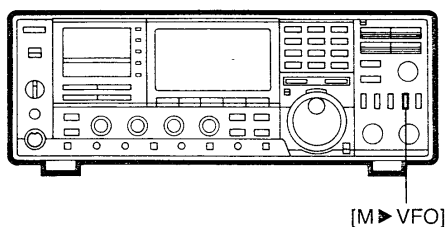

(Contents in memory channel 88:
145.6 MHz/FM/DUP -)

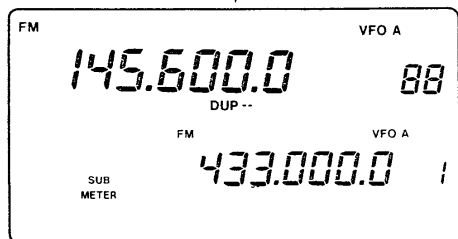
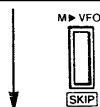
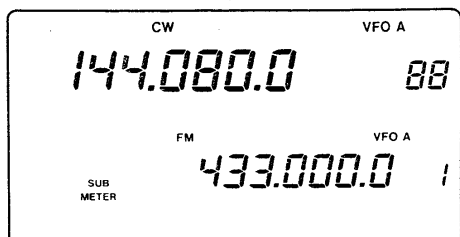

■ Memory clearing

The memory clearing function clears the contents in a memory channel. This function can be performed in MEMORY mode.

- 1) Push [MEMO] to select MEMORY mode.
- 2) Select the memory channel you wish to clear the contents of.
- 3) Push [FUNCTION], then push and hold [MW] for 1 sec.
 - 3 beeps are emitted and the memory contents are cleared from the function display.
 - 2 sec. after the contents are cleared, the display shows the operating band.

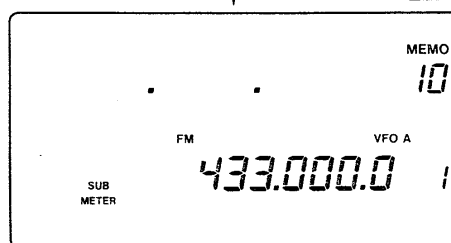
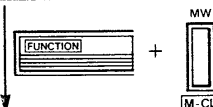
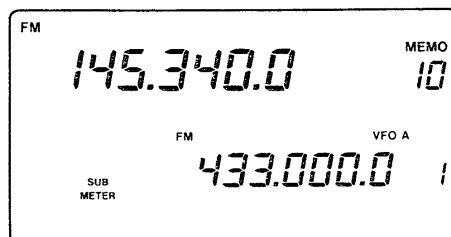
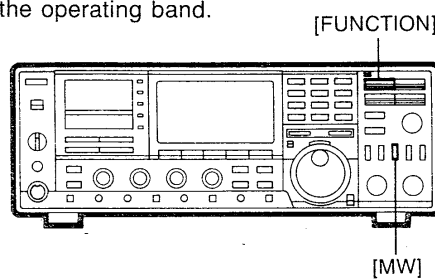

The operating band appears 2 sec. after keeping blank channel.

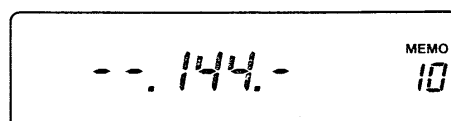

The above display shows that the 144 MHz band is selected.

■ Call channel outline

The transceiver has 1 call channel (call-2 channel) on each band and 1 independent call channel (call-1 channel) regardless of the selected band.

A call channel memorizes an operating frequency, mode and required repeater frequencies (offset and tone).

■ Calling up call-1 channel

- 1) Push [CALL-1] to call up the call-1 channel.
 - "C1" appears instead of the memory channel number.
- 2) Push [A/B] or [MEMO] to exit the call-1 channel.

EXAMPLE:

When 145.5 MHz is programmed in the call-1 channel.

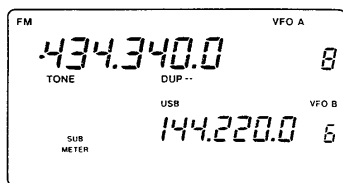

MAIN band:
430 MHz band

SUB band:
144 MHz band

Operating in
the MAIN band
(SUB indicator
does not light.)

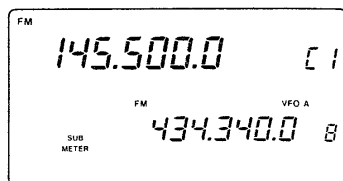

MAIN band:
144 MHz band

SUB band:
430 MHz band

When the SUB band is selected, the call-1 channel is retrieved on the SUB band.

■ Calling up call-2 channel

- 1) Push [CALL-2] to call up the call-2 channel.
 - "C2" appears instead of the memory channel number.
- 2) Push [A/B] or [MEMO] to exit the call-2 channel.

■ Call channel writing

- 1) Select VFO or MEMORY mode.
- 2) Set the frequency. Also the required repeater frequency such as offset and subaudible tone, if desired.
- 3) While pushing [FUNCTION], push and hold the desired call switch, [CALL-1] or [CALL-2].
 - 3 beeps alert you that the contents are programmed.

EXAMPLE:

Writing 145.6 MHz/FM with – duplex into call-2 channel.

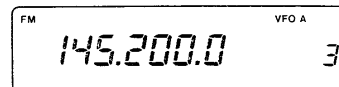

Select VFO or
MEMORY mode



Set as follows:
Freq. 145.6 MHz
Mode FM
Dup – duplex



While pushing
[FUNCTION], push
and hold [CALL-2]

• Changing frequency in a call channel

While selecting a call channel, the frequency can be changed, if desired.

- While pushing the [CALL-1] or [CALL-2] switch, rotate the main dial to change the frequency.
- The keyboard can be used for frequency setting in a call channel.

• Transferring call channel contents to a VFO

Call channel contents can be transferred to a VFO the same as in memory transferring.

- 1) Call up a call channel.
- 2) Push and hold [M>VFO] for 1 sec.

10 SCAN OPERATION

Scan types

Programmed scan

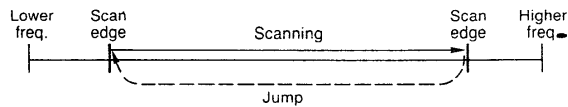

Repeatedly scans between 2 user-programmed scan edges P1 and P2 in the selected tuning step.

- The scan edge frequencies can be programmed in each operating band such as 144 and 430 MHz bands.

Mode-select memory scan

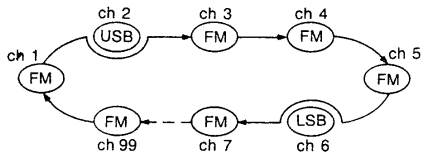

Repeatedly scans memory channels with the same selected operating mode in the selected band.

- The memory skip function can be used.
- The mode-select function simultaneously acts in the MAIN and SUB bands.

Memory skip function

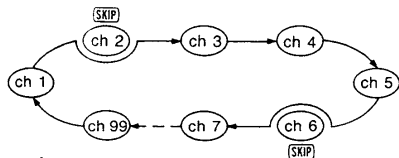

Skips unnecessary memory channels for scanning, making shorter intervals for memory scanning and preventing scan stop on unnecessary channels.

Scanning can be separately operated in the MAIN and SUB bands.

Memory scan

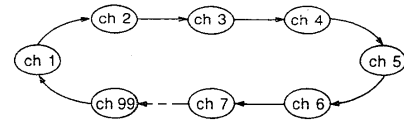

Repeatedly scans all memory channels in the selected band. Of course, blank channels (frequency has not been programmed yet) are skipped.

- The memory skip function can be used for skipping unnecessary memory channels.

Multi-band memory scan (SUB band only)

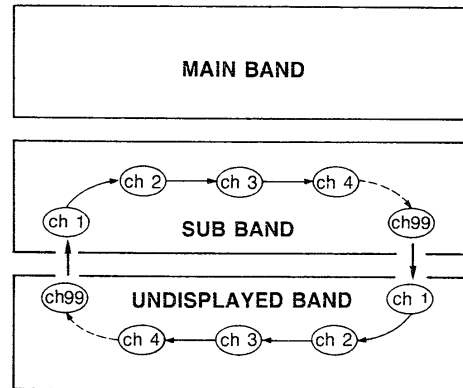

When an optional band unit is installed, multi-band memory scan can be used. This scan repeatedly scans all memory channels in the SUB band and un-displayed band except the general coverage receiver band.

- The memory skip and mode-select functions can be used.
- In the general coverage receiver band, multi-band memory scan acts as a memory scan.

CONVENIENT

Scan resume condition

The scan resume condition can be selected as "scan cancel" and "scan resume" with the internal scan resumption switch. See p. 42 for details.

Scan speed

The internal scan speed switch selects the scan speed fast and slow. The switch is set at fast when you purchase the transceiver.

Scanning while squelch opens

The programmed scan can be used even when the squelch opens in SSB or CW mode or in FM mode with 1 kHz step. The scan starts 10 sec. after a scan switch is pushed and pauses for 10 sec. when the squelch changes from close to open.

The function activates when the internal scan resumption switch is set to "scan resume." See p. 42 for switch location.

■ Operation

SCAN TYPE	PRESET 1	PRESET 2	SCAN START	SCAN STOP
PROGRAMMED SCAN	① Push [SUB] to select the desired band for scanning. ② Adjust [SQL] to the threshold point.	Push [A/B] to select VFO mode.	Push [MAIN] or [SUB] scan switch.	Push the same scan switch [MAIN] or [SUB] pushed at scan start. • [A/B], [MEMO], [CALL-1] [CALL-2] and main dial also stops a scan.
MEMORY SCAN		Push [MEMO] to select MEMORY mode.		
MODE-SELECT MEMORY SCAN		① Push [MEMO] to select MEMORY mode. ② Push [MODE-SEL] to activate the mode-select function. ③ Push a mode switch you wish to scan.		
MULTI-BAND MEMORY SCAN		① Push [SUB] to select the SUB band. ② Push [MEMO] to select MEMORY mode. ③ Push [MULTI-BAND] to activate the multi-band memory function.	Push [SUB] scan switch.	

• Memory skip function setting

- 1) Push [MEMO] to select MEMORY mode.
- 2) Rotate the [MEMO-CH] selector to select the memory channel you wish to set as the skip channel.
- 3) Push [FUNCTION], then push [M▶VFO] to set the channel as the skip channel.
 - "SKIP" appears under the memory channel number.
- 4) To cancel the skip function from the channel, repeat step 3 again.

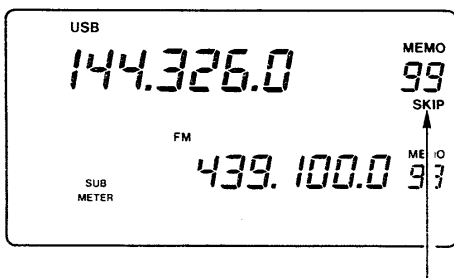

"SKIP" appears at a skip channel.

• Programmed scan edges

Remember, programmed scan repeatedly scans between your desired frequencies. The scan edge programming are the same as memory writing on memory channels P1 and P2. Each operating band has memory channels P1 and P2.

- 1) Rotate the [MEMO-CH] selector to select memory channel P1.
 - The memory channel can also be selected from the keyboard. See below for details.
- 2) Set your desired programmed scan edge frequency using the main dial or the keyboard.
- 3) Push and hold [MW] to program the frequency as a scan edge.
- 4) Rotate the [MEMO-CH] selector to select memory channel P2.
- 5) Set the other side edge frequency using the main dial or the keyboard with [FUNCTION].
- 6) Push and hold [MW] to program the frequency as the scan edge frequency on the other side.

SELECTING MEMORY CHANNEL FROM KEYBOARD

P1 :

P2 :

11 SATELLITE OPERATION

■ Satellite communication outline

The transceiver can track the MAIN and SUB band frequencies in the same (normal) or opposite (reverse) direction. This function is very convenient for satellite communications.

Satellite mode B can be accessed without an optional unit and mode L can be accessed with an optional UX-97 1200 MHz BAND UNIT.

Satellite communications may require an optional preamplifier, beam antennas with a rotor, headphones, orbit information and satellite communications techniques.

• Mode B operating diagram

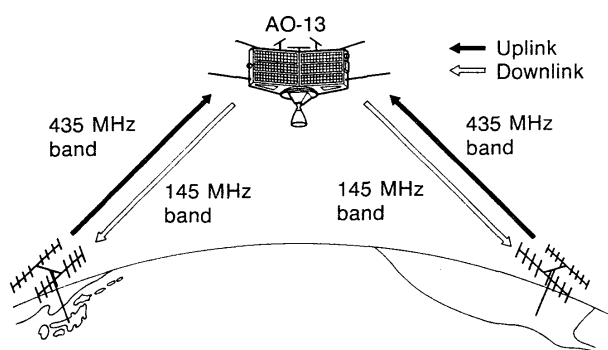

The frequency in the above diagram shows an operating example with AO-13 mode B.

Mode B	
Uplink frequency	: 435.423 ~ 435.573 MHz (LSB/CW)
Downlink frequency	: 145.975 ~ 145.825 MHz (USB/CW)
Tracking direction	: Reverse
General beacon frequency	: 145.812 MHz
Engineering beacon frequency	: 145.985 MHz

■ Operation

- 1) Set the [SATELLITE] switch to [SATL] to select SATELLITE mode.
- 2) Rotate the [MEMO-CH] selector to select the desired satellite memory channel.
 - See the page at right for memory writing details.

NOTE: Setting frequencies may be cleared when you change the memory channel or exit SATELLITE mode before the frequencies are programmed in the memory channel.

- 3) Set the uplink frequency and mode in the MAIN band display.
- 4) Push [SUB], then set the downlink frequency and mode in the SUB band display.
- 5) Set the [SATELLITE] switch to the left setting to the [N] or [R] position.
 - [N]: Normal, tracking in the same direction.
 - [R]: Reverse, tracking in the opposite direction.
- 6) Be sure the [SUB] indicator lights up, then rotate the main dial to tune to a beacon frequency.
- 7) Set your antenna angle while receiving the beacon signal.
- 8) Rotate the main dial to set the desired frequencies.
- 9) Push and hold the PTT switch, and then make loop test at the selected frequency.
 - See the page at right for loop test details.
- 10) To compensate for the Doppler Effect, push the [SUB] switch to select the MAIN band, then rotate the main dial while listening to the downlink signal on the SUB band.
- 11) Release the PTT switch to return to receive.
- 12) Set [SATELLITE] to "OFF" to exit SATELLITE mode.

• **SATELLITE mode operation**

MAIN and SUB band frequencies can be set separately on a satellite memory channel.

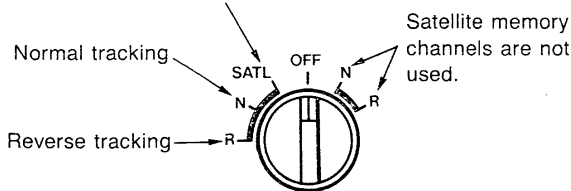

Used as the uplink frequency
A satellite memory channel number

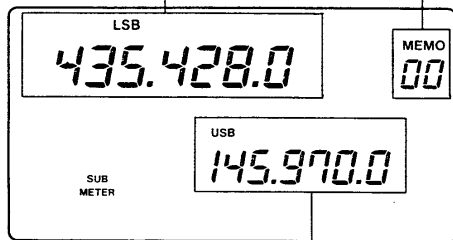

Used as the downlink frequency

• **Loop test**

The loop test checks if your transmit signal can reach a satellite and if the transceiver can receive a satellite signal. While wearing headphones, transmit your voice signal on the MAIN band (uplink frequency) and simultaneously monitor the feedback signal from the satellite on the SUB band (downlink frequency).

- The Doppler Effect may occur. At this time, compensate for the effect on the MAIN band frequency.

• **Orbit information**

Orbit information describes satellite locations, reaching angles, etc. This information may be available in a ham magazine or organizations issue such as from ARRL, RSGB hand book, etc.

■ **Satellite memory writing**

The transceiver has 10 satellite memory channels to memorize both uplink and downlink frequencies and modes.

- 1) Set the [SATELLITE] switch to [SATL] to select SATELLITE mode.
- 2) Rotate the [MEMO-CH] selector to select the desired memory channel.
- 3) Set an uplink frequency and mode on the MAIN band, and a downlink frequency and mode on the SUB band.
- 4) Push and hold [MW] for 1 sec. to program the contents into the memory channel.
 - 3 beeps alert you that the contents are programmed.

EXAMPLE:

Writing the AO-13 frequencies into memory channel 7.

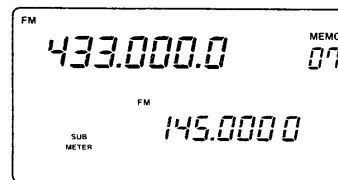

Set [SATELLITE] to [SATL].

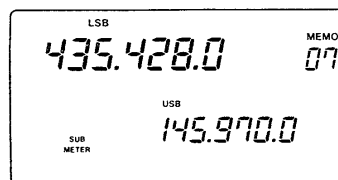

Rotate [MEMO-CH] to select the memory channel.

Set the MAIN and SUB band frequencies and modes.

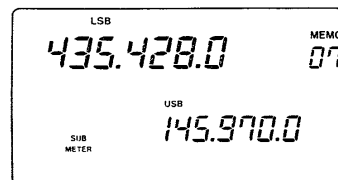

Push and hold [MW].

General description

The pager and code squelch functions can be used in the MAIN band with FM mode only.

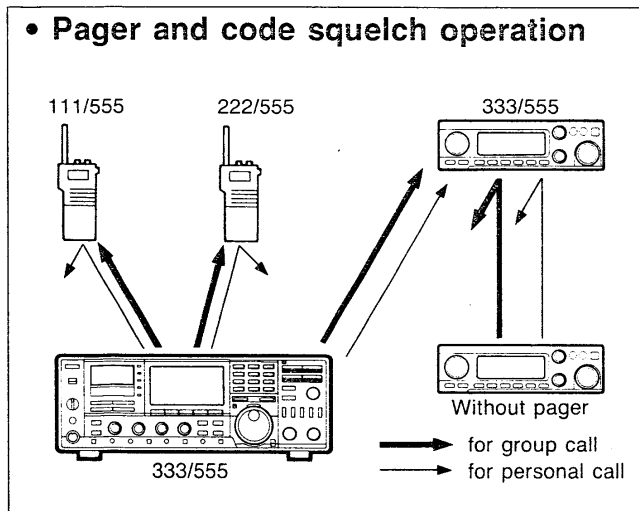

• Pager function

The pager function informs your ID code, decided in your group, to the contacting station's display with beep tones. When receiving the code signal, the pager function automatically stores the received ID code and selects the code as a transmit code. An answer back code for contact confirmation is therefore easy to send.

You can call your desired station or all stations in your group because the function has a personal call and group call. Use the pager function for calling and the code squelch for communications.

The pager function transmits a code with 7 DTMF digits: (Transmit code) + * + (your ID code)

• Code squelch function

The code squelch is a selective communication system that allows you silent standby since you will receive only a call from the station known as your ID code.

The code squelch function transmits a code of 3 DTMF digits.

Code memory programming

• Before programming

Before operating the pager function, the following contents are necessary for determining your group.

- ① ID code of each transceiver and the group code in your group.
- ② With or without code squelch for communication after contact.

• Channel assignment

ID or group code	Code memory channel	SKIP or NON-SKIP
Your ID code	C0	"NON-SKIP" only
Other station's ID codes	C1 ~ C5	"SKIP" should be programmed in each channel.
Group code	One of C1 ~ C5	"NON-SKIP" must be programmed.
Memorizing space*	CP	"SKIP" only

* Channel CP automatically memorizes an ID code when receiving a pager call. The contents in the channel CP cannot be changed manually.

NOTE: Channels C1 ~ C5 can be programmed with another station's ID code or group code. We recommend that the same channel be used for group code programming.

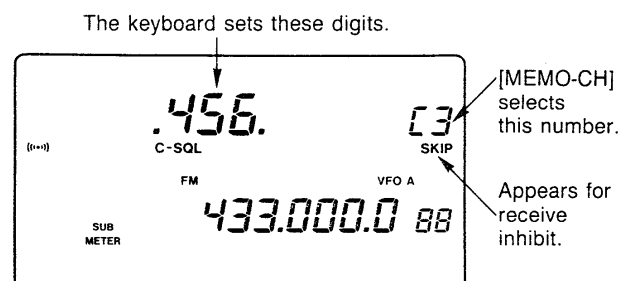

• Programming

- 1) Push [SUB] to select the MAIN band.
- 2) Push [7](PAGER) or [8](C-SQL) to activate the pager or code squelch function.
 - "C-SQL" appears on the function display.
- 3) Push [6](SET) to select the code memory setting display.
 - 3 digit number and code memory channel appear on the function display.
- 4) Rotate the [MEMO-CH] selector to select the desired code memory channel.
- 5) Push [FUNCTION], then push the desired digit key to input the DTMF code.
- 6) Push [ENT](BAND) to enter the input digit as the DTMF code.
- 7) To program the receive inhibit channel ("SKIP" channel), push [FUNCTION] then push [M▶VFO].
 - Transmit code channels (programmed with other station's ID code) should be set to appear as "SKIP."
- 8) Push [6](SET) again to exit the setting display.

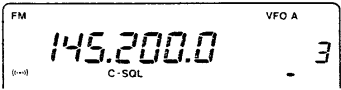

■ Pager operation

The following steps in the chart should be read in sequence. Step 1 in the CALLING STATION column, for example, corresponds to step 1 in the STANDBY STATION column.

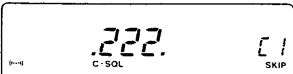
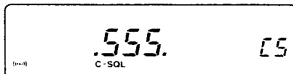
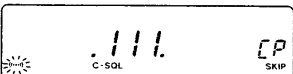
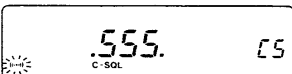
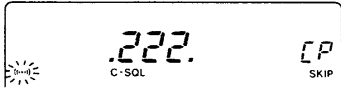
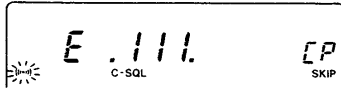
CALLING STATION (ID : 111)	STANDBY STATION (ID : 222)
1) Set the desired operating band and frequency in the MAIN band display. • The function can be operated in FM mode only.	1) Set the desired operating band and frequency in the MAIN band display. • The function can be operated in FM mode only.
2) Push [7](PAGER) to activate the pager function. 	2) Push [7](PAGER) to activate the pager function. 
3) Push [6](SET), then rotate [MEMO-CH] to select the desired code memory channel. For personal call  Select the channel in which programmed the standby station's ID code. For group call  Select the channel in which programmed the group code.	3) When receiving a call, the display shows as follows with beeps: When receiving an ID code.  Channel CP appears and shows the calling station's ID code. When receiving a group code.  The group code programmed channel appears.
4) Push the PTT switch to transmit the selected code. • The speaker also emits the selected code.	4) Push the PTT switch to transmit an answer back code. 5) Push [7](PAGER) again to cancel the pager function.
5) When receiving a call, the display shows the Channel CP or the group code channel. 	 When receiving a code not completely caused by interference, etc., the display shows as at left.
6) Push [7](PAGER) to return the display to the previous one. 7) Push [7](PAGER) again to cancel the pager function.	
8) Operate the transceiver with or without code squelch. See below for details.	6) Operate the transceiver with or without code squelch. See below for details.

NOTE: While Channel CP appears, selecting the code squelch automatically changes the Channel CP to Channel C0.

If you operate the code squelch after a personal call of the pager function, the code memory channel must be selected again.

■ Code squelch operation

- 1) Set the desired operating band in the MAIN band display.
• The function does not operate in SSB/CW mode.
- 2) Push [8](C-SQL) to activate the code squelch function.
• "C-SQL" appears on the function display.
- 3) Push [6](SET), then rotate the [MEMO-CH] selector to select the desired code memory channel.
• Personal communication: other station's ID code programmed channel.
• Group communication: group code programmed channel.
- 4) Operate the transceiver in the normal way (push PTT to transmit and release to receive).
• A 3-digit code is transmitted at the beginning of the signal.
• Signals without a code or with an incorrect code cannot receive.
• To monitor these signals, push and hold [CHECK].
- 5) To cancel the function, push [8](C-SQL).

13 POCKET BEEP AND TONE SQUELCH

■ General description

An optional UT-34 TONE SQUELCH UNIT is convenient for the pocket beep and is necessary for tone squelch operation. See p. 40 for the unit installation.

• Pocket beep operation

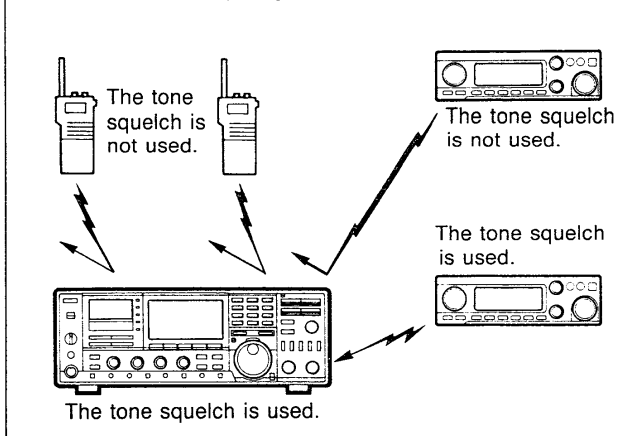

• Pocket beep

The pocket beep function alerts you with beeps for 30 sec. and flashes the "((...))" indicator on the function display when receiving a call.

When using an optional UT-34 TONE SQUELCH UNIT, the pocket beep alerts you receiving only the specified call, including the same subaudible tone frequency.

• Tone squelch

An optional UT-34 TONE SQUELCH UNIT is necessary for the function.

The tone squelch prevents you from receiving undesired signals because the transceiver receives only signals that include the same subaudible tone. You can silently wait for a specified call.

Up to 2 tone squelch units can be installed to operate the function on both the MAIN and SUB bands. The tone squelch function can be used in combination with a code squelch or pager function.

■ Tone frequency setting

NOTE: The tone frequency of the tone squelch is separately programmed from the tone encoder frequency.

- 1) Push [SUB] to select the UT-34 connected band, MAIN or SUB.
- 2) Push [FM] to select FM mode.
- 3) Push [4](P-BEEP) or [5](T-SQL) to activate the pocket beep or tone squelch.
 - "TONE SQL" appears on the function display.
- 4) Push [6](SET) to select the tone frequency setting display.
- 5) Rotate the main dial to select the desired tone frequency.
- 6) Push [6](SET) again to exit the setting display.

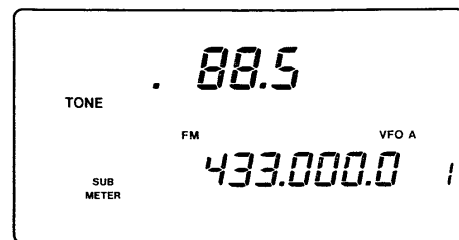

TONE FREQUENCY LIST

67.0	110.9	173.8
71.9	114.8	179.9
74.4	118.8	186.2
77.0	123.0	192.8
79.7	127.3	203.5
82.5	131.8	210.7
85.4	136.5	218.1
88.5	141.3	225.7
91.5	146.2	233.6
94.8	151.4	241.8
100.0	156.7	250.3
103.5	162.2	
107.2	167.9	

■ Pocket beep function

- 1) Push [SUB] to select the desired waiting band MAIN or SUB.
 - When one UT-34 is installed, select the UT-34 connected band.
- 2) Push [FM] to select FM mode.
 - The function will not activate in other modes.
- 3) Push [4](P-BEEP) to activate the pocket beep function.
 - “(•••)” and “TONE SQL” appears on the function display.
- 4) When receiving a signal (if a UT-34 is installed and a signal that includes the same subaudible tone is received), the pocket beep function alerts you with beeps for 30 sec.
 - “(•••)” flashes on the function display.
- 5) To stop the beeps, push [4](P-BEEP) or transmit an answer signal to the calling station.
 - The pocket beep is canceled and the tone squelch is automatically selected.

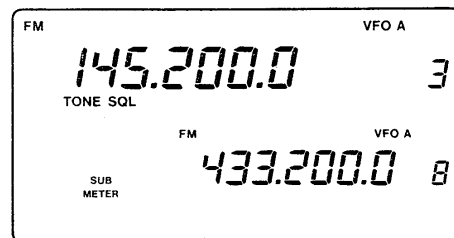
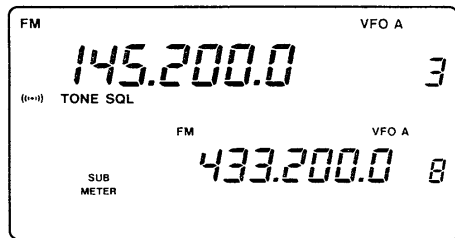

■ Tone squelch operation

- 1) Push [SUB] to select the UT-34 installed band, MAIN or SUB.
 - The tone squelch does not activate in other modes.
- 2) Push [FM] to select FM mode.
 - The tone squelch does not activate in other modes.
- 3) Push [5](T-SQL) to activate the tone squelch.
 - “TONE SQL” appears on the function display.
- 4) Set the desired tone frequency. See the page at left for details.
- 5) Operate the transceiver, transmit or receive in the normal way.
 - The transceiver transmits the selected subaudible tone and receives only the signal with the same tone included.
 - To monitor a signal including a different tone or including no tone, push and hold [3](CHECK).

CONVENIENT

Use memory channel

Tone squelch and a tone frequency can be programmed in a memory channel. Therefore, tone setting is not necessary once a memory channel is programmed.

14 OPTIONAL UNIT INSTALLATION

■ Cover removal

Follow the cover removal procedures shown here when you want to install an optional unit or power supply.

CAUTION: DISCONNECT the DC power cable from the transceiver before removing the top and bottom covers.

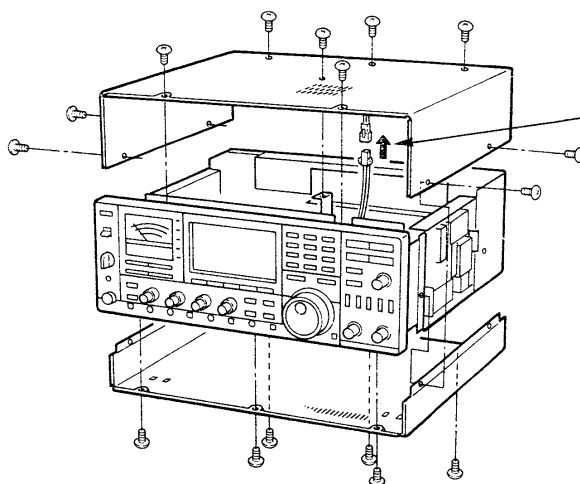

- ① Remove 10 screws from the top cover.
- ② Unplug the speaker plug while slowly opening the top cover.
- ③ Remove the top cover.
- ④ Remove 6 screws from the bottom cover.
- ⑤ Remove the bottom cover.

■ IC-PS35 internal power supply

- ① Remove top and bottom covers.

- ② Remove 4 screws, then remove rear plate (A).

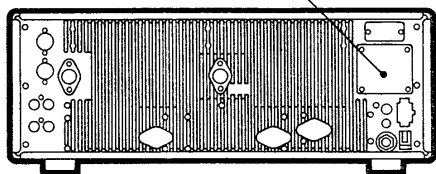

- ③ Remove 4 screws, then remove the internal PS chassis.

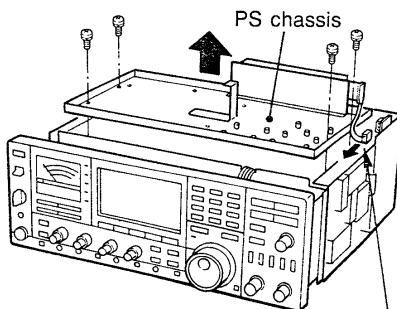

- ④ Attach the insulator sheet and the IC-PS35 to the PS chassis.

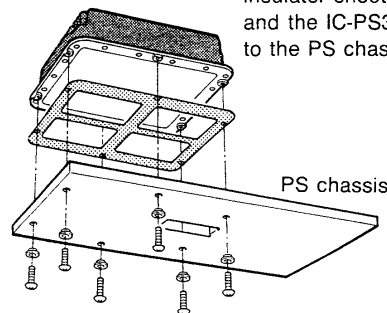

- ⑦ Pull out the DC power cable of the IC-PS35.

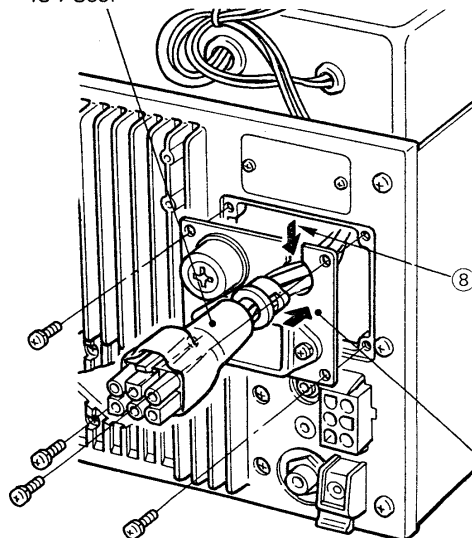

NOTE: The IC-970H has a cooling fan. Unplug the connector while slowly lifting up the PS chassis.

- ⑤ Tighten 6 screws using insulating washers. The screws and washers are supplied with the IC-PS35.
- ⑥ Replace the PS chassis.

- ⑧ Insert the DC power cable into the AC power socket plate and hold it using the bushing.

AC power socket plate

- ⑨ Tighten the AC power socket plate to the rear panel using the removed screws from the rear plate (A).

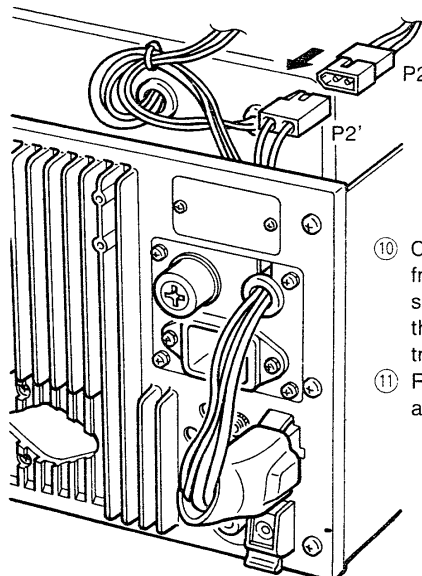

- ⑩ Connect the cable from the AC power socket plate to the P2 in the transceiver.
- ⑪ Replace the top and bottom covers.

■ UX-97 1200 MHz band unit

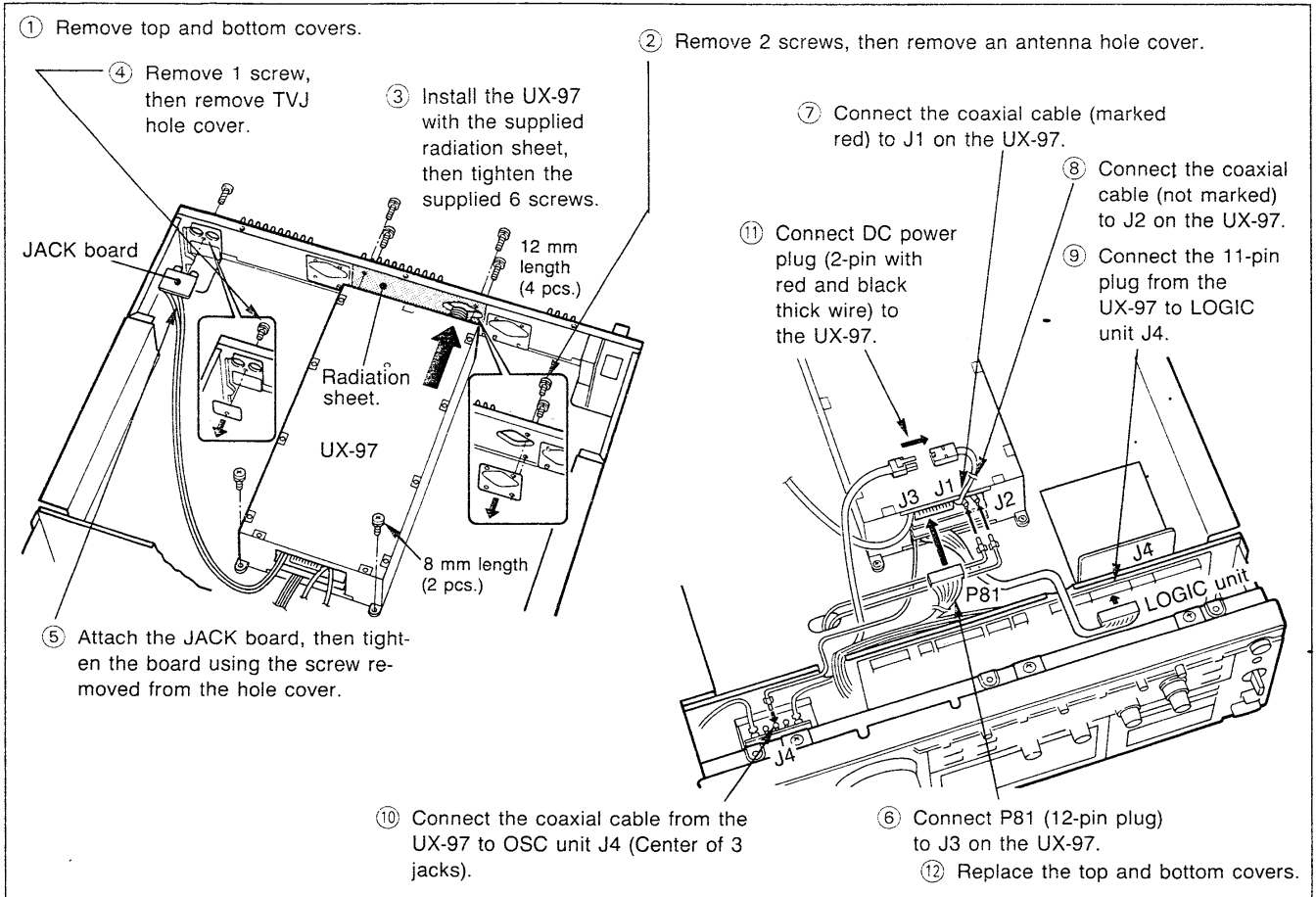

■ UX-R96 receiver unit

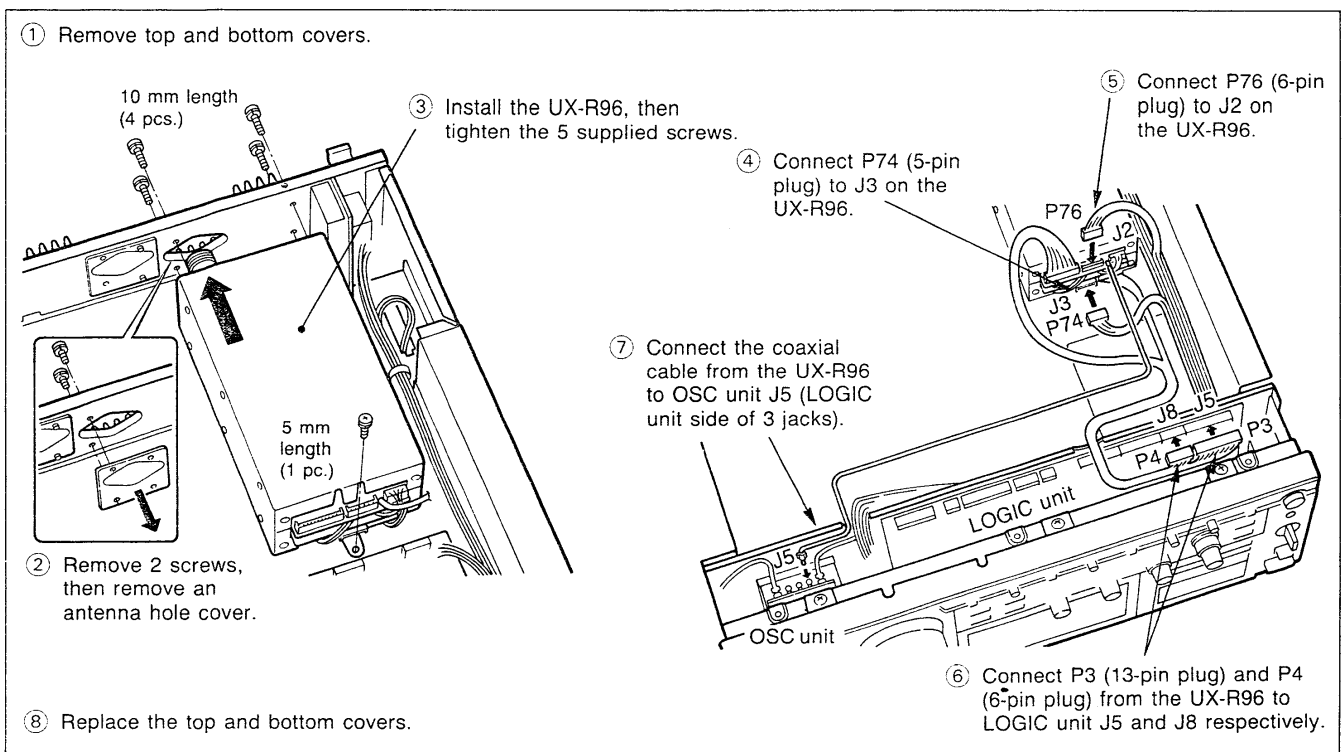

■ FL-132 and FL-133 CW narrow filters

A CW narrow filter is provided for each MAIN and SUB band.

MODEL	CENTER FREQ.	- 6 dB	- 60 dB	NOTE
FL-132	10.8491 MHz	500 Hz	1340 Hz	For MAIN band
FL-133	10.9491 MHz	500 Hz	1340 Hz	For SUB band

④ Pull up the MAIN unit

③ Remove 8 screws from the MAIN unit.

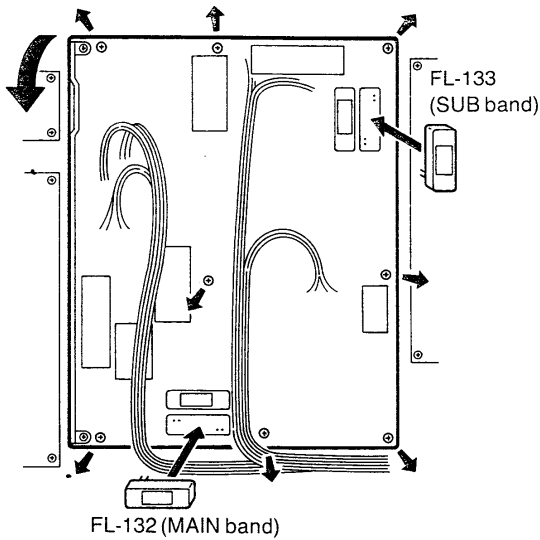

⑥ Install the desired filter to the MAIN unit.

① Remove the top cover. (p. 37)

② Remove the PS chassis. (See p. 37, IC-PS35 for details.)

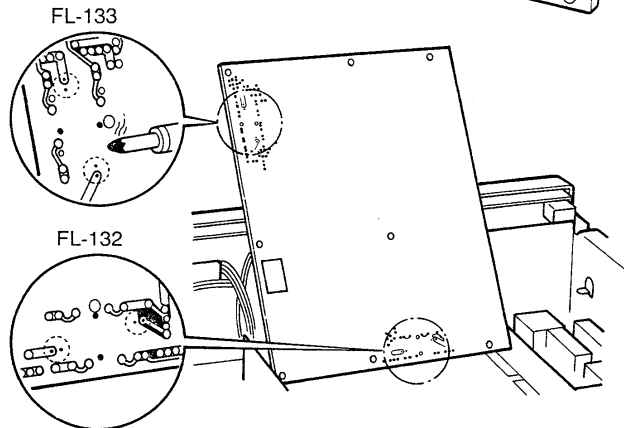
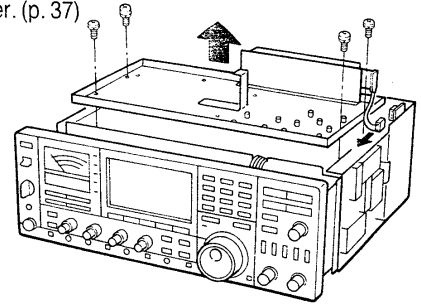

⑤ Unsolder the foil side of the filter installation part.

⑦ Bend the filter's leads flush with the foil side of the MAIN unit and trim the leads. Then solder it.

⑧ Replace the MAIN unit, PS chassis and top cover.

■ CR-293 high-stability crystal unit

① Remove top and bottom covers (p. 37).

② Unplug the coaxial cable (P2).

③ Remove 2 screws.

④ Pull up and pull out the OSC unit with the described arrow.

⑤ Remove 4 screws from the OSC unit and open the top cover.

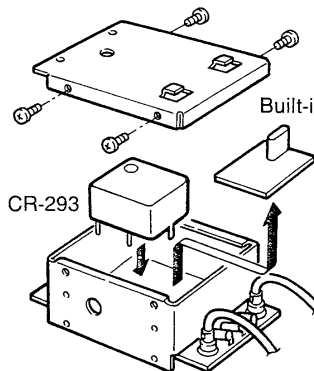

⑦ Replace the internal crystal unit with the CR-293.

⑨ Replace the OSC unit top cover.

⑥ Unsolder the points marked A.

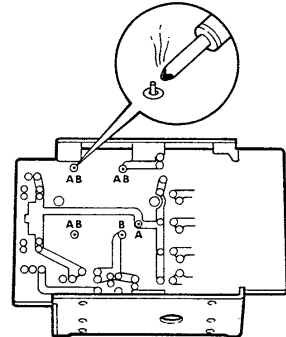

⑧ Solder the points marked B.

⑩ Replace the top and bottom covers.

■ UT-34, UT-36 and IC-EX243

Installation locations for these 3 units are under the top cover. Remove the top cover before installing the units. See p. 37 for cover removal information.

• UT-36 VOICE SYNTHESIZER UNIT

- ① Connect P89 (5-pin) and P90 (3-pin) to UT-36 J1 and J2 respectively.
- ② Remove the protective paper attached to the bottom of the UT-36 to expose the adhesive strip.
- ③ Attach the UT-36 as shown in the diagram's location.
- ④ Set the language, speech speed and speech level as shown in the diagram below.
- ⑤ Replace the top cover.

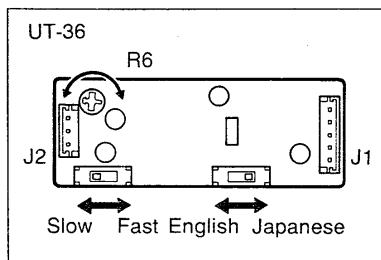

• IC-EX243 ELECTRONIC KEYSER UNIT

- ① Attach the IC-EX243 using the 3 screws supplied with the IC-EX243.
- ② Connect P91 (3-pin) and P92 (4-pin) onto IC-EX243 J1 and J2 respectively.
- ③ Adjust R8 for keying weight (dot-space-dash ratio). See the diagram at right.
- ④ Replace the top cover.

• IC-EX243

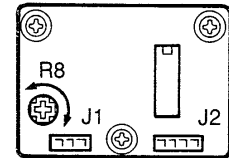

• KEYING WEIGHT CONTROL

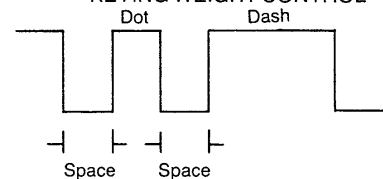

• UT-34 TONE SQUELCH UNIT

Up to 2 UT-34s can be installed in the transceiver for the MAIN and SUB bands.

- ① Install a UT-34 to the desired place using the screws supplied with the UT-34.
- ② For MAIN band use, connect P85 (6-pin) and P86 (5-pin) to UT-34 J1 and J2 respectively.
- ③ For SUB band use, connect P87 (6-pin) and P88 (5-pin) to UT-34 J1 and J2 respectively.
- ④ Replace the top and bottom covers.

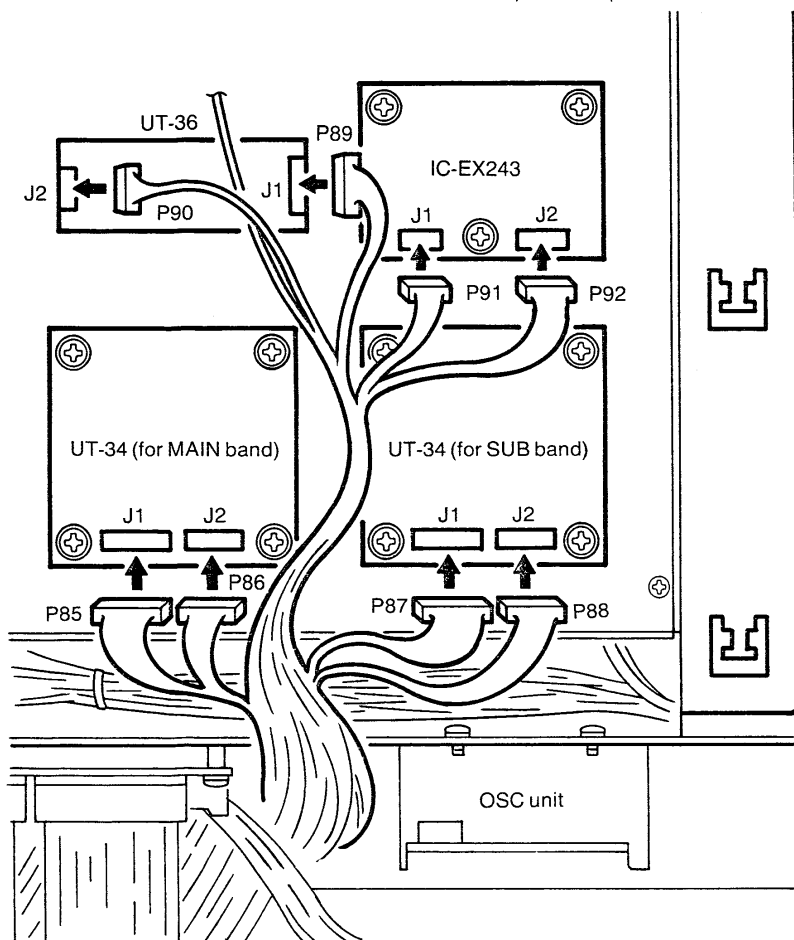

15 ADJUSTMENT AND SETTING

CAUTION: Your transceiver has been thoroughly adjusted and checked at the factory before being shipped. All adjustable trimmers and coils should be adjusted by an authorized Icom Dealer or Service Center. Your transceiver warranty does not cover problems caused by unauthorized internal adjustments.

External adjustment

• Main dial break adjustment

The tension of the main dial may be adjusted to suit your operating requirements.

Set the transceiver upside down.

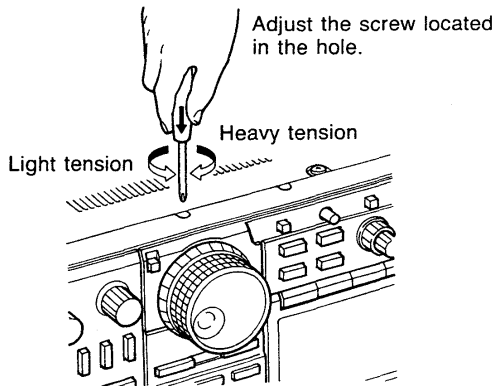

• Display backlight intensity

The intensity of the function display can be adjusted to prevent your eyes from tiring over long periods of operation.

Set the transceiver upside down.

Adjust the trimmer located in the hole.

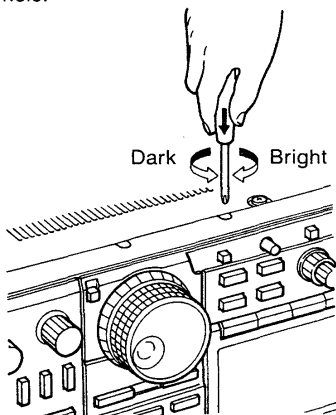

Beep tone level

• Beep tone ON/OFF

Beep tone ON/OFF can be selected externally. The following operation alternately turns ON and OFF both the MAIN and SUB band beep tones.

- 1) Turn power OFF.
- 2) While pushing [FUNCTION] and [-](MHz), turn power ON.

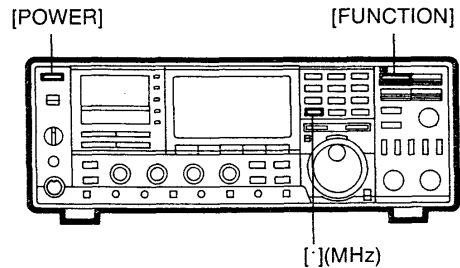

• Beep tone level

Beep tones of the MAIN and SUB bands can be adjusted separately.

R310 (SUB band) R292 (MAIN band)

Max. Min. Min. Max.

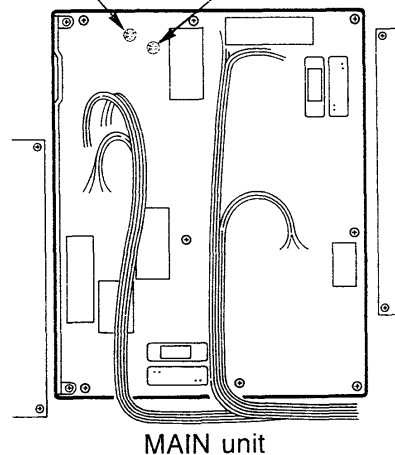

The MAIN unit is located under the PS chassis. See p. 37 IC-PS35 for PS chassis removal information.

■ Preamp control voltage

Each antenna connector outputs the control voltage when the [PREAMP] switch on the front panel is pushed IN. The control voltage can be cut with the following jumper leads, if you desire.

These jumper leads on the CTRL unit are located inside the bottom cover.

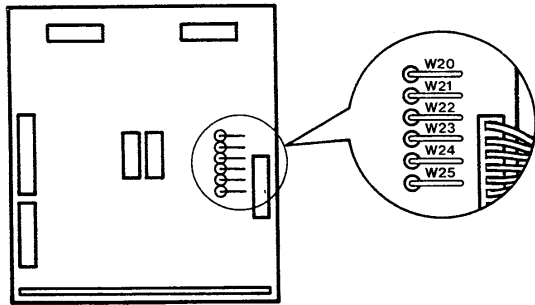

JUMPER	NO VOLTAGE OUTPUT FROM:
W20	All antenna connectors
W21	An optional UX-R96's built-in preamp
W22	An optional UX-97's antenna connector
W23	Do not cut this jumper.
W24	430 MHz band antenna connector
W25	144 MHz antenna connector

■ Modulation input level

The modulation input terminal (pin 1) on the [DATA] socket accepts 2 different input levels for low and high levels to correspond to your terminal unit such as for AMTOR or packet.

When the output level of your terminal unit is low level such as around 3 mV, set the switch to the "3 mV" position.

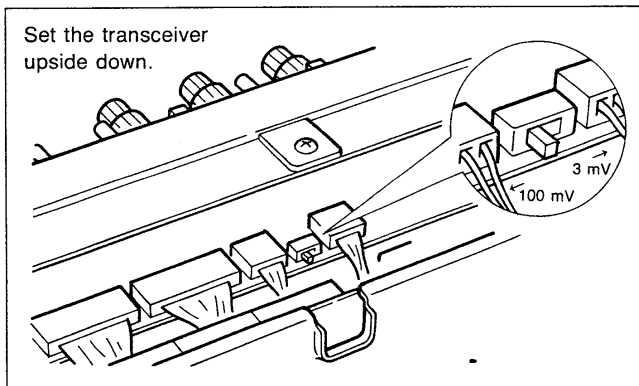

■ Front panel inside switches

Three switches inside the front panel control scan speed, scan auto off and the dial click function. These switches are located under the top cover.

• Dial click function

The dial click function is activated when the [CLICK] switch is pushed IN while the transceiver is in the dial click active condition. The condition can be set in 2 ways: dial clicks occur regardless of tuning step setting; dial clicks occur only in tuning steps greater than 5 kHz.

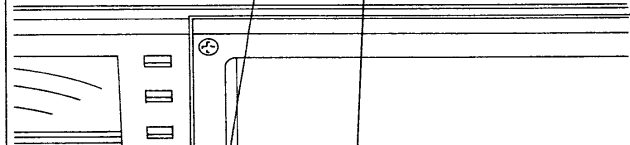
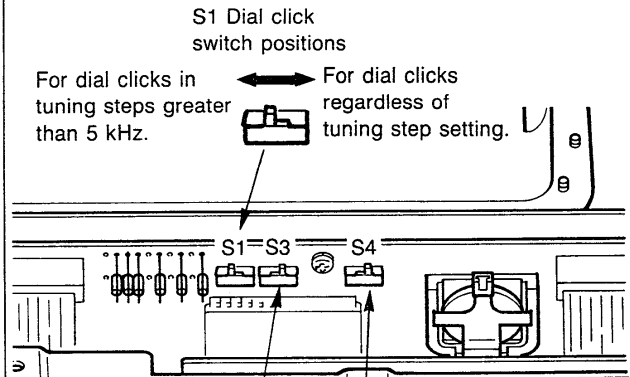

• Scan switches

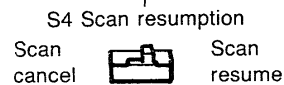
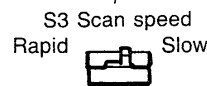

Scan cancel:
Scan is canceled when signal is received.

Scan resume:
Scan resumes 10 sec. after receiving a continuous signal or 3 sec. after receiving an intermittent signal.

■ Troubleshooting

	PROBLEM	POSSIBLE CAUSE	SOLUTION	REF		
POWER SUPPLY	Power does not come on when [POWER] is pushed IN.	<ul style="list-style-type: none"> • Power cable is improperly connected. • Power cable is cut. • Fuse is blown. Fuses are installed in 2 places: <ul style="list-style-type: none"> - in the DC power cable. (2 fuses) - inside transceiver. 	<ul style="list-style-type: none"> • Reconnect the power cable securely. • Check the cable continuity. • Check the cause, then replace the fuse with a spare one. 	<p>p. 10</p> <p>p. 44</p>		
		RECEIVE	No sound comes from the speaker or sound level is too low.	<ul style="list-style-type: none"> • Volume level is too low. • The squelch is closed. • The transceiver is in transmit. • An external speaker or headphones are in use. • [RF] is rotated to maximum counterclockwise. • Pager or code squelch is turned ON. • The optional tone squelch is turned ON, when the UT-34 is installed. 	<ul style="list-style-type: none"> • Rotate [AF] of operating band to obtain a suitable listening level. • Rotate [SQL] counterclockwise to open the squelch. • Set the [TRANSMIT/RECEIVE] switch to RECEIVE or check SEND line of the external unit, if connected. • Check the external speaker or headphones plug connection. • Rotate the [RF] control clockwise. • Push [7] or [8] on the keyboard to turn OFF the function. • Push [5] on the keyboard to turn OFF the function. 	<p>p. 19</p> <p>p. 19</p> <p>p. 21</p> <p>p. 20</p> <p>p. 33</p> <p>p. 35</p>
The SUB band audio cannot be heard.	<ul style="list-style-type: none"> • [SP SEPARATE] is pushed IN. 			<ul style="list-style-type: none"> • Push [SP SEPARATE] OUT if no external speaker is connected. 	p. 2	
Sensitivity is low.	<ul style="list-style-type: none"> • The antenna feedline is cut or shorted. • VHF and UHF antennas are opposite. • [RF] is rotated counterclockwise. 			<ul style="list-style-type: none"> • Check the feedline and correct any improper conditions. • Check the antenna and antenna connector proportions. • Rotate [RF] max clockwise. 	<p>p. 8</p> <p>p. 9</p> <p>p. 20</p>	
	Repeater cannot be accessed.			<ul style="list-style-type: none"> • A wrong offset frequency is set. • The repeater requires a subaudible tone. 	<ul style="list-style-type: none"> • Set the correct offset frequency. • Turn ON the subaudible tone encoder and set the subaudible tone frequency. Be sure the tone squelch and tone encoder separately have the tone frequency. 	<p>p. 22</p> <p>p. 22</p>
				Output power is low.	<ul style="list-style-type: none"> • [RF PWR] is rotated too far counterclockwise. • [MIC GAIN] is rotated too far counterclockwise in SSB mode. • VHF and UHF antennas are opposite. 	<ul style="list-style-type: none"> • Rotate [RF PWR] clockwise. • Rotate [MIC GAIN] clockwise. • Check the antenna and antenna connector proportions.
DISPLAY	The displayed frequency does not change properly.	<ul style="list-style-type: none"> • [LOCK] is pushed IN. • Call channel is selected. • Call channel in the SUB band is selected. 	<ul style="list-style-type: none"> • Push [LOCK] OUT. • Push [A/B] or [MEMO] to exit call channel. • Push [SUB] to select the MAIN band. 		<p>p. 18</p> <p>p. 28</p> <p>p. 28</p>	
		Frequency cannot be entered from the keyboard.	<ul style="list-style-type: none"> • [FUNCTION] is not pushed before digit keys are entered. • [ENT] is not pushed after digit keys are entered. • [-] is not pushed after the 1 MHz digit is entered. • The same band frequency in the SUB band is entered on the MAIN band. 		<ul style="list-style-type: none"> • Push [FUNCTION] before entering a frequency via the keyboard. • Push [ENT] after entering a frequency via the keyboard. • Enter the 1 MHz digit then push [-] before entering the 100 kHz digit. • Push [M/S] or [SUB] then enter the frequency again. 	<p>p. 17</p> <p>p. 17</p> <p>p. 17</p> <p>p. 16</p>
			Frequency is changing when transmitting.	<ul style="list-style-type: none"> • The transceiver is set for split operation. • The transceiver is set for duplex operation. 	<ul style="list-style-type: none"> • Push [SPLIT] to turn OFF the split function. • Push [2](DUP) to select simplex. 	<p>p. 22</p> <p>p. 22</p>

	PROBLEM	POSSIBLE CAUSE	SOLUTION	REF
SCAN	Scan does not function.	<ul style="list-style-type: none"> • Squelch opens. • The transceiver is in transmitting. 	<ul style="list-style-type: none"> • Set [SQL] to threshold point. • Set the transceiver in receiving. 	p. 30
	Programmed scan does not function.	<ul style="list-style-type: none"> • The same frequencies are programmed in memory channels P1 and P2. 	<ul style="list-style-type: none"> • Program a different frequency into memory channels P1 and P2. 	p. 30
	Memory scan does not function.	<ul style="list-style-type: none"> • The mode-select function is activated and the same mode memory channels are not programmed. 	<ul style="list-style-type: none"> • Push the [MODE-SEL] to turn OFF the mode-select function. 	p. 29

■ Fuse replacement

If the fuse blows or the transceiver stops functioning, find the source of the problem if possible, and replace the damaged fuse with a new, rated fuse.

• DC power cable fuses

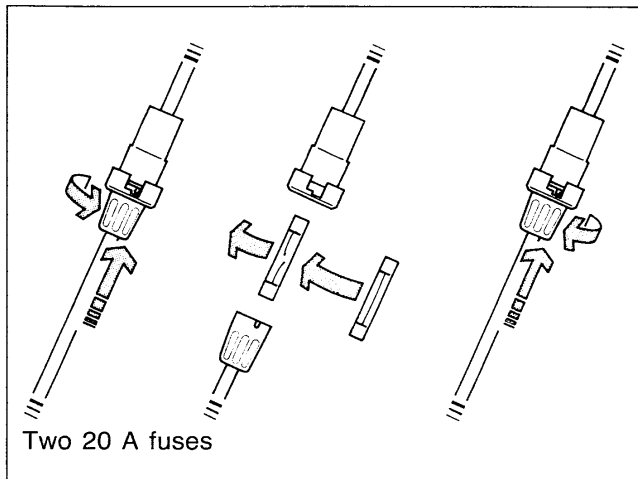

• Internal fuse

An internal fuse is installed on the line affecting all circuits except V/UHF PA circuits and optional band units.

The fuse is located under the PS chassis. See p. 37 for top cover and PS chassis removal information.

Internal fuse: FGMB 125 V/5 A

■ CPU resetting

The frequency display may occasionally display erroneous information, e.g., when first applying power. This may be caused externally by static electricity or other factors.

If this problem occurs, turn the [POWER] switch OFF. Wait a few seconds, and then turn ON power again. If the problem continues, perform the following procedure:

CAUTION: CPU resetting clears all memory information.

RESETTING PROCEDURE:

While pushing the [MW] switch, turn power ON.

■ CPU backup battery

The CPU in the transceiver includes an externally connected RAM IC chip for storing memory channel information. The information is retained by a lithium backup battery.

The usual life of the backup battery is approximately 5 years. When the backup battery is exhausted, the transceiver transmits and receives normally but the transceiver cannot retain memory information.

CAUTION: Backup battery replacement should be done by an authorized Icom Dealer or Service Center.

17 INSIDE VIEWS

• Top view

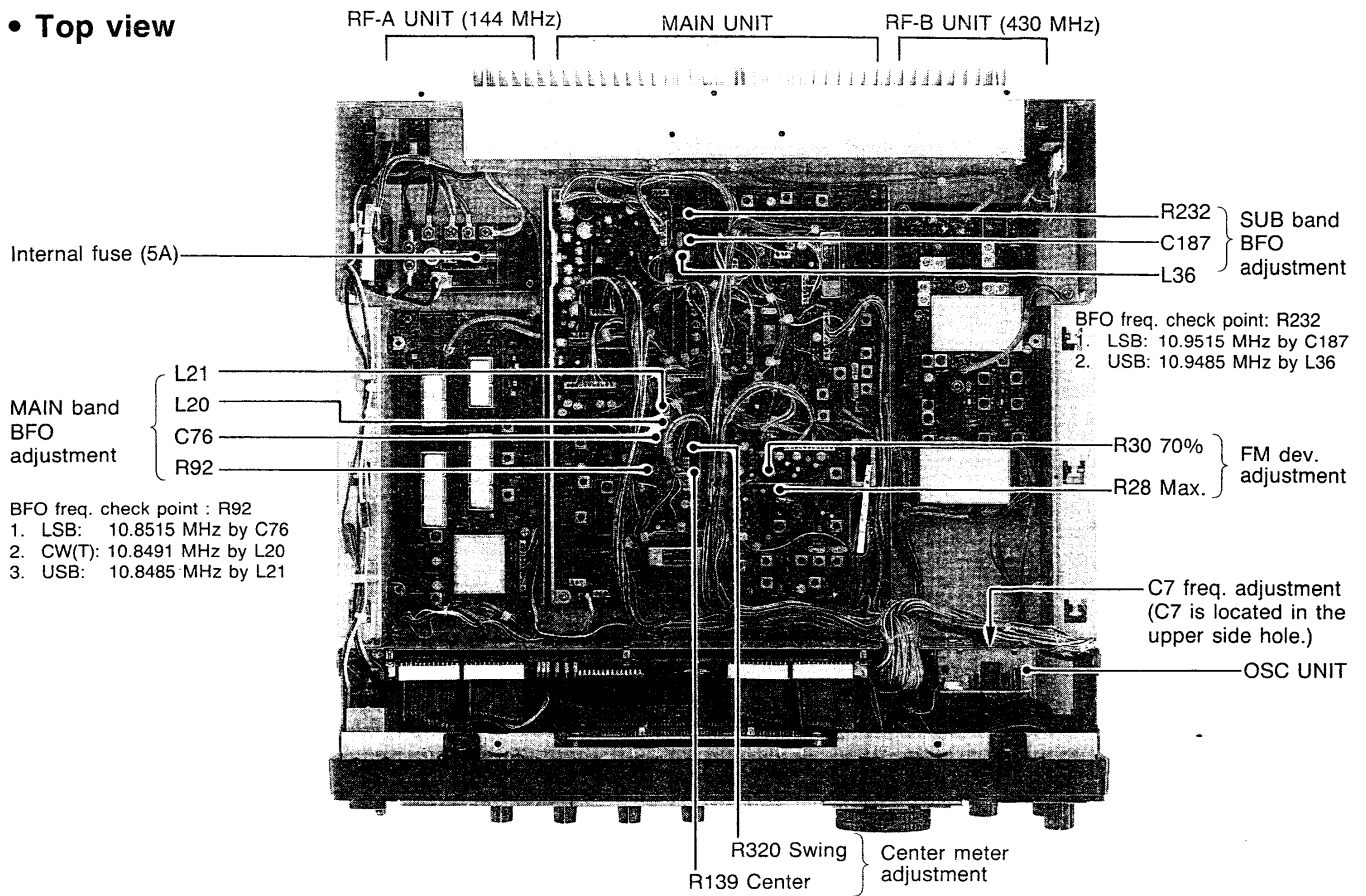

• Right side

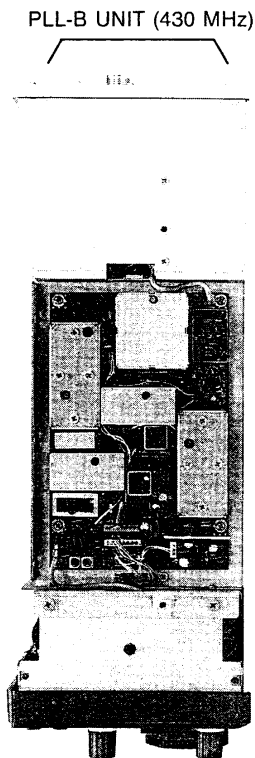

• Bottom view

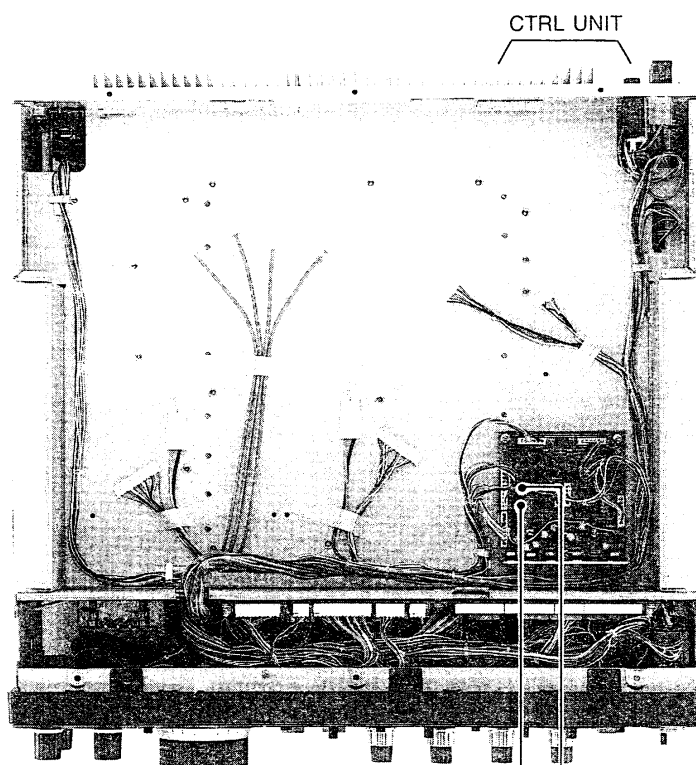

• Left side

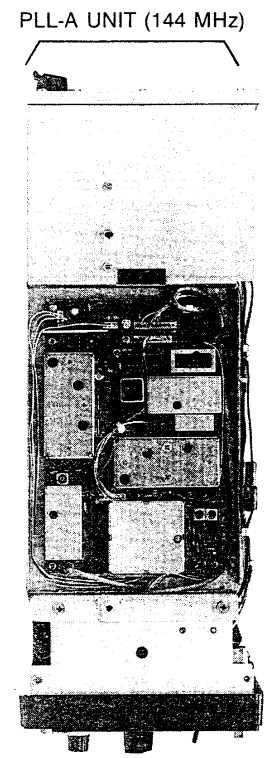

R14 430 MHz } RF output power adjustment
R15 144 MHz }

■ General

- Frequency coverage :

Version	144 MHz band	430 MHz band
U.S.A.	140.1 ~ 150.0 MHz*	430.0 ~ 450.0 MHz
Europe	144.0 ~ 146.0 MHz	430.0 ~ 440.0 MHz
Australia	144.0 ~ 148.0 MHz	430.0 ~ 450.0 MHz
Sweden	144.0 ~ 146.0 MHz	432.0 ~ 438.0 MHz

* Specifications guaranteed 143.8 ~ 148.2 MHz

- Tuning step increment : SSB, CW 10 Hz
FM 5, 10, 12.5, 20, 25 or 100 kHz
All mode 1 kHz and 1 MHz of quick dialing steps are available.
- Mode : SSB (A3J), FM(F3), CW(A1)
- Power supply requirement : 13.8 V DC \pm 15%
- Antenna impedance : 50 Ω (unbalanced)
- Current drain (144 MHz band)
Transmit max. output : 9.0 A (IC-970A/E)
16.0 A (IC-970H)
Receive max. output : 2.5 A (IC-970A/E/H)
Receive squelched : 2.0 A (IC-970A/E/H)
- Usable temperature range : -10°C ~ +60°C (+14°F ~ +140°F)
- Frequency stability : \pm 3 ppm
(0°C ~ +50°C; +32°F ~ +122°F)
- Dimensions : 425(W) \times 149(H) \times 406(D) mm
16.7(W) \times 5.9(H) \times 16.0(D) in
- Weight
(without IC-PS35) : IC-970A/E 14.5 kg (32.0 lb)
IC-970H 15.0 kg (33.0 lb)
(with IC-PS35) : IC-970A/E 16.8 kg (37.0 lb)
IC-970H 17.3 kg (38.1 lb)

■ Transmitter

- Output power
IC-970H : 144 MHz band 5 ~ 35 W (SSB, CW)
6 ~ 45 W (FM)
430 MHz band 5 ~ 30 W (SSB, CW)
6 ~ 40 W (FM)
IC-970A/E : All band 3.5 ~ 25 W (All mode)
- Modulation system
SSB : Balanced modulation
FM : Variable reactance frequency modulation
- Spurious emissions : More than 60 dB below peak output power
- Carrier suppression : More than 40 dB below peak output power

- Unwanted sideband : More than 40 dB below peak output power

- Microphone impedance : 600 Ω

■ Receiver

- Sensitivity
SSB, CW : Less than 0.11 μ V for 10 dB S/N
FM : Less than 0.18 μ V for 12 dB SINAD
- Squelch sensitivity
SSB, CW : Less than 0.56 μ V
FM : Less than 0.18 μ V
- Selectivity
SSB, CW : More than 2.3 kHz/ -6 dB
Less than 4.2 kHz/ -60 dB
CW narrow.(option) : More than 500 Hz/ -6 dB
Less than 1.3 kHz/ -60 dB
FM : More than 15 kHz/ -6 dB
Less than 30 kHz/ -60 dB
- Intermediate frequencies:

		MAIN-BAND		SUB BAND	
		SSB, FM	CW	SSB, FM	CW
144 MHz band	1st	10.8500	10.8491	10.9500	10.9491
	2nd	0.4550*	—	0.4550*	—
430 MHz band	1st	71.2500	71.2491	71.3500	71.3491
	2nd	10.8500	10.8491	10.9500	10.9491
	3rd	0.4550	—	0.4550	—

* FM mode only

Unit: MHz

- Audio output power : 1.5 W with an 8 Ω load at 10% distortion.
- RIT variable range : \pm 9.99 kHz
- Notch filter variable range : More than \pm 1.2 kHz range
- Notch filter attenuation : More than 25 dB

All stated specifications are subject to change without notice or obligation.

19 OPTIONS

UX-97 1200 MHz BAND UNIT

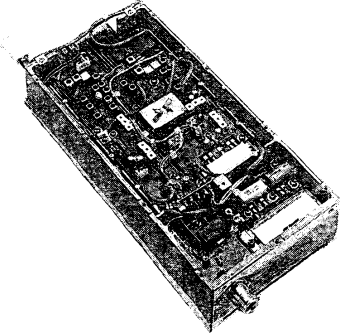

Adds the transceiver operating band of 1200 MHz with all mode capability. The IC-970A/E/H is converted to a tri-band transceiver with the UX-97.
 Mode : SSB, CW, FM
 Output power : 10 W

UX-R96 RECEIVER UNIT

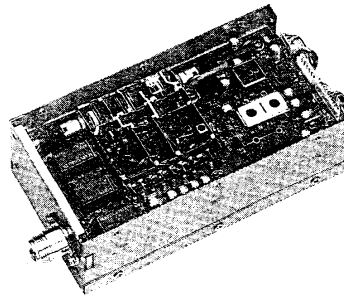

Receives 50~905 MHz continuously. You can receive broadcasts, air and marine bands and other interesting stations. Adds dual watch capability to the 144 or 430 MHz band.
 Mode : FM, FM-Wide, AM

IC-PS35 INTERNAL POWER SUPPLY

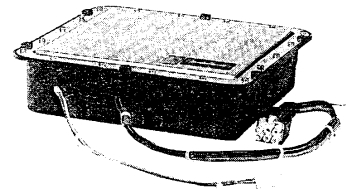

Built-in power supply for AC operation. A lightweight switching regulator system. 100~120 V AC and 220~240 V AC types are available.
 Output voltage : 13.8 V DC
 Max. current : 20 A

IC-PS15 AC POWER SUPPLY



AC power supply for AC operation. Heavy-duty power transformer system. 117, 220 and 240 V AC types are available.
 Output voltage : 13.8 V DC
 Max. current : 20 A

PS-55 AC POWER SUPPLY



AC power supply for AC operation. Heavy-duty power transformer system. Built-in cooling fan for full-duty operation. 117, 220 and 240 V AC types are available.
 Output voltage : 13.8 V DC
 Max. current : 20 A

IC-PS30 AC POWER SUPPLY

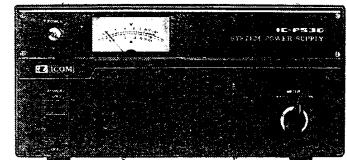

System power supply with some transceivers. Has a DC power cable and 3 output connectors. A lightweight switching regulator system. 100~120 and 220~240 V AC types are available.
 Output voltage : 13.8 V DC
 Max. current : 25 A

SP-20 EXTERNAL SPEAKER WITH AUDIO FILTERS

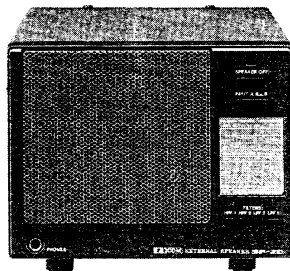

High performance speaker with audio filters for greater sound quality. Style and size are matched with the IC-970A/E/H.
 Input impedance : 8 Ω
 Max. input power : 5 W

SM-8 DESKTOP MICROPHONE

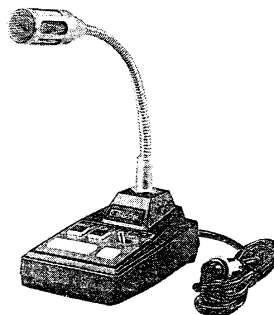

Attractive desktop microphone. Includes 2 connector cables for dual transceiver connection and up/down switches. A diecast frame is used for the mic base.

IC-SP3 EXTERNAL SPEAKER

External speaker for high-quality audio. Designed for increased radio communication readability.
 Input impedance : 8 Ω
 Max. input power : 4 W

SM-6 DESKTOP MICROPHONE

Easy-to-use electret condenser desktop microphone. Suitable for long periods of operation.

HM-58 HAND MICROPHONE

Equipped with up/down switches.

UT-34 TONE SQUELCH UNIT

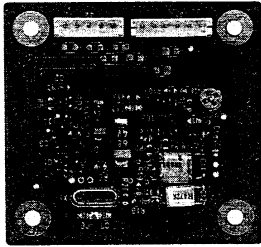

Provides a "personalized" tone squelch system with other stations. Adds a tone-controlled pocket beep function.

UT-36 VOICE SYNTHESIZER UNIT



A clear, electronically-generated voice announces the displayed frequency in English or Japanese. Speech speed can be changed in 2 steps.

IC-EX243 ELECTRONIC KEYS UNIT

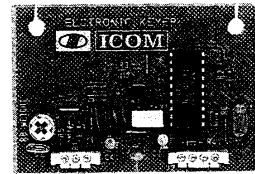

Allows you electronic keyer operation with the IC-970A/E/H for fast and efficient CW contacts.

CR-293 HIGH-STABILITY CRYSTAL UNIT

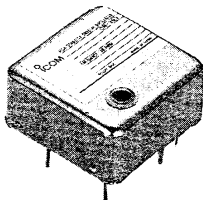

Contains a temperature-compensating oven heater and crystal unit for improved frequency stability.

Frequency stability : ± 0.5 ppm
(0°C ~ +60°C; +32°F ~ +140°F)

FL-132, FL-133 CW NARROW FILTERS

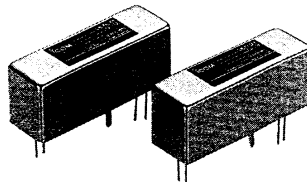

Have good shape factors to provide you with better CW reception on crowded band conditions.

FL-132: for the MAIN band (10.8491 MHz)
FL-133: for the SUB band (10.9491 MHz)
Passband width: 500 Hz / -6 dB

HP-2 COMMUNICATIONS HEADPHONES



Monaural headphones that provide clear audio even in noisy environments.

AH-7000 SUPER WIDEBAND OMNIDIRECTIONAL ANTENNA

Super wideband frequency coverage from 25 ~ 1300 MHz. The AH-7000 is suitable for an optional UX-R96 RECEIVER UNIT.

AG-25, AG-35, AG-1200 WEATHERPROOF PREAMPLIFIERS

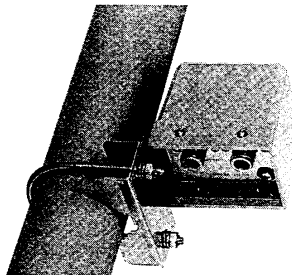

External all-weather mast-mount preamplifier for compensating for coaxial cable loss.

AG-25 : 144 MHz
AG-35 : 430 MHz
AG-1200: 1200 MHz (for UX-97)

MB-19 RACK MOUNTING HANDLES

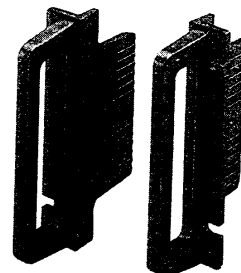

Mounting handles for a 19-inch rack.

CT-17 CI-V LEVEL CONVERTER

For remote transceiver control using a personal computer equipped with an RS-232C port. Sample programs are described in the CT-17 instruction manual.

Count on us!