



VHF AIR BAND TRANSCEIVER IC-A1



OWNER'S MANUAL

FOREWORD

Thank you for choosing the IC-A1, one of the finest VHF AM Air Band Transceivers on the market today. It was designed and built by ICOM INCORPORATED utilizing the latest computer technology and precision VHF engineering. This transceiver incorporates state-of-the-art technology, and it was built specifically for Air Band applications.

Please read this owner's manual carefully before using your IC-A1 transceiver. With proper care, the IC-A1 will provide years of dependable and enjoyable communication.

TABLE OF CONTENTS

SECTION	1	FEATURES	1
SECTION	2	SPECIFICATIONS	2
SECTION	3	ACCESSORIES.....	4
SECTION	4	PRE-OPERATION	5
SECTION	5	CONTROL FUNCTIONS.....	10
SECTION	6	GENERAL OPERATION.....	16

SECTION 1 FEATURES

SYNTHESIZED HANDHELD TRANSCEIVER

The ICOM IC-A1 is a compact, synthesized, 5 watt PEP, VHF handheld transceiver. Using the latest in electronic design, the IC-A1 offers keyboard frequency selection with extremely good stability and frequency accuracy.

ALL CHANNELS

The IC-A1 has all 720 COM channels and 200 NAV channels PLUS 720 additional COM channels and 200 additional NAV channels at 12.5kHz spacing. Wherever you are in the world, you'll be able to communicate with the ICOM IC-A1.

RUGGED CONSTRUCTION

Metal case construction and stainless steel rails for the battery contacts contribute to the ruggedness and long-life of the IC-A1.

12 VOLT OPERATION

The IC-A1 can be operated directly from the aircraft's 12V power panel without draining the battery pack. Also, the standard IC-CM7 battery pack charges in-flight while you operate the transceiver.

10 MEMORY CHANNELS

The IC-A1 has ten memory channels to store your most-used frequencies. An internal lithium battery maintains programmed memory channels.

SECTION 2 SPECIFICATIONS

GENERAL

Number of Semiconductors	:	Transistors	35
		FETs	4
		ICs	10
		Diodes	55
Memory Channels	:		10
Frequency Control	:	Digital PLL synthesizer with keyboard input	
Channel Spacing	:	12.5kHz, 25kHz or 50kHz	
Frequency Stability	:	$\pm 0.002\%$ ($-20^{\circ}\text{C} \sim +50^{\circ}\text{C}$)	
Usable Temperature	:	$-20^{\circ}\text{C} \sim +50^{\circ}\text{C}$ ($-4^{\circ}\text{F} \sim +122^{\circ}\text{F}$)	
Antenna Impedance	:	50 ohms unbalanced	
Power Supply Requirement	:	DC 13.8V within +15% or -20%	
		Attendant power pack, IC-CM7 (negative ground necessary)	
Current Drain at 13.8V	:	Transmitting : High Power	Approx. 0.9A
		Low Power	Approx. 0.6A
		Receiving : Standby	Approx. 55mA
		Max. audio output	Approx. 220mA
Dimensions	:	65(74)mm(W) x 167(178)mm(H) x 35(41)mm(D)	
		() shows dimensions including projections.	
Weight	:	595g including power pack, IC-CM7 and flexible antenna	

RECEIVER

Frequency Range	:	108.000 ~ 135.975MHz
Receiving System	:	Double-conversion superheterodyne
Modulation Acceptance	:	A3E 6K00 (6A3)
Sensitivity (with 50 ohm load)	:	Less than $2\mu\text{V}$ for 6dB S/N with 1kHz, 30% modulation on 108.000 ~ 117.975MHz Less than $1\mu\text{V}$ for 6dB S/N with 1kHz, 30% modulation on 118.000 ~ 135.975MHz
Squelch Sensitivity (with 50 ohm load)	:	Less than $0.5\mu\text{V}$ at threshold point at frequencies higher than 118.000MHz with 1kHz, 30% modulation.
Spurious Response Rejection Ratio	:	More than 60dB
Selectivity	:	More than 60dB at adjacent channel
Audio Output Power	:	More than 500mW at 10% distortion
Audio Output Impedance	:	8 ohms

TRANSMITTER

Frequency Range	:	118.000 ~ 135.975MHz
Output Power	:	High: 1.5W carrier power (4.8W PEP) Low: 0.5W carrier power (1.6W PEP) () shows PEP with 80% modulation by a 1kHz audio tone.
Emission Mode	:	A3E 6K00 (6A3)
Modulation System	:	Low level modulation
Spurious Emission	:	More than 45dB below carrier
Microphone	:	Built-in electret condenser microphone

SECTION 3 ACCESSORIES

UNPACKING

Carefully remove your transceiver from the packing carton and examine it for signs of shipping damage. Notify the delivering carrier or dealer immediately, stating full details, should any damage be apparent. We recommend you keep the shipping carton for storing, moving or reshipping the transceiver if necessary. Accessory hardware, cables, etc. are packed with the transceiver. Make sure you have removed all equipment and parts before discarding the packing material.

Accessories included with the IC-A1:

1. Power pack IC-CM7. 1
(Attached to the set)
2. Wall charger CM-16E 1
3. Flexible antenna 1
4. Rainproof cap 1
5. DC power plug 1
6. Earphone. 1
7. Leatherette case LC-14. 1
8. Cigarette lighter cable IC-CM1. 1
9. Pin-conversion plug. 1
10. Earphone plug. 1
11. Microphone plug 1

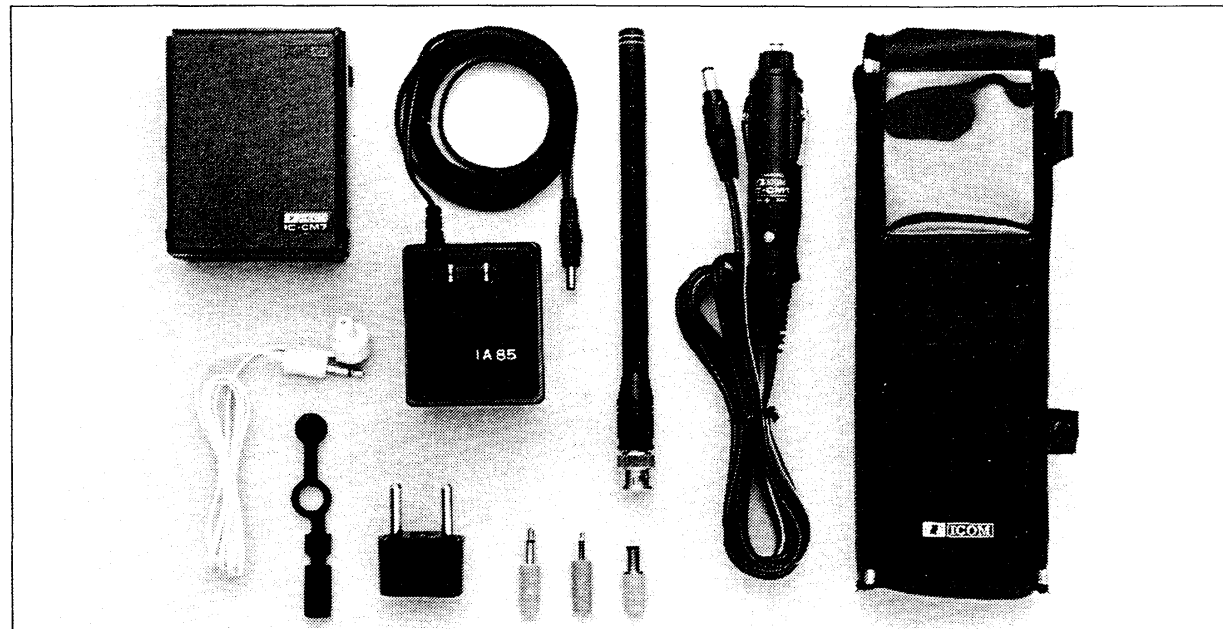

SECTION 4 PRE-OPERATION

BATTERY INSTALLATION

The supplied IC-CM7 is a rechargeable nickel-cadmium power pack which can be slipped on or off the radio very easily. Use the supplied CM-16E wall charger or the optional CM-35 desk charger, or a 12V battery with the supplied IC-CM1 cable for recharging the power pack. Before using the power pack, charge it for 15 hours with the CM-16E or 1.5 hours with the CM-35.

When the IC-CM7 is fully charged, it may be used in the same manner as dry cells. However, the voltage of nickel-cadmium batteries drops rapidly immediately before they are exhausted. For this reason, stop operating and replace or recharge the power pack when the S/BATTERY INDICATOR fails to reach into the silver zone while transmitting. See page 32 for more information.

CHARGING METHOD

1. Use the supplied CM-16E wall charger or optional CM-35 charger, or a stable power source with an output voltage of 13.8V DC and a current capacity over 100mA. A 12V battery with the supplied IC-CM1 charger cable is also suitable. Output voltage in all cases must be 12 to 15V but it is best to use the specified 13.8V.

CAUTION: Voltage greater than 15 volts DC will damage your transceiver. Check the source voltage before connecting the power cord.

2. Turn the IC-A1 POWER SWITCH to the OFF position, or remove the power pack from the transceiver.
3. Connect the output plug from the CM-16E wall charger or other power source to the correct jack on the power pack. The BATTERY CHARGE INDICATOR lights to confirm the charger is working.

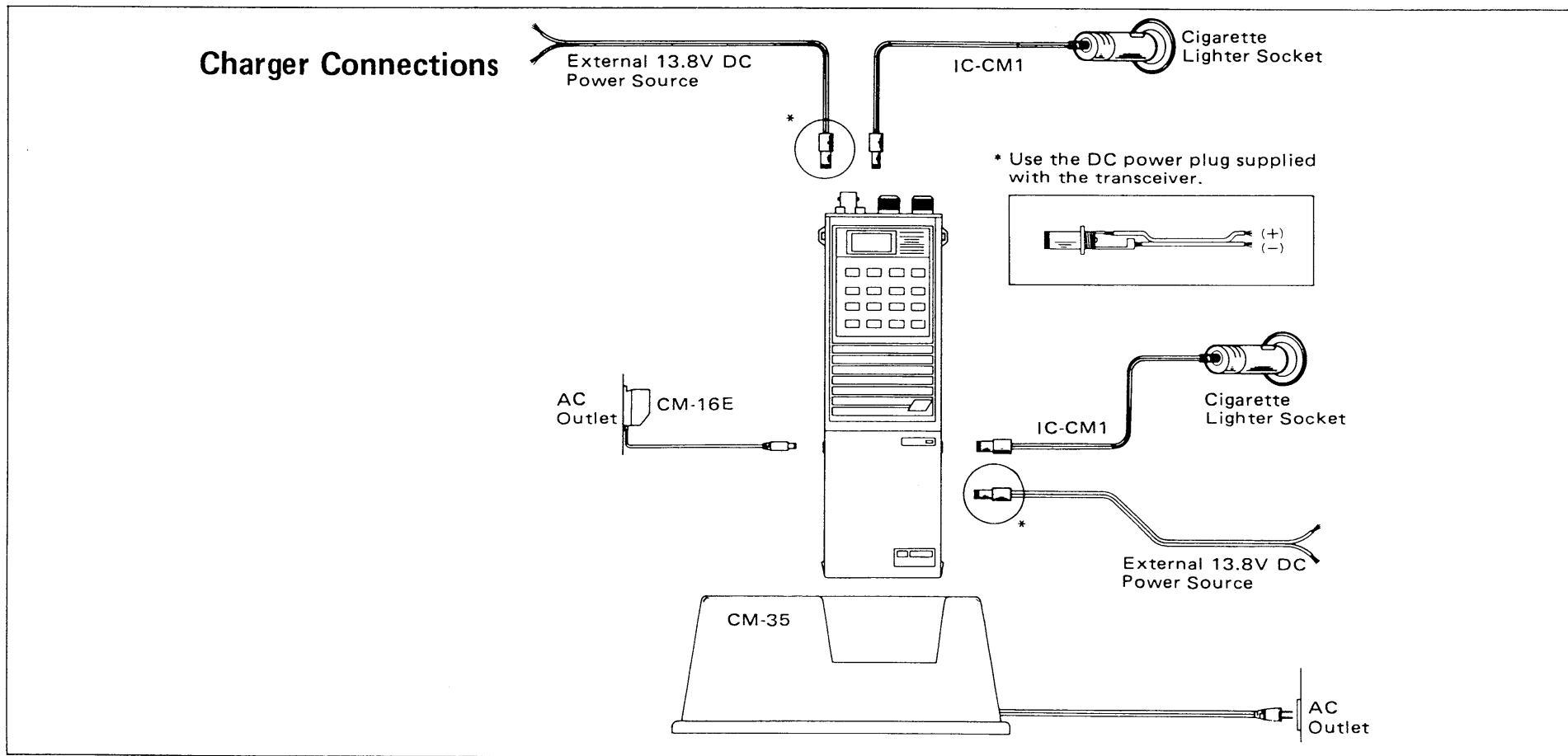

4. Charging time is about 15 hours when using the CM-16E, and about 1.5 hours when using the CM-35. Fully charge the power pack after a long period of disuse, or when it is new.
5. Ambient temperature while charging should be in the range from 0°C to 40°C.
6. Avoid continuous charging after the 15 hour full charge since this excessive charging reduces the power pack life.
7. After charging, unplug the power source from the CHARGER TERMINAL on the power pack.

EXTERNAL POWER SOURCE

When using the IC-A1 for long periods of time, use an external power source which assures reliable communications without concern for battery consumption.

1. Use either a 13.8V DC regulated power supply or a battery. They must have a minimum current capability of 1.5A.
2. Correctly connect the external supply to the external DC power jack as shown in the figure.

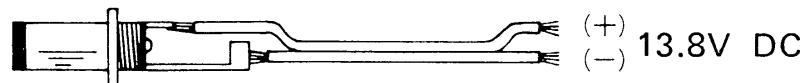

PRECAUTIONS FOR USE OF THE NICKEL-CADMIUM BATTERIES

(from the JIS C8705 MANUAL)

1. Never short the power pack.

Since the internal resistance is low, excess current flows when the pack is shorted causing damage to the batteries or conductors. Avoid shorts! The polarity is shown on the power pack.

2. Never solder directly to the batteries.

If the batteries are soldered directly, the separator or insulator may melt or be damaged. Therefore, always use a battery pack equipped with suitable terminals for mechanical or solder connections.

3. Confirm polarities to prevent reverse charging.

Batteries may be damaged if the leads from the charger are connected backwards. It is essential to confirm the polarity of these leads.

4. Never charge with excess charging current.

If an excess charging rate is employed, gas generation will exceed the rate of gas dissipation at the time of charging. The increased internal pressure may damage the batteries. Therefore, be sure to regulate the charging value of current.

5. Avoid charging under 0°C or over 40°C.

At cold temperatures, the rate of gas dissipation reduces causing higher pressure inside the batteries. At hot temperatures, charging efficiency decreases and it becomes difficult to obtain a full charge. Therefore, charge at a temperature in the range from 0°C to 40°C.

6. Never put batteries into the fire.

Since there could be a little gas left in used batteries, fire causes this gas to expand rapidly resulting in an explosion. Such an explosion could eject battery electrolyte and cause damage to skin or clothes.

PREPARATION FOR USE

1. Attach the supplied power pack.
2. Attach the flexible rubber antenna or connect an external antenna.

ATTACHMENT OF OPTIONAL HAND STRAP AND BELT CLIP

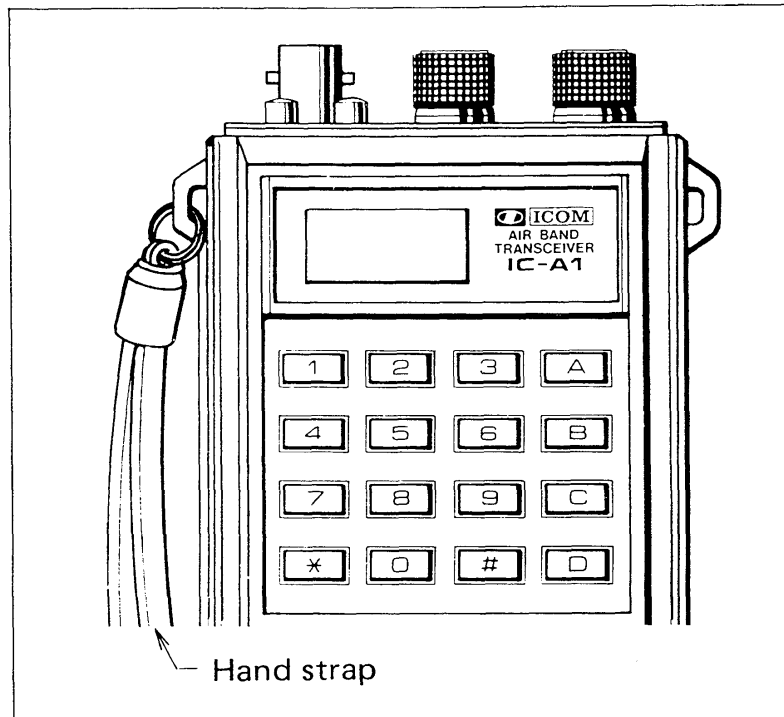

- Attach the belt clip on the back cover with 2 screws supplied.

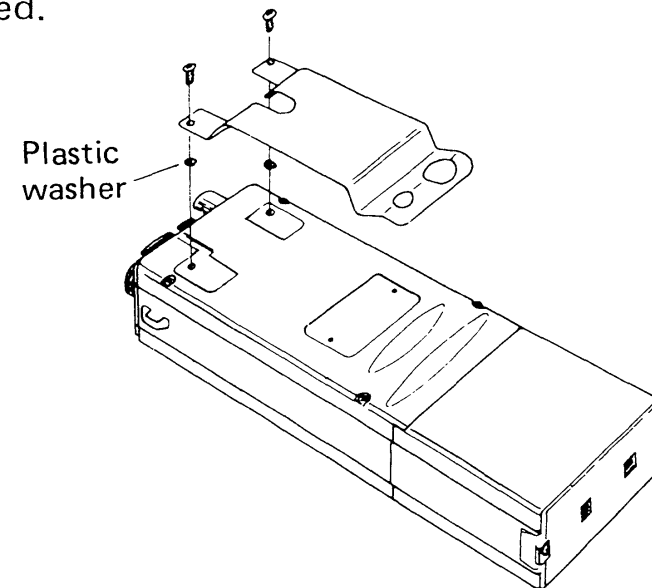

SECTION 5 CONTROL FUNCTIONS

TOP PANEL

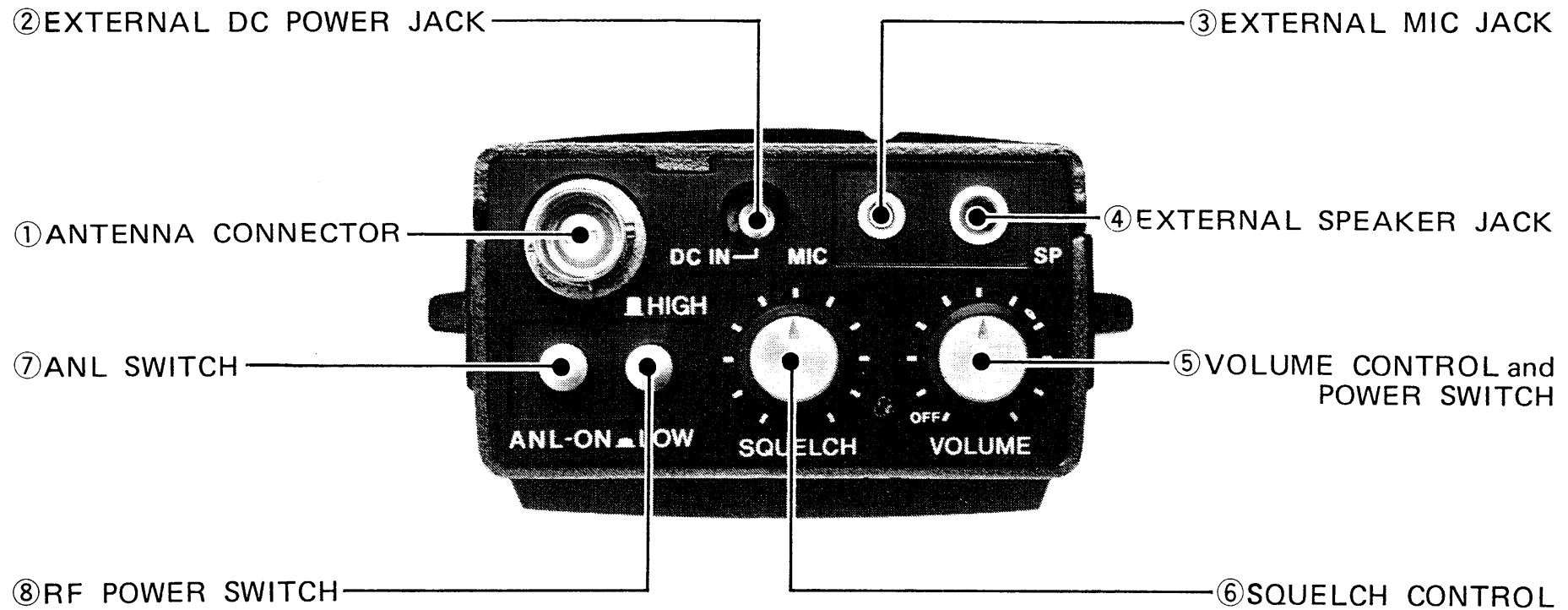

FRONT PANEL

REAR PANEL

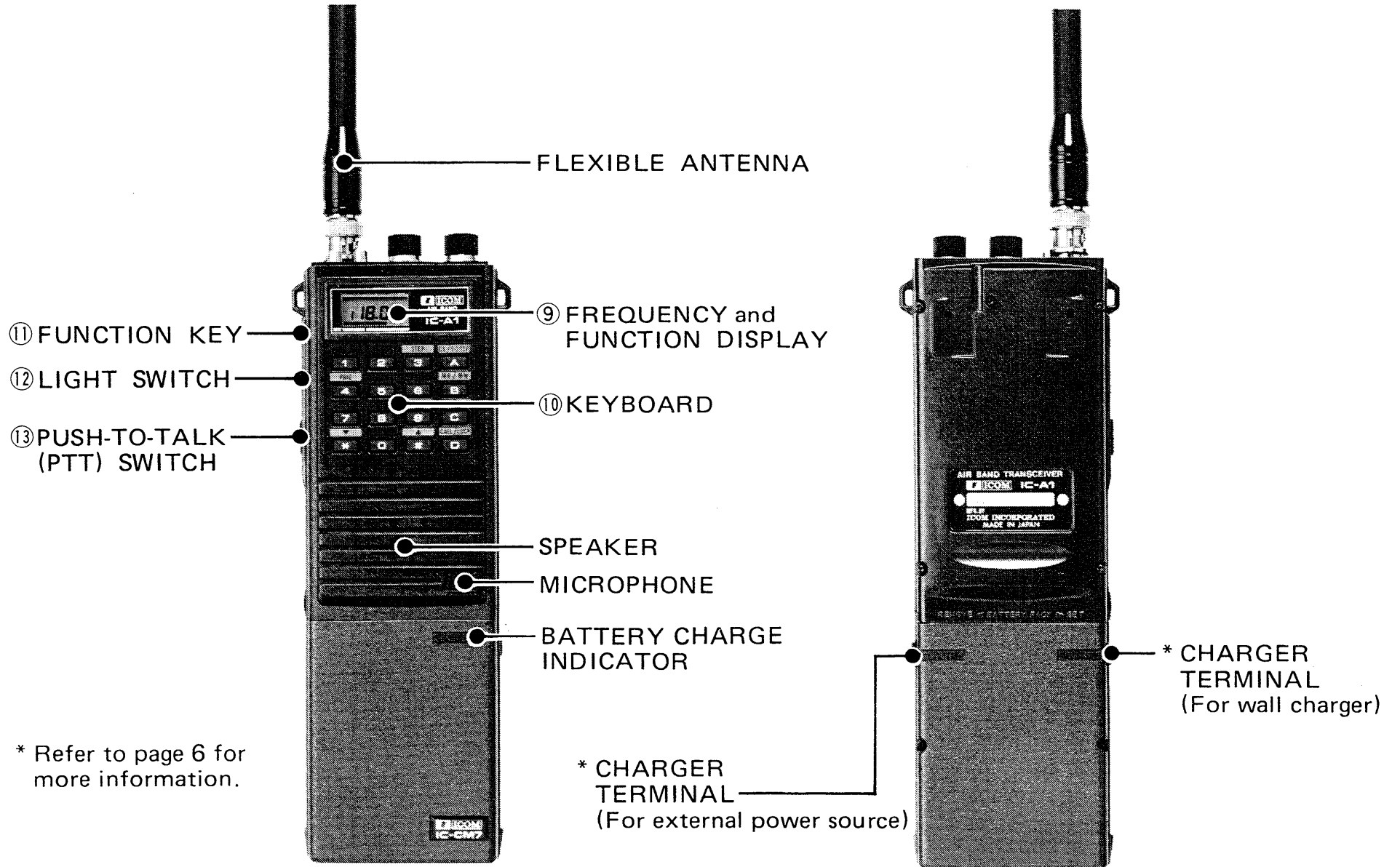

① ANTENNA CONNECTOR

Connect the supplied flexible antenna here.

CAUTION: Transmitting without an antenna may damage the transmitter.

② EXTERNAL DC POWER JACK

Voltage greater than 15 volts DC will damage your transceiver. Check the source voltage before connecting the power cord.

A voltage regulated DC power supply with an output of 13.8 volts may be connected here instead of using the supplied battery pack. Inserting a power plug into this jack disables the attached power pack. The IC-CM7 recharges automatically when power is applied here.

③ EXTERNAL MIC JACK

Connect an optional IC-CM9 speaker-microphone, or an optional HS-10 headset with HS-10SA VOX unit or HS-10SB PTT switch box here. When the external microphone is connected, the built-in microphone does not function.

④ EXTERNAL SPEAKER JACK

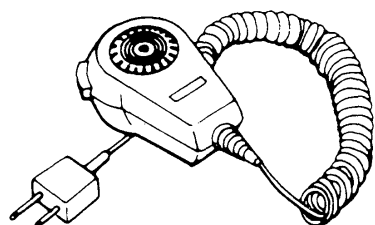

Speaker-microphone
IC-CM9 (OPTIONAL)

Connect an external speaker or earphone, if required, to this jack. Use a speaker with an impedance of 8 ohms. When the external speaker is connected, the built-in speaker does not function.

Or, connect an optional IC-CM9 speaker-microphone to the EXTERNAL MIC JACK and SPEAKER JACK as explained above.

⑤ **VOLUME CONTROL and POWER SWITCH**

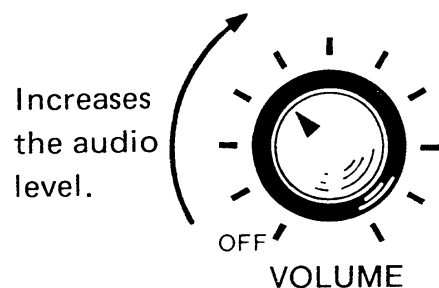

Rotate this control completely counterclockwise to turn the transceiver power OFF. Rotate the control clockwise beyond the "click" to turn the transceiver power ON, and further clockwise to increase the audio level.

⑥ **SQUELCH CONTROL**

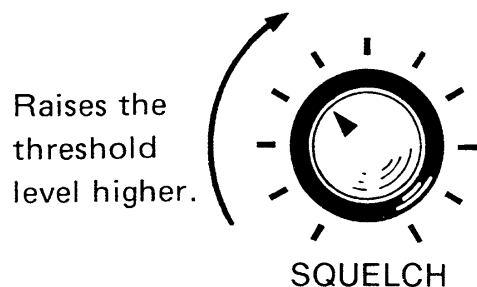

Sets the squelch threshold level. Rotate this control completely counterclockwise to turn OFF the squelch function, and clockwise to raise the threshold level.

⑦ **ANL SWITCH**



Push this switch (locked-IN) to reduce pulse type noise such as that caused by the ignition for more enjoyable reception. Push the switch again (OUT) to disable the circuit.

⑧ **RF POWER SWITCH**

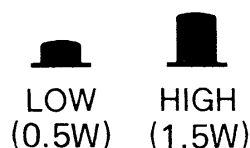

Switches the output power of the transceiver between the HIGH and LOW positions. In the HIGH (OUT) position, the output carrier power is 1.5 watts (4.8 watts PEP) with the IC-CM7 power pack. In the LOW (locked-IN) position, the output carrier is 0.5 watts.

⑨ **FREQUENCY and FUNCTION DISPLAY**

Displays the operating channel and status of the radio.

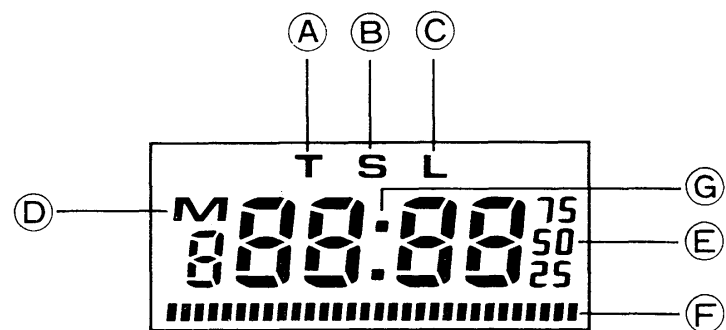

① **TRANSMIT INDICATOR**

"T" appears when the set is in the transmit mode.

② **SCAN INDICATOR**

"S" appears when the set is in the scan mode.

③ **LOCK INDICATOR**

"L" appears when the operating frequency is locked by holding the "FUNC" key down, and pushing the "D" key. In this condition, all keys are disabled except the "FUNC" and "D" keys which may be used to clear the lock function.

④ **MEMORY CHANNEL MODE INDICATOR**

"M" appears while using the memory read or memory write function.

⑤ **FREQUENCY DISPLAY**

Indicates the operating frequency with 5 digits representing 100MHz through 10kHz. The small numerals "75", "50" and "25" represent 7.5, 5.0 and 2.5kHz respectively.

Ⓕ S/BATTERY INDICATOR

Indicates the receive signal strength and battery voltage with a segmented bar. These functions are switched automatically when changing from the receive mode to the transmit mode.

Ⓖ PRIORITY INDICATOR

The indicator appears when the PRIORITY function is activated.

⑩ KEYBOARD

The keyboard has 16 keys consisting of ten numerical keys and six code keys. Some keys have dual functions.

The primary functions are available by simply pushing each key. The ten numerical keys input the number indicated on the key. The other keys operate the various functions indicated above each key with letters on a gray background.

The secondary functions are available by pushing each key while the "FUNC" key on the side of the transceiver is held down. Each function is indicated above the key with letters on an olive color background.

⑪ FUNCTION KEY

Push this key to select the secondary function of each key.

⑫ LIGHT SWITCH

While pushing this switch, the FREQUENCY and FUNCTION DISPLAY is illuminated.

⑬ PUSH-TO-TALK (PTT) SWITCH

Push this switch to begin transmitting. Speak clearly with a normal voice into the microphone. The internal microphone is an electret condenser type which responds well to most voice levels.

SECTION 6 GENERAL OPERATION

6 - 1 RECEIVING

Verify that the VOLUME CONTROL and POWER SWITCH is in the OFF position before connecting power to the transceiver.

- ① Rotate the VOLUME CONTROL and POWER SWITCH clockwise beyond the "click". A frequency appears on the FREQUENCY DISPLAY.
- ② Slowly rotate the VOLUME CONTROL clockwise to a comfortable level.
- ③ Select the desired frequency by pushing the appropriate keys.
- ④ The S/BATTERY INDICATOR displays the signal strength when a station is received.
- ⑤ If only noise with no signal is heard from the speaker, rotate the SQUELCH CONTROL clockwise until the noise stops. This is the threshold point. The transceiver remains silent after this adjustment until a signal is received which opens the receiver's squelch circuit.

If very weak signals are received, the squelch may open and close unreliably. In this case, rotate the SQUELCH CONTROL slightly further clockwise until the squelch operates correctly.

6 - 2 TRANSMITTING

- ① Push the PTT (Push-To-Talk) switch and the transceiver begins transmitting. At the same time, the letter "T" appears on the FREQUENCY and FUNCTION DISPLAY, and the S/BATTERY INDICATOR provides an indication of the battery condition.
- ② Speak into the microphone using your normal voice level.
- ③ Release the PTT switch to return to the receive mode.

NOTE: If the FREQUENCY and FUNCTION DISPLAY begins to blink while transmitting, this indicates the transmit signal is muted or cutoff. There is no output in this condition, and it may be caused by an exhausted battery pack or by attempting to operate outside the frequency range of the IC-A1.

6 - 3 KEY FUNCTIONS

Some keys have dual functions. To select the secondary function, push the "FUNC" key located on the side of the transceiver, and then push the correct key for the function you desire.

See the next page for the key functions table.

KEY	PRIMARY FUNCTION		SECONDARY FUNCTION	
	SYMBOL	FUNCTION	SYMBOL	FUNCTION
1	1	Inputs the digit 1.	-----	-----
2	2	Inputs the digit 2.	-----	-----
3	3	Inputs the digit 3.	STEP	Selects the size of the frequency steps. Push this key, and then one of the step keys "1" to "5".
4	4	Inputs the digit 4.	PRIO	Selects the priority function. To turn this function OFF, push the "A" (CL) key.
5	5	Inputs the digit 5.	-----	-----
6	6	Inputs the digit 6.	-----	-----
7	7	Inputs the digit 7.	-----	-----
8	8	Inputs the digit 8.	-----	-----
9	9	Inputs the digit 9.	BEEP	Turns ON and OFF the circuit which generates the beep tone each time a key is pushed.
0	0	Inputs the digit 0.	-----	-----
✳	▼	Decreases either the operating frequency with specified steps, or the memory channel number.	-----	-----
#	▲	Increases either the operating frequency with specified steps, or the memory channel number.	-----	-----

KEY	PRIMARY FUNCTION		SECONDARY FUNCTION	
	SYMBOL	FUNCTION	SYMBOL	FUNCTION
A	CL/S.STOP	<p>Clears the entered digits, and recalls the previous frequency.</p> <p>Clears the memory channel mode, and selects the dial mode.</p> <p>Clears the priority function.</p> <p>Clears any scan function, and halts the scan at the displayed operating frequency or memory channel.</p>	-----	-----
B	MR	<p>Selects the memory channel mode.</p> <p>Push this key, and then the desired memory channel number "1", "2", "3", "0".</p>	MW	<p>Writes the displayed frequency into a memory channel.</p> <p>Push this key, and then a memory channel number. The displayed frequency is written into the memory channel.</p>
C	MS	<p>Selects the memory scan mode.</p> <p>Push this key to scan all memories.</p>	PS	<p>Selects the programmed scan mode.</p> <p>Push this key to scan all frequencies between the limits stored in memory channels 9 and 0 using the specified steps.</p>
D	CALL	<p>Selects the call mode.</p> <p>Automatically recalls the frequency stored in memory channel 1. In the call mode, no other keys function except the "A" (CL) key, which is used to cancel the function, and the "FUNC"/"LOCK" keys.</p>	LOCK	<p>Disables the keys to prevent accidental key operation.</p> <p>To clear this function, push this key again while holding the "FUNC" key down.</p>

6 - 4 RESETTING THE CPU

If your IC-A1 does not operate as described in Sections 6 - 1 through 6 - 3, the transceiver's CPU (microprocessor) may need resetting. For example, common symptoms of this problem are:

- 1) The transceiver functions do not operate correctly, or do not operate at all, when the keys or controls are used.
- 2) The FREQUENCY and FUNCTION DISPLAY shows incomplete or incorrect information.

NOTE: Resetting the CPU erases all personal programming of your memory channels.

PROCEDURE

1. Rotate the VOLUME CONTROL and POWER SWITCH fully counterclockwise to turn the IC-A1 power OFF.
2. Push and hold down the "FUNC" key.
3. Rotate the VOLUME CONTROL and POWER SWITCH clockwise beyond the "click" to turn the transceiver power ON.
4. Release the "FUNC" key.

The CPU is now reset. The displayed frequency is 118.00MHz and all memory channels have this same frequency stored.

6 - 5 DIAL MODE (SELECTING A FREQUENCY)

To select an operating frequency, push the four numerical keys representing the desired frequency, beginning with the ten MHz digit and ending with the ten kHz digit.

If illegal digits or out-of-band frequencies are entered, the entered values are cancelled and the previous operating frequency is recalled.

If a wrong key is pushed, push the "A" (CL) key to cancel the wrong digits. The previous operating frequency is recalled.

EXAMPLE:

Select 118.10MHz.



First, turn the POWER SWITCH ON. If the frequency display shows the MEMORY CHANNEL mode as in the figure to the left, push the "A" (CL) key to clear the MEMORY mode. Then, push the keys as shown in the diagram.

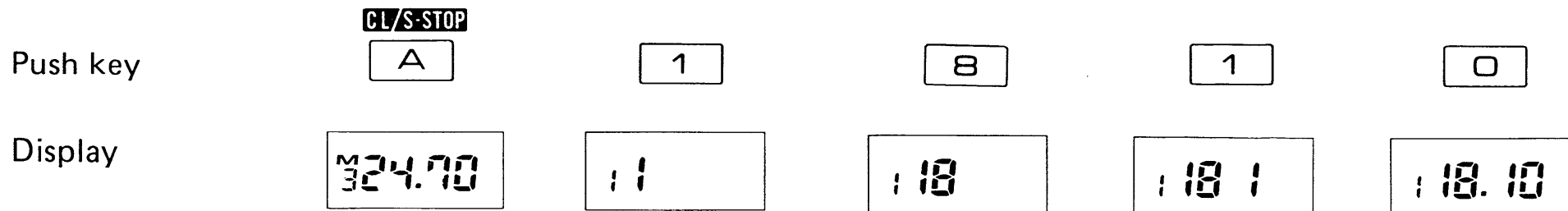

Each push of the “✖” (▼) or “#” (▲) key changes the operating frequency downwards or upwards, respectively, at a specified frequency step rate (described below). In the same way, holding these keys down shifts the operating frequency continuously.

6 - 6 SETTING FREQUENCY STEP RATE

To set the frequency step rate, push and hold the “FUNC” key, push the “3” (STEP) key, and then push a key to determine the step rate.

EXAMPLE:

Select 50kHz steps.

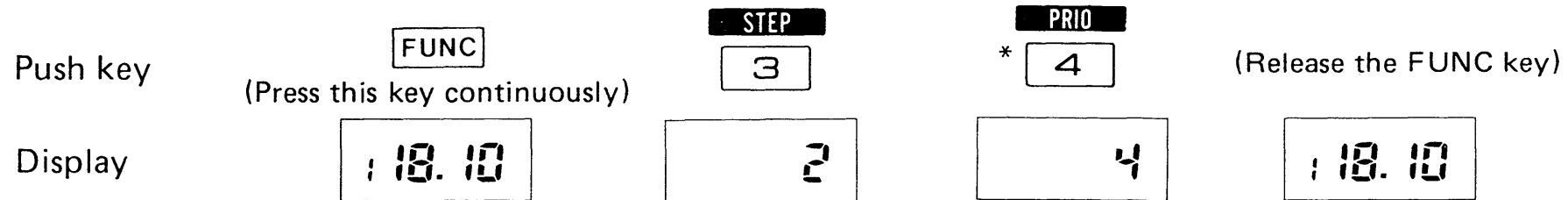

* The frequency step rates associated with keys “1” to “5” are shown in the following table.

KEY/DISPLAY	1	2	3	4	5
FREQUENCY STEP RATE (kHz)	12.5	25	37.5	50	62.5

6 - 7 MEMORY CHANNEL MODE

1. MEMORY WRITE

Select the desired frequency to be stored by following the procedure in Section 6 - 5. Then, while pushing the "FUNC" key, push the "B" (MW) key and the numerical key with the same number as the memory channel desired ("1", "2", "3", "0").

EXAMPLE:

Store 125.10MHz in memory channel 8.

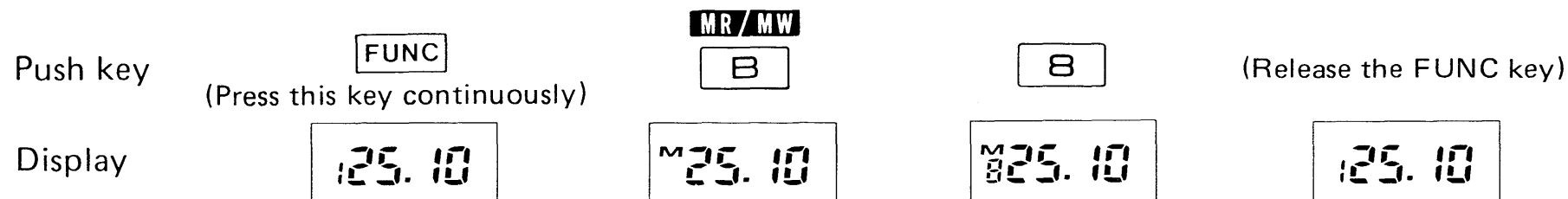

2. MEMORY READ

To recall a frequency stored in a memory channel, push the "B" (MR) key, then push a numerical key with the same number as the memory channel desired.

NOTE: The frequency 118.00MHz has already been stored in all memory channels 1, 2, 3, 0 by the factory.

EXAMPLE 1:

While in the DIAL mode, recall the frequency stored in memory channel 7.

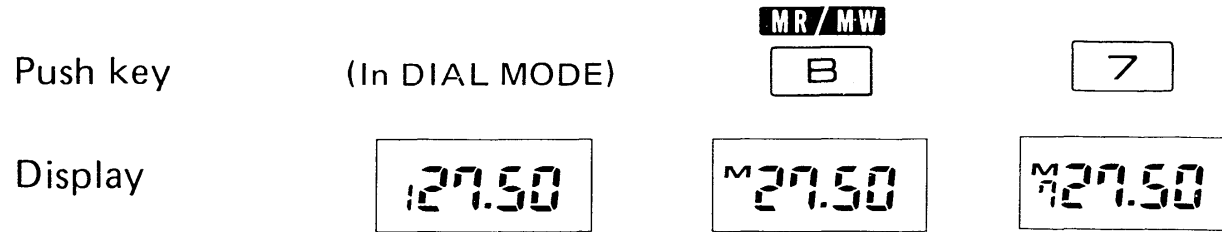





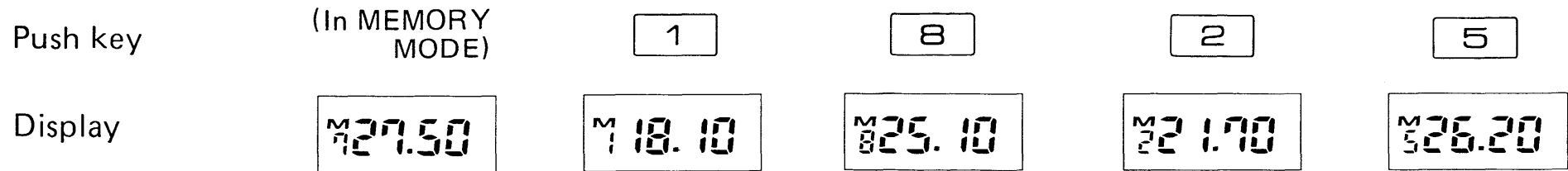

EXAMPLE 2:

After completing EXAMPLE 1, the remaining memory channels can be recalled by simply pushing the numerical key corresponding to the memory channel desired.

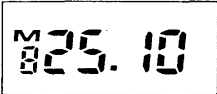

EXAMPLE 3:

Each push of the “#” (▲) key shifts the memory channel by one channel consecutively upwards, and the channel number appears on the display. Holding the “#” key down, shifts the memory channel continuously upwards.

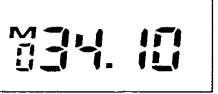
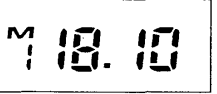
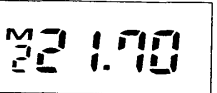
Push key					
		#	#	#	#
Display					



In the same manner, pushing the “*” (▼) key shifts the memory channel selected downwards.

3. MODE CHANGING

Push the “A” (CL) key to clear the MEMORY CHANNEL mode and return to the DIAL mode. The frequency last displayed in the MEMORY mode remains on the display in the DIAL mode.

EXAMPLE:

Change the mode from MEMORY CHANNEL to DIAL.

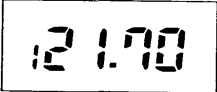
Push key	(In MEMORY MODE)	
		A
Display		

NOTE: In the MEMORY CHANNEL mode, all secondary functions except the PRIORITY and LOCK functions are disabled.

4. CALL KEY

When the transceiver is in either the MEMORY CHANNEL or DIAL modes, push the "D" (CALL) key to quickly select the frequency stored in memory channel 1.

When using the CALL function, all keys (primary and secondary) are disabled except the "A" (CL) and "LOCK" keys.

To clear the CALL function, push the "A" (CL) key. The transceiver switches back to the frequency or memory channel selected immediately prior to using the CALL function.

EXAMPLE:

Using the CALL function.

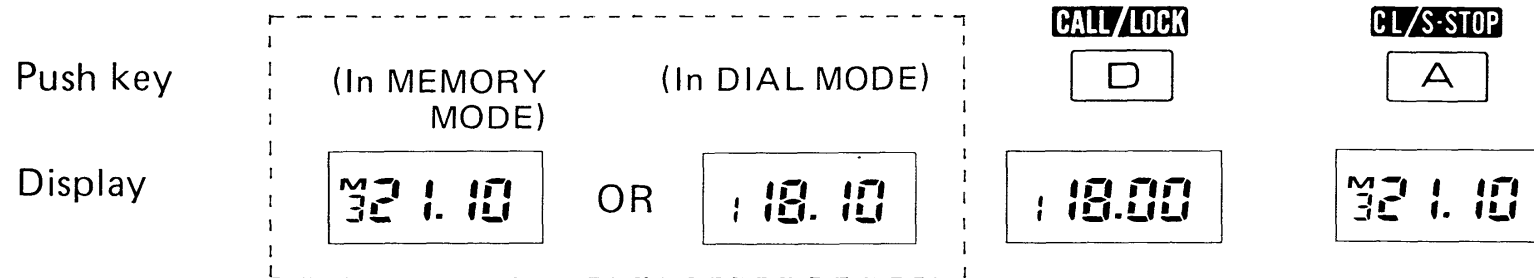

6 - 8 PRIORITY FUNCTION

This feature allows easy checking of an important frequency for activity, such as a local calling frequency, while operating in the DIAL or MEMORY CHANNEL modes.

This indicator appears when the PRIORITY FUNCTION is activated.

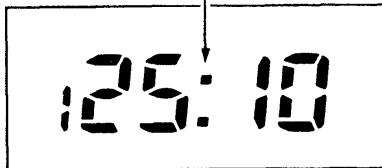

NOTE: If a signal is received on the priority frequency, the receiver does not stop on the frequency. The receiver continues to check both frequencies.

- ① Store your preferred frequency in memory channel 1. (Refer to page 23 for MEMORY WRITE instructions.)
- ② Select the desired operating frequency by key input or by choosing a memory channel which already has the frequency stored.
- ③ Push and hold the "FUNC" key, and then push the "4" (PRIO) key. The transceiver now receives on the operating frequency for five seconds and on the preferred frequency in memory channel 1 for one second. This cycle continues until the PRIORITY function is cleared. A dot appears above the frequency decimal point to indicate the PRIORITY function is selected.
- ④ All keys are disabled except the "A" (CL) key while in the PRIORITY function.
- ⑤ If the transmit mode is used while the PRIORITY function is engaged, the operating frequency is used for the transmit frequency. When the transmission is complete, the receive PRIORITY function continues.
- ⑥ Push the "A" (CL) key to clear the PRIORITY function.

EXAMPLE:

Memory channel 1 contains 118.10MHz and the operating frequency is 125.10MHz

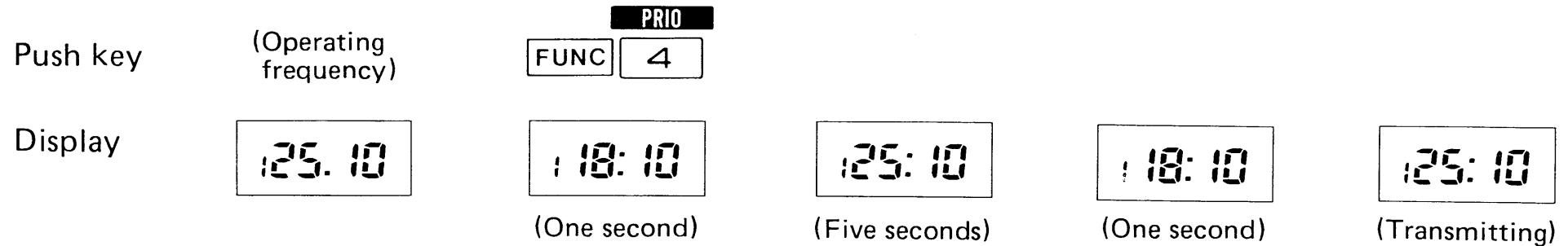

6 - 9 LOCK FUNCTION

This feature prevents accidental changes in the operating frequency, memory channel, mode, etc. The function works in both DIAL and MEMORY CHANNEL modes.

To clear the LOCK function, push and hold the "FUNC" key and then push the "D" (LOCK) key again.

Push and hold the "FUNC" key, and then push the "D" (LOCK) key to activate the function. The displayed frequency is now locked and the letter "L" appears which indicates the LOCK function is in use. All keys are disabled.

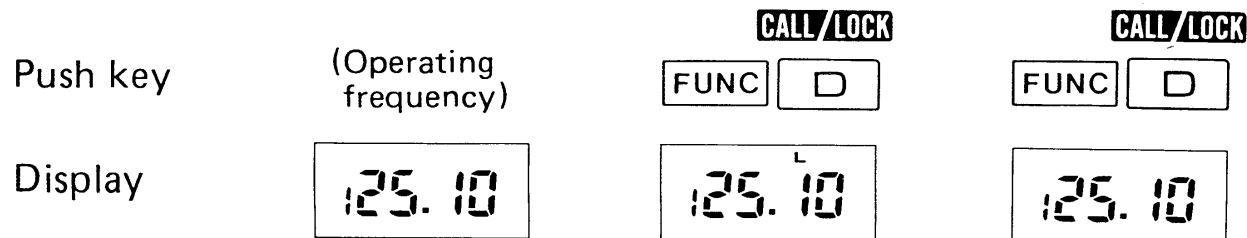

6 - 10 SCANNING OPERATION

1. MEMORY SCAN

(In DIAL mode)

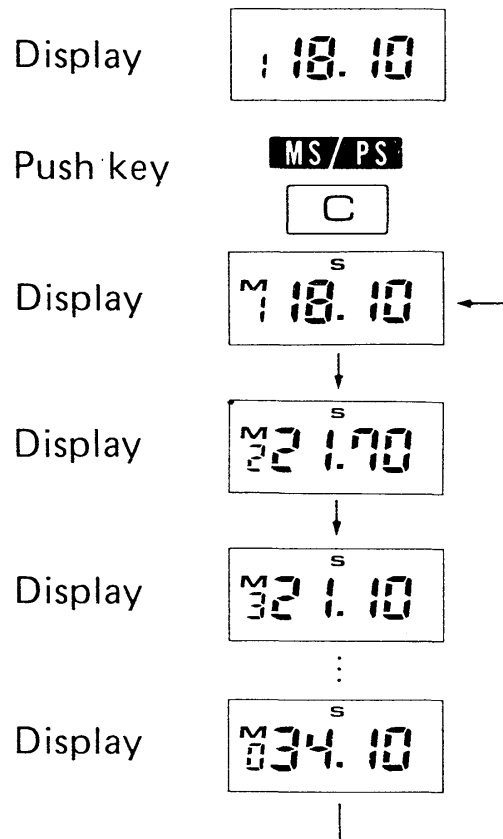

When in the MEMORY SCAN mode, all keys are disabled except the "A" (CL) key.

The IC-A1 is equipped with both MEMORY SCAN and PROGRAMMED SCAN functions.

- ① Store the desired frequencies in memory channels 1, 2, 3, - - - - 0.
- ② To start the scan, push the "C" (MS) key. The letter "S" appears on the frequency display and the scan begins. If the SQUELCH is engaged, the scan halts when a receive signal opens the squelch circuit. The scan automatically resumes when the frequency is clear of any signal.
- ③ To resume the scan after the receiver has stopped on a memory channel due to a signal, push the "C" (MS) key. The receiver continues scanning in the usual manner.
- ④ When transmitting while in the MEMORY SCAN mode, the transmit frequency is the same as the frequency which appears on the display at the moment the PTT switch is pushed. Transmitting clears the scan function, and the transceiver remains locked on the memory channel where the scan halted.
- ⑤ Push the "A" (CL) key to cancel the scan function. The scan stops on the memory channel displayed, and the letter "S" disappears from the display.

2. PROGRAMMED SCAN

NOTE: Frequencies for the high limit and low limit may be stored in either memory channel 9 or 0 since the programmed scan begins from memory channel 0 and moves towards memory channel 9 at all times.

This is used to scan between two frequency limits or boundaries which are stored in the memory channels.

- ① Store the high and low frequency limits for the desired scan range in memory channels 0 and 9.
- ② Select the DIAL mode by pushing the "A" (CL) key. The PROGRAMMED SCAN does not start if the transceiver is in the MEMORY CHANNEL mode.
- ③ Push and hold the "FUNC" key, and then push the "C" (PS) key. The scan begins from the frequency stored in memory channel 0 and moves towards the frequency stored in memory channel 9. The speed of the scan depends on the frequency step rate setting.
- ④ When the frequency stored in memory channel 9 is reached, the scan jumps to the channel 0 frequency and resumes scanning towards the channel 9 frequency in a continuous cycle.
- ⑤ If the SQUELCH is engaged, the scan halts when a receive signal opens the squelch circuit. The scan automatically resumes when the frequency is clear of any signal.

- ⑥ To resume the scan after the receiver has stopped on a frequency due to a signal, push the "C" (MS) key. The receiver continues scanning in the usual manner.
- ⑦ When transmitting while in the SCAN mode, the transmit frequency is the same as the frequency which appears on the display at the moment the PTT switch is pushed. Transmitting clears the scan function, and the transceiver remains locked on the frequency where the scan halted.
- ⑧ Push the "A" (CL) key to cancel the function. The scan stops, the letter "S" disappears from the display and the transceiver returns to the DIAL MODE.
- ⑨ When in the SCAN mode, all keys are disabled except the "A" (CL) key.

EXAMPLE:

Scanning between 134.10MHz and 121.80MHz.

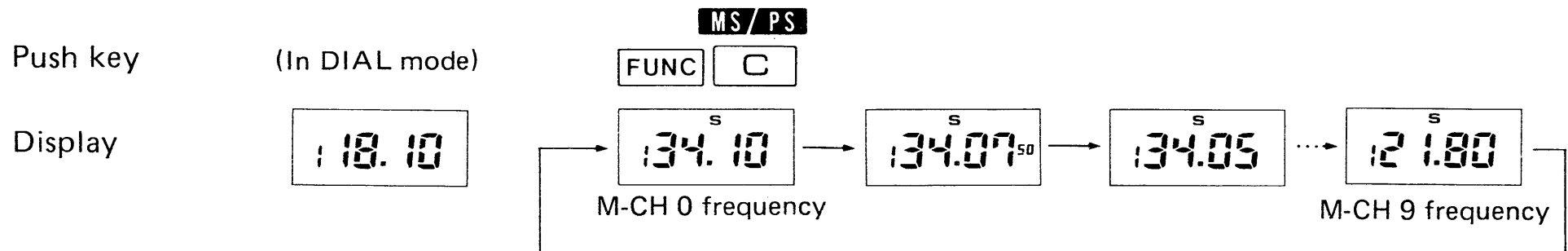

6 - 11 BATTERY INDICATOR

In the transmit mode, a segmented bar indicates the battery condition. The transceiver works normally if the right end of the bar reaches into the silver zone. If the bar does not reach into the silver zone while transmitting, the battery is exhausted.

At this time, stop using the transceiver and either replace or recharge the power pack.

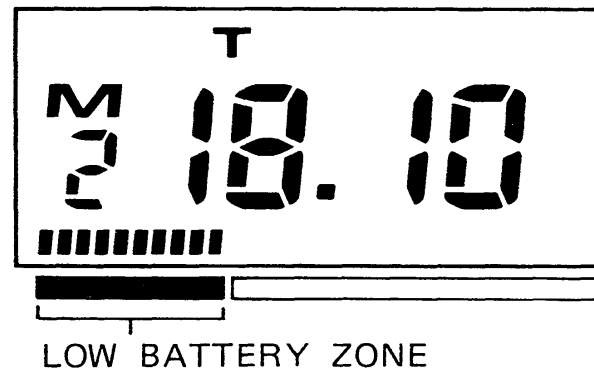

NOTE: The transceiver continues to work for about one hour in receive mode, and about 2 minutes in transmit mode after the bar indicator reaches the **LOW BATTERY ZONE**.

6 - 12 OPERATING GUIDELINES

1. PREVENT INTERFERENCE

Before transmitting, monitor the frequency you wish to use to avoid interrupting transmissions in progress.

2. SERVICING

Your IC-A1 was designed to provide years of trouble-free operation in many different environments. This is possible by using the most current technology along with ICOM's years of experience in the production of high quality, dependable VHF/AM equipment.

However, as with all electronic equipment, it is possible that some problems may occur that would interfere with the operation of the set. Should such a problem occur, we recommend that you take your transceiver directly to an ICOM dealer or authorized ICOM repair service center for qualified service.

OPTIONS

DESK BATTERY MULTI-CHARGER
CM-60

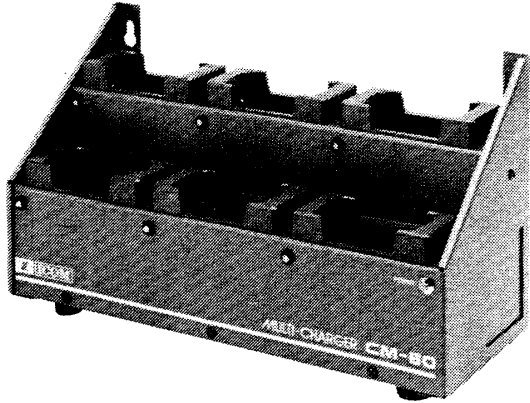

DESK BATTERY CHARGER
CM-35

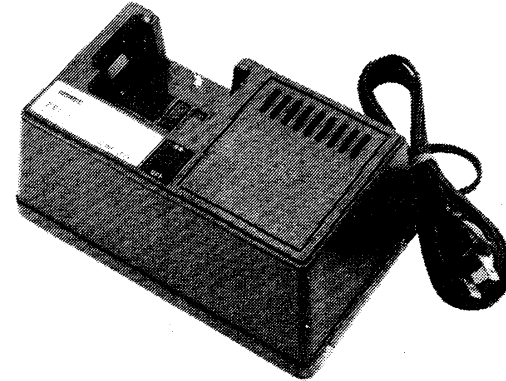

SPEAKER-MICROPHONE
IC-CM9



BELT CLIP

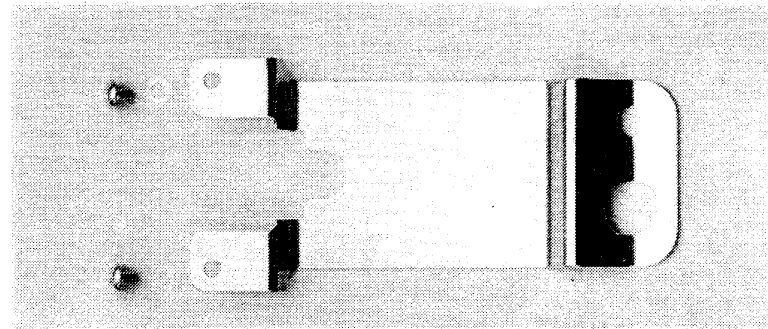



ICOM INCORPORATED

1-6-19, KAMIKURATSUKURI, HIRANO-KU,
OSAKA 547, JAPAN

A-0656

Printed in Japan