

INSTRUCTION MANUAL

VHF AIR BAND TRANSCEIVER
IC-A200

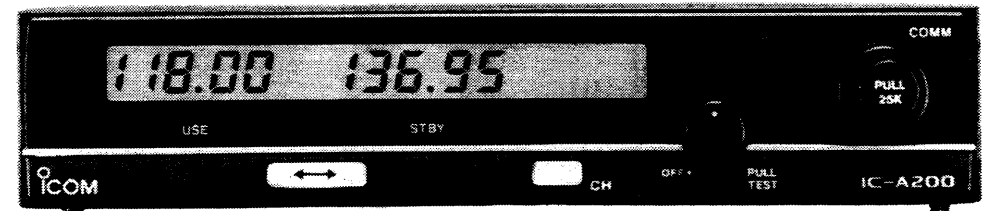

Icom Inc.

IMPORTANT

READ THIS INSTRUCTION MANUAL CAREFULLY before attempting to operate the transceiver.

SAVE THIS INSTRUCTION MANUAL. This instruction manual contains important safety and operating instructions for the IC-A200.

FOREWORD

Thank you for purchasing the **IC-A200 VHF AIR BAND TRANSCEIVER** with Icom's state-of-the-art technology. The **IC-A200** can be installed in your instrument panel and is easy to operate.

To fully appreciate the capabilities of your **IC-A200**, please read this instruction manual thoroughly before attempting operation.

If you have any questions regarding the operation of the **IC-A200**, feel free to contact your nearest authorized Icom Avionics Dealer or Service Center.

CAUTIONS

NEVER connect the transceiver to an AC outlet or to a power source of more than 16 V DC. Higher voltage ruins the transceiver.

NEVER connect the transceiver to a power source using reverse polarity. This connection ruins the transceiver.

AVOID using or placing the transceiver in areas with temperatures below -20°C or above $+50^{\circ}\text{C}$.

DO NOT turn the power ON until the aircraft engines have been started. This is important for protection of the circuit.

EXPLICIT DEFINITIONS

WORD	DEFINITIONS
WARNING	Personal injury, fire hazard or electric shock may occur.
CAUTION	Equipment damage may occur.
NOTE	If ignored, inconvenience only. No personal injury or risk of electric shock.

TABLE OF CONTENTS

IMPORTANT	i	3. RECEIVING AND TRANSMITTING	6
FOREWORD	i	■ Receiving.....	6
CAUTIONS	i	■ Transmitting.....	6
EXPLICIT DEFINITIONS	i	4. MEMORY OPERATION	7~10
TABLE OF CONTENTS	ii	■ Programming notes.....	7
1. PANEL DESCRIPTION	1~2	■ Programming a memory channel.....	7
■ Front panel.....	1	■ Programming example.....	8
■ Function display.....	2	■ Memory recall in the STBY window.....	9
■ Remote switches and jacks.....	2	■ Memory recall in the USE window.....	9
2. FREQUENCY SELECTION	3~5	■ Memory recall example.....	10
■ Frequency selection methods.....	3	■ Remote memory selection.....	10
■ STBY window frequency selection.....	3	5. REMOVAL AND INSTALLATION	11
■ Frequency exchanging.....	4	■ Transceiver removal.....	11
■ USE window frequency selection.....	4	■ Transceiver installation.....	11
■ Frequency set example.....	5	6. SPECIFICATIONS	12
		■ General.....	12
		■ Transmitter.....	12
		■ Receiver.....	12

PANEL DESCRIPTION

Front panel

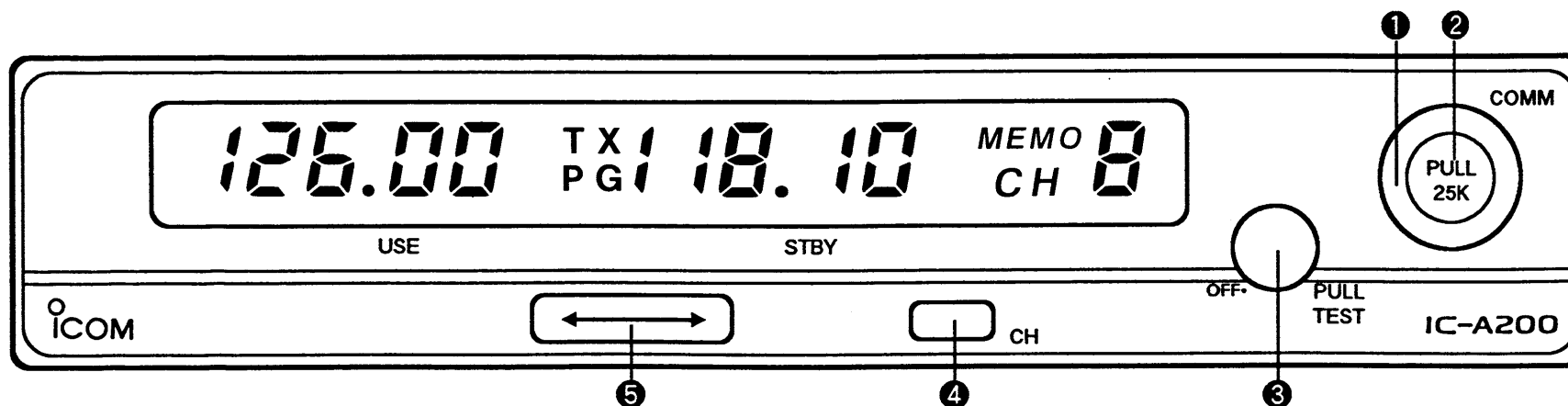

① LARGE TUNING KNOB

- Changes the STBY or USE window frequency in 1 MHz steps. (pgs. 3~4)
- Selects a memory channel. (pgs. 7~10)
- Programs a selected memory channel as a blank channel. (p. 7)

② SMALL TUNING KNOB

- Changes the STBY or USE window frequency in 25 or 50 kHz steps. This knob does not change the 1 MHz digit. (p. 3~4)
- Selects a memory channel. (pgs. 7~10)

③ VOLUME CONTROL

- Turns power ON and adjusts the audio level. (p. 6)
- When pulled OUT, opens the squelch manually for testing. (p. 6)

④ CHANNEL SWITCH [CH]

- Recalls a memory channel in the STBY window. (p. 7)
- When pushed and held, allows memory channel programming. (p. 7~8)

⑤ FREQUENCY EXCHANGE SWITCH [↔]

- Exchanges the USE window frequency for the STBY window frequency and vice versa. (p. 4)
- When pushed and held, hides the STBY window frequency and allows selection of the USE window frequency directly. (p. 4)

■ Function display

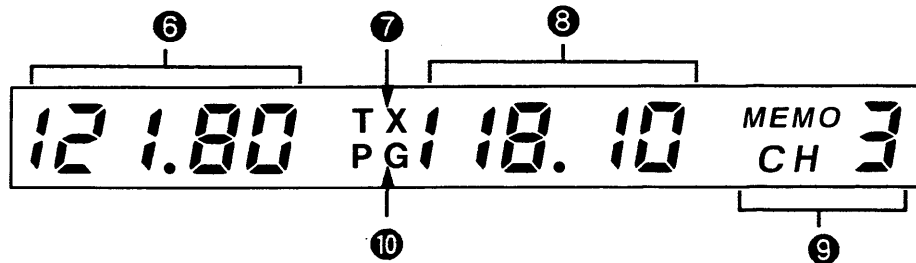

⑥ USE WINDOW

Indicates the operating frequency that is used for transmitting and receiving.

⑦ TRANSMIT INDICATOR

Appears while transmitting. (p. 6)

⑧ STBY WINDOW

- Indicates the standing-by frequency which is used as the next operating frequency.
- When a memory channel is recalled, indicates the memory channel frequency content.

⑨ MEMORY CHANNEL INDICATOR

Indicates a selected memory channel number.
(pgs. 7~10)

⑩ PROGRAMMING INDICATOR

Indicates that a memory channel can be programmed.
(pgs. 7~8)

■ Remote switches and jacks

The following switches and jacks can be installed on your aircraft. Ask your Icom Avionics Dealer for wiring.

Headphone jack

Connects a 500 Ω headset.

Microphone audio jack

Connects a low-impedance carbon or dynamic microphone. A preamplifier is required for a dynamic microphone.

Yoke-mounted communication/intercom switch

- Set to the “communication” position for the air band. (p. 6)
- Set to the “intercom” position to talk with a crew member. This allows communication between the pilot and co-pilot. (p. 6)

Yoke-mounted channel switch

Remotely selects a memory channel. (p. 9)

- Cannot be used for memory channel programming.

Yoke-mounted frequency exchange switch

Remotely exchanges the USE window frequency for the STBY window frequency and vice versa.

Frequency selection methods

There are 2 ways to select a desired frequency.

General frequency selection

Select a desired frequency which is used for the next operating frequency in the STBY window. Then, exchange the USE window frequency for the STBY window frequency.

Refer to STBY window frequency selection at right and frequency exchanging. (p. 4)

Direct frequency selection

Select a desired frequency in the USE window directly.

Refer to USE window frequency selection. (p. 4)

CONVENIENT: For quick frequency selection, often-used frequencies can be programmed into memory channels. Refer to memory operation. (pgs. 7~10)

When a memory channel is recalled, the previous STBY window frequency is erased.

STBY window frequency selection

CAUTION: DO NOT turn the power ON until the aircraft engines have been started. This is important for protection of the circuits.

- 1) Rotate the volume control clockwise to turn the power ON.
 - Previously used frequencies appear in the USE and STBY windows.
- 2) Rotate the large and small tuning knobs to select a desired frequency.
 - The USE window frequency is not affected.
 - To change the 1 MHz digit, use the large tuning knob. The small tuning knob does not change the 1 MHz digit.

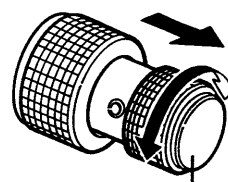

25 kHz steps
when pulled OUT.

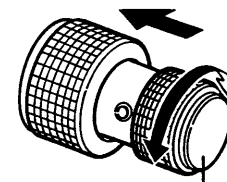

50 kHz steps
when pushed IN.

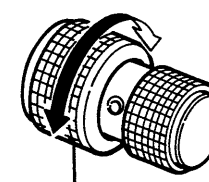

1 MHz steps.

■ Frequency exchanging

After selecting the STBY window frequency, push [↔] to exchange the USE window frequency for the STBY window frequency.

Frequency exchanging can also be performed remotely from the yoke-mounted frequency exchange switch.

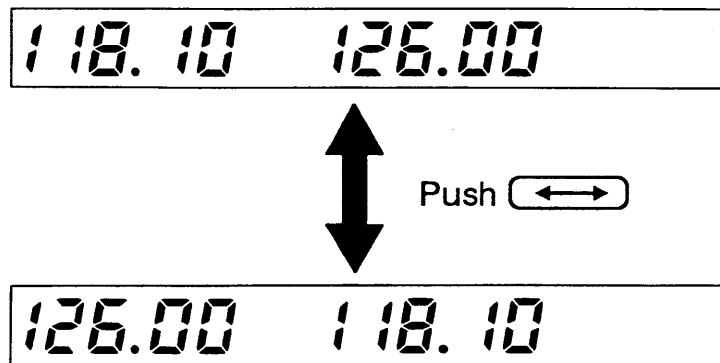

NOTE: DO NOT push and hold [↔] continuously, or the STBY window frequency disappears.

■ USE window frequency selection

The USE window frequency can be selected directly without frequency selection in the STBY window.

- 1) Push and hold [↔] until the STBY window frequency is hidden.
 - The yoke-mounted frequency exchange switch cannot be used.

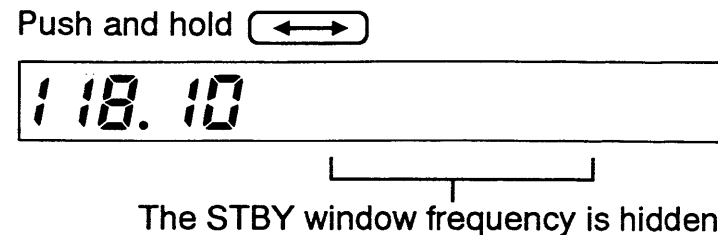









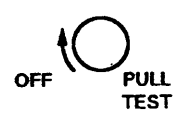

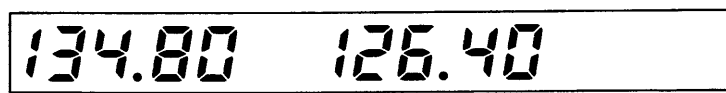
- 2) Select a desired frequency using the large and small tuning knobs.
- 3) Push [↔].
 - Previous STBY window frequency appears.

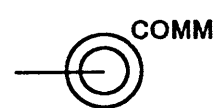
2 FREQUENCY SELECTION

■ Frequency set example

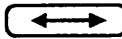
The following is an example of how to select 126.125 MHz in the STBY window, and then transfer it to the USE window.

① Rotate clockwise.			Previously used frequencies appear.
② Select 126.40 MHz.			Rotate the large tuning knob to change the STBY window frequency in 1 MHz steps.
③ Select 126.15 MHz.			Rotate the small tuning knob to change the STBY window frequency in 50 kHz steps.
④ Pull OUT to select 25 kHz steps.			Pull OUT the small tuning knob to select 25 kHz steps.
⑤ Select 126.125 MHz.			Rotate the small tuning knob to change the STBY window frequency in 25 kHz steps.
⑥ Push  • DO NOT hold.			The USE window frequency and the STBY window frequencies are exchanged.

■ Receiving

- 1) Select an operating frequency.
 - Refer to pgs. 3~4 for details.
- 2) Pull the volume control OUT to open the squelch manually.
- 3) Rotate the volume control to adjust the audio level.
- 4) Push the volume control IN to close the squelch.
 - The squelch automatically opens only when a signal is received.

When pulled OUT

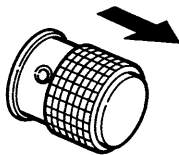

The squelch opens manually.

When pushed IN

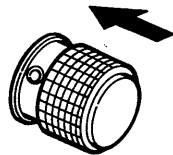

The squelch opens only when a signal is received

CONVENIENT: The intercom function is useful for swift communication between the pilot and co-pilot.

Set the communication/intercom switch on the VHF control panel to the “intercom” position. Voice signals from the microphone are sent to both the pilot and co-pilot’s headsets.

■ Transmitting

NOTE: To prevent interference, listen on the frequency before transmitting. If the frequency is busy, wait until the frequency is clear.

- 1) Select the yoke-mounted communication/intercom switch to the “communication” position.
- 2) Select an operating frequency.
- 3) Push the PTT switch.
 - “TX” appears.

A digital display showing the frequency 118.10 on the left, TX in the middle, and 126.00 on the right.

- 4) Speak into the microphone at your normal voice level.
 - **DO NOT** set the microphone too closely to your mouth or speak too loudly. This may distort the signal.
- 5) Release the PTT switch to receive.

4 MEMORY OPERATION

■ Programming notes

Blank channel

A memory channel with no frequency content is called a blank channel. When a blank channel is selected while programming, “ — — — — ” appears instead of a frequency.

Switch operation

Note that “push” and “push and hold” performs different functions at right.

The yoke-mounted channel switch cannot be used for memory channel programming.

During memory channel programming, if no operation is performed for approx. 15 sec., the transceiver automatically operates as following:

- Writes the selected frequency into the selected memory channel.
- Returns to normal operation.

Protect channel

To prevent accidental changes, required memory channels can be specified as protected channels. Even if [↔] is pushed and held, the frequency content does not blink and it cannot be changed. Your Icom Avionics Dealer can activate and cancel this setting.

■ Programming a memory channel

The transceiver is equipped with 9 memory channels. You can program often-used frequencies into them.









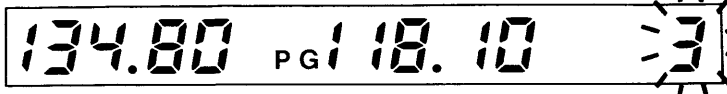

- 1) Push and hold [CH] until the memory channel number blinks.
- 2) Rotate the large or small tuning knob to select a memory channel to be programmed.
- 3) Push [↔].
 - Frequency content or “ — — — — ” blinks.
- 4) Rotate the large and small tuning knobs to select a desired frequency.
- 5) Push [CH] to return to normal operation.

NOTE: To program other memory channels successively push [↔] after step 4) and repeat steps 2)~4).

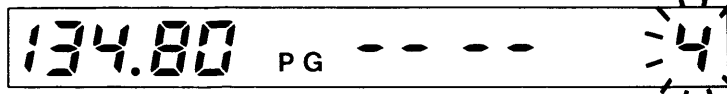
To program a memory channel as a blank channel, select “ — — — — .” Using the large tuning knob, “ — — — — ” appears between 118 MHz and 136 MHz.

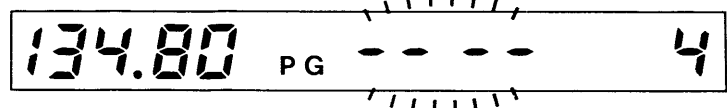
■ Programming example

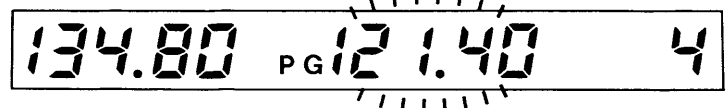
The following is an example of how to program 121.40 MHz into memory channel 4.

① Start from any display.		
② Push and hold  CH		"PG" and the previously used memory channel appears.
③ Select memory channel 4. 		" - - - - " appears when no frequency has been programmed into memory channel 4.
④ Push  • DO NOT hold.		Frequency content or " - - - - " blinks.
⑤ Select 121.40 MHz. 		
⑥ Push  • DO NOT hold.		Previous STBY window frequency appears.

4 MEMORY OPERATION

■ Memory recall in the STBY window

Memory channel selection is performed in the STBY window.

- 1) Push [CH].
 - **DO NOT** push and hold [CH], or another function is activated.
 - Perform next step below within 5 sec.

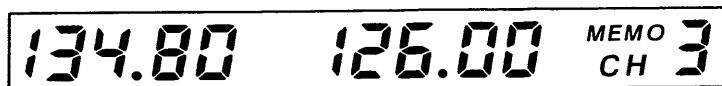

"MEMORY" and previously-used memory channel appear.

- 2) Rotate the large or small tuning knob to select a memory channel.
 - When any switches or tuning knobs are not operated, after 5 sec., the memory channel content is automatically transferred into the STBY window.

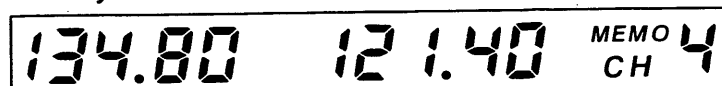

Disappears after 5 sec.

■ Memory recall in the USE window

For quick operation in the USE window, a recalled memory channel can be transferred into the USE window without waiting for 5 sec.

- 1) Push [CH].
 - **DO NOT** push and hold [CH], or another function is activated.

- 2) Rotate the large or small tuning knob to select a memory channel.

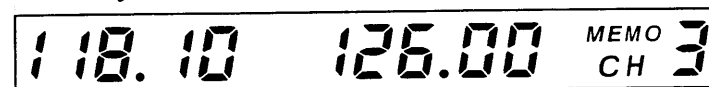

- 3) Push [↔].
 - The memory channel content is copied into the USE window.
 - The previous USE window frequency is transferred into the STBY window.

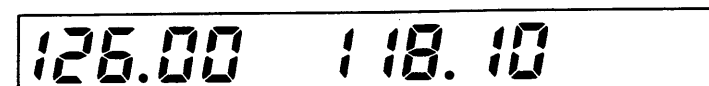



Memory recall example

The following is an example of how to recall memory channel 4 into the STBY window.

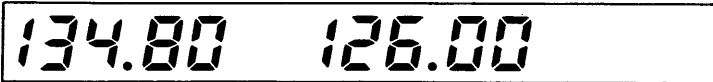
Even when the power is OFF, the IC-A200 retains all memory channel contents.

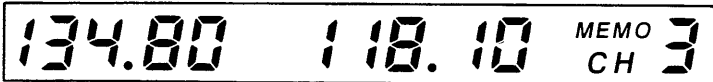
① Start from any display. 

② Push  CH  "MEMO" and the previously-used memory channel appears.

③ Select memory channel 4.   After 5 sec., the memory channel content is automatically transferred into the STBY window.



Remote memory selection

Memory channel selection can also be performed remotely from the yoke-mounted channel switch.

Push the yoke-mounted channel switch several times to increase the memory channel number.

- When no switches are operated for 5 sec., the memory channel content is transferred into the STBY window.

5

REMOVAL AND INSTALLATION

■ Transceiver removal

The IC-A200 is easily removed from the mounting rack, if required.

- 1) Insert a 3/32 in allen wrench into the hole in the front panel.
- 2) Rotate the wrench counterclockwise until the front panel moves slightly from the mounting rack.

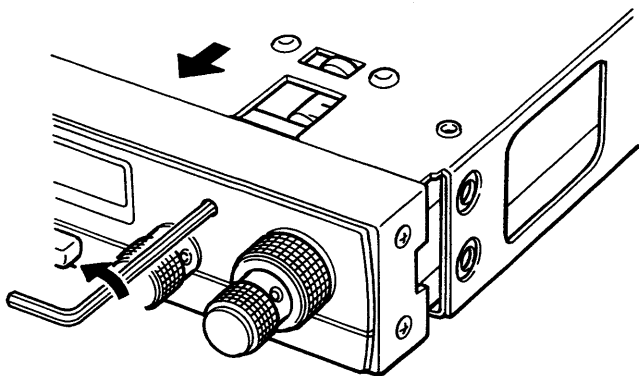

- 3) Slowly pull the transceiver out from the mounting rack.

■ Transceiver installation

- 1) Visually confirm that the metal catch on the top of the transceiver is as shown below.

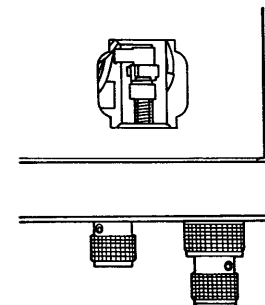

- 2) Slowly insert the transceiver into the mounting rack.
- 3) Insert a 3/32 in allen wrench into the hole in the front panel.
- 4) Rotate the wrench clockwise until the screw stops.
 - **DO NOT** overtighten the screw.

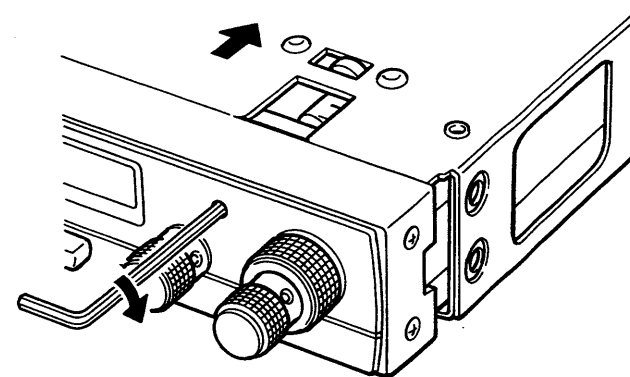

■ General

- Frequency range : 118.000–136.975 MHz
- Mode : AM (6K00A3E)
- Tuning steps : 25 kHz, 50 kHz or 1 MHz
- Number of memory channels: 9
- Antenna impedance : 50 Ω
- Power supply requirement : 13.8 V DC ± 15%
(negative ground)
- Current drain :

Transmit		2.6 A
Receive	Max. audio output	600 mA
	Squelched	320 mA

- Usable temperature range : –20°C to +55°C
- Frequency stability : ± 0.0015%
(–20°C to +55°C)
- Dimensions : 160(W) × 34(H) × 271(D) mm
6.3(W) × 1.3(H) × 10.7(D) in
(Projections not included)
- Weight : 1.1 kg; 2.4 lb

■ Transmitter

- Output power : 7 W (Carrier power)
- Microphone impedance : 600 Ω

■ Receiver

- Receive system : Double-conversion
superheterodyne
- Intermediate frequencies : 1st 32.455 MHz
2nd 455 kHz
- Sensitivity : 2 μV for 6 dB S/N
(with 1 kHz, 30% modulation)
- Spurious rejection : –70 dB
- Audio output power : 5 W with a 4 Ω load
60 mW with a 500 Ω load

All stated specifications are approximate and subject to change without notice or obligation.

Count on us!

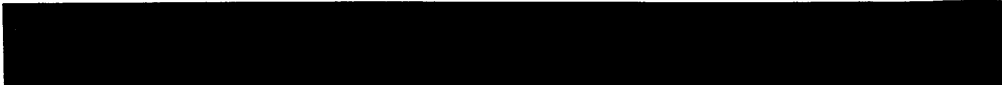
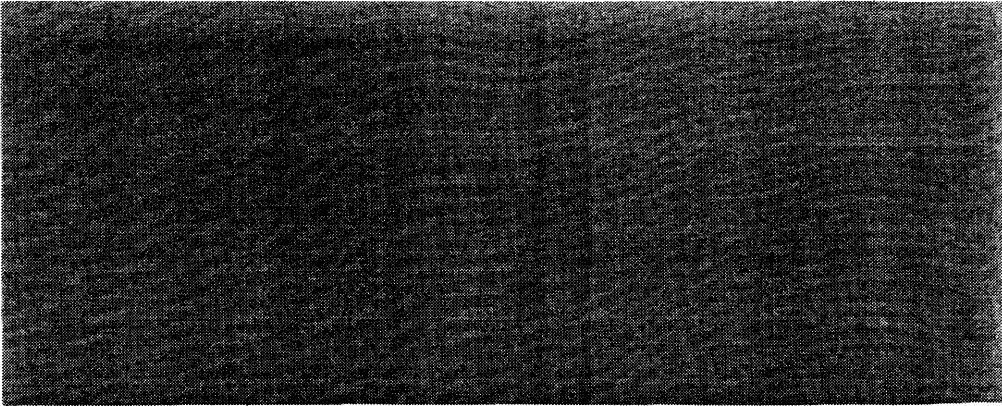

A-5183H-1EX-②
Printed in Japan
© 1991-2003 Icom Inc.

Icom Inc.
1-1-32 Kamiminami, Hirano-ku, Osaka 547-0003 Japan