



Radio Mods Manuals

INSTRUCTION MANUAL

VHF AIR BAND TRANSCEIVER

IC-A22

IC-A22E

This device complies with Part 15 of the FCC Rules. Operation is subject to the condition that this device does not cause harmful interference.

Icom Inc.

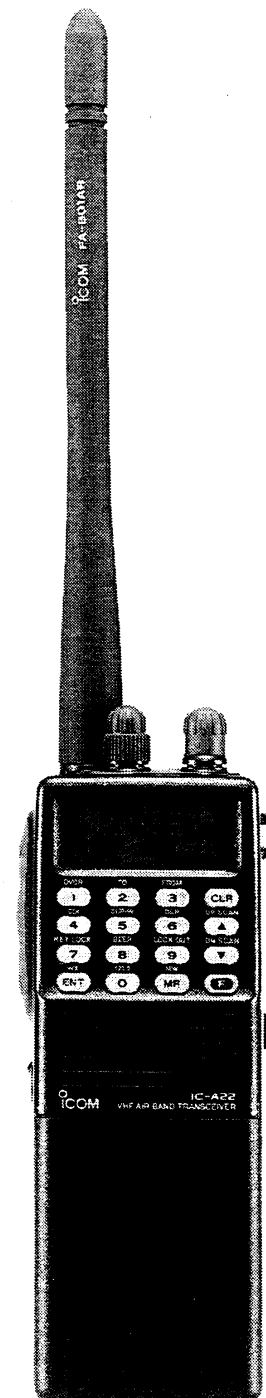

The IC-A22 and IC-A22E VOR functions are supplemental aids to navigation only and are not intended to be a substitute for accurate VOR equipments.

IMPORTANT

READ ALL INSTRUCTIONS carefully and completely before using the transceiver.

SAVE THIS INSTRUCTION MANUAL – This instruction manual contains important safety and operating instructions for the IC-A22 and IC-A22E.

EXPLICIT DEFINITIONS

WORD	DEFINITION
CAUTION	Equipment damage may occur.
NOTE	If disregarded, inconvenience only. No risk of personal injury, fire or electric shock.

CAUTIONS

12 V ONLY! NEVER connect the transceiver to a 24 V socket or to an AC outlet. More than 15 V DC will damage the transceiver.

NEVER connect the transceiver to a power source using reverse polarity. This connection will ruin the transceiver.

NEVER allow children to touch the transceiver.

AVOID using or placing the transceiver in direct sunlight or in areas with temperatures below -10°C ($+14^{\circ}\text{F}$) or above $+50^{\circ}\text{C}$ ($+122^{\circ}\text{F}$).

BE CAREFUL! When transmitting for a long time, the rear panel will become hot.

BE CAREFUL! The use of non-Icom battery packs and chargers may impair transceiver performance and invalidate the warranty.

UNPLUG the external DC plug immediately when "OVER V" is displayed as shown at right, indicating more than approx. 18 V DC is connected.

OVER V

TABLE OF CONTENTS

IMPORTANT i
 EXPLICIT DEFINITIONS i
 CAUTIONS i
 TABLE OF CONTENTS ii
 UNPACKING ii

1 PANEL DESCRIPTION 1-6

- Front and side panels 1
- Top panel 2
- Keypad 3
- Function display 5

2 PRE-OPERATION 7-10

- Battery pack charging 7
- Battery pack precautions 7
- About the battery pack 7
- Charging connections 8
- External power source connection 9
- Alkaline battery installation 9
- Accessory attachment 10

3 BASIC OPERATION 11-13

- Accessing the 121.5 MHz emergency frequency 11
- Setting a frequency 11
- Lock function 12
- Selecting a weather channel 12
- Receiving 13
- Transmitting 13
- Side tone function 13

4 MEMORY OPERATION 14-16

- Memory channel selection 14
- Transferring memory contents 14
- Programming a memory channel 15
- Programming a comment 15
- Clearing memory contents 16

5 SCAN OPERATION 17-18

- Scan types 17
- COM band scan 17
- Memory scan 17
- Weather channel scan 18
- Lockout channels 18

6 VOR NAVIGATION 19-25

- VOR indicators 19
- VOR functions 20
- Flying to a VOR station 21
- Entering a desired course 23
- Crosschecking position 23
- Duplex operation 25

7 TROUBLESHOOTING 26

8 SPECIFICATIONS 27

9 OPTIONS 28

UNPACKING

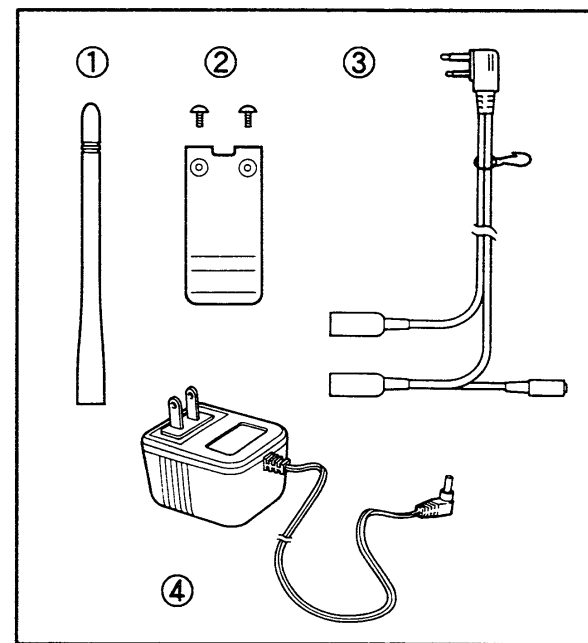

Included accessories:	Qty.
① Antenna (FA-B01AR)	1
② Belt clip and screws	1 set
③ Headset adapter cable (OPC-499)*	1
④ Wall charger*	1
• Ni-Cd battery pack* (CM-166) (attached to the transceiver)	1
• Carrying case (LC-122)*	1
• Charger adapter cable (OPC-507)*	1

* Not included with some versions.

1

PANEL DESCRIPTION

■ Front and side panels

ANL SWITCH [ANL] (p. 13)
Activates the automatic noise limiter function.
• The function reduces pulse noise such as ignition noise.

PTT SWITCH [PTT] (p. 13)
Push and hold to transmit; release to receive.

LIGHT SWITCH [LIGHT] (p. 13)
Turns the display and keypad lighting ON and OFF.

BATTERY PACK RELEASE BUTTON
Opens the latch for battery pack removal when pushed upwards. (p. 9)

SPEAKER AND MICROPHONE

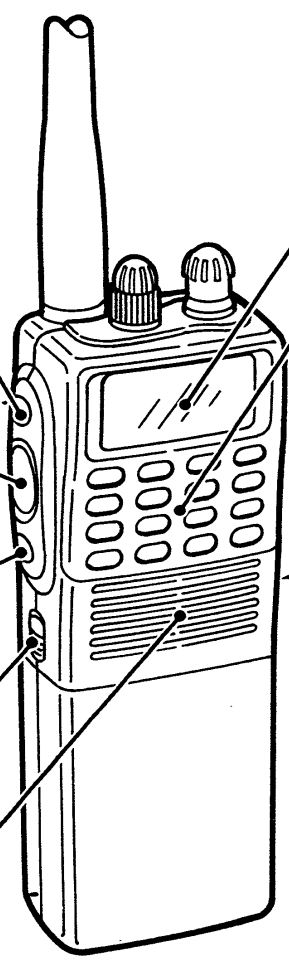

FUNCTION DISPLAY (p. 5)

KEYPAD (p. 3)

EXTERNAL DC POWER JACK [DC 12V] (p. 9)
Allows operation with a 12 V DC power source using the optional cables, CP-17L or OPC-515L.

NOTE: Operation with an external DC power source simultaneously charges the battery pack. This may cause battery overcharging and shorten the life of the battery pack.

CAUTION: When the following indication appears, unplug the connector from this jack. More than approx. 18 V DC has been connected, so the transceiver may need checking at a service center.

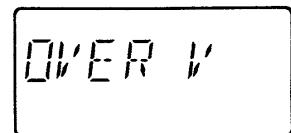

■ Top panel

ANTENNA CONNECTOR (p. 10)
Connects the supplied antenna.

VOLUME CONTROL [VOL] (p. 13)
Turns the power ON and OFF, and adjusts the audio level.

SQUELCH CONTROL [SQL] (p. 13)
Varies the squelch threshold point for noise mute.

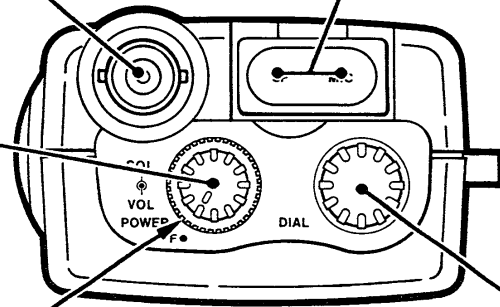

EXTERNAL SPEAKER AND MICROPHONE JACKS [SP]/[MIC]
Connect a headset of the David Clark Co. via the OPC-499, if desired. The transmit voice can be monitored from the headset. The internal speaker will not function when connected. Note that previous headset adapters, the HS-61 and HS-20SB, cannot be used.

TUNING DIAL [DIAL]

- Sets an operating frequency, memory channel, weather channel* or duplex frequency.*
- Sets the 1 MHz digit after pushing [F] in frequency mode.
- Functions as an omni bearing selector (changes course indicator) in CDI mode.

* Weather channel and duplex function: U.S.A. version only.

1 PANEL DESCRIPTION



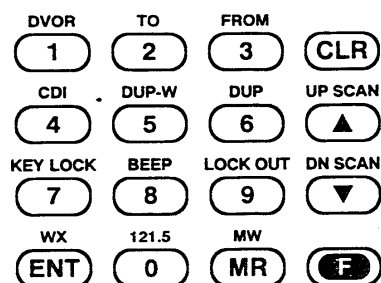



Keypad



KEY	FUNCTION	SECONDARY FUNCTION (After pushing [F])
DVOR 1	- Sets the desired frequency or channel. (pgs. 11, 12, 14) - Selects the desired character for memory channel comments while programming a memory channel. (p. 15) - Inputs the degrees of the desired course in CDI mode. (p. 21)	Selects the DVOR display from the CDI display in NAV band. (p. 19)
TO 2		- Changes the course indicator characteristics to "TO" flag in the DVOR display in NAV band. (p. 19) - Corrects the deviation while using "TO" flag. (p. 23)
FROM 3		- Changes the course indicator characteristics to "FROM" flag in the DVOR display in NAV band. (p. 19) - Corrects the deviation while using "FROM" flag. (p. 23)
CDI 4		Selects the CDI display from the DVOR display in NAV band. (p. 19)
DUP-W 5		Sets the duplex frequency* in NAV band. (p. 25)
DUP 6		Turns the duplex function* ON and OFF in NAV band. (p. 25)
KEY LOCK 7		Turns the lock function ON and OFF. (p. 12)
BEEP 8		Turns the beep tone ON and OFF. (p. 13)
LOCK OUT 9		Sets the displayed memory or weather* channel as a lockout channel. (p. 18)
121.5 0		Selects the 121.5 MHz emergency frequency. (p. 11)

PANEL DESCRIPTION 1

ENGLISH

KEY	FUNCTION	SECONDARY FUNCTION (After pushing [F])
	<ul style="list-style-type: none"> - Clears the input digit before entry. (p. 11) - Exits the memory channel, weather channel* or the emergency frequency. (pgs. 11, 12, 14) - Stops scanning. (p. 17) - Clears [F] key input. 	Clears a memory channel's contents when pushed and held. (p. 16)
 	<ul style="list-style-type: none"> - Changes the frequency or memory channel when pushed. (pgs. 11, 14) - Changes the frequency or memory channel continuously when pushed and held. (pgs. 11, 14) - Changes the scan direction. (p. 17) 	Starts the full scan, memory scan or weather channel* scan. (p. 17)
	Activates the secondary functions of keys and the tuning dial. The function is automatically cancelled after 3 sec.	
	<ul style="list-style-type: none"> - Selects memory mode. (p. 14) - Changes between the memory channel comments and frequency display. (p. 14) 	<ul style="list-style-type: none"> - Programs a memory channel in frequency mode. (p. 15) - Transfers a memory channel's contents into the frequency mode in memory mode. (p. 14)
	Enters numeral input. Enters consecutive zero digits. (p. 11)	Selects a weather channel.* (p. 12)

* Weather channel and duplex function: U.S.A. version only.

1 PANEL DESCRIPTION

■ Function display

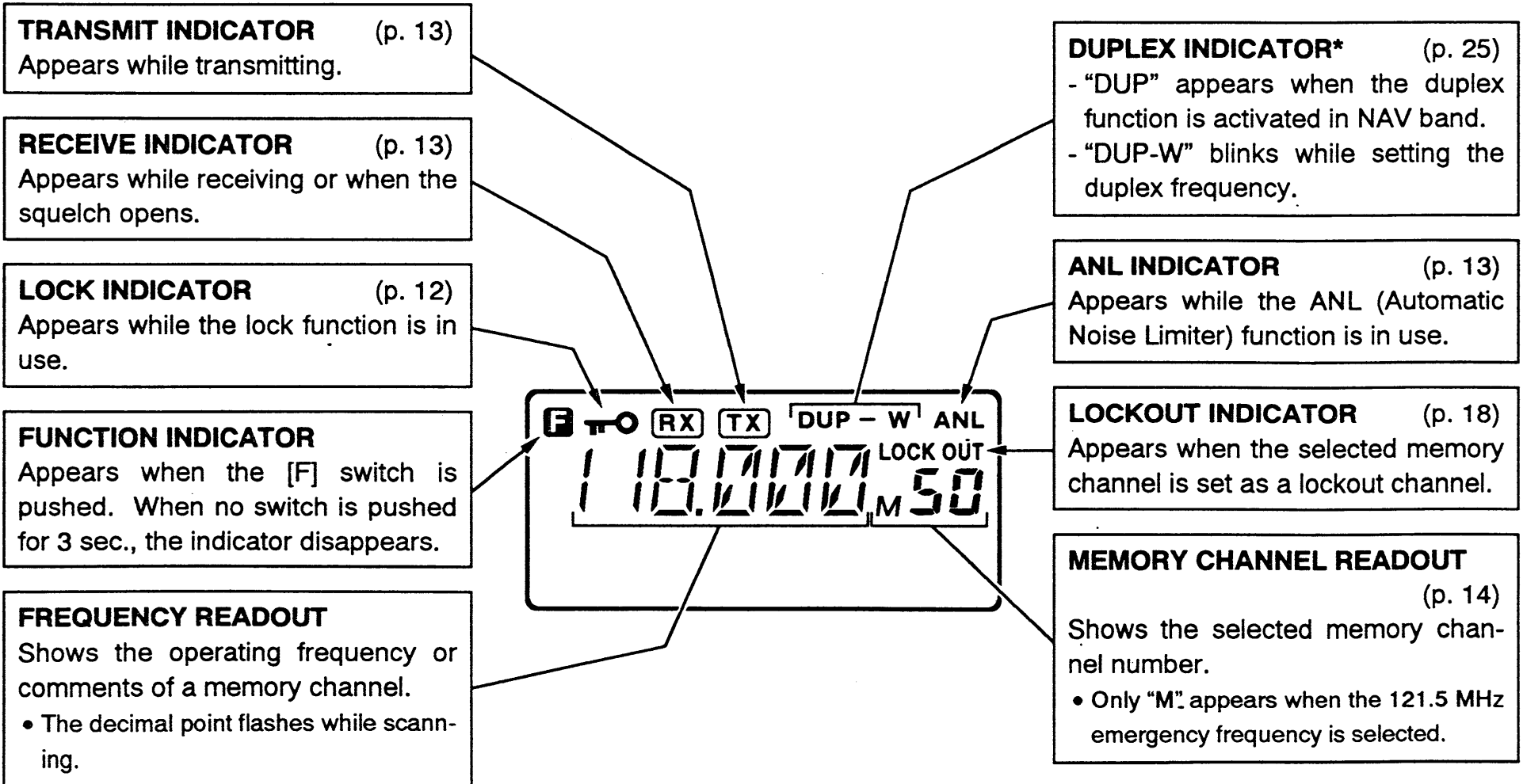

* Duplex function: U.S.A. version only.

COURSE INDICATOR

(pgs. 21, 23)

- Indicates where your aircraft is located on a VOR radial in DVOR mode.
- Indicates where your desired course is located on a VOR radial in CDI mode.

TO-FROM FLAG INDICATORS

(pgs. 21, 23)

Indicate whether the VOR navigation information is based on a course leading to the VOR station or leading away from the VOR station.

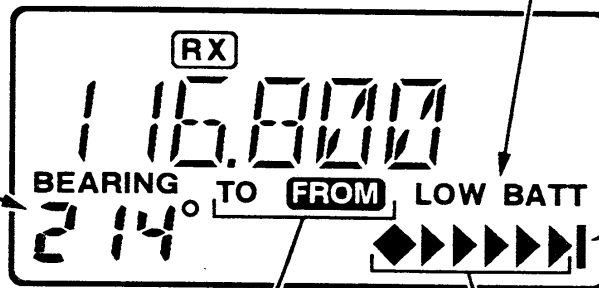

LOW BATTERY INDICATOR (p. 7)

Appears when the battery voltage drops to 10 V DC or below. The attached battery pack requires recharging or the alkaline batteries need replacing.

OVERFLOW INDICATOR

(pgs. 21, 23)

Appears when the deviation between the desired course and flying course is over 10 degrees.

COURSE DEVIATION NEEDLES

(pgs. 21, 23)

Indicates the deviation between the desired course and your actual flying course every 2 degrees.

■ Battery pack charging

Charge the battery pack before first operating the transceiver and when the low battery indicator appears.

■ Battery pack precautions

NEVER throw a battery pack into a fire.

NEVER expose the battery pack to water.

NEVER short the metal terminals of a battery pack.

DO NOT attempt to charge a fully charged battery pack.

DO NOT discharge a battery pack completely.

AVOID overcharging. Disconnect the wall charger or power cable within 48 hrs.

Charging may not occur in extreme cold (under 0°C; + 32°F) or extreme heat (over + 40°C; + 104°F).

■ About the battery pack

◇ Operating period

Operating period of the CM-166 (12 V, 600 mA) is approx. 5 hours.

CONDITION: 5% Tx / 5% Rx / 90% Standby (squelched). The operating period is an estimate and varies depending on temperature, etc.

◇ Battery memory effect

Full charge capacity may become lower when repeatedly recharging after only partial discharging. If this occurs, discharge almost completely through normal use before recharging.

◇ Battery pack life

When the operating period becomes extremely short even after charging the battery pack fully, a new battery pack is needed.

◇ Recycling information (U.S.A. only)



The product that you have purchased contains a rechargeable battery. The battery is recyclable. At the end of its useful life, under various state and local laws, it may be illegal to dispose of this battery into the municipal waste stream. Check with your dealer or local solid waste officials for details in your area for recycling options or proper disposal.

■ Charging connections

◇ Regular charging without transceiver

Connect the wall charger to the charger jack on the side panel of the CM-166. Some versions require an adapter cable for connection.

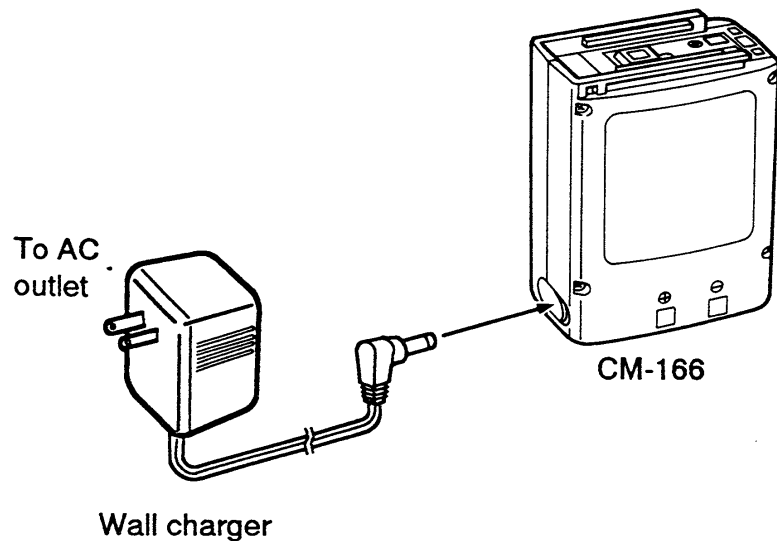

Approx. charging period: 15 hrs.

While connecting the wall charger, **DO NOT** connect any cables to the transceiver's [DC 12V] jack.

◇ Rapid charging with the optional BC-79

- ① Insert the optional AD-50 DESKTOP CHARGER ADAPTER into the charging slot of the BC-79 DESKTOP CHARGER.
- ② Firmly insert a battery pack into the AD-50.

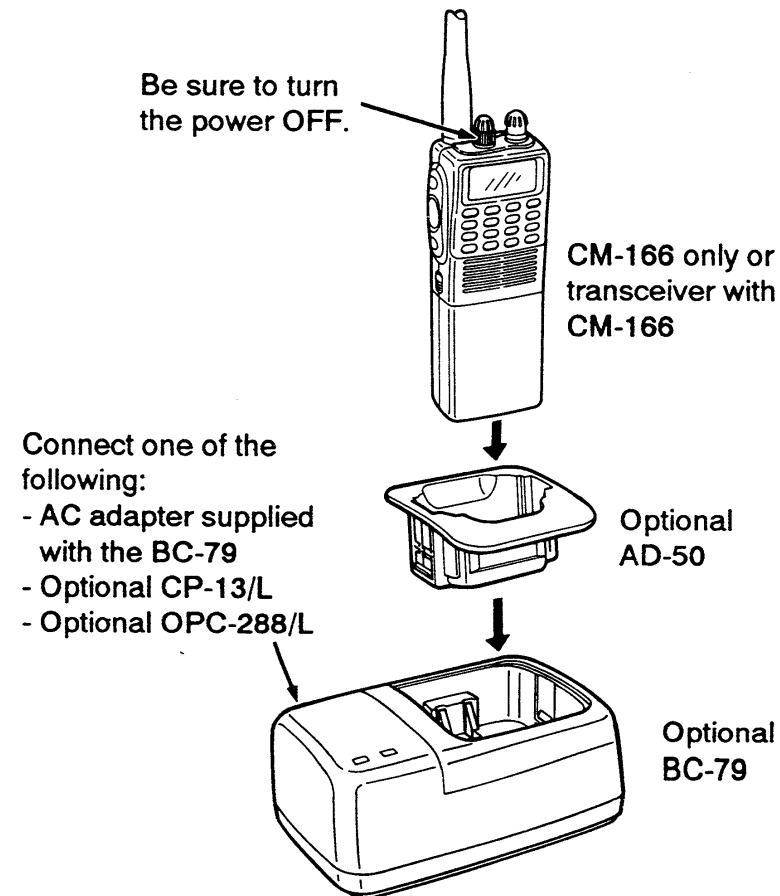

Approx. charging period: 1.5 hrs.

2 PRE-OPERATION

External power source connection

An optional CP-17L CIGARETTE LIGHTER CABLE is available to operate the IC-A22 with a 12 V cigarette lighter socket.

The attached Ni-Cd battery pack is charged in approx. 15 hrs. simultaneously. While connecting an external power source, **DO NOT** connect the wall charger to the CM-166.

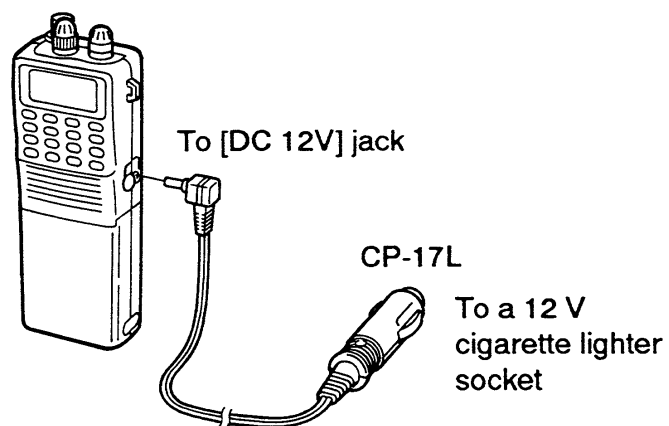

The OPC-515L DC POWER CABLE with a 12 V DC power supply can be used instead of the CP-17L.

Alkaline battery installation

An optional CM-167 BATTERY CASE is available. Install ten alkaline batteries as follows.

- ① Push and hold the battery release button upwards, then slide the battery case to the right with the transceiver facing you. (Fig. 1)
- ② Open the battery case. (Fig. 2)
- ③ Install 10 alkaline batteries. (Fig. 3)
 - Pay attention to the polarities.

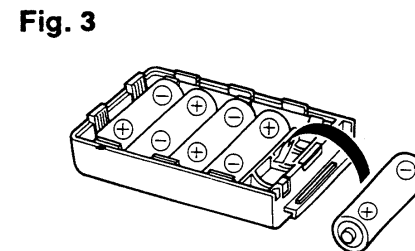
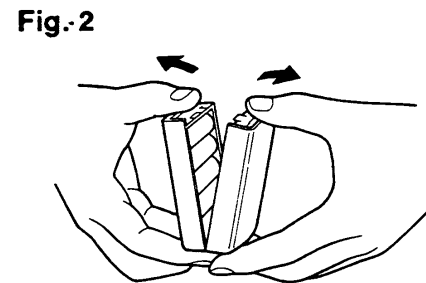
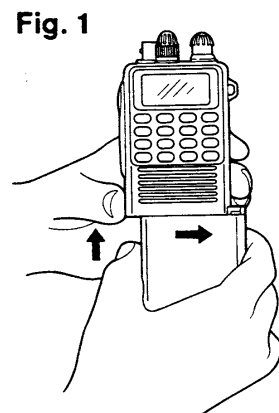

Accessory attachment

Antenna

Connect the supplied flexible antenna into the antenna connector and rotate clockwise.

NOTE: Use an external VOR antenna when using the VOR functions. When receiving a VOR signal with the supplied antenna, the indication will be unstable because it is designed for communications only.

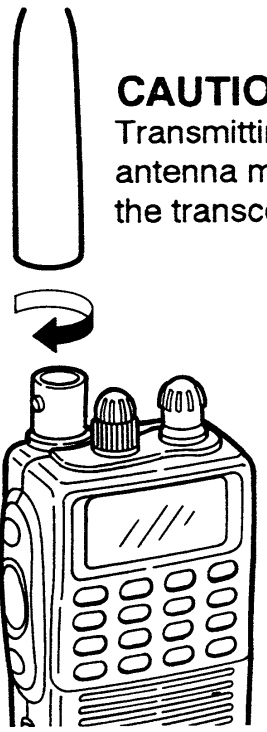

CAUTION:
Transmitting without the antenna may damage the transceiver.

Belt clip

Remove the plastic screws, then attach the belt clip with the supplied metal screws. Conveniently attaches to your belt.

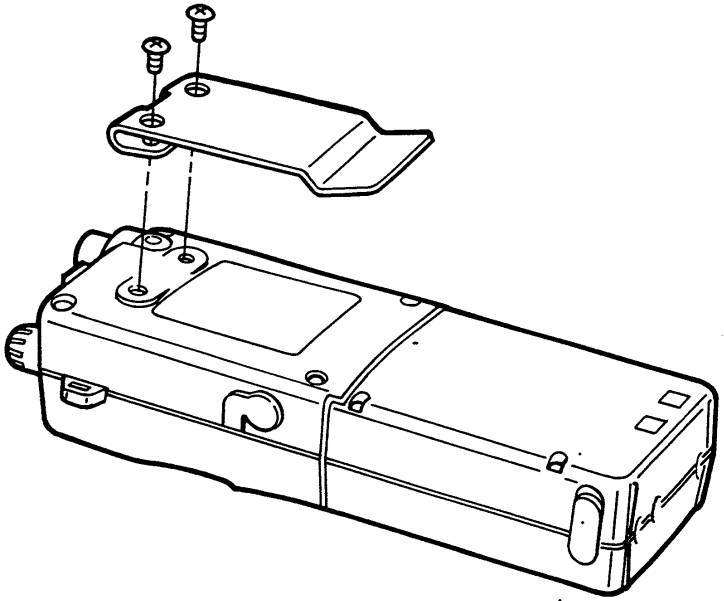

ENGLISH

3

BASIC OPERATION

■ Accessing the 121.5 MHz emergency frequency

The IC-A22 can quickly access the 121.50 MHz emergency frequency. This function can be activated even when the keypad lock function is in use. (p. 12)

- ① Rotate [VOL] to turn power ON.
- ② Push [F] on the keypad.
 - “**F**” appears.
- ③ Push [Ⓜ121.5] to call the emergency frequency.
- ④ Push [CLR] to exit from the emergency frequency.

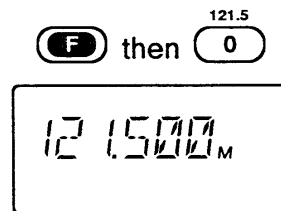

■ Setting a frequency

◇ Using the keypad

- ① Rotate [VOL] to turn power ON.
- ② Push [CLR] to select frequency mode when “M” or “WX” appears in the function display.
- ③ Push 5 appropriate digit keys to input the frequency.
 - Enter [1] as the 1st digit.
 - When a digit is mistakenly input, push [CLR] to clear the input, then start again.
 - Push [ENT] to enter consecutive zero digits.
 - Only [2], [5], [7] or [0] can be entered as the 5th and final digit.
- ④ To change the frequency according to the tuning step (25 kHz step), push [▲] or [▼].
 - Push and hold [▲] or [▼] to change the frequency quickly.

EXAMPLE: Setting the frequency to 120.000 MHz using the keypad.

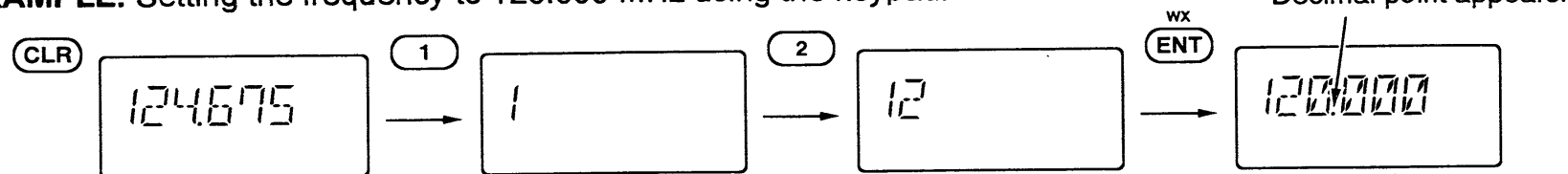

EXAMPLE: Setting frequency to 136.425 MHz using the keypad.

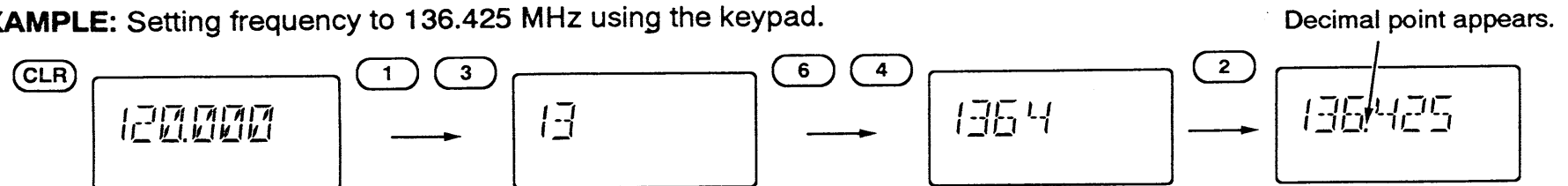

◆ Using the tuning dial

- ① Rotate [VOL] to turn power ON.
- ② Push [CLR] to select frequency mode.
- ③ Rotate the tuning dial to set the desired frequency.
- ④ To select the 1 MHz tuning step, push [F] then rotate the tuning dial.

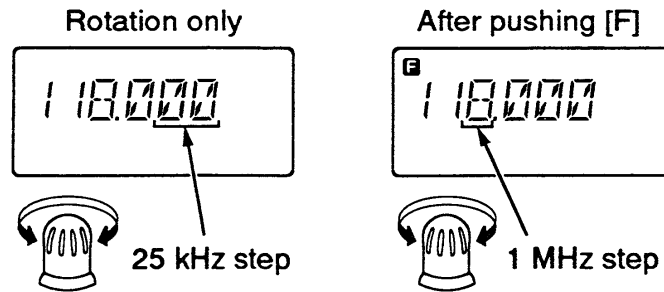

NOTE: The selected frequency may take up to 2 sec. to be backed up after they are set. Wait 2 sec. before turning power OFF.

■ Lock function

The lock function prevents accidental frequency changes and accidental function activation.

- ① Push [F] then [⑦KEY LOCK] to turn the function ON.
- ② To turn the function OFF, repeat step ① above.
 - “” disappears.

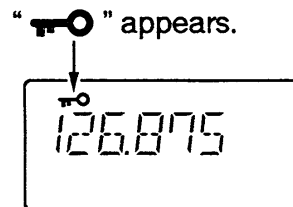

■ Selecting a weather channel (U.S.A. version only)

The U.S.A. version has VHF marine weather channel receiving capability for flight planning.

- ① Push [F] on the keypad.
 - “” appears.
- ② Push [ENT·WX] to select weather channel mode.
 - “WX-” and previously selected channel number appears.
- ③ Rotate the tuning dial to set the desired channel.
 - The [] or [] key can be used.
 - To select weather channels 1–9 directly, push [1]–[9] then [ENT], or push [0] then [1]–[9].
 - To select weather channel 10 directly, push [1] then [0].
- ④ Push [CLR] or [MR] to exit weather channel mode and return to frequency or memory mode.

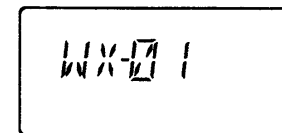

3 BASIC OPERATION

■ Receiving

- ① Rotate [SQL] maximum clockwise.
- ② Rotate [VOL] to turn power ON and adjust the audio level.
- ③ Rotate [SQL] counterclockwise until noise is muted.
 - “RX” disappears.
- ④ Set the desired frequency using the tuning dial or keypad. (pgs. 11, 12)
 - Push [LIGHT] to turn the display and keypad lighting ON, if desired.
- ⑤ Push [ANL] to reduce pulse noise such as caused by engine ignition systems, if necessary.
 - “ANL” appears.
- ⑥ When a signal is received on the set frequency:
 - The receive indicator appears.
 - Squelch opens and audio is emitted from the speaker.

▨ When the [SQL] control is set too “tight” (extremely counterclockwise), squelch may not open for weak signals. To receive weak signals, set the squelch to a “loose” (more clockwise) position.

◇ Beep tone on/off

The beep tone which sounds each time a switch is pushed can be turned ON or OFF, as desired.

- Push [F] then [Ⓢ BEEP] to turn the beep tone ON or OFF.

■ Transmitting

CAUTION: Transmitting without an antenna may damage the transceiver.

NOTE: To prevent interference, listen on the frequency before transmitting. If the frequency is busy, wait until the channel is clear.

- ① Set the desired frequency in COM band using the tuning dial or keypad. (pgs. 11, 12)
 - COM band frequency range: 118.00–136.975 MHz
- ② Push and hold [PTT] to transmit.
 - “TX” appears.
- ③ Speak into the microphone at a normal voice level.
 - **DO NOT** hold the transceiver too close to your mouth or speak too loudly. This may distort the signal.
- ④ Release [PTT] to return to receive.

■ Side tone function

When using an optional headset from the David Clark Co. via the OPC-499, the transceiver outputs your transmitted voice to the headset for monitoring.

Memory channel selection

The transceiver has 50 memory channels for storage of often-used frequencies along with 6-character notes.

- ① Push [MR] to select memory mode.
- ② Select the desired memory channel.

Using the tuning dial:

Rotate the tuning dial to select the desired memory channel.

- Only programmed memory channels appear.

Using the keypad:

Push 2 appropriate digit keys (01–50) to select the desired memory channel.

- To select memory channels 1–9, push [1]–[9] then [ENT]; or, push [0] then [1]–[9].

Using the ▲/▼ keys:

Push [▲] or [▼] to change the memory channel.

- Pushing [▲] or [▼] changes the memory channel continuously.

- ③ When a comment appears, push [MR] to display the programmed frequency, if desired.
- ④ To return to frequency mode, push [CLR].

Comments appear first when programmed, however, the transceiver can be programmed to show the operating frequency first by your dealer. Push [MR] to display the comment in this case.

Transferring memory contents

This function transfers a memory channel's contents into the frequency mode. This is useful when searching for signals around a memory channel's frequency.

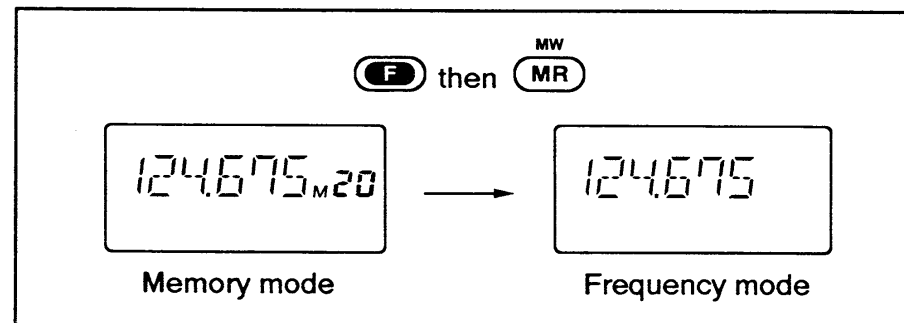

- ① Push [MR] to select memory mode.
 - "M" appears.
- ② Select the desired memory channel to be transferred using the tuning dial or keypad.
- ③ Push [F] then [MR•MW].
 - "M" disappears as frequency mode is automatically selected and the memory contents are transferred.

4 MEMORY OPERATION

■ Programming a memory channel

You can program the following data into each memory channel separately.

- Operating frequency (pgs. 11, 12)
- 6 digit comment (p. 15)
- Lockout and duplex* information (pgs. 18, 25)

- ① Set the desired frequency in frequency mode:
 - Push [CLR] to select frequency mode; or, push [F] then [ENT•WX] to select a weather channel.*
 - Set the desired frequency or weather channel* using the tuning dial or keypad.
- ② Push [F] then [MR•MW].
 - "M" blinks.
- ③ Select the memory channel (01–50) to be programmed using the tuning dial or keypad.
- ④ Push [MR] to enter the frequency and to write a comment; push [ENT] to program the frequency and to skip writing a comment.
 - Push [ENT] to program a weather channel.* A comment cannot be programmed with a weather channel.
 - Push [CLR] to cancel programming.
- ⑤ Set a desired comment as described at right.
- ⑥ Push [ENT] to program.

* Weather channel and duplex function: U.S.A. version only.

■ Programming a comment

The memory channel can display a 6-character comment as well as a frequency.

- ① Set the desired frequency in frequency mode.
- ② Push [F] then [MR•MW].
- ③ Select the memory channel to be programmed.
- ④ Push [MR] to enter the frequency.
- ⑤ Push the appropriate digit key several times to select the desired character as listed below.

Key	Character	Key	Character	Key	Character
1	1, Q, Z	2	2, A, B, C	3	3, D, E, F
4	4, G, H, I	5	5, J, K, L	6	6, M, N, O
7	7, P, R, S	8	8, T, U, V	9	9, W, X, Y
ENT	Program	0	0, Space	MR	Hyphen* ¹

*¹ Hyphen is selectable between the 3rd and 4th digits only.

- ⑥ Push [ENT] to program.

PROGRAMMING NOTES

- Pushing [▲] or [▼] moves the cursor.
- To input characters in the same group, use [▲] to move the cursor.
- To clear the entered comment, push [CLR] before pushing [ENT].

EXAMPLE: Programming 125.000 MHz into memory channel 15 with "AIR-22" as a comment.

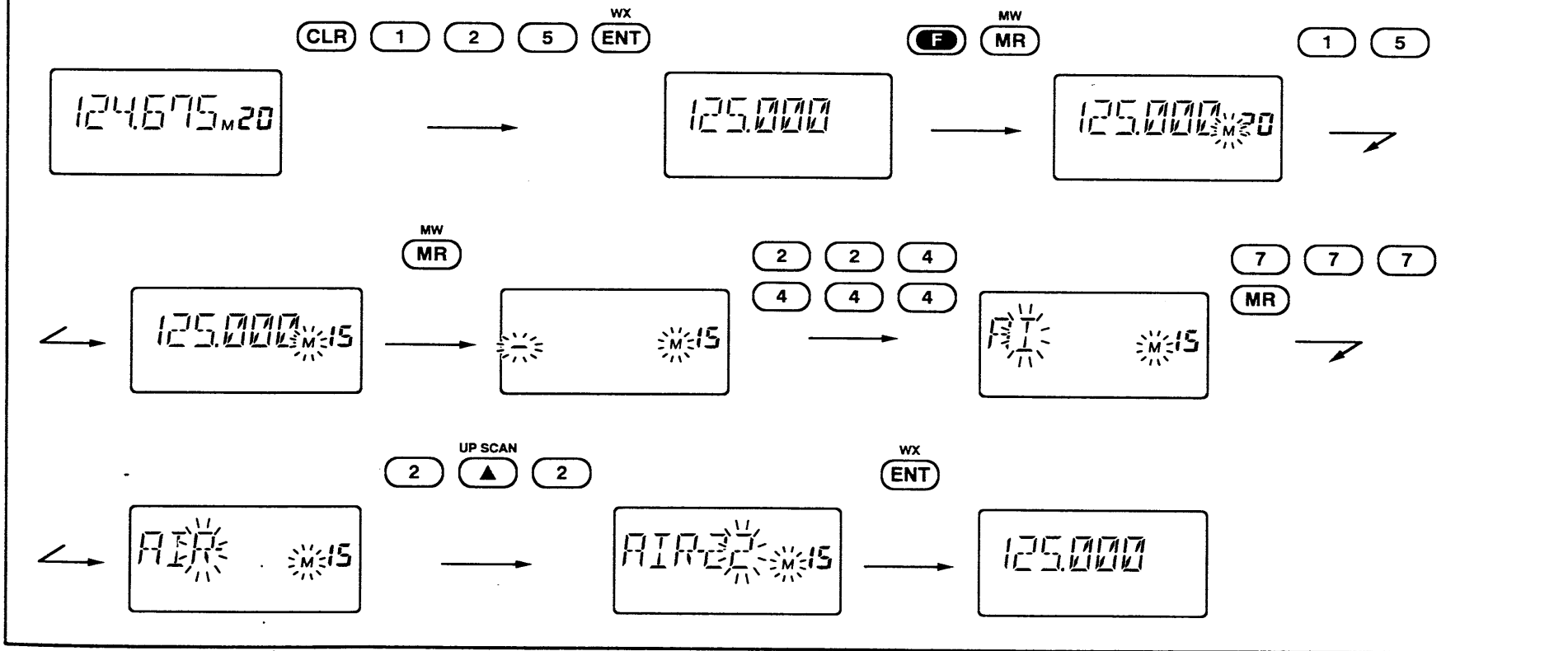

■ Clearing memory contents

Unwanted memory channels can be cleared. Programming over a memory channel also clears the previously programmed contents. Memory channel 1 cannot be cleared.

- ① Select a memory channel to be cleared.
- ② Push [F] then push and hold [CLR] for 1 sec.
 - “-----” appears momentarily, then the next selectable memory channel appears.

5

SCAN OPERATION

Scan types

The U.S.A. version has 3 scan types to suit your needs. The non-U.S.A. versions have 2 scan types.

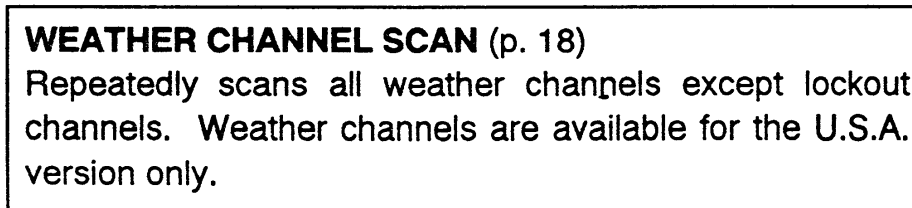
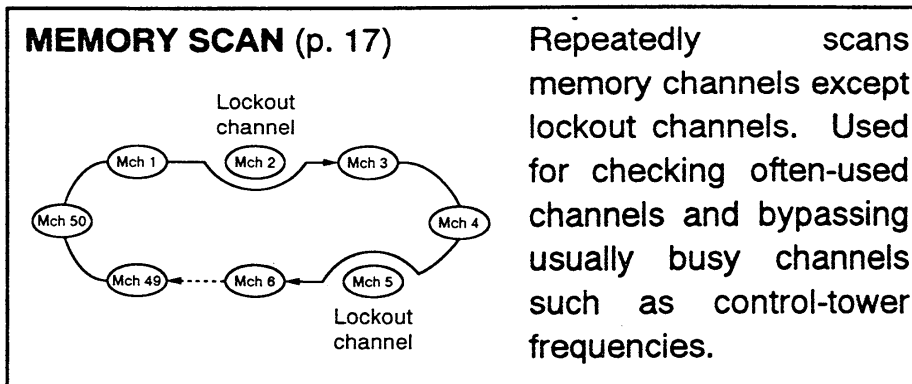
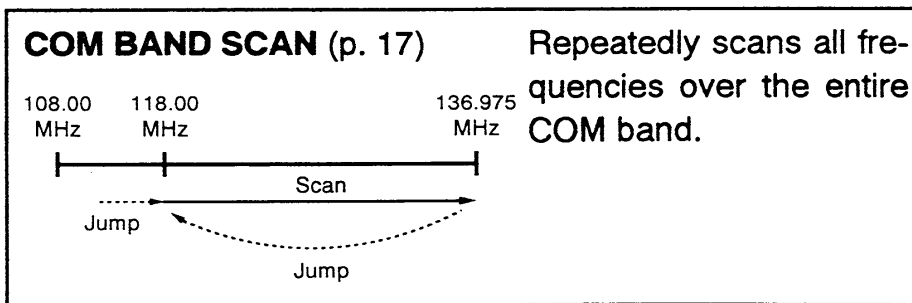

COM band scan

- ① Push [CLR] to select frequency mode.
- ② Set [SQL] to the point where noise is just muted.
- ③ Push [F] then [▲•UP SCAN] or [▼•DN SCAN] to start the scan.
 - When a signal is received, the scan pauses until it disappears. To resume the scan, rotate the tuning dial or push the [▲] or [▼] key.
 - To change the scanning direction, rotate the tuning dial or push the [▲] or [▼] key.
- ④ To stop the scan, push [CLR].

Memory scan

- ① Push [MR] to select memory mode.
- ② Set [SQL] to the point where noise is just muted.
- ③ Push [F] then [▲•UP SCAN] or [▼•DN SCAN] to start the scan.
 - When a signal is received, the scan pauses until it disappears. To resume the scan, rotate the tuning dial or push the [▲] or [▼] key.
 - To change the scanning direction, rotate the tuning dial or push the [▲] or [▼] key.
- ④ To stop the scan, push [CLR].

Weather channel scan

(U.S.A. version only)

- ① Push [F] then [ENT•WX] to select a weather channel.
- ② Set [SQL] to the point where noise is just muted.
- ③ Push [F] then [▲•UP SCAN] or [▼•DN SCAN] to start the scan.
 - When a signal is received, the scan pauses until it disappears. To resume the scan, rotate the tuning dial or push the [▲] or [▼] key.
 - To change the scanning direction, rotate the tuning dial or push the [▲] or [▼] key.
- ④ To stop the scan, push [CLR].

NOTE: A paused frequency or channel is not backed up automatically. Push [CLR] to stop the scan then wait 2 sec. before turning power OFF, otherwise, the previous frequency or channel appears when turning power ON again.

Lockout channels

Memory and weather* channels can be specified to be skipped for the memory and weather* channel scans, respectively. The lockout channel function is only available during scan operation.

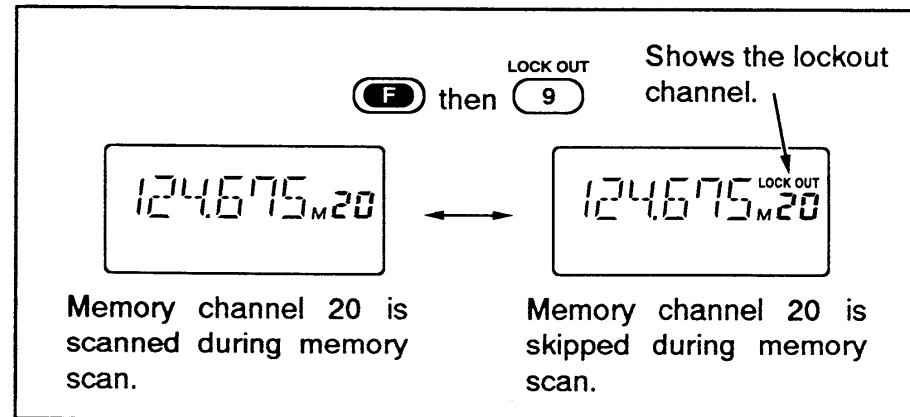

- ① Push [MR] to select memory mode; or, push [F] then [ENT•WX] to select a weather channel.*
- ② Select the desired channel to be locked out.
- ③ Push [F] then [9 LOCK OUT].
 - "LOCK OUT" appears.
 - Lockout channels are skipped during scan.
- ④ To cancel the lockout setting, repeat above steps.

* Weather channel: U.S.A. version only.

6

VOR NAVIGATION

VOR indicators

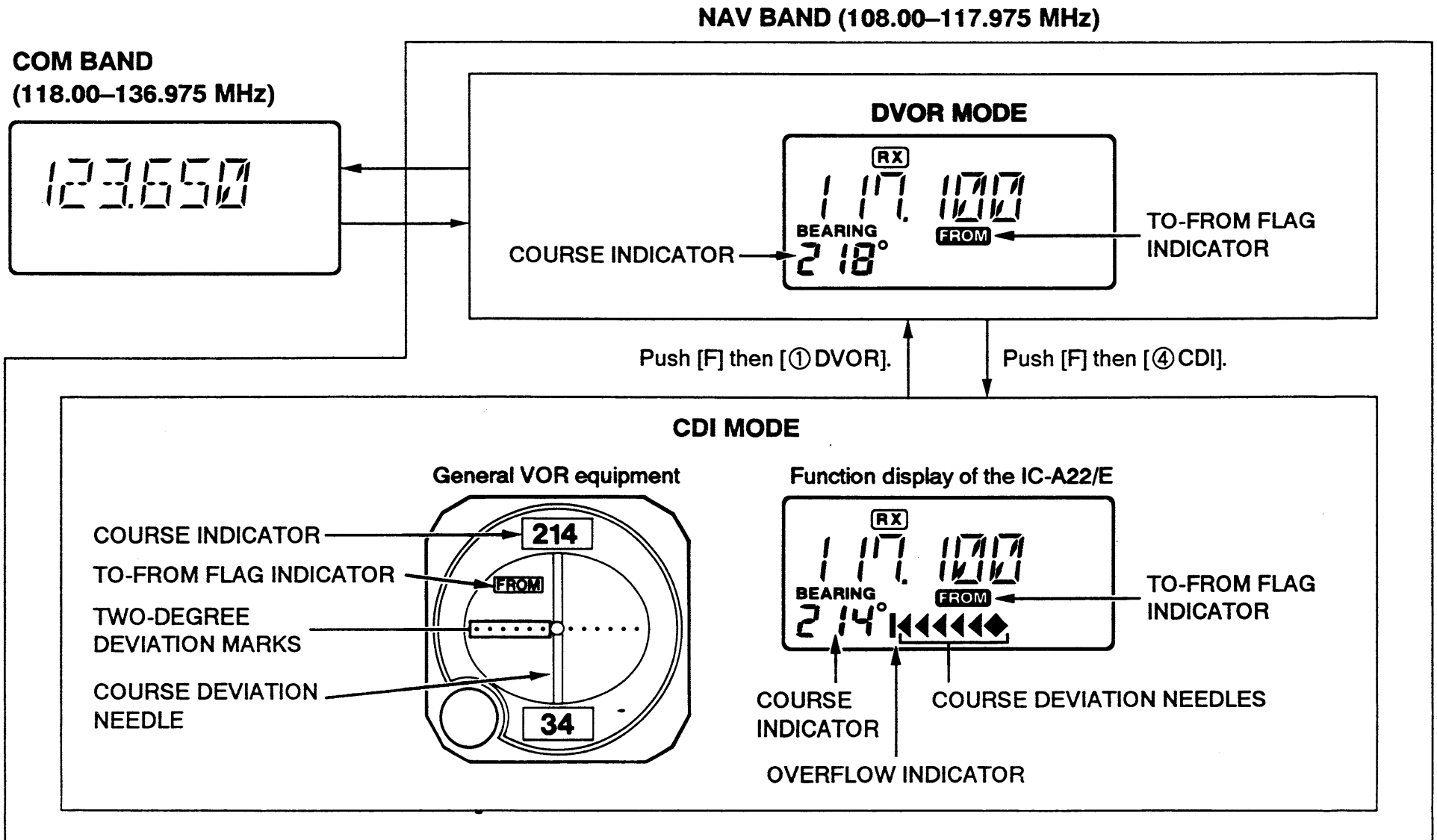

VOR functions

◆ To select CDI mode

To show the deviation between your flying course and the desired course, push [F] then [④ CDI].

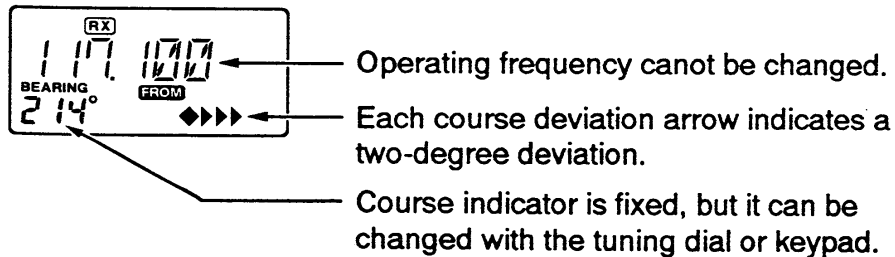

◆ To select DVOR mode

When entering the NAV band, 108.000–117.975 MHz, the IC-A22 selects DVOR mode automatically.

To show your aircraft's direction from (or to) the VOR station, push [F] then [① DVOR].

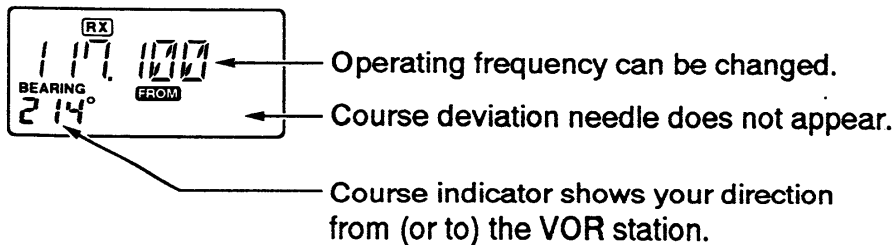

◆ “TO” or “FROM” flag selection

The to-from flag indicators indicate whether the VOR navigation information is based on a course leading to the VOR station or leading away from the VOR station.

To change the flag from “TO” to “FROM” or vice versa, push [F] then [③ FROM] or [② TO], respectively.

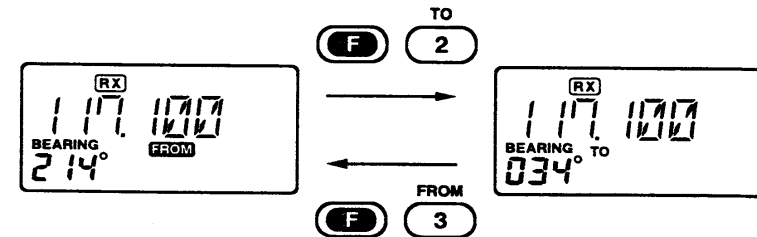

- When using the “TO” flag and passing through the VOR station, the “TO” flag changes to the “FROM” flag automatically.
- When turning power ON, the “FROM” flag is selected automatically.

◆ Selecting the next VOR station when using CDI mode (when using the course deviation needle)

- ① Push [F] then [① DVOR].
- ② Set the next VOR station's frequency.
- ③ Push [F] then [③ CDI].
 - Select “TO” or “FROM” flag, if desired.

6 VOR NAVIGATION

■ Flying to a VOR station

The IC-A22 shows the deviation from a VOR station.

- ① Select a VOR station on your aeronautical chart and set the frequency of the station.
 - The course indicator indicates where you are located on a VOR radial from the VOR station.
 - The course indicator shows “- - -” when either your aircraft is too far away from the VOR station or the frequency is not set correctly at the VOR station.
- ② Select the “TO” flag when flying to the VOR station, or select the “FROM” flag when flying away from the VOR station.
 - To select “TO,” push [F] then [② TO].
 - To select “FROM,” push [F] then [③ FROM].
- ③ Push [F] then [④ CDI] to select CDI (Course Deviation Indicator) mode.
 - The course indicator shows “OFF” when the desired VOR signal cannot be received.

▨ **NOTE:** When CDI mode is selected, the operating frequency cannot be changed. To set the operating frequency, select DVOR mode in advance.

- ④ The course deviation needle appears when your aircraft is off course from the VOR station.
 - “◀” or “▶” appears to indicate your aircraft is off course to the right or left, respectively. Correct your course until “◀” or “▶” disappears. Each arrow represents a two-degree deviation.
- ⑤ To exit CDI mode, push [F] then [① DVOR].

VOR INDICATOR NOTE

“LOC” appears on the function display as shown below when a localizer signal is received.

However, the function display does not indicate additional information about the localizer signal.

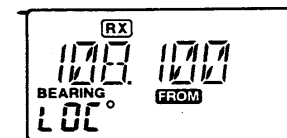

THE AIRCRAFT IS ON COURSE

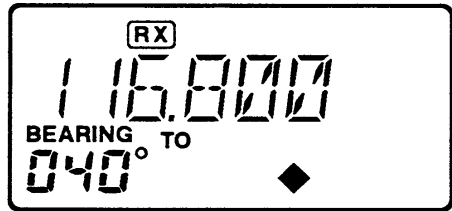

123.65
VORTAC
SEATTLE
116.8 Ch 115 SEA

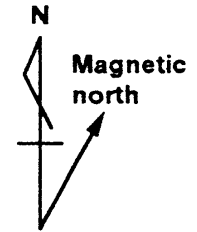
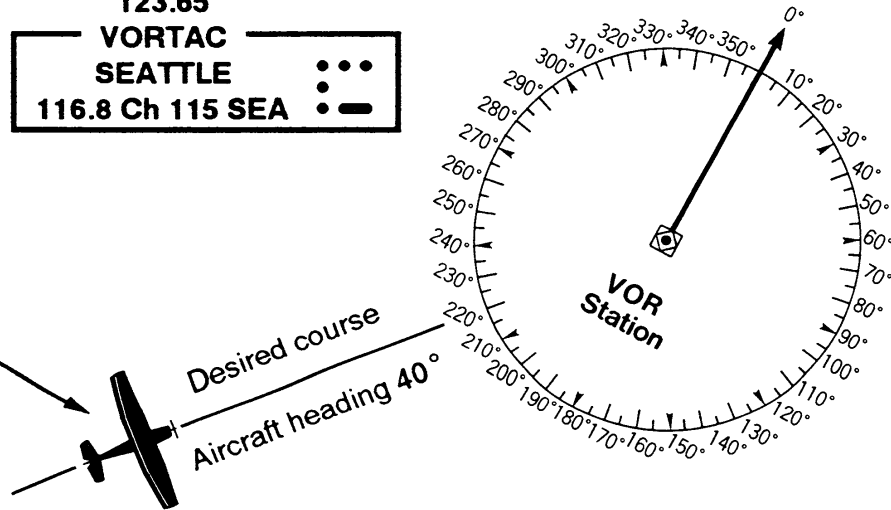

THE AIRCRAFT IS OFF COURSE

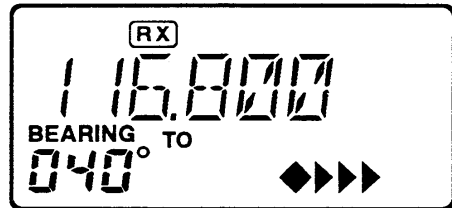

123.65
VORTAC
SEATTLE
116.8 Ch 115 SEA

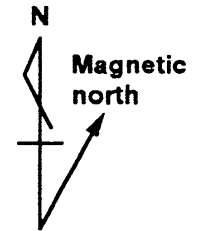
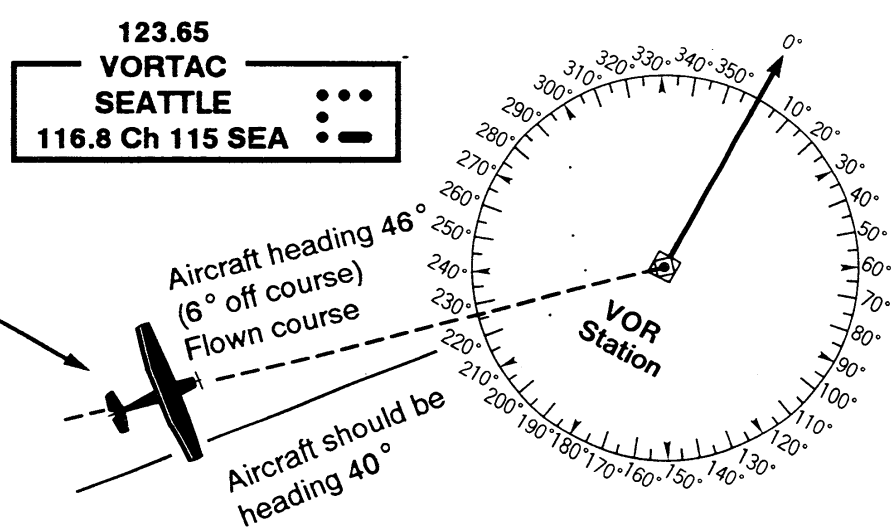

The course deviation indicator appears when the aircraft is off course. In this example, the aircraft is 6 degrees left of course. The pilot must turn more than 6 degrees right to get back on course.

6 VOR NAVIGATION

■ Entering a desired course

The IC-A22 shows not only the deviation from the VOR station but the deviation from the desired course.

- ① Set the frequency for the desired VOR station.
 - To change the to-from flag, push [F] then [②TO] or [③FROM].
- ② Push [F] then [④CDI] to select CDI mode.
- ③ Set the desired course to the VOR station using the tuning dial or keypad.
 - “◀” or “▶” appears on the function display when your aircraft is off the desired course.
 - When your heading is correct, the ABSS function may be useful instead of course input.
- ④ The course deviation needle points to the right when your aircraft is off course to the left.
 - To get back on course, fly right more than the number of degrees indicated by the CDI arrows.
 - If the overflow indicator appears on the right side, select a heading plus 30 degrees to the desired course; if the overflow indicator appears on the left side, select a heading minus 30 degrees.

■ Crosschecking position

- ① Select 2 VOR stations on your aeronautical chart.
- ② Set the frequency of one of the VOR stations in DVOR mode.
 - The course indicator shows course deviation from the VOR radial. Note the radial you are on.
- ③ Set the frequency of the other VOR station in DVOR mode.
 - Note the radial from the station you are on.
- ④ Extend the radials from each VOR station on the chart. Your aircraft is located at the point where the lines intersect.

ABSS FUNCTION

In CDI mode, the Auto Bearing Set System (ABSS) adds or subtracts the number of degrees indicated by the CDI arrows from the Omni Bearing Selector (OBS).

To use ABSS, push [F] then [②TO] while using the TO flag; or, push [F] then [③FROM] while using the FROM flag.

EXAMPLE: Entering the desired course bearing 89° to a VOR station.

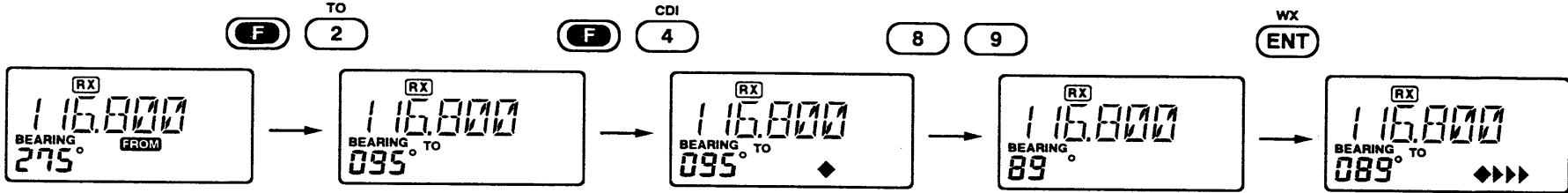

CROSSCHECKING POSITION

VORTAC OLYMPIA 113.4 Ch 81 OLM

123.65 VORTAC SEATTLE 116.8 Ch 115 SEA

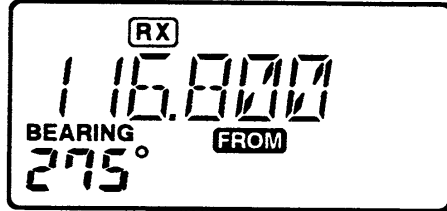
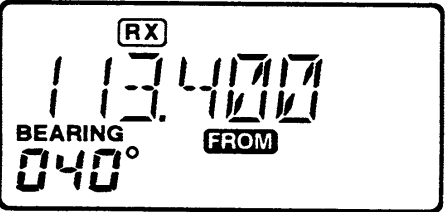
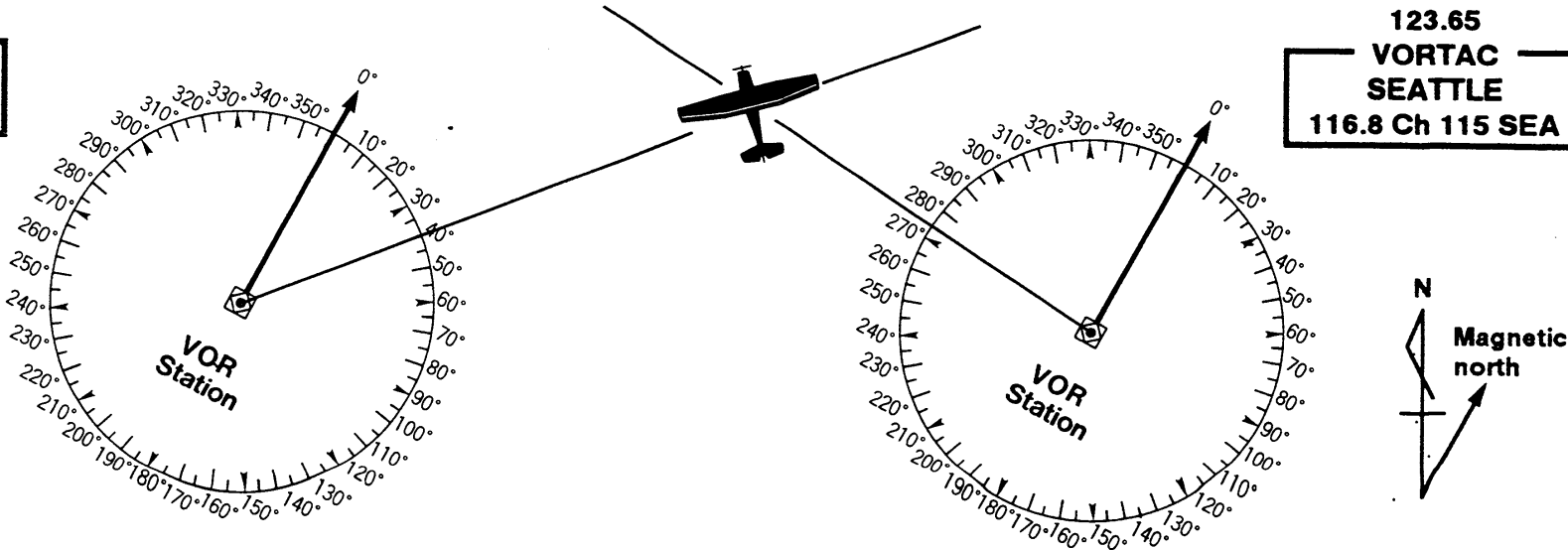

6 VOR NAVIGATION

■ Duplex operation

(U.S.A. version only)

The duplex function allows you to call a flight service station while receiving a VOR station. The duplex function requires frequency programming for the flight service station in advance.

◇ Programming a duplex frequency

- ① Push [CLR] to select frequency mode.
 - NAV band frequency range: 108.00–117.975 MHz.
- ② Set a NAV band frequency using the tuning dial or keypad.
 - NAV band frequency range: 108.00–117.975 MHz.
- ③ Push [F] then [⑤ DUP-W].
 - “DUP-W” blinks and transmit frequency appears.
- ④ Set the frequency of the flight service station using the tuning dial or keypad. When using the tuning dial, push [ENT] after setting a frequency.
 - The displayed frequency returns to the NAV band frequency.

◇ Operating the duplex function

- ① Set the desired frequency in NAV band.
 - NAV band frequency range: 108.00–117.975 MHz.
- ② Push [F] then [⑥ DUP] to turn the duplex function ON.
 - “DUP” appears on the function display.
- ③ Push and hold [PTT] to transmit at the pre-programmed transmit frequency.
- ④ Release [PTT] to return to receive.
- ⑤ Push [F] then [⑥ DUP] to cancel the function.

▨ A duplex frequency can be programmed into each memory channel independently. Set a duplex frequency before programming the memory channel, if desired. The duplex ON/OFF setting can also be programmed into a memory channel.

EXAMPLE: Programming 123.65 MHz as the transmit frequency in the duplex function.

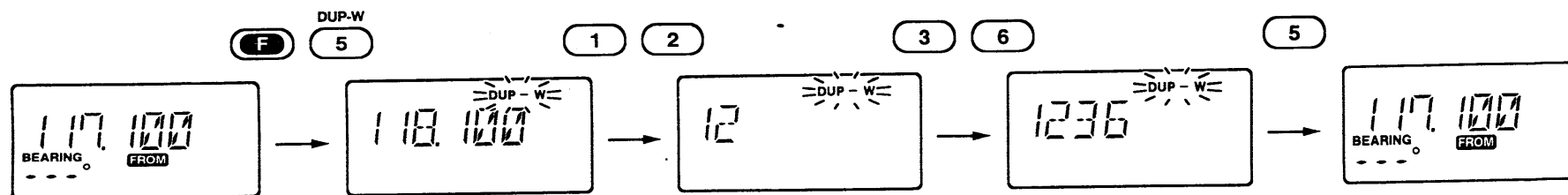

PROBLEM	POSSIBLE CAUSE	SOLUTION	REF.
<ul style="list-style-type: none"> No power comes on. 	<ul style="list-style-type: none"> The battery is exhausted. Poor plug connection to the external DC power cable. 	<ul style="list-style-type: none"> Charge the battery-pack or place new alkaline batteries in the battery case. Check the connector or remove and replace the cable. 	pgs. 8, 9 –
<ul style="list-style-type: none"> No sound comes from the speaker. 	<ul style="list-style-type: none"> [SQL] is turned too far counterclockwise. An optional cable or headset is connected. 	<ul style="list-style-type: none"> Rotate [SQL] clockwise. Unplug the cable or headset. 	p. 13 –
<ul style="list-style-type: none"> Frequency cannot be set. 	<ul style="list-style-type: none"> The lock function is activated. The emergency frequency is selected. CDI mode is selected. 	<ul style="list-style-type: none"> Push [F] then [⑦KEY LOCK] to deactivate the lock function. Push [CLR] to select frequency mode. Push [F] then [①DVOR] to select DVOR mode. 	p. 12 p. 11 p. 19
<ul style="list-style-type: none"> Scan cannot be activated. 	<ul style="list-style-type: none"> The squelch is open. The lock function is activated. 	<ul style="list-style-type: none"> Rotate [SQL] counterclockwise until noise disappears. Push [F] then [⑦KEY LOCK] to deactivate the lock function. 	p. 17 p. 12
<ul style="list-style-type: none"> Frequency is not displayed. 	<ul style="list-style-type: none"> The memory channel comments are displayed. 	<ul style="list-style-type: none"> Push [MR] to toggle between a comment and frequency. 	p. 14
<ul style="list-style-type: none"> Transmitting is impossible. 	<ul style="list-style-type: none"> NAV band frequency is set. Weather channel is selected. (U.S.A. only) 	<ul style="list-style-type: none"> Set the frequency in COM band. Push [CLR] to select frequency mode. 	p. 13 p. 12

◆ Resetting the CPU

CAUTION: Resetting the CPU clears and initializes all programmed contents such as memory contents, lockout channel settings, etc.

- While pushing [F], [0] and [ENT], turn power ON to reset the CPU.

- "CLEAR" appears momentarily, the default frequency appears and the transceiver's CPU is reset.

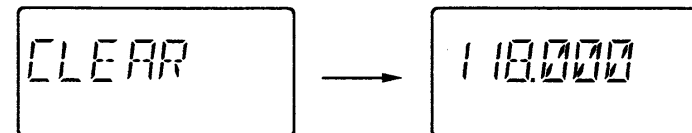

8

SPECIFICATIONS

■ GENERAL

- Frequency coverage :

Transmit	COM band	118.000–136.975 MHz
Receive	NAV band	108.000–117.975 MHz
	COM band	118.000–136.975 MHz
	Weather channel* ¹	ch 01–ch 10

- Mode :
 - Transmit/receive AM (6K00A3E)
 - Receive FM (16K0G3E)*¹
- Antenna impedance : 50 Ω (nominal)
- Power supply : 12–15 V DC
- requirement (negative ground)
- Current drain (at 12 V DC):
 - Transmit 1.0 A typical
 - Rated audio 400 mA max.
 - Squelched 55 mA typical (Standby)
- Usable temperature range: – 10 °C to + 50 °C ;
+ 14 °F to + 122 °F
- Frequency stability : ± 20 ppm (– 10 °C to + 50 °C)
- Dimensions : 57(W) \times 153(H) \times 35(D) mm
(projections not included) 2 1/4(W) \times 6 1/32(H) \times 1 3/8(D) in
- Weight : 465 g; 16.4 oz
(with CM-166 and antenna)

■ TRANSMITTER

- Output power*² : 5.0 W (PEP power)
(at 12 V DC, typical) 1.5 W (Carrier power)

- Modulation system : Low level modulation
- Spurious emissions*² : Less than – 60 dB
- External microphone : 150 Ω
impedance

■ RECEIVER

- Receive system : Double-conversion
superheterodyne
- Intermediate frequencies : 1st 35.8 MHz
2nd 455 kHz
- Sensitivity*² : Less than 1.0 μ V
(for 6 dB S/N with 1 kHz, 30% modulation)
- Tight squelch sensitivity*² : Less than 4.0 μ V
- Selectivity*² : More than 8 kHz/– 6 dB
Less than 25 kHz/– 60 dB
- Spurious response : More than 60 dB
rejection ratio*²
- Noise and hum : More than 25 dB
- Audio output power*² : More than 0.6 W at 10%
(at 12 V DC) distortion with an 8 Ω load.
- Audio output impedance : 8 Ω

*¹ Weather channels and FM mode: U.S.A. version only.

*² Specifications guaranteed at a transceiver temperature of + 25 °C
(+ 77 °F).

All stated specifications are subject to change without notice or obligation.

BM-112U/E WALL CHARGER
(U.S.A./Europe version)

BM-95V WALL CHARGER + OPC-507 JACK ADAPTER (Australia version)
Regularly charges the CM-166 in approx. 15 hrs.

CM-166 Ni-Cd BATTERY PACK
12 V 600 mAh Ni-Cd rechargeable battery pack for approx. 5 hours operation.* Same as supplied with non-U.K. versions.

* 5% Tx/5% Rx/90% Squelched

CM-167 BATTERY CASE
Battery case for R6 (AA) size alkaline batteries × 10.

LC-122 CARRYING CASE
Fits the transceiver with the supplied CM-166.

OPC-499 HEADSET ADAPTER CABLE
Allows you to connect a headset from the David Clark Co. Provides the side tone function. Same as supplied with non-U.K. versions.

OPC-515L DC POWER CABLE
For operation and charging with a 12–15 V DC power supply.

BC-79 DESKTOP CHARGER + AD-50 DESKTOP CHARGER ADAPTER

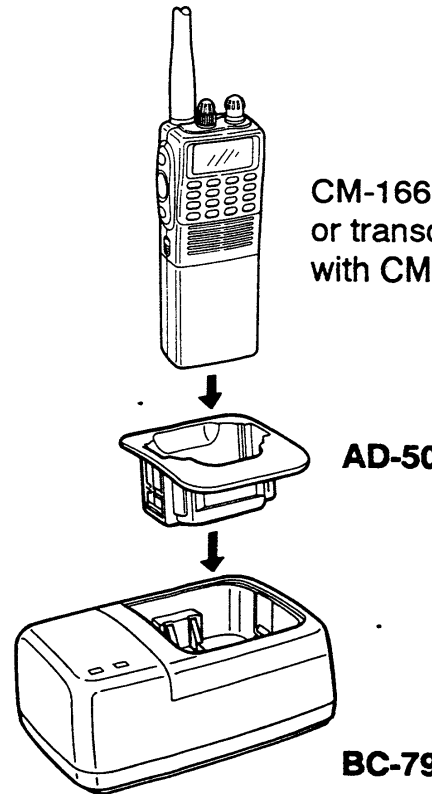

CM-166 only
or transceiver
with CM-166

AD-50

BC-79

Rapidly charges the CM-166 in approx. 1.5 hrs. An AC adapter is packed with the BC-79. An optional CP-13/L or OPC-288/L can be used instead of the supplied AC adapter.

CP-17L CIGARETTE LIGHTER CABLE

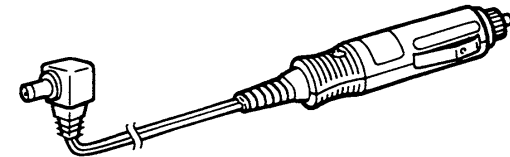

For operation and charging with a 12 V cigarette lighter socket.

Count on us!

