



## INSTRUCTION MANUAL

VHF AIR BAND TRANSCEIVER

# IC-A23

# IC-A5

This device complies with Part 15 of the FCC rules. Operation is subject to the following two conditions: (1) This device may not cause harmful interference, and (2) this device must accept any interference received, including interference that may cause undesired operation.

Icom Inc.

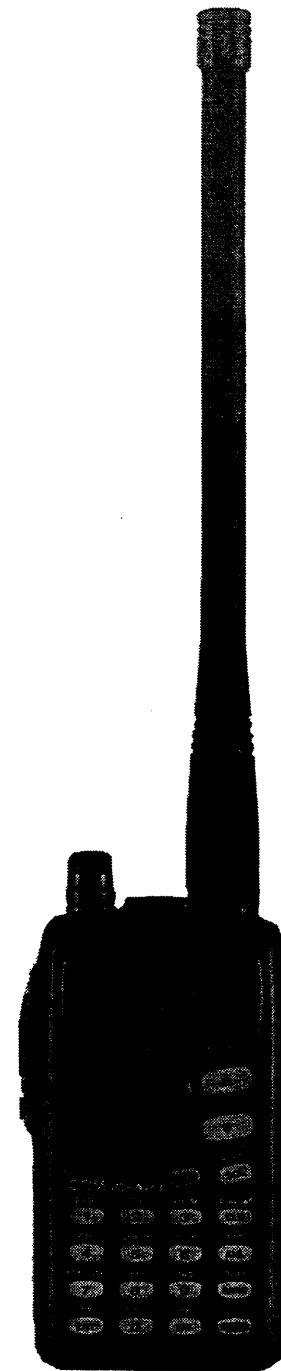

---

## FOREWORD

---

**READ ALL INSTRUCTIONS** carefully and completely before using the transceiver.

**SAVE THIS INSTRUCTION MANUAL**— This instruction manual contains important operating instructions for the IC-A23/A5.

---

## EXPLICIT DEFINITIONS

---

The explicit definitions below apply to this instruction manual.

WORD	DEFINITION
<b>⚠ WARNING</b>	Personal injury, fire hazard or electric shock may occur.
<b>CAUTION</b>	Equipment damage may occur.
<b>NOTE</b>	Inconvenience only. No risk of personal injury, fire or electric shock.

**FCC caution:** Changes or modifications to this transceiver, not expressly approved by Icom Inc., could void your authority to operate this transceiver under FCC regulations. (U.S.A. only)

---

## CAUTION

---

**⚠ WARNING! NEVER** hold the transceiver so that the antenna is very close to, or touching exposed parts of the body, especially the face or eyes, while transmitting. The transceiver will perform best if the microphone is 5 to 10 cm away from the lips and the transceiver is vertical.

**⚠ WARNING! NEVER** operate the transceiver with a headset or other audio accessories at high volume levels. Hearing experts advise against continuous high volume operation. If you experience a ringing in your ears, reduce the volume level or discontinue use.

**NEVER** connect the transceiver to an AC outlet or to a power source of more than 14 V DC. Such a connection will damage the transceiver.

**NEVER** connect the transceiver to a power source that is DC fused at more than 5 A. Accidental reverse connection will be protected by this fuse, higher fuse values will not give any protection against such accidents and the transceiver will be ruined.

**NEVER** short the terminals of the battery pack. Also, current may flow into nearby metal objects, such as a necklace,

etc. Therefore, be careful when carrying with, or placing near metal objects, carrying in handbags, etc.

**DO NOT** allow children to play with any radio equipment containing a transmitter.

**DO NOT** operate the transceiver near unshielded electrical blasting caps or in an explosive atmosphere.

**AVOID** using or placing the transceiver in direct sunlight or in areas with temperatures below  $-10^{\circ}\text{C}$  ( $+14^{\circ}\text{F}$ ) or above  $+60^{\circ}\text{C}$  ( $+140^{\circ}\text{F}$ ).

The use of non-Icom battery packs/chargers may impair transceiver performance and invalidate the warranty.

Even when the transceiver power is OFF, a slight current still flows in the circuits. Remove the battery pack or case from the transceiver when not using it for a long time. Otherwise, the battery pack or installed dry cell batteries will become exhausted.

## SUPPLIED ACCESSORIES

Accessories included with the transceiver:	Qty.
① Antenna .....	1
② Belt clip.....	1
③ Handstrap.....	1
④ Battery pack (BP-200L)*.....	1
⑤ Wall charger* .....	1
• Carrying case (LC-147)* .....	1
• HEADSET ADAPTER (OPC-967)* .....	1

\*The battery pack, wall charger, HEADSET ADAPTER or carrying case may differ depending on version. Some versions do not include a battery pack, wall charger, HEADSET ADAPTER or carrying case.

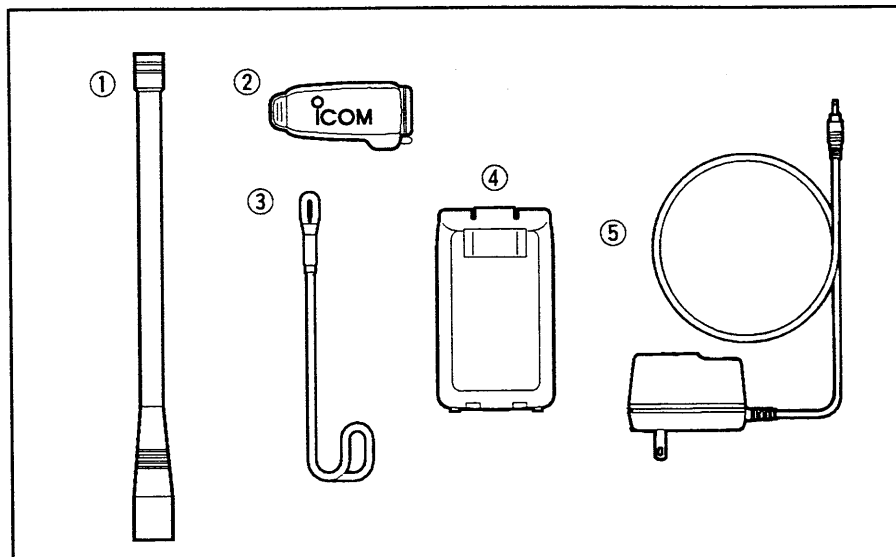

---

# TABLE OF CONTENTS

---

FOREWORD .....	i	5 SCAN OPERATION .....	16–17
EXPLICIT DEFINITIONS .....	i	■ Scan types .....	16
CAUTIONS .....	i	■ COM band scan .....	16
SUPPLIED ACCESSORIES.....	ii	■ Memory scan .....	16
TABLE OF CONTENTS .....	iii	■ Weather channel scan .....	17
<b>1 ACCESSORY ATTACHMENT .....</b>	<b>1</b>	■ “TAG” channels .....	17
<b>2 PANEL DESCRIPTION .....</b>	<b>2–7</b>	<b>6 VOR NAVIGATION (IC-A23 only).....</b>	<b>18–24</b>
■ Panel description .....	2–5	■ VOR indications .....	18
■ Function display .....	6–7	■ VOR functions .....	19
<b>3 BASIC OPERATION .....</b>	<b>8–11</b>	■ Flying to a VOR station .....	20–21
■ DIAL↔[▲]/[▼] trade function .....	8	■ Entering a desired course .....	22
■ Setting a frequency .....	8	■ Crosschecking position .....	22–23
■ Accessing 121.5 MHz emergency frequency .....	8	■ Duplex operation .....	24
■ Selecting a weather channel.....	9	<b>7 BATTERY PACKS .....</b>	<b>25–27</b>
■ Setting a squelch level .....	9	■ Charging precautions .....	25
■ Side tone function .....	9	■ Battery pack charging .....	25–26
■ Beep tone .....	9	■ About the battery pack .....	27
■ Lock function .....	10	■ Battery pack CAUTION .....	27
■ Display backlighting .....	10	<b>8 CLONING .....</b>	<b>28</b>
■ Low battery indicator .....	10	<b>9 TROUBLESHOOTING .....</b>	<b>29</b>
■ REC/PLY of recorded signals/messages .....	10	<b>10 SPECIFICATIONS .....</b>	<b>30</b>
■ Receiving .....	11	<b>11 OPTIONS .....</b>	<b>31–32</b>
■ Transmitting .....	11	(■ OPC-967 connection .....	32)
<b>4 MEMORY OPERATION .....</b>	<b>12–15</b>	<b>12 QUICK REFERENCE .....</b>	<b>33–34</b>
■ Memory channel selection .....	12		
■ Transferring memory contents .....	12		
■ Programming a memory channel .....	13		
■ Memory names .....	14–15		

## ◇ Antenna

**CAUTION:** Transmitting without an antenna may damage the transceiver.

Insert the supplied antenna into the antenna connector and screw down the antenna as shown below.

**Keep** the jack cover attached when jacks are not in use to avoid bad contacts from dust and moisture.

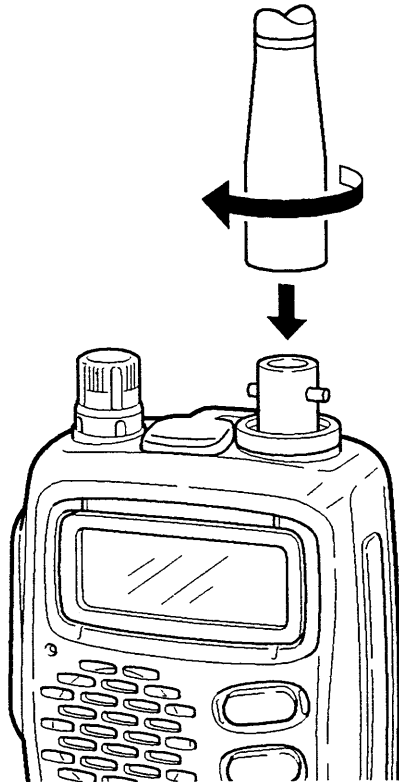

## ◇ Belt clip

Conveniently attaches to your belt.

*To attach:*

Slide the belt clip into the plastic loop on the back of the battery case/pack.

*To remove:*

Push the top of the belt clip towards the transceiver and at the same time, push it downward and free of the plastic loop.

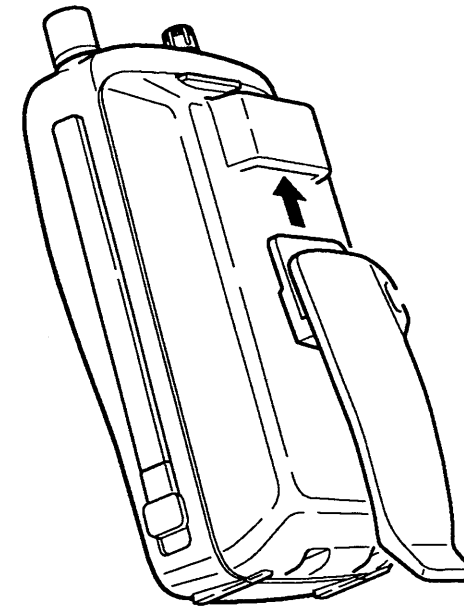

## ■ Panel description

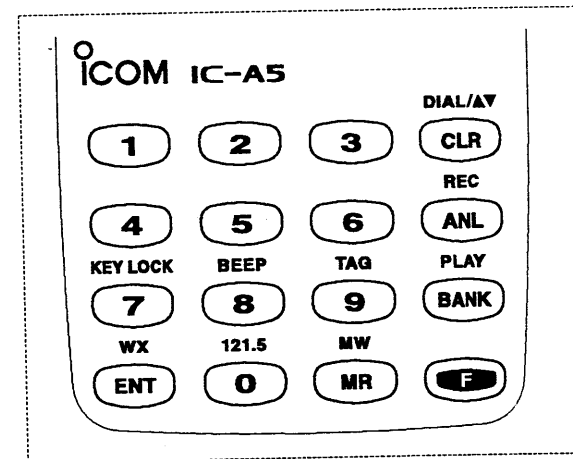
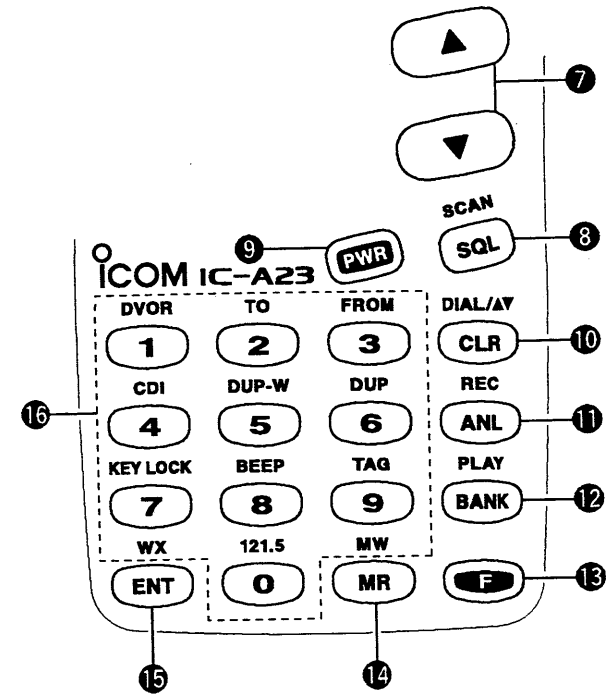
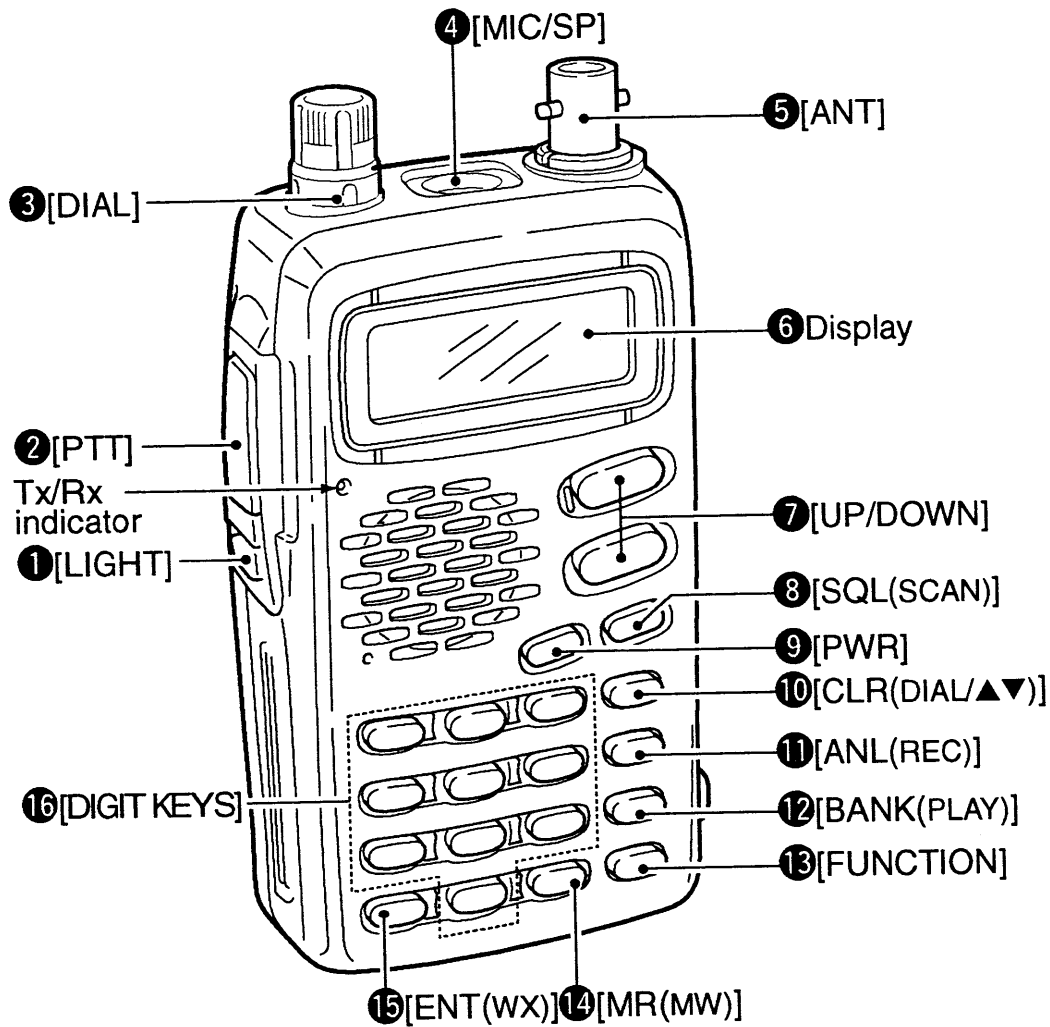

**1 LIGHT [LIGHT]** (p. 10)

Turns the light for display and keypad ON or OFF.

**2 PTT SWITCH [PTT]** (p. 11)

Push and hold to transmit; release to receive.

**3 TUNING DIAL [DIAL]** (p. 8)

- ➔ Rotate [DIAL] to select the desired frequency. (default)
- ➔ Rotate [DIAL] to select the BANK number. (default)
- ➔ Rotate [DIAL] to select the memory channel or WX channel number. (default)
- ➔ Rotate [DIAL] to adjust the audio level.

**4 EXTERNAL SPEAKER AND MICROPHONE JACKS [MIC/SP]**

Connect an OPC-967 HEADSET ADAPTER or headset, if desired.

**5 ANTENNA CONNECTOR [ANT]**

Connects the supplied antenna.

**6 FUNCTION DISPLAY** (pgs. 6, 7)

**7 UP/DOWN KEYS [▲]/[▼]** (p. 8)



➔ Push [▲] to increase the audio level, push [▼] to decrease the audio level. (default)



- ➔ Push to select the operating channel or frequency.
- ➔ Push to select the BANK number.

**8 SQUELCH KEY [SQL (SCAN)]** (p. 9)



- ➔ Push [SQL], then rotate the [DIAL] (or push [▲]/[▼]) to select the squelch level.
  - 24 squelch levels and squelch open (0) are available.
- ➔ Push , then push [SQL] to start scan function:
  - Frequency mode: Frequency scan function.
  - MEMORY mode: Bank scan or Full memory channel scan function.

**9 POWER SWITCH [PWR]**



- ➔ Push and hold for 0.5 sec. to turn the power ON or OFF.
- ➔ While pushing and holding [▲]/[▼] key, push [PWR] to enter the cloning function mode. (OPC-967 must be connected.)

**10 CLR KEY [CLR (DIAL/▲▼)]** (p. 8)



- ➔ Push , then push [CLR] to exchange the **3** tuning Dial function and **7** UP [▲]/DOWN [▼] switch function;
  - Dial: tuning (default)
  - UP [▲]/DOWN [▼]: audio level setting (default)
- NOTE:** You can adjust the audio level via [DIAL] and select the frequency, memory channel or BANK number via UP [▲]/DOWN [▼] keys.
- ➔ Push [CLR] to turn to the frequency mode, when memory channel, WX channel or 121.5 MHz is selected.

## 2 PANEL DESCRIPTION

### ⑩ CLR KEY [CLR(DIAL/▲▼)] (continue)

- DIAL/▲▼**  
**CLR**
- ➔ Push [CLR] to cancel the SCAN function.
  - ➔ Push [CLR] to cancel the direct frequency entering with digit key.
  - ➔ Push [CLR] to turn the squelch level adjusting mode OFF.

### ⑪ ANL KEY [ANL (REC)]

- REC**  
**ANL**
- ➔ Push to turn the ANL function ON or OFF.
  - ➔ Push **F**, then push [ANL (REC)] to turn the recording function ON. (p. 10)
    - The transceiver records the receiving signal or operators voice message by push and holding [PTT] for 20 sec.

### ⑫ BANK KEY [BANK (PLAY)]

- PLAY**  
**BANK**
- ➔ Push [BANK] to enter the BANK selection mode while memory channel is selected, push [CLR] to exit the BANK selection mode. (p. 12)
  - ➔ Push **F**, then push [BANK] to play the recorded signals. (p. 10)

### ⑬ FUNCTION KEY [F]

- F**
- ➔ Push to call up the function indicator, "☐", then push another key to access its secondary function.
  - "☐" appears for 3 sec. after [F] is pushed; at this time pushing [F] again cancels the indication. (p. 6)

**NOTE:** In general, "☐" disappears when another key is pushed to activate a secondary function. However, some keys which have more than one secondary function, (such as [DUP]), do not cancel "☐". In this case, "☐" disappears automatically after 3 sec.

### ⑭ MEMORY MODE KEY [MR (MW)] (pgs. 12, 13)

- MW**  
**MR**
- ➔ Push [MR] to call the memory channel mode, push [CLR] to exit the memory channel mode.
  - ➔ Push **F**, then push [MR (MW)] to program the contents into the memory channels.
  - ➔ Push [MR] to program the memory comment when the memory comment function is enabled.

### ⑮ ENTER KEY [ENT(WX)]

- WX**  
**ENT**
- ➔ Push [ENT] to enter the numeral input. Enters consecutive zero digits. (p. 8)
  - ➔ Push **F**, then push [ENT] to enter the weather channel selection mode. (U.S.A. version only) (p. 9)

#### • Rx/Tx indicator

- ➔ Lights red during the transmit mode.
- ➔ Lights green during receiving a signal or squelch is open.

**NOTE:** Some functions may not be available depending on version. Please consult your dealer.



**16 DIGIT KEYS**

- ➔ Input the specified digit during frequency input, memory channel selection, etc.
- ➔ In addition, each key has one or more secondary functions after pushing **F** as follows:

**121.5**  
**0** ➔ Push **F**, then push [0 (121.5)] to select the 121.5 MHz emergency frequency. (p. 8)

**DVOR**  
**1** ➔ Push **F**, then push [1 (DVOR)] to select the DVOR display from the CDI display in NAV band. (p. 19)\*<sup>1</sup>

**TO**  
**2** ➔ Push **F**, then push [2 (TO)] to change the course indicator characteristics to "TO" flag in the DVOR display in NAV band. (p. 19)\*<sup>1</sup>  
➔ Corrects the deviation while using "TO" flag. \*<sup>1</sup>

**FROM**  
**3** ➔ Push **F**, then push [3 (FROM)] to change the course indicator characteristics to "FROM" flag in the DVOR display in NAV band. (p. 19)\*<sup>1</sup>  
➔ Corrects the deviation while using "FROM" flag. \*<sup>1</sup>

**CDI**  
**4** ➔ Push **F**, then push [4 (CDI)] to select the CDI display from the CDI display in NAV band. (p. 19)\*<sup>1</sup>

**DUP-W**  
**5** ➔ Push **F**, then push [5 (DUP-W)] to set the duplex frequency in NAV band. (p. 22)\*<sup>1</sup>

**DUP**  
**6** ➔ Push **F**, then push [6 (DUP)] to turn the duplex function ON and OFF in NAV band. (p. 22)\*<sup>1</sup>

**KEY LOCK**  
**7** ➔ Push **F**, then push [7 (KEY LOCK)] to turn the key lock function ON and OFF. (p. 10)

**BEEP**  
**8** ➔ Push **F**, then push [8 (BEEP)] to turn the beep tone adjusting mode ON.  
• Adjustable level; 0 to 9 (p. 9)

**TAG**  
**9** ➔ Push **F**, then push [9 (TAG)] to set the displayed memory or weather channel as a "TAG" channel. (p. 17)

\*<sup>1</sup> These functions available on the IC-A23 only.

## 2 PANEL DESCRIPTION

### ■ Function display (COM)

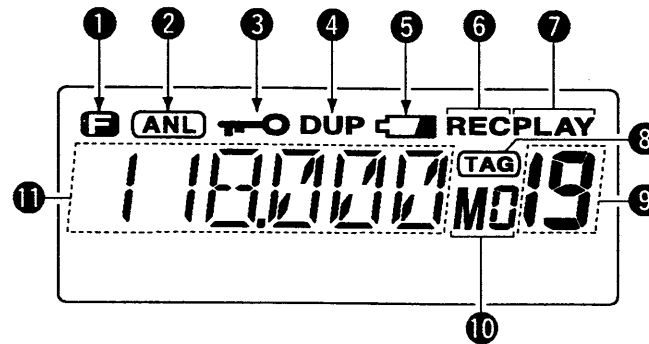

- 1 FUNCTION INDICATOR** (p. 4)  
Appears when  is pushed.
  - ➔ Appears and flashes when battery replacement is necessary.
- 2 ANL INDICATOR** (p. 4)  
Appears while the ANL (Automatic Noise Limiter) function is in use.
- 3 LOCK INDICATOR** (p. 10)
  - ➔ Appears while the lock function is in use.
- 4 DUPLEX INDICATOR** (IC-A23 only) (p. 22)
  - ➔ "DUP" appears when the duplex function is activated in NAV mode.
  - ➔ "DUP" blinks while setting the duplex frequency.
- 5 LOW BATTERY INDICATOR** (p. 10)
  - ➔ Appears when the battery is nearing exhaustion. The attached battery pack requires recharging.
- 6 RECORD INDICATOR** (p. 10)
  - ➔ "REC" blinks while the internal recorder is recording the signal.
- 7 PLAY INDICATOR** (p. 10)
  - ➔ "PLAY" appears during play back of the recorded signal.
- 8 TAG CHANNEL INDICATOR** (p. 17)
  - ➔ "TAG" appears when the memory channel is set as a TAG channel.
- 9 MEMORY CHANNEL INDICATOR** (p. 12)
  - ➔ Shows the memory channel number.

## ■ Function display (COM/NAV)

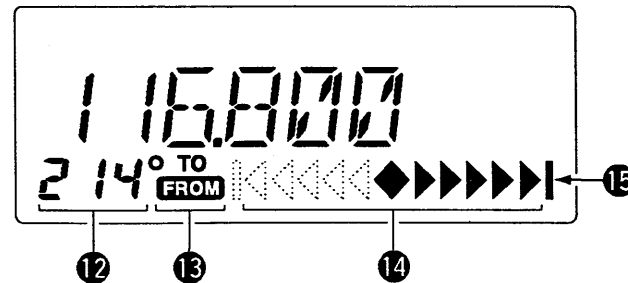

**10 MEMORY BANK NUMBER INDICATOR** (p. 12)  
Shows the selected memory bank number.

**11 FREQUENCY DISPLAY** (p. 8)  
 ➤ Shows the operating frequency.  
 ➤ Shows the channel name when the memory name function is selected.

**12 COURSE INDICATORS** (IC-A23 only) (p. 19)  
 ➤ Indicates where your aircraft is located on a VOR radial in DVOR mode.  
 ➤ Indicates where your desired course is located on a VOR radial in CDI mode.

**13 TO-FROM INDICATOR** (IC-A23 only) (p. 19)  
 ➤ Indicates whether the VOR navigation information is based on a course leading to the VOR station or leading away from the VOR station.

**14 COURSE DEVIATION NEEDLES** (IC-A23 only) (p. 22)  
 ➤ Indicates the deviation between the desired course and your actual flying course every 2 degrees.

**15 OVERFLOW INDICATOR** (IC-A23 only) (p. 22)  
 ➤ Appears when the deviation between the desired course and flying course is over 10 degrees.

## ■ DIAL ↔ [▲]/[▼] trade function

The transceiver is equipped [DIAL] ↔ [▲]/[▼] keys trade function. Push  then push [CLR (DIAL/▲▼)] to trade each function.

### **Default setting:**

DIAL: •Setting the frequency, •Selecting the memory channel, •Selecting the bank number

▲▼ keys: •Increasing or decreasing the audio level



Following explanation is according to the default setting.

## ■ Setting a frequency

### ◇ Using keypad

- ① Push [PWR] for 0.5 sec. to turn power ON, then push [CLR] to select the frequency mode when memory CH number or WX CH number appears on the function display.
- ② Push 5 appropriate digit keys to input the frequency.
  - Enter [1] as the 1st digit.
  - When a digit is mistakenly input, push [CLR] to clear, then start again.
  - Push [ENT] to enter consecutive zero digits.
  - Only [2], [5], [7] and [0] can be entered as the 5th and final digit.

### ◇ Using the tuning dial

- ① Push [PWR] for 0.5 sec. to turn power ON, then push [CLR] to select the VFO mode when memory CH number or WX CH number appears on the function display.
- ② Rotate the [DIAL] to set the desired frequency.
- ③ To select the 1 MHz tuning step, push , then rotate the tuning dial. Push  again to return the normal tuning.

## ■ Accessing 121.5 MHz emergency frequency

The IC-A23 and IC-A5 can quickly access the 121.5 MHz emergency frequency. This function can be activated even when the key lock function is in use.

- ① Push , then push [121.5] to call the emergency frequency.
- ② Push [CLR] to exit from the emergency frequency.

## ■ Selecting a weather channel

(U.S.A. version only)

The U.S.A. version has VHF marine WX (weather) channel receiving capability for flight planning.

- ① Push , then push [ENT (WX)] to select WX channel mode.

- “WX--” and previously selected channel number appears.

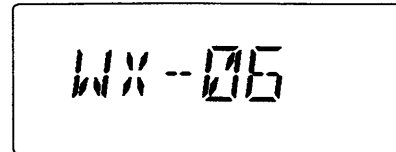

- ② Rotate the [DIAL] to select the desired WX channel.
- ③ Push [CLR] to exit the WX channel mode and return to frequency mode.

## ■ Setting squelch level

The transceiver has a noise squelch circuit to mute undesired noise while receiving no signal.

### ◆ Setting the squelch level

- ① Push [SQL], then rotate the [DIAL] (or using [▲]/[▼] key) to select the squelch level.
  - ‘SQL--0’ is loose squelch and ‘SQL--24’ is tight squelch.
  - Rx indicator turns to green during the squelch is open.
- ② Push [SQL] or [CLR] to exit the squelch set mode.

## ■ Side tone function

When using an optional headset, such as those from the David Clark Co. via the OPC-967 HEAD SET ADAPTOR, the transceiver outputs your transmitted voice to the headset for monitoring. (p. 32)

### ◆ Setting the side tone level

- ① Push [PTT] to turn the transmit mode ON.
- ② During transmit mode, push [▲]/[▼] several times to adjust the monitoring level.
  - ‘ST-0’ is OFF and ‘ST--15’ is Max. level.

 **NEVER** operate the transceiver with a headset at high volume levels for long period. A ringing in your ears may occur. If so, reduce the monitor level or discontinue use.

## ■ Beep tone

The beep tone which sounds each times a switch is pushed can be adjusted, as desired.

- ① Push , then push [BEEP].
- ② Rotate [DIAL] (or using [▲]/[▼] key) to adjust the beep level.
- ③ Push [CLR] to exit the beep tone set mode.
  - ‘BEP-0’ is OFF and ‘BEP--9’ is Max. level.

### 3 BASIC OPERATION

## ■ Lock function

The lock function prevents accidental frequency changes and accidental function activation.

- ① Push **F**, then push [KEY LOCK] to turn the function ON.
- ② To turn the function OFF, repeat step ① above.
  - “” disappears.

## ■ Display backlighting

Push [LIGHT] to turn the display backlighting ON or OFF.

## ■ Low battery indicator

Low battery indicator appears when the battery power has decreased to a specified level. The attached battery pack requires recharging.

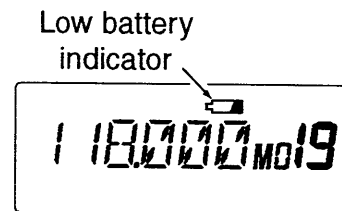

## ■ REC/PLAY the signals /messages

### ◇ Recording a signal /message

➔ Push **F**, then push [ANL (REC)] to start to record the message for 20 sec.

- ‘REC’ blinks on the display.
- Push [CLR] to cancel the recording.
- No message is recorded when no audio comes from the speaker. (e.g. When the squelch is closed.)
- You can record your own message by pushing and holding [PTT] during the recording mode. Frequency or memory CH display disappears in this case.
- No transmission available during the recording mode.
- Only the latest message is remains.

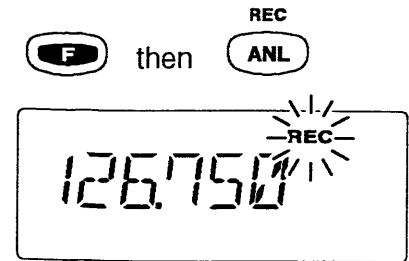

### ◇ Play

➔ Push **F**, then push [BANK (PLAY)] to play back the message.

- ‘PLAY’ appears on the display.
- Push [CLR] to cancel the play back.
- Play back the message during the transmit mode, you can transmit the recorded message.

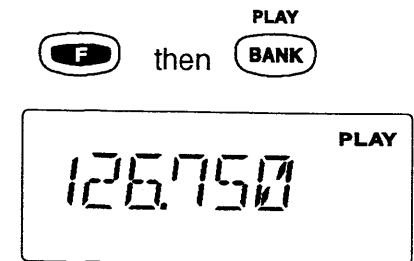

## ■ Receiving

- ① Push [PWR] to turn the power ON.
- ② Push [SQL], then turn the [DIAL] counterclockwise (or [▼] key) to select the squelch level [0].
- ③ Push [▲]/[▼] key several times to adjust the audio level.
- ④ Push [SQL], then turn the [DIAL] clockwise (or [▲] key) until the noise is muted.
  - The Tx/Rx indicator disappears.
- ⑤ Set the desired frequency using the [DIAL] or keypad.
- ⑥ Push [ANL] to reduce pulse noise such as that caused by engine ignition systems, if necessary.
  - [ANL] appears on the display.
- ⑦ When a signal is received on the set frequency:
  - The Tx/Rx indicator lights green
  - Squelch opens and audio is emitted from the speaker.

When the [SQL] control is too “deep”, squelch may not open for weak signals. To receive weak signals, set the squelch to a “loose” position.

## ■ Transmitting

**CAUTION:** Transmitting without an antenna may damage the transceiver.

**NOTE:** To prevent interference, listen on the frequency before transmitting. If the frequency is busy, wait until the channel is clear.

- ① Set the desired frequency in COM band using the [DIAL] or keypad.
  - COM band frequency range: 118.00–136.975 MHz
- ② Push and hold [PTT] to transmit.
  - The Tx/Rx indicator lights red.
- ③ Speak into the microphone at a normal voice level.
  - **DO NOT** hold the transceiver too close to your mouth or speak too loudly. This may distort the signal.
- ④ Release [PTT] to return to receive.

## ■ Memory channel selection

The transceiver has 200 memory channels for storage of often-used frequencies along with 6-character notes.

- ① Push [MR] to select memory mode.
  - Memory BANK number and memory CH number appears.

### **Using the [DIAL]:**

- ② Push [BANK], then rotate the [DIAL] to select the desired memory bank number, then push [BANK] (or [CLR]) to exit the bank selection mode.
  - "BANK" appears.
- ③ Rotate [DIAL] to select the desired memory CH number.
  - If no memory channel is programmed in the selected bank, no memory CH selection is available.

### **Using the Keypad:**

- ② Push [BANK], then push appropriate digit key (0 to 9) to select the desired memory bank number, then push [BANK] (or [CLR]) to exit the bank-selection mode.
  - "BANK" appears.
- ③ Push 2 appropriate digit key (00 to 19) to select the desired memory CH number.
  - If no memory channel is programmed in the selected bank, no memory CH selection is available.

Comments appear first when programmed, however, the transceiver can be programmed by your dealer to show the operating frequency first. Push [MR] to display the comment in this case.

## ■ Transferring memory contents

This function transfers a memory channel's contents into the frequency mode. This is useful when searching for signals around a memory channel's frequency.

- ① Push [MR] to select memory mode.
- ② Select the desired memory channel to be transferred using the [DIAL] or keypad.
- ③ Push **F**, then push [MR].
  - BANK number and memory CH number disappears as frequency mode is automatically selected and the memory contents are transferred.

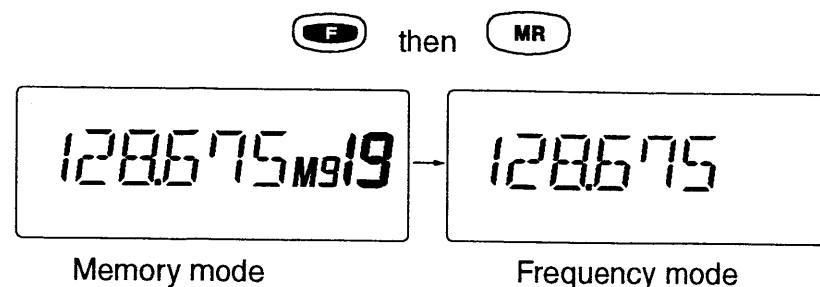



# ■ Programming a memory channel

The transceiver has 200 (10 BANK x 20 CH) memory channels for storage of often-used frequencies.

- ① Push [CLR] to select Frequency mode, if necessary.
- ② Select the desired frequency.
  - Push **F**, then push [ENT (WX)] to select a weather channel.\*
  - Set the desired frequency or WX channel\* using the [DIAL] or keypad.
- ③ Push **F**, then push [MR (MW)].
  - Memory BANK and memory channel number appears.
- ④ Rotate the [DIAL] to select the desired memory channel number.
  - [M] blinks.
  - Push [BANK] to select the BANK number if desired. Push [CLR] (or [BANK]) to exit the BANK selection mode.
- ⑤ Push [ENT] to program the information into the channel and return to Frequency mode.

\*Weather channel: U.S.A. version only.

• **EXAMPLE:** Programming WX-05\* into memory BANK 3/ memory channel 2.

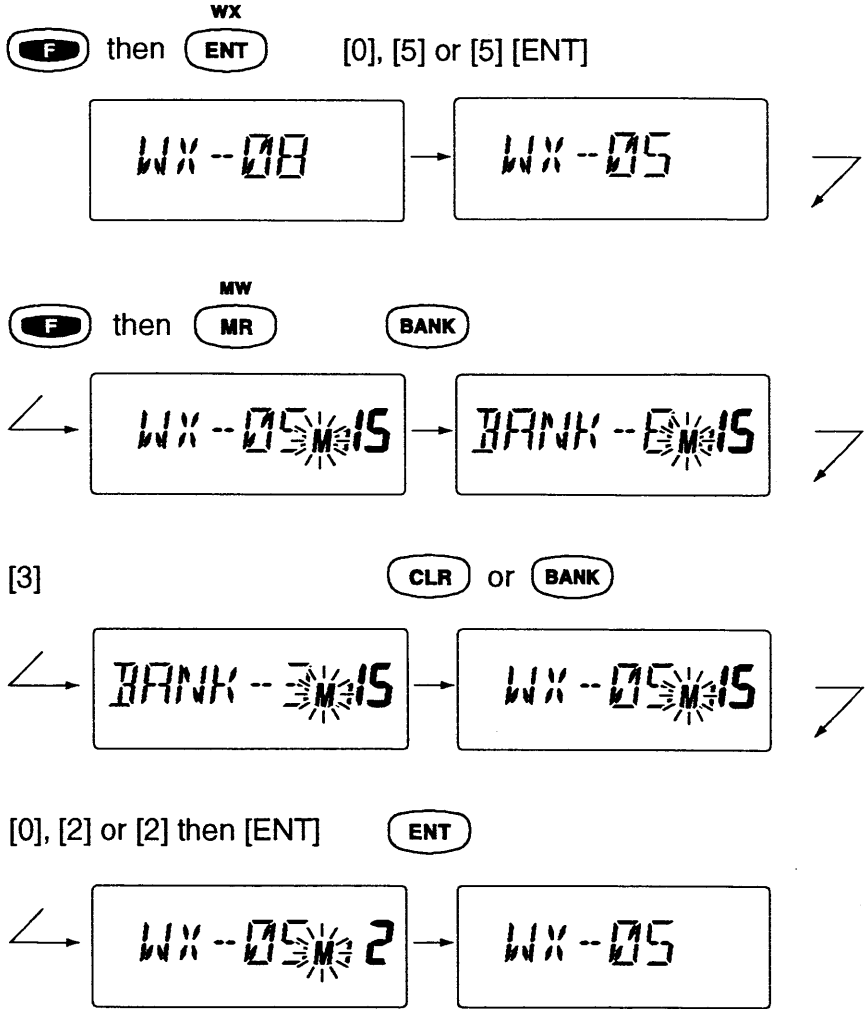

## 4 MEMORY OPERATION

### ■ Memory names

#### ◇ Programming memory names

The memory channel can display a 6-character comment as well as a frequency.

- ① Rotate the [DIAL] to select the desired frequency in Frequency mode.
- ② Push , then push [MR].
- ③ Rotate the [DIAL] to select the desired memory channel to be programmed.
  - Push [BANK] to select the BANK number if desired. Push [CLR] to exit the BANK selection mode.
- ④ Push [MR] to enter the memory name programming mode.
  - “- - - - -” appears on the display.
- ⑤ Push the appropriate digit key several times to select the desired character as listed at right.
  - To erase a character, overwrite with a space (displayed as \_).
  - To move the cursor forwards or backwards, use [DIAL].
- ⑥ Push [ENT] to program the name.
  - Flashing stops.
  - When no name is programmed, the display shows the operating frequency.
  - To clear the entered comment, push [CLR] before pushing [ENT].

key	Character	key	Character	key	Character
1	1, Q, Z	2	2, A, B, C	3	3, D, E, F
4	4, G, H, I	5	5, J, K, L	6	6, M, N, O
7	7, P, R, S	8	8, T, U, V	9	9, W, X, Y
ENT	Program	0	0, space -		

#### ◇ Clearing memory contents

Unwanted memory channels can be cleared. Programming over a memory channel also clears the previously programmed contents. Memory channel 1 cannot be cleared.

- ① Select the memory channel to be cleared.
- ② Push , then push and hold [CLR] for 1 sec.
  - “- - - - -” appears momentarily, then the next selectable channel appears.

• **EXAMPLE:** Programming 125.000 MHz into memory BANK 0/ memory channel 15 with "AIR-23" as a comment.

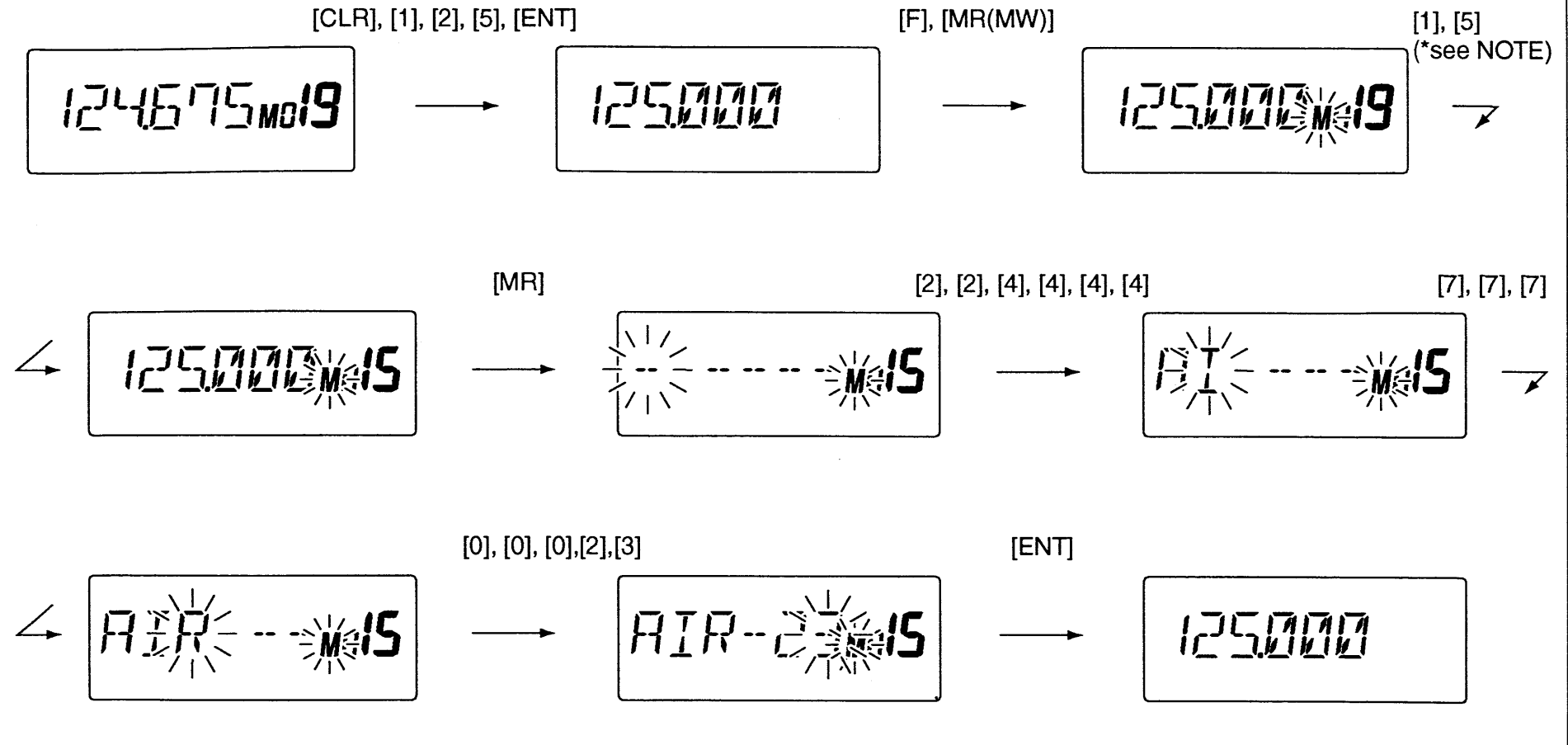

\*NOTE: Push [BANK], then rotate the [DIAL] to select the BANK number, if desired. Push [CLR] to continue memory name programming.

## Scan types

The U.S.A. version has 3 scan types to suit your needs. The non-U.S.A. versions have 2 scan types.

### COM BAND SCAN

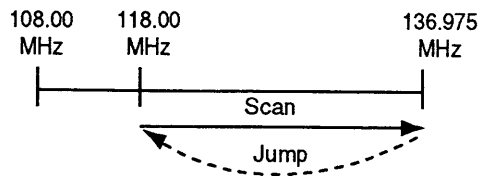

Repeatedly scans all frequencies over the entire COM band.

### MEMORY SCAN

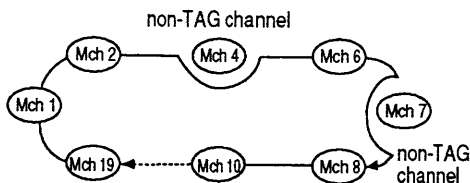

Repeatedly scans all "TAG" memory channels. Used for checking often-used channels and bypassing usually busy channels such as control-tower frequencies..

### WEATHER CHANNEL SCAN

Repeatedly scans all "TAG" weather channels. Weather channels are available for the U.S.A. version only.

## COM band scan

- ① Push [CLR] to select VFO mode.
- ② Set squelch to the point where noise is just muted.
- ③ Push , then push [SQL (SCAN)] to start the scan.
  - When a signal is received, the scan pauses until it disappears.
  - To change the scanning direction, rotate the [DIAL].
- ④ To stop the scan, push [CLR].

## Memory scan

- ① Push [MR] to select memory mode.
- ② Set squelch to the point where noise is just muted.
- ③ Push , then push [SQL (SCAN)] to start the scan.
  - When a signal is received, the scan pauses until it disappears.
  - To change the scanning direction, rotate the [DIAL].
- ④ To stop the scan, push [CLR].

## ■ Weather channel scan

(U.S.A. version only)

- ① Push **F**, then push [ENT (WX)] to select a weather channel.
- ② Set squelch to the point where noise is just muted.
- ③ Push **F**, then push [SQL (SCAN)] to start the scan.
  - When a signal is received, the scan pauses until it disappears.
  - To change the scanning direction, rotate the [DIAL].
- ④ To stop the scan, push [CLR].

## ■ “TAG” channels

Memory and weather\* channels can be specified to be skipped for the memory and weather\* channel scans respectively. The “TAG” channel function is only available during scan operation.

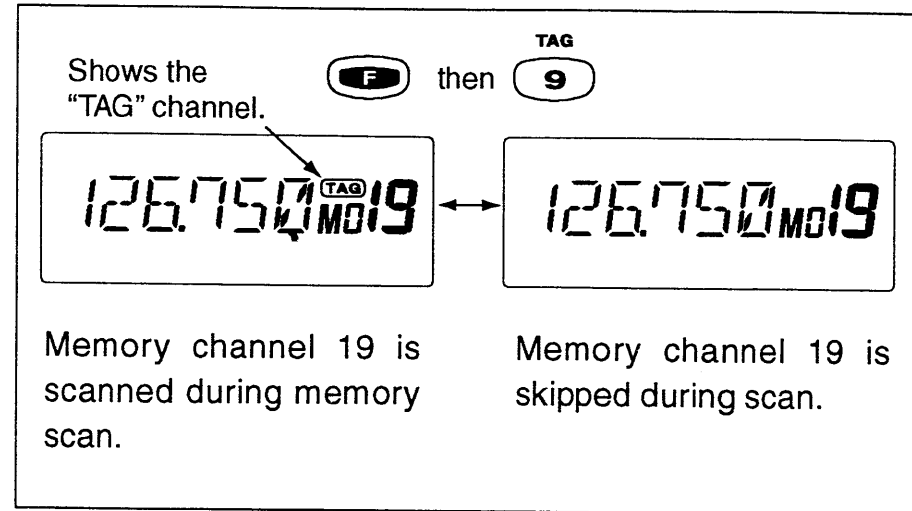

- ① Push [MR] to select memory mode; or, push **F**, then push [ENT (WX)] to select a weather channel\*.
- ② Select the desired channel to be a “TAG” channel.
- ③ Push **F**, then push [9 (TAG)].
  - “TAG” appears.
  - Non-“TAG” channels are skipped during scan.
- ④ To cancel the “TAG” setting, repeat above steps.

\*Weather channel: U.S.A. version only.

## VOR indicators

NAV BAND (108.00–117.975 MHz)

COM BAND  
(118.00–136.975 MHz)

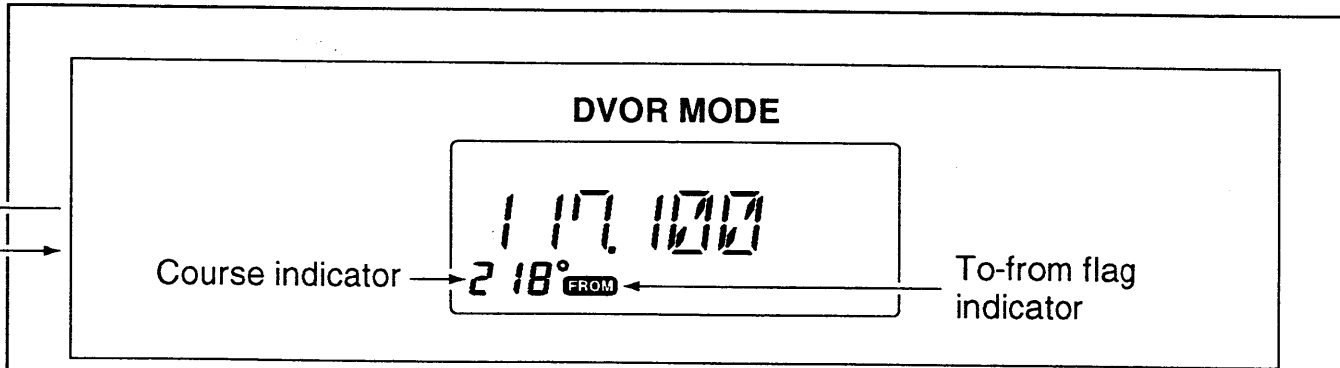
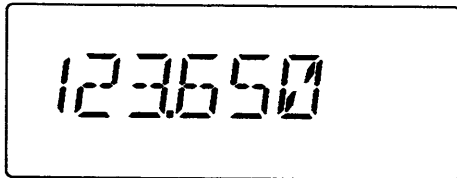

Push [F] then [① DVOR]. ↑ ↓ Push [F] then [④ CDI].

### CDI MODE

General VOR equipment

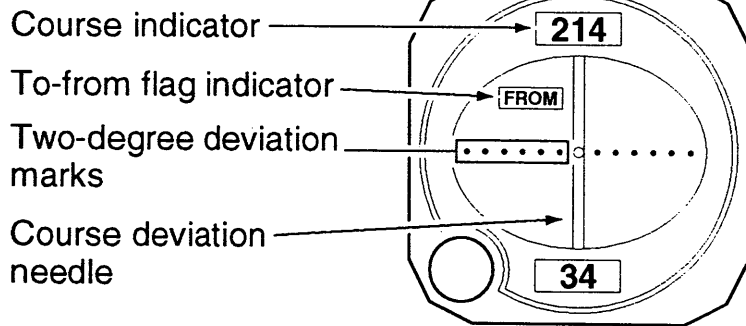

Function display of the IC-A23

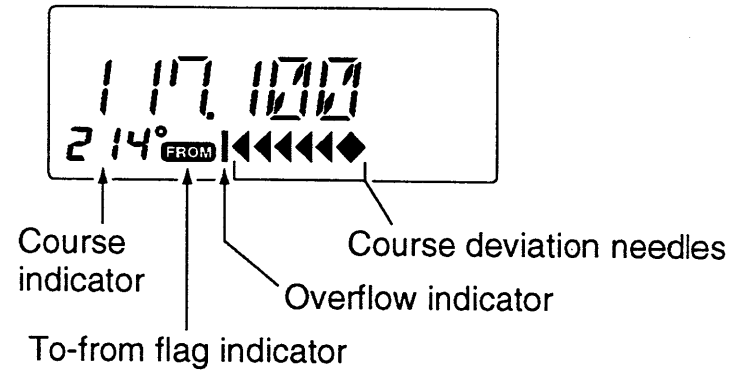

## ■ VOR functions

### ◆ To select CDI mode

To show the deviation between your flying course and the desired course, push **(F)**, then [4 (CDI)].

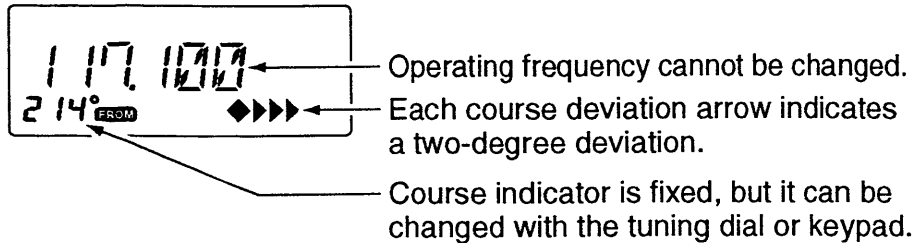

### ◆ To select DVOR mode

When entering the NAV band, 108.000–117.975 MHz, the IC-A23 selects DVOR mode automatically.

To show your aircraft's direction to (or from) the VOR station, push **(F)**, then [1 (DVOR)].

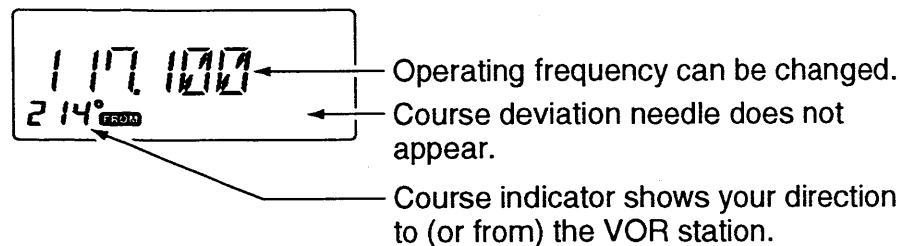

### ◆ 'TO' or 'FROM' flag selection

The to-from flag indicators indicate whether the VOR navigation information is based on a course leading to the VOR station or leading away from the VOR station.

To change the flag from 'TO' to 'FROM' or vice versa, push **(F)**, then [3 (FROM)] or [2 (TO)], respectively.

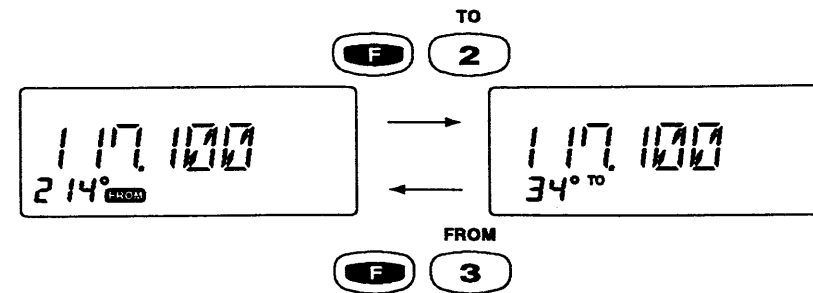



- When using the 'TO' flag and passing through the VOR station, the 'TO' flag changes to the 'FROM' flag automatically.
- When turning power ON, the 'FROM' flag is selected automatically.

### ◆ Selecting the next VOR station when using CDI mode (when using the course deviation needle)

- ① Push **(F)**, then [1 (DVOR)].
- ② Set the next VOR station's frequency.
- ③ Push **(F)**, then [4 (CDI)].
  - Select 'TO' or 'FROM' flag, if desired.

## ■ Flying to a VOR station

The IC-A23 shows the deviation from a VOR station.

- ① Select a VOR station on your aeronautical chart and set the frequency of the station.
  - The course indicator indicates where you are located on a radial from the VOR station.
  - The course indicator shows '- -' when either aircraft is too far away from the VOR station or the frequency is not set correctly at the VOR station.
- ② Select the 'TO' flag when flying to the VOR station, or select the 'FROM' flag when flying away from the VOR station.
  - To select 'TO,' push , then [2 (TO)].
  - To select 'FROM,' push , then [3 (FROM)].
- ③ Push , then [4 (CDI)] to select CDI (Course Deviation Indicator) mode.
  - The course indicator shows 'OF' when the desired VOR signal cannot be received.

 When CDI mode is selected, the operating frequency cannot be changed. To set the operating frequency, select DVOR mode in advance.

- ④ The course deviation needle appears when your aircraft is off course from the VOR station.
  - '◀' or '▶' appears to indicate your aircraft is off course to the right or left, respectively. Correct your course until '◀' or '▶' disappears. Each arrow represents a two-degree deviation.
- ⑤ To exit CDI mode, push , then [1 (DVOR)].

### VOR INDICATOR NOTE

'loc' appears on the function display as shown below when a localizer signal is received.

However, the function display does not indicate additional information about the localizer signal.

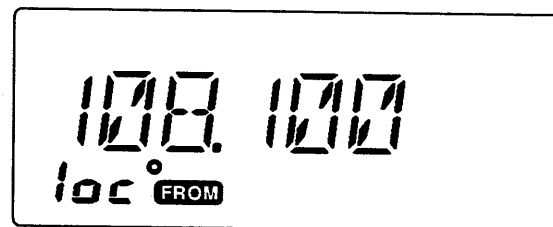



## THE AIRCRAFT IS ON COURSE

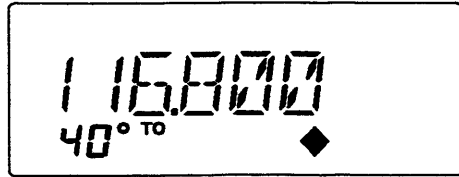

123.65  
VORTAC  
SEATTLE  
116.8 Ch 115 SEA

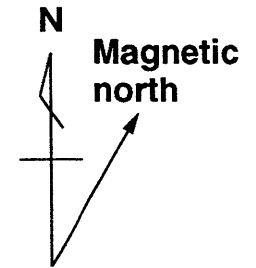
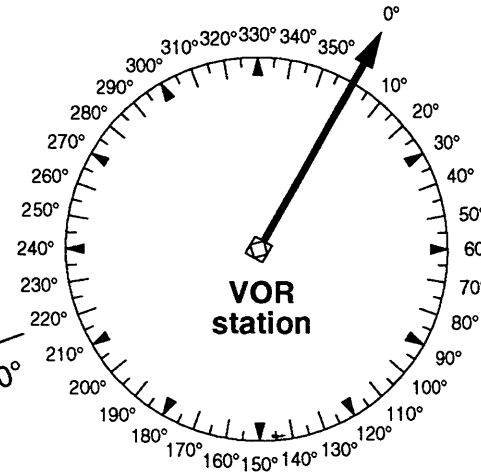
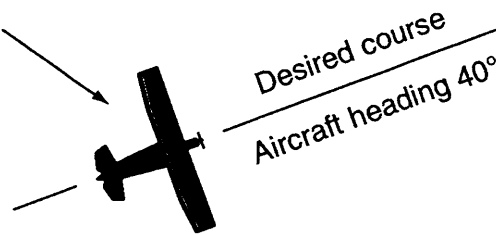

## THE AIRCRAFT IS OFF COURSE

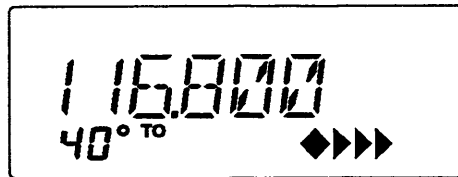

123.65  
VORTAC  
SEATTLE  
116.8 Ch 115 SEA

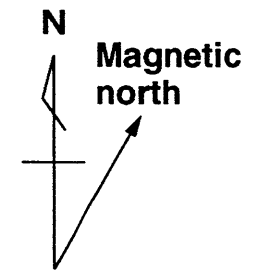
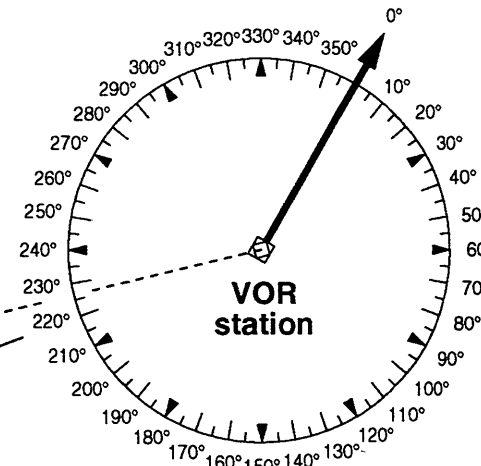
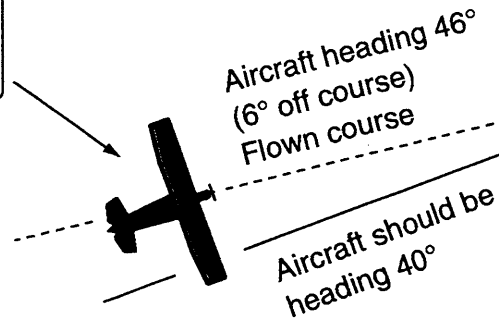

The course deviation indicator appears when the aircraft is off course. In this example, the aircraft is 6 degrees off course to the left. The pilot must turn more than 6 degrees right to get back on course.

## ■ Entering a desired course

The IC-A23 shows not only the deviation from the VOR station but the deviation from the desired course.

- ① Set the frequency for the desired VOR station.
  - To change the to-from flag, push **F**, then [2 (TO)] or [3 (FROM)].
- ② Push **F**, then [4 (CDI)] to select CDI mode.
- ③ Set the desired course to the VOR station using the tuning dial or keypad.
  - '◀' or '▶' appears on the function display when your aircraft is off the desired course.
  - When your heading is correct, the ABSS function may be useful instead of course input.
- ④ The course deviation needle points to the right when your aircraft is off course to the left.
  - To get back on course, fly right more than the number of degrees indicated by the CDI arrows.
  - If the overflow indicator appears on the right side, select a heading plus 10 degrees to the desired course; if the overflow indicator appears on the left side, select a heading minus 10 degrees.

## ■ Crosschecking position

- ① Select 2 VOR stations on your aeronautical chart.
- ② Set the frequency of one of the VOR station in DVOR mode.
  - The course indicator shows course deviation from the VOR radial. Note the radial you are on.
- ③ Set the frequency of the other VOR station in DVOR mode.
  - Note the radial from the station you are on.
- ④ Extend the radials from each VOR station on the chart. Your aircraft is located at the point where the lines intersect.

### ABSS FUNCTION

In CDI mode, the Auto Bearing Set System (ABSS) adds or subtracts the number of degrees indicated by the CDI arrows from the Omni Bearing Selector (OBS).

To use ABSS, push **F**, then [2 (TO)] while using the 'TO' flag; or, push **F**, then [3 (FROM)] while using the 'FROM' flag.

**EXAMPLE:** Entering the desired course bearing 89° to a VOR station.

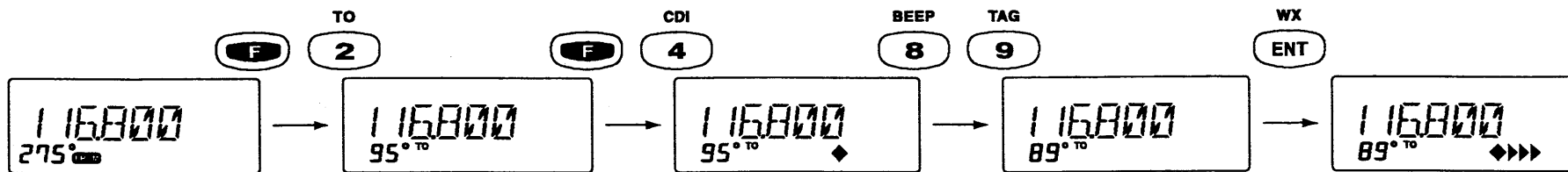

**CROSSCHECKING POSITION**

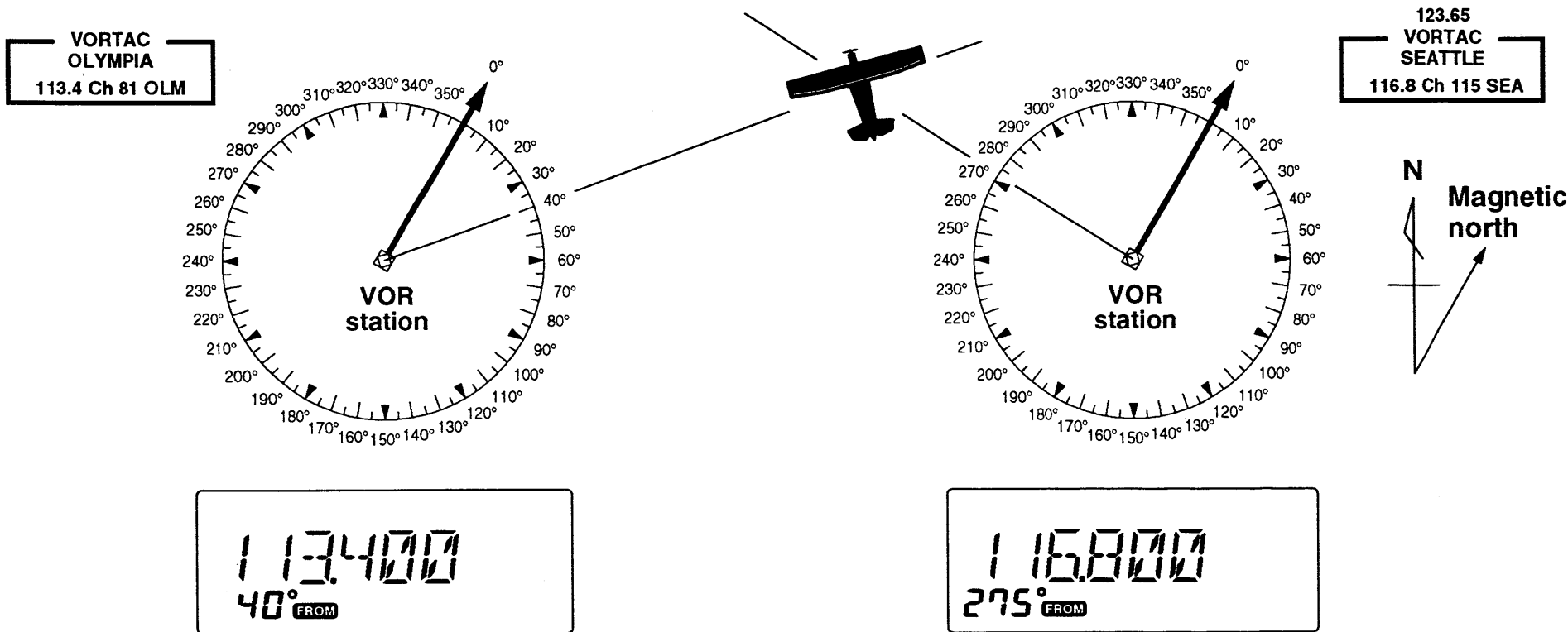

## ■ Duplex operation



(U.S.A. version only)

The duplex function allows you to call a flight service station while receiving a VOR station. The duplex function requires frequency programming for the flight service station in advance.

### ◆ Programming a duplex frequency

- ① Push [CLR] to select frequency mode.
- ② Set a NAV band frequency using the tuning dial or keypad.
  - NAV band frequency range: 108.00–117.975 MHz
- ③ Push , then [5 (DUP-W)].
  - “DUP” flashes and transmit frequency appears.
- ④ Set the frequency of the flight service station using the tuning dial or keypad. When using the tuning dial, push [ENT] after setting a frequency.
  - The displayed frequency returns to the NAV band frequency.

### ◆ Operating the duplex function

- ① Set the desired frequency in NAV band.
  - NAV band frequency range: 108.00–117.975 MHz
- ② Push , then [6 (DUP)] to turn the duplex function ON.
  - “DUP” appears on the function display.
- ③ Push and hold [PTT] to transmit at the pre-programmed transmit frequency.
- ④ Release [PTT] to return to receive.
- ⑤ Push , then [6 (DUP)] to cancel the function.

 A duplex frequency can be programmed into each memory channel independently. Set a duplex frequency before programming the memory channel, if desired. The duplex ON/OFF setting can also be programmed into a memory channel.

**EXAMPLE:** Programming 123.65 MHz as the transmit frequency in the duplex function.

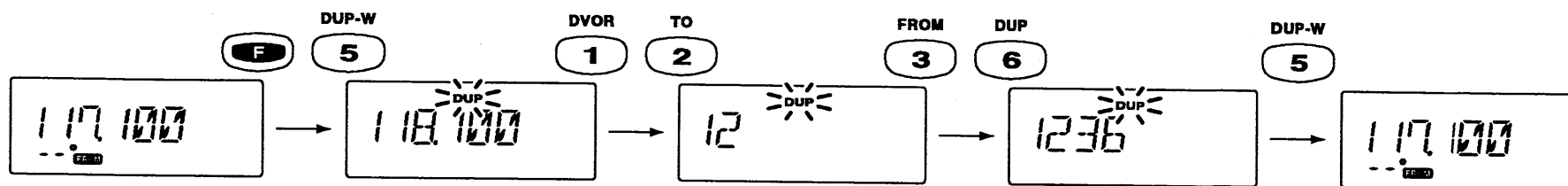

## ■ Charging precautions

**NEVER** connect two or more chargers at the same time.

Charging may not occur under temperatures of 10°C (+50°F) or over temperatures of 40°C (+104°F).

 **When using BC-119:** If the charge indicator flashes orange, vehicle battery voltage is low and charging is not possible. Check the vehicle battery voltage in this case. If the charge indicator flashes red, there may be a problem with the battery pack (or charger). Re-insert the battery pack or contact your dealer.

## ■ Battery pack charging

The BP-200L BATTERY PACK includes rechargeable Ni-MH batteries and can be charged approx. 300 times. Charge the battery pack before first operating the transceiver or when the battery pack becomes exhausted.

If you want to be able to charge the battery pack more than 300 times, the following points should be observed:

1. Avoid overcharging. The charging period should be less than 48 hours.
2. Use the battery until it becomes almost completely exhausted under normal conditions. We recommend battery charging just after transmitting becomes impossible.

### ◇ Rapid charging with the BC-119

The optional BC-119 provides rapid charging of battery packs.

One AD-87 and an AC adapter (may be supplied with the BC-119 depending on version) are additionally required.

- ① Fix the optional AD-88 TERMINAL PC BOARD FOR CHARGER into the BC-119 with the 4 supplied screws.
- ② Insert the optional AD-87A\* CHARGE ADAPTER into the charging slot of the BC-119.
- ③ Insert the optional AD-87B\* CHARGE ADAPTER into the AD-87A\* CHARGE ADAPTER.
- ④ Insert the battery pack, either by itself or attached to the transceiver, into the whole assembly for charging. (p. 26)

\*AD-87A and AD-87B supplied together named as AD-87.

•Charging period: 1.5 to 2 hours

# 7 BATTERY PACKS

## ◇ Rapid charging with the BC-119

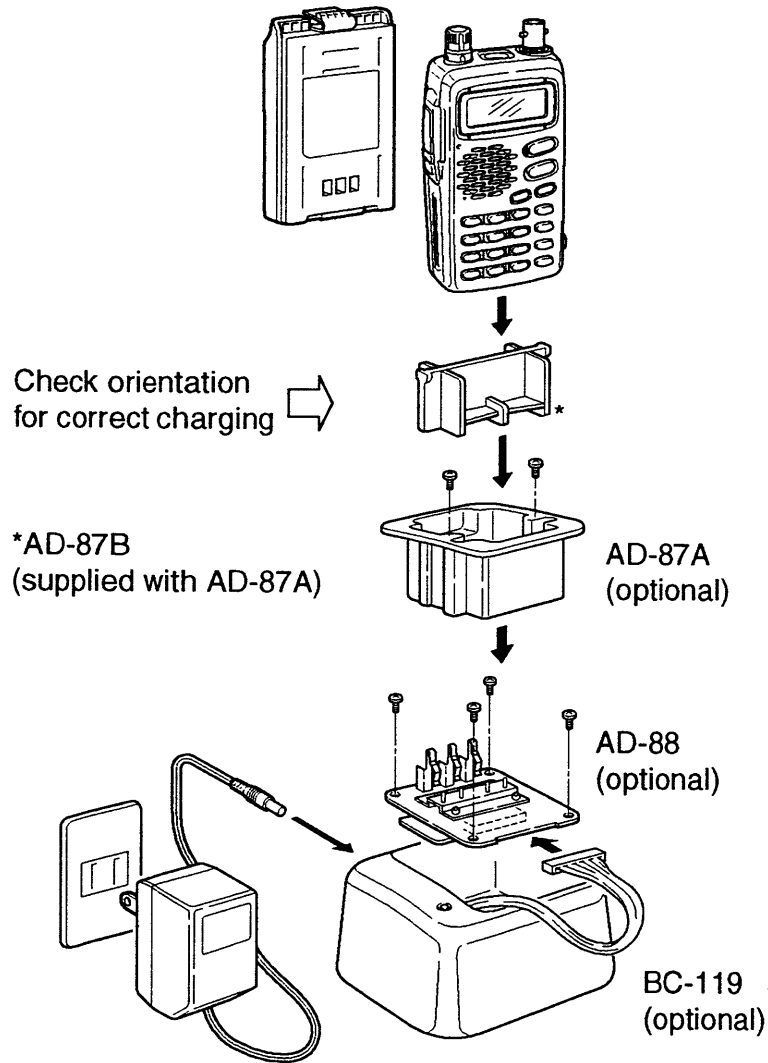

## ◇ Regular charging

- ① Attach the battery pack to the transceiver.
- ② Be sure to turn the transceiver power OFF.
- ③ Connect the Wall charger (BC-110A) or optional cable (CP-12L or OPC-254L) as shown below.

•Charging period: 15 hours

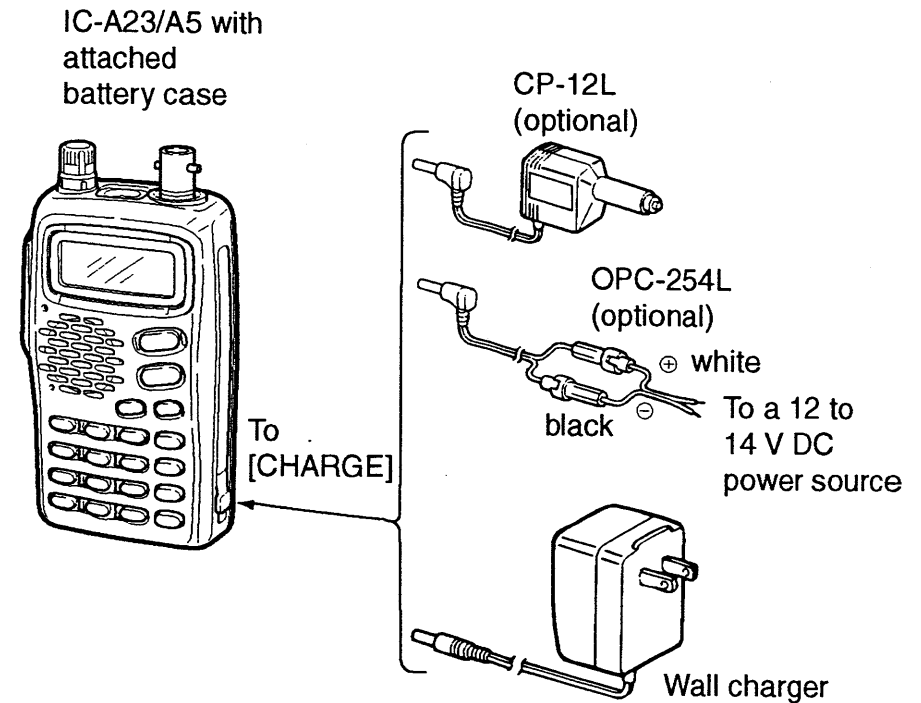

## ■ About the battery pack

### ◇ Operating period

The operating period of the transceiver is 6 hours.

- Operating periods are calibrated for the following conditions:  
at 25°C (77°F), Tx : Rx : standby = 5 : 5 : 90

### ◇ Battery pack life

If your battery pack seems to have no capacity even after being fully charged, completely discharge it by leaving the power ON overnight. Then, fully charge the battery pack again.

If the battery pack still does not retain a charge (or very little), a new battery pack must be purchased.

## ■ Battery pack CAUTION

- **NEVER** short the terminals of the battery pack. Also, current may flow into nearby metal objects, such as a necklace, etc. Therefore, be careful when carrying with, or placing near metal objects, carrying in handbags, etc.
- Keep battery contacts clean. It's a good idea to clean battery terminals once a week.

Cloning allows you to quickly and easily transfer the programmed data from one transceiver to another transceiver, or, data from PC to a transceiver using the optional CS-A23 cloning software.

### ◇ Transceiver to transceiver cloning

- ① Connect the OPC-474 CLONING CABLE with adapter plugs to the [SP/MIC] jack of the master and slave transceivers.
  - The master transceiver is used to send data to the slave transceiver.
- ② While push and holding [▲] + [▼], push [PWR] ON to enter cloning mode (for both the master transceiver and slave transceiver both.).
  - “CLONE” appears and the transceivers enter the clone standby condition.
- ③ Push [ENT] on the master transceiver.
  - “CL-OUT” appears in the master transceiver’s display.
  - “CL-IN” appears automatically in the slave transceiver’s display.
- ④ When cloning is finished, turn power OFF, then ON again to exit cloning mode.



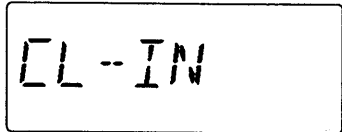

▨ **NOTE: DO NOT** transfer the data from IC-A23 to IC-A5, when the data contains the NAV band data. In such case, cloning error may occur.

### Cloning using PC

Data can be cloned to and from a PC (IBM compatible) using the optional CS-A23 CLONING SOFTWARE and the optional OPC-478 CLONING CABLE. Consult the CS-A23 CLONING SOFTWARE HELP message for details.

### ◇ Cloning error

▨ **NOTE: DO NOT** push [ENT] on the slave transceiver during cloning. This will cause a cloning error.

When the display at right appears, a cloning error has occurred.

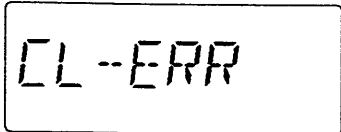

In this case, both transceivers automatically return to the clone standby condition and cloning must be repeated.



If your transceiver seems to be malfunctioning, please check the following points before sending it to a service center.

PROBLEM	POSSIBLE CAUSE	SOLUTION	REF.
No power comes on.	<ul style="list-style-type: none"> <li>• The battery is exhausted.</li> <li>• Bad connection for the battery pack.</li> </ul>	<ul style="list-style-type: none"> <li>• Recharge the battery pack.</li> <li>• Check the connection to the transceiver.</li> </ul>	pgs. 25, 26
No sound comes from the speaker.	<ul style="list-style-type: none"> <li>• Squelch level is too deep.</li> <li>• Volume level is too low.</li> </ul>	<ul style="list-style-type: none"> <li>• Set squelch to the threshold point.</li> <li>• Set [VOL] to a suitable level.</li> </ul>	pgs. 9, 11
Transmitting impossible.	<ul style="list-style-type: none"> <li>• Some channels are receive only.</li> <li>• The battery is exhausted.</li> </ul>	<ul style="list-style-type: none"> <li>• Change channels.</li> <li>• Recharge the battery pack.</li> </ul>	p. 12 p. 25
The displayed channel cannot be selected.	<ul style="list-style-type: none"> <li>• Lock function is activated.</li> </ul>	<ul style="list-style-type: none"> <li>• Push [F], then push [7 (KEY LOCK)].</li> </ul>	p. 10
Scan does not start.	<ul style="list-style-type: none"> <li>• All memory channels are not programmed as "TAG" channels.</li> </ul>	<ul style="list-style-type: none"> <li>• Set the "TAG" settings of desired channels.</li> </ul>	p. 16
No beep sounds.	<ul style="list-style-type: none"> <li>• Beep tones turned OFF.</li> </ul>	<ul style="list-style-type: none"> <li>• Push [F], then push [8 (BEEP)] to adjust the beep tone level.</li> </ul>	p. 9

# 10 SPECIFICATIONS

## ◇ General

- Frequency coverage (MHz): TX 118.000 to 136.975  
RX 108.000 to 136.975\*1  
WX 161.650 to 163.275\*2
- \*1: IC-A23 only, IC-A5; 118.000 to 136.975
- \*2: U.S.A. version only.
- Mode : 6K00A3E  
16K0G3E (161.65. to 163.275 MHz)
- Number of memory channels : 200 (10 BANK x 20 CH)
- Acceptable power supply : 9.6 V DC nominal  
(negative ground) (authorized battery packs)
- Usable temp. range : -10°C to +60°C (+14°F to +140°F)
- Frequency stability : ±17 ppm (-10°C to +60°C)
- Current drain :
  - Tx 1.8 A (CW) max.  
1.1 A (CW) typical
  - Rx 70 mA typical (at stand by)  
500 mA max. (at AF max.)
- Antenna impedance : 50 Ω (nominal)
- Dimensions : 58(W)×107(H)×28.5(D) mm  
(projections not incl.)
- Weight (with BP-200L) : 340 g

**All stated specifications are subject to change without notice or obligation.**

## ◇ Transmitter

- Output power : 5 W (PEP) typical  
1.5 W (CW) typical
- Modulation : Low level modulation
- Modulation limiting : 70 to 100 %
- Audio harmonic distortion : Less than 10 %  
(at 60 % modulation)
- Hum and noise ratio : More than 35 dB
- Spurious emissions : More than 60 dB
- Microphone impedance : 150 Ω

## ◇ Receiver

- Receive system : Double conversion  
superheterodyne
- Intermediate frequencies : 1st 30.05 MHz  
2nd 450 kHz
- Sensitivity (AM 6dB S/N) : Less than 0dBμ  
(FM 12dB SINAD): Less than 0dBμ
- Squelch sensitivity (AM) : Less than -3dBμ  
(FM) : Less than -13dBμ
- Selectivity : 7.5 kHz (at 6 dB) or more  
25 kHz (at 60 dB) or less
- Spurious response : More than 60 dB
- Audio output power : 500 mW (at 10% distortion  
(at 9.6 V DC) with an 8 Ω load)
- Noise and hum : More than 25 dB
- External SP connector : 3-conductor 3.5 (d) mm / 8 Ω

## ◇ Battery packs

Battery pack	Voltage	Capacity	Charging period		Operating period <sup>*1</sup>
			Wall charger	BC-119 or BC-121 with AD-88	
BP-200L	9.6 V	760 mAh	15 hrs	1.5 hrs	6 hrs

\*1 Operating periods are calibrated for the following conditions:  
at 25°C (77°F), Tx (high power) : Rx : standby = 5 : 5 : 90

## ◇ Other options

**BC-110A** WALL CHARGER (same as supplied. Depends on version)

Used for regular charging of the connected battery pack.

**BC-119** DESKTOP CHARGER + **AD-88** CHARGER ADAPTOR

For rapid charging of battery packs. An AC adapter is supplied with the charger. Some BC-119 versions require the AD-87 additionally. Charging time: 1.5 to 2 hrs.

**OPC-254L** DC POWER CABLE

For operation and charging via an external power supply.

**CP-12L** CIGARETTE LIGHTER CABLE WITH NOISE FILTER

For operation and charging via a 12 V cigarette lighter socket.

## **OPC-967** HEADSET ADAPTER

When using an optional headset, such as those from the David Clark Co. via the adapter, the transceiver outputs your transmitted voice to the headset for monitoring. (p. 9)

## **CS-A23** CLONING SOFTWARE

Provides quick and easy programming of items, including private channels, scan settings, etc., via an IBM® compatible PC to transceiver.

## **OPC-474** CLONING CABLE

Cloning cable for transceiver to transceiver cloning.

## **OPC-478** CLONING CABLE

Cloning cable for PC to transceiver cloning.

# 11 OPTIONS

## ◇ OPC-967 (HEADSET ADAPTER) connection

When using an optional headset, such as those from the David Clark Co. via the adapter, the transceiver outputs your transmitted voice to the headset for monitoring. (p. 9)

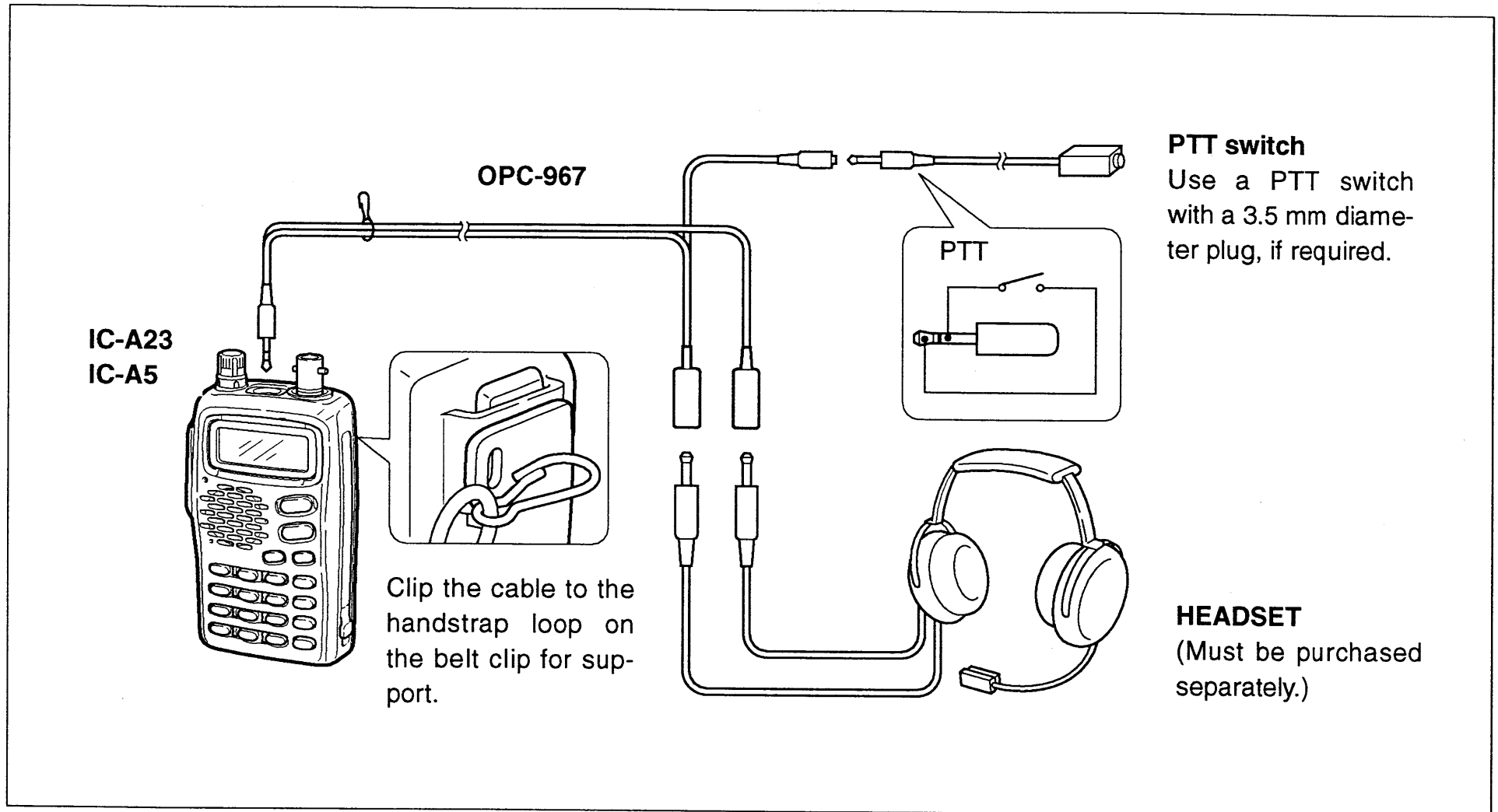

# QUICK REFERENCE 12

Important operating instructions are summed up in this and the following page for your simple reference.

By cutting along the line and folding on the dotted line, it will become a card sized operating guide which can easily be carried in a card case or wallet, etc.

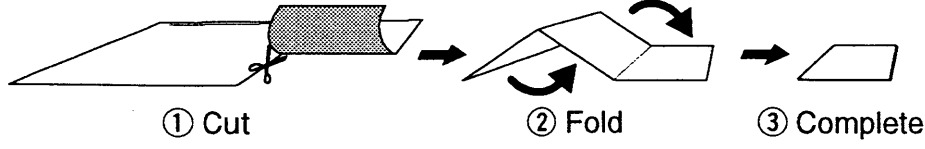

◀CUT HERE▶

## ■ CHANNEL SELECTION (pgs. 8, 12)

### • DIAL ↔ [▲]/[▼] trade function

Push [F], then push [CLR (DIAL/▲▼)] to trade each function.

#### Default:

DIAL: • Setting the frequency, • Selecting the memory channel, • Selecting the BANK number

[▲]/[▼]: • Adjusting the audio level

### • Using Key pad

- 1 Push [CLR] to select the frequency mode when memory CH or WX CH\* appears on the display.
- 2 Push 5 appropriate digit keys to input the frequency.

- Enter [1] as the 1st digit.
- Only [2], [5], [7] and [0] can be entered as the 5th and final digit.
- Push [CLR], when a digit is mistakenly input.

### • Using [DIAL]

- 1 Push [CLR] to select the frequency mode when memory CH or WX CH\* appears on the display.
- 2 Rotate the [DIAL] to select the desired frequency.
- 3 Push [F], then rotate the [DIAL] to select the 1 MHz tuning step. Push [F] to cancel the function.

### • Memory BANK/CH selection

- 1 Push [MR] to enter the memory CH mode.
- 2 Push [BANK] to select the desired BANK number. (BANK 0 to 9)
- 3 Push [BANK] or [CLR] to exit the BANK selection mode.

## ICOM OPERATION GUIDE IC-A23/A5

### ■ BEGINNING OPERATION

#### • Turning the power ON.

- 1 Push [PWR] for 0.5 sec. to turn the power ON or OFF.
- 2 Push [SQL], then push [▼] several times to adjust the squelch level '0'. Push [SQL] to exit the squelch set mode.
- 3 Push [▲]/[▼] several times to adjust the desired audio level.
- 4 Push [SQL], then push [▲] several times to adjust the squelch level.

## ■ MEMORY (p. 13)

### • Memory programming

- ① Push [CLR] to select the frequency mode or push [F], then push [ENT (WX)] to select WX CH\* mode.
- ② Select the desired frequency or WX CH\*.
- ③ Push [F], then push [MR (MW)] to enter memory programming mode.
  - "M" blinks on the display.
- ④ Rotate [DIAL] to select a desired memory CH number.
  - Push [BANK], then select the BANK number if desired. Push [BANK] to exit the BANK selection mode.
- ⑤ Push [ENT] to program the memory contents.

### • Transferring memory contents

- ① Push [MR] to enter memory mode.
- ② Select the desired channel to be transferred.
- ③ Push [F], then push [MR].
  - BANK number and memory CH number disappears as frequency mode is automatically selected and the memory contents are transferred.

## ■ KEY LOCK FUNCTION (p. 10)

- ① Push [F], then push [7 (KEY LOCK)] to turn the key lock function ON.
  - " " appears on the display.
- ② Push [F], then push [7 (KEY LOCK)] to turn the keylock function ON.

## ■ SCAN (p. 16)

- ① Push [CLR], [MR] or [F], then [WX]\* to select the frequency, memory or WX CH\* mode.
- ② Push [F], then push [SQL (SCAN)] to start scanning.
  - Decimal point blinks during scanning.
  - Rotate the [DIAL] to change the scanning direction.
- ③ Push [CLR] to cancel the scanning.

## ■ TAG CHANNELS (p. 17)

- ① Push [MR] to select the memory mode.
- ② Push [F], then [9 (TAG)] to turn the channel "TAG" ON and OFF.

\*WX CH available U.S.A. version only.

**Count on us!**

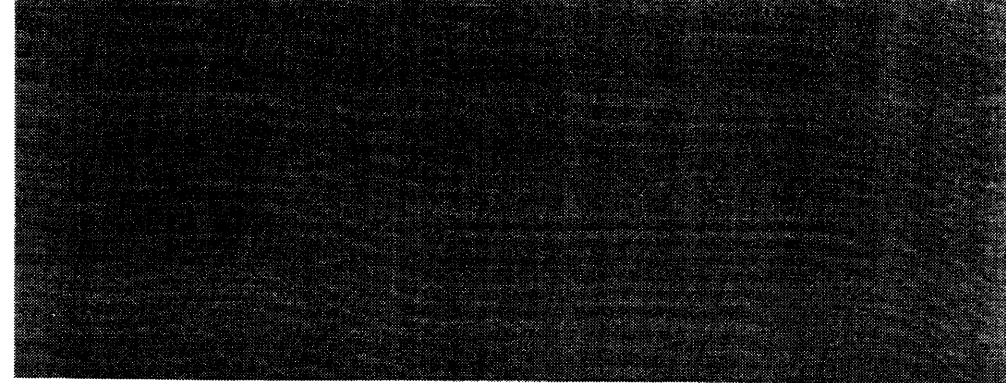

A-5665H-1EX-①  
Printed in Japan  
© 2000 Icom Inc.

**Icom Inc.**  
1-1-32 Kamiminami, Hirano-ku, Osaka 547-0003 Japan