

IC-AH1

HF FIVE BAND MOBILE ANTENNA

INSTRUCTION MANUAL



TABLE OF CONTENTS

INTRODUCTION	1
FEATURES	1
SPECIFICATIONS	1
PARTS DESCRIPTION	2
MOUNTING THE ANTENNA	3
MATCHING BOX INSTALLATION.....	4
HOOKUP AND ADJUSTMENT	4
SCHEMATIC DIAGRAM.....	11
SWR PLOTTING CHARTS.....	12

INTRODUCTION

This mobile antenna, the IC-AH1, has been especially developed by ICOM for use with ICOM's IC-701, IC-720 (with LDA Unit installed) and IC-720A. The design concept of the antenna is new, and the antenna covers 5 bands.

The antenna is made up of a matching box with a rotary relay switch and loading coil inside it, which is intended to be mounted inside the trunk of the car. With this configuration, the IC-AH1 provides automatic band switching when the transceiver is switched. The antenna employs a bumper mount.

FEATURES

- * Change of bands accomplished by switching the transceiver's band switch only.
- * Single element for all bands, 3.5MHz to 28MHz.
- * Large diameter loading coil with steatite bobbin for reduction of loss.
- * Antenna element made of SUS-631 stainless steel, the same material used for propellor shafts on ships, for protection against erosion, and excellent spring characteristics.
- * Epoxy plastic insulator at the base of the element for high protection against shock and low power loss.

SPECIFICATIONS

Frequency Range	: 3.5MHz, 7MHz, 14MHz, 21MHz, 28MHz
Maximum Input Power	: 120 Watts PEP
VSWR	: Less than 1.5 at resonant point of each band
Weight	: Matching box approx. 2.6 kgs Element approx. 2.0 kgs
Dimensions	: Element – 2.5 meters Matching box – 130(H) x 130(W) x 300(L) mm not including mounting brackets

Supplied with the antenna are the following:

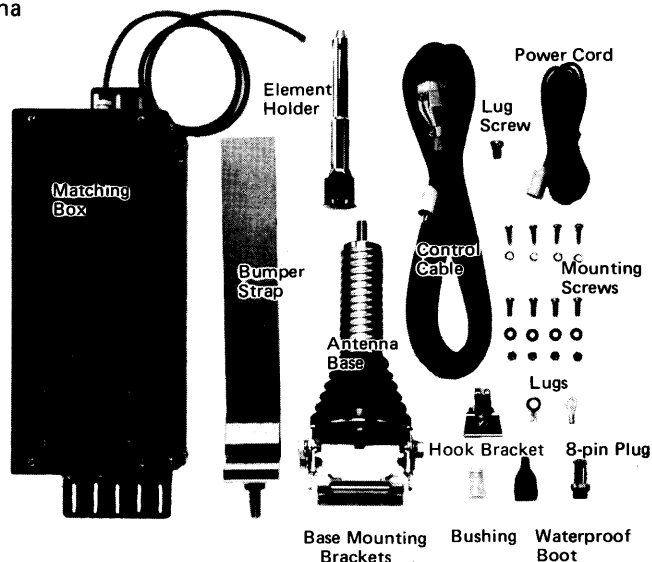

PARTS DESCRIPTION

■ ANTENNA ELEMENT

■ MATCHING BOX

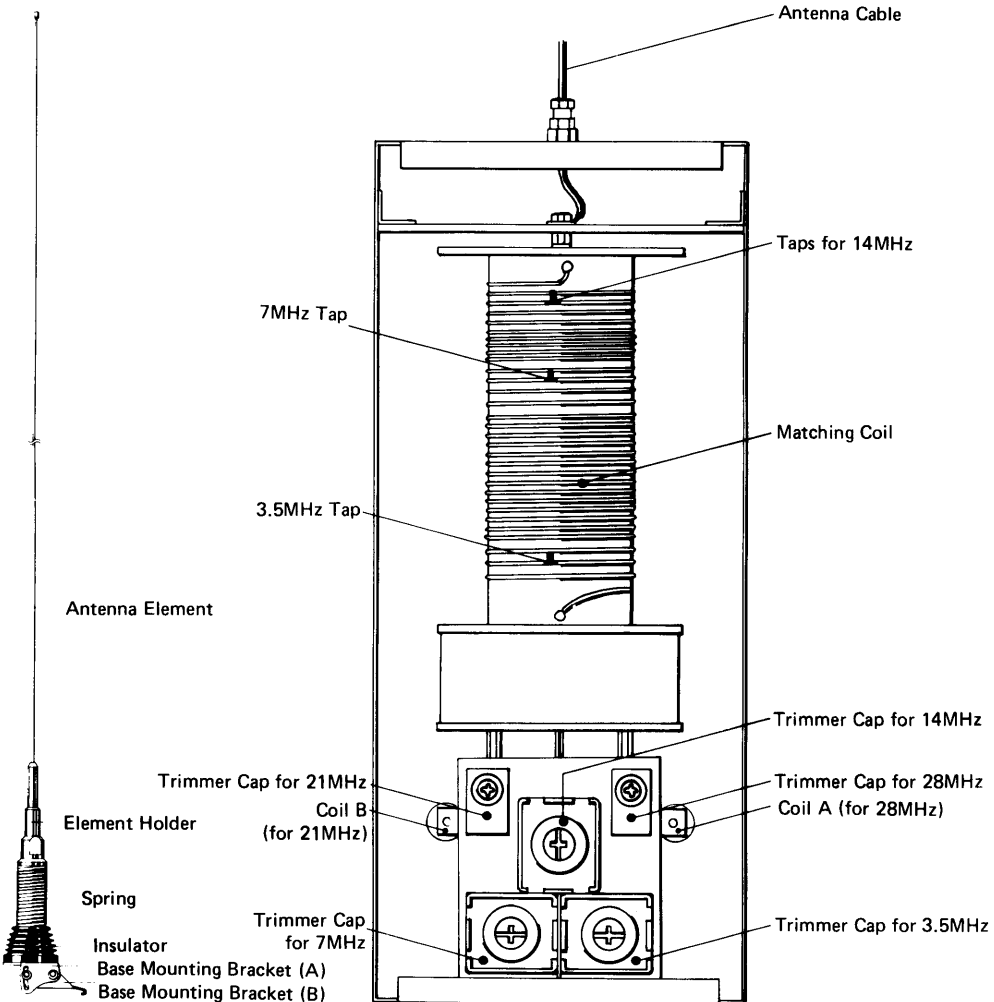

MOUNTING THE ANTENNA

- The following should be taken into consideration when selecting a location for the antenna:
 - Make sure that you do not block taillights, etc, with the antenna.
 - Insure that the antenna will not block the opening of the trunk.
 - Select a position as close as possible to the bumper mounting bracket.
- After the position has been selected, mark the location with a marker pen, or chalk, and assemble the hardware.

- Run the bolt on the bottom of the bumper strap (C) through the hole in the bumper hook (D), slide on the spacer (E), and put the nut (F) on the bolt, run the nut up so that approximately 1/8 inch of the bolt protrudes through the nut.

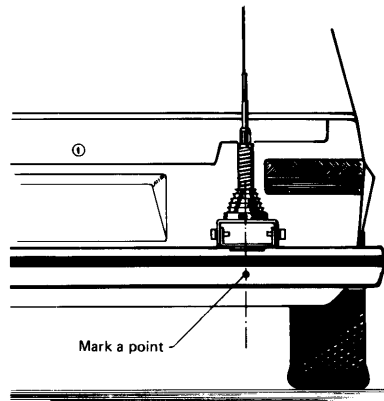
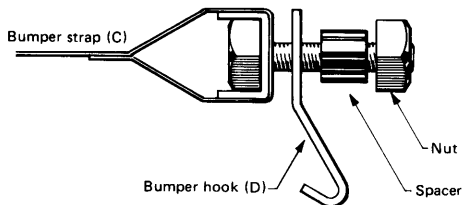

- Hook the bottom bumper hook (D) to the bottom edge of the bumper and run the flat bumper strap (C) alongside the bumper and over the top, mark the strap 1-1/4 inches (3cm) back from the edge nearest the car body, then remove the hook from the bumper.

- Slide the bumper strap (C) through the slot of the antenna base mounting bracket (B), as shown and bend it at the marked point back 180 degrees. Hook both hooks, upper and lower, to the bumper so the flat strap fits closely to the bumper. If the lower hook cannot be hooked, loosen the nut until sufficient slack is left to hook to the bumper.

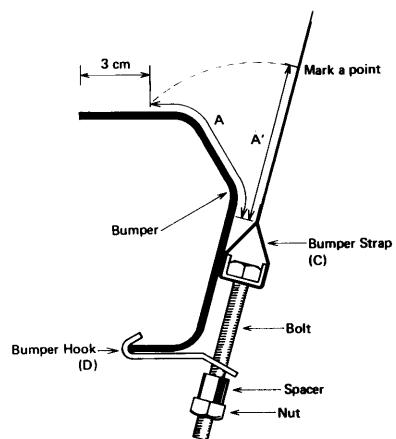
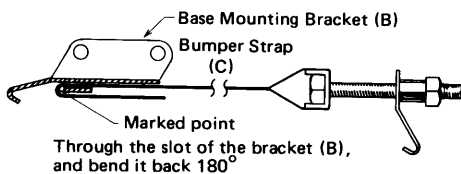

- Make sure that the antenna base mounting bracket (B) is centered and that the bumper strap (C) and bottom bumper hook (D) are aligned, then tighten the nut on the bottom of the bumper strap until the assembly is firmly mounted. Attach the second nut to the bolt as a locking nut, this will prevent the mounting loosening from vibration when the car is driven.

MATCHING BOX INSTALLATION

LOCATION

The unit should be installed along the side of the trunk as close as possible to the antenna mounting.

1. Drill through the trunk floor four mounting holes for the matching box. If you are going to use the self-tapping screws the holes should be 4mm, if you are going to use the bolts with the nuts installed under the trunk the holes should be 6 ~ 7mm.
2. Drill a hole 13mm for the antenna cable at the antenna end of the matching box as shown below. Since a good ground is needed do not use insulators between the matching box and the trunk floor; it is a good idea to remove heavy paint if it exists between the mounting legs of the matching box and the trunk floor.
3. At the end of the matching box opposite the antenna hookup there is a ground lug. Run a #8 or larger wire to the nearest mounting bolt, solder the wire/lug connection. Check with a multi-meter on the Rx1 ohms scale to insure the resistance is low. If the ground is not good it will affect the performance of the antenna and cause its efficiency to drop. If the bumper itself has a rubber shock mount, check to insure that a good connection is made between the frame of the car and the bumper, if necessary install heavy wire to achieve this.

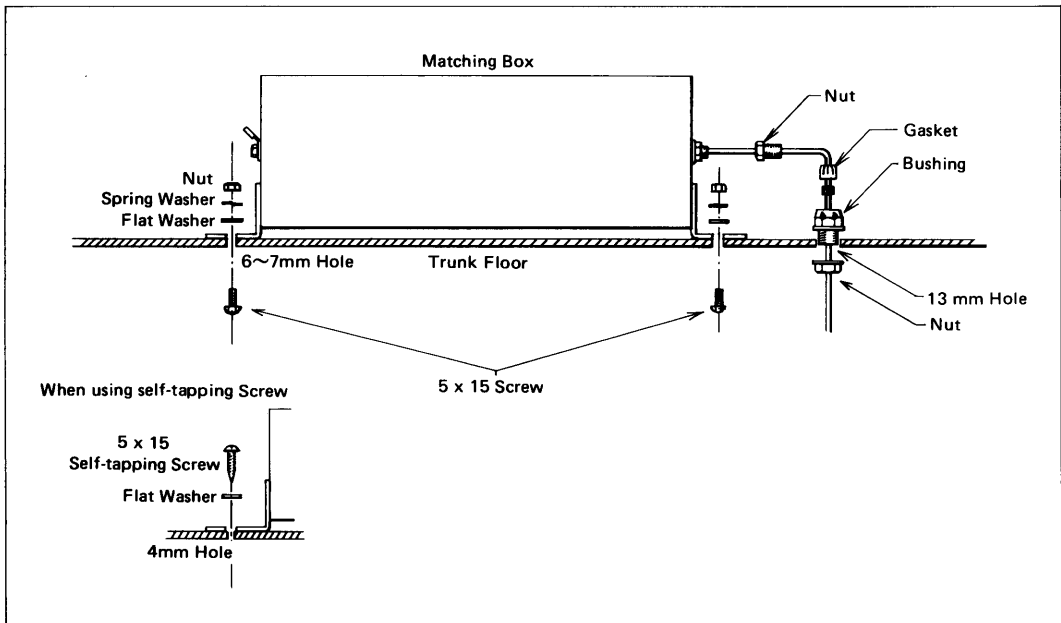

HOOKUP AND ADJUSTMENT

1. Slide the cable bushing, gasket and nut onto the cable leading out of the matching box, out the hole previously drilled in the trunk floor. This cable is 90 centimeters long and it is important that it's length not be changed, its length is part of the antenna design.
2. Run the cable out to the antenna mounting base. Slide the waterproof boot on to the cable,

and strip the outer rubber insulation back about 3/4 of an inch. Strip the white inside insulation back about 3/8 inch and solder the wire to the ring lug. Mount the wire to the base of the antenna insulator as shown below, with the Philips head screw provided, and tighten firmly. Check to see that the cable does not run near the exhaust pipe, or parts that will move when the car is driven. Run the waterproof boot up to cover the ring lug and Philips head screw.

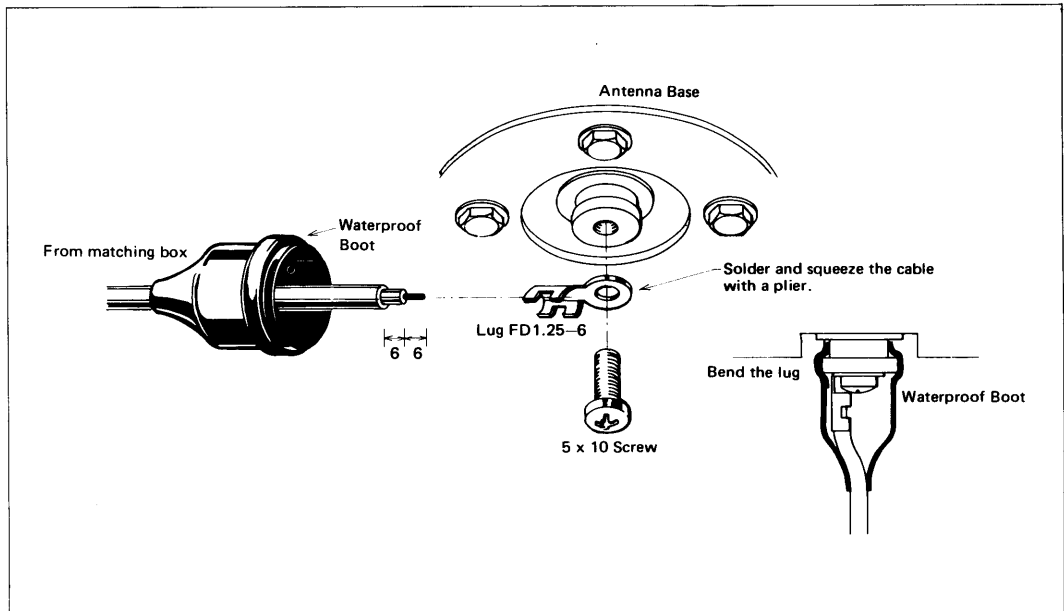

3. Pull the excess cable back into the trunk and leave it coiled near the matching box. Now tighten the cable bushing and see that the cable is clear.
4. At the sides of the antenna base mount there are four bolts; after the foregoing is accomplished insert the element holder (G) and screw it down firmly, insert the antenna element into the holder until it bottoms (13 ~ 14cm) and use the Allen wrench provided to tighten it in the holder. Adjust the four bolts until the element is 90 degrees to the ground plane, perfectly vertical.

Make a final check that all connections are firm and solid.

TRANSCEIVER AND MATCHING BOX HOOKUP

1. Coaxial cable has not been included with the antenna, as every installation will be different. Run the control cable and the coax to the rear of the transceiver with sufficient slack left in both to easily slide the transceiver out if it is dismantled from the car.
2. The control cable has a 24-Pin plug and a 2-Pin power plug. Plug the 24-Pin plug into the Accessory Socket of the transceiver. Connect the power cable to a good 12V DC source. Run the control cable and coax back to the trunk, making sure that neither is stretched tight at any place in the car, leave slack along their lengths. Measure the length need for the control cable and cut it if you wish, it will not affect the operation of the matching box if a coil is left in the trunk. Do not leave coils of coax in the trunk. Make sure the 24-Pin plug and the 2-Pin power plug are both not connected, and solder the control cable to the 8-Pin plug as shown. Check the soldered connections carefully to make sure that there are no shorts or cross-connections.

Lead Color	24-Pin Plug Connection	8-Pin Plug Connection	Remarks
Black	Pin 8	Pin 1	Ground
Orange	2	2	13.8V
Blue	12	3	Band Switching Reference Voltage
Yellow	13	4	Band Switching Signal
White	3	5	T/R Switch
Red	(Ext Pwr Plug +)	6	Ext 13.8V +
Brown	(Ext Pwr Plug -)	7	Ext 13.8V -
Green	(Spare)	8	NC

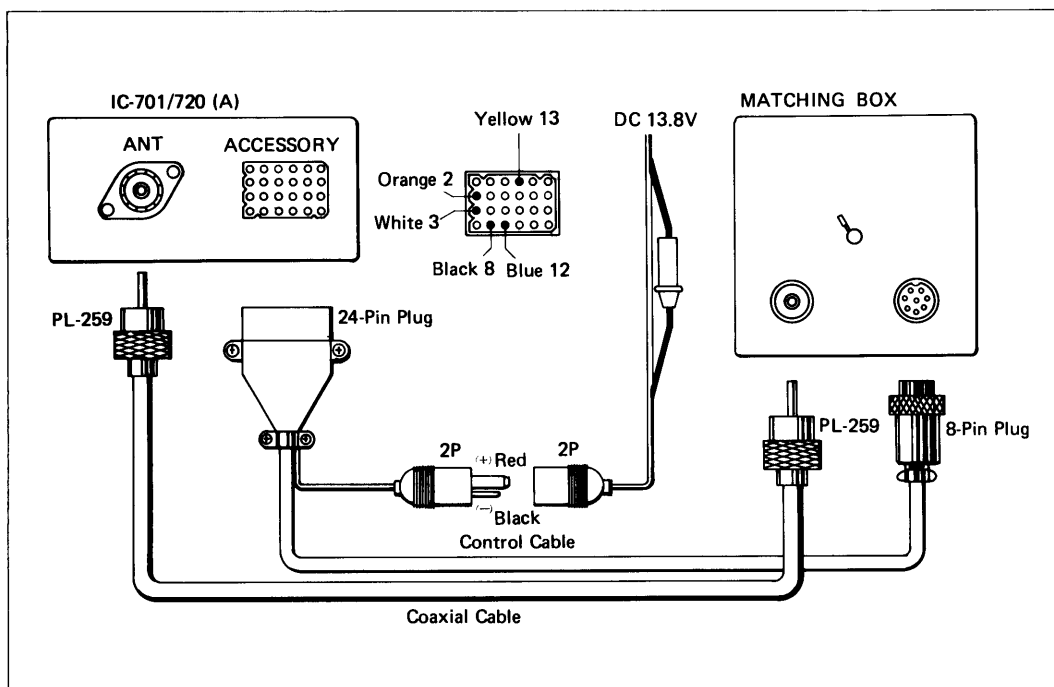
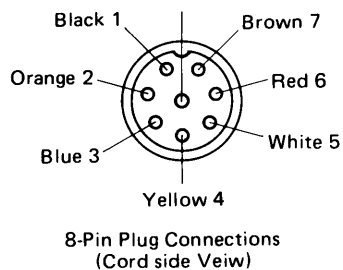

3. Plug all plugs in and make sure the connections are firm.

OPERATION TEST

Set the Band Select Switch of the IC-701 to 3.5MHz and turn the Power Switch on. When the Band Select Switch is turned to another band you will hear the rotary relay in the Matching box operate. In the case of the IC-720/720A you will hear the relay activate immediately upon pushing the Power on button. If the relay does not operate in either case shut off the power and check the connections, particularly the control cable. The relay should operate three times when the IC-701 is turned from 3.5MHz to 7MHz, and three times when the IC-720's/720A's Power button is pushed. When the reverse is done (7MHz to 3.5MHz) you should hear the relay in the matching box operate nine times.

TUNING PROCEDURE

This antenna is built with taps on the matching coil for the various bands, and trimmer capacitors for tuning. Exercise great care during the tuning procedures. Do not change the length of the lead

from the matching box to the antenna, or the length of the element. During transmit do not touch the element. Put the car in an open space with the nearest objects outside of a 5m (16 feet) radius. Keep transmitting time to as short a time possible during tuning. It will be much easier to tune the antenna if two persons perform the tuning. Make sure the trunk lid does not touch the element.

1. Since each car is different in it's wiring and conditions tuning must be done. Put a SWR Meter in the line as shown below.

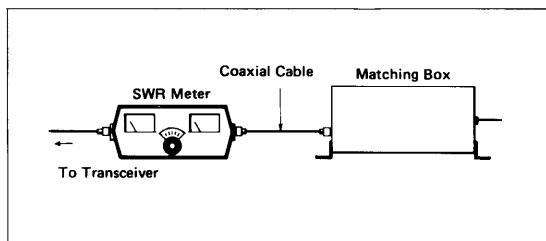

2. Remove the top cover of the matching box.
3. When tuning it is possible that much better SWR can be achieved by moving the tap on the loading coil. If adjusting the trimmer capacitors does not change the SWR significantly the tap should be moved.
4. After the initial tuning is performed the SWR can be easily adjusted at a later time without removing the tap cover.
5. If it is necessary to move one or more of the taps, it will make the job easier if you loosen Nut C and Bolt B, the matching coil bobbin can then be turned, for more convenience while soldering. If this is done, make sure you do not kink any of the wires when turning the bobbin, and when returning it to the original position. Be sure to tighten A, B, and C firmly when finished.
6. **DO NOT TRANSMIT WHEN THE BOBBIN IS LOOSE.**

28MHz TUNING

1. Put the IC-701 or IC-720A, in the RTTY mode, and select 28MHz. Tune to the center of the band, with no signal present. Switch to transmit.
2. Using a non-conductive tuning tool adjust the 28MHz trimmer (Refer to page 2) for the lowest SWR ratio.

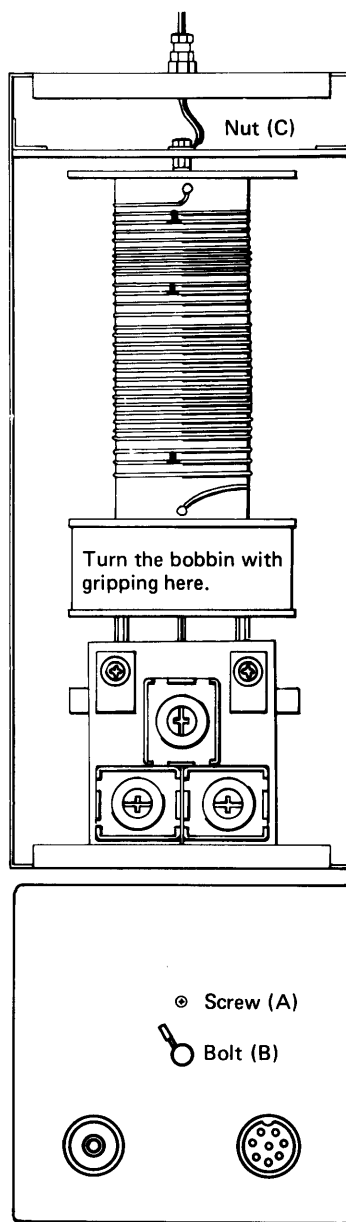

3. Tune to at least five positions across the band and tune for the lowest SWR ratio.
4. If you cannot achieve at least 1.5 VSWR in all five positions, you must move Tap of the coil A.

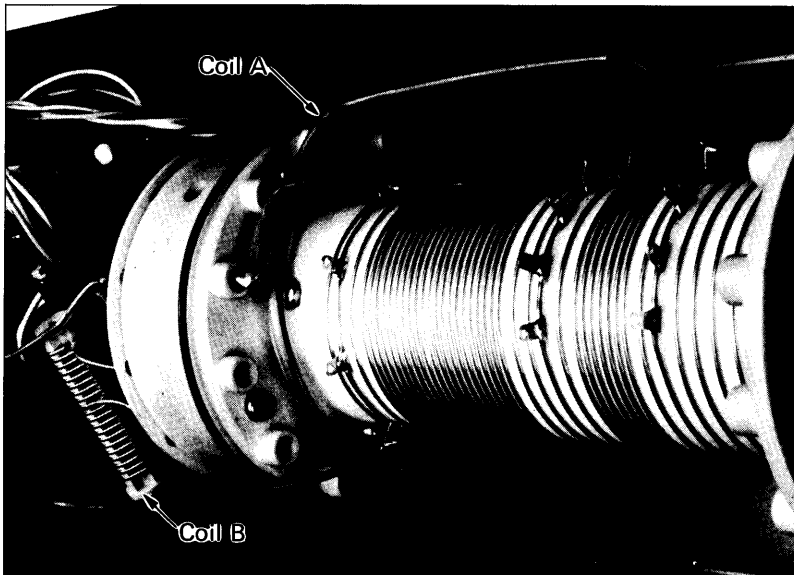

5. If the lowest VSWR readings occur at a frequency higher than the center of the band, decrease the tap one turn, and at a frequency lower, increase the tap one turn.
6. After soldering the tap, repeat the above steps to achieve the best VSWR reading.

NOTE: Coil A is used as a compensator for 28MHz (coil B for 21MHz), and thus the tap may have to be moved for these frequencies.

21MHz TUNING

1. Place the set in the RTTY Mode and select 21MHz, the relay will automatically move 11 steps. Tune to the center of the band with no signal present, put the set in transmit.
2. Align the same as for 28MHz, but if the tap must be moved, in this case it is Coil B.

14MHz TUNING

1. Since 14MHz is a narrow band it is best to select the center of the portion you use most.
2. Using the 14MHz trimmer (Refer to page 2) set the VSWR for the lowest reading.
3. If you cannot get a low VSWR reading by adjusting the trimmer, loosen Bolt B and Nut C again, and turn the coil bobbin so the 14MHz tap is visible and move the tap except that in this case you should move the tap only a short interval, then try for a low reading using the trimmer. If necessary move the tap again, but keep the distance of movement small. When the best point is found, solder the tap to the coil.

4. If the tap wire proves to be too short and it cannot be soldered to the coil without the original configuration install a new lead, using the lead wire provided in the accessories. Do not run the tap wire tightly to the connection, maintain the curves in the lead.

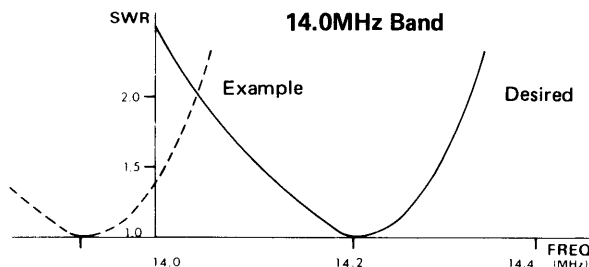

In this case, the antenna resonates lower frequency than desired one, thus decrease the inductance of the matching coil.

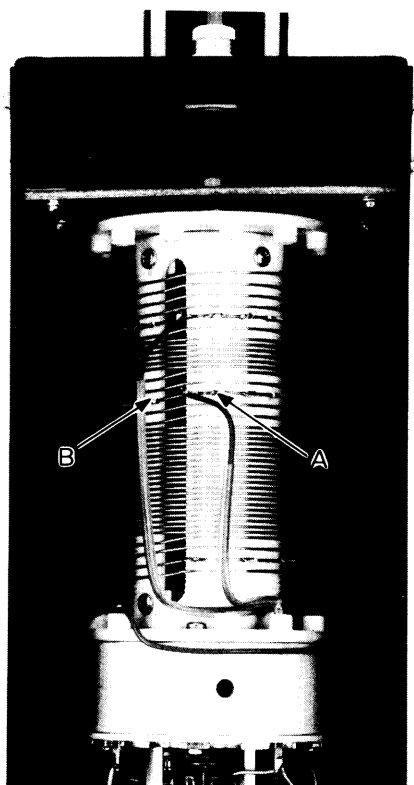

When moving the tap to the A position, the inductance will be decreased (resonant frequency will be raised).
When moving the tap to the B position, the inductance will be increased (resonant frequency will be lowered).

7MHz TUNING

Tune using the above procedures, using the 7MHz trimmer. (Refer to page 2.)

3.5MHz TUNING

Tune using the above procedures, using the 3.5MHz trimmer. (Refer to page 2.)

NOTE: When moving tap across the band, to achieve the best VSWR, move in steps as follows:

- 14MHz ~ 80KHz steps
- 7MHz ~ 25KHz steps
- 3.5MHz ~ 10KHz steps

Below 14MHz when fine-tuning the center of the frequency a finer tune can be accomplished by changing the curve of the tap wire (more or less curve) until the best VSWR is reached.

FINAL CHECK

After alignment is completed, check 28MHz to 3.5MHz for a final time. If the VSWR is not good at any point repeat the tuning steps for that frequency.

ELEMENT HOLDING HOOK

When driving through low-clearance areas, such as under passes, inside parking lots, etc, the antenna element can be bent over and hooked as shown.



SWR vs Frequency (After alignment)

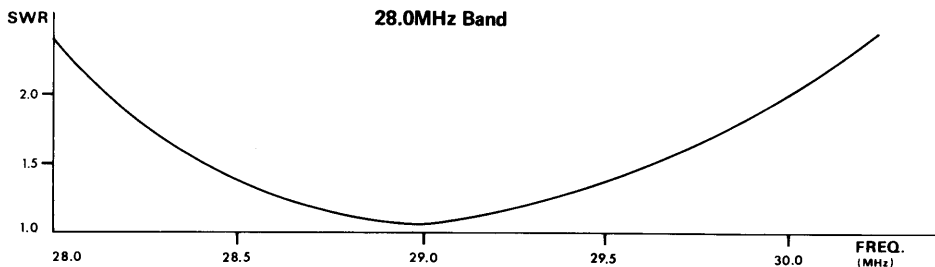
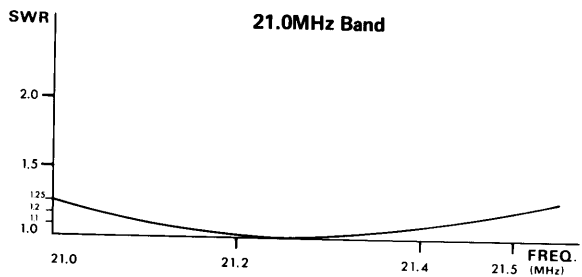
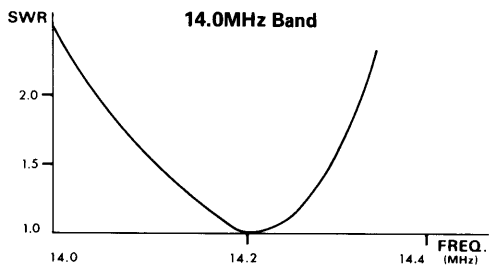
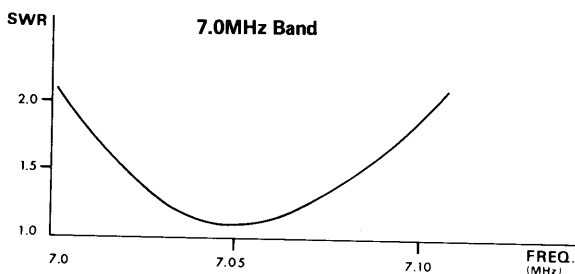
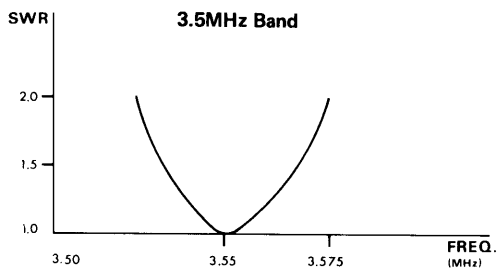

SCHEMATIC DIAGRAM

IC-AH1 SCHEMATIC DIAGRAM

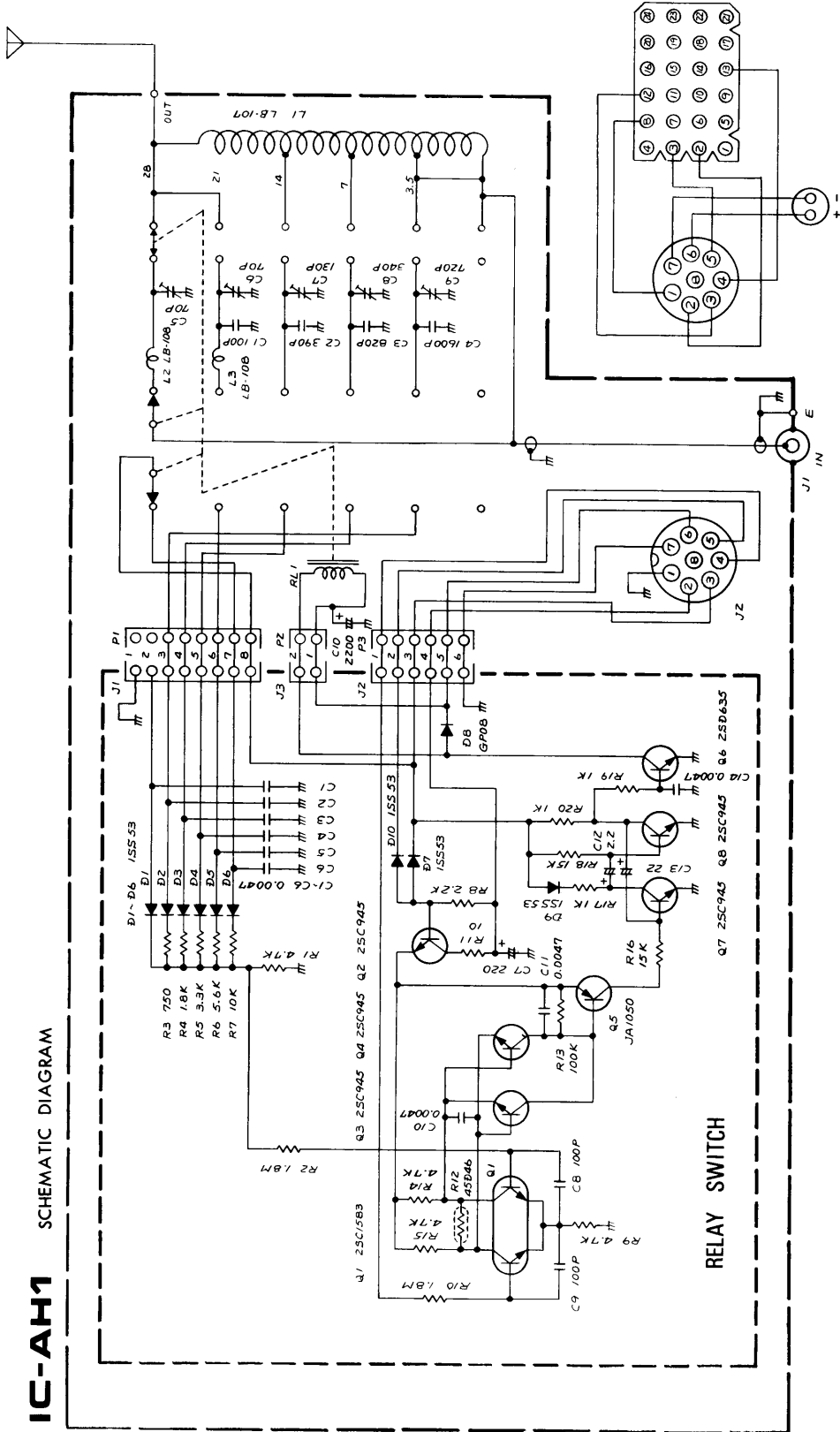

SWR PLOTTING CHARTS

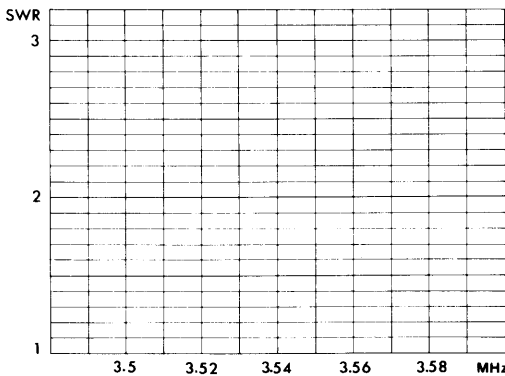
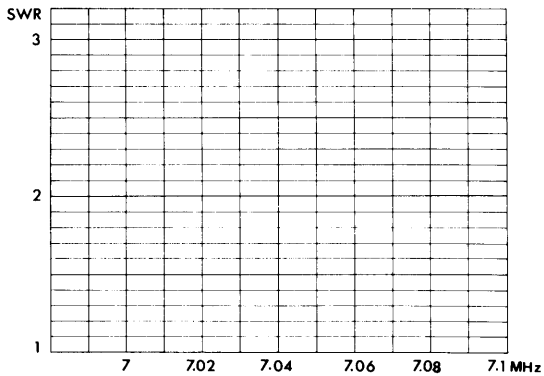
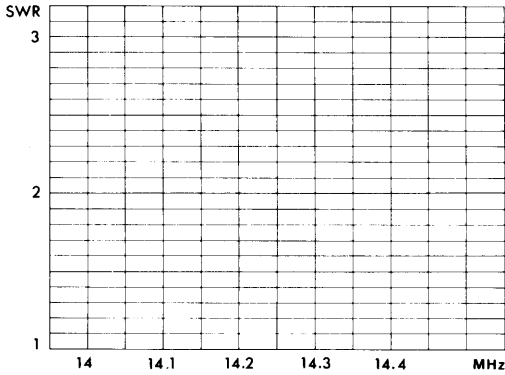
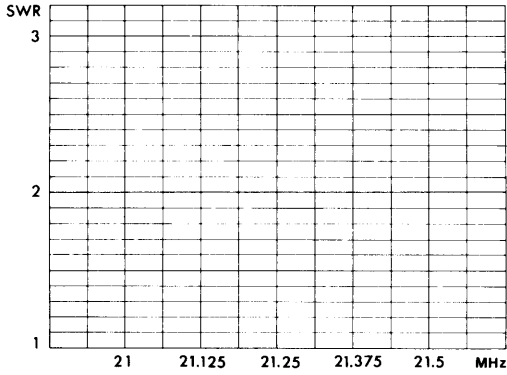
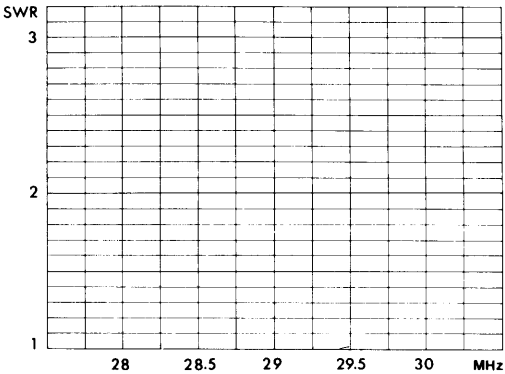



ICOM INCORPORATED

1-6-19, KAMI KURATSUKURI, HIRANO-KU,
OSAKA JAPAN