

# CT-10

## COMPUTER INTERFACE/TERMINAL UNIT

Radio mods manuals  
K B2LJJ

### INSTRUCTION MANUAL



## TABLE OF CONTENTS

I. SPECIFICATIONS .....	1
II. FEATURES .....	1
III. PARTS IDENTIFICATION .....	2
IV. INSTALLATION AND CONNECTION .....	5
V. OPERATION .....	10
VI. TECHNICAL INFORMATION .....	12
VII. BLOCK DIAGRAM .....	17
VIII. SCHEMATIC DIAGRAM.....	SEPARATE

## SECTION I SPECIFICATIONS

### GENERAL

Numbers of semiconductors	:	Transistor	3
		IC	40
		Diode	12
Power supply requirement	:	117V/220V/230V AC $\pm 10\%$	
Dimensions	:	110(120)mm(H) x 180mm(W) x 290(310)mm(D)	
		( ) : Shows the dimensions including projections.	
Weight	:	Approx. 3.5kg	

### RTTY TRANSMITTING

FSK Control	:	TTL Level (Polarity reversible)	
AFSK	:	MARK Frequency	2125Hz
		SPACE Frequency	2295Hz (170Hz Shift)
			2550Hz (425Hz Shift)
			2975Hz (850Hz Shift)
		(Computer commands selectable)	
RTTY Code	:	ASCII or BAUDOT (Commands selectable)	
Baud Rate	:	45 baud or 50 baud (Command selectable)	

### RTTY RECEIVING

MARK Frequency	:	2125Hz (fixed) or 1275Hz ~ 2975Hz (Tunable)	
SPACE Frequency	:	1275Hz ~ 2975Hz (Tunable)	

## SECTION II FEATURES

### 1. GENERAL PURPOSE SYSTEM

The EIA standard RS-232C interface is used to connect the CT-10 with a personal computer. Most commercially available personal computers can be connected.

### 2. REMOTE CONTROL FUNCTION AND RTTY TRANSCEIVE FUNCTION

The CT-10 connects a transceiver with a personal computer, allowing you to set the frequency and mode of the transceiver through a personal computer.

### 3. BUILT-IN AFSK GENERATOR

The CT-10 is equipped with a built-in AFSK generator so that you can enjoy radio teletype using an FM transceiver.

### 4. CONNECTS UP TO 4 TRANSCEIVERS

Up to 4 transceivers can be connected simultaneously to the CT-10. The required transceiver is selected by computer command.

### 5. SWITCHABLE BAUD RATE AND SHIFT

The RTTY baud rate (45.45 baud or 50 baud) and shift frequency (170Hz, 425Hz, 850Hz) can be controlled by the personal computer program so that non-amateur radio RTTY signals can also be received. Further, either Baudot or ASCII can be selected.

## SECTION III PARTS IDENTIFICATION

### FRONT PANEL

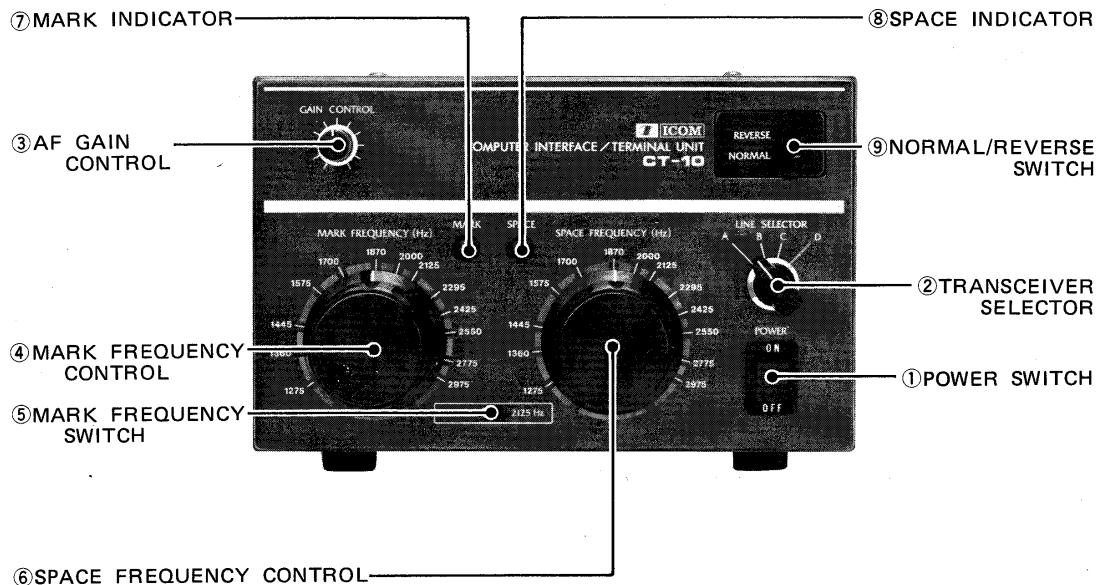

1. **POWER SWITCH:** Turns the CT-10 ON/OFF.
2. **TRANSCEIVER SELECTOR:** Selects the transceiver to be used for radio teletype (RTTY). The CT-10 is designed so that 4 transceivers can be connected to the rear panel, among which 1 can be selected for RTTY operation.
3. **AF GAIN CONTROL:** Adjusts the AF level of the received RTTY signal. The input level increases when turned clockwise.
4. **MARK FREQUENCY CONTROL:** Adjusts the mark frequency from 1275 to 2975Hz. Adjust so that the MARK indicator is brightest.
5. **MARK FREQUENCY SWITCH:** When set to "MANUAL" the mark frequency can be varied using the mark frequency control knob. When set to "2125Hz", the mark frequency is fixed at 2125Hz, the standard mark frequency used for amateur radio. At this setting, amateur radio RTTY signals can be tuned simply by adjusting the space frequency.
6. **SPACE FREQUENCY CONTROL:** Adjusts the space frequency from 1275 to 2795Hz. Adjust so that the SPACE indicator is brightest.
7. **MARK INDICATOR:** Brightest when the mark frequency is properly tuned with the mark frequency control knob.
8. **SPACE INDICATOR:** Brightest when the space frequency is properly tuned with the space frequency control knob.
9. **NORMAL/REVERSE SWITCH:** Reverses the demodulator output. When receiving an RTTY signal, this switch is used to reverse the polarity of the shift.

## REAR PANEL

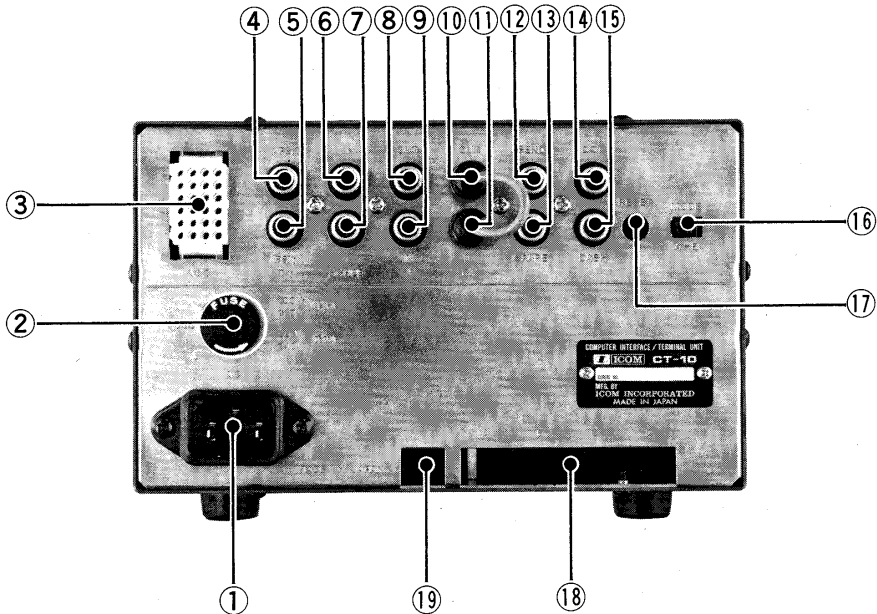

1. **AC POWER CONNECTOR:** Connector for the supplied AC power cable.
2. **FUSE HOLDER:** Holder housing the AC line fuse. The fuse rating at 117V AC is 0.3A and 220/240V is 0.2A.
3. **ACC (ACCESSORY) SOCKET:** Used during simultaneous use with ICOM HF equipment, when operating the automatic band switching function of an antenna tuner or linear amplifier. The signal for automatic band switching is output from this socket.
4. **AFSK OUTPUT JACK:** AFSK (Audio Frequency Shift Keyer) output necessary when transmitting teletype signals using audio signals. The following signals are output during transmission:
  - Mark frequency: 2125Hz
  - Space frequency: 2295Hz, 2550Hz, 2975Hz
 The space frequency is selected by a connected personal computer. (See the instruction manual for the computer program.)  
 The mark and space frequencies for transmission can be reversed by using the MODE switch (16).
5. **FSK TX (TRANSMISSION) JACK:** Output jack for FSK (Frequency Shift Keyer). Use this jack to connect to transceivers with a built-in FSK mode. The mark and space frequencies for transmission can be reversed by using the MODE switch (16).
6. **X** Oscilloscope outputs: Space and mark output jacks used to display RTTY cross patterns on an oscilloscope.
7. **Y** The X axis and Y axis are reversed by switching the normal/reverse switch on the front panel.

- 8. **SP OUT JACK:** Output jack for an external speaker.
- 9. **SP IN JACK:** AF signal input jack for the CT-10. When operating RTTY without using the ACC cable, connect the external speaker jack of the transceiver to the SP IN jack and an external speaker to the SP OUT jack.
- 10. **RX OUT (DEMODULATOR OUTPUT) JACK:** Output jack from the demodulator built into the CT-10. Usually it is connected to the RX IN (intelligent interface input) jack (11) with the supplied jumper cable. When using only the built-in demodulator, obtain the output signals from this jack.

The output is TTL compatible.

Normal    +5V during mark frequency  
             0V during space frequency

- 11. **RX IN (INTELLIGENT INTERFACE INPUT) JACK:** Input jack to the intelligent interface built in the CT-10. Usually, it is connected to the RX OUT (demodulator output) jack (10) with the supplied jumper cable. When an external demodulator is to be used, connect using this jack. The input level is TTL compatible (normally, +5V during mark frequency and 0V during space frequency).
- 12. **SEND JACK:** Jack is used to switch the transceiver to the transmit mode. Connect to the PTT line of the transceiver. The transmit/receive switching is controlled by the personal computer.  
 The jack is an open collector and can switch up to a maximum of 50V.  
 To switch voltages higher than 50V, use this switching circuit to control an external relay.
- 13. 14. 15.    SPARE jacks (not connected)
- 16. **MODE SWITCH:** Reverses the mark and space frequencies during RTTY transmission. Switch depending on your transceiver model.
- 17. **RESET SWITCH:** Resets all the functions of the CT-10.
- 18. **ACC CABLE TERMINAL:** Used when controlling the frequency of certain ICOM transceivers or receivers through a personal computer.  
 Up to four transceivers can be connected simultaneously to any of the four terminals (A, B, C, or D).  
 The voltage at this terminal (interface voltage) is switchable to either +5V or +9V with the internal switch. Switch to match the interface level of your transceiver or receiver. Note that the transceiver or receiver can be damaged if the switch is set to the incorrect level. See page 5 for details.
- 19. **DATA TERMINAL:** RS-232C standard terminal which connects to a personal computer.  
 Note that some types of personal computers can be directly connected while others require the installation of an RS-232C interface in the computer. See page 9 for details.

## SECTION IV INSTALLATION AND CONNECTION

### 4 - 1 INSTALLATION

#### Installation of the CT-10

Avoid installing the CT-10 in locations exposed to direct sunlight, high temperature, high humidity, dust, and excessive vibrations.

#### Installation of the Personal Computer

Noise will be picked up during reception if the personal computer is installed close to the transceiver. This becomes a problem especially when operating the HF bands. The following methods will aid in suppressing noise.

1. Noise Directly Picked up from the Personal Computer  
This type of noise can be reduced by grounding and shielding the personal computer. Also try to place the personal computer further away from the transceiver.
2. Noise Picked up from the Personal Computer's Peripheral Equipment  
Use shielded cable between the personal computer and the peripheral equipment. The noise can also be reduced by placing the peripheral equipment further away from the transceiver.
3. Noise Picked up Through the AC Line  
This type of noise can be reduced by separating the AC lines for the transceiver and the personal computer, and by installing a noise filter into the AC line of the personal computer.
4. Noise Picked up from the Transceiver's Antenna  
Vertically polarized antennas such as ground planes are especially susceptible to noise. Therefore, if possible, use a horizontally polarized antenna such as a dipole or Yagi antenna to reduce noise pick-up.  
Raise the antenna as high as possible.  
Ground all equipment.

### 4 - 2 LEVEL CHECKS

Before connecting the CT-10, transceiver, and personal computer, check the following items.

#### Checking the RS-232C Level of the Personal Computer

Although the EIA standard RS-232C interface is used between the CT-10 and the personal computer, there are two levels depending on the type of personal computer used:  $\pm 12V$  type and the TTL level (+5V/0V) type. Switch the personal computer interface level switch (S1) to the correct level for your computer. Switch S1 is located inside the CT-10. Note that the personal computer may be damaged if an incorrect level is selected. Refer to Section 4 - 5 for the switch location.

#### Checking the Interface Level of the Transceiver

When connecting a transceiver or receiver to the CT-10, be sure to switch the interface voltage as described below.

1. Remove the top cover of the CT-10 as shown in the figure.
2. Refer to the chart below and select the interface voltage corresponding to the transceiver (receiver) model. Using S2 ~ S5, select the proper voltage for each of up to 4 radios connected to the CT-10.

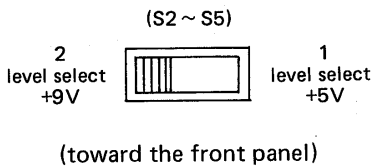
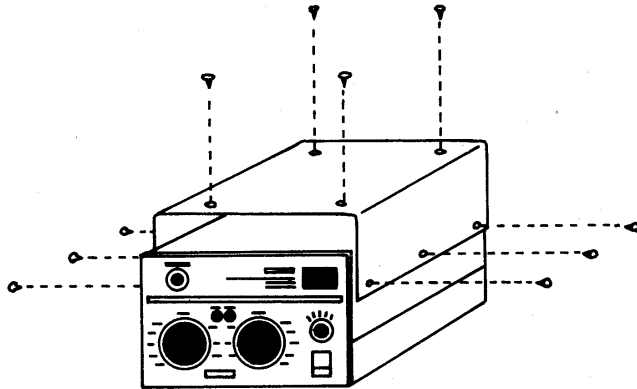

Slide to 2	Slide to 1
IC-255A/E	IC-720/A
IC-260A/E	IC-R70
IC-551/D	IC-751
IC-251A/E	IC-271A/E/H
IC-451A/E	IC-471A/E/H
IC-560	IC-R71A/E/D

**Note:** Exercise caution when switching because the microcomputer built into the transceiver or receiver may become damaged if the wrong interface voltage is selected.

#### 4 - 3 CONNECTING FOR TRANSCEIVER FREQUENCY CONTROL

In addition to RTTY operation, the frequency of ICOM transceivers with a 24-pin (and 57-40240) connector can be controlled. There are 2 types of ICOM transceivers which can be controlled: 4 bit transceivers and 8-bit transceivers.

1. 4 Bit Equipment: ICOM models IC-720/A, IC-R70, IC-560, IC-551/D, IC-255A/E, IC-260A/E, IC 251A/E, and IC-451A/E having a 24-pin connector can be connected as shown below. Two cables (1) and (2) are required. Cable (1) is used to connect the transceiver (receiver) to the CT-10. Use option cable OPC-059 for cable (1). Cable (2) is used to connect the personal computer to the CT-10. The cable used for (2) differs according to the type of computer. See section 6 - 1 on the RS-232C interface.

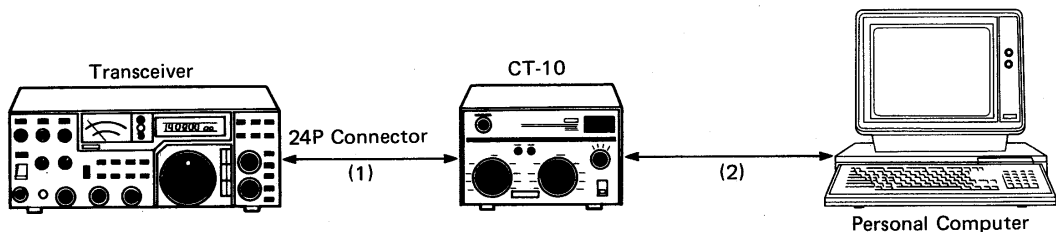



**Option cable OPC-059**

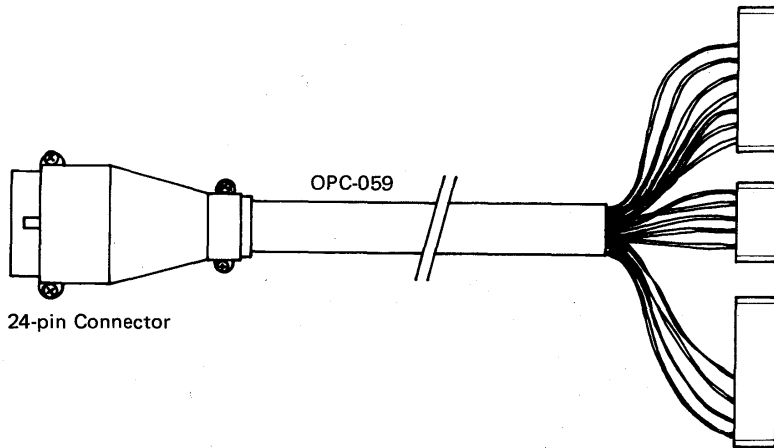

2. 8-Bit Equipment: ICOM models IC-751, IC-R71A/E/D, IC-271A/E/H, and IC-471A/E/H are connected as shown below. Two cables (1) and (2) are required. Cable (1) is used to connect between the transceiver (receiver) and the CT-10. Cable (1) is supplied as an accessory. (OPC-081 is available separately for IC-R71.) Cable (2) is used to connect the personal computer to the CT-10. The cable used for (2) differs according to the type of computer. See section 6 - 1 on the RS-232C interface.

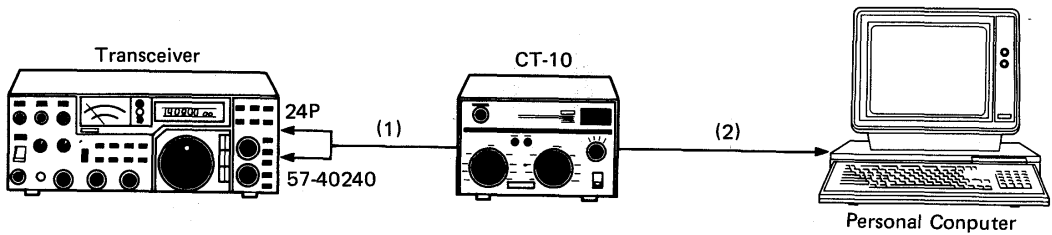

Supplied cable for cable (1).

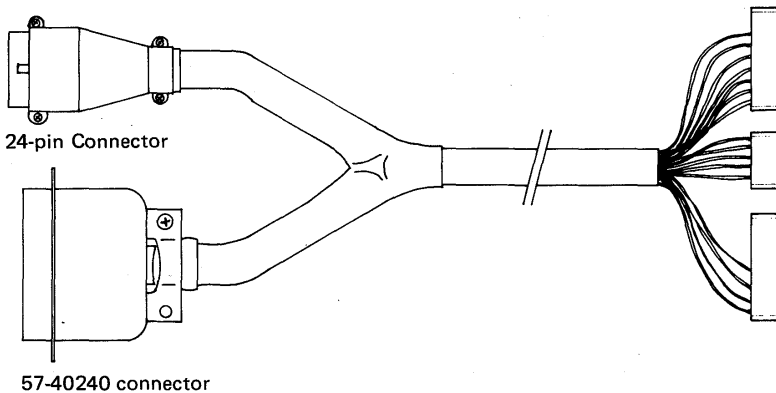

**Note:** An optional interface unit (IC-EX309) is required for all models.

#### 4-4 CONNECTING ALL OTHER TRANSCEIVERS (INCLUDING THE IC-730)

Any transceiver can be connected to the CT-10 using this method. The computer can be used for RTTY (AFSK) operation but not for frequency mode control. Four cables are required:

1. Cable to connect the MIC terminal and SEND terminal (at the MIC connector) of the transceiver to the AFSK OUT jack and SEND jack of the CT-10, respectively.
2. Cable to connect the EXT SP jack of the transceiver to the SP IN jack of the CT-10.
3. Cable to connect the SP OUT jack of the CT-10 to the IC-SP3 (or other external speaker).
4. Cable to connect the personal computer to the CT-10.

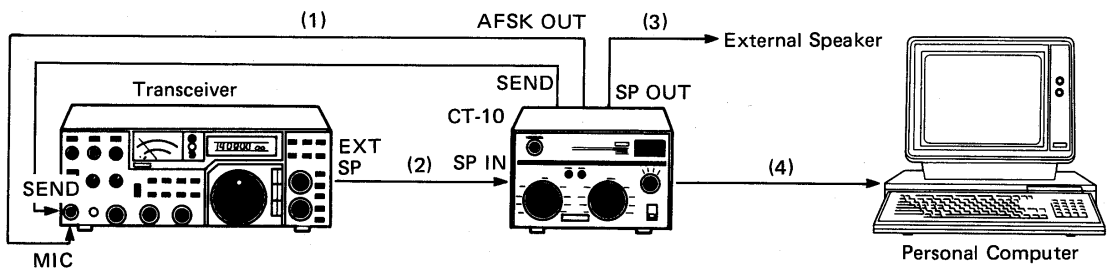

Prepare cable (1) as shown. (Or, use option cable OPC-080.)

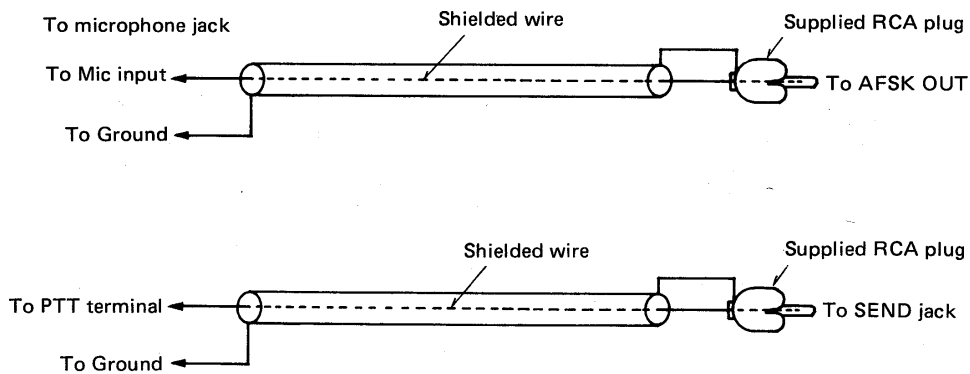

#### ICOM Microphone Jack Connections

(As seen when locking at the transceiver.)

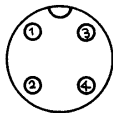

- (1) MIC input
- (2) SEND (PTT)
- (4) Ground

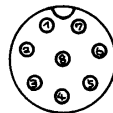

- (1) MIC input
- (7) MIC ground
- (5) SEND (PTT)
- (6) Ground

Prepare cable (2) as shown.

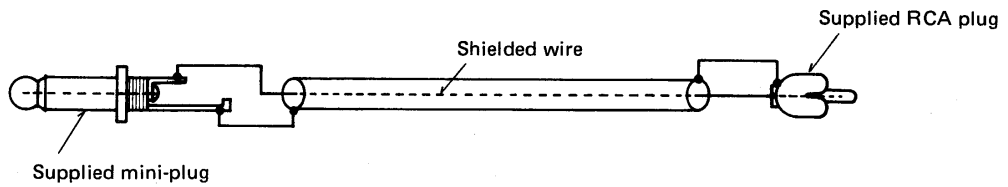

Prepare cable (3) as shown.

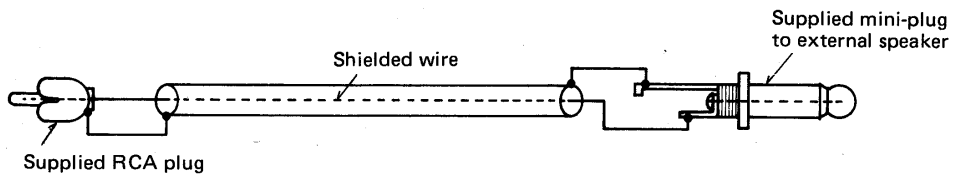

The cable for (4) differs according to the type of computer. See the section on the RS-232C interface in Chapter 6.

**Note:** Depending on the FSK circuit in the connected transceiver, FSK operation may not be possible with the CT-10 without modification of the transceiver.

#### 4 - 5 INTERNAL CONNECTORS AND SWITCHES

The connectors and switches inside the CT-10 are shown below.

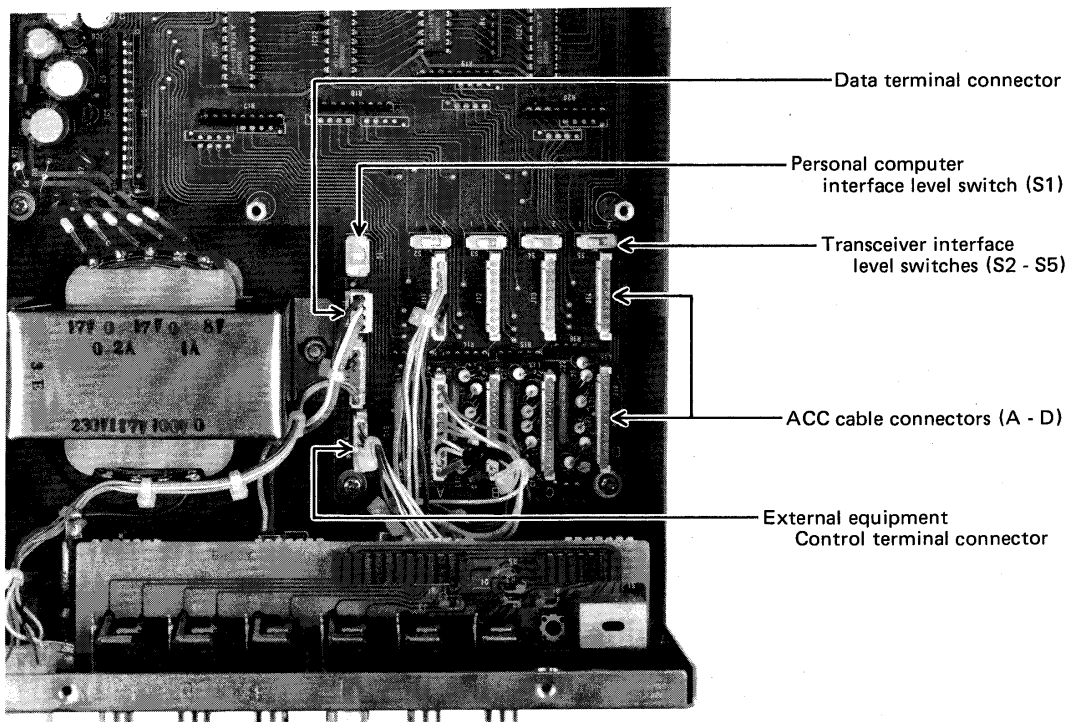

## SECTION V OPERATION

### 5-1 FREQUENCY CONTROL

#### 1 Controllable Transceivers

Equipment in which the frequency can be controlled through the CT-10 by the personal computer is currently as follows:

Frequency Range	Equipment
HF	① IC-720/A ② IC-R70 ③ IC-751 ④ IC-R71A/E/D
50MHz	① IC-560 ② IC-551/D
144MHz	① IC-255A/E ② IC-260A/E ③ IC-251A/E ④ IC-271A/E/H
430MHz	① IC-451A/E ② IC-471A/E/H

\* Although the frequency cannot be controlled on other equipment, RTTY operation is possible.

#### 2. Frequency Control Operation

- (1) Connect the CT-10 with the transceiver (receiver) and personal computer as described in section 4 - 3.
- (2) Load the program into the personal computer as described in the program's instruction manual.
- (3) Operate the personal computer as instructed in the program's instruction manual.

\* Be sure to turn on the power to the CT-10 before turning on the personal computer.

### 5-2 RTTY OPERATION

#### Reception

1. Check to see that the CT-10, personal computer, and transceiver are connected correctly. (See sections 4 - 3 and 4 - 4 for connection.) If desired, connect an oscilloscope as shown in the figure.

(When the transceiver has the 24-pin ACC socket and FSK mode.)

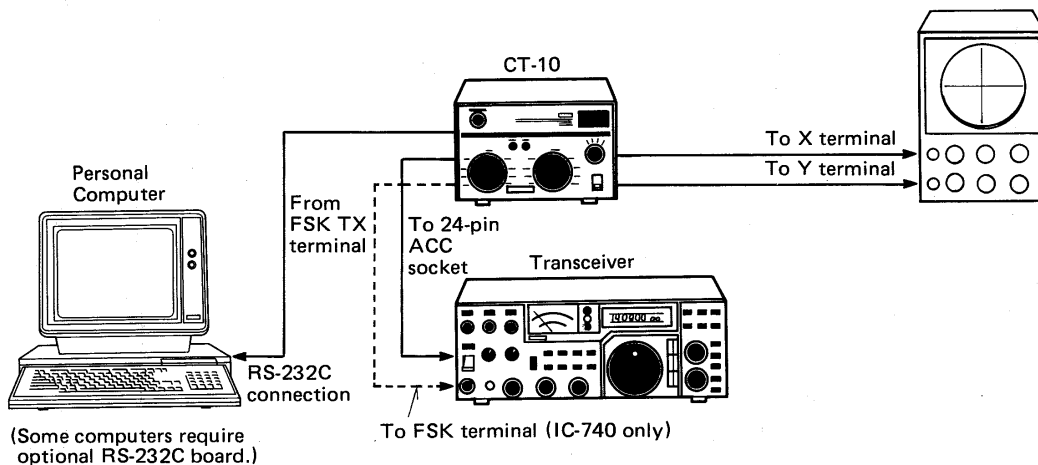

(When the transceiver does not have the 24-pin ACC socket and/or FSK mode.)

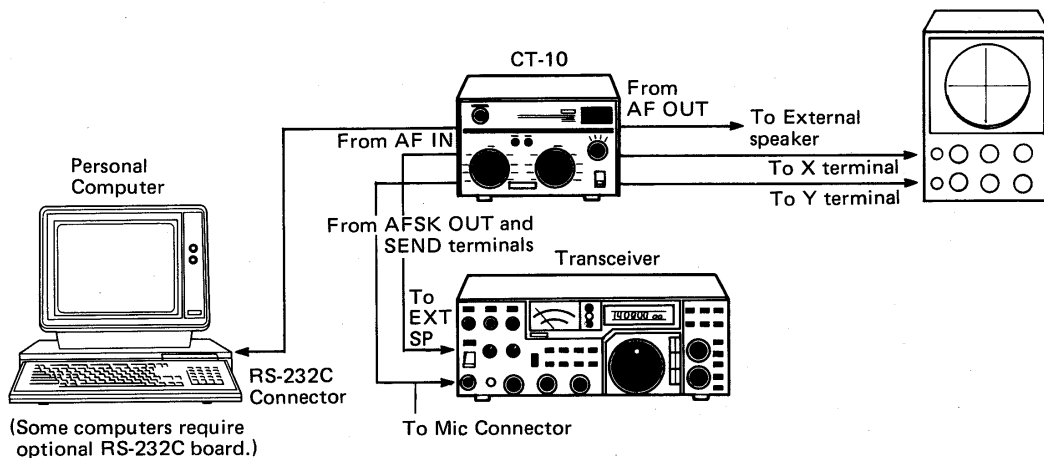

2. Turn on the transceiver, CT-10, and personal computer. Load the program into the personal computer and then run it. Be sure to turn on the power to the CT-10 before turning on the personal computer.
3. Set the transceiver (receiver) to the RTTY mode. Set the baud rate and shift frequency of the CT-10 to 45 baud and 170Hz, respectively, following the program instruction manual. (For RTTY operation in the VHF/UHF FM mode, 850Hz shift is commonly used.)  
If using AFSK, set to the LSB mode for HF or to the LSB or FM mode for VHF/UHF.  
If using FSK, the shift frequency is determined by the FSK circuit of the transceiver independent of the shift setting of the CT-10.
4. Set the mark frequency of the CT-10 to 2125Hz using the MARK FREQUENCY switch. Turn the AF gain control knob clockwise to about the 12 o'clock position.
5. Set the transceiver selector knob of the CT-10 to the position (A - D) matching the ACC cable connecting the transceiver (receiver).
6. Set the MARK frequency switch to "MANUAL" and tune the transceiver so that the MARK lamp is brightest when RTTY signals are received.  
(Note: Tuning is not necessary if in the FM mode.)
7. Turn the space frequency control so that the mark lamp and the space lamp flash alternately.
8. Characters will continue to appear on the display of the personal computer. If the displayed sentences are unreadable, switch the normal/reverse switch.  
If it is still unreadable, try switching the baud rate to 50 (switchable by program command). Switch again if necessary.  
(Note: Some non-amateur transmissions in the amateur radio bands may not be readable. Try tuning to another signal, repeating step (6).)

**Notes:** Unreadable sentences will appear if not tuned properly. Unreadable sentences may appear if the gain control knob is turned too far clockwise.

#### Transmission

9. Set the transceiver to the desired transmitting frequency.
10. Set to the transmit mode according to the program's instructions and send characters by hitting the keyboard.
11. After transmission, return to the receive mode following the program's instructions.

## SECTION VI TECHNICAL INFORMATION

This section describes detailed information on control of the CT-10 for RTTY operation through most personal computers equipped with the RS-232C interface.

### 6-1 RS-232C

Only 3 signal lines in the RS-232C standard, TXD, RXD, and DSR, are used for communication with the CT-10. These 3 lines, along with the ground line (GND) are all that are required for operation.

The operating level of the RS-232C interface used for the CT-10 is switchable to either  $\pm 12V$  or  $0/+5V$ . Set the internal switch of the CT-10 to match the level of the RS-232C used for your computer.

A baud rate of 300 baud has been preset for the RS-232C interface in the CT-10. However, other baud rates (75-9600) can be selected by setting the jumper inside the CT-10.

### 6-2 CONTROL OF THE CT-10

The CT-10 has two operating modes: Normal (RTTY mode) and control. Their operations are described below.

#### 1. Normal Mode

This mode enables the transceiver to transmit 8-bit signals from the computer as RTTY (5-bit) Baudot signals.

This mode also enables the computer to receive RTTY signals from the transceiver.

The baud rate, type of code, transmit/receive switching, etc., necessary for RTTY operation must be set first while in the control mode described next.

#### 2. Control Mode

This mode enables the baud rate, shift frequency, etc., necessary for RTTY operation, to be set. It also enables the frequency and mode of the ICOM transceiver to be controlled by the computer.

Commands to the CT-10 are sent from the computer as 8-bit ASCII codes.

The CT-10 switches to the control mode when 0H is received from the computer and switches to the normal mode when FFH is received.

The type of control is determined by the control code which follows the mode switching code 0H. The control codes are:

0H: CT-10 reset

1H: RTTY terminal unit setting

2H: RTTY code setting

3H: ICOM transceiver control (4-bit models)

4H: ICOM transceiver control (8-bit models)

#### 3. CT-10 Reset

The CT-10 is reset in the following sequence when the specified codes are sent from the computer.

(1) CT-10 in the normal mode.

(2) Send [0H], [0H], and the [FFH] to the CT-10.

(3) The CT-10 is reset and then returns to the normal mode.

#### 4. RTTY Terminal Unit Control

Although the CT-10 contains an RTTY demodulator and AFSK, the front panel only allows the setting of the passband frequency of the demodulator. Set the shift frequency of the AFSK, the baud rate, transmit/receive switching, etc., using the following procedure through the computer.

- (1) Reset the CT-10.
  - (2) Set the RTTY code (Baudot or ASCII code).
  - (3) Set the CT-10 to stand-by.
  - (4) Calculate the value for bits 4 - 6 of the terminal unit setting code.
  - (5) Enter the terminal unit control mode by sending [0H] and then [1H].
- The 8-bit code which follows next sets the terminal unit.  
The significance of each bit is shown below.

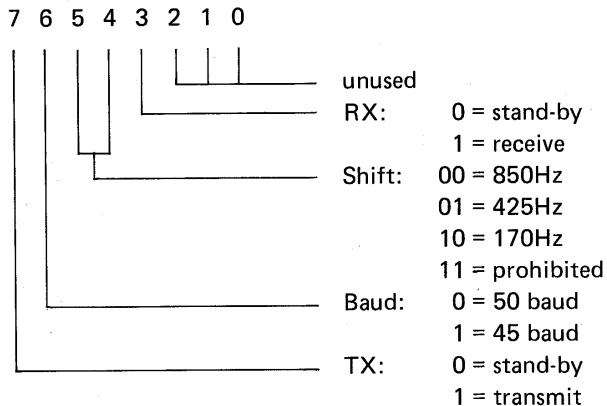

**Example:** 11100000 (E0H) sets the CT-10 to the transmit mode (TX) at 45 baud with 170Hz shift.

**Note:** Each bit must be properly specified each time the 8-bit terminal unit setting code is sent.

The CT-10 returns to the normal mode by sending [FFH] and maintains the modes set in this procedure until reset or a different terminal unit setting code is sent.

- (6) Add 8H to the this value and use to set the terminal unit to the receive mode (bit 3 to high level or "1").
- (7) Add 80H to the value in (4) and use to set the terminal to the transmit mode (bit 7 to high level or "1").
- (8) Set the CT-10 to the normal mode.

#### RTTY Code Setting

Although 8-bit codes are sent between the computer and the CT-10, only the lower 5 bits are used for RTTY. This mode enables the CT-10 to be set to handle 5, 6, 7, or 8-bit codes for RTTY serial/parallel UART.

To set the number of bits for RTTY operation, send the code sequence of:

[0H] [2H] [8-bit code] [FFH]

where the 8-bit code is:

- C2H for 5-bits,
- C6H for 6-bits,
- CAH for 7-bits,
- CEH for 8-bits,

### 6 - 3 ICOM TRANSCEIVER CONTROL

Control for ICOM transceivers differs depending on the type of transceiver. There are three types of control.

- (1) 4-bit HF transceivers
- (2) 4-bit VHF/UHF transceivers
- (3) 8-bit transceivers

#### Standard Format

The following formats consist of a sequence of 8-bit codes. Each 8-bit code is shown in brackets [ ] as a hexadecimal number followed by H.

4-bit transceivers: [0H], [3H] . . . transceiver control code group . . . [FFH]

8-bit transceivers: [0H], [4H] . . . transceiver control code group . . . [FFH]

#### Transceiver Control Code Group

The transceiver control code group is used to control the transceiver and consists of the following:

- ADR: Address code used to select the transceiver to be controlled.  
MODE: Code to set the operating mode of the transceiver.  
VFO: Specifies which VFO is used to set the frequency. (Used only for 4-bit HF transceiver control.)  
FREQ: Frequency to be set. Number of digits varies depending on the type of control.  
[3DH], [3EH]: Start and end codes, respectively, for mode setting. (Used only for 8-bit transceiver control.)  
[2DH], [2EH]: Start and end codes, respectively, for frequency setting. (Used only for 8-bit transceiver control.)

#### 1. ICOM's 4-bit HF Transceivers

The frequency, mode, and VFO can be controlled.

(1) The format of the transceiver control code group is:

[ADR], [MODE], [VFO], [FREQ]

ADR: address code  
HF 50MHz 144MHz 430MHz  
EH DH CH BH

MODE:  
USB CW AM LSB RTTY  
0H 6H 8H BH CH

VFO:  
VFO A VFO B  
AH BH

FREQ: The frequency is specified in 6 digits, in sequence, from the 10MHz digit down to the 100Hz digit and occupies the lower 4 bits of each 8-bit code (the higher 4 bits are all 0).

- (2) When [0H], [3H] (transceiver control code group) [FFH] are sent to the CT-10, the HF transceiver corresponding to the address code is selected and controlled accordingly. The CT-10 then returns to the normal mode. If the transceiver corresponding to the transceiver control codes is not connected, the CT-10 returns to the normal mode after about 1-2 seconds.



**Example:** Setting 14.1234MHz, USB, VFO A. The entire code sequence is then:

[0H] [3H] [EH] [0H] [AH] [1H] [4H] [1H] [2H] [3H] [4H] [FFH]

**Note:** A rotary switch is used for band switching in ICOM's 4-bit HF transceivers. As a result, to set a frequency in a band different from the present one, first send the transceiver control code group, wait at least 1.5 seconds, and then send the code group again:

[0H] [3H] (transceiver control code group) [FFH] (wait at least 1.5 seconds) [0H] [3H] (transceiver control code group) [FFH].

## 2. ICOM's 4-bit VHF/UHF Transceivers

Only the frequency can be controlled.

(1) The format of the transceiver control code group is:

[ADR] (FREQ)

ADR: Refer to the address code table given above.

FREQ: The frequency is specified in 5 digits, in sequence, from the 1MHz digit down to the 100Hz digit and occupies the lower 4 bits of each 8-bit code (the higher 4 bits are all 0).

(2) When [0H] [3H] (transceiver control code group) [FFH] are sent to the CT-10, the VHF or UHF transceiver corresponding to the address code is selected and controlled accordingly. The CT-10 then returns to the normal mode. If the transceiver corresponding to the transceiver control codes is not connected, the CT-10 returns to the normal mode after about 1 - 2 seconds.

**Note:** The lowest frequency digit which can be registered in the transceiver varies depending on the mode setting of the transceiver.

## 3. ICOM's 8-bit Transceivers

The frequency and mode of both HF and VHF/UHF 8-bit transceivers can be controlled by the following method.

**Note:** There may be instances when the frequency shifts a few KHz if the mode is changed. Therefore, be sure to reset the frequency whenever the mode is changed.

(1) The format of the transceiver control code group used to select the transceiver and set its mode is:

[30H + ADR] [3DH + MODE] [3EH]

ADR: ADR occupies the lower 4 bits of the 8-bit code. The higher 4 bits varies depending on the mode or frequency setting.

HF	50MHz	144MHz	220MHz	430MHz	1290MHz
1H	2H	3H	4H	5H	6H

MODE: MODE occupies the lower 4 bits of the 8-bit code. The higher 4 bits is 3H.

LSB	USB	AM	CW	RTTY	FM	CW-NARROW	RTTY-NARROW
0H	1H	2H	3H	4H	5H	BH	CH

[3DH]: Start code.

[3EH]: End code.

The entire code sequence that must be sent to the CT-10 is thus: [0H] [4H] [30H + ADR] [3DH] [30H + MODE] [3EH] [FFH]. The transceiver corresponding to the specified address is selected and is mode set. The CT-10 then returns to the normal mode.

**Example:** Setting the mode of the HF transceiver to CW. The entire code sequence is then:

[0H] [4H] [31H] [3DH] [33H] [3EH] [FFH]

- (2) The format of the transceiver control code group used to select the transceiver and set its frequency is:

[20H + ADR] [2DH] [20H + 1st digit of FREQ] [20H + 2nd digit of FREQ] . . . . .  
[20H + 8th digit of FREQ] [2EH]

**ADR:** Refer to the address code table shown in (1) above. ADR occupies the lower 4 bits of the 8-bit code. The higher 4 bits is 2H.

**FREQ:** The frequency is specified in 8 digits, in sequence, from the 1000MHz digit down to the 100Hz digit. For example, when setting 0.5MHz, the 1000MHz digit down to the 100KHz digit must be specified; the digits below 100KHz need not be specified and can be omitted. Each digit of the frequency is specified as the lower 4 bits of the respective 8-bit code. The higher 4 bits is 0010 (2H).

[2DH]: Start code.

[2EH]: End code.

The entire code sequence that must be sent to the CT-10 is thus: [0H] [4H] [20H + ADR] [2DH] [20H + 1st digit of FREQ] [20H + 2nd digit of FREQ] . . . [20H + 8th digit of FREQ] [2EH] [FFH]. The transceiver corresponding to the specified address is selected and its frequency set. The CT-10 then returns to the normal mode.

**Example:** Setting the frequency of the 2m transceiver to 144.56MHz. The entire code sequence is then:

[0H] [4H] [23H] [2DH] [20H] [21H] [24H] [24H] [25H] [26H] [2EH]  
[FFH]

# SECTION VII BLOCK DIAGRAM

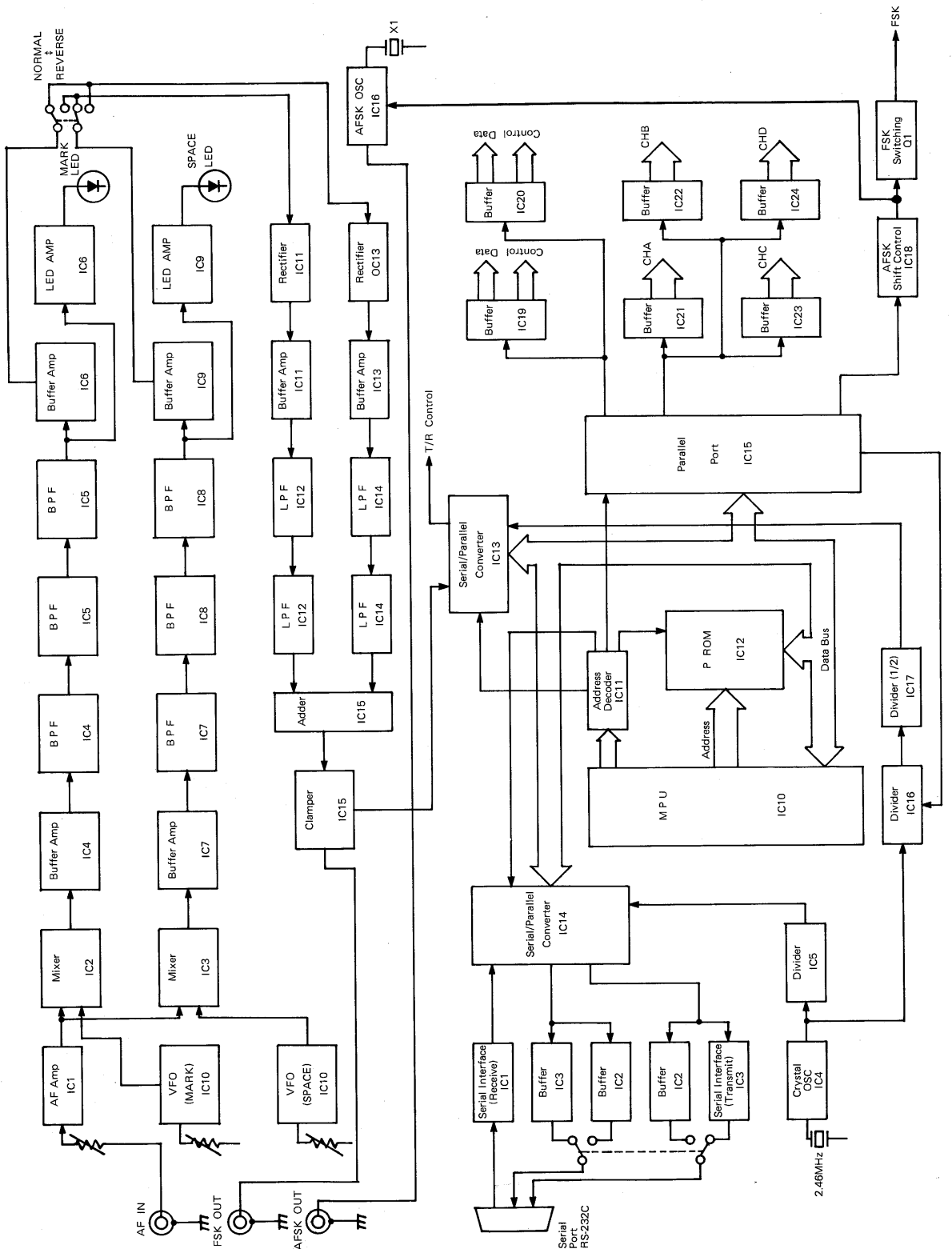



**ICOM**

**ICOM INCORPORATED**

1-6-19, KAMI KURATSUKURI, HIRANO-KU,  
OSAKA JAPAN

A-0602  
Printed in Japan