



# KENWOOD

## Service Manual

### R-1000 / SP-100

### DCK-1



**KB2LJJ**

Radio Mods Database

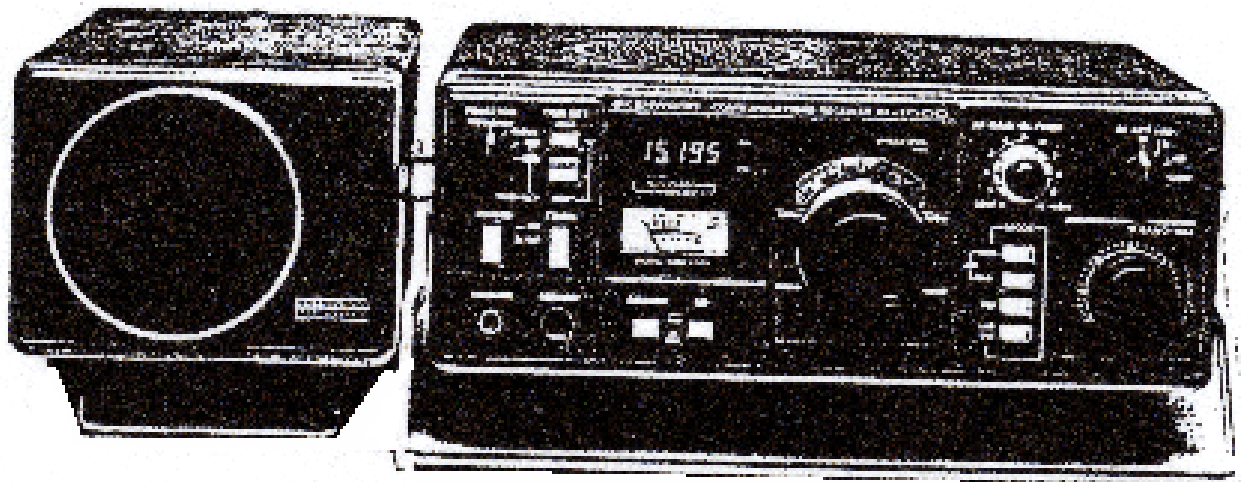

## communications Receiver

# CONTENTS

SPECIFICATIONS .....	2
CIRCUIT DESCRIPTION .....	3
OUTSIDE VIEW .....	6
INSIDE VIEW .....	7
P.C. BOARD .....	8
PLL UNIT (X50-1610-00) .....	8
RX UNIT (X55-1250-00).....	10
VFO UNIT (X40-1160-00) .....	11
PARTS LIST .....	12
EXPLODED VIEW/DISASSEMBLY .....	18
PACKING .....	20
TROUBLESHOOTING .....	21
ADJUSTMENTS .....	22
WIREHARNESSES .....	26
BLOCK DIAGRAM .....	27
SCHEMATIC DIAGRAM .....	28
LEVEL DIAGRAM .....	29
SP-100 .....	30
DCK-1 .....	30

# SPECIFICATIONS

**Frequency Range:** 200 kHz ~ 30.0 MHz  
**Mode:** AM, SSB, CW  
**Receiver Sensitivity:** (S + N/N, better than 10 dB)

	SSB	AM
200 kHz ~ 2 MHz	5 $\mu$ V	50 $\mu$ V
2 MHz ~ 30 MHz	0.5 $\mu$ V	5 $\mu$ V

**Image Ratio:** Better than 60 dB  
**IF Rejection:** Better than 70 dB

**Selectivity:**

<b>AM (WIDE)</b>	12 kHz	- 6 dB
	25 kHz	- 50 dB
<b>AM (NARROW)</b>	6 kHz	- 6 dB
	18 kHz	- 50 dB
<b>SSB/CW</b>	2.7 kHz	- 6 dB
	5 kHz	- 60 dB

**Frequency Stability:** Within  $\pm 2$  kHz during the first hour after 1 minute of warm up.  
 Within  $\pm 300$  Hz during any 30 minute period after warm up.

**Antenna Impedance:**

<b>MW:</b>	200 kHz ~ 2 MHz 1 k $\Omega$ (Unbalanced)
<b>SW-A:</b>	2 MHz ~ 30 MHz 50 $\Omega$ (Unbalanced)
<b>SW-B:</b>	2 MHz ~ 30 MHz 1k $\Omega$ (Unbalanced)

**AF Output:** 1.5W (8 $\Omega$  load, 10% distortion)  
**AF Load Impedance:** 4 ~ 16 $\Omega$  (Speaker, Headphone)  
**Power Consumption:** 20W

**Semiconductors and Tube:**

IC's .....	40
FET's .....	11
Display Tube .....	1
Transistors .....	64
Diodes .....	71

**Dimensions:** 300(W) x 115(H) x 218 (D) mm  
 12-3/4 (W) x 4-1/2 (H) x 8-9/16 (D) inch

**Weight:** 5.5 kg (12.1 lbs)

**CLOCK:**  
**Type:** Quartz  
**Accuracy:** Within  $\pm 15$  second/month (at 25°C)

**NOTE:**  
 The circuit and ratings may change without notice due to development in technology.

# CIRCUIT DESCRIPTION

## R-1000 RECEIVER CIRCUIT CONFIGURATION

The R-1000 has two different antennas: one for 0 ~ 2 MHz (impedance: 1 kΩ) and the other for 2 ~ 30 MHz (impedance: 1 kΩ and 50Ω). The input signal from the antenna is coupled to a variable attenuator covering 0 to -60 dB in 20 dB steps. This attenuator is provided for each antenna. The signal then goes to bandpass filters covering six bands: 0.2 ~ 1 MHz, 1 ~ 2 MHz, 2 ~ 4 MHz, 4 ~ 8 MHz, 8 ~ 16 MHz, and 16 ~ 30 MHz. After passing through the band-pass filter, the signal is fed to RF amplifier Q1 (MOS FET 3SK74(L)), then to a 48.055 MHz IF trap. The signal (covering a frequency range from 200 kHz to 30 MHz) is then fed to amplifiers Q1 and Q2 (2SK125) where it is amplified by approx. 15 dB. It then goes through a wide-band transformer before being fed to a balanced mixer consisting of two 3SK74, where it is mixed with the VCO signal from the PLL circuit to be converted into the 48.055 MHz 1st IF signal. The 1st IF stage consists of monolithic filters MCF F1 and F2. The 1st IF signal is then fed to the 2nd mixer consisting of Q5 and Q6 (3SK74 × 2), where it is mixed with another local frequency of 47.6 MHz to be converted into the 455 kHz 2nd IF signal. After passing through an NB gate, the 2nd IF signal goes to ceramic filters F5, F4, and F3 each dedicated to SSB, AMN, and AMW respectively. The signal then goes to IF amplifier Q7 and Q9 (3SK74 × 2) before it branches into the AM detector and SSB detector. The detector output is amplified by amplifier Q27 (2SC2240) to provide the RECORD output. At the same time, the amplifier output goes through the TONE and GAIN controls before it is power amplified by Q28 (HA1368R) to drive the loudspeaker. Different AGC time constants are automatically selected for SSB and AM.

## CIRCUIT DESCRIPTION

### PLL CIRCUIT

The PLL circuit configuration is shown in Figure 1. The PLL circuit in the R-1000 consists of 4 VCOs covering 0 ~ 7 MHz, 8 ~ 15 MHz, 16 ~ 22 MHz, and 23 ~ 29 MHz to oscillate on 48.055 ~ 78.055 MHz (Q7-10: 2SC1923(O)). The VFO and Q1 (2SC1923(O)) oscillates in combination at a frequency of 47.6 MHz, which is coupled to a buffer (2SC460(B)) then is mixed down by IC1 (SN16913P) to 42.055 ~ 43.055 MHz. This signal is coupled to IC3 (SN16913P), where it is mixed with the VCO frequency (48.055 ~ 78.055 MHz) to be converted into a signal from 6 to 35 MHz. This is then amplified by a 20 dB amplifier consisting of Q15 ~ Q18 via bandpass filters T9 ~ T12. The amplifier output is frequency-divided into 1 MHz by programmable divider IC4 ~ IC7. The 1MHz divider output is then subject to phase comparison by IC8 (MC4044P) which constitutes the PLL loop. The frequency-dividing signal, band switching signal, and VCO switching signal are all created by the BAND switch. The mixer output IC2 (SN16913P), which mixes the VCO frequencies (48.055 ~ 78.055 MHz) with 47.6 MHz, has the frequency of the received signal frequency plus 455 kHz. This signal is coupled to the RX unit via the CON terminal to be used as the counter output.

PLL UNIT X50-1610-00

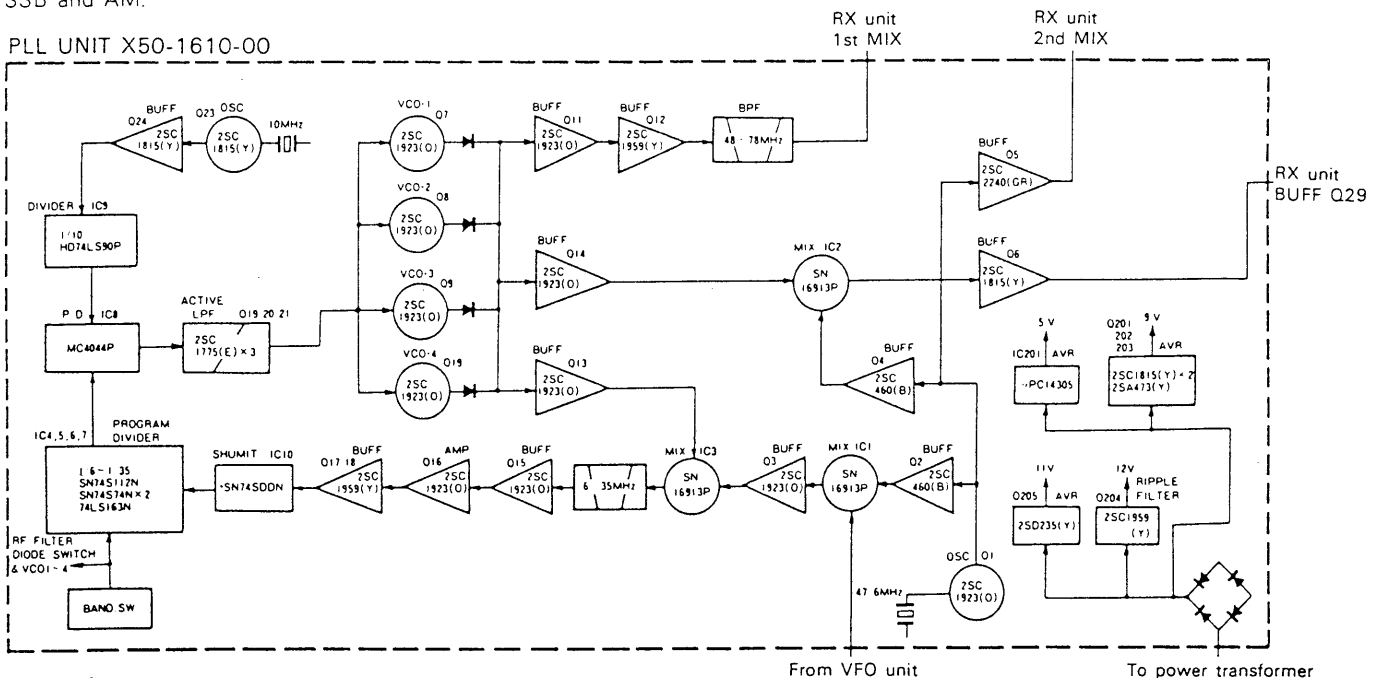

Fig. 1 PLL unit block diagram

# CIRCUIT DESCRIPTION

## COUNTER AND CLOCK CIRCUITS

The PLL circuit output is amplified by Q29 ~ Q32 (2SC1815(Y)) in the RX unit then is fed to Q33 (SN74LS196N) where it is divided by ten. The divider output is fed to Clock and Counter IC MSM5524, which provides a display output that is reduced in frequency by 455 kHz with respect to its input.

The master oscillator for the Clock and Counter oscillates at 3.2768 MHz. The display circuit operates on +11 V DC, which is created by a DC-DC converter.

The FUNCTION switch has four positions: FREQUENCY display, CLOCK display, TIMER ON, and TIMER OFF. Each time the HOUR switch is depressed increments the clock display by one minute; continuously depressing the MIN. switch continuously increments the minutes digit of the clock, while the hours digit is left unchanged. Depressing the HOUR and MIN. switches at the same time resets clock display to "1 hour 0 minute 0 second", and releasing both switches restarts clock operation.

When the FUNCTION switch is placed in the ON or OFF position, pressing the HOUR and MIN. switches at the same time resets the clock to "0.00".

To preset the timer, first preset the desired ON time (or OFF time), then set the TIMER switch to ON. This will turn off (or on) the power to the unit. (When the preset ON time (or OFF time) is reached, the power to the unit is again turned ON (or OFF). At this time, the POWER switch may be placed either ON or OFF position. A relay contact output interlocked with this timer operation is available at the REMOTE terminal.

## [MSM5524]

### • Maximum Ratings

Rating	Symbol	Condition	Value	Unit
DC Supply Voltage	V <sub>DD</sub>	T <sub>a</sub> = 25°C	-0.3 ~ 7	V
Input Voltage	V <sub>I</sub>	T <sub>a</sub> = 25°C	-0.3 ~ V <sub>DD</sub>	V
Storage Temperature Range	T <sub>stg</sub>	—	-55 ~ +125	°C

### • Electrical Characteristics

Rating	Symbol	Condition	Value	Unit	
DC Supply Voltage	V <sub>DD</sub>	Counter	—	4.75 ~ 7	V
		Clock	—	4 ~ 7	V
Crystal Frequency	f	—	3.2768	MHz	
Operating Temperature Range	T <sub>op</sub>	—	-35 ~ +85	°C	

### • Maximum operating frequency

Rating	Symbol	Condition	Min.	Typ.	Max.	Unit
Count frequency (F <sub>IN</sub> )	f	V <sub>DD</sub> = 4.75 V <sub>I</sub> = 1V <sub>p-p</sub>	3	—	—	MHz

Table 1 MSM5524

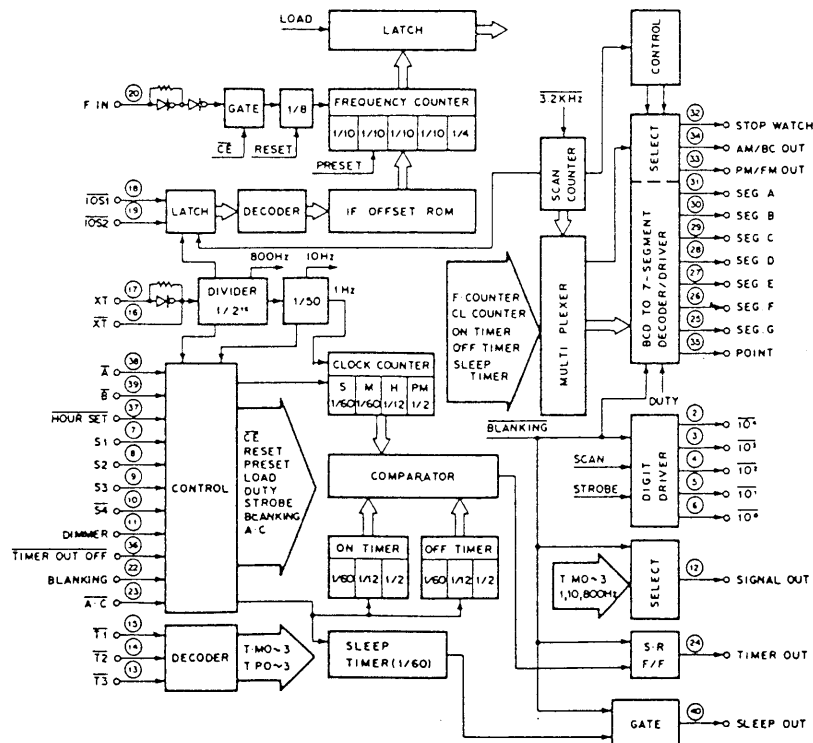

Fig. 2 MSM5524

# CIRCUIT DESCRIPTION

## MSM5524

The equivalent circuit and electrical characteristics of the MSM5524 are shown in Table 1 and Figure 2 respectively.

### 1. Display Drive Output

The display drive output dynamically drives a five-digit common-anode display element. Segment outputs are present at pins 25 ~ 31, while digit outputs are present at pins 2 ~ 6. The active state of each segment (H) and digit (L) requires an output current of 1 mA and 2 mA respectively, which are supplied by drive transistors Q35 ~ Q39 (2SA1015(Y)). Function display outputs are assigned to each pin as follows:

- Pin 35: Point
- Pin 34: AM and BC
- Pin 33: PM and FM
- Pin 32: Stop watch

These operation-mode display elements are driven by transistors Q42 and 43 (2SC1815).

Input			DISPLAY SELECT	MODE
S <sub>1</sub>	S <sub>2</sub>	S <sub>3</sub>		
H	H	H	Clock	Clock Timer
L	H	H	Sleep • Timer	
H	L	H	ON • Timer	
L	L	H	OFF • Timer	
H	H	L	AM	Radio Frequency Counter Frequency Counter
L	H	L	FM	
H	L	L	SW	
L	L	L	Frequency Counter	

H: V<sub>DD</sub> level or open, L: ground level.

Table 2 Function of indicator selection terminal

Code	$\bar{A}$	$\bar{B}$	Function
CLOCK	L	L	Resets to AM 1 : 00 (00 <sup>S</sup> )
	H	L	Advances the "minute", maintains the "minutes" and counts the "seconds"
	L	H	Advances the "hours", maintains the "minutes" and counts the "seconds"
	H	H	Normal operation
ON TIMER	L	L	Resets to AM 0 : 00
	H	L	Advances the "minutes" and maintains the "hours"
	L	H	Advances the "hours" and maintains the "minutes"
	H	H	Maintains the timer-ON time. When the timer-ON time is reached, pin 24 turns ON
OFF TIMER	L	L	Reset to AM 0 : 00
	H	L	Advances the "minutes" and maintains the "hours"
	L	H	Advances the "hours" and maintains the "minutes"
	H	H	Maintains the timer-OFF time. When the timer-OFF time is reached, pin 24 turns OFF

Dropping  $\bar{A}$  or  $\bar{B}$  to "L" advances one digit. When the  $\bar{A}$  or  $\bar{B}$  is kept at "L" for more than 1.6 seconds, the digit advances continuously at a speed of 10 Hz.

### 2. Time Correction

Pins 38 ( $\bar{A}$ ) and 39 ( $\bar{B}$ ) accept time setting inputs which are active at "L" level. Placing these terminals to "L" level permits the functions shown in Table 3 in accordance with the mode selected from Table 2. Each time the time correction button is depressed increments the clock display by one hour or minute. When the button is depressed for more than 1.6 second, the clock display is continuously incremented at a rate of 10 Hz.

### 3. Other Pin Functions

#### a. Pin 23 $\bar{AC}$

All clear input. Initial clear is accomplished by grounding this terminal through capacitor C198 (0.047  $\mu$ F) when the power to the unit is turned ON.

#### b. Pin 22 BLANKING

Input logic of this pin is active at level "H". When this pin is set to "H", all the outputs except the timer and sleep outputs are inhibited. It is usually set to "L".

#### c. Pin 11 DIMMER

This pin accepts the command signal that causes to reduce display brightness. When this pin is set to "H" (active), the display output pulse width is reduced to one fourth.

#### d. Pin 20 F<sub>IN</sub>

This pin accepts the frequency counter input signal.

Table 3 Function chart of input  $\bar{A}$ ,  $\bar{B}$



# INSIDE VIEWS

## TOP VIEWS

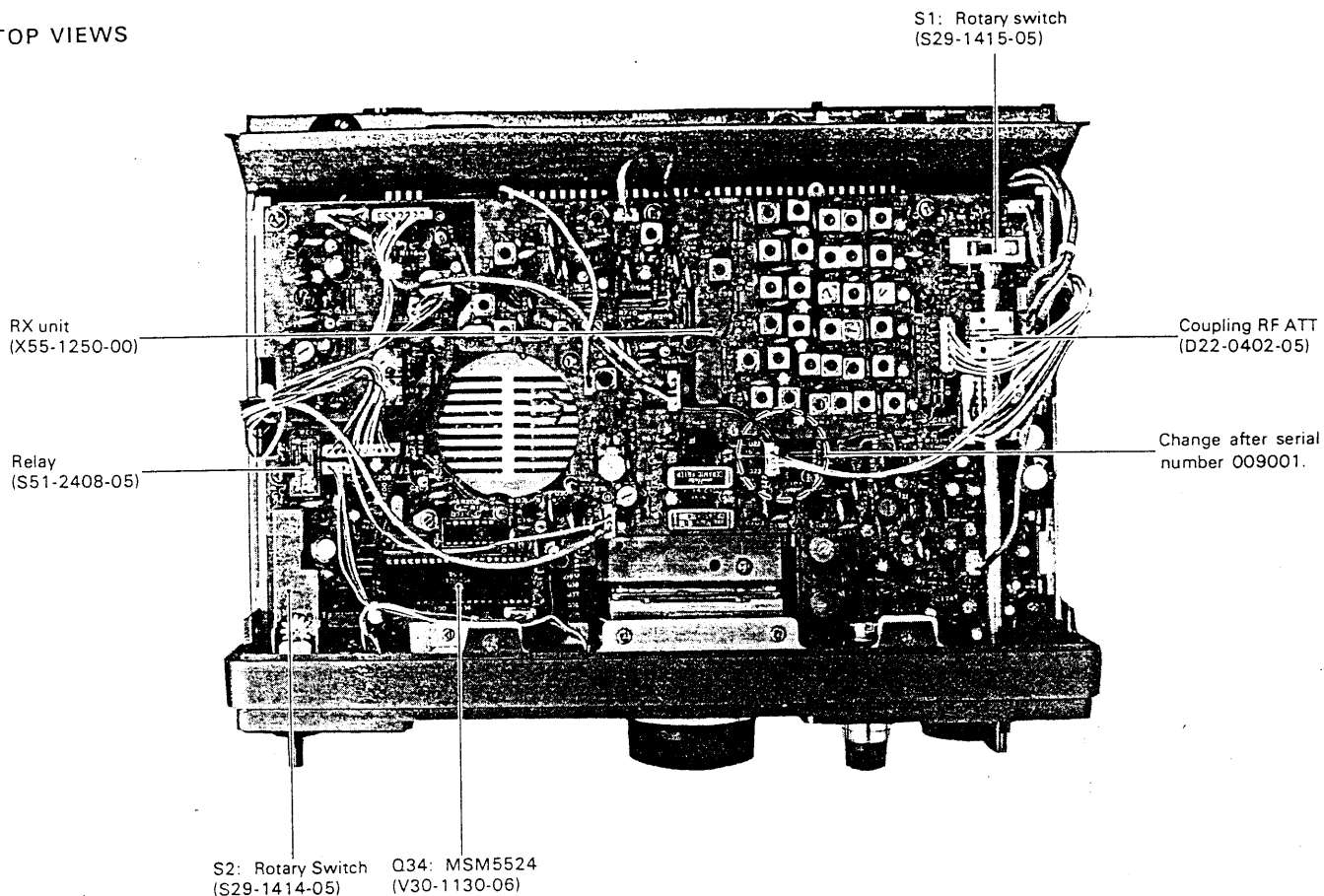

## BOTTOM VIEWS

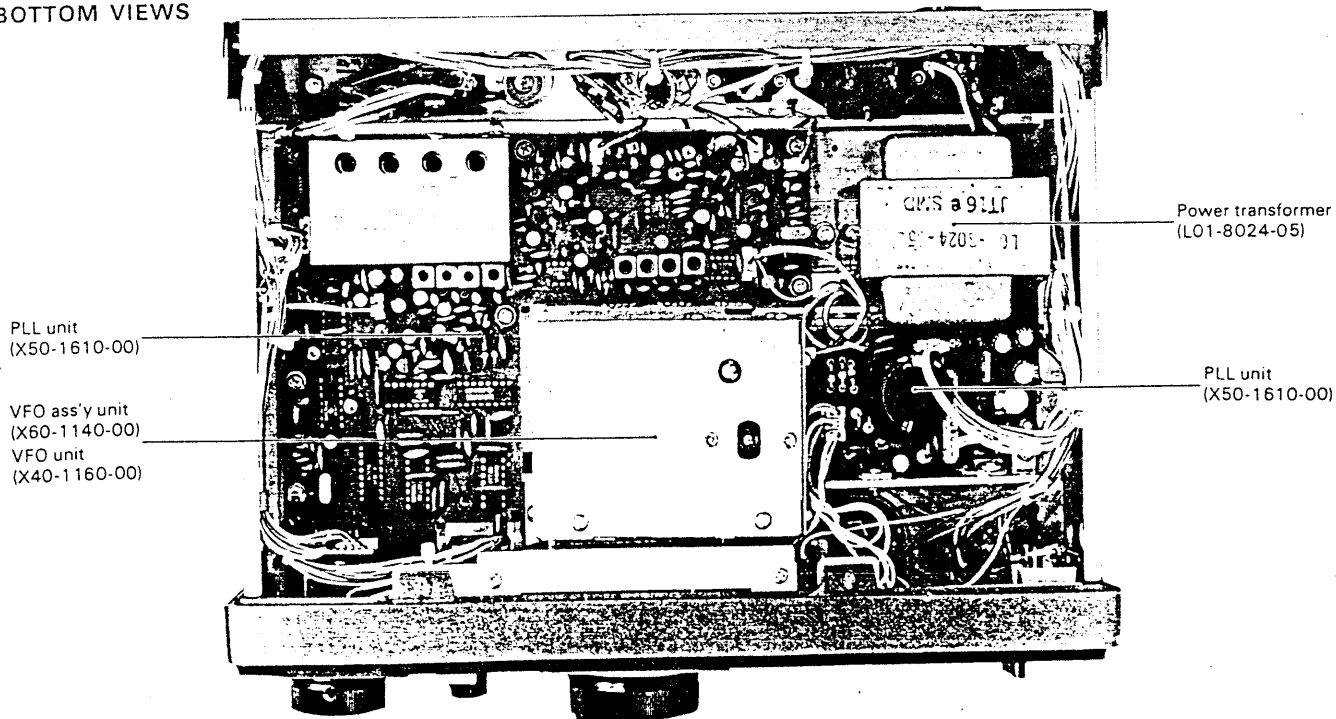

# PC BOARD/CIRCUIT DIAGRAM

▼ PLL UNIT (X50-1610-00)

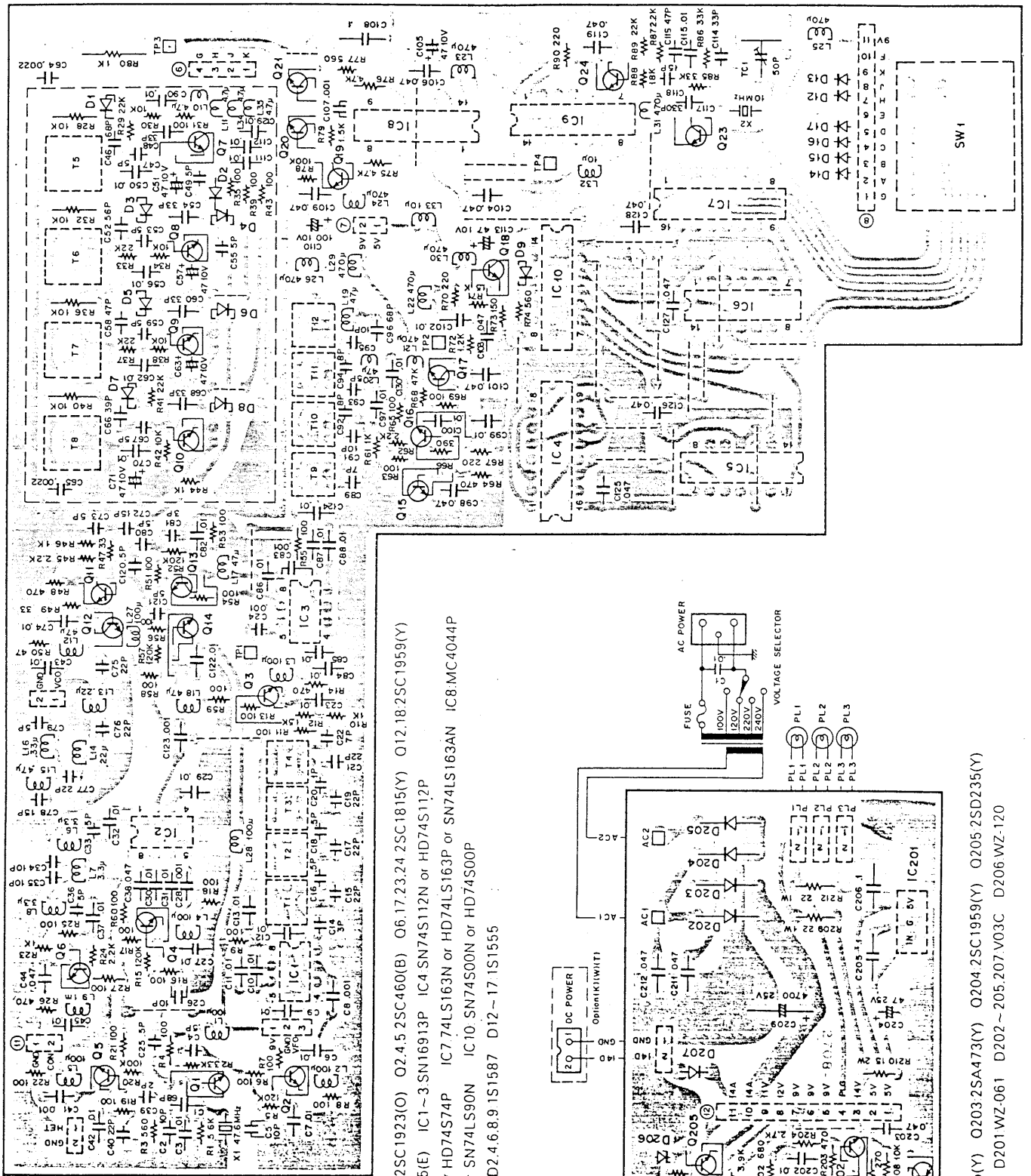

- O1.3.7~11.13~16.2SC1923(O) O2.4.5.2SC460(B) O6.17.23.24.25C1815(Y) Q12.18.25C1959(Y)
- O19.20.21.2SC1775(E) IC1~3.SN16913P IC4.SN74S112N or HD74S112P
- IC5.6.SN74S74N or HD74S74P IC7.74LS163N or HD74LS163P or SN74LS163AN IC8.MC4044P
- IC9.HD74LS90P or SN74LS90N IC10.SN74S00N or HD74S00P
- D1.3.5.7.1S153A D2.4.6.8.9.1S1587 D12~17.1S1555

- Q201.202.2SC1815(Y) Q203.2SA473(Y) Q204.2SC1959(Y) Q205.2SD235(Y)
- IC201.μPC14305 D201.WZ-061 D202~205.207.V03C D206.WZ-120





▼ RX UNIT (X55-1250-00)

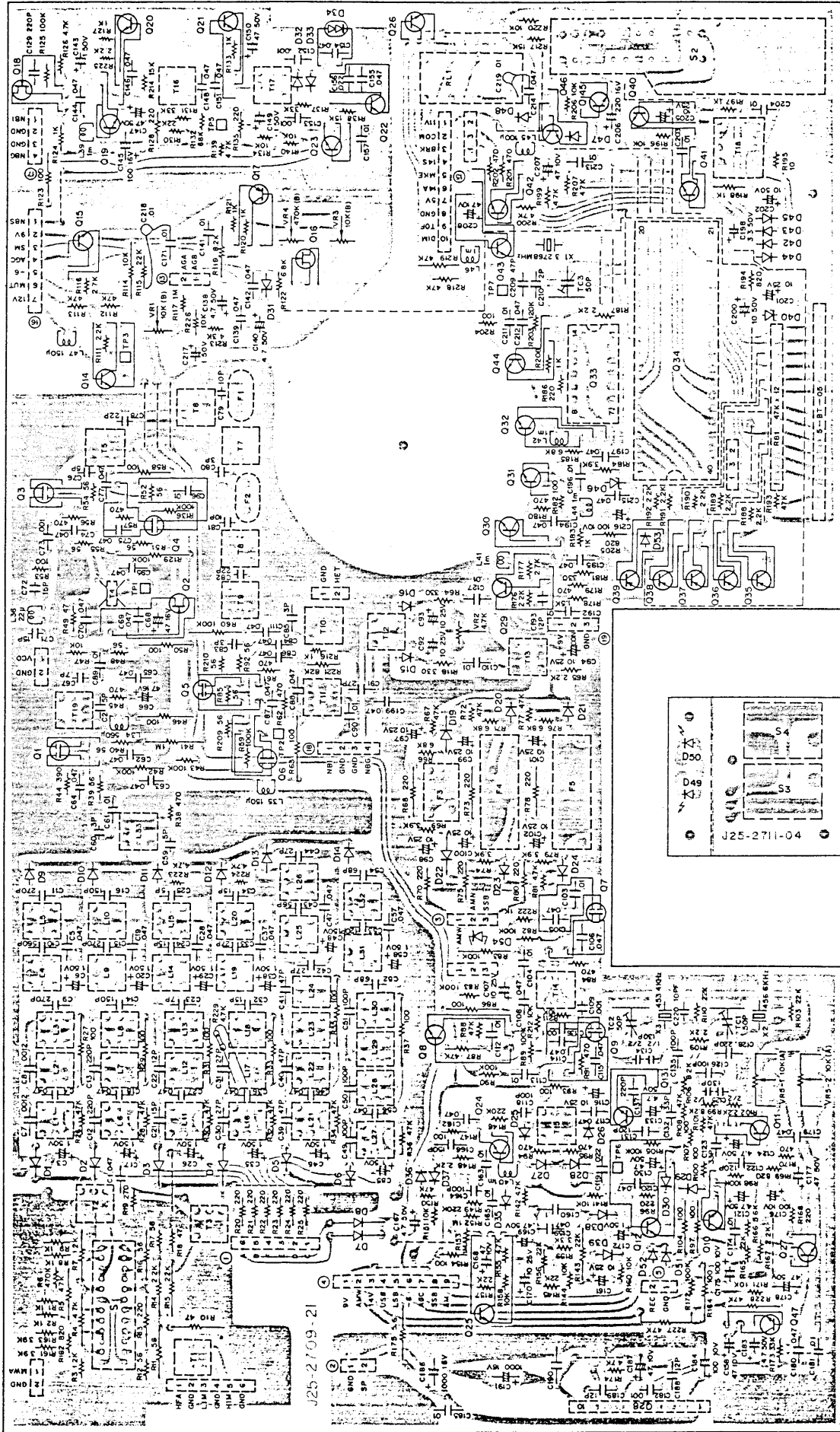

- O1.3-7.9.35K74(L) O2.25K125 O8.10-15.19-24.26.29.31.32.42-45.47.25C1815(Y) O16.18.25K19(GR) O17.35-39.25A1015(Y)
- O25.27.25C2240(GR) O28.HA1368(R) O30.25C460(B) O33.SN74LS196N O34.MSM5524 O40.41.46.25C1959(Y)
- D1-6.152588 D9-16.21.24.1S1587 D7.8.29.30.38.39.42-45.47.48.51-53.151555 D19.20.22.23.1S1007 D25-28.32.33.35-37.1N60 D31.WZ.061 D34.MV.13 D40.WZ.071
- D46.Z6.052 D49.TLG.405 D50.TLY.405

# PC BOARD/CIRCUIT DIAGRAM

▼ VFO UNIT (X40-1160-00)

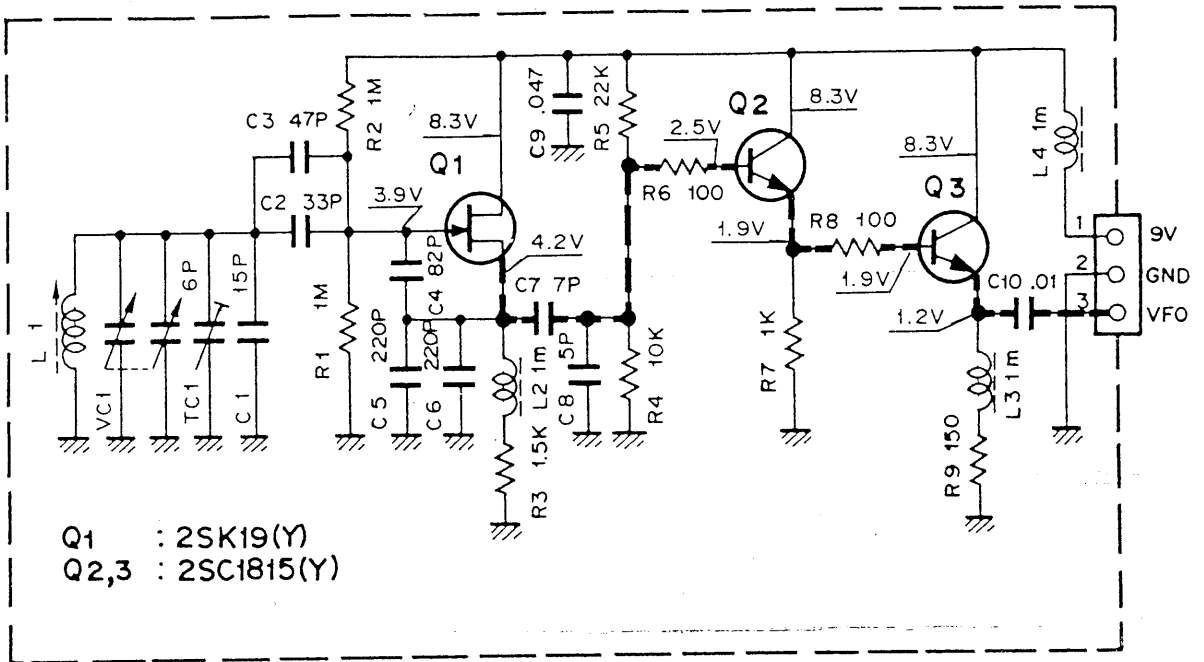

2SA1015(Y) 2SC1959(Y)  
2SC1815(Y) 2SC2240(GR)

2SC460(B)

2SK19(GR),(Y)

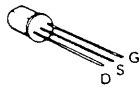
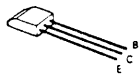
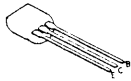

2SK125

3SK74(L)

HA1368(R)

SN74LS196N

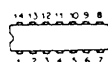
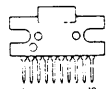
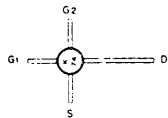
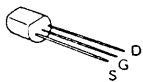

MSM5524

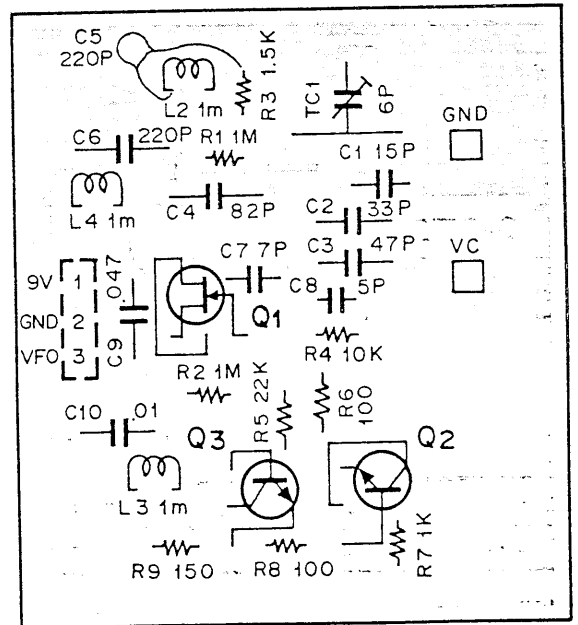
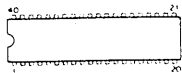

For Service Manuals  
**MAURITRON SERVICES**  
 8 Cherry Tree Road, Chinnor  
 Oxfordshire, OX9 4QY.  
 Tel (01844) 351694  
 Fax (01844) 352554  
 email:- sales@mauritron.co.uk

# PARTS LIST

**Note 1:**

K: U.S.A.      W: Europe      T: Britain      X: Australia

**Note 2:**

Only special type of resistors (example: cement, metal film, etc.) and capacitors (example: electrolytic, tantalum, mylar, temp. coeff. capacitors) are detailed in the PARTS LIST. For the value of all common type components, refer to the schematic diagram of the PC board illustration. Resistors not otherwise detailed are carbon type (1/4 or 1/8W).

Order carbon resistors and capacitors according to the following example:

A carbon resistor's part number is RD14BY 2E222J.

A ceramic capacitor's number is CK45F 1H103Z, CC45TH1H220J.

**RESISTOR**

1. Type of the carbon resistor



2. Wattage

1/4W → 2E  
1/8W → 2B

3. Resistance value

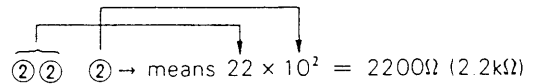

Significant figure

Multiplier

Example: 221 → 220  $\Omega$       224 → 220 k $\Omega$   
 222 → 2.2 k $\Omega$       225 → 2.2 M $\Omega$   
 223 → 22 k $\Omega$

4. Tolerance

J =  $\pm 5\%$  (Gold)  
K =  $\pm 10\%$  (Silver)

**CAPACITORS**

Type I

CK 45 F 1H 103 Z  
1 2 3 4 5 6

Type II

CC 45 TH 1H 220 J  
1' 2 3' 4 5 6

- 1 = Type .... ceramic, electrolytic, etc.
- 2 = Shape ... round, square, etc.
- 3 = Temp. range
- 3' = Temp. coefficient
- 4 = Voltage rating
- 5 = Value
- 6 = Tolerance

6 = Tolerance

Cord	C	D	G	J	K	M	X	Z	P	No cord
(%)	$\pm 0.25$	$\pm 0.5$	$\pm 2$	$\pm 5$	$\pm 10$	$\pm 20$	+40 -20	+80 -20	+100 -0	More than 10 $\mu F$ - 10 ~ +50 Less than 4 7 $\mu F$ - 10 ~ +75

Less than 10 pF

Cord	B	C	D	F	G
(pF)	$\pm 0.1$	$\pm 0.25$	$\pm 0.5$	$\pm 1$	$\pm 2$

3 = CK45F

Ceramic capacitor (type I) 3

Cord	B	D	E	F
Operating temperature °C	-30 +85	-30 +85	-30 +85	-10 +70

3' = CC4500 ....

Ceramic capacitor (type II) temperature coeff. capacitor 1' 3'.

1st word (Color)	CH (Black)	LH (Red)	PH (Orange)	RH (Yellow)	SH (Green)	TH (Blue)	UH (Violet)
ppm/°C	0	-80	-150	-220	-330	-470	-750

5 = Capacitor value

Example: 010 → 1 pF  
 100 → 10 pF  
 101 → 100 pF  
 102 → 1000 pF = 0.001  $\mu F$   
 103 → 0.01  $\mu F$

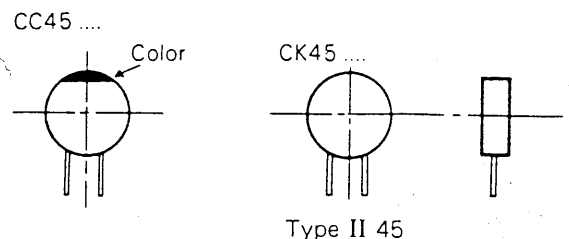

# PARTS LIST

☆ New parts

Ref. No.	Parts No.	Description	Re- marks
<b>GENERAL</b>			
<b>MISCELLANEOUS</b>			
—	A01-0760-12	Case A (top)	☆
—	A01-0761-12	Case B (bottom)	☆
—	A20-2370-05	Panel	☆
—	A23-1442-12	Rear panel	☆
—	B03-0511-04	Switch mask MODE	☆
—	B07-0620-05	Dial escutcheon	☆
—	B10-0624-04	Front glass (B) DISPLAY	☆
—	B10-0623-04	Front glass (A) PANEL	☆
—	B05-0711-04	Speaker grill cloth	☆
—	B06-0501-05	Speaker grill	☆
—	B20-0814-04	Dial scale	☆
—	B30-0813-05	Pilot lamp MODE	☆
—	B30-0808-05	Pilot lamp METER	☆
—	B31-0624-05	Meter	☆
—	B42-1673-04	Indicating plate (AF-TONE)	☆
—	B42-1680-04	FTZ plate (W)	☆
—	B43-0629-04	Model name plate (T)	☆
—	B43-0630-04	Model name plate (K)(W)(X)	☆
—	B46-0058-00	Warranty card (K)	☆
—	B50-2685-00	Operating manual (K)(W)(X)	☆
—	B50-2686-00	Operating manual (T)	☆
—	B58-0619-00	Warning paper (AC VOLT) (K)(W)(X)	☆
—	B58-0620-00	Warning paper (X)	☆
—	B58-0621-00	Warning paper (AC VOLT) (T)	☆
—	D12-0402-05	Handle cam	☆
—	D40-0610-04	Shaft ASS'Y	☆
—	E04-0152-05	UHF Connector ANT	☆
—	E06-0751-05	7P DIN Connector REMOTE	☆
—	E07-0751-05	7P DIN Plug	☆
—	E08-0203-25	2P Connector (T)	☆
—	E11-0402-15	US Jack REC	☆
—	E11-0003-15	US Jack EXT. SP	☆
—	E11-0034-25	US Jack PHONES	☆
—	E12-0001-05	Phone plug	☆
—	E18-0351-05	3P inlet AC POWER	☆
—	E21-0455-05	3P push terminal plate ANT	☆
—	E30-1643-15	AC ASS'Y (K)	☆
—	E30-1645-15	AC ASS'Y (W)	☆
—	E30-1644-15	AC ASS'Y (T)	☆
—	E30-1646-05	DC cord ass'y (X)	☆
—	E30-1647-15	AC ASS'Y (X)	☆
—	F19-0610-04	Connector mask 13.8V DC	☆
—	F05-7012-05	Fuse 0.7A (K) × 2	☆
—	F05-1023-05	Fuse 1A (X) × 2	☆
—	F05-4014-05	Fuse 0.4A (K)(W)(T)(X) × 2	☆
—	F15-0626-04	Shadow mask	☆
—	F15-0631-04	Masking sheet	☆
—	G02-0505-05	D spring AF	☆
—	G02-0513-04	Spring for handle × 2	☆
—	G10-0606-04	Vibration proof cloth × 4	☆
—	G53-0501-04	Packing × 2	☆
—	H01-2652-04	Carton inside (K)(W)(X)	☆
—	H01-2653-04	Carton inside (T)	☆
—	H03-1730-04	Carton outside (K)(W)(T)(X)	☆

Ref. No.	Parts No.	Description	Re- marks
—	H10-2526-02	Right side packing fixture	☆
—	H10-2527-02	Left side packing fixture	☆
—	H12-0466-04	Cushion	☆
—	H20-1415-03	Protective cover	☆
—	H25-0029-04	Protective bag (60 × 100)	☆
—	H25-0105-04	Protective bag (150 × 350)	☆
—	J02-0323-05	Foot × 4	☆
—	J02-0414-05	Rear foot × 2	☆
—	J09-0401-05	Handle arm	☆
—	J13-0033-15	Fuse holder	☆
—	J19-1327-05	Lead holder × 4	☆
—	K01-0405-04	Handle ASS'Y	☆
—	K21-0747-04	Knob BAND	☆
—	K21-0748-04	Knob TONE	☆
—	K23-0726-04	Knob × 2 RF ATT, FUNC	☆
—	K27-0407-04	Knob AF	☆
—	K29-0723-04	Knob MAIN	☆
—	K29-0724-04	Push knob × 4 MODE	☆
—	K29-0725-04	Push knob × 2 NB, DIMMER	☆
—	K29-0726-04	Push knob CLOCK	☆
—	K29-0727-04	Push knob POWER	☆
—	K29-0728-04	Push knob TIMER	☆
—	K29-0729-04	CAL knob	☆
—	L01-8024-05	Power transformer	☆
—	N08-0601-05	Handle screw × 4	☆
—	S29-1413-05	Rocker switch(Power source selector)	☆
—	S31-2045-05	Slide switch ANT.	☆
—	S42-4401-05	Push switch MODE	☆
—	S42-2402-05	Push switch POWER	☆
—	S42-2403-05	Push switch NB	☆
—	T07-0205-05	Speaker	☆
<b>CAPACITOR</b>			
C1	C90-0145-05	Film capacitor 0.01μF AC 125V	
<b>RESISTOR</b>			
R1.2	RC05GF2H101J	Solid 100Ω ±5% 1/2W	
R3	RD14BB2E103J	Carbon 1kΩ ±5% 1/4W	

## PLL UNIT (X50-1610-00)

Ref. No.	Parts No.	Description	Re- marks
<b>MISCELLANEOUS</b>			
—	E23-0046-04	Terminal × 6	
—	F20-0078-05	Insulating plate	
—	F29-0014-05	Insulating washer	
—	J31-0502-04	PC Board collar	
—	J42-0404-05	PC Board bush	
—	S29-2403-05	Band switch	☆
<b>SEMICONDUCTOR</b>			
Q1	V03-1923-06	Transistor 2SC1923 (O)	
Q2	V03-0079-05	Transistor 2SC460 (B)	
Q3	V03-1923-06	Transistor 2SC1923 (O)	
Q4.5	V03-0079-05	Transistor 2SC460 (B)	

# PARTS LIST

Ref. No.	Parts No.	Description	Re- marks
Q6	V03-1815-06	Transistor 2SC1815 (Y)	
Q7~11	V03-1923-06	Transistor 2SC1923 (O)	
Q12	V03-1959-06	Transistor 2SC1959 (Y)	
Q13~16	V03-1923-06	Transistor 2SC1923 (O)	
Q17	V03-1815-06	Transistor 2SC1815 (Y)	
Q18	V03-1959-06	Transistor 2SC1959 (Y)	
Q19~21	V03-1775-06	Transistor 2SC1775 (E)	
Q22	NOT USED		
Q23,24	V03-1815-06	Transistor 2SC1815 (Y)	
Q201,202	V03-1815-06	Transistor 2SC1815 (Y)	
Q203	V01-0473-06	Transistor 2SA473 (Y)	
Q204	V03-1959-06	Transistor 2SC1959 (Y)	
Q205	V04-0880-16	Transistor 2SD880 (Y)	
IC1~3	V30-1048-06	IC SN16913P	
IC4	V30-0185-05	IC SN74S112N or	
	V30-1077-06	IC HD74S112P	
IC5,6	V30-1112-06	IC SN74S74N or	
	V30-1076-06	IC HD74S74P	
IC7	V30-1047-06	IC HD74LS163P or	
	V30-1154-06	IC SN74LS163AN	
IC8	V30-0173-05	IC MC4044P	
IC9	V30-1083-06	IC HD74LS90P or	
	V30-1005-26	IC SN74LS90N	
IC10	V30-0181-05	IC SN74S00N or	
	V30-1075-06	IC HD74S00P	
IC201	V30-1029-26	IC $\mu$ PC14305	
D1	V11-4161-36	Vari-cap 1SV53A	
D2	V11-0370-05	Diode 1S1587	
D3	V11-4161-36	Vari-cap 1SV53A	
D4	V11-0370-05	Diode 1S1587	
D5	V11-4161-36	Vari-cap 1SV53A	
D6	V11-0370-05	Diode 1S1587	
D7	V11-4161-36	Vari-cap 1SV53A	
D8,9	V11-0370-05	Diode 1S1587	
D10,11	NOT USED		
D12~17	V11-0076-05	Diode 1S1555	
D201	V11-0243-05	Zener diode WZ-061	
D202~205	V11-0290-05	Diode V03C	
D206	V11-0249-05	Zener diode WZ-120	
D207	V11-0290-05	Diode V03C	
<b>COIL/CRYSTAL</b>			
T1~4	L32-0198-05	Tuning coil	
T5	L34-0852-05	Tuning coil	☆
T6	L34-0853-05	Tuning coil	☆
T7	L34-0854-05	Tuning coil	☆
T8	L34-0855-05	Tuning coil	☆
T9	L34-0851-05	Tuning coil	☆
T10,11	L34-0856-05	Tuning coil	☆
T12	L34-0851-05	Tuning coil	☆
L1~5	L40-1011-03	Ferri-inductor 100 $\mu$ H	
L6~8	L40-3392-02	Ferri-inductor 3.3 $\mu$ H	
L9	L40-1021-03	Ferri-inductor 1mH	
L10,11	L40-4791-01	Ferri-inductor 4.7 $\mu$ H	
L12	L40-4782-02	Ferri-inductor 0.47 $\mu$ H	
L13,14	L40-2282-01	Ferri-inductor 0.22 $\mu$ H	
L15	L40-4782-02	Ferri-inductor 0.47 $\mu$ H	
L16	L40-3382-01	Ferri-inductor 0.33 $\mu$ H	
L17~20	L40-4701-03	Ferri-inductor 47 $\mu$ H	
L21~26	L40-4711-03	Ferri-inductor 470 $\mu$ H	
L27,28	L40-1011-03	Ferri-inductor 100 $\mu$ H	

Ref. No.	Parts No.	Description	Re- marks
L29~31	L40-4711-03	Ferri-inductor 470 $\mu$ H	
L32,33	L40-1001-02	Ferri-inductor 10 $\mu$ H	
L34,35	L40-4791-01	Ferri-inductor 4.7 $\mu$ H	
X1	L77-0852-05	Quartz crystal 47.6 MHz	
X2	L77-0482-05	Quartz crystal 10 MHz	☆
<b>POTENTIOMETER/RESISTOR/TRIMMER</b>			
VR201	R12-0065-05	Semi-fixed resistor 470 $\Omega$	
R1~R208,211,213	RD14BB2E000J or RD14CB2E000J	Carbon $\infty\infty\infty\Omega \pm 5\%$ 1/4W	
R209	RS14AB3A220J	Metal film 22 $\Omega \pm 5\%$ 1W	
R210	RS14AB3D150J	Metal film 15 $\Omega \pm 5\%$ 2W	
R212	RS14AB3A220J	Metal film 22 $\Omega \pm 5\%$ 1W	
R81~84		Not used	
R91~200		Not used	
TC1	CO5-0029-15	Ceramic trimmer 50pF	
<b>CAPACITOR</b>			
C1	CC45SL1H680J	Ceramic 68pF $\pm 5\%$	
C2	CC45SL1H100D	Ceramic 10pF $\pm 0.5pF$	
C4	CC45CH1H0R5C	Ceramic 0.5pF $\pm 0.25pF$	
C5	CC45SL1H100D	Ceramic 10pF $\pm 0.5pF$	
C14	CC45CH1H030C	Ceramic 3pF $\pm 0.25pF$	
C15	CC45RH1H220J	Ceramic 22pF $\pm 5\%$	
C16	CC45CH1H0R5C	Ceramic 0.5pF $\pm 0.25pF$	
C17	CC45RH1H220J	Ceramic 22pF $\pm 5\%$	
C18	CC45CH1H0R5C	Ceramic 0.5pF $\pm 0.25pF$	
C19	CC45RH1H220J	Ceramic 22pF $\pm 5\%$	
C20	CC45CH1H010C	Ceramic 1pF $\pm 0.25pF$	
C21	CC45RH1H220J	Ceramic 22pF $\pm 5\%$	
C22	CC45CH1H070D	Ceramic 7pF $\pm 0.5pF$	
C25	CC45CH1H0R5C	Ceramic 0.5pF $\pm 0.25pF$	
C26	CC45SL1H100D	Ceramic 10pF $\pm 0.5pF$	
C33	CC45SL1H050C	Ceramic 5pF $\pm 0.25pF$	
C34,35	CC45SL1H100D	Ceramic 10pF $\pm 0.5pF$	
C36	CC45SL1H050C	Ceramic 5pF $\pm 0.25pF$	
C38	C91-0456-05	Ceramic 0.047 $\mu$ F 25WV	
C39	CC45CH1H020C	Ceramic 2pF $\pm 0.25pF$	
C40	CC45SL1H220J	Ceramic 22pF $\pm 5\%$	
C44	C91-0456-05	Ceramic 0.047 $\mu$ F 25WV	
C46	CC45RH1H680J	Ceramic 68pF $\pm 5\%$	
C47	CC45CH1H050C	Ceramic 5pF $\pm 0.25pF$	
C48	CC45CH1H330J	Ceramic 33pF $\pm 5\%$	
C49	CC45CH1H050C	Ceramic 5pF $\pm 0.25pF$	
C51	CE04W1A470Q	Electrolytic 47 $\mu$ F 10WV	
C52	CC45RH1H560J	Ceramic 56pF $\pm 5\%$	
C53	CC45CH1H050C	Ceramic 5pF $\pm 0.25pF$	
C54	CC45CH1H330J	Ceramic 33pF $\pm 5\%$	
C55	CC45CH1H050C	Ceramic 5pF $\pm 0.25pF$	
C57	CE04W1A470Q	Electrolytic 47 $\mu$ F 10WV	
C58	CC45SH1H470J	Ceramic 47pF $\pm 5\%$	
C59	CC45CH1H050C	Ceramic 5pF $\pm 0.25pF$	
C60	CC45CH1H330J	Ceramic 33pF $\pm 5\%$	
C63	CE04W1A470Q	Electrolytic 47 $\mu$ F 10WV	
C66	CC45TH1H390J	Ceramic 39pF $\pm 5\%$	
C67	CC45TH1H050C	Ceramic 5pF $\pm 0.25pF$	
C68	CC45TH1H330J	Ceramic 33pF $\pm 5\%$	
C71	CE04W1A470Q	Electrolytic 47 $\mu$ F 10WV	
C72	CC45CH1H150J	Ceramic 15pF $\pm 5\%$	
C73	CC45CH1H050C	Ceramic 5pF $\pm 0.25pF$	
C75~77	CC45SL1H220J	Ceramic 22pF $\pm 5\%$	

# PARTS LIST

Ref. No.	Parts No.	Description	Re- marks
C78	CC45SL1H150J	Ceramic 15pF ±5%	
C79	CC45SL1H050C	Ceramic 5pF ±0.25pF	
C80	CC45CH1H0R5C	Ceramic 0.5pF ±0.25pF	
C81	CC45CH1H030C	Ceramic 3pF ±0.25pF	
C89	CC45RH1H070D	Ceramic 7pF ±0.5pF	
C91	CC45RH1H100D	Ceramic 10pF ±0.5pF	
C92	CC45RH1H080D	Ceramic 8pF ±0.5pF	
C93	CC45RH1H050C	Ceramic 5pF ±0.25pF	
C94	CC45RH1H080D	Ceramic 8pF ±0.5pF	
C95	CC45RH1H100D	Ceramic 10pF ±0.5pF	
C96	CC45SL1H680J	Ceramic 68pF ±5%	
C98,101	C91-0456-05	Ceramic 0.047μF 25WV	
C103,104	C91-0456-05	Ceramic 0.047μF 25WV	
C105	EC04W1A470Q	Electrolytic 47μF 10WV	
C106	C91-0456-05	Ceramic 0.047μF 25WV	
C107	CQ92M1H102K	Mylar 0.001μF ±10%	
C108	CQ92M1H104K	Mylar 0.1μF ±10%	
C109	C91-0456-05	Ceramic 0.047μF 25WV	
C110	CE04W1A101Q	Electrolytic 100μF 10WV	
C113	CE04W1A470Q	Electrolytic 47μF 10WV	
C114	CC45SL1H330J	Ceramic 33pF ±5%	
C116	CC45SL1H470J	Ceramic 47pF ±5%	
C117	CC45SL1H331J	Ceramic 330pF ±5%	
C118	CC45SL1H150J	Ceramic 15pF ±5%	
C119	C91-0456-05	Ceramic 0.047μF 25WV	
C120	CC45CH1H0R5C	Ceramic 0.5pF ±0.25pF	
C121	CC45SL1H050C	Ceramic 5pF ±0.25pF	
C125~128	C91-0456-05	Ceramic 0.047μF 25WV	
C61,C69		Not used	
C131~200		Not used	
C201	CE04W1A101Q	Electrolytic 100μF 10WV	
C203	C91-0456-05	Ceramic 0.047μF 25WV	
C204	CE04W1E470Q	Electrolytic 47μF 25WV	
C205,206	CQ92M1H104K	Mylar 0.1μF ±10%	
C207	CE04W1C221Q	Electrolytic 220μF 16WV	
C208	CE04W1C101Q	Electrolytic 100μF 16WV	
C209	C90-0814-05	Electrolytic 4700μF 25WV	
C210	CE04W1C101Q	Electrolytic 100μF 16WV	
C211,212	C90-0288-05	Ceramic 0.047μF 50WV	

## VFO ASS'Y UNIT (X60-1140-00)

Ref. No.	Parts No.	Description	Re- marks
MISCELLANEOUS			
—	B42-1645-04	Indicating tape	
—	B11-0406-04	Color filter	☆
—	B30-0808-05	Pilot lamp	
—	G02-0512-04	Dial scale spring	☆
—	N14-0515-04	Dial scale nut	☆
—	N19-0620-04	WASHER	☆

## VFO UNIT (X40-1160-00)

Ref. No.	Parts No.	Description	Re- marks
MISCELLANEOUS			
—	D22-0405-04	Coupling	
—	D40-0611-00	Dial mechanism ASS'Y	☆
—	E23-0046-04	Terminal	

Ref. No.	Parts No.	Description	Re- marks
COIL			
L1	L32-0622-05	Oscillator coil	☆
L2,3,4	L40-1021-03	Ferri-inductor 1mH	
SEMICONDUCTOR			
Q1	V09-0011-05	FET 2SK19 (Y)	
Q2,3	V03-1815-06	Transistor 2SC1815 (Y)	
VC/TRIMMER			
VC1	C02-0018-05	Variable capacitor	☆
TC1	C05-0041-05	Ceramic trimmer 6pF	
CAPACITOR			
C1	CC45PG1H150J	Ceramic 15pF ±5%	
C2	CC45PG1H330J	Ceramic 33pF ±5%	
C3	CC45CG1H470J	Ceramic 47pF ±5%	
C4	CC45PG1H820J	Ceramic 82pF ±5%	
C5,6	CC45RG1H221J	Ceramic 220pF ±5%	
C7	CC45CH1H070D	Ceramic 7pF ±0.5pF	
C8	CC45CH1H050C	Ceramic 5pF ±0.25pF	
C9	C91-0456-05	Ceramic 0.047μF 25WV	
C10	CK45F1H103Z	Ceramic 0.01μF +80%—20%	
RESISTOR			
R1~9	RD14CB2E000J	Carbon 000Ω ±5% 1/4W	

## RX UNIT (X55-1250-00)

Ref. No.	Parts No.	Description	Re- marks
MISCELLANEOUS			
—	D22-0402-05	Coupling RF ATT.	
—	E23-0046-04	Terminal × 7	
—	G13-0620-04	Cushion	
—	J31-0502-04	PC Board collar × 8	
—	J42-0404-05	PC Board bush × 8	
—	V40-7770-06	Indicating tube 5-BT-05	☆
IFT/COIL/FILTER/CRYSTAL/CERAMIC			
T1	L34-0898-05	Input coil	☆
T2	L34-0869-05	Input coil MW	☆
T3	L34-0899-05	Input coil SW	☆
T4	L19-0303-05	Wide band transformer	
T5	L34-0858-05	Tuning coil	☆
T6	L34-0859-05	Tuning coil	☆
T7	L34-0860-45	Tuning coil	☆
T8	L34-0859-05	Tuning coil	☆
T9	L34-0862-05	Tuning coil	☆
T10	L34-0857-05	Tuning coil	☆
T11	L34-0864-05	Tuning coil	☆
T12	L34-0865-15	Tuning coil	☆
T13	L34-0866-15	Tuning coil	☆
T14	L34-0540-05	Tuning coil	
T15	L34-0868-05	Tuning coil	☆
T16	L34-0540-05	Tuning coil	
T17	L34-0863-05	Tuning coil	☆
T18	L19-0320-05	Oscillator transformer	☆
T19	L32-0195-05	Tuning coil	
L1	L34-0884-05	Filter coil 470μH	☆
L2	L34-0883-05	Filter coil 220μH	☆

# PARTS LIST

Ref. No.	Parts No.	Description	Re- marks
L3	L34-0884-05	Filter coil 470 $\mu$ H	☆
L4.5	L34-0882-05	Filter coil 120 $\mu$ H	☆
L6	L34-0881-05	Filter coil 100 $\mu$ H	☆
L7	L34-0879-05	Filter coil 47 $\mu$ H	☆
L8	L34-0881-05	Filter coil 100 $\mu$ H	☆
L9.10	L34-0880-05	Filter coil 68 $\mu$ H	☆
L11	L34-0873-05	Filter coil 5.6 $\mu$ H	☆
L12	L34-0870-05	Filter coil 2.7 $\mu$ H	☆
L13	L34-0873-05	Filter coil 5.6 $\mu$ H	☆
L14.15	L34-0872-05	Filter coil 3.9 $\mu$ H	☆
L16	L34-0875-05	Filter coil 12 $\mu$ H	☆
L17	L34-0873-05	Filter coil 5.6 $\mu$ H	☆
L18	L34-0875-05	Filter coil 12 $\mu$ H	☆
L19.20	L34-0874-05	Filter coil 8.2 $\mu$ H	☆
L21	L34-0877-05	Filter coil 22 $\mu$ H	☆
L22.23	L34-0875-05	Filter coil 12 $\mu$ H	☆
L24	L34-0877-05	Filter coil 22 $\mu$ H	☆
L25.26	L34-0876-05	Filter coil 15 $\mu$ H	☆
L27	L34-0879-05	Ferri-inductor 47 $\mu$ H	☆
L28.29	L34-0877-05	Filter coil 22 $\mu$ H	☆
L30	L34-0879-05	Ferri-inductor 47 $\mu$ H	☆
L31.32	L34-0878-05	Filter coil 33 $\mu$ H	☆
L33	L34-0871-05	Filter coil 3.3 $\mu$ H	☆
L34	L40-5611-03	Ferri-inductor 560 $\mu$ H	
L35	L40-1511-03	Ferri-inductor 150 $\mu$ H	
L36	L40-2282-01	Ferri-inductor 0.22 $\mu$ H	☆
L39~42	L40-1021-03	Ferri-inductor 1mH	
L44	L40-1021-03	Ferri-inductor 1mH	
L45	L40-1011-04	Ferri-inductor 100 $\mu$ H	
L46	L40-1021-03	Ferri-inductor 1mH	
L47	L40-1511-03	Ferri-inductor 150 $\mu$ H	
L37.38		Not used	
L43		Not used	
F1.2	L71-0214-05	MCF	☆
F3	L72-0315-05	Ceramic filter AM (W)	☆
F4	L72-0319-05	Ceramic filter AM (N)	☆
F5	L72-0314-15	Ceramic filter SSB	☆
X1	L77-0853-05	Quartz crystal 3.2768 MHz	☆
-	L78-0001-05	Ceramic oscillator BFO $\times$ 1A	☆
SEMICONDUCTOR			
Q1	V09-1002-56	FET 3SK74 (L)	
Q2	V09-0136-10	FET 2SK125	
Q3~7	V09-1002-56	FET 3SK74 (L)	
Q8	V03-1815-06	Transistor 2SC1815 (Y)	
Q9	V09-1002-56	FET 3SK74 (L)	
Q10~15	V03-1815-06	Transistor 2SC1815 (Y)	
Q16	V09-0012-05	FET 2SK19 (GR)	
Q17	V01-1015-06	Transistor 2SA1015 (Y)	
Q18	V09-0012-05	FET 2SK19 (GR)	
Q19~24	V03-1815-06	Transistor 2SC1815 (Y)	
Q25	V03-2240-06	Transistor 2SC2240 (GR)	
Q26	V03-1815-06	Transistor 2SC1815 (Y)	
Q27	V03-2240-06	Transistor 2SC2240 (GR)	
Q28	V30-1129-06	IC HA1368R	☆
Q29	V03-1815-06	Transistor 2SC1815 (Y)	
Q30	V03-0079-05	Transistor 2SC460 (B)	
Q31.32	V03-1815-06	Transistor 2SC1815 (Y)	
Q33	V03-1102-06	IC SN74LS196N	
Q34	V03-1130-06	IC MSM5524	☆
Q35~39	V01-1015-06	Transistor 2SA1015 (Y)	
Q40.41	V03-1959-06	Transistor 2SC1959 (Y)	
Q42~45	V03-1815-06	Transistor 2SC1815 (Y)	

Ref. No.	Parts No.	Description	Re- marks
Q46	V03-1959-06	Transistor 2SC1959 (Y)	
Q47	V03-1815-06	Transistor 2SC1815 (Y)	
D1~6	V11-0414-05	Diode 1S2588	
D7.8	V11-0076-05	Diode 1S1555	
D9~16	V11-0370-05	Diode 1S1587	
D19.20	V11-4160-66	Diode 1S1007	
D21	V11-0370-05	Diode 1S1587	
D22.23	V11-4160-66	Diode 1S1007	
D24	V11-0370-05	Diode 1S1587	
D25~28	V11-0051-05	Diode 1N60	
D29.30	V11-0076-05	Diode 1S1555	
D31	V11-0243-05	Zener diode WZ-061	
D32.33	V11-0051-05	Diode 1N60	
D34	V21-0004-05	Diode MV-13	
D35~37	V11-0051-05	Diode 1N60	
D38.39	V11-0076-05	Diode 1S1555	
D40	V11-4160-86	Zener diode WZ-071	
D42~45	V11-0076-05	Diode 1S1555	
D46	V11-0418-05	Zener diode BZ-052	
D47.48	V11-0076-05	Diode 1S1555	
D49	V11-3162-86	LED AM TLG-205	
D50	V11-3163-16	LED PM TLY-205	
D51~54	V11-0076-05	Diode 1S1555	
D17,18.41		Not used	
SWITCH/RELAY			
S1	S29-1415-05	Rotary switch ATT	☆
S2	S29-1414-05	Rotary switch FUNCTION	☆
S3.4	S50-1403-05	Tact switch	
-	S51-2408-05	Relay G2V2	
POTENTION METER			
VR1	R12-3045-05	Semi-fixed resistor 10k	
VR2	R12-1040-05	Semi-fixed resistor 4.7k	
VR3	R12-3045-05	Semi-fixed resistor 10k	
VR4	R12-6401-05	Semi-fixed resistor 470k	
VR5	R19-3405-05	Potentiometer AFGAIN. TONE	☆
RESISTOR			
R1~229	RD14CB2E000J or RD14BB2E000J	Carbon $\infty \pm 5\%$ 1/4W	
R215		Not used	
RB1	R90-0523-05	Composite resistor 47k $\times$ 12	☆
TRIMMER			
TC1.2	C05-0312-05	Ceramic trimmer 50pF	☆
TC3	C05-0029-15	Ceramic trimmer 50pF	
CAPACITOR			
C1	C91-0456-05	Ceramic 0.047 $\mu$ F 25V	
C2	CC45SL1H050C	Ceramic 5pF $\pm 0.25$ pF	
C3	CE04W1H010	Electrolytic 1 $\mu$ F 50WV	
C4.5	C91-0456-05	Ceramic 0.047 $\mu$ F 25V	
C6	CE04W1H010	Electrolytic 1 $\mu$ F 50WV	
C7.8	CQ92M1H122K	Mylar 0.0012 $\mu$ F $\pm 10\%$	
C9	CC45SL1H271J	Ceramic 270pF $\pm 5\%$	
C11	CC45SL1H271J	Ceramic 270pF $\pm 5\%$	
C12.13	CC45SL1H221J	Ceramic 220pF $\pm 5\%$	
C14	CC45SL1H151J	Ceramic 150pF $\pm 5\%$	
C15	CC45SL1H271J	Ceramic 270pF $\pm 5\%$	
C16	CC45SL1H151J	Ceramic 150pF $\pm 5\%$	
C17	CE04W1H010	Electrolytic 1 $\mu$ F 50WV	
C18.19	C91-0456-05	Ceramic 0.047 $\mu$ F 25V	
C20	CE04W1H010	Electrolytic 1 $\mu$ F 50WV	



# PARTS LIST

Ref. No.	Parts No.	Description	Re- marks	Ref. No.	Parts No.	Description	Re- marks
C21	CC45SL1H150J	Ceramic 15pF ±5%		C121	CE04W1H4R7Q	Electrolytic 4.7μF 50WV	
C22	CC45SL1H120J	Ceramic 12pF ±5%		C122	CC45SL1H121J	Ceramic 120pF ±5%	
C23	CC45SL1H070D	Ceramic 7pF ±0.5pF		C123	CC45CH1H330J	Ceramic 33pF ±5%	
C24	CC45SL1H150J	Ceramic 15pF ±5%		C124	CE04W1H4R7Q	Electrolytic 4.7μF 50WV	
C25	CC45SL1H050C	Ceramic 5pF ±0.25pF		C126	CQ09FS1H101G	Styrene 100pF ±2%	
C26	CE04W1H010	Electrolytic 1μF 50WV		C128	CQ09FS1H221G	Styrene 220pF ±2%	
C27.28	C91-0456-05	Ceramic 0.047μF 25V		C129	CC45SL1H221J	Ceramic 220pF ±5%	
C29	CE04W1H010	Electrolytic 1μF 50WV		C130	CE04W1H4R7Q	Electrolytic 4.7μF 50WV	
C30.31	CC45SL1H270J	Ceramic 27pF ±5%		C131	CC45SL1H121J	Ceramic 120pF ±5%	
C32	CC45SL1H150J	Ceramic 15pF ±5%		C132	CC45CH1H330J	Ceramic 33pF ±5%	
C33	CC45SL1H270J	Ceramic 27pF ±5%		C133	CE04W1H4R7Q	Electrolytic 4.7μF 50WV	
C34	CC45SL1H150J	Ceramic 15pF ±5%		C135	CQ09FS1H101G	Styrene 100pF ±2%	
C35	CE04W1H010	Electrolytic 1μF 50WV		C137	CQ09FS1H221G	Styrene 220pF ±2%	
C36.37	C91-0456-05	Ceramic 0.047μF 25V		C138	CE04W1H010	Electrolytic 1μF 50WV	
C38	CE04W1H010	Electrolytic 1μF 50WV		C139	C91-0456-05	Ceramic 0.047μF 25V	
C39.40.41	CC45SL1H470J	Ceramic 47pF ±5%		C140	CE04W1H4R7Q	Electrolytic 4.7μF 50WV	
C42	CC45SL1H270J	Ceramic 27pF ±5%		C142	C91-0456-05	Ceramic 0.047μF 25V	
C43	CC45SL1H560J	Ceramic 56pF ±5%		C143	CE04W1H010	Electrolytic 1μF 50WV	
C44	CC45SL1H270J	Ceramic 27pF ±5%		C144	C91-0456-05	Ceramic 0.047μF 25V	
C45	CE04W1H010	Electrolytic 1μF 50WV		C145	CE04W1C101Q	Electrolytic 100μF 16WV	
C46.47	C91-0456-05	Ceramic 0.047μF 25V		C146	C91-0456-05	Ceramic 0.047μF 25V	
C48	CE04W1H010	Electrolytic 1μF 50WV		C147	CE04W1HR47	Electrolytic 0.47μF 50WV	
C49~51	CC45SL1H101J	Ceramic 100pF ±5%		C148	C91-0456-05	Ceramic 0.047μF 25V	
C52	CC45SL1H680J	Ceramic 68pF ±5%		C149	CE04W1H010	Electrolytic 1μF 50WV	
C53	CC45SL1H121J	Ceramic 120pF ±5%		C150	CE04W1HR47	Electrolytic 0.47μF 50WV	
C54	CC45SL1H680J	Ceramic 68pF ±5%		C151	C91-0456-05	Ceramic 0.047μF 25V	
C55	CE04W1H010	Electrolytic 1μF 50WV		C154,155	C91-0456-05	Ceramic 0.047μF 25V	
C56.57	C91-0456-05	Ceramic 0.047μF 25V		C156	C91-0457-05	Ceramic 0.022μF	
C58	CE04W1H010	Electrolytic 1μF 50WV		C158	CE04W1A470Q	Electrolytic 47μF 10WV	
C59	CC45SL1H050C	Ceramic 5pF ±0.25pF		C159	CQ92M1H473K	Mylar 0.047μF ±10%	
C60	CC45SL1H030C	Ceramic 3pF ±0.25pF		C160	CQ92M1H104K	Mylar 0.1μF ±10%	
C62~65	C91-0456-05	Ceramic 0.047μF 25V		C161	CE04W1E100Q	Electrolytic 10μF 25WV	
C66	CE04W1C470Q	Electrolytic 47μF 16WV		C162	C91-0456-05	Ceramic 0.047μF 25V	
C67	CC45SL1H070D	Ceramic 7pF ±0.5pF		C164	CC45SL1H101J	Ceramic 100pF ±5%	
C68	CE04W1C470Q	Electrolytic 47μF 16WV		C166	CC45SL1H151J	Ceramic 150pF ±5%	
C69.70	C91-0456-05	Ceramic 0.047μF 25V		C167	CE04W1H4R7Q	Electrolytic 4.7μF 50WV	
C71.72	CC45SL1H150J	Ceramic 15pF ±5%		C168	CE04W1A470Q	Electrolytic 47μF 10WV	
C74.75	C91-0456-05	Ceramic 0.047μF 25V		C169	CE04W1HR47	Electrolytic 0.47μF 50WV	
C76	CC45RH1H050C	Ceramic 5pF ±0.25pF		C170	CE04W1E100Q	Electrolytic 10μF 25W	
C77	C91-0456-05	Ceramic 0.047μF 25V		C172	CE04W1H010	Electrolytic 1μF 50WV	
C78	CC45RH1H220J	Ceramic 22pF ±5%		C175,176	CE04W1A101Q	Electrolytic 100μF 10WV	
C79	CC45RH1H100D	Ceramic 10pF ±0.5pF		C177,178	CE04W1HR47	Electrolytic 0.47μF 50WV	
C80	CC45RH1H030C	Ceramic 3pF ±0.25pF		C179,180	CQ92M1H473K	Mylar 0.047μF ±10%	
C81	CC45RH1H100D	Ceramic 10pF ±0.5pF		C183	CE04W1H4R7Q	Electrolytic 4.7μF 50WV	
C82	CC45RH1H220J	Ceramic 22pF ±5%		C184	CE04W1A101Q	Electrolytic 100μF 10WV	
C83	CC45RH1H030C	Ceramic 3pF ±0.25pF		C186	CE04W1C102Q	Electrolytic 1000μF 16WV	
C84	C91-0456-05	Ceramic 0.047μF 25V		C187	CE04W1A470Q	Electrolytic 47μF 10WV	
C85	CC45RH1H030C	Ceramic 3pF ±0.25pF		C188,189	CC45SL1H120J	Ceramic 12pF ±5%	
C86~88	C91-0456-05	Ceramic 0.047μF 25V		C190	CQ92M1H104k	Mylar 0.1μF ±10%	
C91	CC45SL1H270J	Ceramic 27pF ±5%		C191	CE04W1C102Q	Electrolytic 1000μF 16WV	
C92~94	CE04W1E100Q	Electrolytic 10μF 25WV		C193	CC45SL1H120J	Ceramic 12pF ±5%	
C95	C91-0456-05	Ceramic 0.047μF 25V		C194,195	C91-0456-05	Ceramic 0.047μF 25V	
C97~102	CE04W1E100Q	Electrolytic 10μF 25WV		C197	C91-0456-05	Ceramic 0.047μF 25V	
C105,106	C91-0456-05	Ceramic 0.047μF 25V		C198	CE04W1H3R3Q	Electrolytic 3.3μF 50WV	
C107	CE04W1E100Q	Electrolytic 10μF 25WV		C199	C91-0456-05	Ceramic 0.047μF 25V	
C108	C91-0456-05	Ceramic 0.047μF 25V		C200	CE04W1H100Q	Electrolytic 10μF 50WV	
C111	C91-0456-05	Ceramic 0.047μF 25V		C201	CE04W1E100Q	Electrolytic 10μF 25WV	
C114,115	C91-0456-05	Ceramic 0.047μF 25V		C202	CE04W1H100Q	Electrolytic 10μF 50WV	
C116	CE04W1E100Q	Electrolytic 10μF 25WV		C205	CE04W1E100Q	Electrolytic 10μF 25WV	
C117	C91-0456-05	Ceramic 0.047μF 25V		C206	CE04W1C221Q	Electrolytic 220μF 16WV	
C118	CC45SL1H101J	Ceramic 100pF ±5%		C207,208	CE04W1A470Q	Electrolytic 47μF 10WV	
C119	C91-0457-05	Ceramic 0.022μF 25V		C209	CC45CH1H470J	Ceramic 47pF ±5%	
C120	C91-0456-05	Ceramic 0.047μF 25V		C210	CC45SL1H020C	Ceramic 2pF ±0.25pF	

# PARTS LIST/EXPLODED VIEW/DISASSEMBLY

Ref. No.	Parts No.	Description	Re- marks
C212	C91-0456-05	Ceramic 0.047 $\mu$ F 25V	
C214,215	C91-0456-05	Ceramic 0.047 $\mu$ F 25V	
C216	CE04W1A101Q	Electrolytic 100 $\mu$ F 10WV	
C217	CE04W1H010	Electrolytic 1 $\mu$ F 50WV	

Ref. No.	Parts No.	Description	Re- marks
C220	CC45CH1H100D	Ceramic 10pF $\pm$ 0.5pF	
C125.134		Not used	
C158.173		Not used	

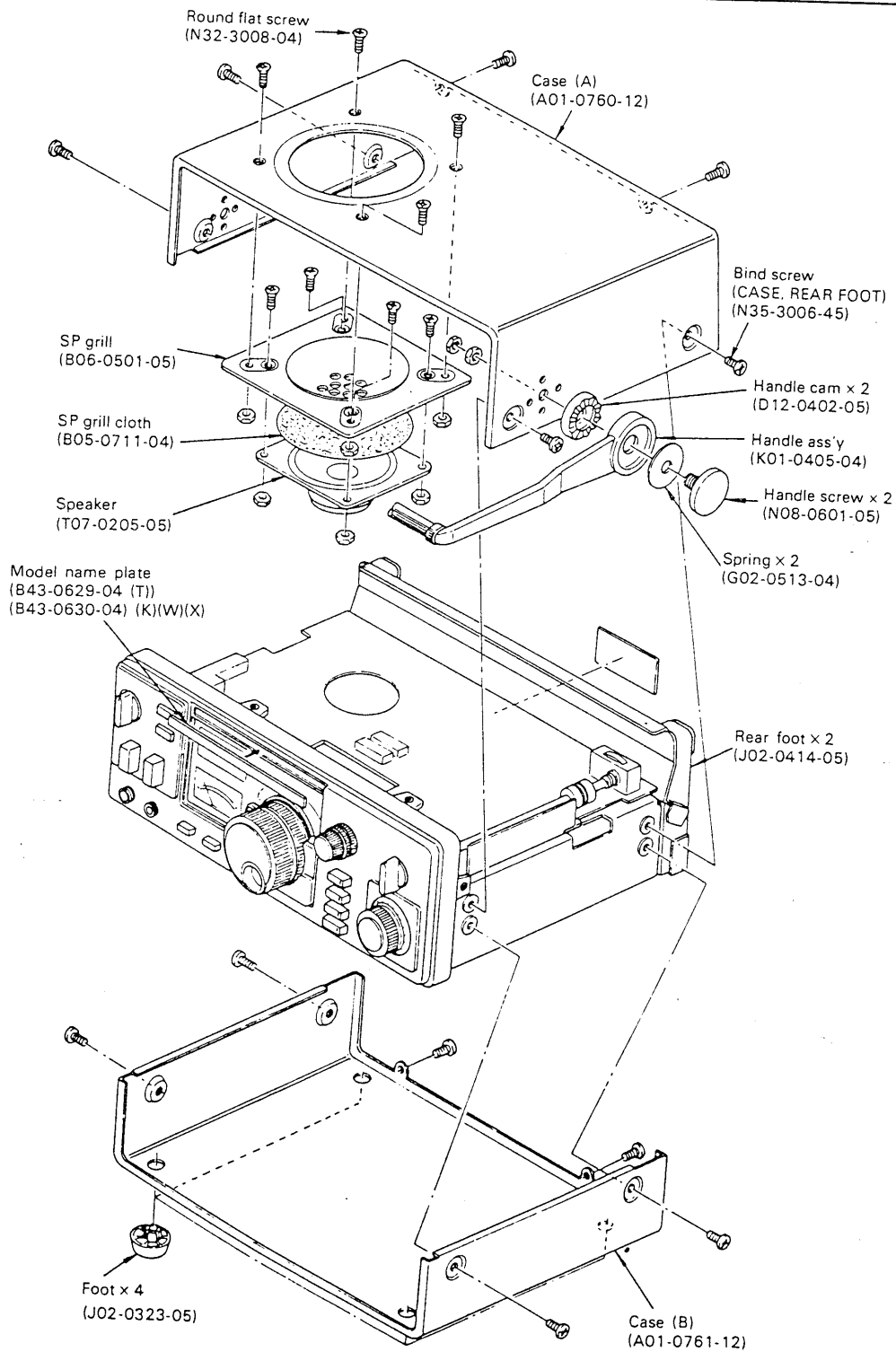

Fig. 3 Case disassembly

# EXPLODED VIEW/DISASSEMBLY

## How to disassemble the RX unit

1. Remove the RF ATT. FUNCTION, AF GAIN and TUNE knobs.
2. Remove the nuts of these controls with a box wrench (11 mm).
3. Remove the 9 retaining screws from the RX unit.

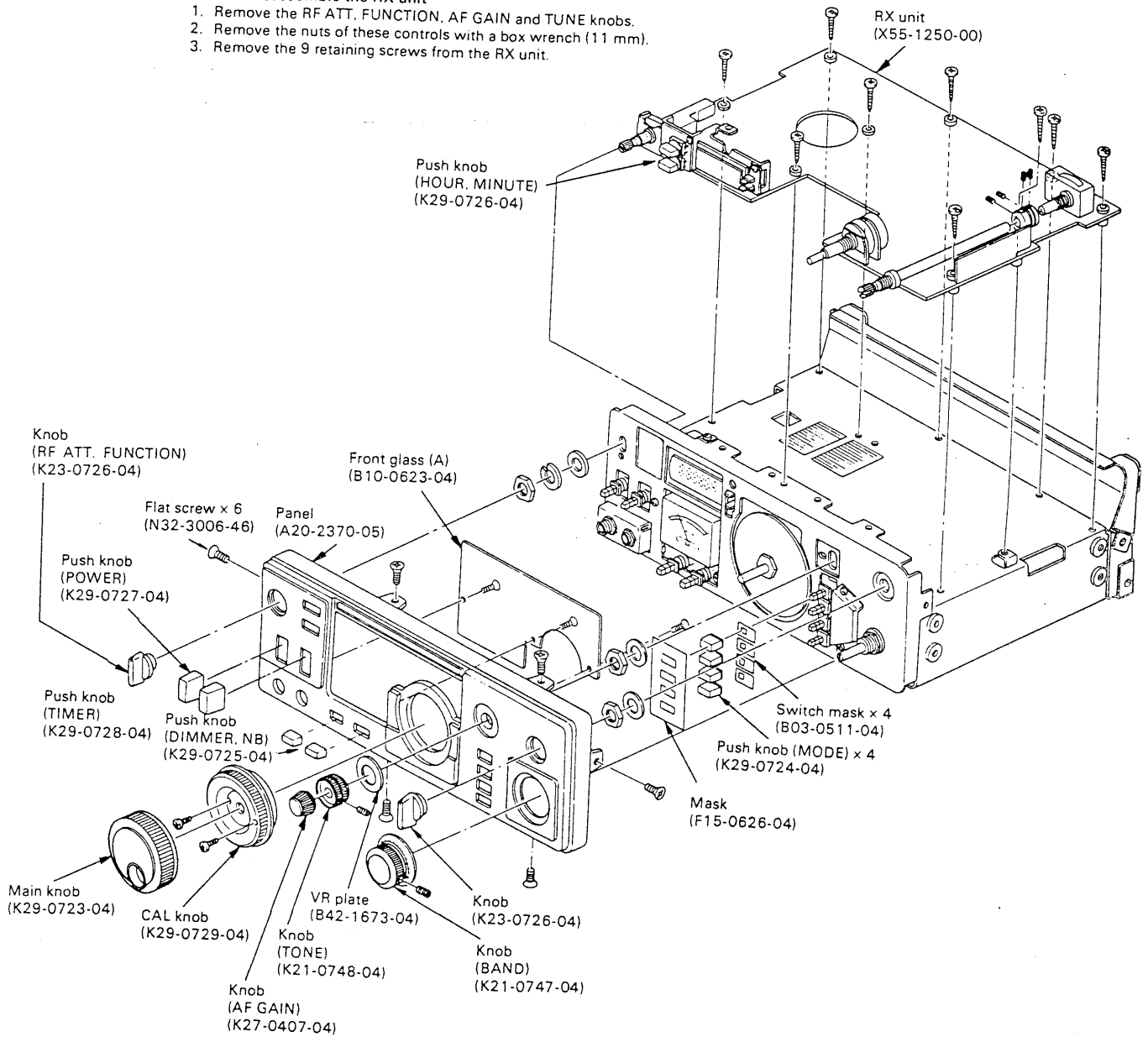

Fig. 4 Front panel and RX unit disassembly

# EXPLODED VIEW/DISASSEMBLY/PACKING

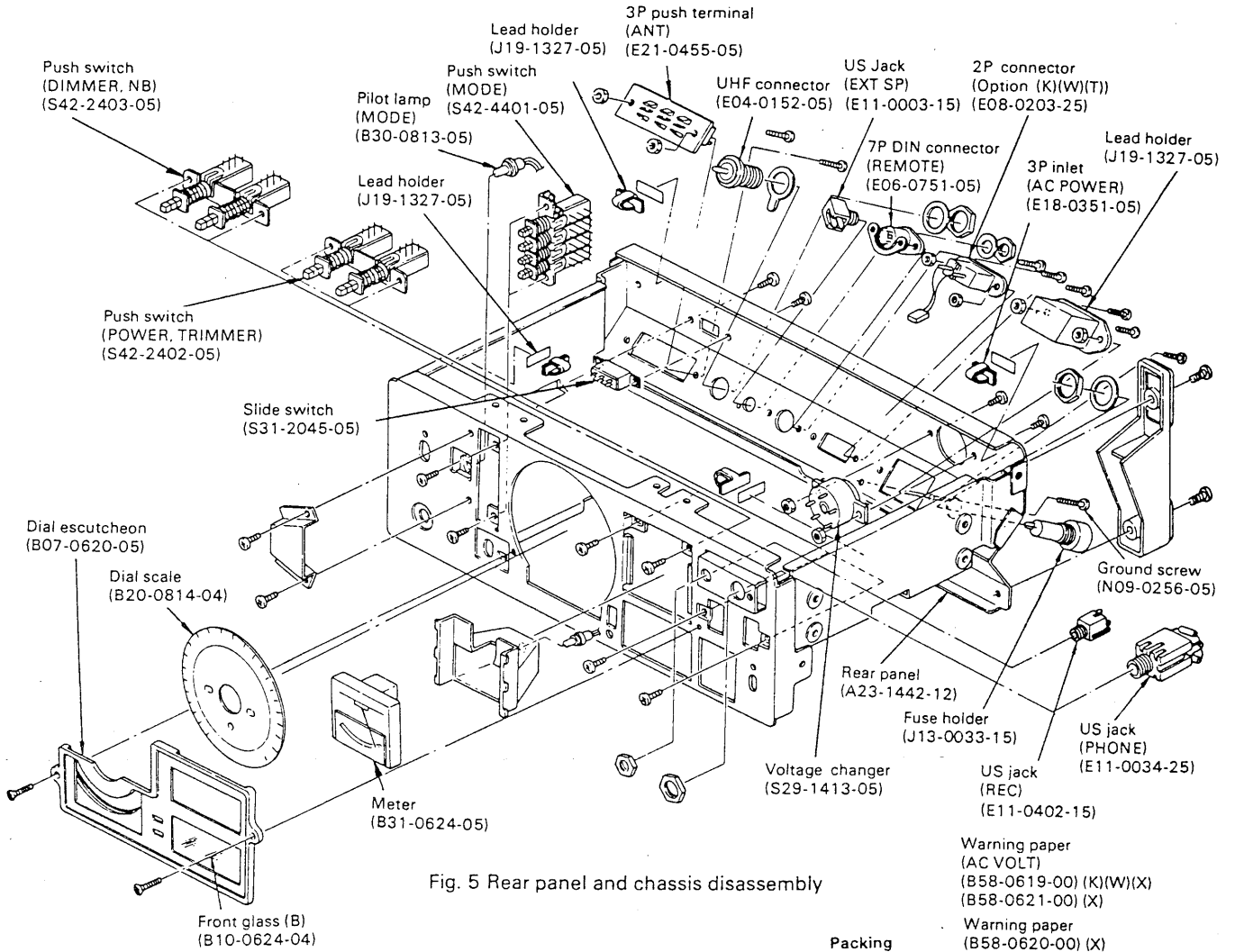

Fig. 5 Rear panel and chassis disassembly

- Small bag (H25-0029-04)
- Fuse (0.7A) (F05-7011-05)
  - Fuse (1A) (F05-1023-05)
  - Phone plug (E12-0001-05)
  - 7P DIN plug (E07-0751-05)

- Large bag (H25-0105-04)
- AC cord ass'y (E30-1643-15)(K)
  - AC cord ass'y (E30-1644-15)(T)
  - AC cord ass'y (E30-1645-15)(W)
  - AC cord ass'y (E30-1647-15)(X)
  - DC cord ass'y (E30-1646-05)(X)
  - Wire (021-4991-05) antenna 5m

For Service Manuals  
**MAURITRON SERVICES**  
 8 Cherry Tree Road, Chinnor  
 Oxfordshire, OX9 4QY.  
 Tel (01844) 351694  
 Fax (01844) 352554  
 email:- sales@mauritron.co.uk

# TROUBLE SHOOTING

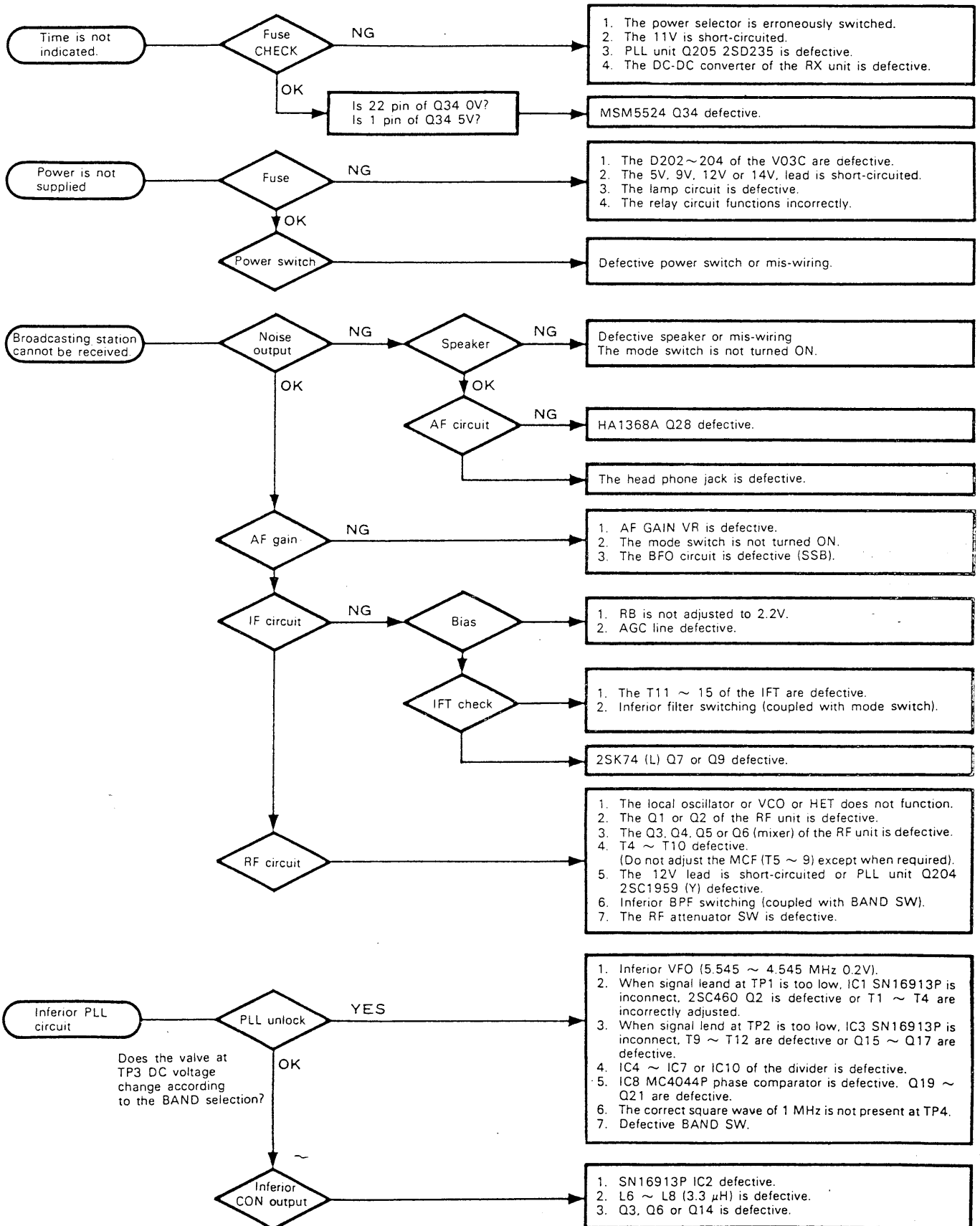

# ADJUSTMENT

## GENERAL

Adjustment procedures for this receiver are classified into formal adjustments requiring a full service bench and simplified adjustment using a VTVM, AF and RF VTVM, AG and AF and RF dummy load.

Complete adjustment also requires a frequency counter, SSG, sweep generator, tracking generator, spectrum analyzer, high-impedance probe and so on.

## TEST EQUIPMENT REQUIRED

### 1. SSVM or DVM

- 1) Input resistance: More than 1 M $\Omega$
- 2) Voltage range: FS = 1.5 ~ 50V DC

#### Note:

High-precision voltmeter may be used. However accurate reading can not be obtained for high-impedance circuits.

### 2. RF VTVM

- 1) Input impedance: 1 M $\Omega$  and less than 3 pF min.
- 2) Voltage range: 10 mV to 30V.
- 3) Frequency range: 100 MHz or greater.

### 3. AF DUMMY LOAD

- 1) Impedance: 8 $\Omega$
- 2) Dissipation: 3W or greater.

### 4. OSCILLOSCOPE

Requires high sensitivity and external synchronization capability.

### 5. SSG (Standard Signal Generator) (EX. ANRITSU MG518B)

- 1) Frequency range: 200 kHz to 100 MHz.
- 2) Output: -6 dB ~ 120 dB (0.25 $\mu$ V ~ 0.5V).
- 3) Output: 50 $\Omega$

Generator must be frequency stable and with sweep function.

### 6. FREQUENCY COUNTER

- 1) Minimum input voltage: 50 mV
- 2) Frequency range: Greater than 100 MHz

### 7. SPECTRUM ANALYZER

Frequency range: Greater than 100 MHz

### 8. TRACKING GENERATOR

(EX. HEWLETT PACKARD 8443A)

### 9. HIGH-IMPEDANCE PROBE

(EX. HEWLETT PACKARD 1121A)

### 10. NOISE GENERATOR

Must generate ignition-like noise containing harmonics beyond 30 MHz.

## PREOPERATION

1. Remove the upper and lower cases as shown Figure 3.
2. Setting

Unless otherwise specified, set the controls as follows:

- 1) Rear panel
  - Voltage selector switch..... 120V (K) 220V (W)  
240V (T). (X)

SW ANT Select..... SWA

- 2) Front panel

POWER SW..... OFF

TIMER SW..... OFF

FUNCTION SW..... FREQUENCY

DIMMER SW..... OFF

NB SW..... OFF

AF GAIN..... FULL COUNTERCLOCKWISE

TONE..... FULL CLOCKWISE

RF ATT..... 0 dB

## POWER SUPPLY ADJUSTMENT

### 9V ADJUSTMENT

1. Instrument  
DC SSVM or digital voltmeter
2. Adjusting procedure  
Connect the digital voltmeter to No. 4 connector (1 pin) on the RX unit (X55-1250-00) and adjust VR2 on the PLL unit (X50-1610-00) for 9V.

### RB LINE ADJUSTMENT

1. Instrument  
DC SSVM or digital voltmeter.
2. Adjusting procedure  
Connect the digital voltmeter to TP3 on the RX unit (X55-1250-00) and adjust VR1 on the RX unit for 2.2V  $\pm$  0.05V.

## RX ADJUSTMENT

### BFO ADJUSTMENT

1. Instrument  
Frequency counter.
2. Adjusting procedure  
Connect the frequency counter to TP6 on the RX unit (X55-1250-00) and adjust TC1, TC2 on the RX unit for below frequency.

MODE SW	FREQUENCY	TRIMMER
USB	456.6 kHz $\pm$ 10 Hz	TC1
LSB	453.4 kHz $\pm$ 10 Hz	TC2

# ADJUSTMENT

## CHECK VFO OUTPUT LEVEL

1. Instrument  
RF VTVM.
2. Check  
Connect the RF VTVM to 3 pin connector (No. 3 pin) on the PLL unit (X50-1610-00) and check that the VFO output is  $0.2V \pm 3 \text{ dB}$  (Refer to Fig. 8)

## VCO VOLTAGE ADJUSTMENT

1. Instruments
  - 1) Frequency counter.
  - 2) VTVM or DVM.
2. Adjusting procedure  
Connect the frequency counter to VCO terminal on the PLL unit (X50-1610-00). Also, connect the **voltmeter to TP3** on the PLL unit. After connecting, check that frequency and adjust at the below point by voltmeter.

BAND VFO	VCO Voltage	Frequency	Adj. Point
4 MHz 500	3.8V $\pm 0.05V$	52.555 MHz	T5
12 MHz 0		60.055 MHz	T6
19 MHz 500		67.555 MHz	T7
26 MHz 500		74.555 MHz	T8

## CLOCK STANDARD OSCILLATOR ADJUSTMENT

1. Instrument  
Frequency counter
2. Adjusting procedure  
Connect the frequency counter to TP7 on the RX unit (X55-1250-00) and adjust TC3 on the RX unit for  $3.2768 \text{ MHz} \pm 5 \text{ Hz}$ .

## RF, IF AMP ADJUSTMENT

1. Instruments
  - 1) SSG (Standard Signal Generator).
  - 2) Oscilloscope.
  - 3) Audio SSVM.
2. Adjusting procedure
  - 1) Setting BAND: 14 MHz  
MODE SW: USB  
ATT SW: 0 dB  
VFO Scale: 500
  - 2) Apply a signal of 14.500 MHz at 0 dB to the antenna terminal.
  - 3) Adjust T4, T10, T11, T12, T13, T14, T15 on the RX unit for maximum audio SSVM reading.

## IF TRAP COIL ADJUSTMENT

1. Instruments
  - 1) SSG.
  - 2) Audio SSVM.
  - 3) Oscilloscope.
2. Adjusting procedure
  - 1) Setting BAND: 29 MHz  
VFO: 500  
MODE: USB.
  - 2) Apply a signal of 48.055 MHz at 90 dB to the antenna terminal.
  - 3) Adjust T19 on the RX unit (X55-1250-00) until the S-meter reading becomes minimum. When the S-meter 0 does not deflect, make adjustments until the AF output becomes minimum.

## MCF ADJUSTMENT (Requires a Tracking Generator)

1. Instruments
  - 1) Tracking generator.
  - 2) Spectrum analyzer.
  - 3) High-impedance probe.
2. Adjusting procedure
  - 1) Disconnect the No. 18 connector (4 pins) on the RX unit (X55-1250-00).
  - 2) Setting, spectrum analyzer:  
SCAN WIDTH: 5 kHz/div. LINEAR.
  - 3) Connect the tracking generator output at  $-40 \text{ dBm}$  to TP-1 on the RX unit (X55-1250-00), and connect the spectrum analyzer input to TP-2 on the RX unit with high-impedance probe.
  - 4) Adjust MANUAL SCAN of spectrum analyzer until the brown tube become the centered (48.055 MHz).
  - 5) Adjust T5, T6, T7, T8, T9 on the RX unit until brown tube's wave level become maximum.
  - 6) Adjust T7 on the RX unit until brown tube's wave become trapezoidal patterns.
  - 7) Connect the No. 18 connector (4 pins).

## MCF ADJUSTMENT (Requires a SSG (EX. ANRITSU MG518B))

1. Instrument
  - 1) SSG (EX. ANRITSU MG518B).
  - 2) Spectrum analyzer.
  - 3) High-impedance probe.
2. Adjusting procedure
  - 1) Tracking generator.
  - 2) Spectrum analyzer.
  - 3) Setting, SG: FUNCTION, MODULATION is SWEEP
  - 4) Connect the **SSG output to TP1** on the RX unit (X55-1250-00).
  - 5) **Apply SSG output at 70 dB to the TP1** on the RX unit, also connect the frequency counter to SSG (rear panel connector).

# ADJUSTMENT

- 6) Connect the **spectrum analyzer** input to TP2 on the RX unit with high-impedance probe.
- 7) Same adjust Section "MCF ADJUSTMENT (Requires a Tracking Generator)".
- 8) Connect No. 18 connector.

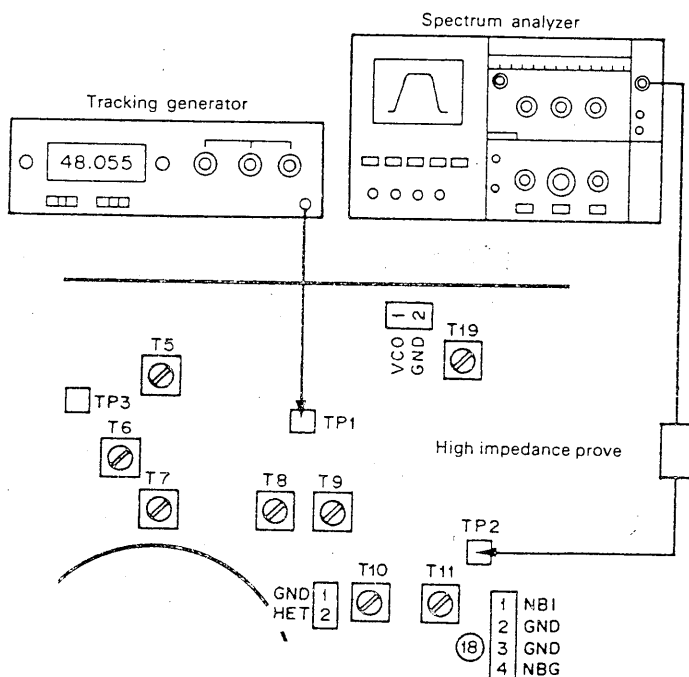
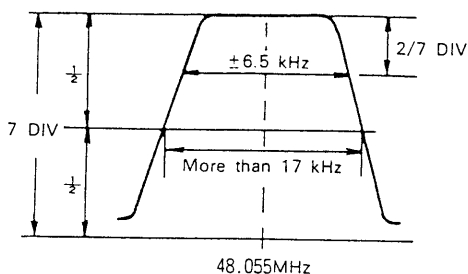

Fig. 6

## NOISE BLANKER ADJUSTMENT

1. Instrument  
Noise generator with ATT.
2. Adjusting procedure
  - 1) Connect the noise generator to the antenna terminal and set the generator output for an S-meter reading within S5 to S7.
  - 2) Push on NB switch and adjust VR2 on the RX unit (X55-1250-00) until the noise level become minimum.
  - 3) Reduce the noise generator output and adjust T16, T17 on the RX unit until the slight noise become effective.

## S-METER ADJUSTMENT

1. Instrument  
SSG.
2. Adjusting procedure
  - 1) BAND: 14 MHz  
VFO: 500  
MODE: USB  
NB SW: OFF
  - 2) Adjust VR3 on the RX unit (X55-1250-00) with no signal condition, input for S-meter zero.
  - 3) Apply a signal of 14.5 MHz at 8 dB to the antenna terminal and adjust T14 on the RX unit for an S-1 reading.
  - 4) Set the SSG output to 30 dB and adjust VR4 on the RX unit for on S-9 reading.

## PLL ADJUSTMENT

### 10 MHz XTAL FREQUENCY ADJUSTMENT

1. Instrument  
Frequency counter.
2. Adjusting procedure  
Connect the frequency counter to TP4 on the PLL unit (X50-1610-00) and adjust TC1 on the PLL unit for 1 MHz  $\pm$  5 Hz.

### 42.555 MHz BPF ADJUSTMENT

1. Instrument  
RF VTVM.
2. Adjusting procedure  
Set the VFO scale to 500, connect the RF VTVM to TP1 on the PLL unit (X50-1610-00). Then, adjust T1, T2, T3, T4 on the PLL unit until the RF VTVM reads max.

### 6 TO 35 MHz BPF ADJUSTMENT

1. Instruments
  - 1) RF VTVM.
  - 2) SSG.
2. Adjusting procedure
  - 1) Set the VFO scale to 500.
  - 2) Disconnect No. 6 (4 pins) connector on the PLL unit (X50-1610-00).
  - 3) Connect the RF VTVM to TP2 on the PLL unit and apply signal of 81.550 MHz at 110 dB from D8's cathode on the PLL unit.
  - 4) Adjust T9, T10, T11, T12 on the PLL unit until RF VTVM reads max.
  - 5) Set the SSG output to 85.050 MHz, adjust T11 on the RX unit until RF VTVM reads Minimum.
  - 6) Set the SSG output to 81.550 MHz again, adjust T9, T10, T12 on the PLL unit and check that RF VTVM reads is same level to item 4).
  - 7) Set the SSG output to 78.550 MHz, check that RF VTVM reads is less than 4 dB to item 4).



# ALIGNMENT

## ▼ RX UNIT (X55-1250-00)

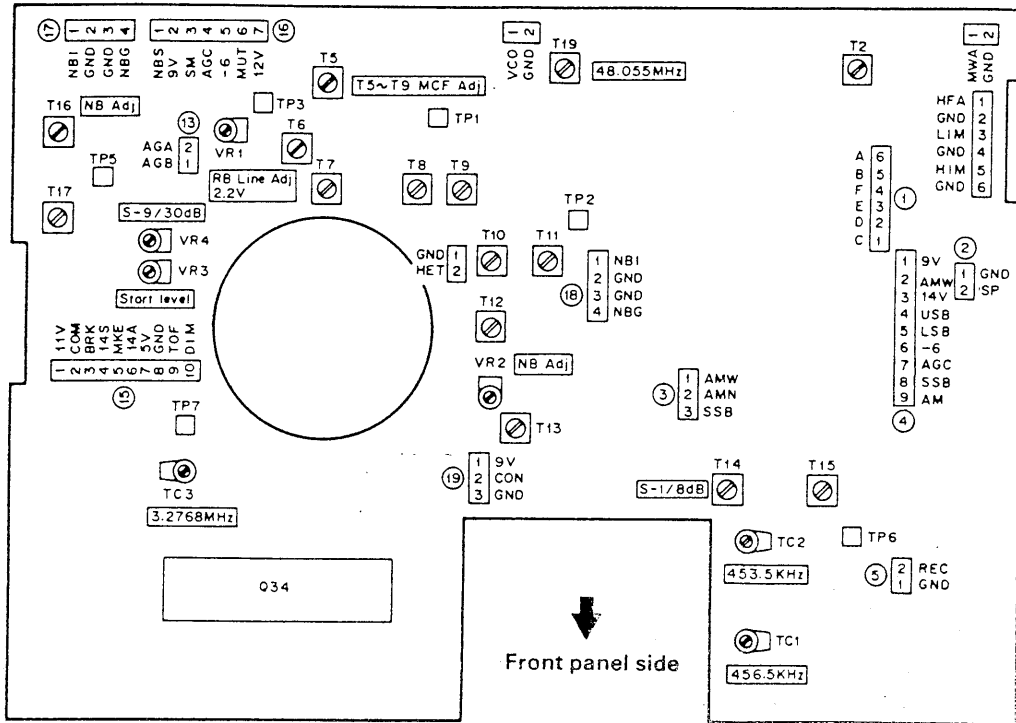

Fig. 7

## ▼ PLL UNIT (X50-1610-00)

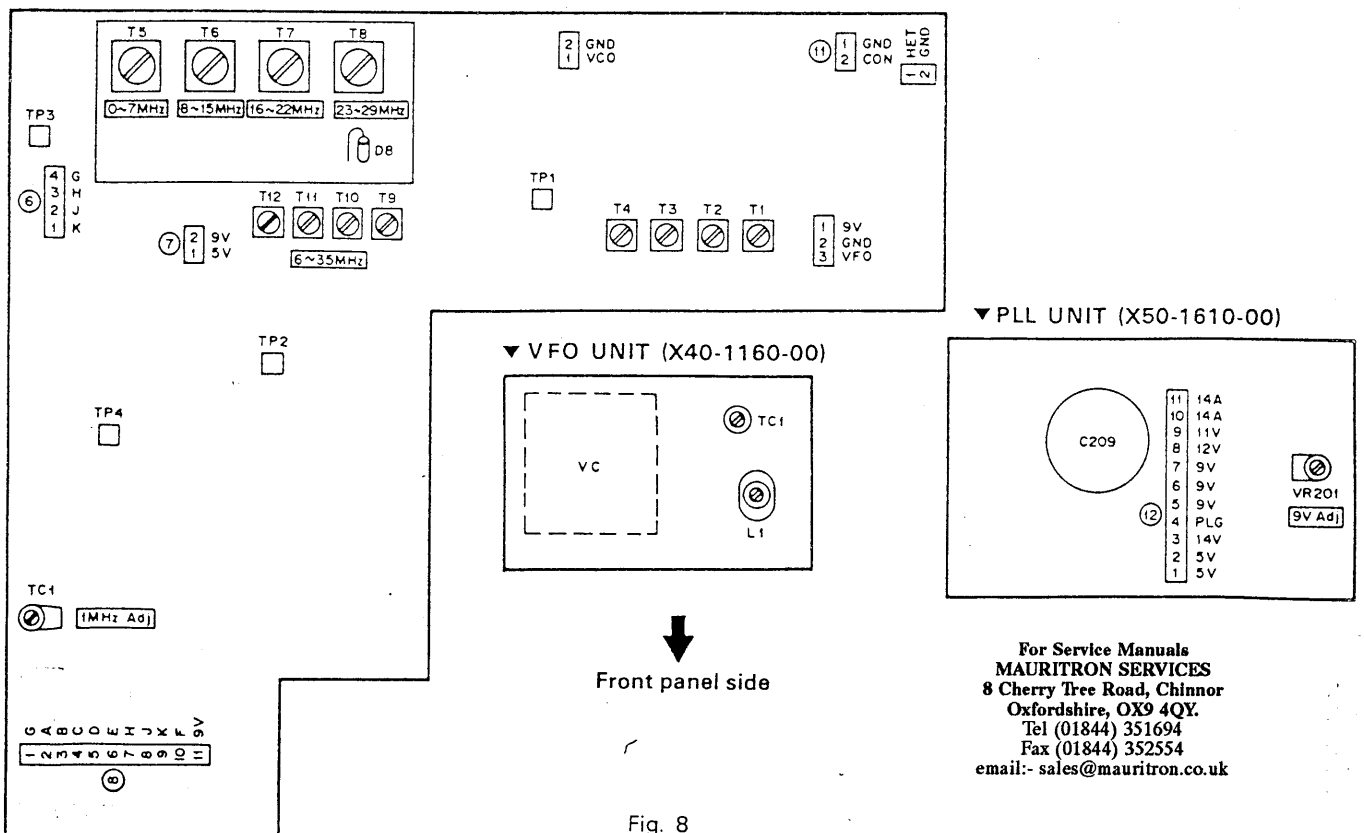
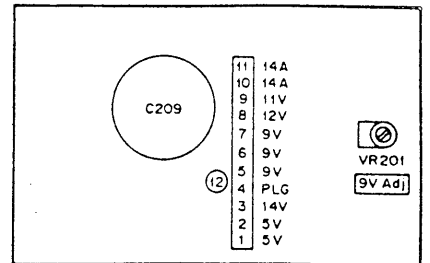

Fig. 8

## ▼ PLL UNIT (X50-1610-00)



For Service Manuals  
**MAURITRON SERVICES**  
 8 Cherry Tree Road, Chinnor  
 Oxfordshire, OX9 4QY.  
 Tel (01844) 351694  
 Fax (01844) 352554  
 email:- sales@mauritron.co.uk

# WIREHARNES

Symbol color:  
 BLU Blue  
 BRN Brown  
 GRN Green  
 GRY Gray  
 ORA Orange  
 VLT Violet  
 WHT White  
 YLW Yellow

Connector No.	Terminal No.	Color	Destination		Terminal No.	Connector No.	Terminal No.	Color	Destination		Terminal No.				
			Connector No.	Terminal No.					Connector No.	Terminal No.					
①	1	WHT/RED	⑧	4	C	⑬	1	WHT/ORA	④	13	AGB				
	2	WHT/BRN	⑧	5	D		2	WHT/BLU	④	12	AGA				
	3	WHT/YLW	⑧	6	E		⑭	1 } 2 }	RED	⑥	7				
	4	WHT/BLU	⑧	10	F					⑥	8				
	5	WHT/VLT	⑧	3	B		⑮	1	WHT/VLT	⑫	9	11V			
	6	WHT/ORA	⑧	2	A			2	BRN	⑥	5	COM			
②	1 } 2 }	YLW	③	1	GND	3		BLU	⑥	4	BRK				
			③	2	SP	4		GRY	③	12	14S				
	③	1	WHT/BRN	④	1	AMW		5	ORA	⑥	6	MKE			
		2	WHT/RED	④	2	AMN		6	WHT/GRN	⑫	10	14A			
		3	WHT/YLW	④	3	SSB	7	WHT/YLW	⑫	1	5V				
	④	1	VLT	④	11	9V	8	VLT	③	8	TOF				
2		WHT	④	14	AMW	9	GRN	③	7	DIM					
3		RED	④	15	14V	⑯	1 } 2 } 3 } 4 }	ORA WHT/BRN BRN WHT/YLW WHT/RED YLW WHT/ORA	③	10	NBS				
4		GRY	④	7	USB				③	5	9V				
5		BLU	④	6	LSB				③	9	SM				
6		WHT/RED	⑥	5	-6				④	6	AGC				
7		WHT/YLW	⑥	4	AGC				④	5	-6				
8		ORA	④	4	SSB				⑥	3	MUT				
9		GRN	④	5	AM	⑥	8	12V							
⑤	1 } 2 }	GRN	③	5	GND	⑰	1 } 2 } 3 } 4 }	COAX. CABLE BRN	⑬	1	NBI				
			③	6	REC				⑬	2	GND				
	⑥	1	RED	⑧	9				K	⑱	1 } 2 } 3 } 4 }	COAX. CABLE BRN	⑰	1	NBI
		2	BLU	⑧	8				J				⑰	2	GND
3		GRN	⑧	7	H	⑰	3	GND							
4		BRN	⑧	1	G	⑰	4	NBG							
⑦	1	WHT/RED	⑫	2	5V	⑲	1 } 2 }	WHT/BLU COAX.	⑫	6	9V				
	2	BRN	④	9	9V				⑪	2	CON				
⑧	1	BRN	⑥	4	G	⑳	① } ② } ③ } ④ } ⑤ } ⑥ } ⑦ } ⑧ } ⑨ } ⑩ } ⑪ } ⑫ } ⑬ }	WHT/BRN WHT/RED WHT/YLW ORA GRN BLU GRY RED BRN YLW VLT WHT/BLU WHT/ORA	③	1	AMW				
	2	WHT/ORA	①	6	A				③	2	AMN				
	3	WHT/VLT	①	5	B				③	3	SSB				
	4	WHT/RED	①	1	C				④	7	SSB				
	5	WHT/BRN	①	2	D				④	8	AM				
	6	WHT/YLW	①	3	E				④	4	LSB				
	7	GRN	⑥	3	H				④	3	USB				
	8	BLU	⑥	2	J				④	4	LSB				
	9	RED	⑥	1	K				④	3	USB				
	10	WHT/BLU	①	4	F				⑫	7	9V				
	11	YLW	④	10	9V				⑦	2	9V				
⑩	1 } 2 }	COAX. CABLE	⑬	3	GND	⑧	11	9V							
			⑬	2	CON	④	1	9V							
⑫	1	WHT/YLW	⑬	7	5V	㉑	① } ② } ③ } ④ } ⑤ } ⑥ } ⑦ } ⑧ }	BLU YLW BLU BRN ORA RED	⑬	2	AGA				
	2	WHT/RED	⑦	1	5V				⑬	1	AGB				
	3	WHT	③	14	14V				④	4					
	4	BLU	③	11	PLG				④	3					
	5	WHT/BRN	⑬	2	9V				⑬	6	MUT				
	6	WHT/BLU	⑬	1	9V				⑬	3	BRK				
	7	RED	④	8	9V				⑬	2	COM				
	8	WHT/ORA	⑬	7	12V				⑬	5	MKE				
	9	WHT/VLT	⑬	1	11V				⑬	1					
	10	WHT/GRN	⑬	6	14A				⑬	2					
	11	YLW	③	13	14A										

**Connector No.**  
**P.C. Board and Parts Name**  
 ①~⑤ RX UNIT(X55-1250-00)  
 ⑥~⑧ PLL UNIT(X50-1610-00)  
 ⑩~⑫ PLL UNIT(X50-1610-00)  
 ⑬ RX UNIT(X55-1250-00)  
 ⑭ PLL UNIT(X50-1610-00)  
 ⑮ RX UNIT(X55-1250-00)  
 ① MODE SWITCH  
 ② REMOTE, EXT.SP  
 ③ PHONE, METER, TIMER, REC



# SP-100

## SP-100 SPECIFICATIONS

Speaker Size:	10 cm
Rated Input	1.5W
Impedance:	8Ω
Frequency Response:	200 Hz ~ 10 kHz
Dimensions:	149 (W) × 115 (H) × 211 (D) mm 5-7/8 (W) × 4-1/2 (H) × 8-15/16 (D) inch
Weight:	Approx. 1.5 kg (3.3 lbs)

## SP-100 PARTS LIST

### GENERAL

Ref. No.	Parts No.	Description	Re- marks
—	A01-0765-02	Case	☆
—	A20-2373-15	Panel	☆
—	B04-0402-04	SP net	☆
—	B07-0622-04	SP ling	☆
—	B43-0632-04	Name plate (T)	☆
—	B43-0633-04	Name plate (K)	☆
—	B39-0407-04	Spacer	
—	G53-0509-04	Packing	
—	G53-0508-04	Packing	
—	B50-2695-00	Operating manual (K)	☆
—	B50-2696-00	Operating manual (T)	☆
—	E20-0208-04	Terminal plate	
—	E30-1629-05	SP Cord	
—	J02-0323-05	Foot	
—	J02-0417-04	Assistant foot	☆
—	J21-2573-04	Foots mounting metal	
—	J61-0019-05	Vinyletie	
—	T07-0207-05	Speaker	☆
—	H01-2660-04	Carton (K)	☆
—	H01-2661-04	Carton (T)	☆
—	H10-2526-02	Right side packing fixture	
—	H10-2527-02	Left side packing fixture	
—	H20-1407-03	Protective cover	
—	H25-0077-03	Protective bag	

## DCK-1

### DC CORD KIT PARTS LIST

#### OPTION (K)(W)(T)

Ref. No.	Parts No.	Description	Re- marks
—	B50-2703-00	Operating manual	☆
—	E08-0203-25	2P Connector	
—	E31-2027-05	Cable with terminal	
—	E30-1646-05	DC cord ASSY	
—	F05-1023-05	Fuse UL 1A × 2	
—	H25-0029-04	Protective bag 60mm × 110mm	
—	H25-0117-04	Protective bag 80mm × 250mm	

# LEVEL DIAGRAM

2SA1015(Y)  
2SC1775(E)  
2SC1815(Y)  
2SC1959(Y)  
2SC2240(GR)

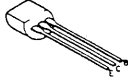

2SC460(B)

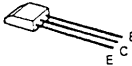

2SA473(Y)  
2SD880(Y)

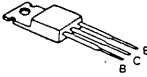

2SK19(Y), (GR)

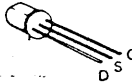

2SK125

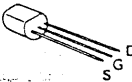

μPC14305

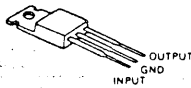

3SK74(L)

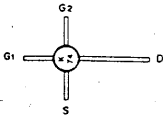

SN16913P

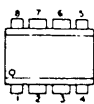

HA1368(R)



SN74S00N  
SN74S74N  
SN74LS196N  
HD74LS90P  
MC4044P

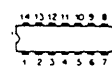

SN74S112N  
HD74LS163P

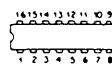

MSM5524

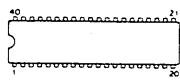

## REFERENCE

Japanese "SG"	American "SG"
-6 dB.	0.25 $\mu$ V
0 dB.	0.5 $\mu$ V
6 dB.	1 $\mu$ V
12 dB.	2 $\mu$ V
24 dB.	8 $\mu$ V
30 dB.	15.8 $\mu$ V
40 dB.	50 $\mu$ V
50 dB.	158 $\mu$ V
60 dB.	500 $\mu$ V
70 dB.	1.58 mV
80 dB.	5 mV
90 dB.	15.8 mV
100 dB.	50 mV
120 dB.	0.5V

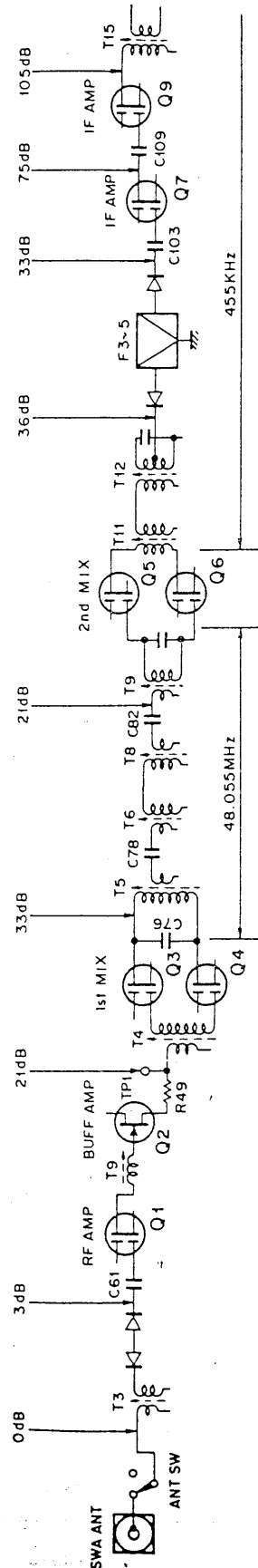

## NOTES:

- The figures shown are signal generator output required for a constant audio output with a constant AF gain control setting. Set the AF gain control for 0.63V/8 $\Omega$  (50 mW) audio output at 0 dB signal generator input from ANT terminal at 14.250 MHz.
- To measure signal generator output connect a 0.01  $\mu$ F, 500WV capacitor between the signal generator and the check point.

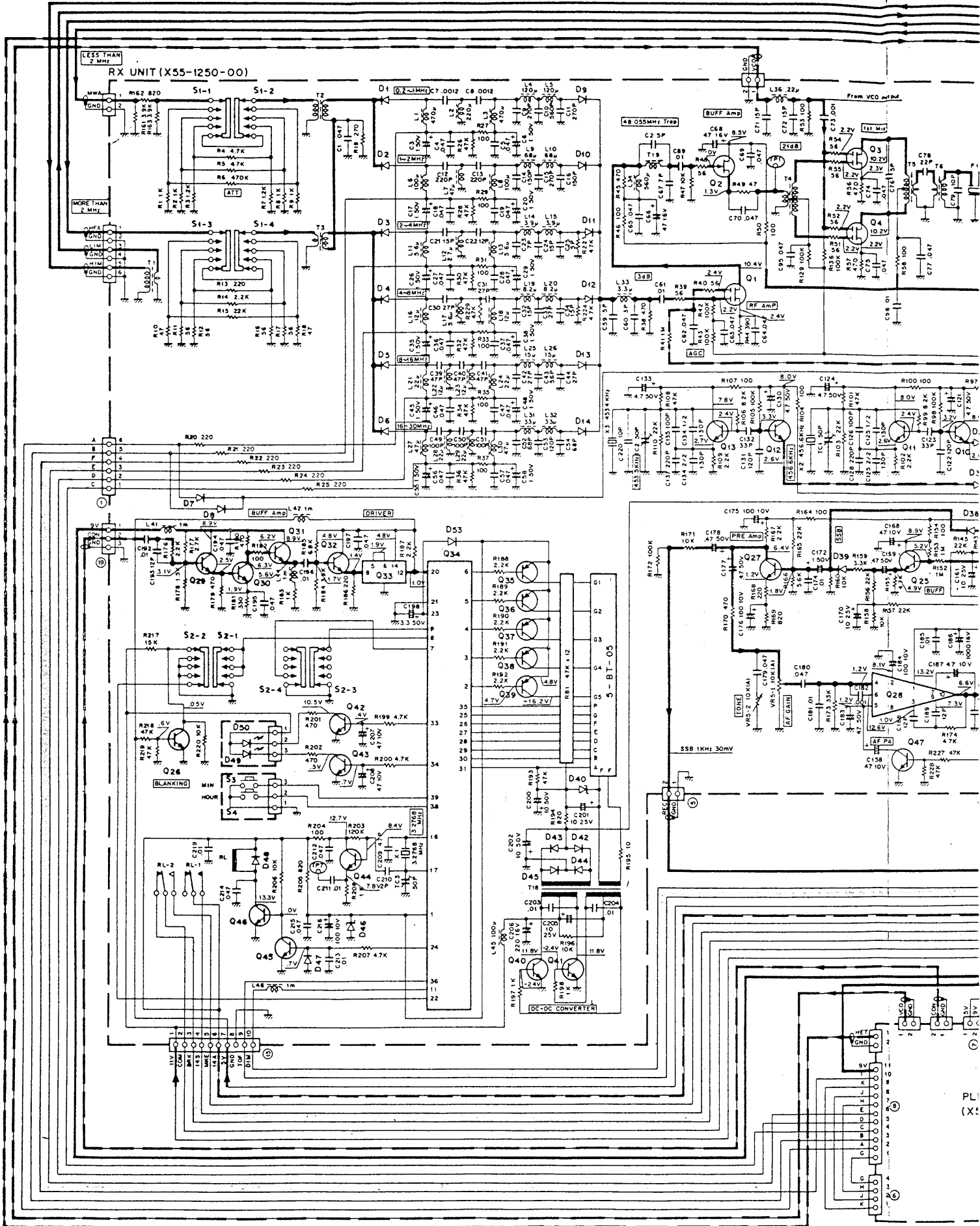

For Service Manuals  
**MAURITRON SERVICES**  
 8 Cherry Tree Road, Chinnor  
 Oxfordshire, OX9 4QY.  
 Tel (01844) 351694  
 Fax (01844) 352554  
 email: sales@mauritron.co.uk

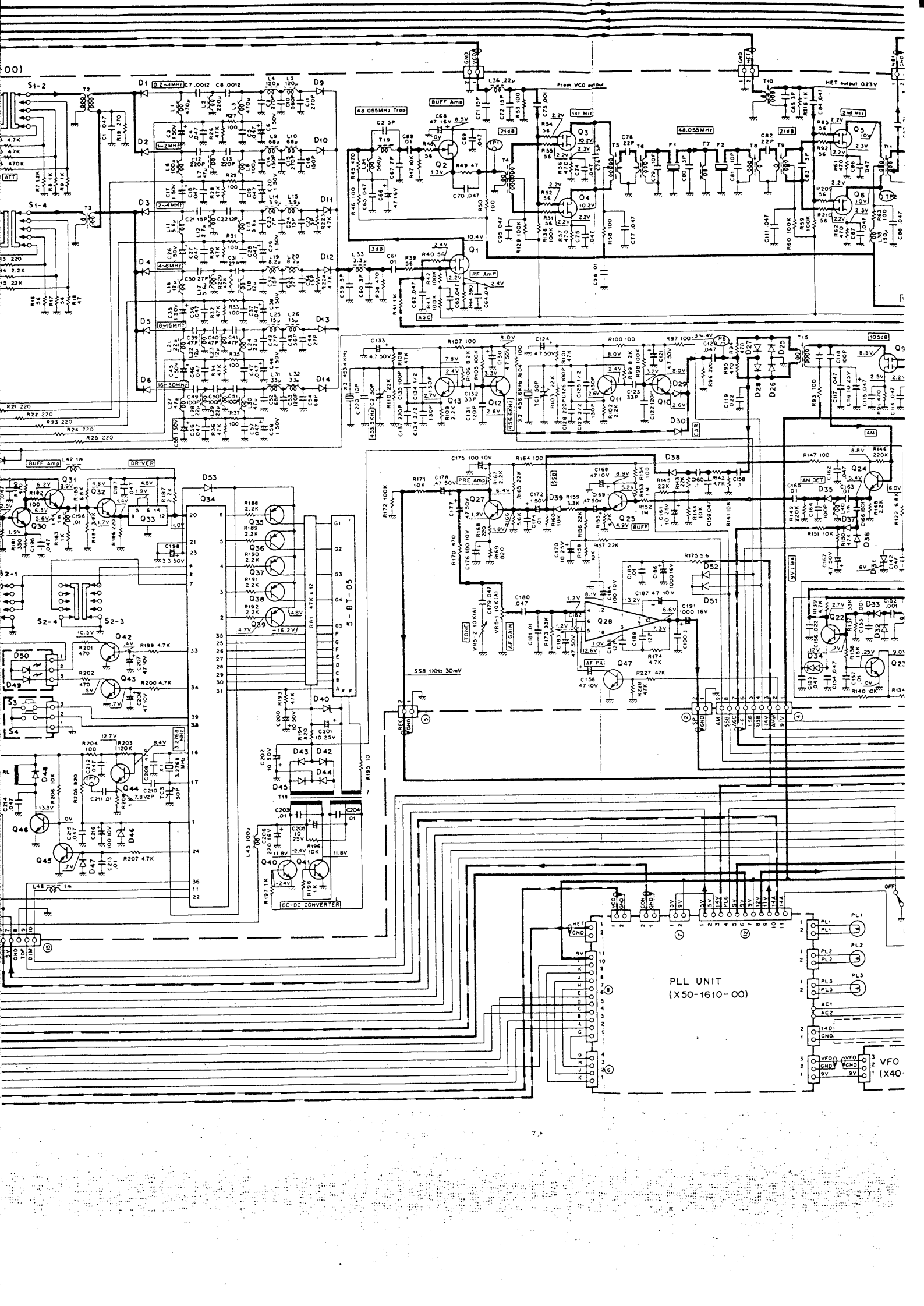

00)

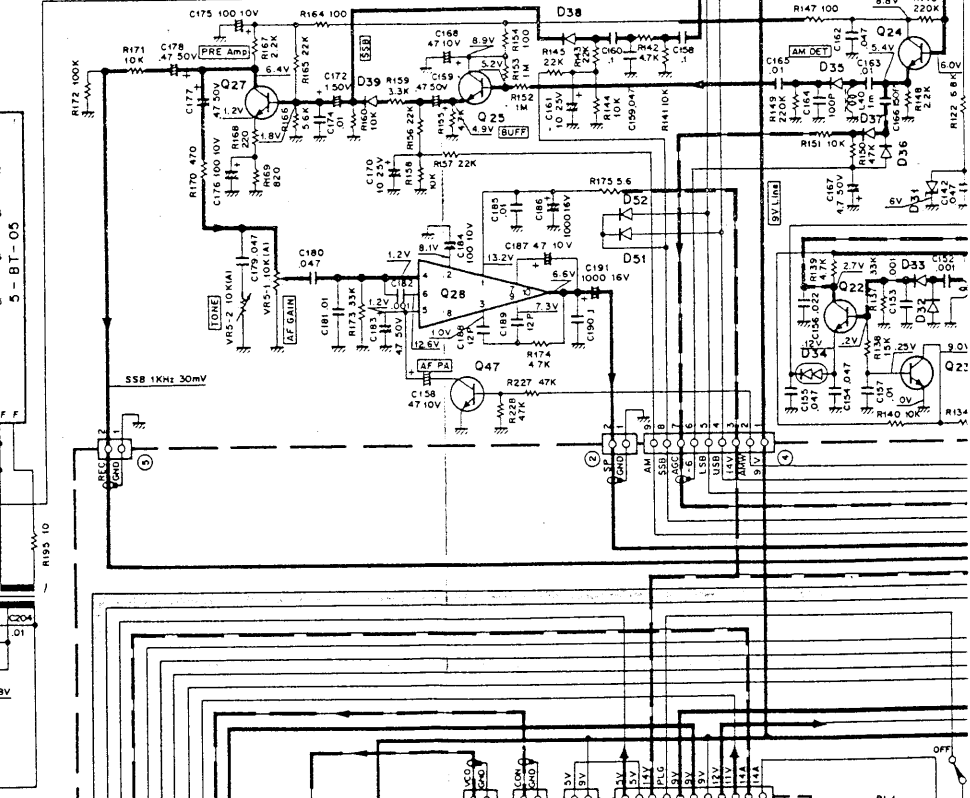
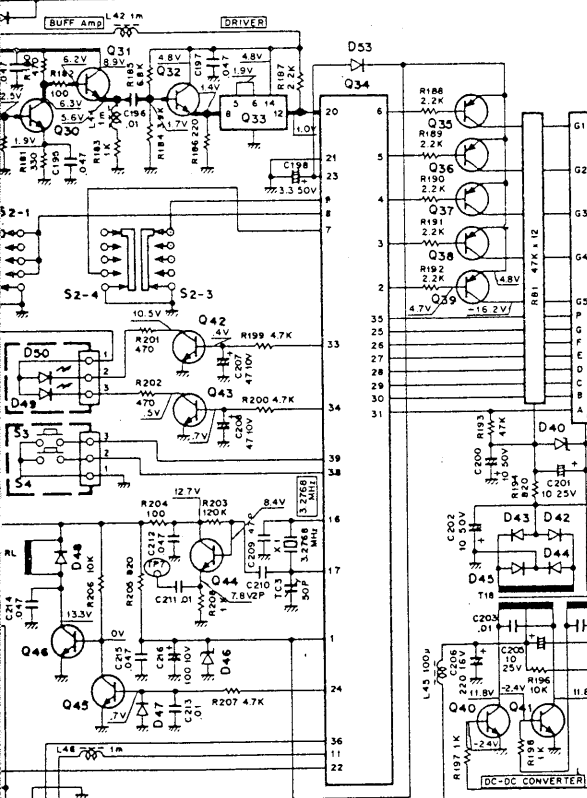
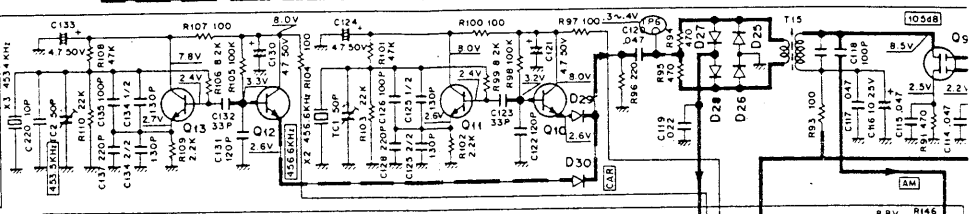
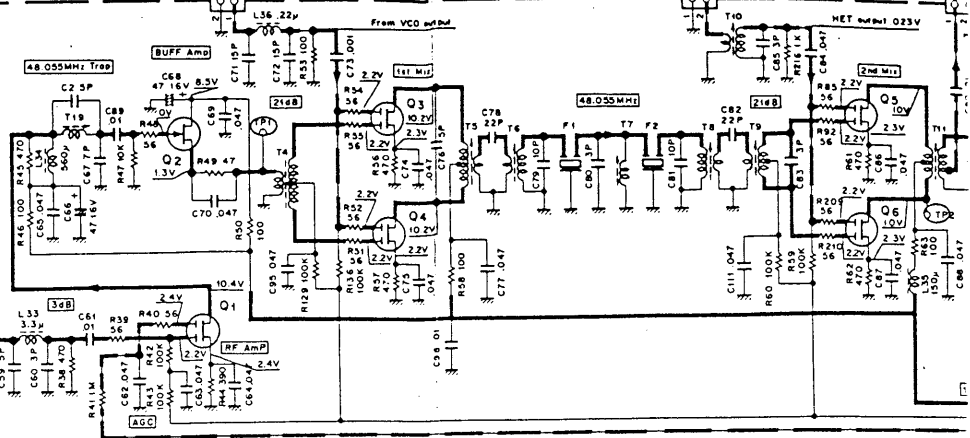
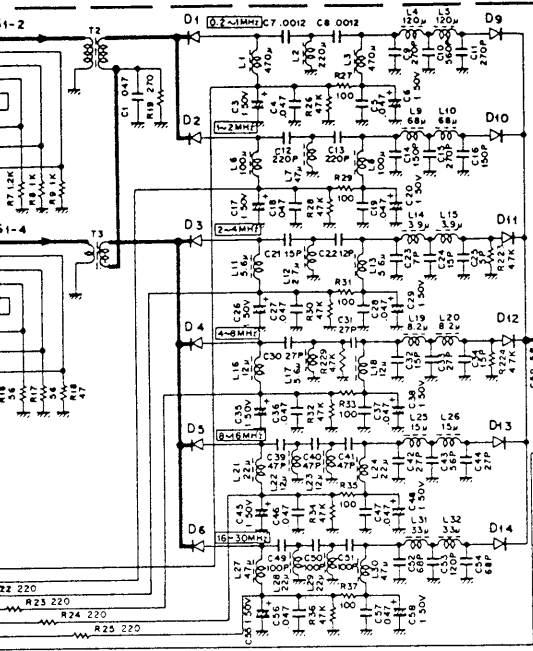

PLL UNIT  
(X50-1610-00)

VFO  
(X40)

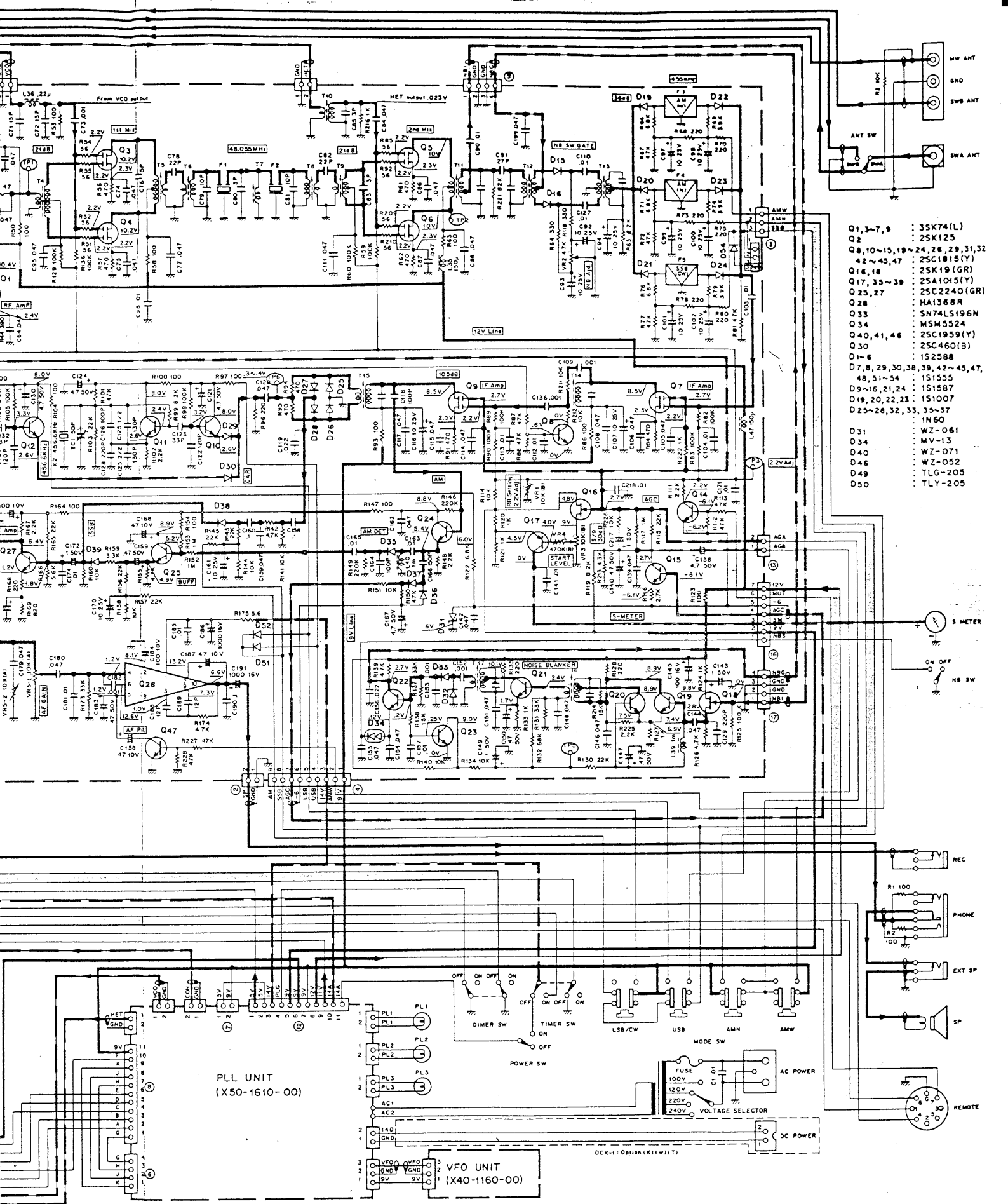

- Q1, 3-7, 9 : 35K74(L)
- Q2 : 25K125
- Q8, 10-15, 19-24, 26, 29, 31, 32 : 25C1815(Y)
- Q16, 18 : 25K19 (GR)
- Q17, 35-39 : 25A1045(Y)
- Q25, 27 : 25C2240 (GR)
- Q28 : HA1368R
- Q33 : SN74LS196N
- Q34 : MSM5524
- Q40, 41, 46 : 25C1959(Y)
- Q30 : 25C460(B)
- D1-6 : 152588
- D7, 8, 29, 30, 38, 39, 42-45, 47, 48, 51-54 : 151555
- D9-16, 21, 24 : 151587
- D19, 20, 22, 23 : 151007
- D25-28, 32, 33, 35-37 : 1N60
- D31 : WZ-061
- D34 : MV-13
- D40 : WZ-071
- D46 : WZ-052
- D49 : TLG-205
- D50 : TLY-205

PLL UNIT  
(X50-1610-00)

VFO UNIT  
(X40-1160-00)

OCR-1: Option 1 (K1W11)

