 **KENWOOD**

COMMUNICATIONS RECEIVER

Model R-820



OPERATING MANUAL

Downloaded by KB2LJJ.COM

INTRODUCTION

You are the owner of our new product, the model R-820 Communications Receiver.

This unit has been carefully engineered and manufactured under rigid quality standards, and should give you satisfactory and dependable operation for many years.

Should any trouble arise with this unit, please contact your dealer, the nearest KENWOOD service facility, or the factory.

AFTER UNPACKING

Shipping Container: Save the boxes and packing in the event your unit needs to be transported for remote operation, maintenance, or service.

The following explicit definitions apply in this manual.

NOTE: IF disregarded, inconvenience only. No risk of equipment damage or personal injury.

CAUTION: Equipment damage may occur, but not personal injury.

WARNING: Personal injury may occur — DO NOT DISREGARD!

NOTE

All reference to the TS-820S Transceiver fully includes the TS-820 (Non-Digital Display) model.

All reference to the TS-520S Transceiver fully includes the older TS-520 model.

All reference to the TV-502S transvertor fully includes the older TV-502 model.

CONTENTS

INTRODUCTION	2	4.6	VBT
INDEX	3	4.7	IF Shift
R-820 SPECIFICATIONS	4	4.8	VBT and IF Shift Combination
SECTION 1 FEATURES	5	4.9	NOTCH
SECTION 2 INSTALLATION	6	4.10	RIT
2.1 General		4.11	Noise Blanker
2.2 Accessories		4.12	AGC
2.3 Operation Location		4.13	RF GAIN
2.4 Antenna		4.14	RF Attenuator
2.5 Speaker		4.15	Monitor
2.6 Headphones		4.16	Fixed Frequency Operation
2.7 Power Requirements		4.17	RTTY Reception
2.8 Ground		4.18	DC Operation
SECTION 3 CONTROLS, CONNECTORS, INDICATORS	8	4.19	Analog Dial Calibration
3.1 Front Panel		4.20	Connection to the TS-820S
3.1 Rear Panel		4.21	Connection to the TS-520S
SECTION 4 OPERATING INSTRUCTIONS	12	4.22	Connecting a Transmitter or Transceiver Having a Frequency Configuration Different from that of the R-820
4.1 Receiver Tuning		4.23	Connection to the TS-820S, TV-502S, TV-506
4.2 WWV Reception		4.24	Connection to the SM-220
4.3 Short Wave Reception		4.25	Modification of the TS-820S
4.4 Reading the Operating Frequency		4.26	AC Voltage Selection
4.5 Selectivity			

SECTION 5 CIRCUIT DESCRIPTION	25	7.3	9V Adjustment
5.1	General Description	7.4	AGC Bias Adjustment
5.2	VBT Circuit	7.5	RIT Zero Adjustment
5.3	IF Shift Circuit	7.6	Crystal Calibrator Alignment
5.4	NOTCH Circuit	7.7	Digital Display Frequency Calibration
5.5	Transceiver Connection Circuit Configuration	7.8	ANT and MIX Coil Alignment
		7.9	IF Alignment
5.6	Printed Circuit Board Descriptions	7.10	S-Meter Adjustment
SECTION 6 CRYSTAL FILTER OPTIONS	29	7.11	NOTCH Adjustment
6.1	Installation: Optional Filters	7.12	Maintenance
6.2	Filter Preset Switching	7.13	Ordering Spare Parts
SECTION 7 MAINTENANCE AND ALIGNMENT ...	31	7.14	Service
7.1	General Information	SECTION 8 TROUBLESHOOTING	33
7.2	Removing the Cabinet	Schematic Diagram	36~39
		Internal Parts Locations	40

INDEX

FIGURES (* Denotes frequency response graph)

- Fig. 2-1 System Interconnection
- Fig. 3.1 Front Panel
- Fig. 3.2 Rear Panel
- Fig. 4.1 Reading the Analog Frequency Display
- * Fig. 4.2 IF Filters: Selectivity Characteristics
- Fig. 4.3 VBT Control Positioning
- * Fig. 4.4 VBT Operation: Selectivity Characteristics
- * Fig. 4.5 IF Shift Operation: Graph
- * Fig. 4.6 IF Shift and VBT in Combination; Graph
- Fig. 4.7 NOTCH Control Positioning
- * Fig. 4.8 NOTCH Operation: Settability Characteristic
- Fig. 4.9 Fixed Channel Crystal Installation
- Fig. 4.10 Fixed Channel Circuit Schematic
- * Fig. 4.11 RTTY Frequency Graph
- Fig. 4.12 Analog Dial Calibration
- Fig. 4.13 Full Transceiver Interconnection with TS-820S
- Fig. 4.14 VFO Transceiver Interconnection with TS-820S
- Fig. 4.15 VFO Transceiver Interconnecting with TS-520S
- Fig. 4.16 Connecting a Transmitter or Transceiver Having a Frequency Configuration Different from that of the R-820.
- Fig. 4.17 Interconnecting with TS-820S, TV-502S and TV506 Transverters
- Fig. 4.18 Interconnection with SM-220
- Fig. 4.19 Removing the TS-820S PLL-ASSY
- Fig. 4.20 Removing the PD Unit
- Fig. 4.21 PD Unit HET Output Wiring
- Fig. 4.22 MODE Switch Rewiring
- Fig. 4.23 PROCESSOR Switch Wiring
- Fig. 4.24 New Cable Routing
- Fig. 4.25 EXT VFO Socket Rewiring
- Fig. 4.26 9P-MT Plug Rewiring
- Fig. 4.27 ANTI VOX (Speaker Line) Rewiring
- Fig. 4.28 ANTI VOX (Phone Patch Output) Rewiring
- Fig. 4.29 Speaker Line Rewiring Detail
- Fig. 5.1 Block Diagram
- Fig. 5.2 TS-820S Frequency Diagram
- Fig. 5.3 R-820 Frequency Diagram
- * Fig. 5.4 VBT Operation
- Fig. 5.5 NOTCH Filter Block Diagram
- * Fig. 5.6 NOTCH Filter Frequency Diagram
- Fig. 6.1 Optional Filter Installation
- Fig. 6.2 Filter Preset Switch
- Fig. 7.1 Cabinet Removal
- Fig. 7.2 Digital Display Calibration
- Fig. 7.3 RF Unit Alignment

TABLES

- 4.1 Initial Control Settings
- 4.2 Bandwidth, Auto Setting
- 4.3 Fixed Channel Crystal Frequency Chart
- 4.4 R-820, TS-820S Transceiver Switching Functions
- 4.5 VFO Transceiver Calibration Settings
- 6.1 Filter Preset Switch Settings
- 7.1 Coil Pack Alignment Order

R-820 SPECIFICATIONS

Receive Frequency Range	160M Band — 1.8 ~ 2.0 MHz 80M Band — 3.5 ~ 4.0 MHz 40M Band — 7.0 ~ 7.5 MHz 20M Band — 14.0 ~ 14.5 MHz 15M Band — 21.0 ~ 21.5 MHz 10M Band A — 28.0 ~ 28.5 MHz 10M Band B — 28.5 ~ 29.0 MHz 10M Band C — 29.0 ~ 29.5 MHz 10M Band D — 29.5 ~ 30.0 MHz 19M Band(WWV) — 15.0 ~ 15.5 MHz
SW Band	49M Band — 5.9 ~ 6.4 MHz 31M Band — 9.4 ~ 9.9 MHz 25M Band — 11.5 ~ 12.0 MHz 16M Band — 17.7 ~ 18.2 MHz
Modes	SSB, CW, AM, RTTY
Receive Sensitivity	SSB 0.25 μ V(SW band 0.5 μ V), S + N/N better than 10dB AM 1.5 μ V(SW band 3 μ V), S + N/N better than 10dB
Image Ratio	More than 80dB(SW band more than 50dB)
IF Rejection	More than 90dB(SW band more than 40dB)
Selectivity	CW(0.25) 250 Hz at -6dB, 480 Hz at -60dB (Note 1) CW(0.5) 500 Hz at -6dB, 820 Hz at -60dB (Note 2) SSB(2.4) 2.4 kHz at -6dB, 3.9 kHz at -60dB AM(6) 6 kHz at -6dB, 9 kHz at -60dB
Variable Bandwidth	CW(0.5) 150 Hz ~ 500 Hz(-6dB), fully variable (Note 3) SSB(2.4) 600 Hz ~ 2.4 kHz(-6dB), fully variable AM(6) 4.3 kHz ~ 6 kHz(-6dB), fully variable (Note 4) NOTE 1. Optional filter YG-455CN installed. NOTE 2. Optional filter YG-455C installed. NOTE 3. Optional filters YG-88C and YG-455C installed. NOTE 4. Optional filter YG-88A installed.
NOTCH Filter Attenuation	More than 50dB
Frequency Stability	Within 100 Hz during any 30 minute period after warmup Within ± 1 kHz during the first hour after 1 minute of warmup and within 100 Hz every 30 minutes thereafter.
Antenna Impedance	50 ~ 75 Ohm(unbalanced)
AF Output	More than 1.5W(8 Ohm load, 10% distortion.)
AF Load Impedance	4 ~ 16 Ohm for both speaker and headphone
Power Consumption	AC 120V 30W DC 13.8V 1.6A
Power Supply	AC 100, 120, 220, 240V, 50/60 Hz DC 12 ~ 15V
Semiconductors and Tubes	IC 40 FET 34 Transistor 89 Diode 170 Display tube 1
Dimensions	13-1/8(333) wide \times 6-0(153) high \times 13-3/16(335) deep inch(mm) (projections not included)
Weight	12 kg (26.4 lbs)

SECTION 1. FEATURES

1. High Performance HF Amateur Band Receiver

A Communications Receiver the R-820 design is based on TS-820 circuit technology, providing excellent performance in every band and operating mode. Full HF Amateur band (1.8 ~ 29.7 MHz) (Plus WWV and selected SW) coverage for CW, SSB, AM and RTTY reception.

2. Transceive Operation with the TS-820S

Readily connected to the TS-820S for transceive operation. Split frequency operation with the R-820 VFO is also possible. The excellent performance of the TS-820S and R-820 assures the highest quality of operation.

3. RF Double Tuned Circuits for Improved Cross Modulation (2-signal) Characteristics

The carefully designed front end circuit improves cross modulation characteristics, minimizing intermodulation and assuring high sensitivity. Double-tuned circuits in the RF Stage further improve selectivity.

4. Variable Bandwidth Tuning Circuit (VBT)

The built-in Variable Bandwidth Tuning circuit allows the IF filter passband-width to be continuously varied. Optimum IF bandwidth can be selected according to interference conditions, assuring clearest reception at all times.

5. 50 kHz Notch Filter Circuit

The notch circuit also minimizes radio interference. Using a fixed notch circuit, the BFO and local mixer frequencies are varied simultaneously to equivalently change the notch frequency. A sharp notch characteristic of more than 50dB attenuation is available for interference-free reception.

6. IF Shift Circuit

KENWOOD'S unique IF Shift circuit, in combination with the VBT and Notch circuits, allows the highest degree of control in eliminating radio interference.

7. Noise Blanker Level and Audio Frequency Characteristic Controls

The R-820 employs a high efficiency Balanced Gate system (used in all KENWOOD noise blankers)- in addition, the noise amplifier threshold level is provided as a Front Panel control. This is particularly effective when the Noise Blanker is operating near its critical operating point at low noise levels. Audio frequency characteristic in any operating mode is also adjustable.

8. S Meter with dB/ μ V Scale

The threshold type RF Gain Control circuit and dB/ μ V meter scale assures accurate indication of signal strength. The S Meter indicates low or high input signal levels when used with the RF step attenuator.

9. 10dB Step Attenuator (0-40dB)

The RF Attenuator allows through operation (ϕ dB), or provides 4 levels of 10, 20, 30 or 40dB attenuation, making it possible to receive strong local signals, or low band stations operating at night.

10. Digital Display gives Accurate Frequency Indication

The Digital Display system employs local oscillator frequency synthesizing (also used in the TS-820S and TS-520S/DG-5). Unlike VFO conversion systems, frequencies in any band (including SW) and in any operating mode can be accurately read to the 100Hz order.

11. DRS Dial

KENWOOD'S renowned analog dial system (also used in the TS-820S) provides easy accurate frequency reading, any mode, against a single cursor.

12. Transmit Signal Monitor Circuit

This circuit allows monitoring your own voice signal, sampled from the Final Stage during transceive transmit/receive operation. Monitor level is Front Panel adjustable.

13. Four Short Wave Bands and an AM IF Filter

The R-820 also covers 4 SW bands (49m, 31m, 25m and 16m), and contains a 455kHz AM IF filter. Provisions for an optional 8.83MHz AM filter (YG-88A) are provided.

14. IF Filters

The R-820 contains an 8.83MHz SSB filter, a 455kHz SSB filter, and a 455kHz AM filter. A variety of additional IF filters, 8.83MHz CW filter [YG-88C], 8.83MHz AM filter [YG-88A], and 455kHz CW filters [YG-455C (500Hz) and [YG-455CN (250 Hz)], are available optionally.

15. Passband-width Selector for Additional Filters

Filters additionally installed are automatically MODE Switch selected. The FILTER switch provides manual override of the passband-width, selecting the 0.25kHz, 0.5kHz, 2.4kHz or 6kHz filter positions.

16. Full Variety of Auxiliary Functions and Connecting Terminals

The R-820 is equipped with a 25kHz marker, Display Hold switch, Transceive/Separate selector switch, Full Transceive/VFO Transceive selector switch, Standby switch, FIXED channel oscillators, and NOTCH, FIX, VFO, RIT indicators. Connecting terminals for Phone Patch, Phones, Speaker, IF OUT (50kHz), Pan Display (8.83MHz), HET input, Transverter Antenna and Record terminals are also provided.

SECTION 2. INSTALLATION

2.1 GENERAL (FIG. 2-1)

To obtain maximum performance from your R-820 receiver it is recommended you read Section 2 and 3 in their entirety before attempting to operate the unit.

2.2 ACCESSORIES

The following accessory items are included with the unit.

- | | | | |
|---------------------------------|----------|---|----------|
| 1. Operating Manual | 1 copy | 5. Screws, 4 × 12mm Long | 2 pieces |
| 2. RCA Phono Plugs | 5 pieces | 6. AC Power Cord | 1 piece |
| 3. Speaker Plug | 1 piece | 7. Transceiver Cable | 1 piece |
| 4. Plastic Extension Foot | 2 pieces | 8. HET Cable | 1 piece |
| | | 9. ANT Cable | 1 piece |
| | | 10. GND Cable | 1 piece |
| | | 11. Digital Display Calibration Cable | 1 piece |
| | | 12. Fuse (1A) | 2 pieces |
| | | 13. Wire (Red, White) | 2m long |
| | | 14. 75 Ohm Coaxial Cable (1.5C-2V) | 1m long |
| | | 15. Capacitor 0.01 μ F (103Z) | 1 piece |

Fig. 2.1 SYSTEM Interconnection

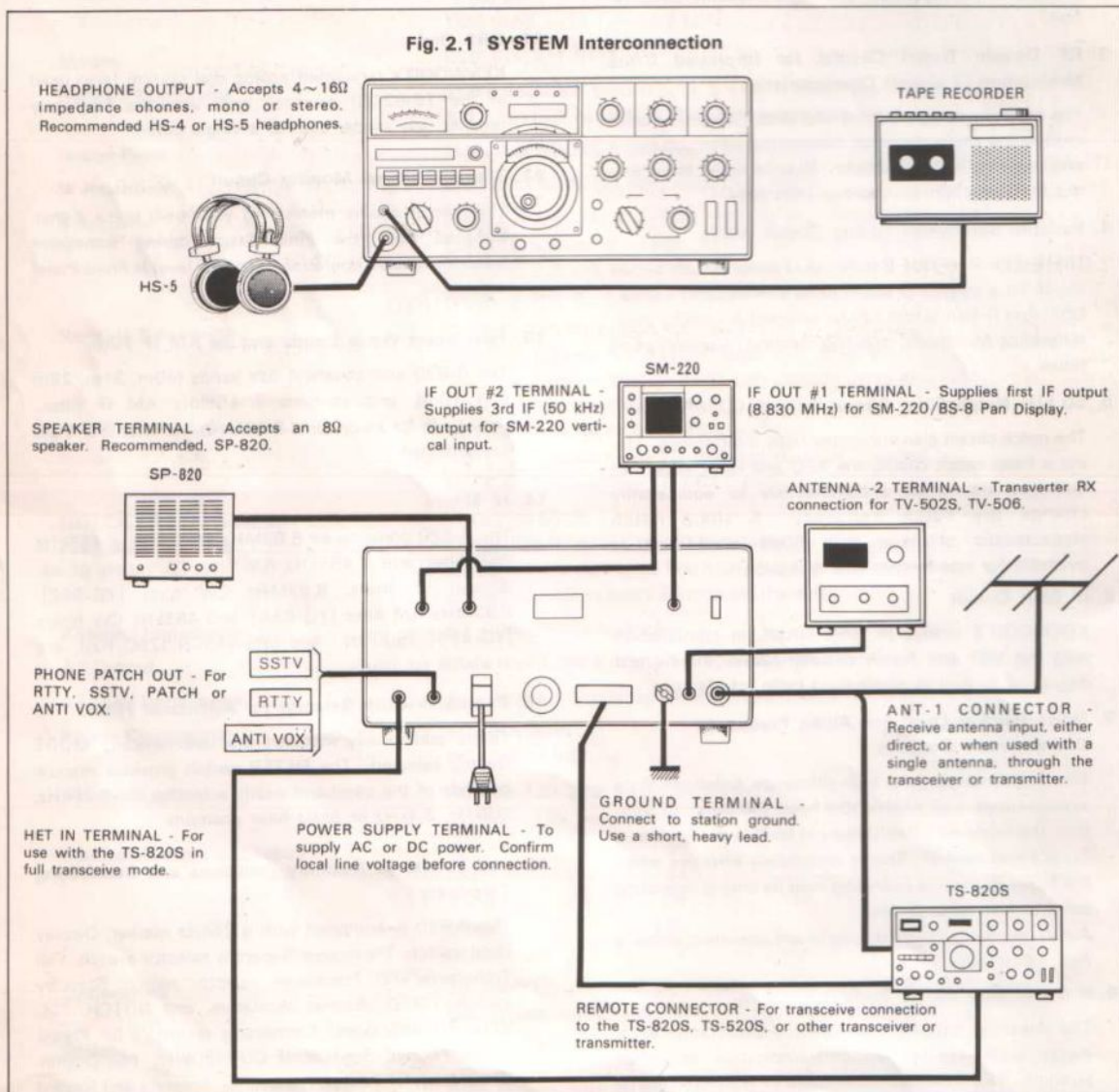

2.3 OPERATING LOCATION

As with any solid state electronic equipment, the R-820 should be kept from extremes of heat and humidity. Choose an operating location that is dry and cool, and avoid operating the receiver in direct sunlight.

2.4 ANTENNA

The R-820 will provide excellent performance with any resonant antenna which is cut for the frequencies desired, these include beams, dipoles, most long-wire antennas and resonant mobile antennas.

The R-820 has been designed for use with 50 ~ 75 Ohm unbalanced input; therefore if the receiver is used with an antenna having other than 50 ~ 75 Ohms impedance, degraded performance will result.

When using the R-820 with antennas having other than a 50 ~ 75 Ohm impedance, such as a random length long-wire antenna, use an antenna Tuner, such as the KENWOOD AT-200.

2.5 SPEAKER

The R-820 accessory speaker Model SP-820, or any other 8 Ohm speaker may be connected to the speaker output jack at the rear of the receiver.

2.6 HEAD PHONES

Any low-z (4 ~ 16 Ohm) headphones may be used with the R-820. Connect the headphones to the Front Panel phones jack.

If a speaker is connected to the receiver it will automatically disconnect when the headphones are plugged into the jack.

2.7 POWER REQUIREMENTS

1 Fixed AC Operation

The R-820 operates from 100/120/220/240V AC, 50 ~ 60Hz. Stability is not affected within 10% of line voltage variation, due to the regulated power supply.

To change the Voltage Selector, refer to Section 4.25.

CAUTION

Operation of this receiver with the wrong power source may result in serious damage.

2 Mobile or Portable Operation

DC operation of the R-820 requires a 13.8VDC power supply having a current capacity of approximately 2A. (A DC power cord is available as an option)

The DC source should be filtered and very stable, be, if not a battery source.

Insufficient filtering can introduce hum and noise into the audio output.

CAUTION

When using DC power to operate the R-820 carefully OBSERVE POLARITY! Check and double check your connections before applying power, as reversed polarity will damage the receiver EXTENSIVELY.

2.8 GROUND

A stud terminal with wing nut is provided on the rear panel for connection to the station ground.

If used with the TS-820S transceiver (and accessories), connect a ground strap between the ground terminals of all units and a common ground point, usually the transceiver ground stud.

SECTION 3. CONTROLS, CONNECTORS, INDICATORS

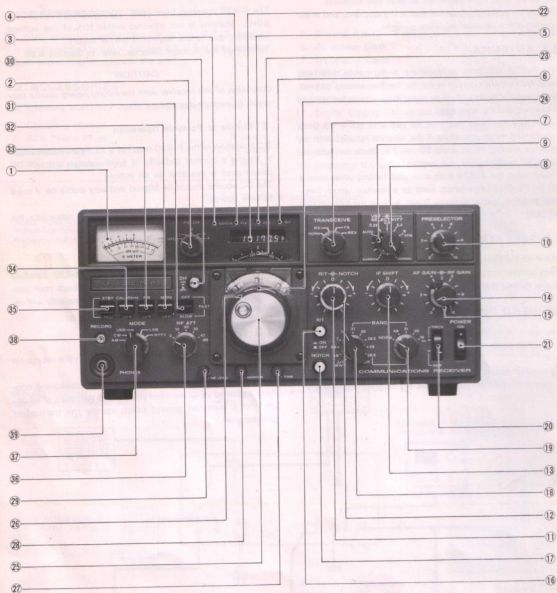

Fig. 3.1 Front Panel

3.1 FRONT PANEL (FIG. 3-1)

① S Meter

The upper scale (S1 to S9, to 40dB/S9) indicates received signal strength- the lower scale (0 ~ 70dB/ μ V) indicates antenna terminal voltage.

② FIX CH (Fixed Channel) Selector Switch

This four-position rotary switch selects between four different fixed frequency crystal channels which can be installed inside the receiver.

Fixed frequency operation is convenient for operation on often used frequencies.

The fixed channel oscillator replaces the VFO when this switch is placed in the 1 ~ 4 position.

③ Notch Indicator

This indicator uses an LED (light emitting diode), which is illuminated when the NOTCH circuit is turned ON.

④ FIX (Fixed Channel Operation) Indicator

The FIX indicator is an LED which illuminates when the R-820 internal fixed frequency oscillator is controlling the receivers operation.

⑤ VFO Indicator

The VFO indicator is an LED which illuminates when the R-820 internal VFO is controlling the receivers operation. This indicator is not lighted during Fixed Channel, or Transceive operation.

⑥ RIT Indicator

This LED is illuminated when the RIT circuit is turned ON.

⑦ Transceive Switch

This switch is used for Transceive operation with the TS-820S. When the R-820 is not used for transceive operation, this switch must be set to NORM.

For transceive operation, the FUNCTION switch of the TS-820 must be set to VFO:

Functions of TRANSCEIVE switch:

nORM: Received signals are selected by the R-820 VFO. cw cum mix frequency by the TS-820S VFO.

RX: Receive and transmit frequency controlled by the R-820 VFO.

TX: Receive and transmit frequency controlled by the TS-820S VFO.

REV: Received signals are selected by the TS-820S VFO, transmit frequency by the R-820 VFO.

⑧ VBT Control (Inner Knob)

The VBT (Variable Bandwidth Tuning) continuously adjusts the IF Filter bandwidth to eliminate radio interference. Under normal operation, this knob may be turned fully clockwise (NORMAL Position).

⑨ Selectivity Switch (Outer Knob)

This switch is used to select the IF Filter bandwidth. In the AUTO position, the IF Filter for the desired operating mode is automatically selected by the MODE switch. The "2.4" position is used for the SSB filter and "6" for the AM filter. The "0.25" and "0.5" positions are available for filter options.

⑩ Preselector

Peaking this control for maximum signal or noise output tunes the receiver "front end".

⑪ RIT Control

This is used to vary receive frequency when the RIT circuit is ON.

Set the RIT knob pointer to the "0" panel legend.

⑫ NOTCH Control

Turn the NOTCH switch ON and the notch filter is energized. Turning the NOTCH control, set the notch frequency to null the beat interference signal. This minimizes beat interference.

⑬ IF Shift Control

By using this control, the IF crystal filter center frequency can be shifted ± 1.7 kHz, allowing adjustment of tone quality, or eliminating interference from adjacent frequencies.

For normal operation, this control should be set to the center "0" position, denoted by the positive detent "click".

⑭ AF Gain Control

This control varies the receiver audio output to the PHONES jack, speaker output, phone patch and record output terminals. Full counter clockwise is minimum gain.

⑮ RF Gain Control

This control adjusts the gain of the RF amplifiers. Turn fully clockwise for maximum gain and a correct S-meter reading. Adjust counterclockwise to reduce the gain.

⑯ RIT Switch

This energizes the RIT (Receiver Incremental Tuning) circuit. To turn ON, press IN. To turn OFF, press IN once again; the switch will return OUT.

The RIT indicator illuminates when the RIT circuit is ON. By adjusting the RIT control, the VFO receive frequency can be varied ± 3 kHz, and the Fixed Channel frequency ± 100 Hz.

⑰ NOTCH Switch

This switch energizes the NOTCH circuit and Indicator.

⑱ Amateur Band Switch (Left)

Use this switch to select the desired Amateur band.

NOTE

For Amateur the SW BAND switch(19) must be set to the NORM position.

⑲ SW Band Switch (Right)

This switch is used only for SW reception. With the Amateur BAND switch(18) in the "29.5", set the SW Band switch to the desired band. Station selection is by the main tuning knob. Frequency is indicated on the Digital Display.

⑳ TRCV-SEP (Transceive-Separate) Switch

For transceive operation with the TS-820S, set this switch to the TRCV position. In the SEP position, the R-820 and TS-820S operate independently of each other.

NOTE

When the TS-820S is in Transmit mode, the R-820 can act only as a monitor and receives no incoming signals.

⑲ Power Switch

This switch controls all power into the R-820.

⑳ Digital Frequency Display

The Digital Display unit indicates true operating frequency accurate to the 100Hz order.

㉑ SUB-DIAL

The Sub-Dial turns along with the main tuning to select and analog display the receiver operating frequency. It is calibrated at 50kHz intervals from 0 ~ 500 kHz.

㉒ Dial Scale

The unique Mono-Scale permits direct frequency reading over the 0 to 500 kHz range graduated at 1 kHz intervals. Operating frequency can be obtained by adding the frequency read on the dial to the frequency (in MHz) indicated on the amateur BAND switch. (SW frequency is read from the Digital Display.)

㉓ Main Tuning Knob

This adjusts the VFO (dial scale and sub-dial) to select the receiver's operating frequency, to be added to the Amateur Band Switch frequency.

㉔ Dial Calibrate Ring

This is used to calibrate the reading on the Analog dial scale. It should NOT be used for tuning.

㉕ TONE CONTROL

This adjusts the tone quality of the audio signal. Normally, it may remain fully clockwise. To cut the high frequency component, adjust the control counterclockwise.

㉖ Monitor CONTROL

With the MONI switch (32) set to the MONI position, this control adjusts the Monitor input level of the R-820 during Transmitter operation.

㉗ NB (Noise Blanker) LEVEL CONTROL

With the NB (Noise Blanker) switch (33) set to the NB position, this control adjusts the Noise Blanker circuit threshold. This circuit functions even when the noise level is low.

㉘ DH (Display Hold) Switch

Set to ON, the frequency below 100 kHz on the Digital Display remains locked (held ON) the Main Tuning is adjusted.

This feature is useful to memorize the original frequency when checking other frequencies.

At DH ON, the "MHz" digits turn OFF, eliminating the

possibility of mis-reading frequency.

㉙ AGC Switch

This switch controls the AGC (Automatic Gain Control) circuit, allowing the operator three control options.

OFF: It may sometimes be desirable to turn Off the AGC when receiving a very weak signal.

FAST: The FAST AGC position is designed primarily for use during CW operation.

SLOW: Use the SLOW AGC position for SSB operation.

㉚ MONI Switch

This switch is used to monitor the transmitter signal during Transceive operation. Monitor level is adjustable by the MONITOR CONTROL (28).

㉛ NB (Noise Blanker) Switch

The NB switch energizes the built-in Noise Blanker circuit. The Noise Blanker is designed to reduce pulsating, ignition type noises.

When the lever switch is flipped up, the circuit is turned ON.

㉜ CAL 25 kHz Switch

The receiver's Calibrator circuit generates a marker signal at every 25 kHz for normal calibration of the internal VFO. When the lever switch is flipped up, the circuit is turned ON.

㉝ STBY (STANDBY) Switch

Normally, this switch should be set to the REC position. At the STBY position, the receiver stops operating while Power remains ON. By setting the switch to STBY and the TRCV-SEP switch(20) to TRCV during Transceive operation, the R-820 VFO functions as a remote VFO.

㉞ RF (ATTENUATOR) ATT Switch

This switch allows precise attenuation of the input signal from the antenna in five steps. (0, 10, 20, 30 and 40dB), thus protecting the RF Amplifier and Mixer circuits.

㉟ MODE Switch

The MODE Switch selects the type of demodulation.

AM: The (AM) position is provided to operate the receiver on an incoming Amplitude Modulated signal for reception of tone modulated telegraphy or SW broadcasts.

CW: Provides narrow filter selection (when optional filters are installed), and automatically narrows AF response by attenuating the high frequency components through the preamplifiers.

USB: The USB position is provided to operate the receiver on incoming USB signals in and above the 14 MHz band.

It is an international convention to use USB for operation in and above the 14 MHz Amateur band.

LSB: The LSB position is provided to operate the receiver on incoming LSB signals the 1.8, 3.5 and 7 MHz band.

It is an international convention to use the LSB mode for operation in the 1.8, 3.5 and 7 MHz band.

RTTY: For RTTY operation with a T.U. and teletype-writer.

14 Record Jack

An output jack for connecting a tape recorder or other audio line accessories. The output impedance is 1k Ω . Output level is adjusted with the AF GAIN control (14).

15 Phones Jack

This jack accepts a standard PL-55 plug and can be used with 4 to 16 Ohm impedance headphones.

When headphones are plugged into the jack the speaker audio output is automatically disabled.

3.2 REAR PANEL (FIG. 3-2)

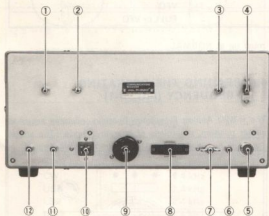

Fig. 3.2 Rear Panel

1 IF OUT #2 Jack

The receive signal from the 50 kHz final IF stage is fed to this jack, allowing you to monitor the signal using the Oscilloscope function of the SM-220 Station Monitor (optional equipment).

2 Speaker Jack

Audio output can be connected through this jack to an external 4 to 16 Ohm speaker.

3 IF #1 Jack

The receive signal entering the 1st IF (8.83 MHz) is fed to this jack for Pan Display observation using the SM-220 Station Monitor and BS-8(option).

4 Full-VFO Transceive Switch

With Heterodyne remote, and ANT cables connected to the TS-820S, setting this switch to the FULL position allows full Transceive operation. For the TS-520S (which can not accept the heterodyne connection), set the switch to the VFO position for VFO Transceive operation.

5 ANT-1 Connector

Connect your receiving antenna using UHF connector. For Transceive operation, connect the supplied ANT cable to the TS-820S X VERTER IN jack. The input impedance is 50 \sim 75 Ω unbalanced.

6 ANT-2 Jack

Transverter Input jack. For connection to the TV-502S, use the supplied extension cable. This jack is also used to calibrate the Digital Display Unit using the supplied calibration cable.

7 GND Terminal

When the R-820 is used for transceive operation, connect this terminal to the TS-820S GROUND Terminal.

8 Remote Jack

Connect the modified TS-820S using the supplied Transceive cable.

9 Voltage Selector

This is a plug/socket combination with built-in 1A (AC) fuse. The socket is provided with 100, 120, 220 and 240 volt terminals for selection of an AC line source.

10 Power Supply Connector

For connection of the supplied AC power cord. (A DC power cord is optional.)

11 Phone Patch Out Jack

This is a line output terminal for phone patch, RTTY, or SSTV use.

12 HET in Jack

Used for Full Transceive operation with the TS-820S. The heterodyne signal (crystal oscillator signal) from the TS-820S is input to the R-820 PLL unit.

SECTION 4. OPERATING INSTRUCTIONS

This section assumes that you have read Section 2 and installed the receiver as specified.

Check once again to make sure the antenna, speaker and

power connections have been made properly. Set the R-820 controls as listed in Table 4-1.

TABLE 4.1 Initial Control Settings

LOCATION	CONTROL	POSITION
FRONT PANEL CONTROLS	POWER Switch	OFF
	TRCV-SEP Switch	SEP
	STBY-REC Switch	REC
	NB Switch	OFF
	NB Switch	OFF
	AGC Switch	SLOW or FAST
	MODE Switch	As Desired
	RF ATT Switch	OdB
	RIT Switch	OFF
	NOTCH Switch	OFF
	BAND Switch	As Desired *
	IF SHIFT Control	Centered
	AF GAIN Control	Minimum
	RF GAIN Control	Maximum
	PRESELECTOR Control	Centered
	VBT Control	NORMAL
	SELECTIVITY Switch	AUTO
TRANSCIVE Switch	NORM	
FIX-CH Switch	VFO	
REAR PANEL CONTROLS	FULL-VFO Switch	FULL or VFO

* For Amateur BAND reception, SHORT WAVE BAND switch must be at NORMAL.

4.1 RECEIVER TUNING

Refer to Table 4-1 for initial control settings, then continue. Push the Power Switch ON.

The Meter, Dial Scale, and VFO indicators will light.

Advance the AF GAIN control clockwise until some receiver noise is heard in the speaker.

Adjust the Main Tuning until a signal is heard, (tuning for clearest reception,) and then adjust the PRESELECTOR control for maximum deflection of the S-Meter.

4.2 WWV RECEPTION

The R-820 tunes WWV at 15 MHz when the Amateur BAND switch is set at WWV and the Sub-Dial is turned to zero.

4.3 SHORT WAVE

Set the Amateur BAND switch to "29.5" and the SW BAND switch to the desired band. Set the MODE switch to "AM", and select your station by the main Tuning control. The receive frequency will appear on the Digital Display. Adjust the preselector for maximum signal strength.

4.4 READING THE OPERATING FREQUENCY (FIG. 4-1)

The R-820 Analog Frequency Readout indicates accurate carrier position, regardless of operating mode. The actual

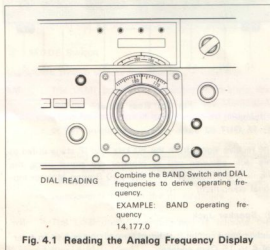

Fig. 4.1 Reading the Analog Frequency Display

receive frequency is read directly from the Dial Scale. If there is difference between the Dial Scale and Digital Display frequencies, the Analog Dial should be calibrated to the Digital Display by the calibrate knob.

4.5 SELECTIVITY SWITCH (FIG. 4-2)

High selectivity, 2.4 kHz filters are used in the 1st IF(8.83 MHz) and 2nd IF(455 kHz) circuits. When optional (250 Hz, 500 Hz or 6 kHz) filters are installed, they can be manually selected by this switch. With the switch in the AUTO position, selectivity is automatically chosen by the MODE switch. Refer to Section 6.2 "Filter Preset Switching".

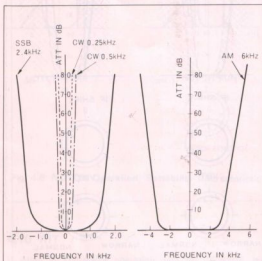

Fig. 4.2 IF Filters: Selectivity Characteristics

TABLE 4.2 Bandwidth, Auto Setting

Mode Switch Setting	Bandwidth, Auto Setting
AM	6 kHz
CW	2.4 kHz
USB	2.4 kHz
LSB	2.4 kHz
RTTY	2.4 kHz

NOTE

If optional CW filters(YG-88C, YG-455, YG-455CN) are not installed, SELECTIVITY switch positions 0.25 and 0.5 will be inoperative.

4.6 VBT (VARIABLE BANDWIDTH TUNING) CONTROL (FIG. 4-3, 4-4)

By setting the VBT control to the NORMAL position, maximum passband-width is obtained. The IF filter passband-width is narrowed as the control is adjusted

counterclockwise, center frequency remains unchanged. The maximum passband-width is set by the SELECTIVITY switch. The variable range is determined by the filter selected:

4.6.1 2.4 kHz Filter

Variable range: 2.4 kHz to 600 Hz(approx) as shown in Fig. 4-3A.

4.6.2 Optional Filter YG-88C (8.83 MHz bandwidth: 500 Hz) Together with YG-455C (455 kHz, bandwidth: 500 Hz)

Variable range: 500 Hz to 100 Hz(approx) as shown in Fig. 4-3B.

Filter center frequency is shifted 700 Hz, as compared with the 2.4 kHz filter, so CW tone of approximately 800 Hz is obtained without using the IF SHIFT.

4.6.3 YG-88A(8.83 MHz, bandwidth: 6 kHz)

Variable range: 6 kHz to 4.3 kHz(approx).

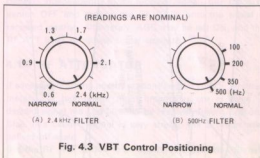

Fig. 4.3 VBT Control Positioning

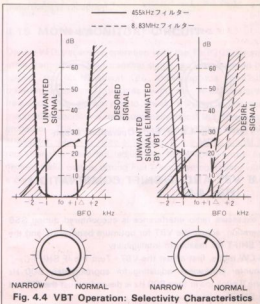

Fig. 4.4 VBT Operation: Selectivity Characteristics

4.7 IF SHIFT (FIG. 4-5)

4.7.1 USB

Turn the IF SHIFT control in the "+" direction and interference lower than the receive signal frequency is eliminated; the signal is heard as low-cut. Adjustment in the "-" direction eliminates interference higher than the receive signal frequency, the signal is heard as high-cut.

4.7.2 LSB

Adjust in the "+" direction and interference lower than the receive signal frequency is eliminated; the signal is heard as high-cut.

Adjustment in the "-" direction eliminates interference higher than the receive signal frequency- the signal is heard as low-cut.

NOTE

The IF SHIFT has no effect in the AM MODE.

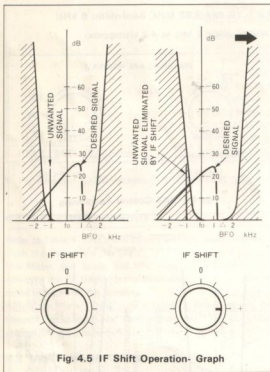

Fig. 4.5 IF Shift Operation- Graph

4.8 VBT AND IF SHIFT COMBINATION (FIG. 4-6)

If excessive radio interference is encountered during SSB operation, adjust the VBT for optimum bandwidth, and the IF SHIFT for maximum intelligibility.

In CW mode, first adjust the VBT. Turn the IF SHIFT "-" (counter clockwise), adjusting for approximately 800 Hz tone. If pitch lower than 800 Hz is desired, adjust the RIT and IF SHIFT.

During RTTY narrow shift (170 Hz) reception, adjust the VBT and turn the IF SHIFT "-" for balanced 2125 Hz and 2295 Hz tone.

If your receiver is equipped with the optional CW filters, this adjustment is not required.

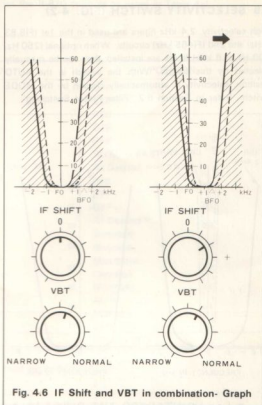

Fig. 4.6 IF Shift and VBT in combination- Graph

4.9 NOTCH (FIG. 4-7, 4-8)

For heterodyne or single tone (CW) interference, turn the NOTCH switch ON and adjust the NOTCH control to null (or minimize) interference.

NOTE

The NOTCH filter has no effect in the AM MODE.

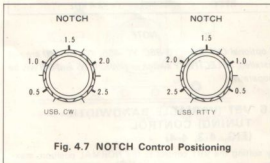

Fig. 4.7 NOTCH Control Positioning

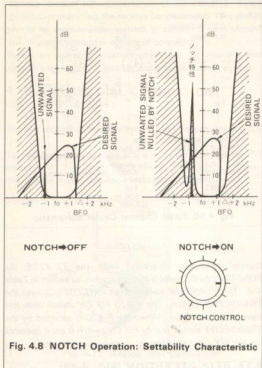

Fig. 4.8 NOTCH Operation: Settability Characteristic

4.10 RIT

If when in Transceive operation with the TS-820S, the opposite stations frequency is offset, your receive frequency can be independently corrected by turning the RIT switch ON and adjusting the RIT control.

By using the RIT, the receive VFO frequency can be shifted approximately ± 3 kHz, and Fixed Channel frequency by approximately ± 100 Hz.

The RIT LED indicates circuit, operation, while frequency deviation is read directly from the Digital Display.

4.11 NOISE BLANKER (NB)

For pulse type noise, such as generated by automotive ignition systems, turn the NB switch ON. Adjusting the NB LEVEL control varies the blanker's threshold, eliminating even low level noises.

If high level signal or noise are present on adjacent frequencies, do not use excessive NB threshold LEVEL counterclockwise adjustment, as it may distort the receive signal.

4.12 AGC (AUTOMATIC GAIN CONTROL)

Position the AGC switch appropriately for signal condition. Generally, for SSB reception set the AGC switch to SLOW. For CW reception set to FAST, and for reception of a very weak signal the AGC may be turned OFF.

4.13 RF GAIN

RF GAIN is controlled by changing the AGC circuit bias voltage.

Adjust the RF GAIN control if the S-Meter deflects excessively.

This minimizes noise during reception and allows the S-Meter to indicate correct signal strength. For normal operation, this control should remain fully clockwise for maximum sensitivity.

If AGC voltage is generated by interference (the S-Meter deflects independently of the received signal), turn the AGC switch OFF and reduce the RF GAIN until the signal is received clearly. Alternately, AGC may be left ON, and the RF ATT used to reduce signal strength.

4.14 RF ATTENUATOR

If excessively strong nearby stations (within several hundred meters), or high-power night broadcasts are received, a desired signal may be blocked by receiver desensitization. Also, if a desired signal is very strong, the S-Meter may deflect off-scale.

Set the RF ATT switch to an appropriate position. Signals input to the RF amplifier are attenuated, providing distortionless reception.

4.15 MONI (MONITOR) CIRCUIT

During VFO transceive operation with the TS-820S (or any other transceiver,) your transmit signal can be monitored by turning the MONI circuit ON. Providing the TS-820S transmit frequency coincides with the R-820 receive frequency, this allows you to check, transmit signal and modulation conditions, or to optimally adjust the RF speech processor. The input signal is fed to the R-820 through the attenuator, which is relay activated. If the MONI signal is too strong or distorted, adjust the MONITOR control for desired audio output, during Full Transceive operation, with a common VFO, no tuning is required.

Various types of HF mobile antennas are available. Select an antenna matching the receive bands desired. The R-820 should be mechanically secured to prevent it from slipping out of place while the vehicle is operating. Select an operating location which will not interfere with safe driving, and will provide convenient control access.

4.19 ANALOG DIAL CALIBRATION (FIG. 4-12)

The dial must first be calibrated to read frequencies correctly.

To calibrate, turn the CAL 25 kHz switch ON and the RIT switch OFF; Turn the RF ATT switch to the 40 dB position; the marker signal can be more easily received.



4.19.1 SSB Calibration

Set the switch to USB or LSB. Marker signals are received every 25 kHz, so that accurate calibration is possible over the entire dial range. With the receiver set to the band desired, turn the Main Tuning knob: a beat signal can be received every 25 kHz. Tuning across the marker signal, the beat will vary from high to low pitch and finally become zero beat. Accurate beat point is obtained by adjusting the IF SHIFT control "-" for USB, or "+" for LSB. Stop tuning at the zero beat point and rotate the Dial Calibrate Ring alone while holding the Main Tuning knob stationary, until the Dial Pointer indicates 0, 25, 50 or 75 on the dial. The Dial Calibrate Ring is coupled to the Main Tuning knob by a spring slip clutch, permitting easy rotation.

4.19.2 CW Calibration

Set the IF SHIFT control to its center position. If the optional CW filters are not used, obtain a marker zero beat, then adjust the Main Tuning counter-clockwise for an 800 Hz beat. While holding the Main Tuning knob stationary, turn the Dial Calibrate ring so the Dial Pointer indicates the correct dial frequency. When the optional CW filters are installed, tune for marker signal maximum S-Meter deflection, and then calibrate using the Dial Calibrate Ring. Again, the beat frequency will be appropriately 800 Hz.

4.20 CONNECTION TO THE TS-820S

Connect the R-820 to the TS-820S for Full Transceive operation. By connecting the R-820 to an HF band transceiver, the following operating modes are available:

- i) TS-820S:
Transceive operation (both Full Transceive or VFO Transceive operation)
- ii) TS-520S:
Separate operation Separate System(1)
- iii) Any HF band transceiver (with a different frequency arrangement):
Separate operation Separate System(1)
The difference between Transceive operation and Separate operation is explained below.

TRANSCIVE OPERATION

Transmit and receive signals are controlled by the VFO's of R-820 and TS-820S. By using both VFO's cross-operation is available. Transceive operation is classified into Full Transceive operation and VFO Transceive operation.

- i) Full Transceive operation
By applying a Heterodyne signal from the TS-820S to the R-820, transceive operation at the same operating frequency is effected through the VFO's.
For Transceive operation, Full Transceive is recommended.
- ii) VFO Transceive operation
Cross-operation is effected by using separate R-820 and TS-820S VFO's. In this case, the HET frequency deviation between both units must be compensated for by using the RIT circuits.

SEPARATE OPERATION

Separate operation is classified into the following two types:

- i) SEPARATE SYSTEM (1):
Using a transmitter and a receiver or a transceiver and a receiver, two VFO's are operated at the same time for transmission and reception at their own frequencies. In this way, cross band QSO or simultaneous reception of two signals (when a transceiver and receiver are used) can be effected. However, this method is recommended as secondary- the other Transceive modes should be used for more effective operation.
- ii) SEPARATE SYSTEM (2):
Using a transmitter and a receiver, a transceiver and a receiver, or a transceiver and an EXT VFO, two VFO's are operated alternately at the normal or reverse position during Full Transceive operation for transmission and reception on the same or different frequencies.
The combination of transmitter and receiver, or transceiver and receiver, assures effective Transceive operation even when transmit and receive frequencies are far removed from each other, since receiving sensitivity and transmit drive circuit adjustments are separate.

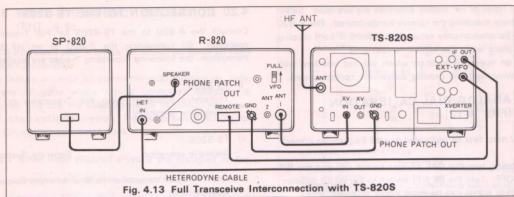

Fig. 4.13 Full Transceiver Interconnection with TS-820S

4.20.1 Cabling for Full Transceiver Operation (Fig. 4-13)

Connect as shown in Fig. 4-13. The TS-820S IF OUT jack and EXT VFO connector must be rewired: refer to Section 4.24, modification of the TS-820S.

i) Operation

Set the R-820 rear panel FULL-VFO Transceive switch to the full (normal operation) position. The BAND switches of both the R-820 and TS-820S must be set to the same band. Set the R-820 TRCV-SEP switch to TRCV and the TS-820S RF ATT switch ON.

Use the TS-820S FUNCTION switch for FIX-CH or VFO operation. Refer to Table 4-4, for TRANSCEIVE and FUNCTION switch settings.

Control Settings

Control settings for the R-820:

1. TRANSCEIVE: For switching operation, refer to Table 4-4.
2. BAND switch (left): Set to the same position as that on the TS-820.
3. BAND switch (right): NORM position
4. MODE switch: Set to the same position as that on the TS-820. (standard)
5. TRCV-SEP switch: TRCV
6. FULL-VFO switch: FULL (for VFO transceive connection, set to the VFO).

Control settings for the TS-820:

1. FUNCTION switch: Set to the VFO when no fixed channel (FIX) in the TS-820 is used. When the fixed channel is to be used, refer to Table 4-4.
2. BAND switch: Set to the same position as that on the R-820.
3. MODE switch: Set to the same position as that on the R-820.
4. RF ATT switch: Set to the ON position so as to prevent interference to the TS-820's receiver section.

Table 4.4 R-820, TS-820S Transceive Switching Functions

		TS-820S FUNCTION						
		TRANSCEIVE				CAL		
		VFO	VFO-R	FIX-R	FIX	CAL-FIX	CAL-RMT	
R-820 TRANSCEIVE	*NORM	R	R-820	R-820	TS-820S FIX	TS-820S FIX	TS-820S FIX and R-820	TS820S and R-820
		T	TS-820S	TS-820S	TS-820S	TS-820S FIX		
	RX	R	R-820	R-820	TS-820S FIX	TS-820S FIX	TS-820S FIX and R-820	TS-820S and R-820
		T	R-820	TS-820S FIX	R-820	TS-820S FIX		
	TX	R	TS-820S	TS-820S	TS-820S FIX	TS-820S FIX	TS-820S FIX and TS-820S-VFO	TS820S and R-820
		T	TS-820S	FIX	TS-820S	FIX		
*REV	R	R-820	R-820	TS-820S FIX	TS-820S FIX	TS-820S FIX and TS-820S-VFO	TS-820S and R-820	
	T	R-820	TS-820S FIX	R-820	TS-820S FIX			

* Separate system (2)

R: Reception TS-820S: TS-820S VFO

T: Transmission R-820: R-820 VFO or FIX

NOTE 1

ANTIVOX: In Transceive operation, the TS-820S ANTI VOX circuit should be modified.

NOTE 2

VFO CALIBRATION: When calibrating the TS-820S at the CAL-RMT or CAL-FIX FUNCTION switch position, the beat tone is heard from the TS-820S speaker. In CW operation, side tone is also heard from the TS-820S speaker.

If the R-820 CAL 25 kHz switch is ON and the AF GAIN is advanced, the sound heard from the R-820 speaker in the vicinity of zero beat is normal, and is not an indication of trouble.

The Digital Display also indicates an incorrect frequency. The error indication disappears at zero beat.

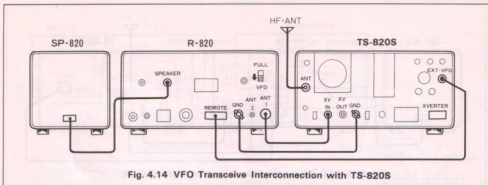

Fig. 4.14 VFO Transceiver Interconnection with TS-820S

NOTE 3

DIGITAL DISPLAY: During Full Transceiver operation, the TS-820S Digital Display indicates transmit frequency, and the R-820 Digital Display goes off in transmit mode. The R-820 Digital Display indicates receive frequency and the TS-820S Digital Display goes off in receive mode. This occurs regardless of the TRANSCEIVE switch position. When the R-820 MONI switch is ON, the R-820 Digital Display is illuminated.

4.20.2 Cabling for VFO Transceiver Operation

Connect as shown in Fig. 4-14. Modification to the TS-820S is not required. Do not connect the heterodyne cable.

i) VFO Transceiver Frequency Calibration

Set the R-820 and TS-820S BAND and MODE switches to the same position. Set the other switches as follows (TABLE 4-5):

TABLE 4.5 VFO Transceiver Calibration Settings

TS-820	FUNCTION	VFO
R-820	TRCV-SEP	TRCV
	CAL 25 kHz	ON
	TRANSCEIVE	RX
	TRCV-VFO(rear panel)	VFO

Heterodyne frequency deviation between the TS-820S and R-820 can be corrected by the following adjustments. After adjustment, DO NOT touch the RIT controls.

NOTE 1

These adjustments should be made when changing bands, or when the VFO is tuned more than 200 kHz within the same band.

NOTE 2

If the R-820 CAL 25 kHz switch is ON and the AF GAIN is advanced, the sound heard from the R-820 speaker in the vicinity of zero beat is normal, and is not an indication of trouble.

The Digital Display also indicates an incorrect frequency. The error indication disappears at zero beat.

- Advance the TS-820S AF GAIN, and turn the R-820 RIT switch OFF. Adjust the R-820 Main Tuning for marker zero beat.
- Advance the R-820 AF GAIN and reduce the TS-820S AF GAIN. Turn the R-820 RIT switch ON and adjust the for marker zero beat with the RIT control.
- Set the R-820 TRANSCEIVE switch to TX.
- Advance the TS-820S AF GAIN and reduce the R-820 AF GAIN. Turn the TS-820S RIT switch OFF, and adjust the TS-820S Main Tuning for marker zero beat.
- Advance the R-820 AF GAIN and reduce the TS-820S AF GAIN. Turn the TS-820S RIT switch ON and adjust the for marker zero beat using the RIT control.

ii) Operation

Turn the R-820 CAL 25 kHz switch OFF and the TS-820S RF ATT switch ON. Reduce the TS-820S AF GAIN to Minimum. Refer to table 4-4 for switch settings.

4.20.3 Separate connection

Separate system (1) applies

When the R-820 is used with the TS-820S, both Transceiver and Separate operations are available.

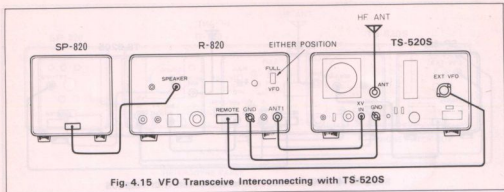

Fig. 4.15 VFO Transceiver Interconnecting with TS-520S

i) Operation

Connect for Full or VFO Transceiver operation, then set the R-820 TRCV-SEP switch to SEP. The R-820 functions as a receiver and the TS-820S as a transmitter. During operation, turn the TS-820S RF ATT switch ON and reduce the AF GAIN.

ii) Separate Operation

*DIVERSITY RECEPTION: In the SEPARATE mode, the R-820 and TS-820S receiver can be operated simultaneously (TS-820S RF ATT should be OFF with the AF GAIN advanced), allowing simultaneous reception of two signals on the same band, or an other band.

*R-820 as Remote VFO: The R-820 will operate as a remote VFO for the TS-820S. Set the R-820 TRCV switch to TRCV, and the STBY switch to STBY.

*TS-820S Independent Transceiver: The R-820 stops operating and the TS-820S operates as a transceiver: Set the R-820 TRCV switch to SEP and the STBY switch to STBY.

Next, set the TS-520S FUNCTION switch to the VFO position, and the R-820 TRANSCIVE switch to the NORM position.

Set the R-820 TRCV-SEP switch to SEP, and the MONITOR switch to the MONI position.

With the TS-520S in transmit mode, receive the MONI signal on the R-820. Turn the R-820 RIT switch ON and adjust the RIT control for zero beat.

VFO frequency calibration is now completed, and the TS-520S and R-820 are ready for operation.

4.22 CONNECTING A TRANSMITTER OF TRANSCEIVER HAVING A FREQUENCY CONFIGURATION DIFFERENT FROM THAT OF THE R-820:

The R-820 requires a relay-1 circuit synchronized with the STANDBY switch on the transmitter when it is used with a transmitter or a transceiver other than the TS-520.

To connect the transmitter or transceiver, wire the REMOTE connector as illustrated in Fig. 4-16 and connect it to the transceiver.

4.21 CONNECTION TO THE TS-520S

Connect as shown in Fig. 4-15.

4.21.1 Operation

Set the R-820 and TS-520S BAND switches to the same band. Reference Table 4-4. "TS-820S" should be read as "TS-520S" for switch settings.

VFO Transceiver Frequency Calibration:

The R-820 and TS-520S VFO's must be set to the same frequency. Set the R-820 TRCV-SEP switch to the TRCV position and the TS-520S FUNCTION switch to the CAL-RMT position. To set the R-820 VFO to the TS-520S VFO frequency, adjust the TS-520S Main Tuning knob for a zero beat.

4.23 CONNECTION TO THE TS-820S, TV-502S AND TV-506

Connect as shown in Fig. 4-17. Since this cabling system is used for full transceiver operation. The TS-820S IF OUT and EXT-VFO connectors need to be rewired as outlined in Section 4-24.

4.23.1 Operation

Set the R-820 rear panel FULL-VFO switch to the FULL (normal operating) position. The R-820 and TS-820S BAND switches must be set to the same band. See Table 4-4 for switch settings of the R-820 TRANSCIVE and TS-820S FUNCTION switches

TV-502S and TV-506 operating procedures are the same for transceiver operation with the TS-820S and R-820.

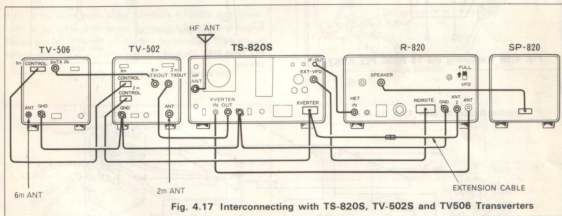
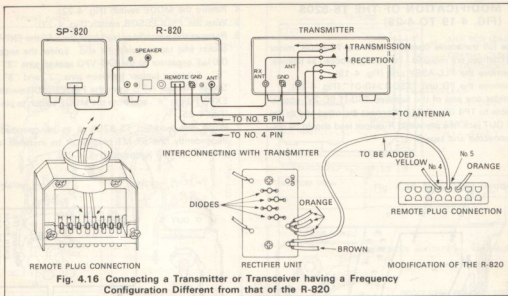

4.24 CONNECTION TO THE SM-220

Fig. 4-18 shows connection of the SM-220 with the BS-8 Pan Display option. The IF output from the R-820 can be observed by connecting IF OUT 2 to the SM-220 V INPUT.

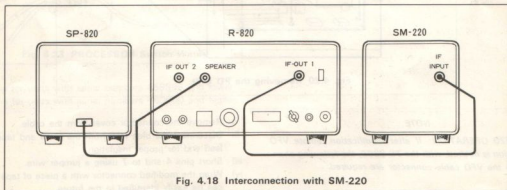

4.25 MODIFICATION OF THE TS-820S (FIG. 4-19 TO 4-29)

For the full transceive operation with the TS-820S, minor wiring changes are required. To modify, proceed as follows:

1. Remove the PLL-ASSY unit (Fig. 4-19).
2. Remove the PD unit "X50-1340-01" (Fig. 4-20).
3. Solder one end of the supplied 75 Ω (1.5C-2V) coaxial cable to TP4 (Fig. 4-21). Connect the other end to the IF OUT jack (the pre-wired IF output lead should be disconnected and taped).

4. Rewire the MODE switch (Fig. 4-22).
5. Wire the PROCESSOR switch (Fig. 4-23).
6. Remove the white/blue lead from pin "4" of the EXT-VFO socket and tape insulate its end. Solder the supplied 0.01 μ F capacitor to the EXT-VFO socket, pins "3" and "5". Solder a jumper between pins "2" and "3". Solder the new leads from the PROCESSOR switch to EXT-VFO pin "4", and from the MODE switch to pin "7" (Fig. 4-25).
7. When the modified TS-820S is to be operated independently, the 9P-MT plug must be installed, with pins "4" to "7" jumpered (Fig. 4-26).

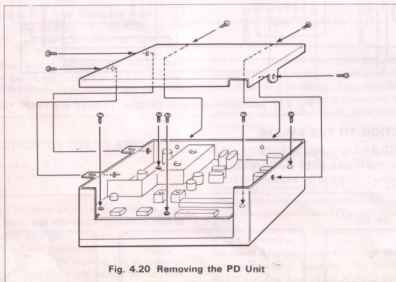
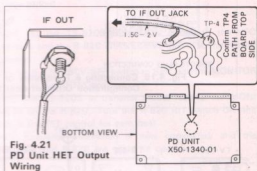
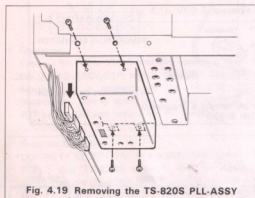

NOTE

VFO-820 OPERATION: If after modification remote VFO operation is desired, with the TS-820S, the following changes to the VFO cable connector are required.

- i) Remove the connector cover from the cable.
- ii) Disconnect the blue lead from the pin 4 and tape the lead end for proper insulation.
- iii) Short pins 4 and to 7 using a jumper wire.
- iv) Wrap the modified connector with a piece of tape so it can be easily identified in the future.

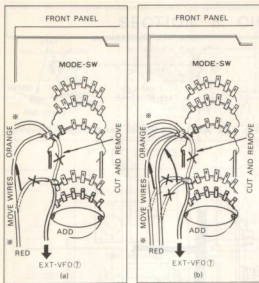

* (a) is for units with serial numbers 519999 and lower.
 (b) is for units with serial numbers 520000 and higher.
 These are for different production techniques. They do not reflect schematic or performance changes.

Fig. 4.22 MODE Switch Rewiring

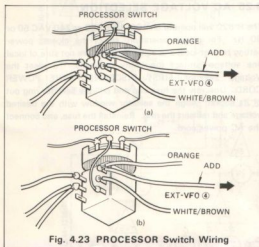

Fig. 4.23 PROCESSOR Switch Wiring

* (a) is for units with serial numbers 459999 and lower.
 (b) is for units with serial numbers 460000 and higher.

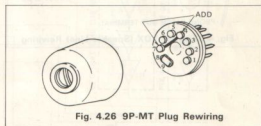
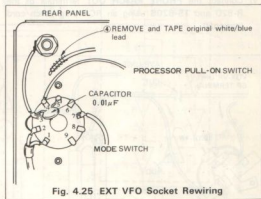
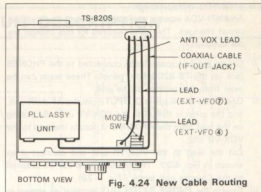
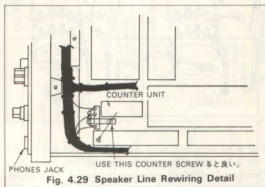
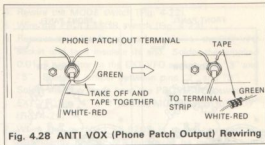
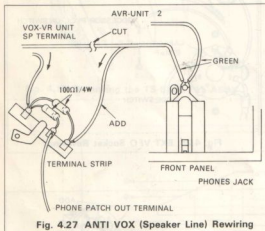

Fig. 4.26 9P-MT Plug Rewiring

8. ANTI VOX wiring change

An ANTI-VOX input is available by making the following circuit changes. The parts required for this change are not supplied.

- i) Locate the two green leads connected to the PHONES jack on the TS-820S front panel. These leads can be seen from the bottom of the unit.
- ii) One of the two leads is OUTPUT from the AF-AVR unit, and the other is INPUT to the VOX-VR unit. By pulling on the lead from the AF-AVR unit, locate the lead to the VOX-VR unit.
- iii) Cut the lead to the VOX-VR unit and connect it as shown in Fig. 4-27. The terminal strip can be secured to the Counter unit screw (Fig. 4-29).
- iv) Rewire the PHONE PATCH OUT terminal as shown in Fig. 4-28. Tape the leads for proper insulation.
- v) Connect the PHONE PATCH OUT terminals of the R-820 and TS-820S using an RCA plug patch cord (optional).



4.25 AC VOLTAGE SELECTION

The R-820 will operate on 100, 120, 220 or 240 VAC 50 or 60 Hz. For proper operation, select the closest power setting to your local line voltage. If you are not sure of local line voltage contact the utility company. To reset the Voltage Selector, FIRST DISCONNECT THE POWER CORD. Unscrew the fuse cap and pull the selector ring out of its socket. Align the selector window with the desired voltage and reinsert the ring. Reinstall the fuse, and connect the AC power cord.

5.1 BLOCK DIAGRAM GENERAL DESCRIPTION (FIG. 5-1)

Refer to the BLOCK DIAGRAM, (Fig. 5-1) input from the antenna (1.8 ~ 30 MHz and WWV) is fed to the RF unit through the RF attenuator. BC band signals are fed to the CONV unit where they are converted to the 29.5 MHz range and applied to the RF unit.

In the RF unit, signals pass through the RF amplifier, double-tuned circuit and buffer, are fed to the 1st Mixer and are converted to the 1st IF, 8.83 MHz. This signal is fed to the IF-A unit, through the 8.83 MHz crystal filter and then to the 2nd Mixer. Converted the 2nd IF 455 kHz, the signal passes through the 455 kHz ceramic filter and is applied to the 3rd Mixer, where it is converted to 50 kHz the 3rd IF.

The 1.8 ~ 29.5 MHz signals (plus WWV 15 MHz) are processed through the triple conversion superheterodyne circuit, while BC band signals are quadruple converted. The 1st and 2nd IF circuits are provided with crystal and ceramic filters to improve selectivity. Use of a 455 kHz filter in the 2nd IF allows the IF Shift and Variable Bandwidth Tuning to operate independently. The 3rd IF 50 kHz filter improves the Notch characteristic, and eliminates the IF Shift's effect on Notch operation.

The 1st Mixer, 2nd Mixer and Converter are balanced, using dual gate MOS FET's to ensure high receiver reliability. All RF signal circuits employ dual gate MOS FET's to provide excellent selectivity, S/N and AGC characteristic.

Fig 5-2 shows TS-820S frequency construction. The following shows frequency relationships:

$$\begin{aligned} \text{Transmit/receive frequency} &= \text{VCO frequency} - \text{CAR1 frequency} \quad (1) \\ \text{VCO frequency} &= (\text{CAR1 frequency} - \text{VFO frequency}) \\ &+ \text{HET frequency} \quad (2) \end{aligned}$$

When equation (2) is substituted for equation (1).

Transmit/receive frequency =

HET frequency - VFO frequency

Thus, the transmit/receive frequency is independent of CAR1 frequency.

Fig. 5-3 shows R-820 frequency construction.

Receive frequency = VCO frequency -

CAR2 frequency - MIX D output frequency +

CAR3 frequency _____ (3)

VCO frequency = (CAR1 frequency - VFO frequency) + HET frequency _____ (4)

MIXD output frequency = (CAR1 frequency - CAR2 frequency) + CAR3 frequency _____ (5)

When equations (4) and (5) are substituted for equation (3).

Receive frequency = HET frequency - VFO frequency.

Thus, receive frequency is independent of CAR1, CAR2 and CAR3 frequencies.

Consequently, when the TS-820S HET signal is applied to the R-820 using a common VFO frequency, full transceive operation with matched transmit/receive frequency can be effected.

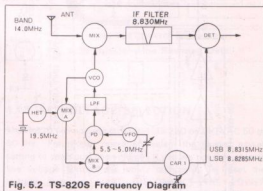

Fig. 5.2 TS-820S Frequency Diagram

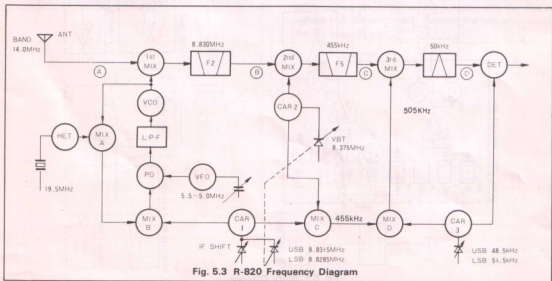

Fig. 5.3 R-820 Frequency Diagram

5.2 VARIABLE BANDWIDTH TUNING (VBT) CIRCUIT

The VBT circuit functions to continuously change the IF filter passband by equivalently crossing the passbands of the 1st (8.83 MHz) and 2nd IF (455 kHz) filters.

Since passband center frequency remains unchanged, the IF passband can be IF SHIFTED varied without changing its center frequency, or the filter's passband(center frequency) can be shifted to an optimum point while maintaining the set VBT passband. Thus, interference signals are markedly eliminated. Fig. 5-3 shows the VBT circuit block diagram. Suppose that a 14.00 MHz USB signal is received at the antenna. Under normal operating conditions, the VFO is set to 5.5 MHz, CAR-1 to 8.8315 kHz and HET to 19.5 MHz. Thus, oscillator injection to the 1st Mixer is 22.8315 MHz, and the SSB signal "A" with 14.0015 MHz center frequency is converted to the SSB signal "B" with 8.830 MHz center frequency by the 1st Mixer(22.8315 - 14.0015 = 8.8300).

This signal is further converted to 455 kHz by the 2nd Mixer and to 50 kHz by the 3rd Mixer. At this stage, Variable Bandwidth is controlled by adjusting CAR2 by the VBT control. For simplified explanation, assume filters F2 and F5 passbands for normal CAR-1 and CAR-2 conditions are 2.7 kHz.

Fig. 5-4 (A) shows filter F2 and F5 characteristics and the signal status where the VBT(CAR-2) is set to 8.375 kHz and CAR-1 to 8.8315 kHz. Since the filter characteristic coincides with the signal, the passband is 2.7 kHz.

Fig. 5-4 (B) shows CAR-2 set to 8.374 kHz and CAR-1, interlocked with the VBT, set to 8.831 kHz. In this instance, with the VBT control counterclockwise the signal passing through F2 is shifted down by 500 Hz. Bandwidth of the signal passing through the 8.830 kHz filter is 8,828.65-8,830.85 kHz, or 500 Hz narrower than "normal". Thus, filter bandwidth becomes 2.2 kHz, and the signal passing through the 455 kHz filter becomes 455.5 kHz \pm 850 Hz- the overall bandwidth of signals passing through F2 and F5 is therefore 1.7 kHz.

Since CAR-3 produces a 48.5 kHz(USB) BFO signal, the MIX-D output is (8,831.0 - 8,374.0) + 48.5 = 505.5 kHz, so the signal at "C" (455.5 kHz \pm 850Hz) is converted to the signal at "D" (50 kHz \pm 850 Hz) by the 3rd Mixer. The difference frequency between CAR-1 and CAR-2 (8,831.0 - 8,374.0) is 457.0 kHz, which is a Carrier frequency 1.5 kHz higher than the sum of F2 and F5 signals center frequency. Since the relationship between F5 center frequency and the carrier remains the same, composite F2 and F5 filter characteristic is such that only the bandwidth is narrowed to 1.7 kHz, while the filters are not shifted.

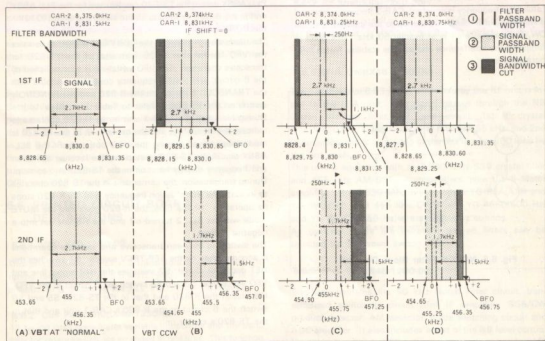

Fig. 5.4 VBT Operation

5.3 IF SHIFT CIRCUIT

Fig. 5-4(C) shows CAR-1 set to 8,831.25 kHz with the VBT control positioned as in Fig. 5-4(B) and the IF SHIFT control adjusted clockwise. Since CAR-1 has been set to 8,831.0 kHz (in Fig. 5-4(B)), the signal center frequency is 250 Hz higher even when the IF SHIFT control is centered.

In this case, signal bandwidth through F2 is 8,828.65 — 8,831.1 kHz or 2.4 kHz which is 250 Hz narrower than "normal", where the signal through F5 is the same as in Fig. 5-4(B). The difference frequency (8,831.25 — 8,374.0) between CAR-1 and CAR-2 is 457.25 kHz, which is a Carrier frequency 1.75 kHz higher than the sum of F2 and F5 composite center frequency.

Consequently, the bandwidth is 1.7 kHz, and filter center frequency is shifted +250 Hz as compared to ANT input. Fig. 5-4(D) shows 1.7 kHz bandwidth as in Fig. 5-4(C), but with the center frequency shifted -250 Hz.

5.4 NOTCH CIRCUIT

Although the R-820 is designed so that its various oscillators can be adjusted by the VBT and IF SHIFT circuits, the frequency relationship of the "D" mixer signal (Fig. 5-5) remains constant, providing CAR-3 frequency is at "normal". CAR-3 output is mixed with MIX C output through MIX D and is fed to the 3rd Mixer: the 3rd mixer output frequency is constant even when CAR-1 and CAR-2 frequencies are varied.

The 3rd IF signal center frequency can be varied by changing CAR-3 frequency. Audio output pitch remains the same. The NOTCH circuit functions when the 50 kHz (center frequency) filter is turned ON, as shown in Fig. 5-6. Since Notch filter frequency is constant, CAR-3 frequency is varied to shift the 3rd IF center frequency so the interfering signal (CW, heterodyne, etc.) is at exactly 50 kHz. This process eliminates the interference and assures stabilize Notch filter characteristic.

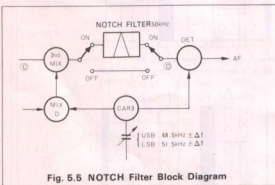

Fig. 5.5 NOTCH Filter Block Diagram

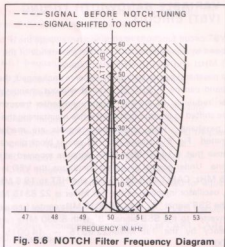

Fig. 5.6 NOTCH Filter Frequency Diagram

5.5 TRANSCIVE CONNECTION CIRCUIT CONFIGURATION

A schematic diagram for full transceive connection between the R-820 and TS-820 (wiring already modified) is shown in Fig. 5-7.

For full transceive connection, the HET oscillator in the R-820's PLL-ASSY unit must be made inoperative by turning off Q12 so as to make the R-820 frequency agree with the TS-820 frequency. Then the HET oscillator output from the PLL-ASSY unit in the TS-820 can be used for the PLL-ASSY unit in the R-820 by turning on the switching circuit (Q11) in the CONV unit.

The diode switch circuit in the CONV unit is used to connect the VFO line of the R-820 with that of the TS-820 for transceive operation. The VFO switching is accomplished by the B circuit, and a split frequency control is available with the TRANSCIVE switch on the R-820 and the FUNCTION switch on the TS-820. (Refer to Table 2 on page 14.) During reception, the CAR-1 unit in the R-820 operates to indicate the frequency; and the carrier unit in the TS-820 is made inoperative, causing the VCO output from the PLL-ASSY unit in the TS-820 to stop and the receiver operation and frequency display function in the TS-820 also to stop. During transmission, the carrier unit in the TS-820 operates to indicate the transmission frequency, and the R-820 stops its operation. At the time, the R-820 goes into the MUTE mode with its RL-12 turned off and the RB line set into a negative voltage.

The switching between transceive and separate operations is accomplished by the SEP-TRCV switch. S1 switches the HET oscillator circuit; S2 switches the HET signal line and VFO signal line; S3 and S4 switch the B circuit in the VFO-FIX unit in the R-820 and that in the TS-820; S5 and S6 switch the B circuit in the R-820's CAR-1 unit and that in the TS-820's carrier unit.

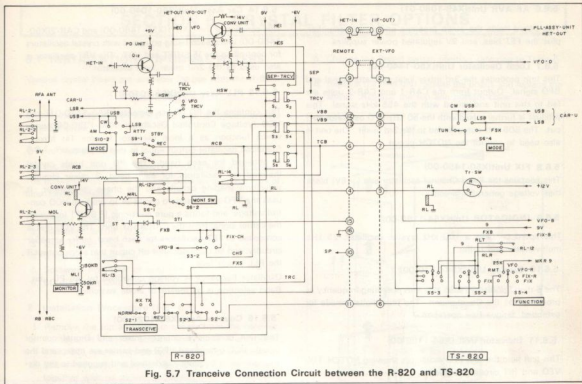

Fig. 5.7 Tranceive Connection Circuit between the R-820 and TS-820

During tranceive operation, if the SEP-TRCV switch is set to the TRCV and the STBY-REC switch is set to the REC, then the TS-820 operates as a receiver. If the STBY-REC switch is set to the STBY position, the display goes out and the VFO in the R-820 operates as an external VFO for the TS-820.

For VFO tranceive connection:

Setting the PULL-VFO switch at the rear to the VFO position permits VFO tranceive connection. The HET signal lines in the R-820 and TS-820 are turned off, and the HET oscillator in the R-820 goes into operation. Since the CAR-1 unit in the R-820 and the carrier unit in the TS-820 perform transmission/reception operation, frequency display ON-OFF operation is not available.

5.6 PRINTED CIRCUIT BOARD DESCRIPTIONS

5.6.1 VFO X40-1110-00

This unit contains 2 FET's, 2 transistors, and 3 diodes. Its tuning range is 5.0 to 5.5 MHz- frequency stability is excellent. VFO output is the PLL VCO reference input.

5.6.2 Coil Pack Unit(X44-1230-00)

All tuning coils preselector variable capacitors and the band selector rotary switch are arranged in one unit. This function together with the RF unit.

5.6.3 RF Unit(X44-1240-00)

The RF unit consists of an FET RF amplifier and the balanced 1st mixer circuit. It also includes the RB voltage source circuit.

5.6.4 IF-A Unit(X48-1190-00)

The 1st IF signal(8.83 MHz) converted by the RF unit is input to the IF-A unit. This signal passes through the NB (Noise Blanker) filter, NB gate circuit, 1st IF crystal filter(8.830 MHz), 2nd mixer, 2nd IF filter(455 kHz) and 2nd IF amplifier, and is converted to the 3rd IF signal(50 kHz) by the 3rd mixer.

This unit is equipped with an 8.830 MHz SSB crystal filter and 455 kHz AM/SSB ceramic filters, plus the S-Meter amplifier. The 8.830 MHz crystal filters YG-88A(AM) and YG-88C(CW), and 455 kHz CW filters, YG-455C(500 Hz) and YG-455CN(250 Hz) are available as options.

As optional filters are installed, desired filters can be selected by the Preset switch.

5.6.5 IF-B Unit(X48-1200-00)

This unit contains the 50 kHz Notch Filter circuit, transistorized switching circuit, 3rd IF amplifier, SSB/CW product detector, AM detector, diode switching circuit and AGC amplifier. It also includes a part of the NB level control circuit and a Notch OFF voltage generator circuit for AM operation.

5.6.6 AF AVR Unit(X49-1080-01)

This board holds the audio preamps and power amplifier, plus the FET bias, and 9V regulated power supplies.

5.6.7 Local Oscillator Unit(X50-1440-00)

This unit produces the 3rd mixer local oscillator signal and BFO signal. Output from the CAR-1 and CAR-2 units are fed to this unit and mixed with the 455 kHz signal. This product is further mixed with the 50 kHz BFO oscillator output. The 505 kHz output is fed to the 3rd mixer. The unit is also used to control the NOTCH circuit.

5.6.8 FIX Unit(X50-1450-00)

This contains the Fixed Channel oscillator and (-6V) block bias voltage generator circuit.

5.6.9 INDICATOR Unit(X54-1180-00)

This board contains a 100 kHz crystal, oscillator, 25 kHz multivibrator and buffer.

5.6.10 Display Unit(X54-1310-00)

The 6-digit fluorescent tube indicates operating frequency as processed by the Counter unit. The blue digits provide for extended, fatigue-free operation.

5.6.11 Indicator Unit (X54-1180-00)

This unit hold the four LED indicators showing NOTCH, FIX, VFO and RIT circuit operation.

5.6.12 NB Unit(X54-1330-00)

This holds the noise amplifier and the NB Gate switch drive circuit. It detects and amplifies pulse noise to drive the Gate switching diodes on the IF-A unit, operating the Noise Blanker circuit.

5.6.13 VR Unit(X54-1340-00)

This board holds the NB, MONI and tone controls.

5.6.14 Car Assy Unit(X60-1040-00)

This consists of the CAR-1(X50-1480-00) and CAR-2(X50-1460-00) units, each being equipped with crystal oscillators for controlling the IF SHIFT and VBT. The VBT oscillator is also used as the 2nd mixer local oscillator.

5.6.15 PLL Assy Unit(X60-1010-01)

This contains the PD (Phase Detector)(X50-1130-01) and VCO (Voltage Controlled Oscillator) (X50-1330-00), units which function as a local oscillator for the 1st Mixer. Stabilized oscillator output equal to that of the built-in VFO is obtained for each band. The PD unit holds crystal (heterodyne) oscillators for each band, 2 mixer circuits, waveform shaping circuits and the phase comparator. It uses the VFO as a standard oscillator to produce VCO control voltage, and forms a pure electronic IF SHIFT loop with the carrier signal from the CAR ASSY unit. The VCO unit is composed of FET oscillators for each band, buffer amplifier circuitry, and an oscillator shut-off circuit that stops output if the PLL circuit fails.

Oscillator frequency is voltage controlled by the PD unit. Band selection is by means of diode switching.

5.6.16 Counter Assy(X60-1020-00)

This unit contains a counter mixer and Digital counter board. VCO (processed VFO) and carrier are mixed and the true operating frequency is derived and supplied to the display unit.

5.6.17 Converter Unit

This unit is used to receive SW (Short Wave) broadcasts in the 49m, 31m, 25m and 16m bands. The input circuit for each band consists of bandpass filters. The local oscillator circuit is equipped with crystal oscillators which, together with the bandpass filters, are selected by diode switches. Frequency display is via the mixed local oscillator and PLL outputs. Actual operating frequency is displayed because composite local oscillator signals are used. This unit also contains the HET and VFO signal switching circuit which selects FULL or VFO TRANSCIVE operation and the Monitor control circuit.

SECTION 6. CRYSTAL FILTER OPTIONS

6.1 INSTALLATION: OPTIONAL FILTERS

Various crystal filters are available for use with the R-820.

CAUTION

Before installing crystal filters, be sure to disconnect the POWER cable.

6.6.1 Preparation

The following tools are required for crystal filter installation. The nutdriver may not be required, depending on the type of filter being installed.

1. Phillips Screwdriver
2. Nutdriver, 3m/m (7/32")
3. Long Nosed Pliers
4. Diagonal Cutting Plier
5. Soldering Iron(40W or less)
6. 60/40 Rosin Core Solder

2 Installation Procedure (Fig. 6-1)

1. Remove the top and bottom covers from the receiver.
2. Remove the shield (4 screws) from the IF-A unit (X48-1190-00), located on the left hand side of the chassis.
3. Disconnect and remove the IF-A unit (4 screws) together with its mounting bracket.
4. Install the Crystal Filter on the IF-A unit.

NOTE 1

Different filters are installed by separate procedures.

NOTE 2

Because the board is flow-soldered, the filter lead holes will probably be covered, and must first be opened by desoldering.

NOTE 3

Use a low power iron for a short time only. Too much heat will damage the crystal filter!

- i) YG-88A
Remove the jumper wire and resistor R66 from the circuit board (marked 6 kHz) on the upper left side. Install the filter by soldering the 4 pins from the rear side of the board.
- ii) YG-88C
Install the filter on the circuit board (marked 0.5 kHz) on the lower left side by soldering the 4 pins from the rear of the board.
- iii) YG-455C, YG-455CN
Install these filters on the circuit board (marked 0.5 kHz or 0.25 kHz) on the right side. Tighten the filter to the board using the supplied nut, and solder the pins.

5. Change the Preset switch position, referring to Table 6-1.
6. Replace the IF-A unit recable the board, and replace the shield. Replace the top and bottom cover.

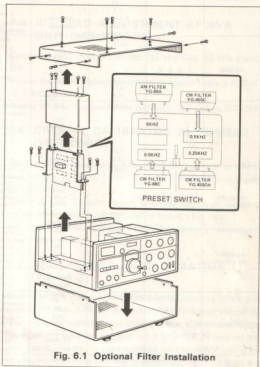

Fig. 6.1 Optional Filter Installation

6.2 FILTER PRESET SWITCHING IF-A (FIG. 6-2)

After crystal filters have been installed, set the Preset switch per Table 6-1, which shows passband width as determined by PRESET, SELECTIVITY, and MODE switch positions. The PRESET switch has no effect on the YG-88A (8.83 MHz AM filter).

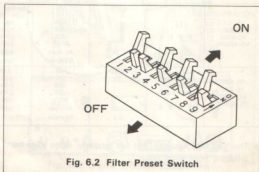

Fig. 6.2 Filter Preset Switch

TABLE 6.1 Filter Preset Switch Settings

Optional Filter	Preset Switch Position ON (All others OFF)	Selectivity	Mode	1 IF Filter	2 IF Filter	Pass Band Width	Adjustment Range	Note
No optional filter installed	1 4 6 8	AUTO	AM	No filter: Signal passes through	6 kHz	6 kHz	—	No effect use auto only If not noted, same pass band width
		CW USB LSB RTTY	2.7 kHz 2.7 kHz 2.7 kHz 2.7 kHz	2.7 kHz 2.7 kHz 2.7 kHz 2.7 kHz	2.4 kHz 2.4 kHz	600 Hz~2.4 kHz 600 Hz~2.4 kHz 600 Hz~2.4 kHz 600 Hz~2.4 kHz		
YG-88A	1 4 6 8	0.25	—	—	—	—	—	No effect use auto only
		0.5	—	—	—	—	—	
		2.4 kHz	All mode	2.4 kHz	2.4 kHz	2.4 kHz	600 Hz~2.4 kHz	No effect use auto only
		6 kHz	All mode	No filter: Signal passes through	6 kHz	6 kHz	—	
YG-88A	1 4 6 8	AUTO	AM	6 kHz	6 kHz	6 kHz	4.3 kHz~6 kHz	No effect use auto only
		CW USB LSB RTTY	2.7 kHz 2.7 kHz 2.7 kHz 2.7 kHz	2.7 kHz 2.7 kHz 2.7 kHz 2.7 kHz	2.4 kHz 2.4 kHz 2.4 kHz 2.4 kHz	600 Hz~2.4 kHz 600 Hz~2.4 kHz 600 Hz~2.4 kHz 600 Hz~2.4 kHz		
		0.25	All mode	—	—	—	—	No effect use auto only
		0.5	All mode	—	—	—	—	
YG-455C	1 3 6 9	AUTO	AM	No filter: Signal passes through	6 kHz	6 kHz	—	Mmmmmmmmm
		CW USB LSB RTTY	2.7 kHz 2.7 kHz 2.7 kHz 2.7 kHz	500 Hz 2.7 kHz 2.7 kHz 500 Hz	500 Hz 2.4 kHz 2.4 kHz 500 Hz	600 Hz~2.4 kHz 600 Hz~2.4 kHz		
		0.25	All mode	—	—	—	—	No effect use auto only
		0.5	All mode	2.7 kHz	500 Hz	500 Hz	—	
YG-455CN	1 3 5 6	AUTO	AM	No filter: Signal passes through	6 kHz	6 kHz	—	No effect use auto only
		CW USB LSB RTTY	2.7 kHz 2.7 kHz 2.7 kHz 2.7 kHz	250 Hz 2.7 kHz 2.7 kHz 250 Hz	250 Hz 2.4 kHz 2.4 kHz 250 Hz	800 Hz~2.4 kHz 800 Hz~2.4 kHz		
		0.25	All mode	0	250 Hz	—	—	No effect use auto only
		0.5	All mode	—	—	—	—	
YG-455C YG-455CN	1 3 6 9	AUTO	AM	No filter: Signal passes through	6 kHz	6 kHz	—	No effect use auto only
		CW USB LSB RTTY	2.7 kHz 2.7 kHz 2.7 kHz 2.7 kHz	500 Hz 2.7 kHz 2.7 kHz 500 Hz	500 Hz 2.4 kHz 2.4 kHz 500 Hz	800 Hz~2.4 kHz 800 Hz~2.4 kHz		
		0.25	All mode	2.7 kHz	250 Hz	250 Hz	—	No effect use auto only
		0.5	All mode	2.7 kHz	500 Hz	500 Hz	—	
YG-88C	2 4 7 8	AUTO	AM	No filter: Signal passes through	6 kHz	6 kHz	—	No effect use auto only
		CW USB LSB RTTY	2.7 kHz 2.7 kHz 2.7 kHz 2.7 kHz	500 Hz 2.7 kHz 2.7 kHz 500 Hz	500 Hz 2.4 kHz 2.4 kHz 500 Hz	600 Hz~2.4 kHz 600 Hz~2.4 kHz		
		0.25	All mode	500 Hz	—	—	—	No effect use auto only
		0.5	All mode	500 Hz	2.4 kHz	500 Hz	—	
YG-88C YG-455C	2 4 6 9	AUTO	AM	No filter: Signal passes through	6 kHz	6 kHz	—	No effect use auto only
		CW USB LSB RTTY	500 Hz 2.7 kHz 2.7 kHz 500 Hz	500 Hz 2.7 kHz 2.7 kHz 500 Hz	500 Hz 2.4 kHz 2.4 kHz 500 Hz	150 Hz~500 Hz 600 Hz~2.4 kHz 600 Hz~2.4 kHz 150 Hz~500 Hz		
		0.25	All mode	500 Hz	—	—	—	No effect use auto only
		0.5	All mode	500 Hz	500 Hz	500 Hz	150 Hz~500 Hz	
YG-88C YG-455CN	2 4 7 8	AUTO	AM	No filter: Signal passes through	6 kHz	6 kHz	—	No effect use auto only
		CW USB LSB RTTY	500 Hz 2.7 kHz 2.7 kHz 500 Hz	2.7 kHz 2.7 kHz 2.7 kHz 500 Hz	500 Hz 2.4 kHz 2.4 kHz 500 Hz	600 Hz~2.4 kHz 600 Hz~2.4 kHz		
		0.25	All mode	500 Hz	250 Hz	250 Hz	—	No effect use auto only
		0.5	All mode	500 Hz	2.4 kHz	500 Hz	—	
YG-88C YG-455C YG-455CN	2 4 6 9	AUTO	AM	No filter: Signal passes through	6 kHz	6 kHz	—	No effect use auto only
		CW USB LSB RTTY	500 Hz 2.7 kHz 2.7 kHz 500 Hz	500 Hz 2.7 kHz 2.7 kHz 500 Hz	500 Hz 2.4 kHz 2.4 kHz 500 Hz	150 Hz~500 Hz 600 Hz~2.4 kHz 600 Hz~2.4 kHz 150 Hz~500 Hz		
		0.25	All mode	500 Hz	250 Hz	250 Hz	—	No effect use auto only
		0.5	All mode	500 Hz	500 Hz	500 Hz	150 Hz~500 Hz	
YG-88A YG-88C YG-455C YG-455CN	Switch has no effect for AM YG-88A	AUTO	AM	6 kHz	6 kHz	6 kHz	4.3 kHz~6 kHz	No effect use auto only
		0.25	All mode	500 Hz	500 Hz	500 Hz	150 Hz~500 Hz	
		0.5	All mode	500 Hz	500 Hz	500 Hz	150 Hz~500 Hz	

★ The VBT will function, but not properly, since pass band width characteristic of the 8.830 MHz and 455 kHz filters are different from each other.

SECTION 7. MAINTENANCE AND ALIGNMENT

7.1 GENERAL INFORMATION

The R-820 has been factory aligned and tested to specification before shipment.

Under normal circumstances, the receiver will operate in accordance with these operating instructions when properly adjusted.

Attempting service or alignment without factory authorization can void the receiver's warranty.

When operated properly, the receiver can give years of service without requiring realignment.

The information in this section, some general service procedures, can be accomplished without sophisticated test equipment. A full service manual is available as a separate publication.

7.2 REMOVING THE CABINET (FIG. 7-1)

Remove the eight top cover screws and nine bottom cover screws and lift away the panels.

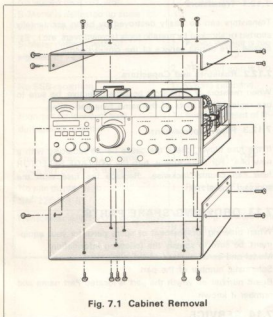

Fig. 7.1 Cabinet Removal

7.3 9V ADJUSTMENT AF AVR UNIT (X49-1080-01)

Adjust VR4 for 9V between the "9" terminal and chassis.

7.4 AGC BIAS ADJUSTMENT AF AVR UNIT (X49-1080-01)

Adjust VR1 for 3.5V between the "RF1" terminal and chassis.

7.5 RIT ZERO ADJUSTMENT AF AVR UNIT (X49-1080-01)

Center the RIT control turn the RIT and CAL 25 kHz switch ON.

Adjust the Main Tuning for a beat of approximately 800 Hz to 1 kHz.

Adjust VR2 so the beat does not vary, RIT ON to RIT OFF.

7.6 CRYSTAL CALIBRATOR ALIGNMENT (X52-0000-01)

Set the MODE switch to AM, the BAND switch to WWV, and tune to 15,000.0 MHz. A 15 MHz WWV signal should be received.

Turn the CAL 25 kHz switch ON- the marker is superimposed on the WWV signal and is heard as a beat.

Adjust trimmer TC1 for zero beat. The marker's frequency is now calibrated.

7.7 DIGITAL DISPLAY CALIBRATION (FIG. 7-2)

Set the MODE switch to AM, the BAND switch to WWV and tune to 15,000.0 MHz. A 15 MHz WWV signal should be received. Connect the supplied Counter Calibration cable between the Counter unit and the X VERTER IN jack on the rear panel. A beat is superimposed on the WWV signal by the harmonics of the Counter standard oscillator. Adjust the Counter trimmer for a zero beat. The frequency indicated on the Digital Display is now accurately calibrated.

After calibration, disconnect the Counter Calibration cable.

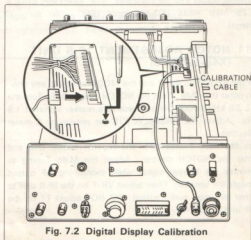

Fig. 7.2 Digital Display Calibration

7.8 ANT AND MIX COIL ALIGNMENT, COIL PACK UNIT (X44-1230-00)

ANT and MIX coils are contained in the Coil Pack unit. Turn the CAL 25 kHz switch ON to receive a marker signal. Terminate the ANT connector with a $50 \sim 75\Omega$ load resistor. Center the PRESELECTOR and adjust the ANT and MIX coils for maximum S-meter deflection, using Frequency Table 7-1.

Start with the 1.8 MHz band and proceed.

To adjust the 10M band, use only 29.0 MHz in the 29.0 MHz band.

TABLE 7.1 Coil Pack Alignment Order

BAND	ADJUSTMENT FREQUENCY	ANT COIL	MIX COIL
1.8	1.90 MHz	L 1	L 9.16
3.5	3.75 MHz	L 3	L10.17
7.0	7.25 MHz	L 4	L11.18
14.0	14.25 MHz	L 5	L12.19
21.0	21.25 MHz	L 6	L13.20
29.0	29.00 MHz	L 7	L14.21
WWV	15.25 MHz	L 2	L 8.15

7.9 IF ALIGNMENT, IF UNITS

Receive a Marker signal at any frequency by turning the CAL 25 kHz switch ON. Adjust the PRESELECTOR and Main Tuning for maximum S-meter deflection.

Adjust T4, T5, T6 and T8 on the IF-A unit (X48-1190-00), and T2 and T3 on the IF-B unit (X48-1200-00) until the S-meter indicates maximum deflection. DO NOT adjust T7 on the IF-A unit, T1 on the IF-B unit, or the Notch filter trim-pot VR1 on the IF-B unit.

7.10 S-METER ADJUSTMENT IF-A UNIT (X48-1190-00)

Disconnect the antenna and adjust VR1 on the IF-A unit for S-meter "zero". If a Standard Signal Generator (SSG) is available, adjust VR2 for the meter "S-9" indication, using a 14.25 MHz 40dB (50 μ V) signal (SSG open terminal voltage).

7-11 NOTCH ADJUSTMENT, IF-B UNIT (X48-1200-00)

Set the RF-ATT to 40dB and the MODE switch to any position other than AM. Turn the NOTCH switch OFF. Turn the CAL 25 kHz switch ON and receive a marker signal at 1.9 MHz. Adjust the PRESELECTOR for maximum S-meter deflection.

Turn the AGC switch OFF, the NOTCH switch ON, and center the NOTCH control. Adjust the Main Tuning to minimize the Marker signal while monitoring AF output through the speaker. Then adjust VR-1 on the IF-B unit to further minimize audio output. DO NOT adjust T1 on the IF-B unit.

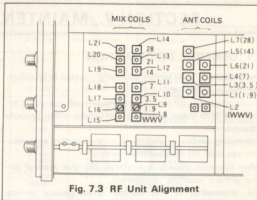

Fig. 7.3 RF Unit Alignment

7.12 MAINTENANCE

WARNING

ALWAYS Disconnect Power BEFORE Attempting Service.

CAUTION

If you are unfamiliar with Solid State techniques, refer service to a qualified TRIO-KENWOOD technician.

7.12.1 Transistors

Transistors can be easily destroyed by being accidentally shorted or shocked by metallic tools (screwdrivers, etc.). Exercise care during service of the circuit boards.

7.12.2 Resistors and Capacitors

When resistors or capacitors become defective, be sure to use replacement parts of the same type and rating.

7.12.3 Fuse Replacement

If the fuse blows, check the cause before replacing with a new one. For replacement, turn the VOLTAGE SELECTOR fuse cap counterclockwise. Replace the fuse with the supplied spare(1A).

7.13 ORDERING SPARE PARTS

When ordering replacement or spare parts for your equipment, be sure to specify the following information: Model and serial number of the equipment.

Schematic number of the part.

Board number on which the part is located Part name and number if known.

7.14 SERVICE

Should it ever become necessary to return the equipment for repair, pack in its original boxes and packing, and include a full detailed description of the problems involved.

You need not return external accessory items unless they are directly related to the service problem.

NOTE

When claiming Warranty service, please include a photocopy of the Bill of Sale, or other proof of purchase showing date of sale.

SECTION 8. TROUBLESHOOTING

If trouble arises with the unit, conduct the following checks.
If the trouble persists after having made these checks, con-

tact your dealer or nearest KENWOOD authorized Service facility.

Trouble	Cause	Remedy
Unit completely dead with Power switch ON.	<ol style="list-style-type: none"> 1. Incorrect AC connection. 2. Power connector loose. 3. Fuse blown. 	<ol style="list-style-type: none"> 1. Reconnect AC plug. 2. Reseat power connector. 3. Replace fuse. (If new fuse blows, unit is defective.)
No signals received with antenna connected, S-Meter at zero.	<ol style="list-style-type: none"> 1. VFO or Fixed Channel not operating. 2. REC-STBY switch in STBY position. 3. SEP-TRCV switch in TRCV position. 4. Selectivity switch set to vacant filter position. 5. Amateur Band switch not at 29.5 MHz. SW Band switch not at NORM. 	<ol style="list-style-type: none"> 1. Set TRANSCIVE switch to NORM or RX position. 2. Set to REC position. 3. Set to REC position. Check for opened or missing HET cable (to TS-820S). 4. Reset the Preset switch to correct settings. Set VBT control to NORMAL position. 5. Set amateur Band switch to 29.5 MHz. or set SW Band switch to NORM.
No signals received, and S-Meter is deflected up scale with antenna connected.	<ol style="list-style-type: none"> 1. RF gain reduced. 	<ol style="list-style-type: none"> 1. Turn RF-GAIN fully clockwise.
S-Meter deflects without signals.	<ol style="list-style-type: none"> 1. Power voltage is too low. 2. RF circuit gain is too low. 	<ol style="list-style-type: none"> 1. Reset Voltage Selector to correct local line voltage. 2. Turn RF-GAIN fully clockwise.
No SSB reception.	<ol style="list-style-type: none"> 1. Wrong sideband. 	<ol style="list-style-type: none"> 1. Set MODE switch to alternate SSB position.
High-cut (or low-cut) tone during SSB reception.	<ol style="list-style-type: none"> 1. Misadjustment of IF-SHIFT and/or VBT. 	<ol style="list-style-type: none"> 1. Set IF-SHIFT to normal (detent) position. Set VBT control to NORMAL position.
Frequency remains the same when RIT control is adjusted.	<ol style="list-style-type: none"> 1. RIT circuit is OFF. 	<ol style="list-style-type: none"> 1. Turn RIT ON.
No pan display with SM-220/BS-8.	<ol style="list-style-type: none"> 1. Reversed IF1, IF2 cables. 	<ol style="list-style-type: none"> 1. Correct reversed cables.
Transceiver ANTI-VOX inoperative.	<ol style="list-style-type: none"> 1. Missing, opened Anti-Vox cable. 2. ANTI-VOX modification not installed in Transceiver. 	<ol style="list-style-type: none"> 1. Repair or replace cable. 2. Reference section 4.24.8.

SCHEMATIC DIAGRAM

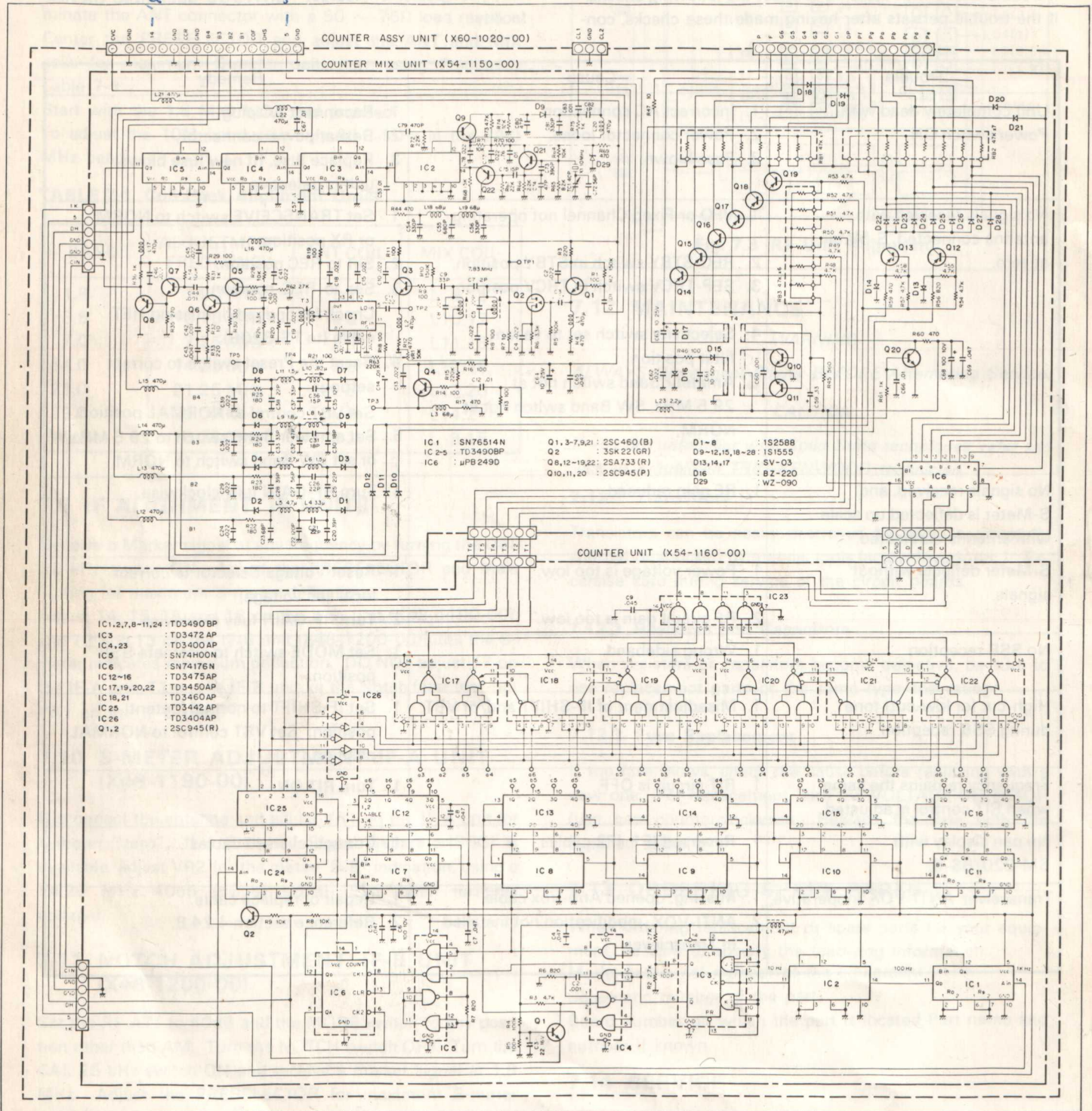

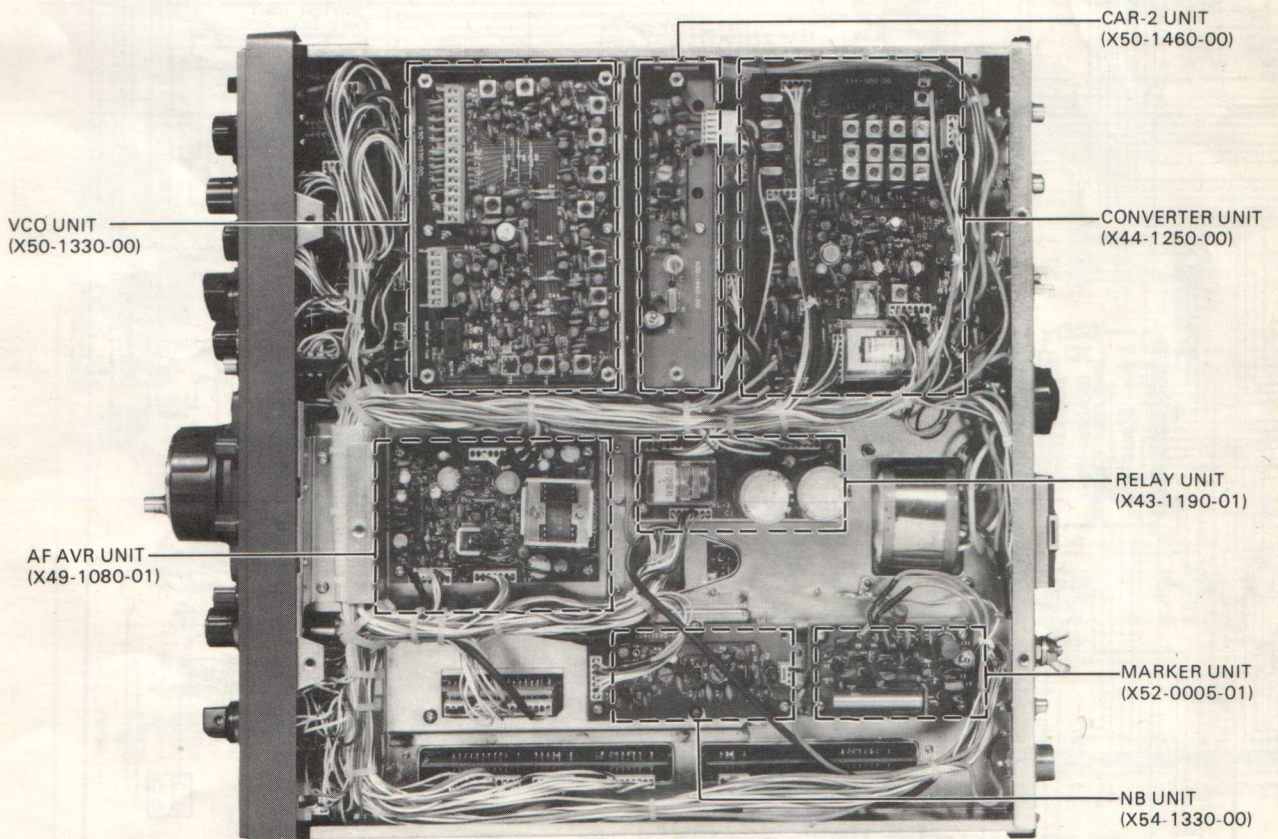
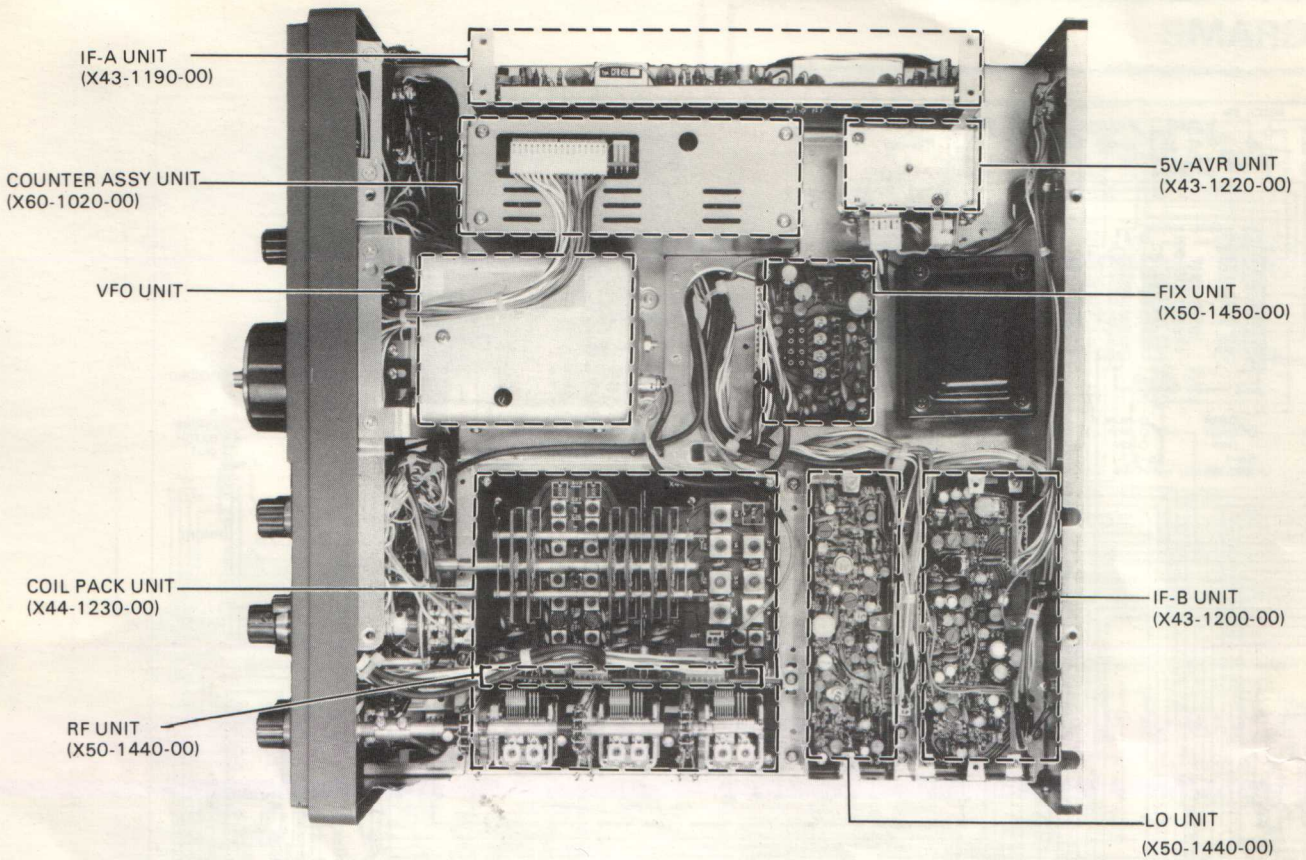



MODEL SP-820 SPEAKER

OPERATING MANUAL

We're happy that you've chosen the Model SP-820 for your receiving needs. It has undergone stringent quality control inspection and tests prior to packing and has left our factory in perfect operating condition. Please inspect your SP-820 carefully for any signs of damage in transit. If the unit is damaged, immediately notify the sales representative from whom you purchased the unit, or contact the nearest Kenwood authorized service facility.

GENERAL

Your SP-820 is a sophisticated external speaker designed to further enhance operation of the TS-820 SSB Transceiver. It features precise audio response and matches the TS-820 in appearance. Its advantages are:

- * Built-in selectable tone filters to attenuate high or low frequency response inputs;
- * Two channel selectable headphone output switchable through the tone filters.

CONTROLS AND THEIR FUNCTIONS

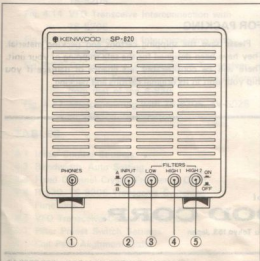

Front Panel

① PHONES Connector

Standard headphone output, switchable through the tone filters.

② INPUT Switch

Selects one of two audio inputs.

③ FILTERS, LOW Switch

This switch attenuates frequencies below 400 Hz; -3 dB at 400 Hz, -6 dB/octave.

④ FILTERS, HIGH 1 Switch

This switch attenuates frequencies above 3 kHz; -3 dB at 3 kHz, -6 dB/octave.

⑤ FILTERS, HIGH 2 Switch

This switch attenuates frequencies above 1.5 kHz; -3 dB at 1.5 kHz, -6 dB/octave.

FILTERS, HIGH 1 and HIGH 2 Switch

This switch attenuates frequencies above 1 kHz; -3 dB at 1 kHz, -6dB/octave.

USING COMBINED FILTERS

1. When both LOW and HIGH 1 filters are engaged, the pass bandwidth ranges from 400 Hz to 3 kHz.
2. When both LOW and HIGH 2 filters are engaged, bandwidth is 400 Hz to 1.5 kHz.
3. LOW, HIGH 1 and HIGH 2 filters engaged, 400 Hz to 1 kHz.

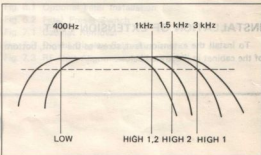

REAR PANEL

① ② INPUT Connectors

Accepts audio output from two sources.

③ LINE OUT Connector

Standard line output switchable through the filters for RTTY, SSTV, or similar use.

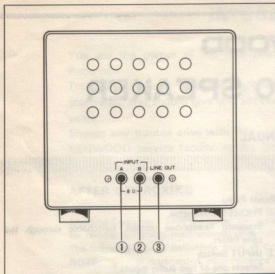

USE OF FILTERS

In general, it is desired that a CW, AM, or similar transmission be received clearly within the usual communications audio bandwidth, 300 Hz - 3 kHz. However, QRM, QRN or RFI may lower the overall signal-to-noise ratio at the receiver, resulting in degraded reception. In theory, as the pass-band width of the IF stages is narrowed, the equivalent noise bandwidth will also narrow, thus improving the signal-to-noise ratio. Alternately, the bandwidth of the AF stage can be narrowed to attenuate the noise component, enhancing reception.

Proper filter selection depends on transmission mode and type of noise encountered.

1. SSB: use the HIGH 1 filter. In more severe cases, use both HIGH 1 and LOW filters.
2. CW: use the HIGH 2 filter the HIGH 2 and LOW filters or HIGH 1+HIGH 2 and Low in combination.

INSTALLATION OF EXTENSION FEET

To install the extension feet, screw to the front, bottom of the cabinet as illustrated below.

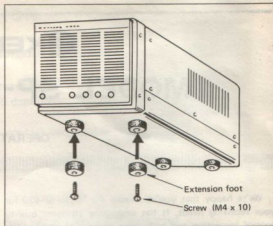

SPECIFICATIONS

Speaker used: 12 cm dia.
 Rated Input: 2 Watts
 Impedance: 8Ω
 Frequency response: 300Hz to 5kHz.

Filter cut-off frequency,

LOW: 400Hz, -3dB.

HIGH 1: 3kHz, -3dB.

HIGH 2: 1.5kHz, -3dB.

Filter attenuation: -6dB/oct.

Dimensions: 169 mm (6⁷/₁₆) wide x 153 mm (6¹/₁₆) high x 335 mm (13³/₁₆) deep. Values in () inch.

Net weight: 2.5kg. (5.5 lbs.)

Accessories furnished:
 Speaker cord, 1 pc.
 Extension foot, 2 pcs.
 Screw, M4 x 10, 2 pcs.
 1-pin plug, 2 pcs.

FOR PACKING

Please save the shipping cartons and packing material. They have been designed for the safe shipping of your unit. There will be considerably less chance of damage if you ship your unit in its original cartons and packing.



A product of

TRIO-KENWOOD CORP.

6-17, 3-chome, Aobadai, Meguro-ku, Tokyo 153, Japan

A product of
TRIO-KENWOOD CORPORATION
6-17, 3-chome, Aobada, Meguro-ku, Tokyo 153, Japan

TRIO-KENWOOD COMMUNICATIONS, INC.
115 West Walnut Street, Lombard, California 90250, U.S.A.

TRIO-KENWOOD COMMUNICATIONS, GmbH
D-8274 Garmisch-Partenkirchen, 84, West Germany

TRIO-KENWOOD (AUSTRALIA) PTY. LTD.
30 Whiting Street, Artarmon, Sydney N.S.W. Australia 2064