

KENWOOD

Service Manual



CONTENTS

ACCESSORIES	5	5 Memory Contents	18
BEFORE OPERATION	5	6 Entering Split Channel Frequencies	19
Controls Overview	6	7 Entering The Call Channel Frequency	19
THE BATTERY PACK		8 Recalling Memory Channels	20
1 NiCd Battery Pack (PB-13)	8	9 Memory Shift	20
2 Recharging	8	10 Memory Channel Character Display	21
3 Installing The Battery Pack	8	SCANNING	
4 Battery Voltage Level	9	1 Hold/Resume Programming	22
5 Battery Operating Time	9	2 Scan Options	22
RECEIVER OPERATION		3 Scanning Memory Channels	23
1 Getting started	10	4 Locking Out Memory Channels	23
2 Selecting Frequency	11	5 Band Scanning	24
3 Step Size Selection	12	6 Programmable Band Scan	24
4 Programmable VFO Tuning Limits	14	7 MHz Scan	26
5 Subband Reception	14	8 VFO/Memory Scan	26
TRANSMITTER OPERATION		9 CALL/VFO Scan	26
1 To transmit	15	10 CALL/Memory Scan	26
2 Changing Transmitter Output Power	15	11 V/M/C(VFO/Memory/CALL) Scan	26
3 TX. Stop Function	16	REPEATER OPERATION	
4 Time Out Timer	16	1 Transmitter Offsets	27
USING THE MEMORY		2 Selecting the Offset Direction	27
1 Microprocessor Memory Backup	17	3 Automatic Offset Selection	27
2 Entering Memory Data	17	4 Manual Offset Selection	28
3 Initializing The Memory	18	5 The Reverse Function	28
4 Memory Channel	18	6 Tone Operation	29
		7 Autopatch Operations	30
		8 DTMF Memory	31

CTCSS OPERATION	33
------------------------	----

THE DUAL TONE SQUELCH SYSTEM (DTSS)

1 DTSS Code	34
2 Using the DTSS Function	34
3 Using DTSS with a Repeater	35

PAGING

1 Paging Operation Overview	36
2 Paging Code Memory	37
3 Setting Paging Codes	37
4 Sending Pages (Calling)	38
5 Receiving Pages (Wait)	40
6 Canceling Signal Squelch	41
7 Locking Out Codes	41

MESSAGE TRANSMISSION AND RECEPTION

1 Message Transmission Modes	42
2 Using the Message Memory	42
3 Message Memory Check	44
4 Message Memory Transmission	44
5 Message Reception	44
6 Receive Message Memory	45

ENHANCED RECEIVER FUNCTION

1 The Tone Alert System	46
2 Monitor	47
3 Beep Off	47
4 Lamp	47
5 Key Lock	47
6 Channelized Frequency Display	47

POWER SAVER FEATURES

1 The Battery Saver Mode	48
2 Automatic Power Off (APO)	48

CLOCK FUNCTION

1 Time Setting	49
2 Timer Function	49

CROSS BAND OPERATION

MAINTENANCE

1 General Information	52
2 Service	52
3 Record Keeping	52

TROUBLESHOOTING

ACCESSORIES

1 Installing the CTCSS Unit (TSU-7)	55
2 Memory Expansion Unit (ME-1)	56
3 Programming the SMC-33 Remote Control Speaker Microphone	57
4 Using other microphones	59
5 Connecting an External Speaker	59

SPECIFICATIONS

QUICK REFERENCE

ACCESSORIES

Antenna (TH-28A/28E)	T90-0444-××
Antenna (TH-48A/48E)	T90-0445-××
Belt Hook	J29-0465-××
Hand Strap	J69-0317-××
Rubber Cap	B09-0329-××
AC plug (M type only)	E19-0254-××
NiCd Battery Pack(PB-13)	W09-0563-××
Battery Charger(BC-14)		
for U.S.A. and Canada (120V)	W09-0565-××
for Europe (220V)	W09-0569-××
for U.K.version (240V)	W09-0568-××
for Oceania (240V)	W09-0567-××
for other market (120/240V)	W09-0566-××
Instruction Manual	B62-0236-××
Warranty Card(U.S.A.,Canada,and Europe)		

CAUTION

Transmitting with the supplied antenna near other electronic equipment can interfere with that equipment. Also, transmitting near a regulated power supply may cause the power supply to output an extremely high voltage that could damage both your transceiver and any other equipment connected to the supply.

BEFORE OPERATION

Thank you for purchasing this KENWOOD transceiver. To get the most out of its many features, we suggest you read this instruction manual carefully, and keep it handy for further reference.

To get ready to transmit and receive.

- 1 Check the accessories list to be sure everything you need has been included in the package.
- 2 Charge the included NiCd battery pack, following the instructions completely before proceeding. (see page 8)

When you have everything checked out and charged, you're ready to get to the Receiver Operation section and get up and running with your new equipment. Other sections follow in a logical order to help you learn and use this transceiver to its full potential.

CAUTION

The recommended transceiver duty cycle is 1 minute of transmission and 3 minutes of reception. Longer transmissions or extended operation in the HI power mode may cause the back of the transceiver to get hot. Do not place the transceiver where the heat sink (rear panel) might come in contact with plastic or vinyl surfaces.

Controls Overview

This transceiver has different key layouts for each destination. Check the version of your transceiver first by looking at the following illustration.

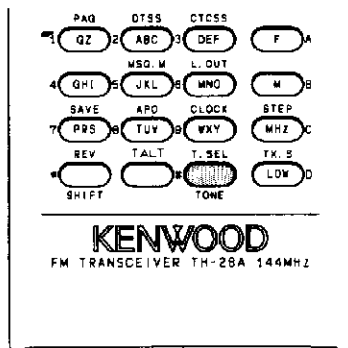
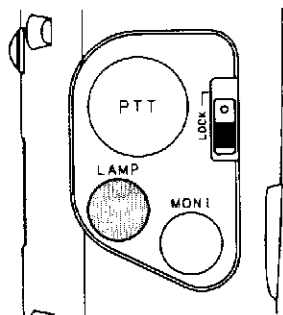

All types except U.K and European version

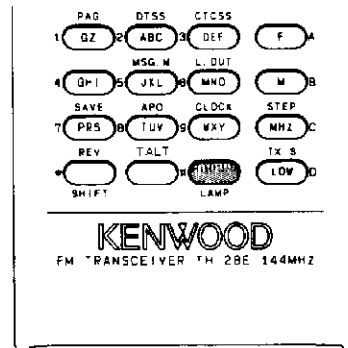
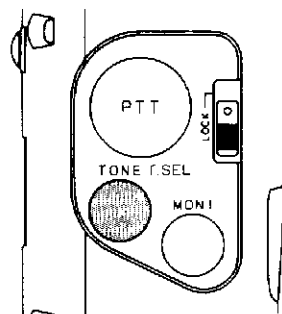

U.K and Europe version only

This diagram will help you locate the keys, switches, and knobs you'll need to perform necessary operations. Please study these controls carefully. By the time you reach the end of this manual, you will have had to use each of them many times.

ANTENNA CONNECTOR
 DC IN TERMINAL
 MICROPHONE JACK
 ON AIR INDICATOR
 SPEAKER HEADPHONE JACK

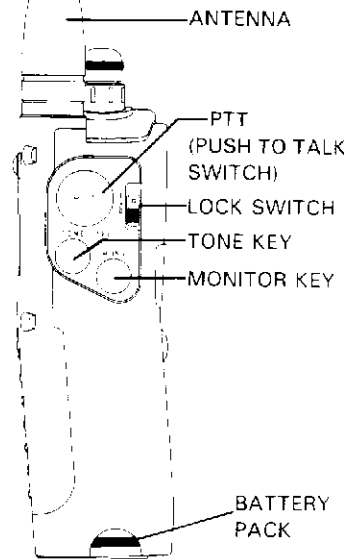
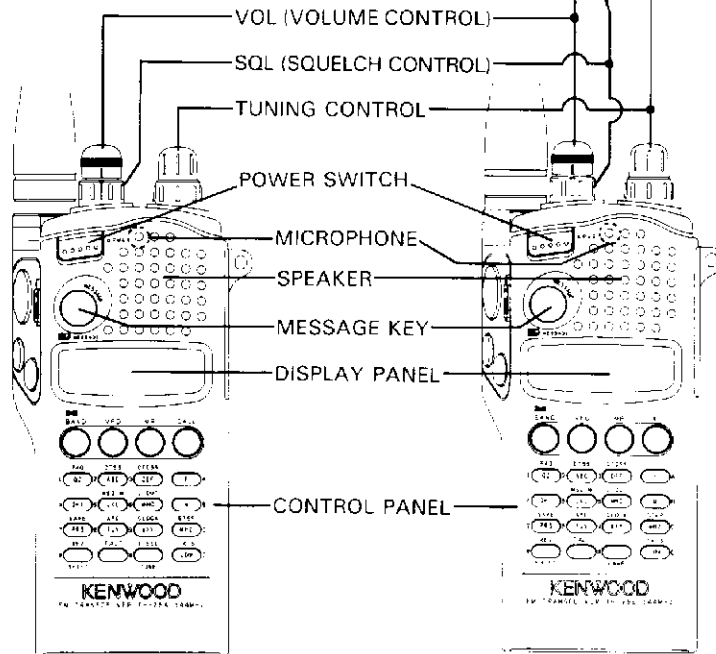
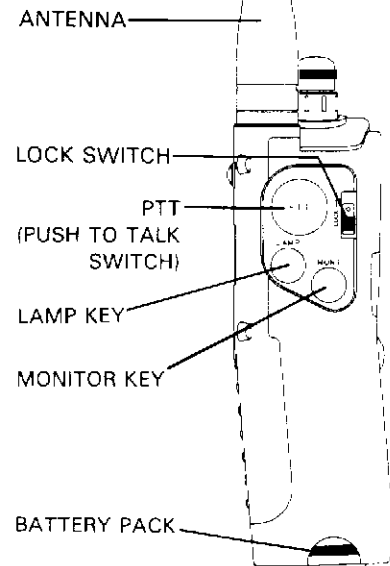

All types except U.K and European version

U.K and Europe version only

THE BATTERY PACK

1 NiCd Battery Pack (PB-13)

You must charge the battery before you can use it. It has not been charged at the factory in order to provide you with the greatest number of charge/discharge cycles. It takes several charge/discharge cycles before the battery pack will operate for its maximum period. If you store the battery pack for more than two months, recharge it before use.

2 Recharging

Insert the charge plug from the charger (BC-14) into the receptacle on the top of the transceiver. Then plug the charger into the AC line. Do not allow the battery to charge for greater than 15 hours. The useful life and battery performance will be reduced if you exceed the recommended charge period.

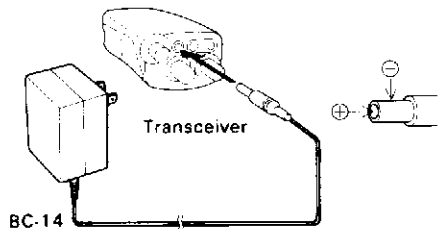

(Illustrations show the U.S.A. version.)

3 Installing The Battery Pack

Insert the battery pack into the transceiver until it locks in place.

To remove the battery pack slide the Release button to the right and pull the pack down.

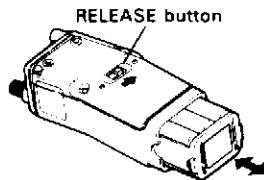

NOTE

Recharging should be done within an ambient temperature between 5°C ~ 40°C (41°F ~ 104°F). Recharging performed out of this range may not fully charge the battery.

4 Battery Voltage Level

The meter indicates the relative battery voltage during transmit.

Recharge or replace the batteries when the level reaches the low indicator.

NiCd Battery pack

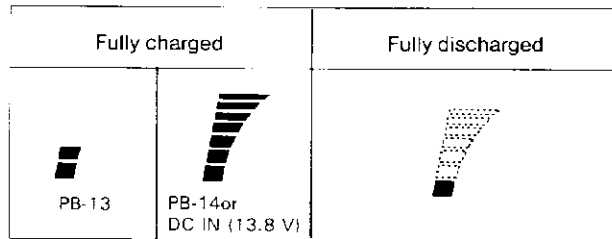

Approximate battery condition

Manganese or Alkaline Batteries

Load 6 × R6 (AA) manganese or alkaline batteries in series in the optional battery case(BT-8). Be sure to observe the polarities. We recommend use of high performance Alkaline batteries.

Manganese or Alkaline batteries

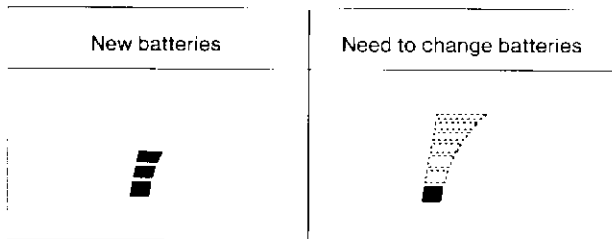

Approximate battery condition

5 Battery Operating Time (hours)

Models	Batteries	Transmitter output power			
		H	M	L	EL
TH-28A TH-28E	PB-13	5.5	5.5	8	17
	Alkaline	13	15	23	60
	Manganese	4	5	7	23
TH-48A TH-48E	PB-13	5	5	7.5	16
	Alkaline	12	14	19	59
	Manganese	4	5	7	21

- 6 seconds transmission, 6 seconds reception, 48 seconds reception with no signal recommended. AF output 0.2W/8 ohms.
- Battery saver function on.

CAUTION

The display indicator flashes and the POWER switch will not work when the battery starts to go flat. When this happens, recharge or replace the battery.

We recommend use of the NiCd battery pack for long transmission or extended operation. Manganese batteries (except Alkaline manganese batteries) may be used for Low or EL position.

RECEIVER OPERATION

1 Getting started

Connect the battery pack and the supplied antenna.

Press the POWER switch to turn the transceiver on. One of the default frequencies should appear on the display.

TH-28A/E

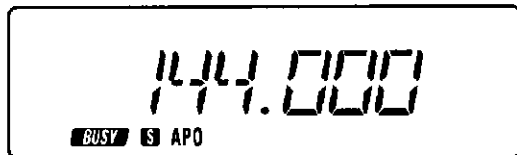

TH-48A/E



or



If the display shows incomplete data, or you think the displayed frequency is wrong, reset the micro-processor (see page 18 Initializing the Memory).

- 1 Rotate the VOL control clockwise until a signal or noise is heard coming from the speaker.
- 2 Rotate the tuning control to selected an open channel.
- 3 Rotate the SQL control clockwise until the noise just disappears and the BUSY indicator turns off. This point is known as the Squelch Threshold point.

Note

Most programming procedures mentioned in this manual allow a 10 second delay between steps.

If you wait too long to perform a step the transceiver will return to the normal frequency display. If this occurs you will have to begin the procedure again.

2 Selecting Frequency

You have several ways to select frequencies:

- By entering a specific frequency via the keyboard
- By using the tuning control
- By selecting a memory channel (see page 20)
- By pressing the CALL key

Direct Keyboard Frequency Entry

You can enter specific frequencies directly into the transceiver.

We will explain how to enter 145.050 MHz using the TH-28A/E as an example.

- 1 If the transceiver is in the Memory mode or CALL mode, press the VFO key to select the VFO mode.
- 2 Press the numeric 4 key. A 4 is entered as the 10MHz digit, and the 1MHz and below digits change to —.

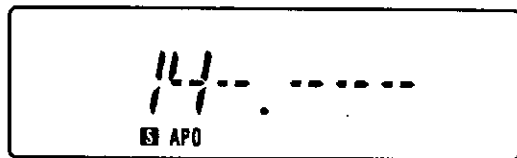

For the European version and some other markets, you must enter the 1MHz digit first. So, first press numeric key 5.

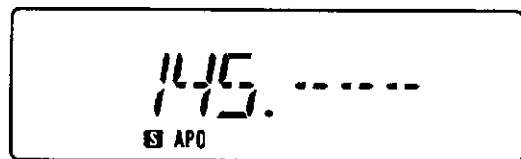

Next press numeric keys 0 and 5.

How Step Selection Works

The chart below illustrates the 1 kHz and 100 Hz digit frequencies that are automatically selected when you enter specific keys for the 10 kHz digit, when using the 12.5kHz or 25 kHz step size

10 kHz Key	Frequency(kHz)	10 kHz Key	Frequency(kHz)
0	00	5	50
1	12.5	6	62.5
2	25	7	75
3	37.5	8	87.5
4	37.5	9	87.5

- 3 Press numeric keys 5, 0, 5 and 0.

Notes

- 1 The transceiver changes frequency after the 1 kHz digits have been entered.
- 2 If the frequency step is 10 or 20 kHz, the 1kHz digit becomes zero automatically when you enter the 10kHz digit.
- 3 If you press an invalid key, the valid value nearest to that number is entered.
- 4 If you do not press a key within 10 seconds, the normal frequency display returns.
- 5 If you press the VFO key during input, the digits showing — return to the values that appeared before the direct entry mode was selected.

Using the Tuning Control

The tuning control selects frequencies in up or down sequential steps.

Rotate the tuning control clockwise or counterclockwise to select the desired operating frequency.

3 Step Size Selection

The transceiver must be in the VFO mode to select frequency steps.

To select the desired tuning or scan step size use the following procedure:

- 1 Press the F key momentarily, then press the MHz/STEP key. The current frequency step size will be displayed.



- 2 Rotate the Tuning control until the desired tuning step size appears in the display. The frequency step is indicated in the chart below.

5 → 10 → 15 → 20 → 12.5 → 25 → 5

Press a key other than the LAMP, MONI, or POWER key.

The displayed step size is set, and the normal frequency display returns.

Changes in the Displayed Frequency

As you change from one step size to another, the displayed frequency also changes, as illustrated in the accompanying charts.

For example, assume you are presently displaying 439.920 MHz at a 20kHz step size. If you were to change the step size to 12.5kHz, the display would read 439.925 MHz.

FROM step size 5, 10, 15, or 20	To step size 12.5 or 25
<i>Frequencies</i>	<i>Display as</i>
0, 5, 10, 15	0
20, 25, 30, 35	25
40, 45, 50, 55	50
60, 65, 70, 75, 80, 85, 90, 95	75

FROM step size 12.5 or 25	To step size 5, 10, 15, or 20
<i>Frequencies</i>	<i>Display as</i>
0	0
12.5	10
25	20
37.5	30
50	50
62.5	60
75	70
87.5	80

4 Programmable VFO Tuning Limits

This radio provides the capability of programming the VFO tuning range, in 1 MHz band segments, as well as providing a separate programmable band scan function. (See page 24)

For example you could tell the transceiver that you only wish to tune the 144.000 MHz and 145.000 MHz band segment by specifying any frequency within these two segments.

The Tuning controls would then only tune within these specific bands. The procedure for specifying the bands is described below.

- 1 Rotate the Tuning control until the desired lower tuning limit appears on the frequency display. For example you might want to select the 144 MHz band and dial up 144.100 MHz.
- 2 Press and hold the M key for longer than one second, then press the 7 key. This selects the lower frequency limit for the programmable VFO.
- 3 Rotate the Tuning control until the desired upper tuning limit appears in the frequency display. For example you might want to select the 145 MHz band and dial up 145.100 MHz.
- 4 Press and hold the M key for longer than one second, then press the 4 key. This selects the upper frequency limit for the programmable VFO.

- 5 To confirm that the programming was properly performed rotate the Tuning control. The transceiver should not go above or below the programmed band limits.

To clear both programmed limits simultaneously reset the VFO memory using the procedures discussed on page 18.

You can reprogram either limit independently by following the appropriate instructions above.

Note

This function is not available in the subband.

5 Subband Reception

Press the BAND key.

The subband frequency appears in the display.

You can select the desired subband frequency as described in Section 2 (selecting frequency: see page 11).

TRANSMITTER OPERATION

Before you attempt to transmit, attach an antenna with a low standing wave ratio to the antenna connector. Failure to provide a proper load may cause damage to the final amplifier section. Always check that the frequency is clear before transmitting.

1 To transmit, follow these steps:

- 1 Use any of the frequency selection methods on page 11 to select an operating frequency.
- 2 Check the frequency to see if it is occupied before you transmit.
- 3 Press the PTT switch. The ON AIR indicator and battery level meter will appear.



- 4 Speak into the microphone from the recommended distance of 5 cm (2 inches). Talking closer or farther away can result in loss of clarity, an excessively wide transmit signal, or weak audio.
- 5 Release the PTT switch to return to the receive mode. The ON AIR and battery level meter indicators should go out.

2 Changing Transmitter Output Power

Pressing the LOW key allows you to select 4 different transmitter output power levels. The actual transmitter output power for this unit depends on the power supply being used. Indicators will appear on the display to tell you which level you have selected.

The "E and L" indicators show the Economic Low power position. Use Economic Low power for line-of-sight short-distance communication.



The "L" indicators shows the Low power position. Use Low power for short-distance communication.



The "M" indicators shows the medium power position.

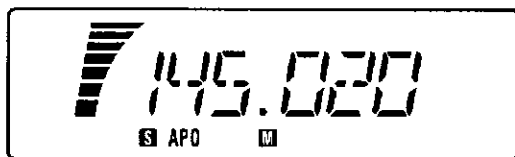

No indicator means the high power position has been selected. Use high power for maximum transmitter power.

3 TX. Stop Function 禁止发射

The TX STOP function allows you to temporarily disable the transceiver transmit, preventing accidental or unauthorized transmission.

Press the F key, then press the LOW/TX.S key to turn the TX STOP function on or off.



Output Power(watts)

	TH-28A/28E		TH-48A/48E		L	EL
	H	M	H	M		
PB-13	2.5	2.5	1.5	1.5	0.5	0.02
Manganese Battery	3.0	2.5	2.5	2.5	0.5	0.02
External Power Supply (13.8V DC)	5.0	2.5	5.0	2.5	0.5	0.02

4 Time-Out-Timer

This transceiver has a time-out-timer function to prevent possible problems caused by continuous transmission. This function forcibly stops continuous transmission after 10 minutes. When the timer times out, the transceiver beeps and automatically returns to the receive mode. Press the PTT switch to transmit again.

The time-out-timer function cannot be turned on or off.

USING THE MEMORY

1 Microprocessor Memory Backup 数据备份

All memory channel data, CALL channel data, DTSS codes, message memory, last channel memory data, and VFO data is backed up in EEPROM. It is not lost unless you reset the memory.

All other data that you set is retained by a secondary lithium battery, that will provide memory backup for about 20 days if you remove the battery pack or external DC power.

A fully discharged battery will require approximately 10 hours to reach full charge after installing a NiCd battery pack or external power.

2 Entering Memory Data 输入存储数据

Entering memory data is a simple operation requiring just a few keystrokes to store all the data you require.

Entering Normal Channels 输入频道

- 1 Use the numeric keypad to select the desired receive frequency, offset, and any other information you desire. If the desired frequency is already on the display, continue to step 2.

① 设置频率

- 2 Press the M key. The memory indicator will flash.

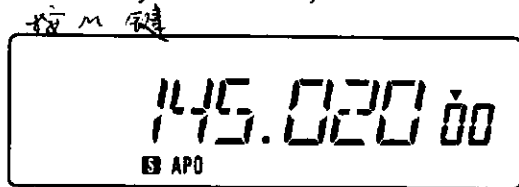

- 3 Use the keypad to select any desired memory channel number (00~39). Use a two-digit number, such as 02 for channel 2 or 15 for channel 15, to enter the data in memory. 输入 00~39 号码
- 4 Press the MR key. 按 MR 键
- 5 The memory channel number will turn off, indicating that the receiver data has been properly stored.

Clearing a Memory Channel 删除频道

Use the following procedure to clear the contents of an individual memory channel:

- 1 Select the memory channel to be cleared.
- 2 Press the M key for longer than one second, then press the MR key. 选择频道 按 M 键 1 秒以上, 按 MR 键.
- 3 The selected memory channel number is removed from the display and the data is cleared from the memory.

3 Initializing The Memory 初始化存储

Press and hold the M key and turn on the power to reset the memory. All the LCD indicators will appear on the display. Release the M key. This resets all user programmed data to the factory defaults.

按住M键打开电源，机器恢复出厂数据。
Factory Default Settings

	TH-28A	TH-28E	TH-48A	TH-48E
VFO Frequency	144 MHz	144 MHz	430/440 MHz	430 MHz
Call Channel Frequency	144 MHz	144 MHz	430/440 MHz	430 MHz
Frequency Step	5 kHz	12.5 kHz	25 kHz	25 kHz
Tone Frequency	88.5 Hz	1750 Hz	88.5 Hz	1750 Hz

VFO Reset

Press and hold the F key and turn on the POWER switch to reset the microprocessor's VFO memory, without destroying the memory channel, CLOCK data, message memory data, automatic dialer DTMF memory, Programmable SCAN tuning range, PAGING code, or CALL channel data.

4 Memory Channel

This transceiver provides 40(00~39 channel) memory channels. Addition of the optional ME-1(memory expansion unit) will provide from 40-239 additional memory channels.

Note

The number of additional ME-1 memory channels that are available depends upon whether they are used as split channels and if alpha numeric designators are used.

5 Memory Contents

Each memory channel can store information as shown in the chart below.

× = Can be stored in memory

	Normal Channel	Split Channel
RX frequency	×	×
TX frequency	N/A	×
Tone(CTCSS) frequency	×	×
Tone (CTCSS) status		
Frequency step	×	×
Shift status, REV on/off	×	N/A
DTSS code, DTSS status	×	×

6 Entering Split Channel Frequencies

- 1 Use the numeric keypad to select the desired receiver frequency, tone and other information. If the desired frequency is already on the display, continue to step 2.
- 2 Press the M key. The memory indicator will flash.
- 3 Use the keypad to select any desired memory channel number (00~39). For example, use a two digit number, such as 02 for channel 2, or 15 for channel 15, to enter data in memory.
- 4 Press the MR key.
- 5 The memory channel number will turn off, indicating that the receiver data has been properly stored.
- 6 Use the numeric keys to enter the desired transmit frequency.
- 7 Press the M key. The memory channel indicator will flash.
- 8 Press and hold the PTT switch and press the MR key.
- 9 The TX frequency is set. The system returns to its previous state.

Note

You will hear an error sound if you attempt to recall a memory when nothing is stored in that memory.

Confirming the Contents of the Split Channel

- 1 Press the MR key. The programmed receiver frequency appears on the display with "+" and "-" offset direction indicators showing that this channel has an odd split entered.

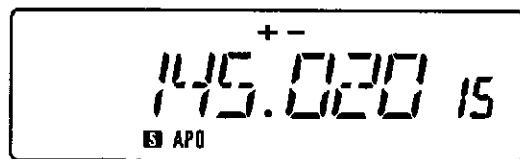

- 2 Press the F key, then press the REV key, or just the PTT switch, to check the transmit frequency. The transmit frequency will appear on the display.

7 Entering The Call Channel Frequency

- 1 Use the numeric keypad to select the desired receiver frequency, tone and other information.
- 2 Press the M key, then press the CALL key within 10 seconds. You have now entered the call channel frequency.

If entering an odd split channel, continue with steps 3 to 6.

- 3 Select the desired call channel transmit frequency.

- 4 Press the M key.
- 5 Press and hold the PTT switch and press the CALL key.
- 6 Release the PTT switch.

8 Recalling Memory Channels

Press the MR key.

You can change the memory channel by the following two methods.

Using the numeric keypad

Select any desired memory channel number (00~39). For example, use a two digit number, such as 02 for channel 2, or 15 for channel 15.

Selecting the three digit memory mode

If you install the optional ME-1, you cannot recall more than 100 memory channels in the two digits recall mode (initial states).

You must change the function to three digit recall mode.

- 1 Press and hold the F key for longer than one second then press the MR key.

2 digit mode (initial state)→3 digit mode →

1 digit mode→2 digit mode.....

- 2 Repeat as required until the desired mode has been selected.

Using the Tuning Control

Rotate the tuning control clockwise or counterclockwise to select the desired Memory Channel.

9 Memory Shift

Press the F key, then press the VFO key to copy the contents of a memory or call channel to the VFO without changing the data in memory. Doing this allows you to begin tuning at the point specified by the memory channel data.

Caution

You cannot perform memory shift if the displayed frequency exceeds the programmable VFO setting range (see page 14).

Note

Only the receive frequency data in the odd split memory channels is copy to the VFO.

10 MEMORY CHANNEL CHARACTER DISPLAY

You can display the memory channel frequency with your own spelling. It must be up to six characters long. You can use numerics 0 to 9, the letters A to Z and space.

If you select this mode, it will be changed to 20 (0~19) memory channels, and memory channels 20 to 39 are used for message memory. If memory frequency data for channels 20 to 39 is changed to message data.

If you installed the ME-1, frequency data for channels 40 to 139 automatically change to channels 20 to 119.

Function Setting

- 1 Press and hold the MR key and turn the POWER on.
- 2 Press the MR key to enter the memory channel mode.
- 3 Select a desired channel from among the memory channels in which you stored data using the Tuning control or numeric keypad.

- 4 Press the M key, then press the MHz key to enter the message setting mode.

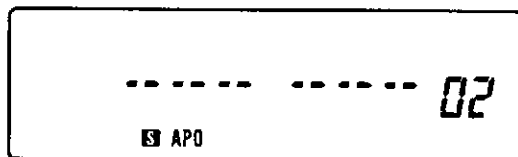

- 5 Enter your message with the keypad. See the list on page 43 for the key combinations for each letter.
- 6 If you enter the wrong message, press the VFO key to start over step 5.
- 7 Press the MR key at the end.
- 8 You can display a message from other memory channels by performing steps 2 to 6 again.

If a message is specified for a memory channel, the message is displayed instead of the frequency. If you want to check the frequency, press the F key, then the 5 key.

Message Display Cancel

- 1 Select the memory channel to be canceled.
- 2 Press and hold the M key for longer than one second, then press the MHz key.

The message display is canceled, and the frequency is displayed.

SCANNING

You must adjust the squelch to the threshold point for proper scan operation. You cannot use scan in conjunction with the tone alert function.

1 Hold/Resume Programming

This transceiver provides two types of scan hold/resume:

■ Time Operated Scan

The transceiver stops scanning on a busy channel, remains there for approximately 5 seconds, and then continues to scan even if the signal is still present.

■ Carrier Operated Scan

The transceiver stops scanning on a busy channel and remains there until the signal drops out. It allows a 2 second delay before resuming scanning to prevent losing the station when operators change.

The transceiver is delivered from the factory in the Time Operated Scan mode. Use the following procedure to switch between modes:

Hold/Resume Selection

Press and hold the 5 key and turn on the power.

Note

- 1 In CTCSS operation, scan will stop only on signals that contain the proper CTCSS code.
- 2 In DTSS operation, scan will stop (without squelch turned off) whenever it receives a signal. However, squelch will not open until the proper DTSS signal is received.
- 3 In combined CTCSS and DTSS modes, scanning stops when the proper CTCSS tone is received. Squelch will open only if the DTSS signal matches when the scan stops.

2 Scan Options

The following scan options are available:

■ Memory Scan

Scans through those memory channels that have data stored and that have not been locked out. This function operates only in the memory mode. (page 20)

■ Band Scan

Scan proceeds over the entire band. This function operates only in the VFO mode. (page 24)

■ Programmable Band Scan

The scan range for this mode is specified in memory. (page 24)

■ MHz Scan

Scans over a 1 MHz range. (page 26)

■ VFO / Memory Scan

Provides alternate scanning of the VFO and last used memory channel. (page 26)

■ CALL/VFO Scan

Provides alternate scanning of the call channel and the VFO. (page 26)

■ CALL / Memory Scan

Provides alternate scanning of the call channel and last used memory channel. (page 26)

■ V/M/C(VFO/Memory/CALL) Scan

Scans the VFO, the last memory channel used, and the call channel. (page 26)

■ You can reverse the direction of scan by turning the Tuning control.

3 Scanning Memory Channels

Note

The transceiver scans only those memory channels that have data entered and are not locked out. Scanning does not start unless two channels or more have data entered.

- 1 Adjust the SQL control to the threshold point.
- 2 Press the MR key.
- 3 Press and hold the MR key for longer than one second. The MHz indicator (decimal) flashes when the transceiver is scanning.
- 4 Press the PTT switch to stop scan.

4 Locking Out Memory Channels

This function allows you to specify which memory channels you want to skip during memory channel scan.

- 1 Select the appropriate numbers of the memory channels that you want to skip.



- 2 Press the F key, then the 6/L.OUT key.
A ★ indicator appears below the memory channel number on the display, indicating that channel will be skipped in the memory channel scan mode.

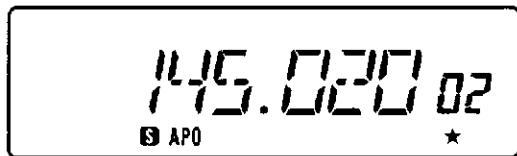

- 3 Repeat steps 1 and 2 to lockout any other channels you may want to skip.
- 4 To cancel the lockout, select the memory channel number. If it was locked out, it will have the ★ indicator on the display. Press the F key and then the 6/L.OUT key. The ★ will disappear.

5 Band Scanning

- 1 Adjust the SQL control to the threshold point.
- 2 Press the VFO key to select the VFO mode.
- 3 Press and hold the VFO key for longer than one second.

Scanning begins toward the higher frequencies. The MHz indicator (decimal) flashes when the transceiver is scanning.

- 4 Scanning pauses on a station strong enough to open the squelch and turn the BUSY indicator on.
- 5 Press the PTT switch to stop scan.

Note

If you set the Programmable Band Scan Tuning limit, set the VFO frequency to exceeding the limit, then perform step 3.

6 Programmable Band Scan

This transceiver has two Programmable Band Scan memories. You can set a scan frequency limit for each of the memories.

For example, you can store 144.500 to 145.000 MHz in programmable band scan memory 1, and 145.000 to 145.900 MHz in programmable band scan memory 2.

NOTE

When the lower frequency limit is not in the same band, or uses a different step size, or is a higher frequency than the upper limit frequency, Programmable Band scan is not initiated.

Use the following procedure to specify the desired scan limit.

Programmable band scan memory 1

- 1 Turn the Tuning control, and select the upper scan limit.
- 2 Press and hold the M key for longer than one second, then press the 5 key.
- 3 Turn the Tuning control, and select the lower scan limit.
- 4 Press and hold the M key for longer than one second, then press the 8 key.

Programmable band scan memory 2

- 1 Turn the Tuning control, and select the upper scan limit.
- 2 Press and hold the M key for longer than one second, then press the 6 key.
- 3 Turn the Tuning control, and select the lower scan limit.
- 4 Press and hold the M key for longer than one second, then press the 9 key.

Confirming Scan Limit

- Upper scan limit for programmable band scan memory 1

Press and hold the F key for longer than one second, then press the 5 key.

- Lower scan limit for programmable band scan memory 1

Press and hold the F key for longer than one second, then press the 8 key.

- Upper scan limit for programmable band scan memory 2

Press and hold the F key for longer than one second, then press the 6 key.

- Lower scan limit for programmable band scan memory 2

Press and hold the F key for longer than one second, then press the 9 key.

Initiating Programmable Band Scan

- 1 Adjust the SQL control to the threshold point.
- 2 Select a frequency between the two programmed scan limits.

- 3 Press and hold the VFO key for longer than one second.

The MHz indicator will flash when the transceiver is scanning.

Note

If the frequency in programmable band scan memory 1 overlaps the frequency in programmable band scan memory 2, the band stored in programmable band scan memory 1 is also scanned.

- 4 Press the PTT switch to stop scan.

7 MHz Scan

- 1 Adjust the SQL control to the threshold point.
- 2 Start the band scan or programmable band scan.
- 3 Press the MHz key during band scan or programmable band scan. Scanning begins in an upward sequence over a 1 MHz.

Example: If the MHz key is pressed when the frequency is 145.02 MHz for VHF band scan, just the 145 MHz band is scanned.

8 VFO/Memory Scan

- 1 Press the F key, then press the MR key.
- 2 The VFO frequency and the last used memory channel are scanned alternately.
- 3 Press the PTT switch to stop scan.

9 CALL/VFO Scan

- 1 Press and hold the CALL key for longer than one second in VFO mode.
- 2 The display frequency and CALL frequency are scanned alternately.

10 CALL / Memory Scan

- 1 Press and hold the CALL key for longer than one second in memory channel mode.
- 2 The memory channel in use and CALL frequency are scanned alternately.

11 V/M/C(VFO/Memory/CALL) Scan

- 1 Press the F key, then press the CALL key.
- 2 The VFO frequency, last used memory channel, and CALL frequency are scanned alternately.

REPEATER OPERATION

1 Transmitter Offsets

All amateur radio repeaters use a separate receive and transmit frequency. The receive frequency may be above or below the transmit frequency. Most repeater configurations fall into one of the following categories.

Offset Direction	TH-28A/E	TH-48A	TH-48E
+	+ 600 kHz	+ 5 MHz	+ 1.6 MHz
-	- 600 kHz	- 5 MHz	- 1.6 MHz
--			- 7.6 MHz

2 Selecting the Offset Direction

Press the SHIFT key. The transceiver will shift from one offset direction to the other, such as from + to -, or from - to simplex where no indicator shows. In the European version (UHF band), - change to --.

3 Automatic Offset Selection

■ U.S.A. and CANADA versions

The TH-28A is programmed according to the standard ARRL (Amateur Radio Relay League) Band Plan for repeater offset direction. You can override this programming by using the SHIFT key as described in the preceding paragraph.

■ European version

The TH-28E automatic offset is programmed as follows.

144.00 145.600 145.800

SIMPLEX - 600 kHz SIMPLEX

■ To cancel automatic offset

Press and hold the CALL key and switch the power on.

This operation switches automatic offset mode on or off.

4 Manual Offset Selection

The factory default sets the automatic offset frequency. You can select any offset frequency in the range 0 to 99.9 MHz in 100-kHz steps.

- 1 Press and hold the VFO key and switch the power on.
- 2 Press the F key for longer than one second, then press the 0 key.
The current offset frequency is shown on the LCD.
- 3 Rotate the Tuning control, and select the desired offset frequency.
- 4 Press any front panel key to return to the normal frequency display.

To return to the normal offset, reset the VFO.
(see page 18)

Note

Selecting an offset frequency that would result in the radio transmitting outside its intended range will cause an error tone to be sounded and transmit to be inhibited. Reselect a valid offset frequency if this occurs.

5 The Reverse Function

Some repeaters use a 'reverse pair', that is, the transmit/receive frequencies are the reverse of other repeaters.

For example, repeater A uses 146.000 as an input frequency, and 146.600 as an output frequency. Repeater B might use 146.600 as an input frequency, and 146.000 as an output frequency. It would be quite inconvenient to have to reprogram the transceiver each time you want to use these repeaters.

Press the F key, then press the SHIFT/REV key. The R indicator displays to remind you that you are working a reverse pair.

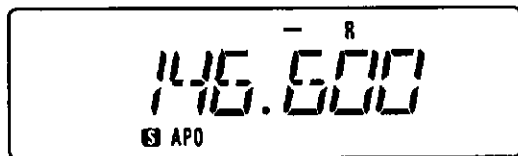

Press the F key, then press the SHIFT/REV key again to return to normal. The R indicator will disappear.

This function is also useful in checking the repeater input frequency, allowing you to determine if you are in range for simplex communication.

6 Tone Operation

Some repeaters require a control signal to activate them. Several different methods are currently in use.

In the United States, sub-audible tones are sometimes used. This transceiver will generate sub-audible frequencies.

In Europe and the United Kingdom, a 1750 Hz tone is used in transmitting. Simply press and hold the TONE key to transmit the access code. You need not press the PTT switch. A 1750 Hz tone encoder is included with models delivered to Europe and the United Kingdom.

Selecting Tone Frequencies

- 1 Press the F key, then press the TONE key. The current tone frequency will appear on the display.



- 2 Rotate the tuning control to select the desired tone frequency(Hz)

67.0	82.5	97.4	114.8	136.5	162.2	192.8	233.6
71.9	85.4	100.0	118.8	141.3	167.9	203.5	241.8
74.4	88.5	103.5	123.0	146.2	173.8	210.7	250.3
77.0	91.5	107.2	127.3	151.4	179.9	218.1	1750
79.7	94.8	110.9	131.8	156.7	186.2	225.7	

- 3 Press the TONE key again or simply wait 10 seconds for the transceiver to resume the previous mode.

Tone Function Operating

Press the TONE key. A "T" indicator appears on the display, and the transmitter sends the desired tone when you press the PTT switch.



7 Autopatch Operations

(U.S.A. versions only)

Some repeaters offer a service called autopatch. This feature allows you to dial a telephone number from your transceiver and carry on a telephone conversation.

This function requires the use of a DTMF (Dual Tone Multi Frequency) keypad. The transceiver also provides four additional keys - A, B, C, and D - in addition to the normal 12 keys found on your telephone.

These keys are required for various control operations by some repeater systems. A chart listing the various tone frequencies generated by the keypad is provided below.

Hz	1209	1336	1477	1633	key	Hz	key	Hz
697	1	2	3	A (F)	1	697	5	1209
770	4	5	6	B (M)	2	770	6	1336
852	7	8	9	C (MHz)	3	852	7	1473
941	*	0	#	D (LOW)	4	941	8	1633

To activate the keypad:

Press and hold the PTT switch

Dial the number just as you would on a normal telephone by pressing the appropriate keys.

Note

Some repeaters require a special key sequence to activate the autopatch function. Check with the control operator for this sequence.

You will hear and transmit a single tone if you press the VFO key before pressing one of the numeric keys (see the chart at left).

Selecting Delay Time

(Direct keyboard entry only)

It's easier to enter a long string of numbers if you don't have to hold down the PTT switch while you enter them. To instruct the transceiver to remain keyed for 2 seconds after pressing each number:

- 1 Turn the power off.
- 2 Press and hold the 3 key and turn on the power.

You are now able to enter numbers without pressing and holding the PTT switch.

Repeat 1 and 2 to cancel the delay time.

8 DTMF Memory

You can store 10 DTMF telephone numbers up to a maximum of 15 digits long in memory.

Storing DTMF Codes

- 1 Press the M key, then press the BAND key to select the DTMF code entry mode.

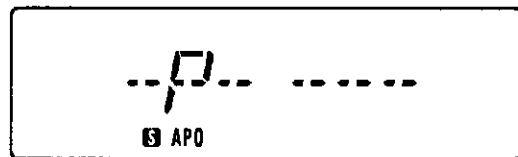

- 2 Enter the DTMF code on the keypad

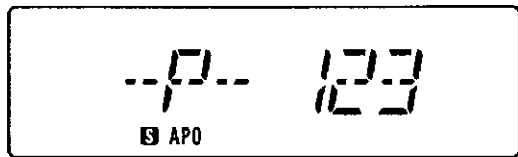

- 3 Press the MR key after entering the DTMF code.

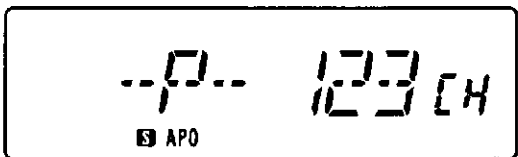

- 4 Select the channel (0~9) where you want to store the DTMF code and press the key for that channel. The DTMF code is stored and the previously displayed frequency reappears.
- 5 If you enter the wrong number, press the VFO key to start over from step 1.
- 6 To stop during entry, press the PTT switch. The previously displayed frequency appears on the display.

Recalling Stored DTMF Codes in Receive Mode

- 1 Press and hold the F key for longer than one second, then press the BAND key.
- 2 Press a number key (0~9). The corresponding stored DTMF code is displayed.

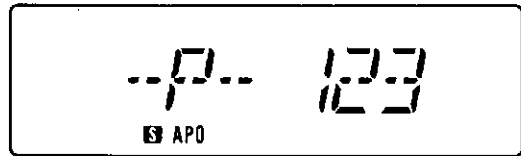

Making a DTMF Call

- 1 Hold the PTT switch down and press the BAND key.
- 2 Press the numeric key for the channel where the DTMF code is stored.
- 3 The DTMF code appears on the display.

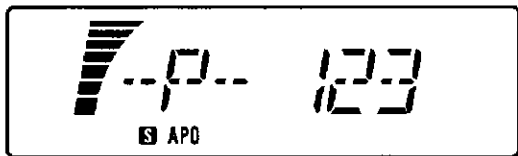

Note

Transmission continues until the whole code string is recalled, even if the PTT switch is released. You cannot stop DTMF code transmission once it is initiated.

CTCSS OPERATION

The CTCSS unit (TSU-7) is included only with models delivered to the United States and Canada. The CTCSS unit (TSU-7) installation instructions are shown on page 55.

If the Continuous Tone Code Squelch System (CTCSS) function is activated, the transceiver will not open squelch until it receives the proper PL tone (tone squelch).

The transceiver will now operate in the Tone Squelch mode. That is, squelch will not open until the selected tone is received as a portion of the incoming signal.

Selecting Tone Frequencies

You can select the desired tone frequency according to the procedure on page 29.

Operating the CTCSS Function

Press the F key, then press the 3 key. The CT indicator will appear on the display.



THE DUAL TONE SQUELCH SYSTEM (DTSS)

DTSS allows squelch activation in the receive mode when the transceiver receives a three-digit code matching the DTSS code you have selected.

Once squelch is activated, it operates normal from then on. If no signal is received for more than two seconds, squelch turns off until the transceiver receives a matching code.

Note

This function is not available in some market areas.

1 DTSS Code

You can select DTSS codes from 000 to 999 in the VFO mode. Store them either in memory channel or in the call channel.

Selecting DTSS Codes

- 1 Press and hold the F key for longer than one second, then press the 2 key.

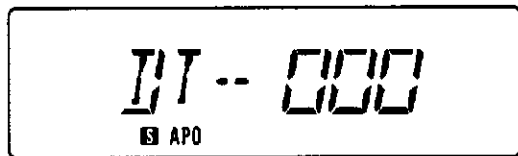

- 2 Enter a three-digit number on the keypad.

Note

Pressing a non-numeric key cancels code selection mode. Code selection cancels automatically if you make no entries within 10 seconds.

2 Using the DTSS Function

- 1 Adjust the squelch to the threshold point.
- 2 Press the F key, then press the 2 key. The DT indicator will appear on the display.



- 3 Squelch opens when you receive the proper code.

- 4 To transmit, press the PTT switch. The displayed code is sent for about 0.5 second.

Note

Voice output is muted during code output. We recommend that you turn off the battery saver function when you use DTSS.

- 5 Press the F key, then press the 2 key to cancel the DTSS function.

Note

Although you can select the CTCSS function simultaneously in the band, an incoming DTSS code may be lost at certain timings.

3 Using DTSS with a Repeater

Pressing the PTT switch transmits the DTSS signal after a short delay. The delay helps avoid any malfunction that might be caused when the repeaters switching times interrupt the DTSS signal.

The normal delay time is fixed to 250 milliseconds. When using shift or split channel operation, the delay time is 450 milliseconds.

You can change the delay time to 250 milliseconds.

To Change Delay Time

- 1 Turn the power off.
- 2 Press and hold the 2 key.
- 3 Turn the power on.
- 4 Release the 2 key.

PAGING

Paging uses a DTMF (Dual Tone Multi Frequency) signal and is useful in calling members of a group, a specific station, or for waiting for a call from another station.

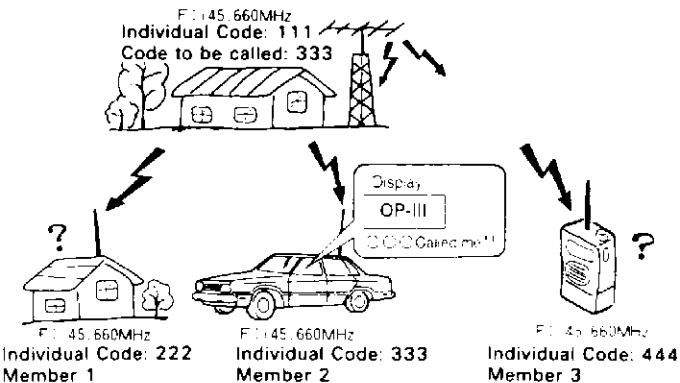

You should determine the common group paging code and individual codes in advance. You can enter three-digit codes from 000 to 999.

Unlike DTSS, the calling station code displays on the transceiver so the receiving party can identify the calling station. If called with an individual code, the individual caller code displays. When called with a group code, the group code displays.

1 Paging Operation Overview

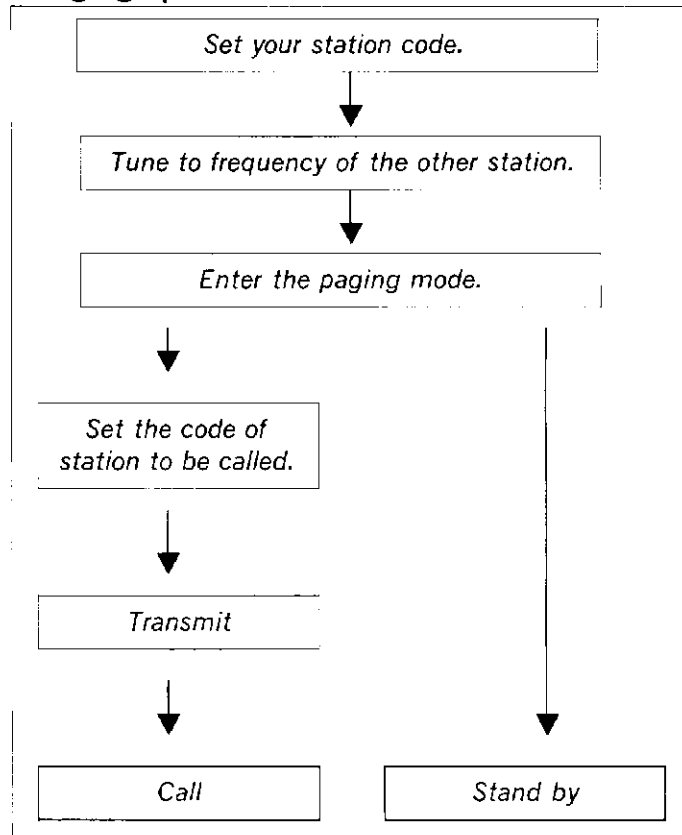

2 Paging Code Memory

There are 11 paging code memories.

Memory Code	Use
A	Stores your station ID code in memory.
0	Automatically stores the calling station's code during reception. Can temporarily set the code for the station to be called.
1~9	Stores group codes and local station codes in memory.

3 Setting Paging Codes

First, you must program your Individual Code into Memory A.

- 1 Press the F key then press the 1 key.

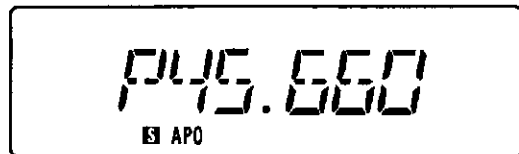

- 2 Press and hold the F key for longer than one second, then press the 1 key to enter the code setting mode.

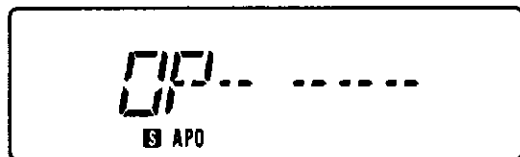

- 3 Rotate the tuning control to select A (your individual code channel).

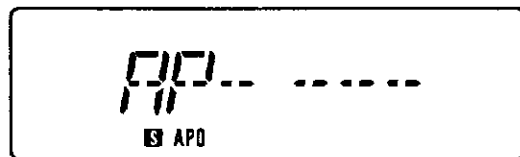

- 4 Enter your individual code (000 to 999) using the numeric keys.

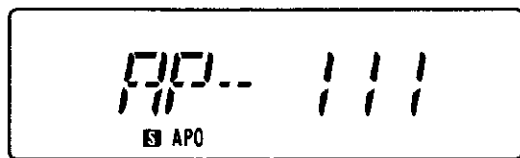

- 5 Your station ID is set in memory A.
- 6 Select 1 to 9 with the tuning control.
- 7 Enter the next Paging Code Memory you wish to program as described in step 4.
- 8 Press the M key to exit the code setting mode.

The chart shows how members of a group might communicate with each other. You may wish to refer back to this chart as you read the examples on the following pages.

Note

Your station ID code is preset in memory A. You can set up memory channel codes in any order you wish.

Group Communication Network Example

Predetermined frequency		145.660MHz
Your Individual code		111
Member 1	Individual code	222
Member 2	Individual code	333
Member 3	Individual code	444
Group code		789

Your memory

A 111
0
1 222
2 333
3 444
4
5 789

Member 1

A 222
2 789

Member 2

A 333
3 789

Member 3

A 444
4 789

4 Sending Pages (Calling)

- 1 Turn to the predetermined frequency.
- 2 Press the F key then press the 1 key to enter the Paging mode. The Paging function of the other transceiver must also be on.
- 3 Press and hold the F key for longer than one second, then press the 1 key to enter the code setting mode.
- 4 Use the tuning control to select the memory channel where the local station code is stored

Calling All Group Members

Select the group code memory channel to call all members of a group. In the example below, the group code is stored in channel 5.

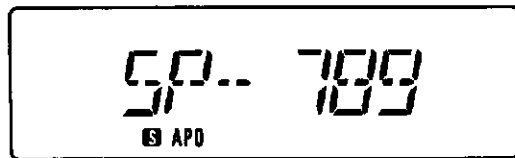

Press the PTT switch. Communication is possible in both the Paging and code setting mode.

In the code setting mode

In the Paging mode

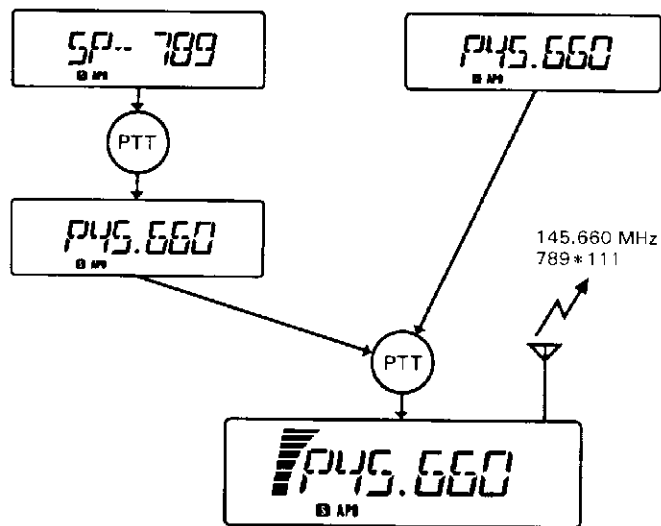

The group code 789 and your station ID code 111 are transmitted.

Calling a Specific Group Member

Use the following procedure to call a specific group member:

- 1 Select the local station code memory. In this example, we have selected memory 3.
- 2 If the local station code is not in memory, enter it in memory 0.
- 3 Press the PTT switch.
- 4 You can cancel Paging once you have established contact.

In the code setting mode

In the Paging mode

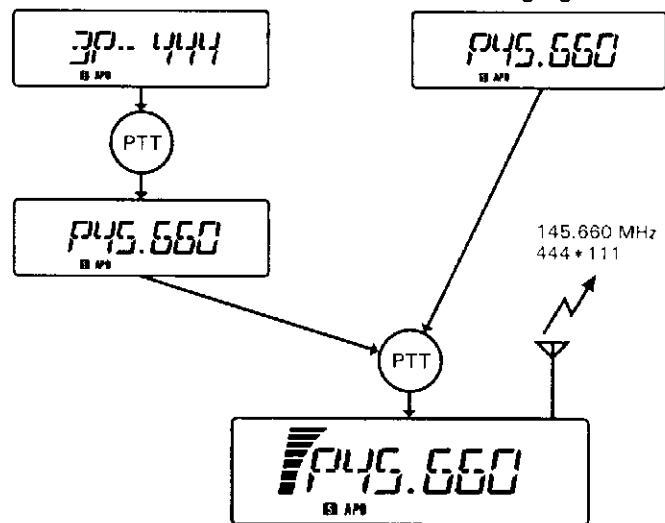

Local station code 444 and your station ID code 111 are transmitted. The DTMF sounds as the codes are transmitted.

5 Receiving Pages (Wait)

- 1 Tune to the predetermined frequency.
- 2 Press the F key then press the 1 key to enter the Paging mode.

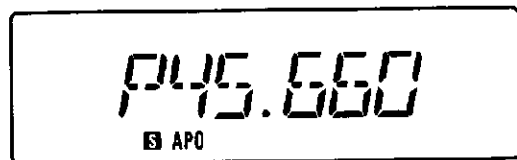

Receiving a Page with an Individual Code

- 1 When the proper code is received, your squelch will open and you will hear an alert tone sequence coming from the speaker.
- 2 If the calling station transmits your individual call the display will show Paging Mode Memory Channel 0, and will display the ID code of the calling station. Our example uses a station calling code of 444.

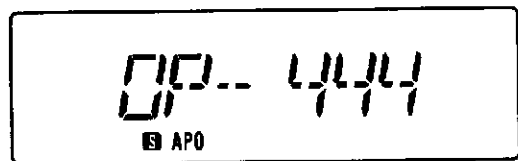

- 3 Press the PTT switch to respond to the calling party.

Receiving a Page with a Group code

- 1 If the calling station transmits the group code, the group code will display. The Paging Mode Memory Channel on your display becomes a number other than 0 (in this case a 5) to indicate a group call.

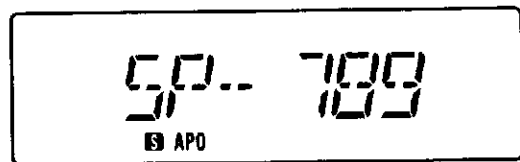

- 2 When the proper code is received, your squelch will open and you will hear an alert tone sequence coming from the speaker.
- 3 Press the PTT switch to respond to the calling party. (see page 39)

Note

An E indicator appears on the display if the local station code cannot be recognized.

Note

You can communicate more efficiently if you cancel Paging after contacting the local station.

6 Canceling Signal Squelch

Squelch will not open when operating in the paging mode when the paging codes do not match. It is possible to reprogram the transceiver so that squelch will open regardless of the incoming paging code.

Even when signal squelch is canceled, a beep sounds and the individual code of the local station is displayed when the proper code is received.

Canceling signal type squelch

- 1 Press and hold the F key for longer than one second, then press the 3 key.
- 2 To return signal squelch to the original state, repeat steps 1.

7 Locking Out Codes

You can lock a Paging function code only during reception. The Paging code will be transmitted even if it's locked out. The squelch unlocks if an individual code is stored in memories A and 1 through 9 and the codes match.

This remains true even if one local station communicates with another and the code is not locked out. Locking out codes is desirable when you call another group member, but don't want to receive communications between other individuals in the group.

To Lock Out Codes

- 1 Enter the code setting mode (page 38) and use the tuning control to display the memory channel number to be locked out.
- 2 Press the F key, then press the 1 key. The ★ indicator displays and memory locks out.

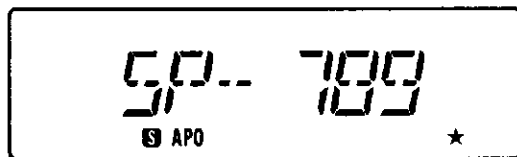

- 3 To cancel, repeat step 1 and 2.

MESSAGE TRANSMISSION AND RECEPTION

This function lets you transmit your message to the other party or display a message from the other party on your transceiver using the DTMF (Dual Tone Multi Frequency) signal and alphanumeric display.

You can use the numerics 0 to 9, letters A to Z and space.

The message that can be transmitted and received at one time can be up to six characters long.

Note

This function is used with DTSS or paging.

1 Message Transmission Modes

You can transmit your message by one of the following two methods.

- Transmit your message directly using the DTMF keypad. You must press the # key at the beginning and end of the character.

See the list on the next page for combinations of keys for alphabets.

- Store your message in the message memory, and transmit it.

2 Using the Message Memory.

This transceiver has 10 message memory channels.

Memory write procedure

- 1 Press the M key, then press the MESSAGE key to enter the message setting mode.

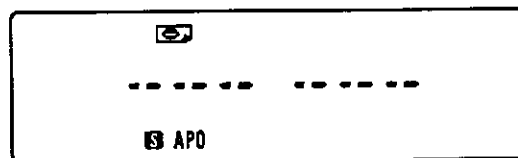

2. Enter your message with the DTMF keypad. See the list on the next page for the key combinations for each letter.
- 3 If you enter the wrong message, press the VFO key to start over step 2.
- 4 Press the MR key at the end. The MSG display begins flashing.

Relationship between input characters and keys

Input characters	Key operation
0	0
1	1
2	2
3	3
4	4
5	5
6	6
7	7
8	8
9	9

Input characters	Key operation
Q	1+A (F)
A	2+A (F)
D	3+A (F)
G	4+A (F)
J	5+A (F)
M	6+A (F)
P	7+A (F)
T	8+A (F)
W	9+A (F)

Input characters	Key operation
Z	1+B (M)
B	2+B (M)
E	3+B (M)
H	4+B (M)
K	5+B (M)
N	6+B (M)
R	7+B (M)
U	8+B (M)
X	9+B (M)

Input characters	Key operation
(Space)	1+C (MHz)
C	2+C (MHz)
F	3+C (MHz)
I	4+C (MHz)
L	5+C (MHz)
O	6+C (MHz)
S	7+C (MHz)
V	8+C (MHz)
Y	9+C (MHz)

For example

C A L L M E

2+C 2+A 5+C 5+C 6+A 3+B

Note

Characters other than 0-9 require you to press two keys. First press the number key listed in the chart, then press the key after the "+" symbol.

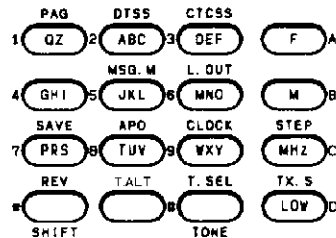

- 5 Press a key (0 to 9) corresponding to the numeric you want to enter to memory.
- 6 To cancel message input mode, press the PTT switch.

3 Message Memory Check

- 1 Press and hold the F key for longer than one second, then press the MESSAGE key.
- 2 Press a desired key (0 to 9).
- 3 To return to the normal frequency display, press any key except 0 to 9 key.

4 Message Memory Transmission

- 1 Press the PTT switch, then press the MESSAGE key. The MSG indicator will appear on the display.
- 2 Hold down the PTT switch, and press a desired key (0 to 9).

Note

Message transmission continues even if you release the PTT switch during transmission.

- 3 You can perform steps 1 and 2 any number of times during transmission. Therefore, if you use 10 message memory channels, you can transmit a text of up to 60 characters.

5 Message Reception

- 1 When the DTSS or Paging function is on, press the F key, then the MESSAGE key.
- 2 The MSG display lights, and you can now receive a message.

When a message is received, it is displayed, and the MSG indicator flashes.

■ DTSS mode

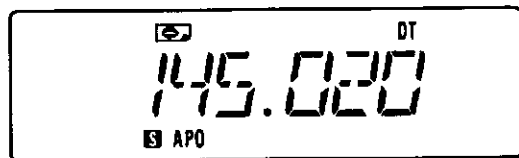

Press the MSG key



■ Paging mode



Press the MESSAGE(*) key

Press the PTT switch

↓ ↓
00-- 444 P45.550

↓
Press the MESSAGE(*) key

↓
P45.550

6 Receive Message Memory

This transceiver has 10 incoming message memory channels, in which received messages are stored.

If you press the MESSAGE key in the message mode, the last stored message is displayed.

If there is data in all 10 message memory channels, new data is written into channel 0.

Receive message memory clear

Press and hold the M key for longer than one second, then press the MESSAGE key.

Note

This operation does not clear the transmit message memory that you set.

ENHANCED RECEIVER FUNCTION

1 The Tone Alert System

The Tone Alert function provides an audible alarm to indicate when someone is transmitting on the frequency you are monitoring.

If you set the T.ALT function you will not hear voice communications. When used in conjunction with the CTCSS function, this allows the transceiver to operate similar to a private paging system.

The Automatic Power Off function is disabled during T.ALT operations.

- 1 Adjust the squelch control to respective threshold.
- 2 Select the proper tone frequency and be sure the CT indicator is displayed if you will be using the CTCSS function.
- 3 Press the F key, then press the 0 key. The T.ALT indicator will appear on the display.



- 4 The T.ALT and BUSY indicators display and the transceiver beeps on and off for approximately 5 seconds when a signal is present.
- 5 The time when the signal was received will be displayed. The time is changed each time a new signal is received.
- 6 Press the PTT switch to release the T.ALT function.
- 7 Press the F key, then press the 0 key again to completely release the T.ALT function.

Note

For the T.ALT to function properly in CTCSS, the incoming signal must be present for approximately 1 second. If you use the DTSS or Paging function in combination with the Tone Alert function, Tone Alert is activated only when the proper code is received.

Selecting a Beep Sound

Press and hold the TONE key (U.K. and Europe versions: LAMP key) and turn on the POWER switch to alternate the beep sound between a tone alarm and telephone type ring.

2 Monitor

Even if the squelch or CTSS, DTSS, or PAGING is ON, you can monitor the channel by pressing the MONI key.

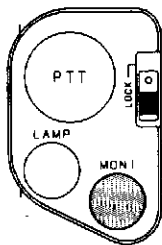

3 Beep Off

The transceiver produces beeps when you push the front panel keys. If you want to disable this function, press and hold the 8 key and press the POWER switch.

4 Lamp

If you press the LAMP key, the LCD illumination lamp lights to help you operate your transceiver at night. You can use this lamp at any time.

- 1 Press the F key, then press the LAMP key.
- 2 To cancel, press the LAMP key.

5 Key Lock

Slide the LOCK key to LOCK position.

The LOCK indicator will appear on the display, and all keys except LAMP, MONI, and PTT, are locked.

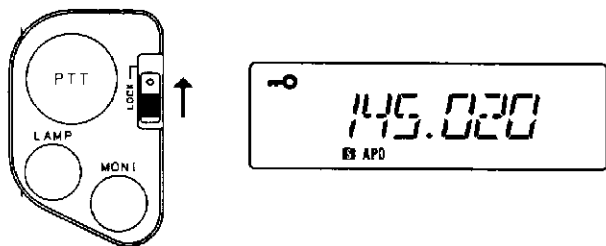

6 Channelized Frequency Display

The frequency display can be changed to display channel numbers instead of the operating frequency. This function makes use of the data you have stored in memory for this function. Channel 1 is memory channel 1, Channel 2 is memory channel 2, etc.

- 1 Turn the POWER switch off.
- 2 Press and hold down the 1 key, then press the POWER switch.
- 3 The channel number can be changed with the tuning control.
- 4 To return to the normal frequency display, perform steps 1 and 2 again.

POWER SAVER FEATURES

1 The Battery Saver Mode

This transceiver provides a battery saver mode to conserve on battery power. The battery saver circuit activates 10 seconds after the last key is pressed. The squelch must be closed. This function deactivates whenever a key is pressed or the squelch opens.

The battery saver does not operate during scanning or T.ALT operations.

Press the F key, then press the 7 key to activate or deactivate the battery saver function.

Battery Save Rate Selection

You can change the on/off rate when the battery save function is in effect.

- 1 Press and hold the F key for longer than one second, then press the 7 key.
- 2 Select the rate with the Tuning control.(1:1~1:16)
- 3 Press any front panel key.

2 Automatic Power Off (APO)

- 1 If no signal is received and if you have not performed any operations within 59 minutes, a 5 second audio tone sounds.
- 2 The transceiver switches the power off 1 minute after this tone sounds.

Note

Even though the APO indicator appears on the display, it will not activate during scanning or Tone Alert functions.

- 3 Press the F key, then press the 8 key to turn off the APO function.

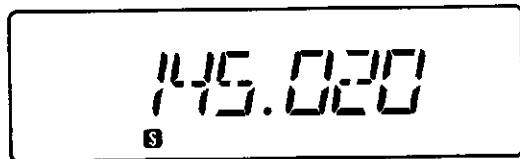

CLOCK FUNCTION

If you press the F key, then the 9 key in receive mode, the clock is displayed. The time is displayed on a 24-hour basis. If you press the F key, then the 9 key again, the clock is canceled, and the normal frequency display returns.

1 Time Setting

- 1 Press the F key, then the 1 key, in clock display mode.
- 2 Set the "Hour" display to the current hour with the Tuning control.
- 3 Press the M key.
- 4 Set the "Minute" display to the current minute with the Tuning control.
- 5 Press the M key.

Time Alarm Setting

In clock display mode, press the F key then the 2 key, the "second" display is cleared, and counting begins from 0 seconds.

2 Timer Function

Switch-on Timer Setting

- 1 If you press the F key, then the 4 key, in clock display mode, you enter the switch-ON timer setting mode, and the TIMER.ON indicator and the "Hour" display will flash.

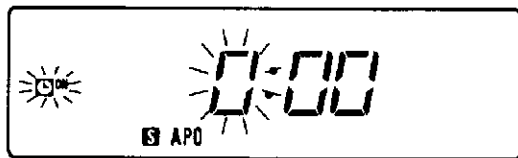

- 2 Set the "Hour" display to the time you want the transceiver to turn on with the Tuning control.
- 3 Press the M key.
- 4 Set the "Minute" display to the time you want the transceiver to turn on with the Tuning control.
- 5 Press the M key.

Switch-off Timer Setting

- 1 If you press the F key, then the 7 key, in clock display mode, you enter the switch-off timer setting mode, and the **TIMER.OFF** indicator and the "Hour" display will flash.



- 2 Set the "Hour" display to the time you want the transceiver to turn off with the Tuning control.
- 3 Press the M key.
- 4 Set the "Minute" display to the time you want the transceiver to turn off with the Tuning control.
- 5 Press the M key.

Timer Start/Stop

If you press the F key, then the 5 key, in clock display mode, the switch-on timer starts or stops.

When the switch-on timer starts, the **TIMER.ON** indicator lights on the LCD, and the transceiver is switched on at the set time every day.

If you press the F key, then the 8 key, in clock display mode, the switch-off timer starts or stops.

When the switch-off timer starts, the **TIMER.OFF** indicator lights on the LCD, and the transceiver is switched off at the set time every day.

Alarm Function

In clock display mode and switch-on timer ON, press the F key then the 6 key, the alarm function turns on, and an alarm sounds for 7 minutes when the switch-on timer set time is reached.

The alarm stops when you press any front panel key.

CROSS BAND OPERATION

The sub band must be activated for Cross Band operation.

- 1 Press the BAND key and select the sub band.
- 2 Set the receive frequency using the Tuning control or keypad keys 0 to 9. (Example: when the receive frequency is 438.100 MHz for the TH-28A/E)

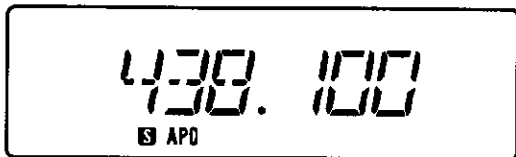

- 3 Press the BAND key.
- 4 Set the transmit frequency using the Tuning control or keypad keys 0 to 9. (Example: when the transmit frequency is 145.660 MHz for the TH-28A/E)



- 5 Press the F key, then the BAND key.
The Cross Band indicator lights on the LCD, and the receive frequency is displayed. In this example, 438.100 is displayed.



You can change this receive frequency with the Tuning control.

- 6 Pressing the PTT allows you to transmit on VHF band.

Perform Cross band Operation With Memory Channel

- 1 You must set the sub band frequency for the memory receive frequency, and the main band frequency for the transmit frequency.
- 2 Select the desired memory channel.

MAINTENANCE

1 General Information

Your transceiver has been factory aligned and tested to specification before shipment. Under normal circumstances the transceiver will operate in accordance with these instruction manuals.

All adjustable trimmers and coils in your transceiver has been adjusted at the factory and should only be readjusted by a qualified technician with proper test equipment. Attempting service or alignment without factory authorization can void the transceiver's warranty.

When operated properly, the transceiver will provide many years of service without requiring realignment. The information in this section gives some general service procedures which can be accomplished without sophisticated test equipment.

2 Service

If it ever becomes necessary to return the transceiver to your dealer or service center for repair:

- Pack the equipment in its original box and packing. Do not pack it in crushed news papers. Extensive damage could result during shipment.

- Include a full description of any problems. Include your telephone number.

You need not return accessory items unless they are directly related to the service problem.

Service note

If corresponding on a technical or operational problem, please make your note short, complete, to the point, and legible. Give sufficient detail for diagnosis of the problem. For example, list the test equipment you have available to you, any meter readings you might have taken, and any other information you feel might be useful.

3 Record Keeping

- Record the date of purchase, the unit serial number, and the name of the dealer from whom you purchased the unit.
- Retain a written record of any service or maintenance performed on the unit.

Photocopy the bill of sale or other proof of purchase showing the sale date. This information must be included with the transceiver when claiming warranty service.

TROUBLESHOOTING

The following problems are generally caused by improper transceiver operation or connection, not by defective components.

If you experience any of these problem causes and corrective actions before requesting service.

<i>Symptom</i>	<i>Probable Cause</i>	<i>Corrective Action</i>
Indicators do not light and no receiver noise is heard when the POWER switch is turned on.	<ol style="list-style-type: none">1. Low voltage.2. With optional DC cable:<ol style="list-style-type: none">1) Bad power cable or connections.2) Blown power supply fuse.	<ol style="list-style-type: none">1. Recharge/ replace the battery.2.<ol style="list-style-type: none">1) Check cables and connections.2) Check for the cause of the blown fuse and replace the fuse.
No sound from the speaker. No signal can be received.	<ol style="list-style-type: none">1. Squelch is closed.2. With the TSU-7: CTCSS is operating.3. DTSS is operating.4. Paging is operating.	<ol style="list-style-type: none">1. Turn the SQL control counterclockwise.2. Press the F key, then press the 3 key to turn off the CTCSS.3. Press the F key, then press the 2 key to turn off the CTCSS.4. Press the F key, then press the 1 key to turn off the Paging.
No control works.	<ol style="list-style-type: none">1. LOCK is ON.2. T.ALT is ON.	<ol style="list-style-type: none">1. Slide the LOCK key to OFF position.2. Press the F key then the O/T.ALT
Memory channel cannot be recalled.	Nothing is stored in the memory channel.	See Using the Memory (page 17)
Memory cannot be backed up.	<ol style="list-style-type: none">1. Battery voltage is low.2. Battery case removed.	<ol style="list-style-type: none">1. Recharge the battery.2. Install the Battery case.

ACCESSORIES

SPEAKER
MICROPHONE
SMC-31
SMC-32
SMC-34

HEADSET with
VOX/PTT
HMC-2



CTCSS UNIT
TSU-7



BATTERY CASE
AA x 6
BT-8



NiCd BATTERY PACK
7.2V 700mAh
PB-13



MEMORY EXPANSION UNIT
ME-1

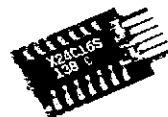

CLIP MICROPHONE
with EAR PHONE
EMC-1



REMOTE CONTROL
SPEAKER MICROPHONE
SMC-33



NiCd BATTERY PACK
12.0V 300mA
PB-14



WALL CHARGER
BC-14



RAPID CHARGER
Recharging Approx. 1 hour
BC-15



WATER
RESISTANT BAG
WR-2

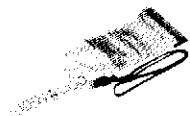

SOFTCASE
SC-33
for PB-13
BT-8



SOFT CASE
SC-34
for PB-14



SWIVEL MOUNT
BH-6



FILTERED CIGARETTE
LIGHTER CODE
PG-3F



PLUG CODE
PG-2W



NOTE: Some optional accessories may not be available in your area.

1 Installing the CTCSS Unit (TSU-7)

- 1 Slide the release button to unlock, then pull out the battery case.
- 2 Unscrew the four screws on the rear (Fig. 1).
- 3 Put your finger into the battery holder, and release the claw of the rear case. (Fig. 2)
- 4 Position the set with its front facing forward.
- 5 Open the front panel from the PTT switch side, being careful of the internal wiring.(Fig. 3)

- 6 Attach the TSU-7 to the transceiver, as shown in fig.4.
- 7 Replace the case in its original position, taking care not to pinch any wires or cables under the case.
- 8 Install the four screws.

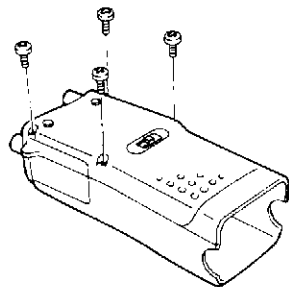

Fig. 1

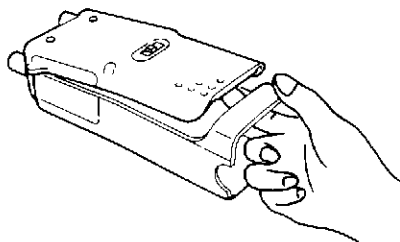

Fig. 2

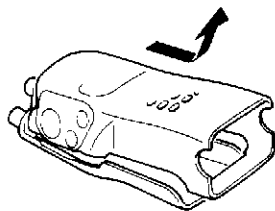

Fig. 3

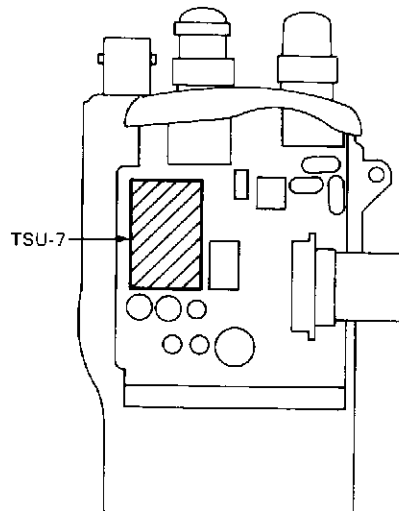

Fig. 4

2 Memory Expansion Unit (ME-1)

- 1 Slide the release button to unlock, then pull out the battery case.
- 2 Unscrew the four screws on the rear (Fig. 1).
- 3 Put your finger into the battery holder, and release the claw of the rear case. (Fig. 2)
- 4 Position the set with its front facing forward.
- 5 Open the front panel from the PTT switch side, being careful of the internal wiring. (Fig. 3)
- 6 Attach the ME-1 to the transceiver, as shown in fig.4.
- 7 Replace the case in its original position, taking care not to pinch any wires or cables under the case.
- 8 Install the four screws.
- 9 Reset the VFO. (See page 18)

Selecting the Three Digit memory Mode

- 1 Press and hold the F key for longer than one second, then press the MR key.
2 digit mode (initial state) → 3 digit mode → 1 digit mode → 2 digit mode
- 2 Repeat as required until the desired mode has been selected.

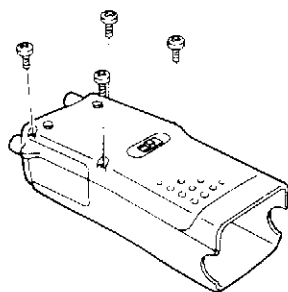

Fig. 1

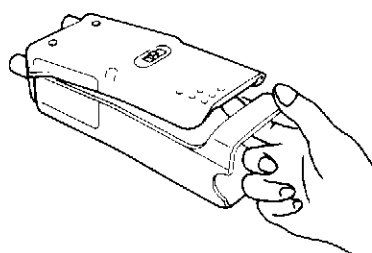

Fig. 2

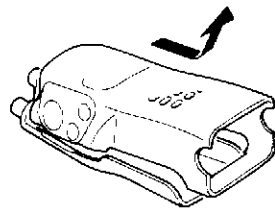

Fig. 3

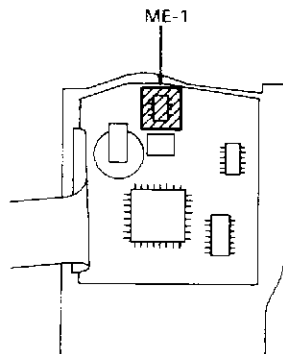
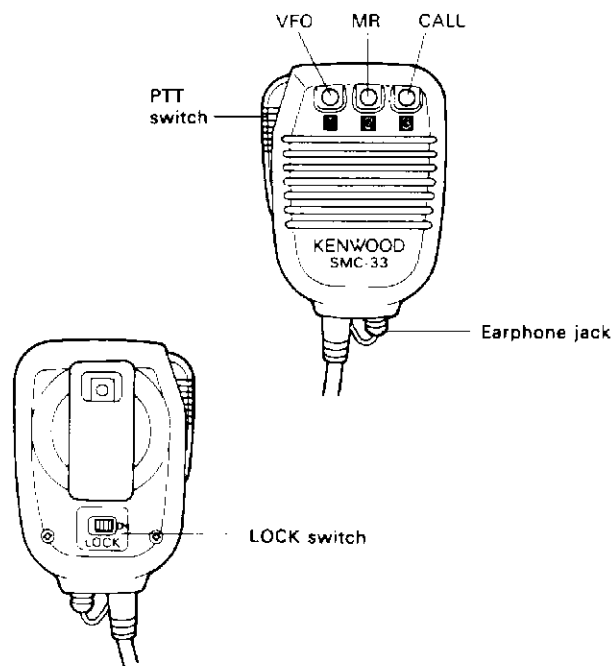

Fig. 4

3 Programming SMC-33 the Remote Control Speaker Microphone



These keys function just like the VFO, MR, and CALL keys on the front panel of the transceiver. To reset the function of the transceiver keys.

- 1 Connect the SMC-33 to the MIC jack on top of the transceiver.
- 2 Press and hold Microphone key 1 (or 2 or 3) and turn the power on. The programmable function (PF) indicator appears for 10 seconds.



- 3 Press a key on the transceiver - or press F and a key - to assign that key's function to key 1 (or 2 or 3) on the SMC-33. The possible functions for the SMC-33 keys 1, 2, and 3 are listed on the next page.

For example, press the BAND key on the transceiver to make key 1 on the SMC-33 function as the BAND key. Press the F key, then the CALL key to make key 1 function as the VFO/MEMORY/CALL scan key.

Turn the LOCK switch on to disable microphone keys 1, 2, and 3.

You can use the SMC-33 with models that have no remote function for simple transmit and receive functions. No remote functions will be possible. Make sure the LOCK switch on the back of the microphone is on before using it with such models.

Memory Control Functions

<i>Press the key below.</i>	<i>Press the F key , then the key below.</i>
Tuning control ※1	—
LAMP (Turns off 5 seconds after the last key operation)	LAMP (Does not turn off automatically)
MONI	—
TONE	Tone Frequency Selection
MESSAGE	Message Selection
BAND	Duplex Operation
VFO	Memory Shift
MR	V/M Scan
CALL	V/M/C Scan

※1. Clockwise rotation sets the UP function, counterclockwise rotation sets the DOWN function.

<i>Press the key below.</i>	<i>Press the F key , then the key below.</i>
1: Memory channel recall 01	Paging
2: Memory channel recall 02	DTSS
3: Memory channel recall 03	CTCSS
4: Memory channel recall 04	—
5: Memory channel recall 05	Memory Channel Message
6: Memory channel recall 06	Memory Channel Lock Out
7: Memory channel recall 07	Battery Saver
8: Memory channel recall 08	Automatic Power Off
9: Memory channel recall 09	Clock
0: Memory channel recall 00	Tone Alert
MHz	Step Selection
LOW	TX. Stop
SHIFT	Reverse

Note

You can not operate these functions during transmit.

4 Using other microphones

If you will not be using the SMC-33, we recommend using an electret type microphone. The input impedance is 2k ohms and the DC voltage on the microphone terminal is approximately 4 volts (Max. 3.5 mA). Do not use a dynamic microphone.

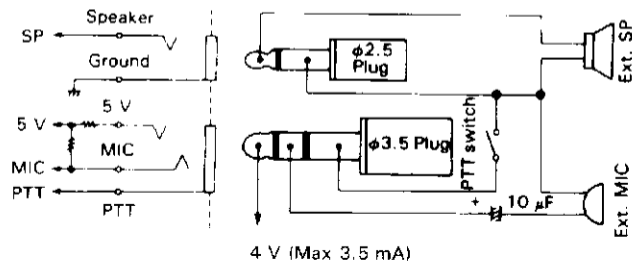

5 Connecting an External Speaker

At times, you may want to use an external speaker. Use the speaker jack located on top of the transceiver to connect an external speaker or earphone. We recommend using an 8 ohms speaker or earphone.

Plugging an external speaker into the transceiver deactivates the internal speaker.

SPECIFICATIONS

GENERAL		TH-28A/E	TH-48A/E
FREQUENCY RANGE (MHz)	U.S.A. Version	144 to 148	438 to 450
	U.K. and Europe	144 to 146	430 to 440
	Other market	144 to 146 or 144 to 148	430 to 440 or 438 to 450
MODE		F3E (FM)	
ANTENNA IMPEDANCE		50 Ω	
OPERATING TEMPERATURE		-20°C ~ +60°C (-4°F ~ 140°F)	
POWER REQUIREMENTS	DC IN (nominal)	7.2 V ~ 16 VDC (13.8 VDC)	
	BATTERY PACK	6.3 V ~ 16 VDC (7.2VDC)	
CURRENT DRAIN		(Approx.)	(Approx.)
13.8VDC (Ext. Power Supply)	H	1.4A	1.6A
7.2VDC (Battery)	H	0.95A	1.1A
Transmit mode	L	0.5A	0.6A
Transmit mode	EL	90mA	95mA
Receive mode with no signal		55mA	57mA
Battery Save mode		15mA	15mA
GROUND		Negative	
DIMENSION(W × H × D)		49.5 × 115.8 × 37.8mm	
DIMENSION(Projection Included)		61.2 × 131.5 × 37.8mm	
WEIGHT		330g	
MICROPHONE IMPEDANCE		2kΩ	

TRANSMITTER

OUTPUT POWER	H (13.8V DC)	more than 5W
	H (7.2V DC)	Approx. 2W
	M (13.8V DC)	Approx. 2.5W
	L (7.2V DC)	Approx. 0.5W
	EL (7.2V DC)	Approx. 20mW

	TH-28A/E	TH-48A/E
MODULATION	Reactance	
MAX. FREQUENCY DEVIATION	±5kHz	
SPURIOUS RADIATION	less than -60dB	
RECEIVER		
CIRCUITRY	Double conversion superheterodyne	
INTERMEDIATE FREQUENCY 1st.	45.05 MHz	
INTERMEDIATE FREQUENCY 2nd.	455 kHz	
SENSITIVITY (12dB SINAD)	less than -15dBμ (0.18μV)	less than -13dBμ (0.2μV)
	less than -20dBμ(0.1μV)	
SQUELCH SENSITIVITY	less than -20dBμ(0.1μV)	
SELECTIVITY -6dB	more than 12kHz	
SELECTIVITY -40dB	less than 28kHz	
AUDIO OUTPUT POWER (10% distortion)	more than 200 mW (across 8Ω load)	

NOTES:

1. Circuits and ratings are subject to change without notice, due to development in technology.
2. Recommended duty cycle :
1 minute Transmission, 3 minutes Reception.

QUICK REFERENCE

Note: The plus symbol (+) means press two keys simultaneously. "then" means press two keys in sequence. "(1 second)" means press the key for longer than one (1) second.

<i>TO DO THIS</i>	<i>PRESS</i>
Activate all function (blue letters)	F
Activate BAND scan	VF O (1 second)
Activate call channel function	CALL
Activate call scan	CALL (1 second)
Activate CTCSS function	F then 3
Activate DTMF delay time (2 seconds)	3 + POWER
Activate DTSS delay time	2 + POWER
Activate DTSS function	F then 2
Activate duplex function	F then BAND
Activate memory channel scan	MR (1 second)
Activate PAGING mode	F then 1
Activate tone encoder (except Europe version)	TONE

<i>TO DO THIS</i>	<i>PRESS</i>
Activate tuning control lock function	LOCK
Activate hold/resume mode	5 + POWER
Change tone alert sound	TONE + POWER
Clear displayed memory channel data	M (1 second) then MR
Determine if a frequency is in use before transmitting	MONI
Display current DTSS code	F (1 second) then 2
Display current VFO tuning step	F then MHz
Enter displayed frequency in upper limit frequency of programmable band scan 1	M (1 second) then 5
Enter displayed frequency in upper limit frequency of programmable band scan 2	M (1 second) then 6

<i>TO DO THIS</i>	<i>PRESS</i>
Enter displayed frequency in lower limit frequency of programmable band scan 1	M (1 second) then 8
Enter displayed frequency in upper limit frequency of programmable band scan 2	M (1 second) then 9
Enter displayed data in call channel	M then CALL
Enter displayed data in upper limit frequency of programmable VFO tuning limit	M (1 second) then 4
Enter displayed data in lower limit frequency of programmable VFO tuning limit	M (1 second) then 7
Exchange Main and Sub band contents	BAND
Initiate VFO and last memory channel scan	F then MR
Recall lower limit frequency of programmable band scan 1	F (1 second) then 8
Recall upper limit frequency of programmable band scan 1	F (1 second) then 5
Recall lower limit frequency of programmable band scan 2	F (1 second) then 9
Recall upper limit frequency of programmable band scan 2	F (1 second) then 6

<i>TO DO THIS</i>	<i>PRESS</i>
Reset memory	M + POWER
Reset VFO	F + POWER
Reverse function on or off	F then SHIFT
Select desired transmitter offset direction	SHIFT
Select transmit output power level	LOW
Select tone frequency(except Europe version)	F then TONE
Set memory channel lock out on or off	F then 6
Transmit	PTT
Transmit 1750 Hz repeater access tone (Europe version)	TONE
Turn automatic power saver on or off	F then 8
Turn battery saver on or off	F then 7
Turn beep on or off	8 + POWER
Turn CLOCK function on or off	F then 9
Turn the transceiver on or off	POWER
Turn TONE alert function on or off	F then 0
Turn TX.STOP function on or off	F then LOW