

**KENWOOD**

**220 MHz FM TRANSCEIVER**

**TH-315 A**

**INSTRUCTION MANUAL**

**KENWOOD CORPORATION**



## IMPORTANT

Please read this instruction manual carefully before placing your transceiver in service.

This Instruction Manual covers the following models:

- TH-415A: 430/440 MHz FM transceiver with DTMF.
- TH-415E: 430 MHz FM transceiver with Tone.  
(with Tone Burst for U.K. version)
- TH-315A: 220 MHz FM transceiver with DTMF.
- TH-215A: 144 MHz FM transceiver with DTMF.
- TH-215E: 144 MHz FM transceiver with Tone.  
(with Tone Burst for U.K. version)

## SAVE THIS INSTRUCTION MANUAL.

Under normal circumstances, the transceiver will operate in accordance with these operating instructions. The transceiver was preset at the factory and should only be readjusted by a qualified technician with proper test equipment.

Attempting service or alignment without factory authorization can void the transceiver's warranty.

### CAUTION:

Long transmission or extended operation in the 5 watt mode might cause the rear of this transceiver to get warm. Do not place the transceiver where the heat sink (rear panel) might come in contact with plastic or vinyl surfaces. Use of an external antenna for fixed station is recommended.

## MAINTENANCE ..... 18

- In case of difficulty
- Service

## OPTIONAL ACCESSORIES ..... 19

- Programmable tone decoder unit TSU-4

## BLOCK DIAGRAM ..... another sheet

## SCHEMATIC DIAGRAM ..... another sheet

Illustrations show the TH-215A.

## CONTENTS

|                                    |    |
|------------------------------------|----|
| ACCESSORIES .....                  | 3  |
| SPECIFICATIONS .....               | 4  |
| BATTERY PACK .....                 | 5  |
| Ni-Cd battery                      |    |
| Recharging the battery pack        |    |
| Manganese/Alkaline batteries       |    |
| Operating time                     |    |
| CONTROLS AND FUNCTIONS .....       | 6  |
| OPERATION .....                    | 10 |
| Receive                            |    |
| Transmit                           |    |
| Frequency selection .....          | 11 |
| Repeater operation.....            | 12 |
| Transmitter offsets                |    |
| Reverse function                   |    |
| Tone operation                     |    |
| Auto patch operations .....        | 13 |
| Scan .....                         | 14 |
| Beep tone                          |    |
| Memory.....                        | 15 |
| Memory channels                    |    |
| Memory entry                       |    |
| Memory recall                      |    |
| Odd Split memory channel           |    |
| Memory channel lockout .....       | 16 |
| Clearing a specific memory channel |    |
| Clearing all memories              |    |
| Memory back up battery             |    |
| Priority alert channel check       |    |
| Battery saver .....                | 17 |

## ACCESSORIES

Unpack your transceiver carefully and confirm that it is supplied with the following accessories.

1. Antenna for 144 MHz ..... T90-0352-05 ..... 1 ea.  
or for 220 MHz ..... T90-0363-08 ..... 1 ea.  
or for 430/440 MHz ..... T90-0354-05 ..... 1 ea.
2. Rubber cap ..... B09-0307-04 ..... 1 ea.
3. Belt Hook (U.S.A. version) J29-0417-04 ..... 1 ea.
4. Machine Screw (U.S.A. version) ..... N35-3005-41 ..... 2 ea.
5. Spring washer (U.S.A. version) ..... N16-0030-41 ..... 2 ea.
6. Ni-Cd Battery pack (PB-2) W09-0361-05 ..... 1 ea.  
or  
AA Manganese/Alkaline  
Battery case ..... A02-0728-03 ..... 1 ea.
7. Battery charger (120 V) W09-0315-25 ..... 1 ea.  
(U.S.A. version) or  
Battery charger (220 V) W09-0317-15 ..... 1 ea.  
(European version) or  
Battery charger (240 V) W09-0318-15 ..... 1 ea.  
(U.K. version) or  
Battery charger (240 V) W09-0319-15 ..... 1 ea.  
(Oceania version)
8. DC cable (PG-2V) (U.S.A. version) ..... Y62-8240-00 ..... 1 ea.
9. Instruction Manual ..... B50-8217-XX ..... 1 copy
10. Warranty Card (U.S.A. version) ..... 1 ea.



|   |                                    |   |                              |                  |                              |
|---|------------------------------------|---|------------------------------|------------------|------------------------------|
|   |                                    | Others                                  | TH-415A<br>430.000 ~ 439.995 | —                | TH 215A<br>144.000 ~ 147.995 |
|   |                                    | European and U.K. version               | TH-415E<br>430.000 ~ 439.995 |                  | TH 215E<br>144.000 ~ 145.995 |
| MODE  |                                    | F3 (FM)                                 |                              |                  |                              |
| OPERATING TEMPERATURE                               |                                    | -20°C ~ +50°C (-4°F ~ +122°F)           |                              |                  |                              |
| ANTENNA IMPEDANCE                                   |                                    | 50 Ω                                    |                              |                  |                              |
| POWER REQUIREMENT                                   |                                    | 6.3 V ~ 15 VDC (8.4 VDC nominal)        |                              |                  |                              |
|   |                                    | DC IN 7.2 V ~ 16 VDC (13.8 VDC nominal) |                              |                  |                              |
| CURRENT DRAIN                                       | Hi TRANSMIT MODE 2.5 W (8.4 V)     | Approx. 1.2 A                           |                              | Approx. 1 A      |                              |
|   | Hi TRANSMIT MODE 5 W (13.8 V)      | Less than 2 A                           |                              | Less than 1.7 A  |                              |
|   | Low TRANSMIT MODE                  | Less than 0.9 A                         |                              | Less than 0.7 A  |                              |
|   | RECEIVE MODE WITH NO SIGNAL        | Approx. 55 mA                           |                              | Approx. 55 mA    |                              |
|   | BATTERY SAVER MODE (At 1 : 2)      | Approx. 20 mA                           |                              |                  |                              |
| DIMENSIONS  | W × H × D                          | 67 × 173 × 37 (mm)                      |                              |                  |                              |
|   | (PROJECTIONS INCLUDED)             | 70 × 181 × 40 (mm)                      |                              |                  |                              |
| WEIGHT  | With Ni-Cd battery and antenna     | Approx. 560 g                           |                              | Approx. 550 g    |                              |
|   | With manganese battery and antenna | Approx. 540 g                           |                              | Approx. 530 g    |                              |
| OUTPUT POWER  | Hi                                 | 13.8 VDC                                | 5 W                          |                  |                              |
|   |                                    | with PB-1                               | 5 W                          |                  |                              |
|   |                                    | with PB-2                               | 2 W                          | 2 W              | 2.5 W                        |
|   |                                    | with PB-3, PB-4                         | 1 W                          | 1 W              | 1.5 W                        |
|   | Low                                | Approx. 0.5 W                           |                              |                  |                              |
| MODULATION  | REACTANCE                          |   |                              |                  |                              |
| MAXIMUM FREQUENCY DEVIATION                         | ± 5 kHz                            |   |                              |                  |                              |
| SPURIOUS RADIATION                                  | Less than -60 dB                   |   |                              |                  |                              |
| RECEIVER  | CIRCUITRY                          | DOUBLE CONVERSION SUPERHETERODYNE       |                              |                  |                              |
|   | INTERMEDIATE FREQUENCY             | 1st IF                                  | 30.825 MHz                   | 16.9 MHz         | 16.3 MHz                     |
|   |                                    | 2nd IF                                  | 455 kHz                      |                  |                              |
|   | SENSITIVITY                        | 12 dB SINAD                             | Less than 0.25 μV            | Less than 0.2 μV | Less than 0.2 μV             |
|   | SQUELCH SENSITIVITY                | Less than 0.16 μV                       |                              |                  |                              |
|   | SELECTIVITY                        | -6 dB                                   | More than 12 kHz             |                  |                              |
|   |                                    | -40 dB                                  | Less than 24 kHz             |                  |                              |
| AUDIO OUTPUT POWER (across 8 Ω load 10% distortion) | More than 350 mW                   |   |                              |                  |                              |

**NOTE:** Circuit and ratings are subject to change without notice, due to development in technology.

## BATTERY PACK

**Installing the battery pack**  
Match the concave part at the bottom of the radio to the convex part at the top of the battery pack.  
Turn the battery pack clockwise until it clicks.  
Be sure the pack and transmitter are locked together.

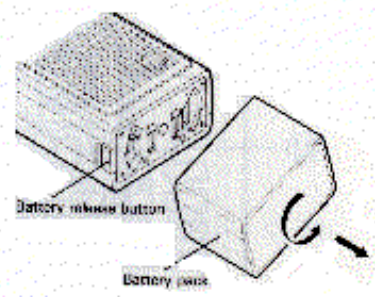

**Removing**  
Pressing the battery release button, turn the battery pack counterclockwise.

### Ni-Cd BATTERY PACK (PB-2)

**NOTE:**  
This battery pack has not been charged at the factory in order to provide you with the greatest number of charge/discharge cycles. You must charge the battery before use. The battery pack will require several charge/discharge cycles before you can expect to see the maximum operating period between charges. If the battery will be stored for greater than 2 months it should be recharged before use.

### RECHARGING THE BATTERY PACK

Insert the charge plug from the BC-2 into the receptacle on the rear of the battery pack. Then plug the BC-2 into the AC line. The LED on the BC-2 will illuminate to show that the pack is charging. The LED will remain on as long as the BC-2 is connected to the AC power source and the battery, indicating that the pack is still being charged. Do not allow the battery to charge for greater than 15 hours. The useful life and battery performance will be reduced if you exceed the recommended charging time.

## MANGANESE or ALKALINE BATTERIES

Load 6 × R6 (AA) manganese or alkaline batteries in series in the supplied battery case. (Be sure to observe the polarities.) (We recommend use of high-performance manganese batteries.) Battery pack (1) can be inserted into the case (2) only in a specific direction. Check the shape (top and bottom) after moving the stopper on the rear side, then insert the battery correctly. Inserting the battery by force without checking the shape may damage the case.

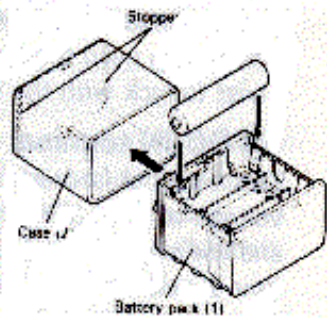

## OPERATING TIME

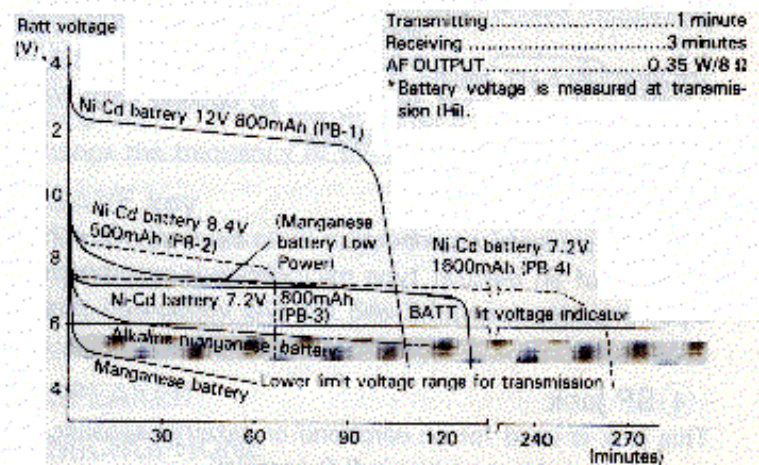



# CONTROLS AND FUNCTIONS

## 1 Antenna connector

This jack is used to connect the supplied antenna. Twist to lock with the BNC connector.

## 2 DC IN terminal

This terminal is used for an external power supply. Input voltage is 13.8 VDC nominal. The center is the (+) side and the sleeve is (-) side.

You should turn the power switch OFF when connecting this terminal. Pay attention to the polarity.



CAUTION:

As a precaution, do not remove the battery pack when an external power supply is used. Use the KENWOOD PG-2V (supplied with the U.S.A. version) or PG-3D optional cable for the connection.

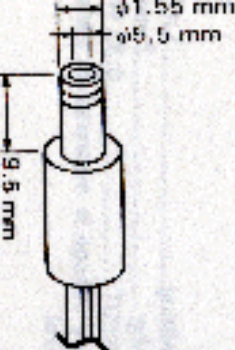

## 3 MIC jack

This jack is used for connection of an external microphone. The use of an electret type microphone is recommended. Input impedance is 2 k $\Omega$  and the DC voltage on this terminal is 4 V.

## 4 SP jack

This jack is used for an earphone or external speaker. The recommended impedance is 8  $\Omega$  nominal.

## 5 TONE switch

U.S. version:

This switch is used to activate the sub-audible tone encoder.

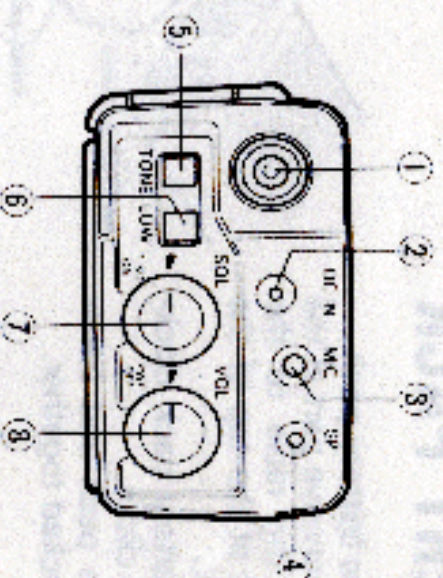

European version:

This switch is used to transmit a TONE signal. When the switch is pressed the repeater control signal of 1750 Hz is activated.

## 6 HI (■) / LOW (■) switch

This switch is used to select the transmit output power.

## 7 SQL control

The SQL control is used to eliminate noise during no signal periods. Normally, this control is adjusted clockwise until the noise just disappears and the BUSY indicator goes OFF (Threshold level). For scan operation, this control must be set to the threshold point. When an incoming signal is weak or unstable, readjust the squelch for optimum reception. For tone squelch operation with TSU-4, this control must be set to the T.SQ position. (TH-415A/315A/215A)

## 8 VOL control

Volume control with power ON/OFF switch.



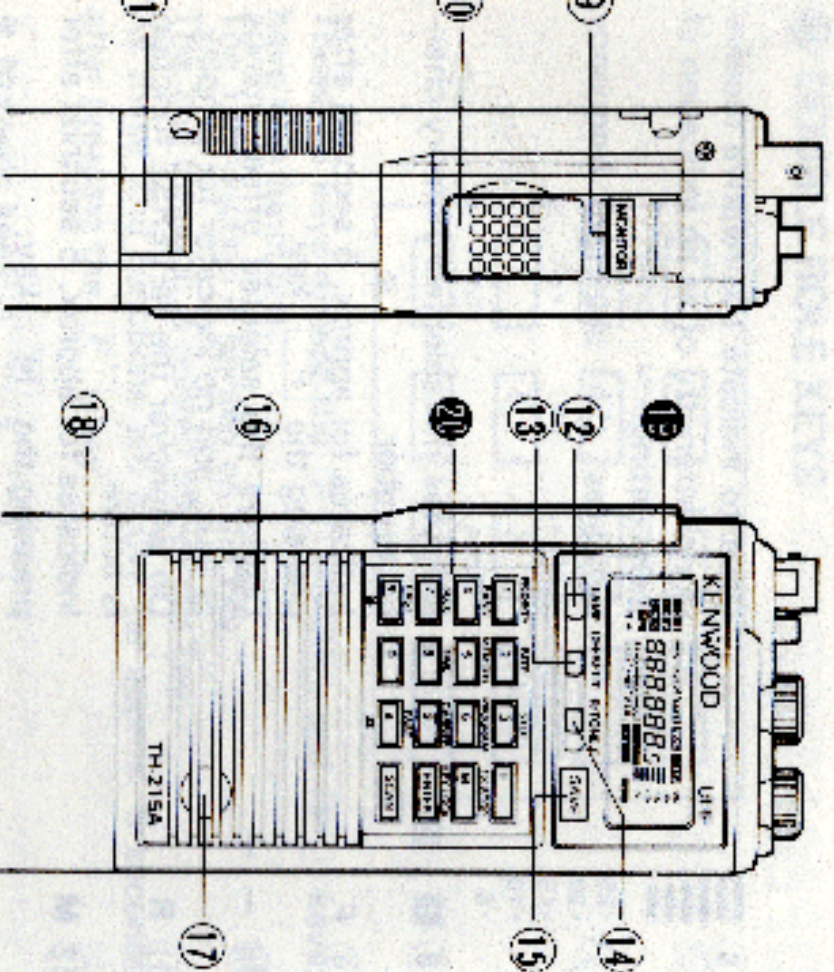

**9) MONITOR switch**

Pressing this key will open squelch.

**10) PTT (Push To Talk) switch**

For transmission, press this switch and speak into the microphone.

**11) RELEASE button**

Used to release the battery.  
Depress this button, and turn the battery counterclockwise.

**12) LAMP key**

This key controls the lamp on the LCD display.

**NOTE:**

When the LAMP is on battery drain will be accelerated. Do not use this feature unnecessarily.

**13) OFFSET/F key**

The OFFSET/F key is used to select the desired transmitter offset for repeater operation. Each time the key is pressed, the mode cycles from + shift, to - shift, to simplex, and back to + shift. When the offset function is ON, the symbol “+” or “-” is displayed.

Pressing the **[F]** and the OFFSET/F key in order is used to change the desired offset frequency.

**14) R/TONE. F (or REVERSE) key**

This key is used to reverse the transmit/receive frequencies during repeater operation.

**TONE. F: TONE FREQUENCY key (with the TH-415A/215A)**

Pressing the **[F]** and the R/TONE. F key in order is used to change the frequency of the tone encoder.

**15) SAVE key**

The SAVE key is used to select the power save condition during the receive mode.

Pressing the **[F]** and the SAVE key in order is used to change the battery saver on/off ratio.

**16) SPEAKER**

**17) MICROPHONE**

**18) BATTERY CASE**



# 13 Display

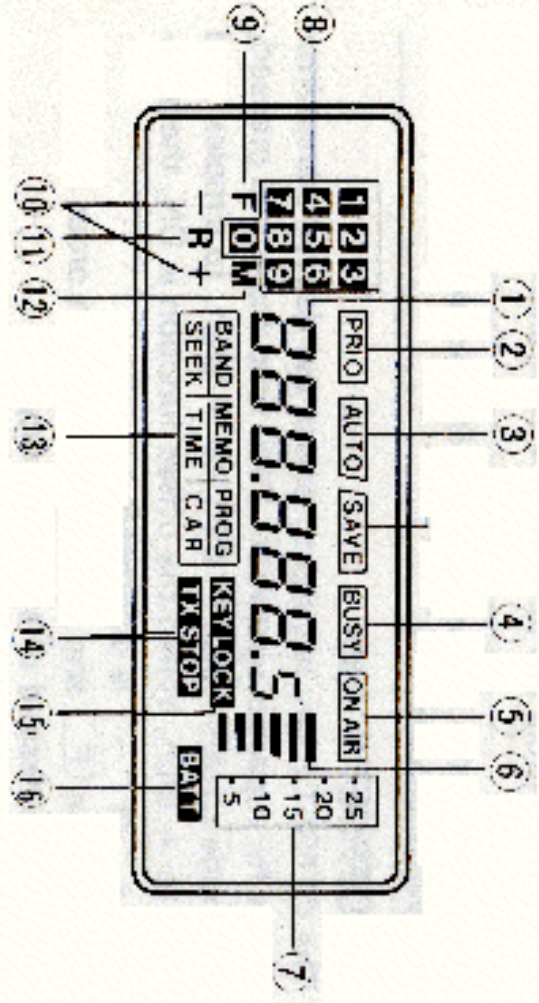

① FREQUENCY display

Displays the operating frequency.

② PRIORITY

ON when the Priority Alert function is active.

Flashes when the channel is busy.

③ [AUTO] [SAVE]

Displays the selected power save condition:

④ BUSY

[AUTO], [SAVE] for auto save mode, [SAVE] for save mode, and no indicator for OFF.

ON whenever the squelch opens during receive.

ON all the time if the squelch control is rotated counterclockwise, and the T.SQ is off.

⑤ ON AIR

ON during transmit mode.

⑥



Used to indicate the relative receive signal strength, or as an indication of transmitting.

⑦

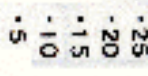

Indicates the selected frequency step.

⑧ 1 0

Indicates the selected memory channel number.

⑨ F

Indicates for approx. 5 seconds after pressing the [F] key.

⑩ - +

Displays the selected offset, minus or plus, and no indicator for simplex.

⑪ R

On whenever the REVERSE function is active.

⑫ M

Indicates for approx. 5 seconds after pressing the [M] key.

⑬ BAND MEMO PROG  
SEEK TIME CAR

Indicates the selected scan mode.

Indicates the selected scan stop mode.

Flashes during scan.

⑭ TX STOP

Indicates that the transmitter has been disabled by the TX.STOP key.

⑮ KEY LOCK

Indicates that all keyboard functions except LAMP key has been disabled by the KEY LOCK is activated.

⑯ BATT

ON when the battery voltage falls below the level for good communications. Recharge/replace the battery pack.



## 20 DOUBLE ROLE KEYS

| PRIORITY | HF2    | STEP    | F        |
|----------|--------|---------|----------|
| 1        | 2      | 3       | M        |
| HAND     | MEMORY | PROGRAM | TX S TOP |
| 4        | 5      | 6       | M        |
| SEEK     | TIME   | CHANNEL | KEY LOCK |
| 7        | 8      | 9       | ENTER    |
| FAST     |        | FAST    |          |
| * ▼      | 0      | ▲       | SCAN     |
|          |        | #       |          |

These 13 keys except the [F], [SCAN], and [0] keys, have two functions.

The 1st function is printed on the key.

The 2nd function is printed above the key.

All these 2nd functions are active for approx. 5 seconds after pressing the [F] key.

### ● Numeric keys: [1] [2] [3] [4] [5] [6] [7] [8] [9] [0]

These keys are used to select the desired operating frequency and/or memory channel number.

Memory channel 1, 8, and 9 also serve additional functions as described below.

M. channel 1 is used to store the Priority Alert channel information.

M. channel 8 is used to store the lower, and M. channel 9 the upper limit frequency for the programmable band scan.

### ● UP/DOWN keys: [▲], [▼]

These keys are used to increase or decrease the operating frequency, offset frequency, tone frequency, or the power saver circuit rate.

### ● F: Function exchange key

The [F] key is used to activate the 2nd function.

The F indicator is displayed for approx. 5 seconds after pressing the [F] key.

#### CAUTION:

You must press the 2nd function while the F indicator is lit, or the radio will perform the function printed on the key, rather than the function printed above it.

### ● M: Memory key

The [M] key is used to select the desired memory channel.

The operation is similar to that of the [F] key, in that, the M indicator will illuminate for 5 seconds in the LCD display.

#### CAUTION:

The memory channel must be selected within 5 seconds of pressing the [M] key.

### ● ENTER key

The [ENTER] key is used to enter a frequency selected by the numeric keys.

### ● SCAN key

The [SCAN] key is used to start or stop the scan function.

### ● PRIORITY CHANNEL CHECK key: [F] then 1/PRIO

These keys are used to monitor whether the priority channel (CH 1) is busy or not. When this function is activated, the radio will switch to CH 1 approximately once every 10 seconds.

To cancel this function, press these keys again.



● **BEEP key:** **[F]** then **2/BEEP**  
Each time these keys are pressed, the audio annunciator will be turned ON or OFF alternately.

● **(FREQUENCY) STEP key:** **[F]** then **3/STEP**  
Each time these keys are pressed, the frequency scanning step size will be increased 5 kHz.

Several different scan function keys and scan stop keys are provided.

- **BAND SCAN key:** **[F]** then **4/BAND**
- **MEMORY SCAN key:** **[F]** then **5/MEMORY**
- **PROGRAMMABLE BAND SCAN key:** **[F]** then **6/PROGRAM**
- **SEEK OPERATED SCAN key:** **[F]** then **7/SEEK**
- **TIME OPERATED SCAN key:** **[F]** then **8/TIME**
- **CARRIER OPERATED SCAN key:** **[F]** then **9/CARRIER**

For additional information on this function refer to page 14.

● **TX. STOP key:** **[F]** then **M/TX. STOP**  
Pressing these keys will prevent accidental transmission. To cancel this function, press these keys again.

● **KEY LOCK key:** **[F]** then **ENTER/KEY LOCK**  
Depress these keys and the frequency and other settings will remain unchanged by keyboard operation except the LAMP key.

To cancel this function, press these keys again.

- **FAST** **[▼]** key: **[F]** then **▼/FAST**
- **FAST** **[▲]** key: **[F]** then **▲/FAST**

# OPERATION

## ■ RECEIVE

After power and antenna connections have been completed, set the switches as follows:

1. Turn the VOL control clockwise to turn on power. The frequency on the LCD display will show the transceiver is operating.
2. As the VOL control is turned clockwise, either background noise or a QSO will be heard.
3. To eliminate the no-signal noise turn the SQL control clockwise.
4. Enter the desired frequency.

## ■ TRANSMIT

**Precaution:** Check the intended transmit frequency before operating to prevent interference with other stations. If you are using T. SQ (Tone Squelch) press the MONITOR key to allow the Squelch to open.

1. Simply depress the PTT switch and the **[ON AIR]** indicator will light.
2. Speak into the microphone. Recommended distance to the microphone is approximately 2 inches (5 cm).

### CAUTION:

Long transmission or extended operation in the 5 watt mode might cause the rear of this transceiver to get warm. Do not place the transceiver where the heat sink (rear panel) might come in contact with plastic or vinyl surfaces.



## ■ FREQUENCY SELECTIONS

Two different methods are provided for frequency selection.

### ● UP/DOWN key frequency selection

1 Pressing either the **▲** or the **▼** key momentarily will cause the displayed frequency to change 1 step up or down, respectively.

The step size is selected by pressing the **F** and the **3/STEP** key from 5 step sizes (5, 10, 15, 20, 25 KHz).

1 step up



1 step down



2 Pressing the **▲** or the **▼** key for more than 1 second will cause the frequency to change up or down continuously until the key is released.

3 Pressing the **F** followed by holding the **▲** or the **▼** key will cause the frequency to change quite rapidly.

Rapidly up

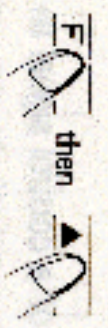

Rapidly down

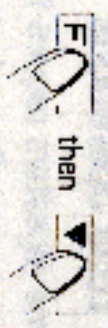

Repeating this operation shifts the displayed frequency as shown below.

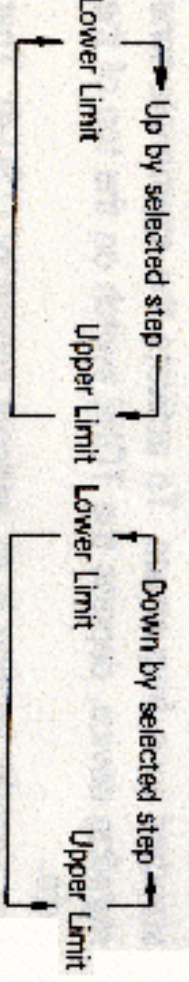

### ● Direct keyboard frequency entry

Press the **ENTER** key.

U.S.A. version

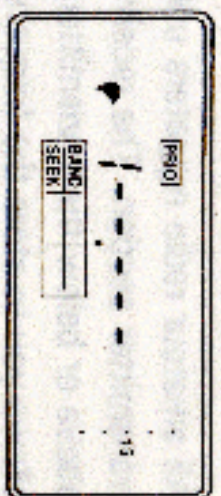

Other version



Enter the frequency to the nearest KHz.

For example

U.S.A. version

**1** **5** **6** **0** **0**

Other version

**1** **5** **6** **0** **0**

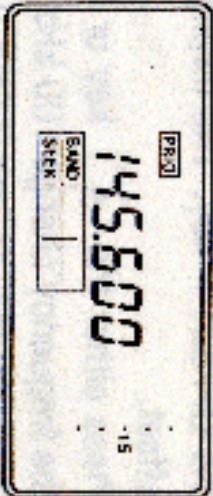

The receiver will not change frequency until all digits have been entered.

If you should make an error before entering all digits, press the **ENTER** key twice, and reenter all digits.



## REPEATER OPERATION

### Transmitter offsets

All amateur radio repeaters utilize a separate receiver and transmitter section. The receiver frequency may be either above or below the transmitter frequency. The transceiver allows you to store the frequency and offset in memory, or you can select the offset and offset frequency from the keyboard.

#### Offset direction

To select the desired offset, press the OFFSET/F key. Each time you press the key the radio will advance from one offset to the other, i.e. "+" to "-" to no offset or simplex.

#### Offset frequency selection

To select the desired offset frequency, press the [F] and the OFFSET/F key. The display shows present transmitter offset.

Press either the ▲ key or the ▼ key momentarily. The frequency change 100 kHz step up or down from lower limit 100 kHz to upper limit 9.9 MHz. Press the [ENTER] key to complete the selection.

#### NOTE:

You can enter any offset you desire, but if you select an offset that would cause the radio to go out of band the radio will ignore the programmed offset, and transmit in the simplex mode. (For MARS and CAP operators who have modified their radios to cover the MARS and CAP frequencies this may not be the case. For these sets the transceiver will accept any offset that does not take it outside its tuning range. See the instructions supplied with the MARS/CAP modification sheet.)

### Reverse function

Some repeaters utilize a "reverse pair", i.e. the transmit/receive frequencies are exactly the reverse of another repeater. For example repeater A uses 146.000 for a transmit frequency (OUTPUT) and 146.600 for receive (INPUT). Repeater B uses 146.000 for its receive and 146.600 for its transmit. It would be inconvenient to have to reprogram the radio each time if you were in range of both repeaters.

The R/TONE. F key has been provided to allow you to reverse the transmit and receive frequencies.

TH-415E/215E : Transmission is inhibited when the REVERSE key is engaged.

To use the REVERSE function, press the R/TONE. F (or press and hold the REVERSE) key. The R indicator will light in the display.

To return to normal offsets press the R/TONE. F (or release the REVERSE) key again. This function is useful to check the input frequency of the repeater so that you can determine if you are within SIMPLEX range.

### Tone operations

Some repeaters require the use of a control signal to activate the repeater. Several versions are currently in use worldwide.

#### TH-415A/315A/215A:

These transceiver provides a subaudible tone encoder with 38 standard tone frequencies. To activate the appropriate tone signaling device, depress the TONE switch on the top of the radio.

The decoder section is an optional accessory (TSU-4). That allows for T.SQ (Tone Squelch) operation. With this option you will only hear those stations that transmit the same subaudible tone directly.



## TH-415E/215E:

In Europe a 1750 Hz tone is used in transmit. In the United Kingdom a 1750 Hz tone burst at the beginning of each transmission is used. Since use of these tones is required in the U.K. and in Europe the tone encoder is included as standard equipment.

### Tone frequency selection

To select the tone frequency, press the **[F]** and the **R/TONE.F** key. The display will show a operating tone frequency.

Press either the **▲** key or the **▼** key momentarily, the frequency will change 1 step up or down. Press the **ENTER** key to complete the selection.

### Tone Frequency

|          |          |          |
|----------|----------|----------|
| 67.0 Hz  | 107.2 Hz | 167.9 Hz |
| 71.9 Hz  | 110.9 Hz | 173.8 Hz |
| 74.4 Hz  | 114.8 Hz | 179.9 Hz |
| 77.0 Hz  | 118.8 Hz | 186.2 Hz |
| 79.7 Hz  | 123.0 Hz | 192.8 Hz |
| 82.5 Hz  | 127.3 Hz | 203.5 Hz |
| 85.4 Hz  | 131.8 Hz | 210.7 Hz |
| 88.5 Hz  | 136.5 Hz | 218.1 Hz |
| 91.5 Hz  | 141.3 Hz | 225.7 Hz |
| 94.8 Hz  | 146.2 Hz | 233.6 Hz |
| 97.4 Hz  | 151.4 Hz | 241.8 Hz |
| 100.0 Hz | 156.7 Hz | 250.3 Hz |
| 103.5 Hz | 162.2 Hz |          |

### Tone Squelch operation

To actuate the tone squelch function (decode), turn the Squelch control fully counterclockwise past the detent. Squelch will now open only when the radio receives the same subtone frequency. To return to normal noise activated squelch, turn the Squelch control clockwise past the detent.

It is a good operating practice to check the frequency before transmitting. A **MONITOR** switch has been provided for this purpose when using the **TONE SQUELCH** function. Pressing this switch will open the squelch so you can check for activity.

### NOTE:

97.4 Hz is available only for encode.

## ● Autopatch operations (with the TH-415A/315A/215A)

Some repeaters offer a service known as **AUTOPATCH**. This allows you to dial a telephone number from your radio and carry out a telephone conversation, much like a car telephone, or cellular telephone. This function requires the use of a **DTMF** (Dual Tone Multi Frequency) pad. This is also known as a touch tone pad. It operates just like the touch tone pad on your home telephone. In addition to the normal 12 keys that are found on your telephone the transceiver also provides 4 additional keys A, B, C, and D. These keys are required by some repeater systems for various control functions. You should check with the control operator of your repeater to determine if their use is required. A chart is provided that lists the tones that are generated when you press each key.

To use the touch tone pad you should first key the radio using the **PTT** switch. Then simply press the numbers corresponding to the telephone number you want to dial. Some repeaters will require a special sequence of keys to activate the autopatch. Again you should check with the control operator of your repeater for this sequence.

After you have pressed the first number key the radio will remain keyed for approximately 2 seconds. This is done so you do not have to hold the **PTT** switch depressed while dialing. The radio remains keyed after you press each number for this 2 seconds interval.

| Column | Row | 1209 | 1336 | 1477    | 1633 |
|--------|-----|------|------|---------|------|
| 697    | 1   | 2    | 3    | F=A     |      |
| 770    | 4   | 5    | 6    | M=B     |      |
| 852    | 7   | 8    | 9    | ENTER=C |      |
| 941    | ▲   | 0    | ▼    | SCAN=D  |      |

(Hz)



## ■ SCAN

Scan is initiated by pressing the **SCAN** key.

The transceiver will stop on a busy channel. When an incoming signal is detected during scanning, the **BUSY** indicator will light. In order for this function to operate the **SQL** control must be adjusted to the threshold point. Scan direction can be selected by either the **▲** or the **▼** key before initiating scan.

The selected scan mode and scan stop mode indicators will flash ON and OFF during scanning.

### ● SCAN MODES

**1. BAND SCAN MODE:** Scans the entire band.

**2. MEMORY SCAN MODE:** Scans the memory channels repeatedly, skipping the vacant channels.

**3. PROGRAMMABLE BAND SCAN MODE:** Scans between the frequencies stored in memory channels 8 and 9.

If the frequency stored in memory channel 8 is the same or greater than in memory 9, or if either or both channels are vacant, scan will proceed over the entire band.

If **SCAN** is initiated while the displayed frequency is outside the range specified in memory channels 8 and 9, scan will proceed outside of the programmed limits.

In the **BAND SCAN** and **PROGRAMMABLE BAND SCAN MODE**, scan proceeds according to the selected step size.

### ● SCAN STOP AND RESUME MODES

**1. SEEK OPERATED SCAN:** Scan will stop on a busy channel. Scan will not resume until the **SCAN** key is pressed again.

**2. TIME OPERATED SCAN:** Scan will stop on a busy channel and resume approx. 5 seconds afterwards. Scan will resume even if the station is still present.

**3. CARRIER OPERATED SCAN:** Scan will hold as long as the signal is present and resume scan after a 2 second delay if the signal drops out.

**Releasing scan:** Press one of the following keys during scanning to clear the scan mode.

- a) **SCAN** key
- b) **PTT** switch

### ■ BEEP TONE

Audible confirmation of microprocessor function is provided in the form of a series of audio beeps.

To activate beep tones, press the **F** key and 2/BEEP key.

The radio will then supply audio confirmation according to the chart below.

| Scan# | Frequency (Hz) | Key operation                                       |
|-------|----------------|---|
| A     | 440.00         | MIR 0   |
| A#    | 486.16         | MIR 1   |
| B     | 493.88         | MIR 2   |
| C     | 523.25         | MIR 3, SAVE ON                                      |
| C#    | 554.37         | MIR 4, OFFSET                                       |
| D     | 587.33         | MIR 5, To select OFFSET Frequency.                  |
| D#    | 622.26         | MIR 6, REV. To select Tone Frequency                |
| E     | 859.26         | MIR 7, TXSTOP, SAVE AUTO                            |
| F     | 698.46         | MIR 8, To change the rate of Power Save time. ENTER |
| FA    | 739.98         | MIR 9, KEYLOCK                                      |
| G     | 783.98         | DOWN, SAVE OFF                                      |
| G#    | 830.61         | UP  |
| A     | 880.00         | F   |
| A#    | 932.33         | M   |
| B     | 987.77         | Stopping scanning                                   |
| F     | 1396.91        | Key operation without effect.                       |



## ■ MEMORY

### ● MEMORY CHANNELS

The 10 memory channels (1 through 9, and 0) are available for data entry. Channel 1, 8 and 9 have the following functions in addition to its ordinary function.

Channel 1 is the Priority Alert Channel.

Channel 8 is the lower, and channel 9 is the upper limit frequency for the programmable band scan operation.

Channel 0 is the Odd Split channel.

Each memory channel can store RX Frequency, F. STEP status, OFFSET, REVERSE switch status and TONE Frequency (TH-415A/315A/215A).

### ● MEMORY ENTRY

1. Press the **M** key. The display will indicate M and any memory channels that contain data. (Ex. 1, 4, 7, 8, 9)
2. Press the desired memory channel number (Ex. 5) within 5 seconds of pressing the **M** key. This will actually store the information into memory.



### ● MEMORY RECALL

Simply press the desired memory channel key and the radio will switch to this frequency.

To return to the original operating frequency, press the same memory channel key again

### ● ODD SPLIT MEMORY CHANNEL

Memory channel 0 stores both a transmit and a receive frequency. This channel will allow operation on "Odd Split" repeater channels.

1. Select the desired receiver frequency, tone frequency, etc.
2. Press the **M** and then the **0** key to store this part of the data into memory.
3. Select the desired transmitter frequency.
4. Press the **M** key.
5. Within 5 seconds of pressing the **M** key press and hold the PTT switch. The PTT switch will not initiate transmit during the programming of this channel.
6. Press the **0** key within 5 seconds of pressing the PTT switch to complete the operation. After you have pressed the **0** key in this step you may release the PTT key.

To operate on memory channel 0 you need only press the **0** key. The - and the + indicators will turn on to indicate that this memory channel now contains odd split frequency data.

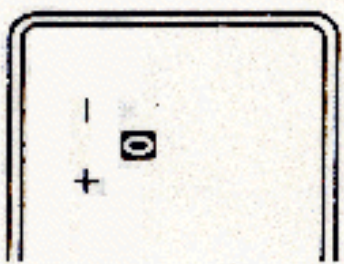

To cancel this odd split data simply store a new frequency into the memory channel.



## ● MEMORY CHANNEL LOCKOUT

The Memory Channel Lockout function allows you to temporarily skip unwanted memory channel(s).

1. Select the memory channel you wish to skip.
2. Press the **F** key. The F indicator will illuminate.
3. Press the **0** key within 5 seconds. The selected memory channel number will flash as an indication the Memory Channel has been locked out.

### NOTE:

The channel number will not flash while the display is showing M and the listing of the memory channels that contain data. It will only flash when you recall the individual memory channel from the front panel directly.

4. To cancel the lockout press the desired memory channel number key and then press the **|F|** and **0** keys again.

## ● CLEARING A SPECIFIC MEMORY CHANNEL

1. Press the **|M|** key. The display will indicate M and any memory channels that contain data. (Ex. 1, 4, 5, 7, 8, 9)

2. Press the **|F|** key. The F indicator will illuminate.



3. Press the key that corresponds to the channel you want to clear (Ex. 7) within 5 seconds of pressing the **|F|** key. The M, F, and channel number display will clear indicating the operation has been completed.
4. To confirm the data was erased press the **|M|** key.  
(From our example the **7** will now be gone.)



## ● CLEARING ALL MEMORIES (= Microprocessor Initialization)

To erase all data from the memories, turn the power switch on while pressing both the **|F|** and the **|ENTER|** keys together.

## ● MEMORY BACK-UP BATTERY

The transceiver includes a lithium back-up battery to retain memory in the microprocessor. When changing batteries, or if the Ni-Cd batteries should fully discharge, memory will always be retained.

If the display should begin to show erroneous information or numbers, the lithium battery needs replacement.

This should be performed by an authorized KENWOOD dealer since these components are easily damaged by static electricity.

## ■ PRIORITY ALERT CHANNEL CHECK

Memory channel 1 can be monitored at about 5 seconds intervals to check for activity.



Press the **F** key and then the 1/PRIO key, **PRIO** will appear on the display.

If the channel is busy, the **PRIO** indicator blinks, and if the BEEP function is ON, a beep will sound.

To stop the function, press the **F** and 1/PRIO keys again.

The function does not operate during scan or transmission.

## ■ BATTERY SAVER

Battery Saver operation provides to turn ON or OFF battery power automatically during reception and thus extend operation time.

### 2 ACTIVATION MODES

1. **SAVE MODE:** The transceiver will activate the battery saver circuit 2 seconds after the squelch closes.
2. **AUTO SAVE MODE:** The transceiver will activate the battery saver circuit 1 minute after the last key operation during the squelch closes.

To select the desired Battery Saver Mode, press the **SAVE** key. Each time press the key, radio will advance from **SAVE** to **AUTO SAVE** to **OFF**. The indicator will light;

|                |              |
|----------------|--------------|
| SAVE MODE      | /SAVE        |
| AUTO SAVE MODE | AUTO /SAVE   |
| OFF            | No indicator |

### Power Save Ratio Selection

To after the actual length of time the receiver section shuts down, press the **F** key and then the **SAVE** key. The display will show the time the radio will be operating at reduced power levels (Ex. 1 : 1).

Use the **▲** or the **▼** key to select the desired save ratio from 1 : 1 to 1 : 9.

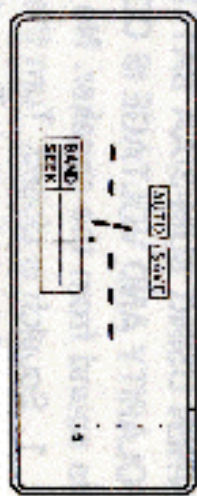

Press the **ENTER** key to complete the selection.

The radio will operate at reduce power consumption according to the accompanying diagram.

For example;

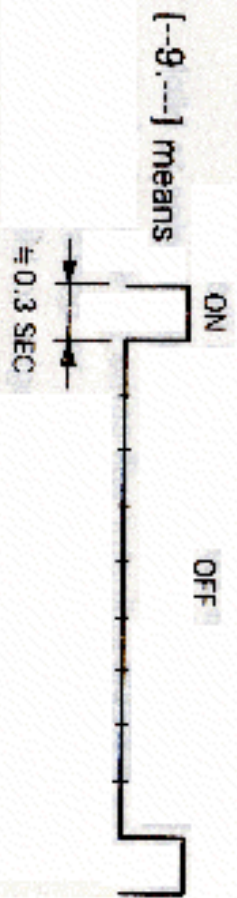
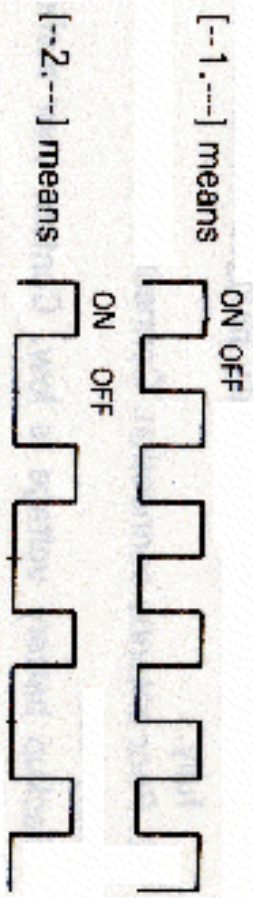

When a signal is received, the function is automatically cancelled.

Since the receiver section shuts down, the squelch may not open by pressing the **MONITOR** switch.



# MAINTENANCE

## ■ IN CASE OF DIFFICULTY

**WHEN USING SUM-3/AA BATTERIES, ENSURE THE BATTERY POLARITY AND VOLTAGE IS CORRECT BEFORE PROCEEDING. No sound from the speaker. No signal can be received.**

1. Squelch is closed. Turn the SQL control counterclockwise.
2. T.SQ is activated. Turn the SQL control clockwise past the detent position.
3. PTT switch of microphone is pressed setting the unit in the transmit mode. Turn PTT switch off.

**No control works.**

**KEY LOCK is ON.** Press **F** key and **KEY LOCK** key.

**No output**

1. Microphone jack is not fully plugged in. Insert the plug fully.
  2. Poor antenna connection. Connect antenna securely.
- Memory loss.**

Backup battery voltage is low. Contact your authorized dealer.

**All the indicators go out on the display.**

Turn the power switch OFF and then ON.

**The BATT and/or ON AIR indicator begins to blink.**

The **BATT** indicator will come on when the battery needs recharging. If you continue to operate and the **BATT** and/or **ON AIR** indicator begins to blink the radio will no longer operate properly.

Replace/Recharge the battery when the **BATT** indicator comes on.

## ■ SERVICE

Should it ever become necessary to return the equipment to your dealer or service center for repair, pack in its original box and packing, and include a full description of the problems involved. Also include your telephone number. You need not return accessory items unless directly related to the service problem.

**Service note:** Dear OM, if you desire to correspond on a

technical or operational problem, please make your note short, complete, and to the point. And PLEASE make it readable.

Please list: Model and serial number.

The question or problem you are having.

When claiming warranty service, a photocopy of the bill of sale, or other proof of purchase showing the date of sale must accompany the radio.



# OPTION

|   |   |  |
|---|---|--|
| <b>SWIVEL MOUNT</b><br><b>BH-5</b>                    | <b>TELESCOPING ANTENNA</b><br><b>RA-3 (144 MHz)</b> | <b>MICRO HEADPHONES</b><br><b>HS-7</b>                 |
| <b>SOFT CASE</b><br><b>SC-13</b><br>(for PB-1/4)      | <b>MOBILE MOUNTING BRACKET</b><br><b>MB-4</b>       | <b>MICRO HEADPHONE</b><br><b>HS-8</b>                  |
| <b>PROGRAMMABLE TONE DECODER UNIT</b><br><b>TSU-4</b> | <b>SOFT CASE</b><br><b>SC-12 (for PB-2/3)</b>       | <b>FILTERED CIGARETTE LIGHTER CORD</b><br><b>PG-3D</b> |
|   | <b>DC CABLE</b><br><b>PG-2V</b>                     |  |

## POWER SUPPLY

|   |   |  |
|---|---|--|
| <b>NI-CD RECHARGEABLE BATTERY PACK</b><br><b>PB-1</b><br>12V 800mAh<br>Charge with PB-7/8 only. | <b>NI-CD RECHARGEABLE BATTERY PACK</b><br><b>PB-3</b><br>7.2V 800mAh<br>Charge with PB-7/8 only.  | <b>AA MANGANESE/ALKALINE BATTERY CASE</b><br><b>BT-5</b> |
| <b>NI-CD RECHARGEABLE BATTERY PACK</b><br><b>PB-2</b><br>8.4V 500mAh                            | <b>NI-CD RECHARGEABLE BATTERY PACK</b><br><b>PB-4</b><br>7.2V 1600mAh<br>Charge with PB-7/8 only. | <b>BATTERY CHARGER</b><br><b>BC-2 (for PB-2 only)</b>    |
| <b>RAPID CHARGER</b><br><b>BC-7</b><br>(for PB 1/2/3/4)   | <b>COMPACT CHARGER</b><br><b>BC-8</b><br>(for PB 1/2/3/4)   |  |

### NOTE:

Some optional accessories may not be available in your area. Some cars may not be suitable to hook the MB-4 into the window. HMC-1 vox headset cannot be used.

## PROGRAMMABLE TONE DECODER UNIT (TSU-4) INSTALLATION

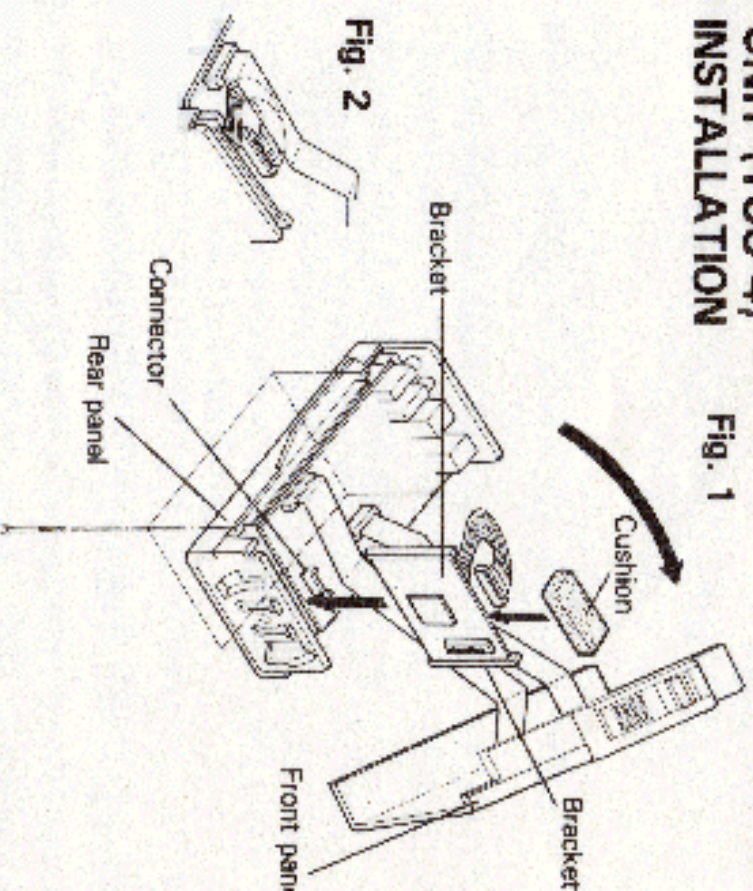

1. Remove the four Phillips head screws from the rear panel of the radio.
2. Gently remove the front panel. The panel should be rotated away from the PTT switch side.
3. Remove the foam cushion attached to the bottom of the set. Install the tone squelch unit between the bottom of the set and the main circuit board as shown in Fig. 1.
4. Attach the cable from the TSU-4 as shown in Fig. 2. The cable should be routed under the ribbon cable that goes to the front panel.
5. Remove the backing from the foam cushion that was provided with the TSU-4 and attach the cushion to the edge of the TSU-4.
6. Replace the covers and tighten screws to complete the installation.