

KENWOOD

144MHz FM TRANSCEIVER

TH-25A SERIES

430/440MHz FM TRANSCEIVER

TH-45A SERIES

1200MHz FM TRANSCEIVER

TH-55AT SERIES

INSTRUCTION MANUAL

KENWOOD CORPORATION



©PRINTED IN JAPAN B50-8170-50K, M, T, X(T)
90/12 11 10 9 8 7 6 5 4 3 2 1 89/12 11 10 9 8 7 6 5

Thank you for purchasing this new transceiver.

IMPORTANT:

Please read this instruction manual carefully before placing your transceiver in service.

SAVE THIS INSTRUCTION MANUAL.

This Instruction Manual covers the following models:

- TH-25AT :144 MHz FM transceiver with DTMF Pad.
- TH-25A :144 MHz FM transceiver without DTMF Pad.
- TH-25E :144 MHz FM transceiver with Tone.
(with Tone Burst for U.K. version)
- TH-45AT :430/440 MHz FM transceiver with DTMF Pad.
- TH-45A :430/440 MHz FM transceiver without DTMF Pad.
- TH-45E :430 MHz FM transceiver with tone.
(with Tone Burst for U.K. version)
- TH-55AT :1200 MHz FM transceiver with DTMF Pad.
- TH-55E :1200 MHz FM transceiver with Tone.
(with Tone Burst for U.K. version)

Under normal circumstances, the transceiver will operate in accordance with these operating instructions. The transceiver has been adjusted at the factory and should only be readjusted by a qualified technician with proper test equipment.

Attempting service or alignment without factory authorization can void the transceiver's warranty.

CAUTION:

Long transmission or extended operation in the HI power mode might cause the rear of this transceiver to get warm. Do not place the transceiver where the heat sink (rear panel) might come in contact with plastic or vinyl surfaces. Use of an external antenna for fixed station is recommended.

Illustrations show the TH-25A.

CONTENTS

- 1. SPECIFICATIONS and ACCESSORIES 4
- 2. BATTERY PACK 6
- 3. OPERATION
 - OPERATING CONTROLS 8
 - RECEIVER OPERATION.....12
 - TRANSMITTER OPERATION
 - MEMORY.....13
 - AUTOMATIC MEMORY INITIALIZATION
 - MEMORY ENTRY
 - MEMORY SHIFT.....14
 - MEMORY RECALL
 - ODD SPLIT
 - MEMORY CHANNEL LOCKOUT15
 - CLEARING ALL MEMORY16
 - MEMORY BACK UP BATTERY
 - SCAN
 - REPEATER OPERATION.....17
 - TRANSMITTER OFFSETS
 - REVERSE FUNCTION
 - TONE OPERATION
 - AUTOPATCH19
 - BEEP TONE
 - TONE ALERT SYSTEM20
 - BATTERY SAVER
 - AUTOMATIC POWER OFF
 - BATTERY SAVER and AUTOMATIC POWER OFF function CANCEL
- 4. BLOCK DIAGRAM and SCHEMATIC DIAGRAMAnother sheet
- 5. MAINTENANCE22
 - IN CASE OF DIFFICULTY23
- 6. OPTIONAL ACCESSORIES Back cover

1. SPECIFICATIONS and ACCESSORIES

1-1 SPECIFICATIONS

■ GENERAL		TH-25A/25AT/25E 2 m Band	TH-45A/45AT/45E 70 cm Band	TH-55AT/55E 23 cm Band	
FREQUENCY RANGE (MHz)	U.S.A. version	144.000~147.995	440.000~449.995	1258.000~1299.9875	
	European and U.K. version	144.000~145.995	430.000~439.995	1258.000~1289.9875	
	Others	144.000~147.995	430.000~439.995	1258.000~1289.9875	
MODE	F3E (FM)				
MEMORY CHANNELS	14				
FREQUENCY STEP (kHz)	TH-25A/25AT	TH-25E	TH-45A/45AT	TH-45E	
	5, 10	12.5, 5	25, 5	12.5, 5	
ANTENNA IMPEDANCE (Ω)	50				
POWER REQUIREMENT	6~16 (7.2 VDC nominal)				
CURRENT DRAIN	HI	12 V (with PB-8 or DC-1)	Less than 1.2 A	Less than 1.8 A	Less than 1.0 A
		9 V (with BT-8)	Approx. 0.9 A	Approx. 1.4 A	Less than 1.0 A
		7.2 V (with PB-5/6/7/9)	Approx. 0.8 A	Approx. 1.1 A	Approx. 0.8 A
	LO transmit mode	Less than 0.4 A	Less than 0.6 A	Less than 0.6 A	
	RECEIVE mode with no signal	Approx. 55 mA	Approx. 60 mA	Approx. 60 mA	
	BATTERY SAVER mode	Approx. 16 mA	Approx. 17 mA	Approx. 17 mA	
AUTOMATIC POWER OFF mode	Approx. 6 mA		Approx. 5 mA		
FREQUENCY STABILITY (-10°C ~ +60°C)	±3 ppm				
GROUND	Negative				
DIMENSIONS (W×H×D)	Projections not included (mm)		58×137.5×29.5 (2.3×5.4×1.2 inch)		
	Projections included (mm)	A/E	68.5×152.0×34.5 (2.7×6.0×1.35 inch)		
		AT	68.5×162.0×35.5 (2.7×6.0×1.4 inch)		
WEIGHT (g)	With NiCd Battery and Antenna		400 (0.88 lbs.)		
OPERATING TEMPERATURE	-20°C ~ +50°C (-4°F ~ 122°F)				
MICROPHONE IMPEDANCE	2 kΩ				
■ TRANSMITTER					
OUTPUT POWER	HI	12 V (with PB-8 or DC-1)	More than 5 W		1 W
		9 V (with BT-8)	Approx. 3.5 W	Approx. 3.5 W	1 W
		7.2 V (with PB-5/6/7/9)	Approx. 2.5 W	Approx. 2 W	Approx. 0.8 W

OUTPUT POWER	LO	Approx. 0.5 W	Approx. 0.1 W
MODULATION		REACTANCE	
MAXIMUM FREQUENCY DEVIATION (kHz)		±5	
SPURIOUS RADIATION		Less than -60 dB	Less than -50 dB
DUTY CYCLE OPERATION		1 minute transmission 3 minutes reception recommended	
RECEIVER			
CIRCUITRY			
DOUBLE CONVERSION SUPERHETERODYNE			
INTERMEDIATE FREQUENCY	1st IF (MHz)	18.9	30.825
	2nd IF (kHz)	455	
SENSITIVITY	12 dB SINAD	Less than 0.16 μV	Less than 0.18 μV
SQUELCH SENSITIVITY		Less than 0.1 μV	Less than 0.16 μV
SELECTIVITY	-6 dB	More than 12 kHz	
	-40 dB	Less than 28 kHz	Less than 32 kHz
RIT variable range			More than ±5 kHz
AUDIO OUTPUT POWER (across 8 Ω load 10% distortion)		More than 200 mW	

Note: Circuit and ratings are subject to change without notice, due to development in technology.

1-2 ACCESSORIES

Unpack your transceiver carefully and confirm that the accessories listed below are included in the box.

1 Antenna	1	for U.S.A. version (120 V) ...	W09-0382-XX
For 144 MHz	T90-0356-05	for European version (220 V) ..	W09-0388-XX
or For 430/440 MHz	T90-0355-05	for U.K. version (240 V)	W09-0387-XX
or For 1200 MHz	T90-0364-05	for Oceania version (240 V) ..	W09-0386-XX
2 Belt Hook	J29-0424-04	for Other market (220 V)	W09-0388-XX
3 Rubber Cap	B09-0309-04	(120 V)	W09-0385-XX
4 Hand Strap	J69-0312-04	7 Label	B42-3325-04
5 Battery	1	8 Warranty Card	1
NiCd battery pack (PB-6)	W09-0507-05	9 Instruction Manual	B50-B170-XX
6 Battery Charger	1		

After unpacking

Shipping container: Save the boxes and packing in the event your unit needs to be transported for remote operation, maintenance, or service.

5

2. BATTERY PACK

2-1 NiCd BATTERY PACK (PB-6)

This battery pack has not been charged at the factory in order to provide you with the greatest number of charge/discharge cycles. You must charge the battery before use. The battery pack will require several charge/discharge cycles before you can expect to see the maximum operating period between charges. If the battery will be stored for greater than 2 months it should be recharged before use.

2-2 RECHARGING

- Slide the adapter onto the NiCd battery pack.
- Plug the supplied charger into an AC outlet.
- Do not allow the battery to charge for greater than 15 hours.

The useful life and battery performance will be reduced if you exceed the recommended charge period.

Note:

Recharging should be performed within an ambient temperature range of between 5°C - 40°C (41°F - 104°F).

Recharging the battery outside of this range may not allow the battery to reach full charge.

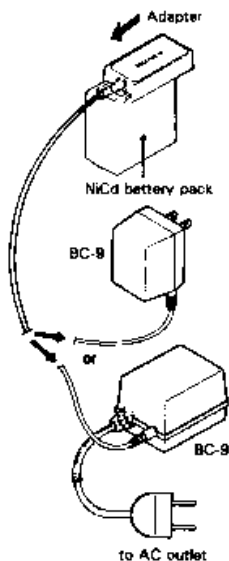

2-3 MANGANESE or ALKALINE BATTERIES (Optional Battery Case BT-6)

Install 6 × R6 (AA) manganese or alkaline batteries in the battery holder. Pay close attention the battery polarities marked in the holder. We recommend the use of high performance manganese batteries for the greatest operating time.

Press down on the hook in the middle of the battery case top to open

Note:

Do not install NiCd batteries and attempt to charge them with the supplied charger. There is no battery protection circuit in the battery holder.

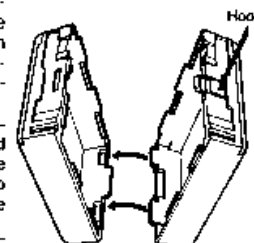

2-4 INSTALLING THE BATTERY PACK

Align the grooves in the battery pack with the transceiver and slide the pack to the right until it locks in place.

To remove the battery pack push up on the release button and slide the pack to the left.

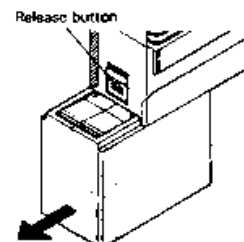

6

2-5 BATTERY VOLTAGE LEVEL METER

The S meter indicates the relative battery voltage during transmit.

Recharge/replace the batteries when the level reaches the low indicator.

NiCd Battery pack

MODEL	V	mAh	Fully charged	Fully discharged
PB-5	7.2	200	████████████████████	████████████████████
PB-6		600	████████████████████	████████████████████
PB-9		1100	████████████████████	████████████████████
PB-7	7.2	600	████████████████████	████████████████████
PB-8	12	600	████████████████████	████████████████████

Manganese or Alkaline batteries (Approximate battery condition)

	New batteries	Need to replace
BT-6, 9 V	████████████████████	████████████████████

2-6 OPERATING TIME

TH-25 series

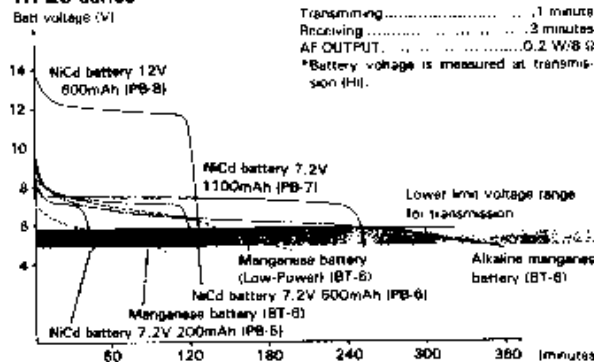

TH-45 series

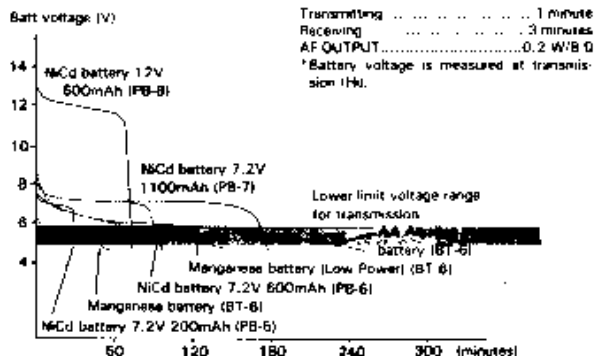

TH-55 series

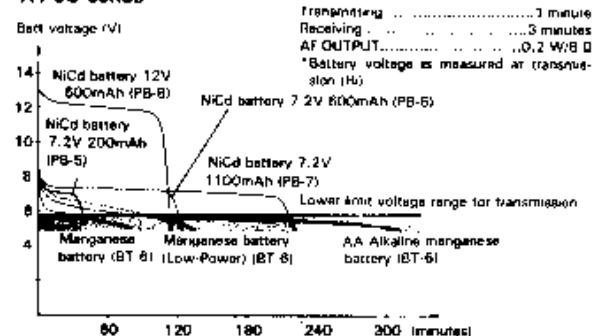

We recommend use of the NiCd battery pack for long transmission or extended operation. Manganese battery (except Alkaline manganese battery) is suitable only for LOW power transmission.

7

3. OPERATION

3-1 OPERATING CONTROLS

① Antenna connector

Connect the antenna that is supplied to this jack. Twist to lock.

② TX indicator

ON whenever the transceiver is in the transmit mode.

③ Volume control/Power switch

The volume control and power switch are combined. Rotating the control clockwise will turn ON the transceiver. Advancing the control further clockwise will increase the volume.

④ SQL control

This control is used to select the desired Squelch threshold level.

⑤ MHz key

This key is used to select the tuning rate of the Tuning control. When the MHz indicator is lit, the Tuning control will cause the transceiver to increase or decrease in 1 MHz step.

⑥ VFO key

This key is used to switch back to VFO operation after operating in the MR (Memory Recall) mode. The tuning control will increase or decrease frequency in accordance with the VFO indicator. See the chart below for your transceiver.

(KHz)

	TH-25A/25AT	TH-25E/45E	TH-45A/45AT	TH-55AT/55E
STEP SIZE	6/10	12.5/5	25/5	25/12.5

Pressing this key for longer than 1 second will initiate the Band Scan function.

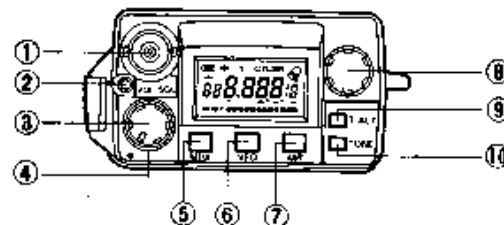

⑦ MR key

This key is used to switch from the VFO mode to the MR (Memory Recall) mode. The tuning control may be used to select the desired memory channel in this mode.

Pressing this key for longer than 1 second will initiate the Memory Scan function.

⑧ Tuning control

Rotate this control clockwise to increase frequency and counterclockwise to decrease the transmit/receive frequency.

This control is also used to select the desired memory channel and the scan direction.

⑨ Tone Alert key

This key is used to activate the Tone Alert function.

⑩ Tone key

U.S. version: This key is used to activate the subaudible tone encoder.

European version: This key is used to transmit a Tone signal. When the key is depressed the repeater control signal of 1750 Hz is activated.

U.K. version: This key is used to activate the 1750 Hz tone burst.

LCD display

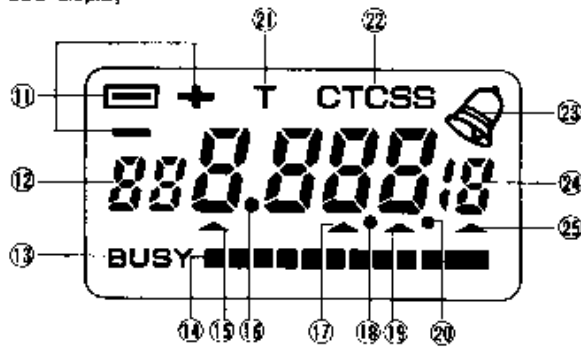

- ⑪ (European version:)
Displays the selected transmitter offset direction. When neither indicator is ON the transceiver is in the Simplex mode. When both indicators are ON the transceiver is in the Split Channel mode. When a indicator flashes the transceiver is in the Reverse function.
- ⑫ **Frequency display**
Displays the operating frequency to the nearest kHz. TH-55AT/55E: Displays the operating frequency from 10 MHz digit.
- ⑬ **Busy indicator**
ON whenever there is a signal present strong enough to open the squelch, or when the squelch is not activated, and the CTCSS key is OFF.
- ⑭
Used to indicate the relative receive signal strength, or as an indication of the battery voltage level during transmit.



- ⑮ **MHz indicator**
This indicator flashes during MHz tuning steps.
- ⑯ **MHz dot**
This indicator flashes during scan operations.
- ⑰ **VFO indicator**
This indicator lights during VFO operation.
- ⑱ **Hz dot**
This indicator lights during CTCSS frequency selection, and is used to show the 1 Hz digit. Additionally ON when the Battery Saver and Automatic Power Off function have been cancelled.
- ⑲ **5 kHz tuning step indicator**
This indicator lights during VFO operation when tuning in 5 kHz steps.
- ⑳ **500 Hz dot (TH-25E/TH-45E only)**
This indicator show 500 Hz.
- ㉑ **T indicator**
This indicator is ON when the Tone function is active.
- ㉒ **CTCSS indicator**
This indicator is ON when the CTCSS function is active.
- ㉓ **T. ALT indicator**
This indicator is ON when the Tone alert system is active. The indicator will flash when a signal is received.
- ㉔ **Memory channel indicator**
This indicator is used to show the selected memory channel number
- ㉕ **Memory indicator**
This indicator lights during Memory Recall mode, and flashes during Memory entry.

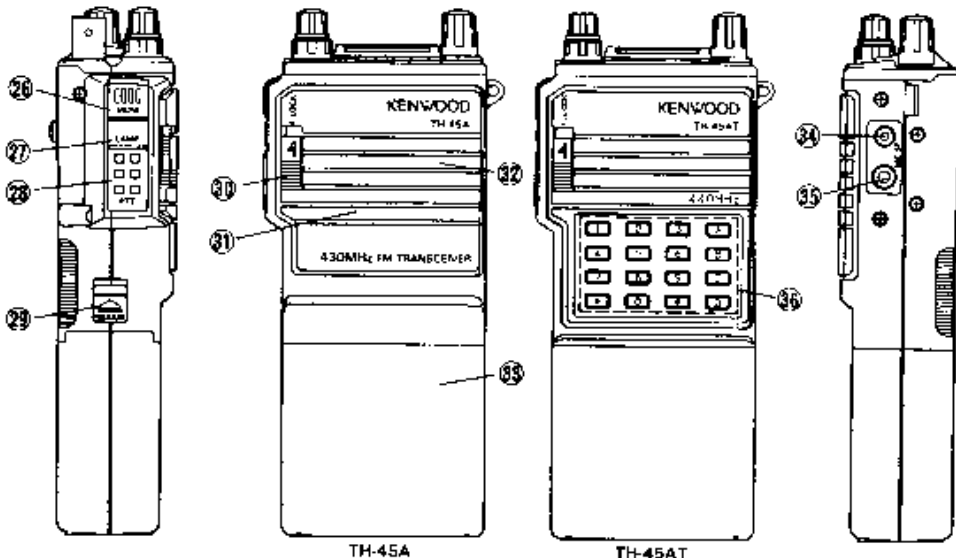

- ㉖ **Release button**
Press this button up to release the battery pack.
- ㉗ **F. Lock key**
This key will deactivate all functions except the Lamp, MONI, PTT functions.
- ㉘ **Speaker**
- ㉙ **Microphone**
- ㉚ **Battery case**
- ㉛ **SP jack**
This jack is used to connect an external speaker or earphone. The recommended impedance is 8 Ω.
- ㉜ **MIC jack**
This jack is used for connection of an external microphone. The use of an electret type microphone is recommended.

- ㉝ **MONITOR switch**
When operating in the CTCSS (Tone Squelch) mode you can use this key to determine if the frequency is in use before transmitting. Pressing this key will disable the CTCSS function as long as the key is held depressed.
- ㉞ **Lamp switch**
This switch is used to control the night lamp on the LCD display. The lamp will turn itself OFF automatically 5 seconds after the last key operation.
- ㉟ **PTT (Push To Talk) switch**
Press this switch whenever you wish to transmit.

Input impedance is 2 kΩ and the DC voltage on this terminal is Approx. 4 V (MAX 3.5 mA).

Note:

The use of a dynamic microphone is not recommended.

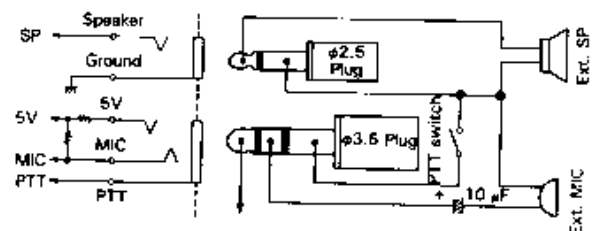

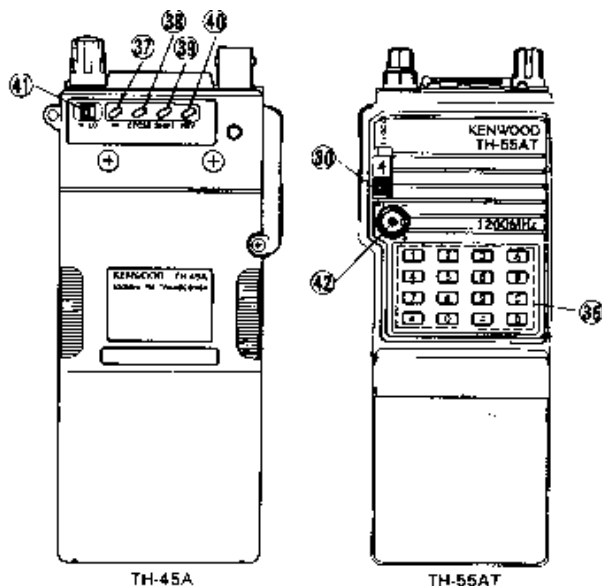

43 DTMF PAD (with the TH-25AT/45AT/55AT)

This key pad is used in conjunction with a repeater to provide AUTOPATCH capabilities

37 M (Memory) key

This key is used to enter a frequency, offset, etc. into the desired Memory channel.
When this key is pressed during Memory channel operation the contents of the Memory channel are duplicated in the VFO, and the transceiver returns to VFO operation.
The contents of the memory are not lost during this procedure.

3-2 RECEIVER OPERATION

Connect the battery pack, and the supplied antenna. Set the controls as follows:

1. Rotate the POWER (VOL) control clockwise to turn the transceiver ON. A frequency will appear in the display.
2. As the VOL control is rotated clockwise either background noise or a QSO will be heard coming from the speaker, provided the CTCSS and Squelch are not ON.
3. To eliminate the no signal noise turn the SQL control clockwise to the point the background noise just disappears. This point is known as the Squelch Threshold point.
4. Select the desired operating frequency using the tuning control.

Frequency Selection

Press the VFO key. An operating frequency will appear in the display.

• VFO Mode

1. Press the VFO key.
2. Turn the tuning control to increase/decrease the frequency. The step size is determined by the location of the VFO indicators (See Step Size Selection below).

• MHz Mode

1. Press the MHz key. The MHz indicator will begin flashing.
2. The tuning control will now increase/decrease the operating frequency in 1 MHz increments.
3. The tuning step will revert to the VFO mode 5 seconds after you stop turning the tuning control.

40 CTCSS key

This key is used to select the CTCSS (Tone squelch) function.

39 SHIFT key

This key is used to select the desired transmitter offset for repeater operation. When the offset function is ON, + or - will be displayed in the display.

44 REV key

Pressing the REV key allows you to reverse the transmit/receive frequencies during repeater operations. This will allow you to check the input of the repeater or to operate on a reverse repeater pair.

41 HI-LO switch

This switch is used to select the transmit output power.

TH-25A/45A SERIES

TH-55AT SERIES



42 RIT control (TH-55AT/55E only)

When the transmit frequency of the distant station drifts a little bit during the QSO, but you do not wish to alter your transmit frequency to compensate, you may wish to make use of the RIT control function. This control allows shifting the receive frequency approximately ± 5 kHz without shifting the transmit frequency.

Step Size Selection

1. Press the VFO key.
2. Press the M key.
3. Within 5 seconds of pressing the M key press the MHz key. The VFO indicator will toggle between 5 kHz and 10 kHz (See the chart below for your transceiver.) each time this sequence is performed.

(kHz)

	TH-25A/25AT	TH-25E/45E	TH-45A/45AT	TH-55AT/55E
STEP SIZE	5/10	12.5/5	25/5	25/12.5

Note:

If you are already in the VFO mode you can skip step number 1.

3-3 TRANSMITTER OPERATION

CAUTION:

Ensure that an antenna with a low standing wave ratio (SWR) is attached to the antenna connector before attempting to transmit. Failure to provide proper termination may result in damage to the final amplifier section. Always check to ensure the frequency is clear before transmitting.

1. Select the desired operating frequency using any of the methods described above.
2. Check the frequency to see if it is occupied before you transmit. If you are using CTCSS (Tone Squelch) press the MONITOR key to allow the Squelch to open.
3. Press the PTT switch. The TX indicator will light.
4. Speak into the microphone. The recommended distance to the microphone is 5 cm (2 inches). Talking closer may result in overdeviation of your transmit signal, and talking too far away may result in reports of weak audio.
5. Release the PTT switch to return to the receive mode. The TX indicator should go out.

3-4 MEMORY

The transceiver provides 14 memory channels. In addition to serving as a normal memory channel some of the memory channels serve a dual purpose to specify other parameters.

- * Memory channel 13 and 14 are used to store both a transmit and a receive frequency for ODD SPLIT operations.

• Memory channel contents

Each memory channel is capable of storing:

- * Frequency
- * CTCSS status
- * Tone status (Excluding European Versions)
- * Tone frequency
- * SHIFT status

3-4-1 AUTOMATIC MEMORY INITIALIZATION

CAUTION:

This procedure will erase all of the current data in memory channels 1 thru 10.

This transceiver can automatically store data in memory channels 1 thru 10 in the following steps.

	TH-25A/25AT	TH-25E	TH-45A/45AT/45E/55AT/55E
MR key	15 kHz	12.5 kHz	25 kHz
VFO key	20 kHz	25 kHz	

This automatic storage will begin from the frequency that appeared in the display before the transceiver was turned OFF.

1. Press and hold either the MR or the VFO key and turn ON the power.
2. Release the MR or the VFO key. The memory channel 1 indicator will be on.
3. Rotate the tuning control to confirm data entry in the remaining channels (2 thru 10).

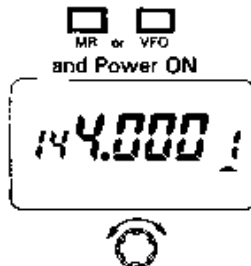

3-4-3 MEMORY SHIFT

It is possible to copy the contents of a memory channel to the VFO without erasing the memory channel.

1. Select the desired Memory Channel. (For example Ch. 12)
2. Press the M key
3. Within 5 seconds press the VFO key to copy the data.

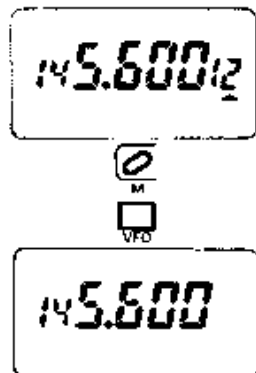

3-4-4 MEMORY RECALL

1. Press the MR key. The memory channel that was active before return to the VFO mode will appear in the display. (For example Ch. 12)
2. Rotate the tuning control until the desired Memory channel number appears in the display. (For example Ch. 5)

Note:

If a channel contains no data it cannot be displayed using this procedure.

3. To return to the VFO mode, press the VFO key.

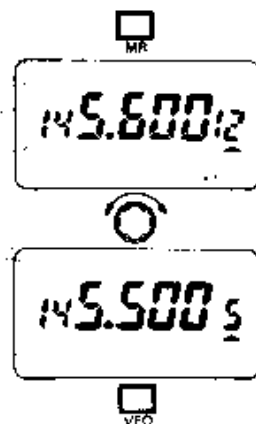

3-4-2 MEMORY ENTRY

1. Select the desired operating frequency, offset, tone frequency, etc. (For example 145.600 MHz)
2. Press the M key to select the Memory Entry Mode.



3. Within 5 seconds of pressing the M key rotate the tuning control until the desired memory channel number appears in the display. (For example Ch. 12)

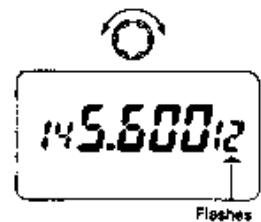

4. Press the MR key within 5 seconds of selecting the Memory channel number. If you do not press the MR key within 5 seconds data will not be stored into memory.



13

3-4-5 ODD SPLIT

Memory channels 13 and 14 store both a transmit and a receive frequency. These channels allow operation on "Odd Split" repeater channels.



• Data entry

1. Select the desired receiver frequency, tone frequency, and tone status. (For example 145.080 MHz)
2. Enter the data into either memory channel 13 or 14 as described previously. (For example Ch. 13)
3. Select the desired transmitter frequency by pressing the VFO key and then rotating the tuning control. (For example 145.300 MHz)
4. Press the M key. Memory channel 13 will appear in the display.

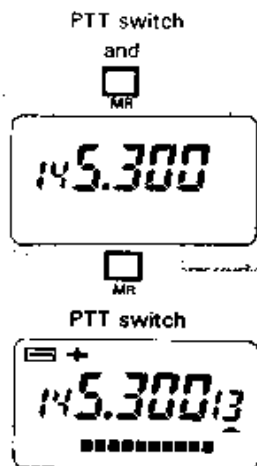

5. Press and hold the PTT key.
6. Press the MR key and then release both keys.



Note:
The PTT switch will not initiate transmit during this operation. The  and  indicators will be on to indicate that this memory channel now contains odd split frequency data.

◆ **Release**

To cancel this Odd Split data simply store a new frequency into the memory channel using the normal memory channel method.

Note:

- Only the receiver frequency will be transferred to the VFO during a Memory Shift operation.
- TH-45A/45AT/55AT: During Odd Split operation the SHIFT key does not work.

3. Select the desired channel number using the tuning control. You will be able to see all channel numbers with this procedure. (For example Ch. 13)

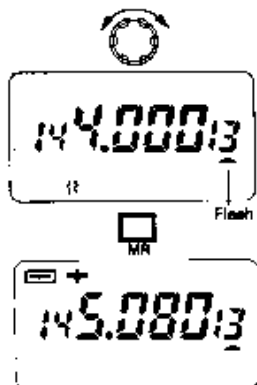

4. Press the MR key within 5 seconds. The Memory channel number will appear in the display.

3-4-7 CLEARING ALL MEMORY (Microprocessor initialization)

To erase the data from all memory channels at the same time you can reset the microprocessor. This will remove any programmed information that you have entered.

1. Turn the Power switch OFF.
2. Press and hold the M key.
3. Turn ON the power switch and then release the M key.
4. The display will show: 144.000 (TH-25A/25AT/25E)
430.000 (TH-45A/45E)
440.000 (TH-45AT)
60.000 (TH-55AT/55E)

3-4-8 MEMORY BACK-UP BATTERY

A lithium battery is contained in the transceiver to retain memory. Turning off the power switch, changing or fully discharging the normal battery will not erase the memory. The battery should last for approx. 5 years. When the battery discharges, an erroneous display may appear in the display. (For the lithium battery replacement, refer to IN CASE OF DIFFICULTY, Page 23)

3-4-6 MEMORY CHANNEL LOCKOUT

The Memory Channel Lockout function allows you to temporarily skip unwanted Memory Channels except Channel 1.

1. Press the MR key and select the memory channel you wish to skip. (For example Ch. 13)

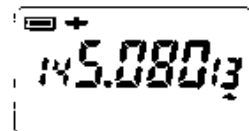

2. Press the M key for longer than 1 second. Both the channel number and the Memory indicator (▲) will flash.

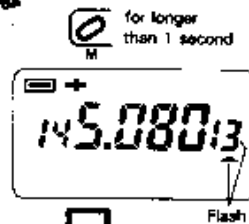

3. Press the MR key within 5 seconds. The selected memory channel number will disappear and the channel number of the next active memory channel will appear. (For example Ch. 1)

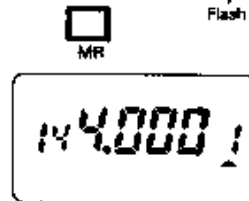

◆ **Release**

1. Press the MR key to select the MR mode.
2. Press the M key for longer than 1 second. Both the channel number and the Memory indicator (▲) will flash.

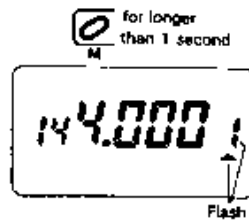

3-5 SCAN

For proper scan operation the squelch must be adjusted to the threshold point. The MHz dot will flash ON and OFF as a visual indication that the transceiver is scanning.

◆ **Scan Modes**

- Band Scan:** Scans the entire band. Pressing the VFO key for longer than 1 second will initiate Scan. The scan step size depends upon the current step programming.
- Memory Channel Scan:** Scans those memories that actually have data and have not been locked out. Pressing the MR key for longer than 1 second will initiate Scan.

◆ **Scan Hold**

Scan will stop on a busy channel and hold for approximately 5 seconds. Scan will resume even if the station is still present. You can manually cause scan to resume by rotating the Tuning control.

◆ **Scan Direction**

Scan will begin in an upwards direction. You can reverse the direction by rotating the Tuning control counter-clockwise.

◆ **Scan Release**

Scan can be released by pressing PTT switch (no transmitting) or any key except the LAMP, or MONI key.

3-6 REPEATER OPERATION

3-6-1 TRANSMITTER OFFSETS

All amateur radio repeaters utilize a separate receiver and transmitter section. The receiver frequency may be either above or below the transmitter frequency.

For most repeaters offsets are as follows:

Model Display	TH-25A TH-25AT TH-25E	TH-45A TH-45AT	TH-45E		TH-55AT	TH-55E
			European version	U.K. version		
➔	+ 800kHz	+ 5MHz		+ 1.6MHz	+ 12MHz	+ 36MHz
◀	- 800kHz	- 5MHz	- 1.6MHz	- 1.6MHz	- 12MHz	- 8MHz
□			- 7.6MHz			

● Offset Direction

To select the desired transmitter offset direction press the SHIFT key. Each time you press the key the transceiver will advance from one offset to the other, i.e. ➔ to ◀ (◀ to □ with TH-45E European version) to no offset (simplex).

The transceiver allows you to store the frequency, offset in memory, or you can select these functions directly from the keyboard.

● Auto-Offset (TH-25AT only)

The TH-25AT has been programmed according to the standard ARRL Band Plan, regarding transmitter offsets. Please see the accompanying chart for additional information. You can, of course, override this by using the SHIFT function, if desired.

144.00	145.10	146.00	146.60	147.40	148.00
S	S	-	S	+	S
S					S

S: Simplex Channel 145.50 146.40 147.00 147.60

● Tone Activation

To activate the TONE function depress the TONE switch on the top of the transceiver. The tone indicator will appear in the display to signify the tone has been activated. To turn the tone OFF press the TONE key again.

Tone frequency selection

1. Press the CTCSS key for longer than 1 second. The current tone frequency will be displayed.
2. Rotate the Tuning control until the desired tone frequency appears in the display.
3. Press the TONE key to turn to the normal frequency display.
4. If CTCSS (Tone Squelch) is not desired press the CTCSS key to cancel the function. The transmit tone will still be active.

Tone Frequency		
67.0 Hz	110.9 Hz	173.8 Hz
71.9 Hz	114.8 Hz	179.9 Hz
74.4 Hz	118.8 Hz	186.2 Hz
77.0 Hz	123.0 Hz	182.8 Hz
79.7 Hz	127.3 Hz	203.5 Hz
82.5 Hz	131.8 Hz	210.7 Hz
85.4 Hz	136.5 Hz	218.1 Hz
88.5 Hz	141.3 Hz	225.7 Hz
91.5 Hz	146.2 Hz	233.6 Hz
94.8 Hz	151.4 Hz	241.6 Hz
100.0 Hz	156.7 Hz	250.3 Hz
103.5 Hz	162.2 Hz	
107.2 Hz	167.9 Hz	

Note:

When no Tone Unit is installed, pressing the TONE key will not transmit a subtone, even if the indicator is ON.

In Europe a 1750 Hz tone is used in transmit. Press and hold the TONE key to transmit the access tone, then press the PTT switch.

In the United Kingdom a 1750 Hz tone burst at the beginning of each transmission is used. Press the Tone key. Since use of this tone is required in the Europe and the United Kingdom, an 1750 Hz tone encoder is included as standard equipment.

3-6-2 REVERSE FUNCTION

Some repeaters utilize a "Reverse pair", i.e. the transmit/receive frequencies are exactly the reverse of another repeater. For example repeater A uses 146.000 for a transmit frequency (OUTPUT) and 146.600 for receive (INPUT). Repeater B uses 146.600 for its receive and 146.000 for its transmit frequency. It would be inconvenient to have to reprogram the transceiver each time if you were in range of both repeaters.

The REV key allows you to reverse the transmit and receive frequencies. To use the REVERSE function press the REV key. The offset indicator (➔ or ◀ / ◀ or □) will flash OFF and ON in the display to remind you that you are working a reverse repeater pair.

To return to normal offsets press the REV key again. This function is also useful to check the input frequency of the repeater, so that you can determine if you are within SIMPLEX communications range.

3-6-3 TONE OPERATION

Some repeaters require the use of a control signal to activate the repeater. Several versions are currently in use worldwide.

In the United States sub-audible tones are sometimes used. With the TH-25A/25AT/45A/45AT/55AT 37 different sub-audible tone frequency selections are possible with the use of the optional sub-audible tone encoder/decoder (TSU-6). This accessory also allows for CTCSS (Tone Squelch) operations. When this option is activated the squelch of the transceiver will only open when the proper sub-audible tone is received.

● CTCSS (Tone Squelch) Operation

1. To activate the CTCSS (tone squelch) function (decode) select the desired tone frequency as described above but do not press the CTCSS key the second time.
2. Squelch will now open only when the transceiver receives the same subtone frequency.
3. To release tone squelch operation press the CTCSS key. The CTCSS indicator should go out.

It is a good operating practice to check the frequency before transmitting. A MONITOR switch has been provided for this purpose when using the CTCSS (tone squelch) function. Pressing this switch will open the squelch so you can check for activity.

● TSU-6 (option) Installation

1. Remove the backing from the cushion (large) that was provided the TSU-6 and attach it to the back of the TSU-6.
2. Remove the Battery Pack and remove the four Phillips head screws from the terminal plate of the transceiver.
3. Turn the terminal plate over and take out the cable as shown in the diagram.
4. Remove the clear tube covering the connector, and the resistor inserted into the connector.

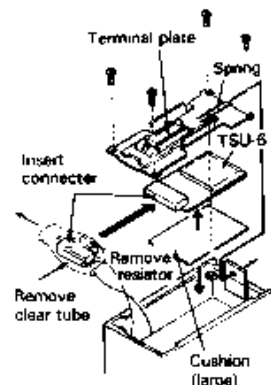

5. Attach the cable from TSU-6 as shown in the diagram.
6. Remove the backing from the other side of the cushion and attach the TSU-6 to the transceiver.

- Push up on the release button and set the terminal plate in the hole of the release button. Replace the terminal plate and tighten the screws to complete the installation. Do not pinch the wiring when closing the terminal plate.

3-6-4 AUTOPATCH

(TH-25AT/45AT/55AT U.S.A. version only)

Some repeaters offer a service known as autopatch. This allows you to dial a telephone number from your transceiver and carry out a telephone conversation, much like a car telephone, or cellular telephone. This function requires the use of a DTMF (Dual Tone Multi Frequency) pad. In addition to the normal 12 keys that are found on your telephone the transceiver also provides 4 additional keys, A, B, C, and D. These keys are required by some repeater systems for various control functions. You should check with the control operator of your repeater to determine if their use is required. A chart is provided that lists the tones that are generated when you press each key.

- To activate the DTMF pad, press and hold the PTT switch.
- Now press the keys just as you would dial a telephone.

Note:

Some repeaters will require a special sequence of keys to activate the Autopatch. Again you should check with the control operator of your repeater for this sequence.

Audio tones		(Hz)			
Column	Row	1209	1336	1477	1633
	697	1	2	3	A
	770	4	5	6	B
	852	7	8	9	C
	941	*	0	#	D

3-7 BEEP TONE

If you would like audio confirmation when a function is activated press the M and then the T.ALT key. The transceiver will then supply audio confirmation according to the chart below. Pressing the same combination again will turn the function OFF.

Scale	Frequency (Hz)	Key operation
A	440.00	CALL, REV. T.ALT, TONE, CTCSS, MHz, M, SCAN OFF
B	493.88	SCAN STOP
C	523.25	VFO MODE SELECTION, MEMORY SHIFT
C#	554.37	- OFFSET
D	587.33	SIMPLEX
D#	622.26	+ OFFSET
E	659.25	MR MODE SELECTION
F	698.46	To complete the MEMORY Entry To complete the CTCSS Frequency selection
G	743.96	CALL, REV. T.ALT, TONE, CTCSS, MHz, M, SCAN ON
G#	783.81	MEMORY CHANNEL selection CTCSS Frequency selection
A	880.00	M, ODD SPLIT
A#	932.33	STEP SIZE selection
B	967.77	AUTOMATIC POWER OFF
F	1396.81	Key operation without effect
	2000	T.ALT alarm

3-8 TONE ALERT SYSTEM

The Tone Alert function will provide an audible "alarm" to signal when someone is transmitting on the frequency you are monitoring.

- Adjust the SQL control to the threshold point.
- If you will be using the TSU-6 for CTCSS decode you should select the desired tone frequency and then press the CTCSS key. Please refer to page 18.
- Press the T.ALT key. The T.ALT indicator will light.
- When a signal is present:
 - The T.ALT indicator will flash.
 - The busy indicator will light.
 - The transceiver will beep ON and OFF for about 5 seconds.

Note:

When using CTCSS the incoming signal must be present for approximately 2 seconds in order for the T.ALT to function properly.

- The T.ALT function can be released by pressing the T.ALT key again, or by pressing the PTT switch while the T.ALT indicator is flashing.

Note:

- The tuning control, PTT switch, and all the keys except MONI, LAMP are not effective during the T.ALT operations.
- During Tone Alert operation the AUTOMATIC POWER OFF function is disabled.

3-9 BATTERY SAVER

The transceiver provides a battery saver mode to conserve on battery power. The transceiver will activate the battery saver circuit 10 seconds after the last key operation with the squelch closed.

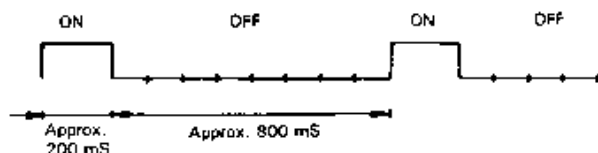

The function will be released by key operation or when squelch opens. The function cannot operate during scan or tone frequency selection.

Note:

It is possible that you might press the MONI switch during the OFF period. Squelch would not open during this period.

3-10 AUTOMATIC POWER OFF

The transceiver also provides an Automatic Power OFF circuit.

The circuit action is described below.

- A 5 second audio confirmation alert will sound after 59 minutes if no signal has been received and if you have not performed any key operation.
- 1 minute after this alert signal the transceiver will shut itself OFF except for enough power to show "PO OFF" in the LCD display.

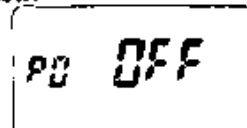

Release

The function can be released by pressing the MONI key or turning the Power switch OFF and back ON.

The function can not be activated during scan or Tone Alert System operation.

Note:

To conserve battery life even more simply turn the transceiver OFF when you are not using it.

3-11 BATTERY SAVER and AUTOMATIC POWER OFF function CANCEL

The Battery Saver and Automatic Power Off functions can be turned Off or On simultaneously or you may turn off the Automatic Power Off function alone. The accompanying chart provides the procedures for both.

	Battery Saver and Automatic Power OFF	Automatic Power OFF
1.	Turn the Power Switch OFF.	
2.	Press and hold the MHz Key.	Press and hold the CTCSS key.
3.	Turn on the Power Switch.	
4.	Release the MHz Key.	Release the CTCSS key.
5.	The Hz dot will light as a visual reminder that the function has been cancelled.	

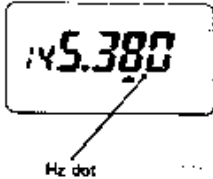

Hz dot

Turning off the Power switch will not erase the status you have just set. The functions can be restored by this procedure.

Note:
These functions cannot be activated during T.ALT system operation or when F.LOCK key is on.

21

5. MAINTENANCE

GENERAL INFORMATION

Your transceiver has been factory aligned and tested to specification before shipment. Under normal circumstances the transceiver will operate in accordance with these operating instructions. All adjustable trimmers and coils in your transceiver has been adjusted at the factory and should only be readjusted by a qualified technician with proper test equipment. Attempting service or alignment without factory authorization can void the transceiver's warranty.

When operated properly, the transceiver will provide many years of service without requiring realignment. The information in this section gives some general service procedures which can be accomplished without sophisticated test equipment.

SERVICE

Should it ever become necessary to return the equipment to your dealer or service center for repair, pack it in its original box and packing, and include a full description of the problems involved. Also include your telephone number. You need not return accessory items unless directly related to the service problem.

Service note:

Dear OM, if you desire to correspond on a technical or operational problem, please make your note short, complete, and to the point, and PLEASE make it readable.

Please list: **Model and serial number.**
The problem you are having.

Please give sufficient detail to diagnose. Information such as other equipment in the station, meter readings and anything else you feel might be useful in attempting diagnosis.

Caution:

Do not pack the equipment in crushed newspapers for shipment. Extensive damage may result during shipment.

Notes:

1. Record the date of purchase, serial number and dealer from whom purchased.
2. For your own information, retain a written record of any maintenance performed on the unit.
3. When claiming warranty service, please include a photocopy of the bill of sale, or other proof of purchase showing the date of sale must accompany the transceiver.

IN CASE OF DIFFICULTY

The problems described in this table are failures caused in general by improper operation or connection of the transceiver, not by defective components. Examine and check according to the following table.

Symptom	Probable cause	Action
Indicators do not light and data is not displayed when power switch is pressed.	a. Low voltage With optional DC cable b. Wrong power polarity. c. Fuse is blown.	a. Recharge/replace the battery. b. Connect red to "+" and black to "-". c. Replace with the specified fuse.
All the indicators go out on the LCD display, or TX indicator does not light. All the indicators flash.	a. Low voltage	a. Recharge/replace the battery.
No sound from the speaker. No signal can be received.	a. Squelch is closed. b. PTT switch is depressed setting the unit in the transmit mode.	a. Turn the SQL control counterclockwise. b. Release the PTT switch.
No control works.	a. LOCK is ON. b. T.ALT key is ON.	a. Place the F.LOCK switch to OFF position. b. Press the T.ALT key.
When rotating the Tuning control after the M key has been pressed, no control works.	a. Nothing is stored in the memory channel.	a. See page 13: MEMORY ENTRY
Memory cannot be backed up.	a. Backup battery voltage is low.	a. Contact the authorized dealer.
(TH-55AT/55E only) The receive tone may become distorted, making it difficult to hear.	a. The transmit frequency of the distant station drifts a little. b. The RIT control is adjusted off the detent position.	a. Adjust the RIT control as required. b. Set the RIT control to the detent (click) position.
(TH-55AT/55E only) No autopatch tone is transmitted even though the PTT switch is depressed and a tone sounds through the speaker.	a. The transmit indicator is not on, even though the PTT switch is depressed. For example: When programming Odd Split data.	a. Ensure the TX indicator is ON.

6. OPTIONAL ACCESSORIES

HS-7
HS-8
RA-3
TSU-6



SMC-31

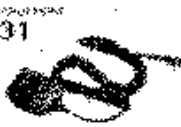

HMC-2

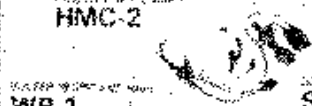

WR-1

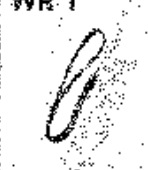

SC-14
for TH-25/45 series
SC-17
for TH-65 series
SC-15
for TH-25/45 series
SC-18
for TH-55 series
SC-16
for TH-25/45 series
SC-19
for TH-55 series
SC-11
for PB-5

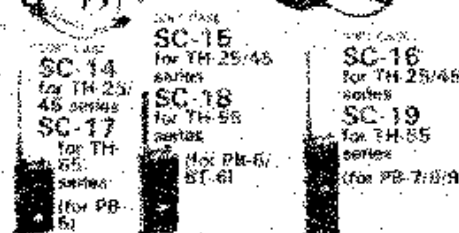

PB-5
7.2V, 200mAh
H: 36.5mm, 80g

PB-6
7.2V, 600mAh
H: 66.5mm, 155g

PB-7
7.2V, 1100mAh
H: 86.5mm, 290g

PB-8
12V, 600mAh
H: 64mm, 250g

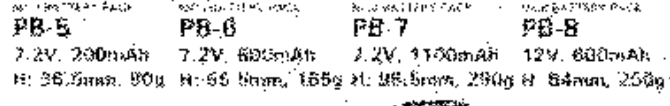

PB-9
7.2V, 600mAh
H: 98.5mm, 280g
(for U.S.A., vertical)

RC-9
(for PB-6/7 only)

BC-10

BC-11

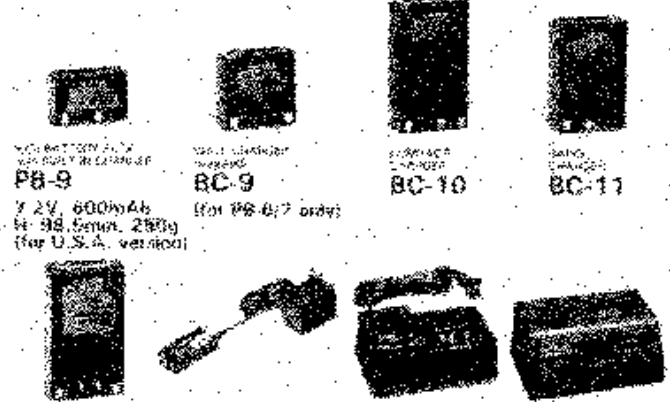

DC-1
and PG-2V

DC-1
and PG-3E

BT-6



RECHARGE- ING TIME	PB-5	PB-6	PB-7	PB-8	PB-9
BC-9	N/A	15	30	N/A	N/A
BC-10	8	8	15	9	8
BC-11	1	1	1	1	1

NOTE: Some optional accessories may not be available in your area.

KENWOOD TH-25AT

Radio Modification

EXPANDED RF

- 1- Disconnect the power and antenna.
- 2- Remove the volume, squelch and tuning control knobs
- 3- Remove the nuts from the volume control and tuning controls.
- 4- Remove screw located by the PTT switch.
- 5- Remove screw by the speaker jack
- 6- Remove two screws from the battery plate.
- 7- Carefully pull the front panel from the radio. Do not break any wires.
- 8- Gently lift top panel from the radio by pulling it toward and then upwards. The O ring on the BNC connector will cause some tension.
- 9- Rotate the top panel towards the front of the radio to expose the 75" x 75" board.
- 10- Remove chip resistor R19, R20, R21.
- 11- Reassemble the radio.
- 12- RESET the CPU. Hold down [M] and turn power ON.

TH-25AT MARS/CAP modification

The following modifications will allow the TH-25AT to transmit from 141.000 to 162.995 MHz. Specifications are guaranteed for the Amateur band only. The transceiver may require realignment of the PLL circuits.

1. Disconnect battery pack and antenna.
2. Remove the volume, squelch and tuning control knobs by pulling them straight up from the top panel.
3. Using a 7mm spanner wrench, remove the nut from the volume control and the nut from the tuning control.
4. Remove one screw from the back of the radio, by the PTT switch.
5. Remove one screw near the speaker jack.
6. Remove two screws from the battery terminal plate:

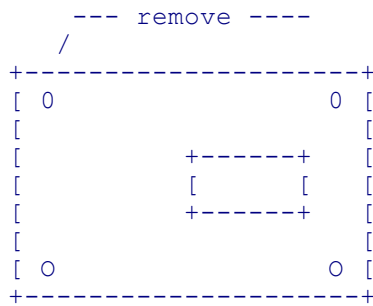

7. Carefully pull the front panel up from the transceiver (do not break the wires connected between the front panel and the body of the transceiver). Lay the front panel to the side of the transceiver (keep track of the PTT and F.LOCK covers if they come off).
8. Gently lift the top panel from the transceiver by pulling it forward and then up (the O-ring on the BNC connector will produce some tension).
9. Rotate the top panel toward the front of the radio to expose the 3/4 x 3/4" board.
10. Using a 45 watt (or less) soldering iron that has an isolated or grounded tip, unsolder and remove chip resistors R19, R20 and R21 from the control unit (X53-3080-02).
11. Carefully reassemble the transceiver by reversing steps 1-9. Pull the BNC connector O-ring up a little before installing the top panel.
12. Reset the microprocessor by following the procedure in the instruction manual (p. 16) called CLEARING ALL MEMORY.

Disclaimers:

The source of this information is unknown and not personally verified. It is illegal to transmit outside the ham bands with this equipment.

KENWOOD TH-25/45 out of band modifications

Here are some mods for the TH-25AT and the TH-45AT. Please note that I do not encourage transmitting on a frequency for which you do not have a license, nor do I encourage transmitting on a non-amateur frequency without FCC type accepted equipment (in the United States).

First let me recommend that you buy the service manuals for these radios. The service manual is not expensive (about \$15 I think) and it will greatly help you in performing these modifications.

Look at the schematic for your radio. In the lower left hand corner is an IC labeled IC2. This is an ASIC microprocessor. At the lower right hand corner of this uP are several diodes and pull-up/pull-down resistors. They are D4, D3, R19, R18, R28, R20, R21, R22, R25, R26, and a couple of resistors that are not even on the schematic that attach to B2 (pin 51 on IC2) and B3 (pin 50 on IC2). The TH-45AT schematic shows R23 on the ASIC uP pin B2.

The schematic for the TH-25AT shows:

			R18-R21	R25	R26, 27	R28	R36
TH-25A	M, M2	-12	O	X	X	X	X
TH-25A	M3, M4, X	-23	O	X	X	O	X
TH-25AT	K	-11	O	O	X	X	X
TH-25AT	M, M2	-12	O	X	X	X	X
TH-25E	T	-52	X	X	O	O	O
TH-25E	W	-62	X	O	O	O	O

And the schematic for the TH-45AT shows:

			R19-R21	R22	R23	R25	R26, 27	R28	R36
TH-45A	M1, M2, X	-21	O	O	O	X	X	O	X
TH-45A	M3, M4	-22	O	X	O	X	X	X	X
TH-45AT	K	-10	O	X	O	X	X	O	X
TH-45AT	M1, M2	-21	O	O	O	X	X	O	X
TH-45AT	M3, M4	-22	O	X	O	X	X	X	X
TH-45E	T	-51	X	O	X	X	O	X	O
TH-45E	W	-61	X	O	X	O	O	O	O

where O means USED, and X means NOT USED.

On the TH-25AT:
(All frequencies given in MHz.)

R22 in
R28 out

This is how the radio is delivered in the USA. TX 144-1, 141-163
(I think).

R22 out
R28 in

The radio tunes from 142-151. This may be the modification given to US MARS members. I don't remember where the unit will transmit. It may or may not transmit outside the range from 144-148.

R22 in
R28 in

The radio tunes only from 144-148.

R22 out
R28 out

Frequencies may be selected from 100-200 MHz (on the display only - your PLL will not lock up in this entire range). In addition, TX is possible where your PLL locks up.

R25 out

Removing R25 disables automatic offset selection.

R23 and R24 are used for selecting the step size for tuning. I can't remember which positions are for which

step sizes, and alas I didn't write down what I found. If you want to play with this, go ahead.

On the TH-45AT:

(All frequencies are given in MHz.)

R18 in

R28 in

This is how the radio is delivered in the USA. The radio covers 438-450 MHz.

R18 in

R20 out

The radio is prohibited from tuning outside 440-450 MHz.

R18 out

R28 in

The radio will only tune from 215-230 MHz. Note that the PLL would not lock up! (What did you expect?) Could it be possible that Kenwood originally planned a 220 version of this radio, but then scrapped their plans?

R18 out

R28 out

The radio will tune from 200-500 MHz (on the display only - your PLL will not lock up over this entire range). Transmitting is possible anywhere your PLL will lock up.

Some of the above codes are:

- K USA
- T England
- X Australia
- M Other Areas

These components are found on the flexible circuit board under the display. To get to them, take the radio apart. Some unsoldering of obvious grounding wires may be necessary. You will see where the flexible circuit board plugs into a socket on the main circuit board.

Before unplugging it, make sure you know what's in the memories, because they will be lost. Unplug the flexible circuit board and unfold it so that the components are accessible. One of the fold-out parts of the flexible board will look something like this:

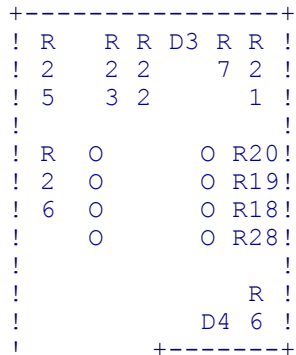

The O's are solder pads.

!
!
!
!

The fold out board is actually square, but with only characters for graphics, I couldn't draw it that way. On both radios, R36 is for the European tone burst to "whistle up" repeaters. On both radios, D4 is for selecting the type of display. With D4 in, the display is normal. With D4 removed, the display is a channel display. D3 is for selecting VHF or UHF. With D4 in, the radio thinks its a VHF radio. With D4 removed, the radio thinks its a UHF radio. Don't change this on your radio.

I have found a quick and easy way to retune your PLL (in the TH45-AT) with a minimum of test equipment. All you need is a scope and a small tuning tool. First, take off the battery pack holder plate. Then, remove the silvery sticker covering the tuning pot access holes. If the radio is positioned on its back, with the top folded over so that the touch tone pad is also facing down, the test point you want (TP1) is on the bottom half of the radio, near the center (left to right), and close to the battery; the tuning pot you want (TC1) is on the bottom, and closest to the PTT switch. Under no circumstances change the tuning of TC51. This is used to calibrate the output of the radio with the display the radio is giving; you don't want to mess with it. Once again, the Service Manual makes it very clear where these points are, if you are having trouble with my descriptions. On with retuning the PLL. With the radio on, and receiving, monitor the voltage and the waveform on test point TC1.

Tune the radio DOWNWARDS in frequency until the PLL unlocks. Note that the radio will beep when this happens, and the waveform on TP1 will change. Tune the radio about 1 MHz higher so that the PLL locks up again, and note the voltage on the test point, TP1. Now, tune the radio to the LOWEST frequency that you want to be able to receive. Adjust TC1 until the voltage on the test point TP1 is the same as what was noted earlier. Button the radio back up, and you're done. You will not be able to tune the PLL to any range you want. There are limits. On my radio, I have been able to retune the radio so that I can receive from 439.2-468.6 MHz with a set of batteries fresh out of the charger. The tuning range will probably diminish as the battery voltage decreases. I have not retuned the PLL on my 2m HT, but I'd imagine the same technique will prove fruitful.

TH-25/45AT Automatic Power OFF Function
--

Some users of the TH-25AT/45AT have expressed a desire to defeat the automatic power off function. The following modification will explain how to do this. It should be noted that this modification does not effect the battery saver function.

Required Part:
Diode Kenwood Part #1SS133

1. Disconnect the battery pack and antenna.

2. Remove the Volume, Squelch, and Tuning Control knobs by pulling them straight up from the top panel.
3. Using a 7mm spanner wrench, remove the nut from the volume control and the nut from the tuning control.
4. Remove one screw located by the PTT switch. (Figure 1).
5. Remove one screw located by the speaker jack. (Figure 2).
6. Remove two screws from the battery terminal plate. (Figure 3).
7. Carefully pull the front panel up from the transceiver (do not break the wires connected between the front panel and the body of the transceiver.) Lay the front panel to the side of the transceiver (Keep track of the F.LOCK cover if it comes off.)
8. Remove the PTT cover.
9. Remove one screw from the PTT switch unit. (Figure 4).
10. Gently lift the top panel from the transceiver by pulling it forward and then up (the O ring on the BNC connector will produce some tension.)
11. Carefully unfold the flex Printed Circuit Board (PCB) to expose IC2. (Figure 5).
12. Using a 45 watt (or less) soldering iron that has an isolated or grounded tip, add a diode between pins 23 and 58 of IC2. (Figure 6).
13. Carefully assemble the transceiver by reversing step 1-11. Pull the BNC connector "O" ring up a little before installing the top panel.
14. Reset the microprocessor by following the procedure in the instruction manual (page 16) called CLEARING ALL MEMORY.

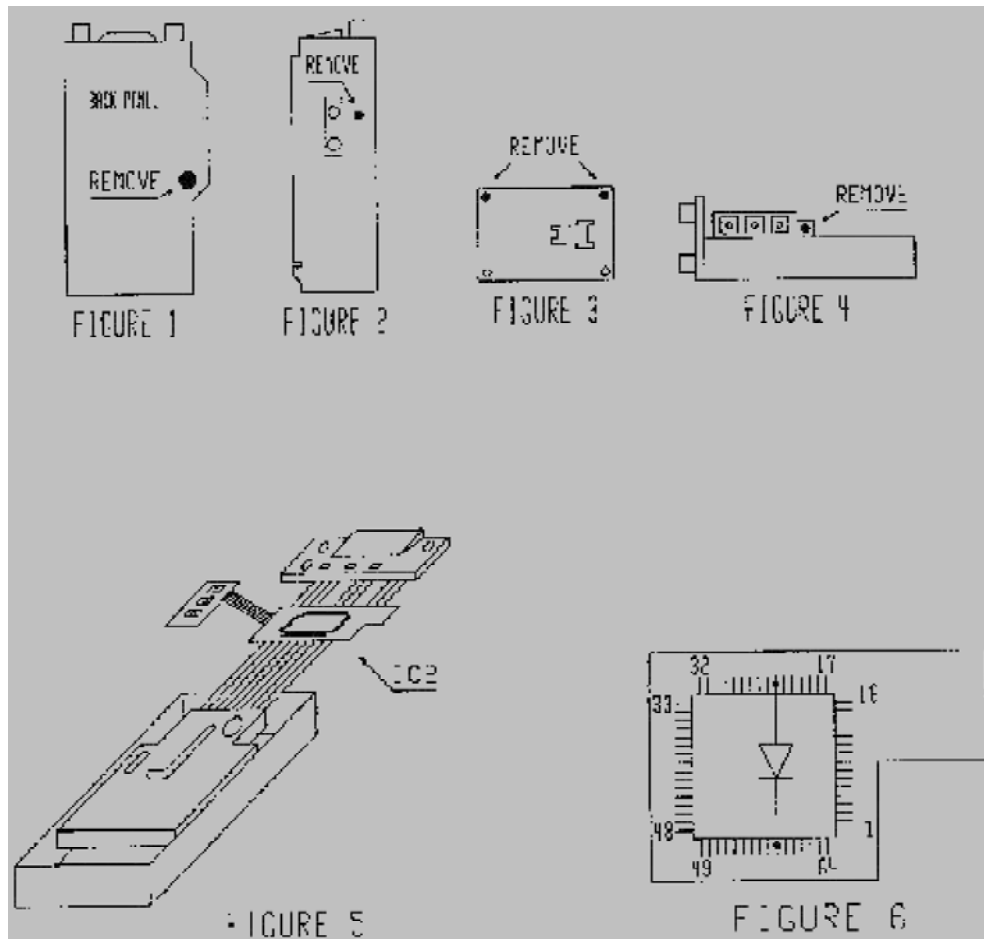

This is an optional change that is not covered under warranty.
 Time required for this modification is 1 hour or less.

SYSOP NOTES:

Later versions of the TH-25/45AT came with a programmable defeat for the Auto power off function. Do not install this modification if your manual provides a procedure for turning the power off function off! Step 11 tells you to carefully unfold the flexible pc board. It is extremely important that you do not try and bend the board in a direction that is opposite from its current bend. To do so will break the board or the foil traces inside the board!

EXT TX ON THE: TH-26AT/TH-45AT/TH-75A HT's

On the three above units a jumper wire controls the TX frequency coverage. By removing the jumper you will extend TX from 142-152Mhz.

By removing a diode you can extend the TX coverage to the limits of the VCO. Both the jumper wire and the diode are located on the "CONTROL UNIT".

On the TH-26AT this is just a bare jumper wire, TH-45AT ???, TH75A it is a green wire labeled W1. Removing or lifting D4 on the TH-75A extends TX from 136-174Mhz and 335-512Mhz. On the TH-26/TH-46 models this would be 136-174Mhz and 335-512Mhz respectively.

TH-25/45 W/TSU-6 Tone alert improvements

When using the TH-25/45 in combination with the TSU-6 you may experience erratic operation of the tone alert function. This may be due to an incoming signal that is over-modulated, distorted, or noisy. The following modification will correct this tendency.

Required parts:

22 μ F, 6.3V electrolytic capacitor	part # CE04CW0J220J
56 Kohm, 1/8 watt carbon resistor	part # RD14BB2B563J
Diode	part # 1SS133

1. Remove the TSU-6 from the TH-25/45 (refer to the TH-25/45 instruction manual for details).
2. Cut the blue wire (pin # 4) approximately 5 mm from the connector for the TSU-6.
3. Solder the components to the blue wire and ground as shown in figure 1. Note that the cathode side of the diode goes toward the TSU-6 connector. Use the leg of the VCO shield to ground the negative side of the capacitor.
4. Insulate the components with electrical tape to prevent shorting.
5. Install the TSU-6 in the TH-25/45. Route the components so that the battery terminal plate does not bow when installed.

Figure 1.

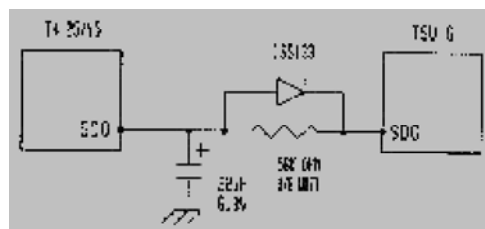

This modification may be covered under warranty.
Time required for this modification is ½ hour or less.