

KENWOOD

144/440 MHz FM DUAL BANDER

TH-79A

144/430 MHz FM DUAL BANDER

TH-79A

144/430 MHz FM DUAL BANDER

TH-79E



---

# INSTRUCTION MANUAL

KENWOOD CORPORATION

©PRINTED IN JAPAN B62-0423-30(K,P,E,M)(A)  
09 08

### Models Covered by this Manual:

- **TH-79A:** 144/440 MHz FM Dual Bander (U.S.A./ Canada)
- **TH-79A:** 144/430 MHz FM Dual Bander (General)
- **TH-79E:** 144/430 MHz FM Dual Bander (Europe)

The TH-79A (U.S.A./ Canada) is used for all LCD example displays.

### Notice to the user:



**ATTENTION(U.S.A.Only):**  
*Nickel-Cadmium batteries must be recycled or disposed of properly.  
State laws may vary regarding the handling and disposal of Nickel-Cadmium batteries.  
Please contact your Authorized KENWOOD Dealer for more information.*

One or more of the following statements may be applicable to this equipment.

#### **FCC WARNING**

*This equipment generates or uses radio frequency energy. Changes or modifications to this equipment may cause harmful interference unless the modifications are expressly approved in the instruction manual. The user could lose the authority to operate this equipment if an unauthorized change or modification is made.*

#### **INFORMATION TO THE DIGITAL DEVICE USER REQUIRED BY THE FCC**

*This equipment has been tested and found to comply with the limits for a Class B digital device, pursuant to Part 15 of the FCC Rules. These limits are designed to provide reasonable protection against harmful interference in a residential installation.*

*This equipment generates, uses and can generate radio frequency energy and, if not installed and used in accordance with the instructions, may cause harmful interference to radio communications. However, there is no guarantee that the interference will not occur in a particular installation. If this equipment does cause harmful interference to radio or television reception, which can be determined by turning the equipment off and on, the user is encouraged to try to correct the interference by one or more of the following measures:*

- *Reorient or relocate the receiving antenna.*
- *Increase the separation between the equipment and receiver.*
- *Connect the equipment to an outlet on a circuit different from that to which the receiver is connected.*
- *Consult the dealer for technical assistance.*

## THANK YOU

We are grateful you decided to purchase this **KENWOOD** FM Dual Bander. The TH-79 series of dual banders were developed to satisfy the requirement for a compact handheld that's simple to operate yet contains numerous sophisticated features. The innovative Menu System combined with the Display Help Guide make this dual bander user-friendly from the moment you switch it on.

**KENWOOD** believes you will be pleased with this product's quality and features.

## PRECAUTIONS

Please observe the following precautions to prevent fire, personal injury, and dual bander damage:

- Do not transmit with high output power for extended periods. The dual bander may overheat.
- When using a regulated power supply, connect the recommended DC cable (option) to the DC jack on the dual bander. The supply voltage must be between 5.5 V and 16 V to prevent damaging the dual bander.
- If input voltage exceeds approximately 18 V, an alarm message appears on the Display.
- When connecting the dual bander to a cigarette lighter socket in a mobile, use the recommended cigarette lighter cable (option).

- Before recharging a mobile battery, unplug the cigarette lighter cable from the lighter socket. Voltage spikes sometimes present during charging can damage the dual bander.
- Do not recharge the NiCd battery pack for more than 15 hours (PB-33: 30 hours) with an external power supply. Switching ON the power supply begins recharging the battery pack automatically.
- Do not expose the dual bander to long periods of direct sunlight or place the dual bander close to heating appliances.
- Do not place the dual bander in excessively dusty or humid areas, or on unstable surfaces.
- If an abnormal odor or smoke is detected coming from the dual bander, turn OFF the power immediately. When using a regulated power supply, also remove the DC cable from the dual bander. Contact a **KENWOOD** service station or your dealer.
- Do not modify this dual bander unless instructed by this manual or by some other approved **KENWOOD** communication.

### CAUTION:

- ◆ *The recommended duty cycle is 1 minute of transmission and 3 minutes of reception. Longer transmissions or extended operation in the High power mode may cause the back of the dual bander to get hot. Do not place the dual bander where the heat sink (rear panel) might come in contact with plastic or vinyl surfaces.*
- ◆ *Transmitting with the supplied antenna near other electronic equipment can interfere with that equipment. Also, transmitting near a regulated power supply that is not recommended by **KENWOOD** may cause the power supply to output an extremely high voltage. This voltage could damage both your transceiver and any other equipment connected to the supply.*

## CONTENTS

FEATURES .....	1	Audio Separation .....	14
ACCESSORIES .....	1	BAND SELECT .....	15
CONVENTIONS FOLLOWED IN THIS MANUAL .....	2	VHF/VHF Configuration .....	15
Guide Function Identification .....	2	UHF/UHF Configuration .....	15
Key Stroke Conventions .....	2	SINGLE BAND MODE .....	16
BATTERY INFORMATION .....	3	SQUELCH ADJUST .....	16
NiCd BATTERY PACK (PB-32/PB-34) .....	3	SELECTING FREQUENCIES .....	17
Recharging .....	3	ENC Control .....	17
Installing/Removing the Battery Pack .....	3	Keypad Direct Frequency Entry .....	17
INSTALLING/REMOVING ALKALINE OR		PROGRAMMABLE VFO .....	18
MANGANESE BATTERIES		SELECTING FREQUENCY STEP SIZE .....	19
(SOME GENERAL VERSIONS) .....	4	1 MHz Frequency Step .....	20
BATTERY VOLTAGE LEVEL .....	5	Changes in Displayed Frequencies .....	20
BATTERY OPERATING TIME (HOURS) .....	5	TRANSMITTING .....	21
GETTING ACQUAINTED .....	6	SELECTING OUTPUT POWER .....	21
PHYSICAL LAYOUT .....	7	PTT SWITCH .....	21
FUNCTION KEYS AND DTMF KEYPAD .....	8	TRANSMIT INHIBIT .....	22
DISPLAY .....	10	TIME-OUT TIMER (TOT) .....	22
MENU SETUP .....	11	MEMORY CHANNELS .....	23
GUIDE FUNCTION .....	11	STORING DATA IN MEMORY .....	23
MENU FUNCTIONS .....	12	Simplex Memory Channels .....	23
GUIDE INDEX .....	13	Split Memory Channels .....	24
STATUS DISPLAY .....	13	RECALLING MEMORY CHANNELS .....	24
RECEIVING .....	14	Using the ENC Control .....	24
SWITCHING POWER ON/OFF .....	14	Using the Keypad .....	24
VOLUME ADJUST .....	14	MEMORY → VFO TRANSFERS .....	25
		ERASING MEMORY CHANNEL DATA .....	25

MEMORY CHANNEL IDS .....	26	Storing DTMF Numbers for the	
Storing IDs.....	26	Automatic Dialer.....	35
Character Library.....	26	Confirming Stored DTMF Numbers.....	36
Confirming ID/Frequency Pairings .....	27	Storing DTMF Memory IDs .....	37
Erasing IDs.....	27	Transmitting Stored DTMF Numbers	
CALL CHANNEL		(Automatic Dialer) .....	38
(EXCLUDING EUROPEAN VERSIONS) .....	28	Autopatch (U.S.A. and Canada) .....	38
Recalling the Call Channel .....	28	SCAN .....	39
Changing Call Channel Contents (Simplex) ...	28	SCAN RESUME METHODS.....	39
Changing Call Channel Contents (Split).....	28	Time-Operated Scan .....	39
CLONE (U.S.A. ONLY) .....	29	Carrier-Operated Scan.....	39
CHANNEL DISPLAY FUNCTION .....	29	SELECTING SCAN RESUME METHOD .....	40
INITIALIZING MEMORY.....	30	MEMORY SCAN .....	40
VFO Reset (Partial Reset).....	30	BAND SCAN .....	41
All Reset (Full Reset).....	30	PROGRAM SCAN.....	41
OPERATING THROUGH REPEATERS .....	31	Setting Scan Limits – VHF Band.....	41
TRANSMITTER OFFSETS (SHIFT).....	31	Setting Scan Limits – UHF Band.....	41
SELECTING OFFSET DIRECTION .....	31	Confirming the Programmable Limits.....	42
AUTOMATIC TRANSMIT OFFSET .....	32	Using Program Scan .....	42
U.S.A. and Canada Versions .....	32	MHz SCAN.....	42
European Versions.....	32	AUXILIARY FUNCTIONS .....	43
Canceling Automatic Offset.....	32	BATTERY SAVER .....	43
SELECTING OFFSET VALUES MANUALLY .....	33	AUTOMATIC POWER OFF (APO) .....	43
REVERSE FUNCTION.....	33	AUTOMATIC BAND CHANGE (A.B.C.).....	44
TONE FUNCTION .....	34	KEY LOCK .....	44
Selecting Tone Frequencies.....	34	ENC Lock Release.....	44
Using the Tone Function .....	34	BEEP TONE .....	45
DUAL TONE MULTI-FREQUENCY (DTMF)		FULL DUPLEX .....	45
FUNCTIONS.....	35	DISPLAY DEMONSTRATION MODE	
Making DTMF Calls.....	35	(SHOW-OFF MODE) .....	45
Activating DTMF Transmit Hold .....	35		

POWER-ON MESSAGE.....	46	CONNECTING EQUIPMENT FOR REMOTE CONTROL .....	56
LAMP FUNCTION .....	46	MAINTENANCE.....	58
CONTINUOUS TONE CODED SQUELCH SYSTEM (CTCSS) .....	47	SERVICE NOTE .....	58
SELECTING CTCSS FREQUENCIES .....	47	TROUBLESHOOTING .....	59
USING CTCSS .....	47	OPTIONAL ACCESSORIES .....	63
DUAL TONE SQUELCH SYSTEM (DTSS).....	48	INSTALLING OPTIONS .....	65
USING DTSS .....	48	INSTALLING THE TSU-8 CTCSS UNIT (TH-79A(GENERAL), TH-79E) .....	65
DTSS AND REPEATERS .....	49	REMOVING THE TSU-8 CTCSS UNIT .....	65
PAGE .....	50	CONNECTING AN EXTERNAL POWER SOURCE .....	66
OVERVIEW .....	50	Using a Regulated Power Supply .....	66
PAGE CODE MEMORY .....	50	Using a Cigarette Lighter Socket .....	66
STORING PAGE CODES .....	51	CONNECTING OTHER EXTERNAL EQUIPMENT .....	66
CALLING .....	51	SPECIFICATIONS .....	67
RECEIVING.....	52		
Receiving a Call with your Station Code .....	52		
Receiving a Call with a Group Code .....	52		
LOCKING OUT CODES .....	53		
AUTO PAGE CANCEL.....	53		
PAGE ANSWER BACK.....	54		
PAGE CODE AND REPEATERS .....	54		
TONE ALERT.....	55		
ACTIVATING TONE ALERT .....	55		
REMOTE CONTROL.....	56		
REASSIGNING THE PF KEYS .....	56		

*Note: See page 9 for a rapid-find function key index.*

## FEATURES

- Full-featured, dual band transceiver capable of simultaneous receive on both bands using a VHF/UHF, VHF/VHF, or UHF/UHF configuration.
- Introduces a new generation of user friendliness with detailed operator instructions that scroll across the liquid crystal display and an intuitive Menu system for function configuration.
- Presents a full summary report of important settings via a single keypad command.
- Accepts an alphanumeric ID such as a callsign, name, location, etc., for each of the 80 memory channels. You create your own personalized IDs using an extensive built-in character library.
- Pocket sized dimensions and light weight are combined in a slim package that's truly portable.
- Includes Full Duplex for split-band contacts with simultaneous transmit and receive allowing "telephone-style" conversations.

## ACCESSORIES

Accessory	Part Number	Quantity
Antenna		
U.S.A./Canada	T90-0603-XX	1
Europe/General	T90-0483-XX	1
Hand strap	J69-0327-XX	1
Belt hook	J29-0465-XX	1
NiCd battery pack		
PB-32 <sup>1</sup> (6 V, 600 mAh)	W09-0826-XX	1
PB-34 <sup>2</sup> (9.6 V, 600 mAh)	W09-0825-XX	1
Battery case (BT-9) <sup>2</sup>	--	1
Battery charger (BC-17)		
U.S.A./Canada	W08-0437-XX	1
Europe (excluding U.K.)	W08-0440-XX	1
United Kingdom	W08-0438-XX	1
General	W08-0441-XX	1
AC plug adapter <sup>2</sup>	E19-0254-XX	1
Warranty card		
U.S.A./Canada, Europe	--	1
Instruction manual	B62-0423-XX	1

<sup>1</sup> Excluding some General market versions.

<sup>2</sup> Some General market versions only.

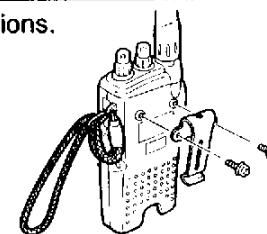

## CONVENTIONS FOLLOWED IN THIS MANUAL

The writing conventions described below have been followed to simplify instructions and avoid unnecessary repetition. This format is less confusing for the reader. Reviewing the following information now will reduce your learning period. That means less time will be spent reading this manual; more time will be available for operating.

Several of the keys have multiple functions and, therefore, more than one key label. Procedures in this manual use the key label that applies to the procedure being executed. For example, when selecting the Reverse function, the procedure refers to the **[REV]** key. When using the same key for the Frequency Step function, the procedure refers to the **[STEP]** key.

### Note:

- ◆ *Basic procedures are numbered sequentially to guide you step-by-step. Additional information pertaining to a step, but not essential to complete the procedure, is provided in bulleted form following many steps for further guidance.*
- ◆ *Most procedures require that you enter a final key stroke that acts as a terminator for the procedure. You can, if you prefer, wait for approximately 10 seconds rather than make this final entry.*

## ■ Guide Function Identification

### GUIDE FUNCTION

- The Section Title is shaded as shown above for functions included in the Guide (Help) Menu on the dual bander.

## ■ Key Stroke Conventions

Instruction	What To Do
Press <b>[KEY]</b> .	Press and release <b>KEY</b> .
Press <b>[KEY1]+[KEY2]</b> .	Press and hold <b>KEY1</b> down, then press <b>KEY2</b> .
Press <b>[KEY1], [KEY2]</b> .	Press <b>KEY1</b> momentarily, release <b>KEY1</b> , then press <b>KEY2</b> .
Press <b>[KEY]+ POWER ON</b> .	With dual bander power OFF, press and hold <b>KEY</b> , then switch ON the dual bander power.
Press <b>[KEY1]+[KEY2]+ POWER ON</b> .	With the dual bander power OFF, press and hold both <b>KEY1</b> and <b>KEY2</b> down, then switch ON the dual bander power.
Press <b>[KEY] (1 s)</b> .	Press and hold <b>KEY</b> until the function begins.



## BATTERY INFORMATION

### NiCd BATTERY PACK (PB-32/PB-34)

You must charge the battery pack before using it with the dual bander. The pack is delivered uncharged to provide you with the greatest number of charge/discharge cycles. It takes several charge/discharge cycles before achieving the full battery pack capacity. After storing the pack for more than 2 months, recharge it before use.

#### ■ Recharging

Insert the plug from the charger into the DC jack on the right side of the dual bander. Then plug the charger AC plug into an AC wall outlet. Do not charge the battery for more than 15 hours. Exceeding the recommended charge period shortens the useful life of the pack and adversely affects battery performance.

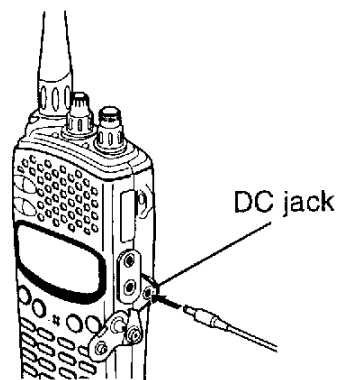

#### Note:

- ◆ Recharging should be done within an ambient temperature between 5°C to 40°C (41°F to 104°F). Recharging outside this range may not fully charge the battery.
- ◆ If the entire display is blinking, or if turning **PWR/VOL** clockwise does not power the dual bander, recharge the battery pack.
- ◆ The BC-17 charger is designed to recharge only PB-32, PB-34, PB-30 (option), or PB-33 (option). Never use the BC-17 to recharge other types of battery packs.

#### ■ Installing/Removing the Battery Pack

**WARNING!** Do not install the battery pack in a hazardous environment where sparks could cause an explosion.

Insert the battery pack into the bottom of the dual bander, and push in until the tab on the pack locks in place.

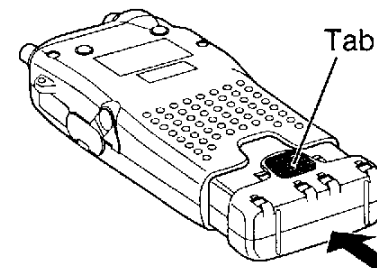

To remove the battery pack, simultaneously press the tab on the back of the pack while pulling out the pack from the dual bander.

## INSTALLING/REMOVING ALKALINE OR MANGANESE BATTERIES (SOME GENERAL VERSIONS)

**WARNING!** Do not install the batteries in a hazardous environment where sparks could cause an explosion.

It is preferable to use high quality alkaline batteries rather than manganese batteries. If manganese or alkaline batteries are used, it's recommended that transmissions be made only with the "LO" or "EL" transmitter output power.

- 1 To remove the battery case, simultaneously press the tab on the back of the case while pulling out the case from the dual bander.

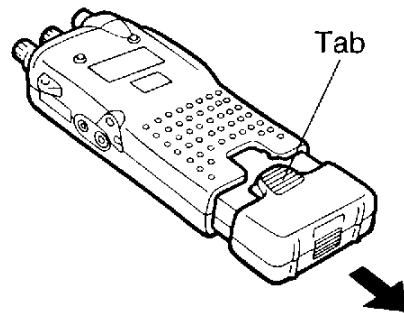

- 2 Open the battery case by simultaneously pressing on the locking tab on the bottom of the case while pulling the two case halves apart.

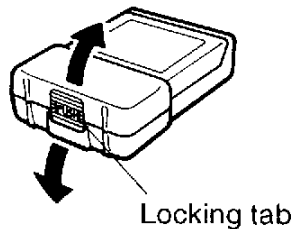

- 3 Insert four AA (LR 6) alkaline or manganese batteries in the case half with metal contacts making sure the + and - end of each battery is as shown.

- If replacing batteries, remove the old batteries first by lifting up on each battery end.

**WARNING!** Never discard old batteries in fire as extremely high temperatures can cause batteries to explode.

- 4 Insert the two small alignment tabs on the other half of the case into their matching holes in the case half containing the batteries. Press the case halves together until the tab on the case bottom locks in place.

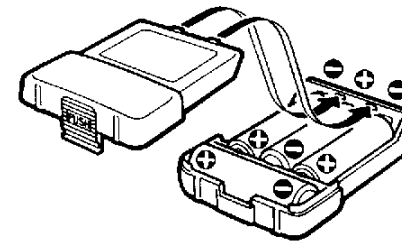

- 5 Insert the battery case into the bottom of the dual bander, and push in until the tab on the case locks in place.

### CAUTION:

- ◆ Install only alkaline or manganese batteries in the battery case. Attempting to recharge NiCd batteries that are installed in the battery case may damage the battery case as a result of contact heating.
- ◆ Remove the batteries from the battery case if your dual bander will not be used for a long time.

## BATTERY VOLTAGE LEVEL

The horizontal bars on the Display show the relative battery voltage while transmitting using "EL" output power. Recharge or replace the batteries as necessary using the accompanying diagrams as reference.

	Charged Pack/ New Battery	Discharged Pack/ Old Battery
NiCd Pack (PB-30)	or 	or 
NiCd Pack (PB-32/ PB-33)		
NiCd Pack (PB-34)		
Alkaline Battery	or 	or 

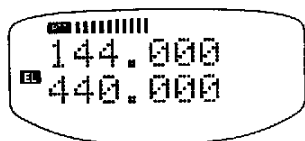

## BATTERY OPERATING TIME (HOURS)

Frequency Band	Batteries	Transmitter Output Power		
		HI	LO	EL
VHF	PB-30	6	8	12
	PB-32	5	8	12
	PB-33	10	18	25
	PB-34	4	8	13
	Alkaline	12	17	29
UHF	PB-30	4.5	7	10
	PB-32	3.5	6.5	10
	PB-33	7	13	21
	PB-34	3.5	7	11
	Alkaline	8	14	25

### Recommended operation:

- 6 seconds Transmit, 6 seconds Receive,  
48 seconds Standby (AF output 0.2 W / 8 ohms)

## GETTING ACQUAINTED

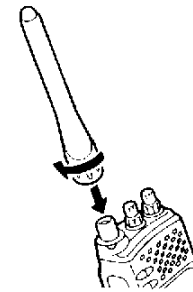
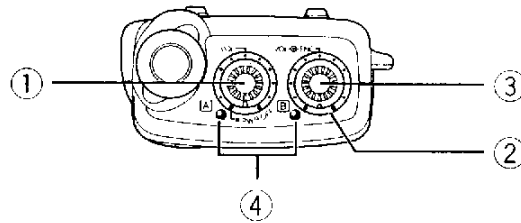

Holding the antenna at its base, push it into the antenna connector. Twist the antenna clockwise one-quarter turn until it locks in place. The installed antenna can turn continuously around the connector.

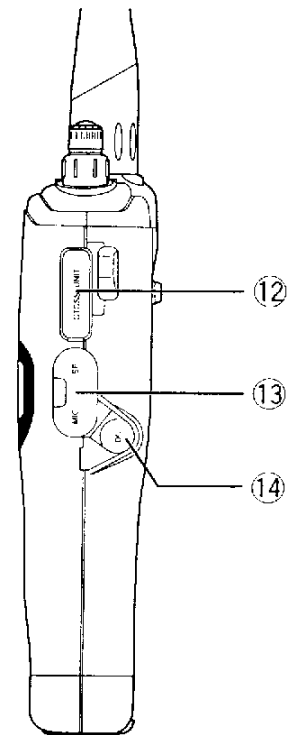
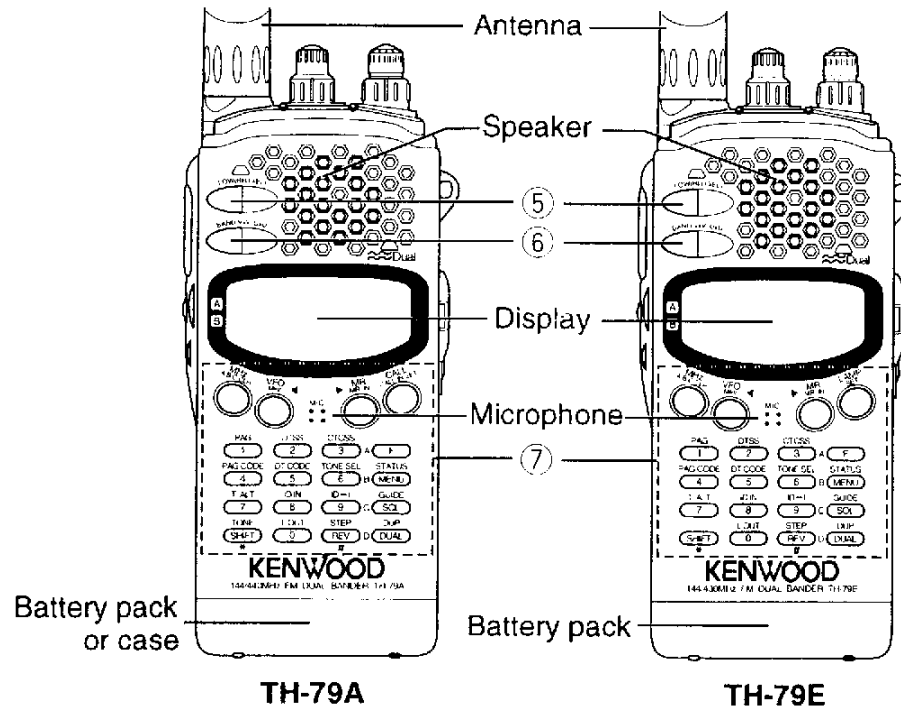
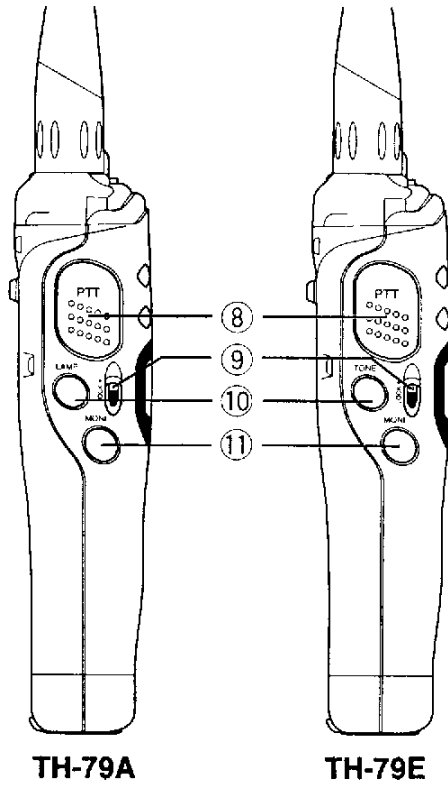

## PHYSICAL LAYOUT

### ① **PWR/VOL** (A) control

Turn clockwise to switch ON the dual bander. Turn counterclockwise (to PWR OFF) to switch OFF the power. Also adjusts the volume of the band displayed in the upper Display half (A).

### ② **VOL** (B) control

Adjusts the volume of the band displayed in the lower Display half (B).

### ③ **ENC** (Encoder) control

Selects data necessary to use and control your dual bander, e.g. operating frequencies, frequency steps, memory channels, menu items, etc. Also reverses the direction of any of the scans.

### ④ **RX/TX** indicators

Each indicates the receive and transmit state of its associated band. The left indicator reports on the band displayed on the upper Display half (A) and the right indicator reports on the band displayed on the lower Display half (B). Each lights green when a signal is received and red when you are transmitting.

### ⑤ **LOW** key

Selects the different levels of transmit output power.

### ⑥ **BAND** key

Selects the Operating band on which you can transmit and receive. Also selects the VHF/VHF and UHF/UHF configurations.

### ⑦ **Function keys and DTMF keypad**

Used for accessing functions, menu items, help information, etc. Also used for sending DTMF tones.

### ⑧ **PTT** (Push-To-Talk) switch

Hold down to transmit. Release to receive.

### ⑨ **LOCK** switch

Locks most keys and the **ENC** control.

### ⑩ **LAMP** key (TH-79A), **TONE** key (TH-79E)

On the TH-79A, controls the Display illumination.

On the TH-79E, press to transmit a 1750 Hz repeater access tone. The Lamp key is located on the front.

### ⑪ **MONI** (Monitor) key

Hold down to listen to the current receive frequencies on the 144 MHz and 430/440 MHz bands.

### ⑫ **CTCSS** unit installation slot {page 65}

### ⑬ **MIC/SP** jacks

If desired, connect an external microphone, speaker, or speaker-microphone. Keep water out of these jacks.

### ⑭ **DC** jack

Connect a BC-17 wall charger for recharging. Also accepts a PG-2W DC power cable if an external power supply (5.5 V to 16 V) is used, or a PG-3J cigarette lighter cable for mobile operation.

# FUNCTION KEYS AND DTMF KEYPAD

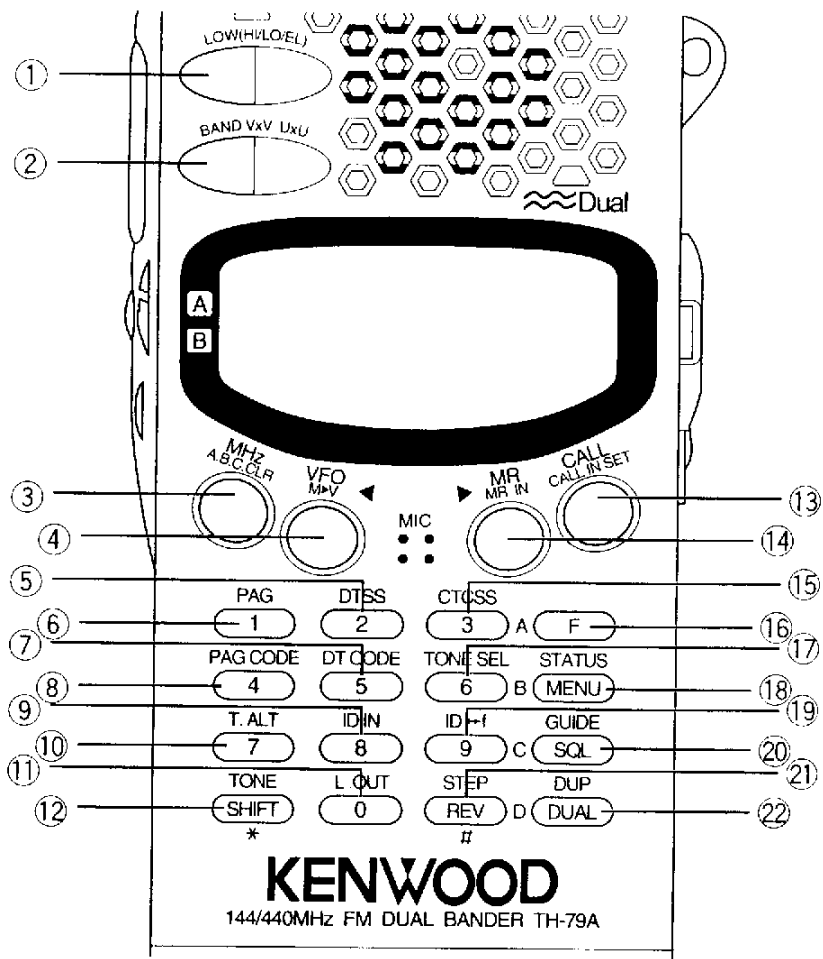

TH-79A

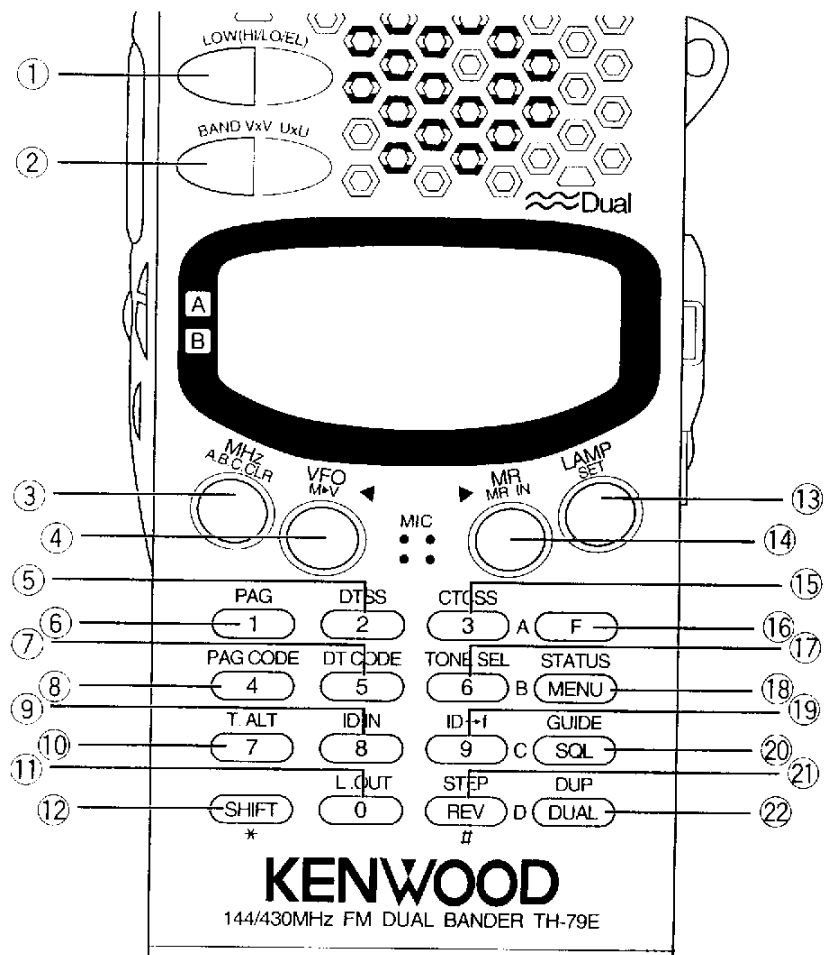

TH-79E

	Key	Selected Page References
①	[LOW]	21
②	[BAND]	15
	[VxV, UxU]	15
③	[MHz]	20, 38
	[A.B.C.]	44
	[CLR]	26, 36, 37, 46, 51, 53
④	[VFO]	17, 18, 30, 38, 41, 42
	[M▶V]	25
	[◀]	26, 27, 36, 37, 46
⑤	[2]	17, 18, 24, 35, 38, 48, 51
	[DTSS]	48
⑥	[1]	17, 18, 24, 35, 38, 48, 51
	[PAG]	51
⑦	[5]	17, 18, 24, 35, 38, 48, 51
	[DT CODE]	48
⑧	[4]	17, 18, 24, 35, 38, 48, 51
	[PAG CODE]	51
⑨	[8]	17, 18, 24, 35, 38, 48, 51
	[ID IN]	26
⑩	[7]	17, 18, 24, 35, 38, 48, 51
	[T.ALT]	55
⑪	[0]	17, 18, 24, 35, 38, 48, 51
	[L.OUT]	40, 53
⑫	[SHIFT]	31
	[TONE] (TH-79A)	34, 55
	[*]	17, 18, 24, 35, 38, 48, 51

	Key	Selected Page References
⑬	[CALL] (TH-79A)	28
	[LAMP] (TH-79E)	45, 46
	[CALL IN] (TH-79A)	28
⑭	[SET]	11, 14, 18, 22, 26, 32, 33, 35-37, 40, 43, 45, 46, 49, 53, 54
	[MR]	24, 25, 40, 42, 49, 52, 54
	[MR IN]	23, 24, 41, 42
⑮	[▶]	26, 36, 37, 46
	[3]	17, 18, 24, 35, 38, 48, 51
	[CTCSS]	47
⑯	[F]	Function key
	[A]	17, 18, 24, 35, 38, 48, 51
⑰	[6]	17, 18, 24, 35, 38, 48, 51
	[TONE SEL]	34
⑱	[MENU]	11
	[STATUS]	13
	[B]	17, 18, 24, 35, 38, 48, 51
⑲	[9]	17, 18, 24, 35, 38, 48, 51
	[ID↔f]	27
⑳	[SQL]	16
	[GUIDE]	11
	[C]	17, 18, 24, 35, 38, 48, 51
㉑	[REV]	33
	[STEP]	19
	[#]	17, 18, 24, 35, 38, 48, 51
㉒	[DUAL]	16
	[DUP]	45
	[D]	17, 18, 24, 35, 38, 48, 51

## DISPLAY

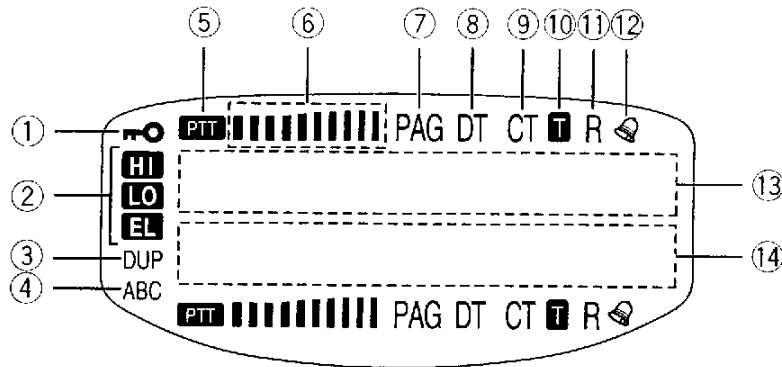

**Note:** Electromagnetic fields, such as those produced by static electricity, may occasionally cause the LCD to function abnormally. However, the LCD will typically return to normal operation within approximately one minute.

① 

Appears when Key Lock is ON.

② **HI LO EL**

Indicates the transmit power for the current band.

③ DUP

Appears when Full Duplex is ON. Blinks when Full Duplex and the feedback prevention circuit are ON.

④ ABC

Appears when Automatic Band Change is ON.

⑤ **PTT**

Indicates which band is the current Operating Band.

⑥ 

While receiving, displays relative received signal strength. While transmitting, displays battery level relative to a fully charged battery.

⑦ PAG

Appears when Page is ON for the current band.

⑧ DT

Appears when DTSS is ON for the current band.

⑨ CT

Appears when the CTCSS function is ON for the current band.

⑩ 



Appears when the Tone encoder is ON for the current band.

⑪ R

Appears when the Reverse function is ON for the current band.

⑫ 

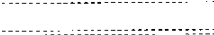
Appears when Tone Alert is ON for the current band.

⑬   
⑭ 

Area where information such as frequencies, menu data, help sentences, etc. appear. The default is the VHF band in the upper half of the Display (A) and the UHF band in the lower half of the Display (B).



## MENU SETUP

Many of the functions in this dual bander are activated or configured by means of a menu system. This system reduces the number of keys and controls without eliminating important features.

- 1 Press **[MENU]** to enter Menu Setup.
- 2 Turn the **ENC** control to select the menu item to be changed.

**Example:** "Audio" (5)

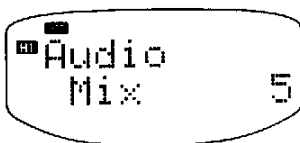

Audio  
Mix 5

- 3 Press **[SET]** to cycle through the different selections available. For menu items that allow user input, follow the instructions in the section of the manual that describes the particular function.



Audio  
Separate 5

- 4 Press **[MENU]** to store the selected value and exit Menu Setup.
  - You can also press instead any key other than **[SET]**, **[MONI]**, **[LAMP]**, **[◀]**, or **[▶]**.

## GUIDE FUNCTION

A user help function has been built-in to advise you of many of the procedures necessary to configure and use your dual bander. The Section Title is shaded as shown above for functions included in the Guide Menu on the dual bander.

- 1 Press **[F]**, **[GUIDE]** to access the Guide Menu.
- 2 Turn the **ENC** control to select the Guide item of interest.

**Example:** Storing simplex memory channel data.

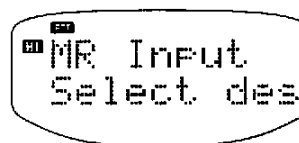

MR Input  
Select des

- 3 Press **[GUIDE]** to exit the Guide Menu.
  - You can also press instead any key other than **[LAMP]** or **[MONI]**.

## MENU FUNCTIONS

No.	Menu Name	Function	Selections	Default	Page Ref.
1	Save	Battery Saver	Off / On	On	43
2	APO	Automatic Power Off (APO)	Off / On	On	43
3	ENC	<b>ENC</b> Lock	Lock/Unlock	Lock	44
4	Tx Stop	Transmit Inhibit	Off / On	Off	22
5	Audio	Audio Separation	Mix / Separate	Mix	14
6	Auto Shift <sup>1</sup>	Automatic Transmit Offset	Off / On	See text	32
7	PAG Cancel	Page Cancel	Manual / Auto	Manual	53
8	CSQL Delay	DTSS/Page Transmit Delay	350 ms / 550 ms	350 ms	49, 54
9	DTMF memory	DTMF Memory Store	User Input	—	35
10	PWR On MSG	Power ON Message	User Input	—	46
11	VHF Shift	VHF Transmit Offset	600 kHz or User Input	600 kHz	33
12	UHF Shift	UHF Transmit Offset	TH-79A: 5 MHz TH-79E: 1.6 MHz or User Input	5 MHz or 1.6 MHz	33
13	Prog VFO (VHF)	VHF Programmable VFO Limits	Lower / Upper	Min./ Max	18
14	Prog VFO (UHF)	UHF Programmable VFO Limits	Lower / Upper	Min./ Max.	18
15	Beep	Beep Function	Off / On	On	45
16	DTMF 2sec	DTMF Transmit Hold	Off / On	Off	35
17	Scan Mode	Scan Resume	Time / Carrier	Time	40
18	AnswerBack <sup>2</sup>	Page Answer Back	Off / On	Off	54

<sup>1</sup> On General market versions, Auto Shift can be switched on in the Menu but this selection is invalid.

<sup>2</sup> TH-79A (U.S.A. / Canada) only

## GUIDE INDEX

Guide Name	Function	Page Ref.
Guide Func	Help for the Guide Function	11
Band Scan	Band Scan start	41
MR Scan	Memory Scan start	40
MHz Scan	MHz Scan start	42
MR Input	Simplex memory channel store	23
Split MR	Split memory channel store	24
CALL Input <sup>1</sup>	Simplex Call channel store	28
Split CALL <sup>1</sup>	Split Call channel store	28
ID Input	Personal ID store	26
ID ↔ f	ID/operating frequency toggle	27
VFO Reset	VFO initialization	30
All Reset	Dual bander initialization	30
MR ch Clear	Memory channel contents clear	25
DTMF MR TX	DTMF Memory transmit	38
REM Sw Set	Microphone key program	56

<sup>1</sup> Excluding European versions.

**Note:** Only Guide Func, MR Scan, DTMF MR TX, and REM Sw Set are visible while using Channel Display mode.

## STATUS DISPLAY

This function provides a quick way to get an update of how your dual bander is configured. The dual bander scrolls through a summary of the parameters in the chart. Bracketed status selections are the defaults.

Press **[F]**, **[STATUS]**.

- Press any key other than **[LAMP]** or **[MONI]** to exit.

Status Label	Status
ID ↔ f	(ID) / Frequency
Save	Off / (On)
APO	Off / (On)
ENC	(Lock) / Unlock
Tx Stop	(Off) / On
Audio	(Mix) / Separate
Auto Shift	Off / On <sup>1</sup>
PAG Cancel	(Manual) / Auto
CSQL Delay	(350 ms) / 550 ms
Scan Mode	(Time) / Carrier
Beep	Off / (On)
DTMF 2sec	(Off) / On

<sup>1</sup> Default depends on version {page 32}.

## RECEIVING

### SWITCHING POWER ON/OFF

Turn the **PWR/VOL** control clockwise to switch ON the dual bander. Turn the same control fully counterclockwise to switch OFF the dual bander.

### VOLUME ADJUST

The transceiver has separate volume controls for each band. The left **VOL** control (A) adjusts the audio level for the band displayed in the upper Display half (A); the right **VOL** control (B) adjusts the audio level for the band displayed in the lower Display half (B). Turn the controls clockwise to increase the audio level, and counterclockwise to decrease the level.

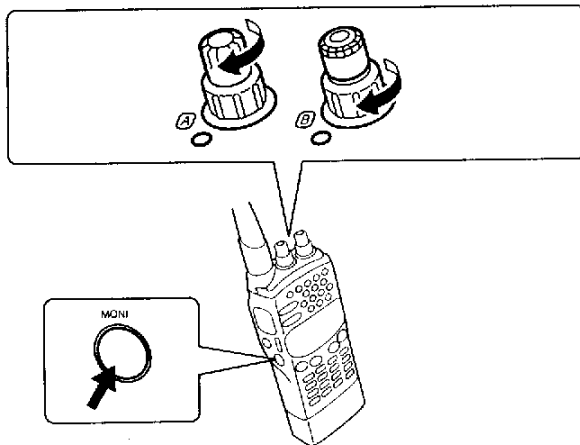

### ■ Audio Separation

This function allows you to combine or separate the receive audio from the VHF and UHF bands.

- 1 Press **[MENU]**.
- 2 Turn the **ENC** control to select "Audio" (5).

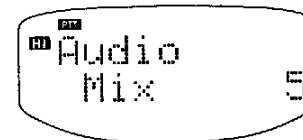

- 3 Press **[SET]** to select "Mix" or "Separate".
  - When an external speaker-microphone is connected, "Mix" passes audio from both bands to the external speaker. When "Separate" is selected, Operating band audio passes to the external speaker and audio from the Receive only band is heard from the internal speaker.
  - The default is "Mix"
- 4 Press **[MENU]** to exit.

## BAND SELECT

While in the dual band mode (default), the dual bander receives simultaneously on the VHF and UHF bands.

Press **[BAND]** to toggle the Operating band between VHF and UHF. The Operating Band is the band on which you can transmit as well as receive.

- The position of "PTT" on the Display indicates which band is the Operating band.

### VHF Operating Band / UHF Receive only

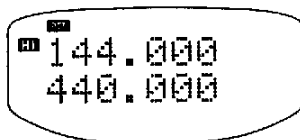

### UHF Operating Band / VHF Receive only

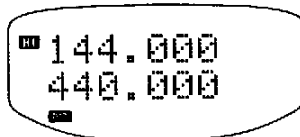

The dual bander can be used in a VHF/VHF or UHF/UHF configuration if you prefer. Switching ON either of the following functions cancels Full Duplex. The following procedures assume you are currently using the default VHF/UHF configuration.

## VHF/VHF Configuration

- 1 Press **[BAND]** to select the UHF band as the Operating band.
- 2 Press **[F], [VxV, UxU]** to toggle between VHF/UHF and VHF/VHF configurations.
  - When VHF/VHF is selected, the UHF Operating band switches to a VHF Operating band. Two VHF frequencies are visible.

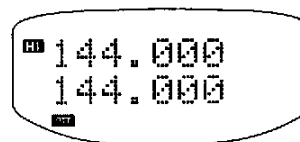

## UHF/UHF Configuration

- 1 Press **[BAND]** to select the VHF band as the Operating band.
- 2 Press **[F], [VxV, UxU]** to toggle between VHF/UHF and UHF/UHF configurations.
  - When UHF/UHF is selected, the VHF Operating band switches to a UHF Operating band. Two UHF frequencies are visible.

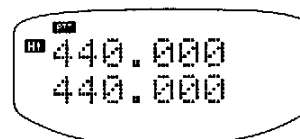

## SINGLE BAND MODE

It's possible to switch OFF either the VHF band or the UHF band. You can still select either band using **[BAND]**, but only one frequency appears on the Display at a time and only the received audio from the currently selected band will be heard.

- 1 Press **[BAND]** to select the Operating band.
- 2 Press **[DUAL]** to toggle between dual and single band mode.
  - The Receive only band switches OFF when selecting single band mode.

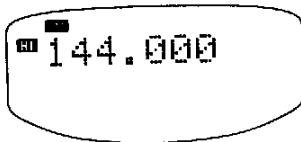

## SQUELCH ADJUST

The purpose of squelch is to silence audio output from the speaker when no signals are present. The squelch is automatically controlled by the dual bander's microcomputer based on the measured noise level. However, you can override the microcomputer setting, if you wish.

- 1 Press **[BAND]** to select the Operating band.
- 2 Press **[SQL]**.

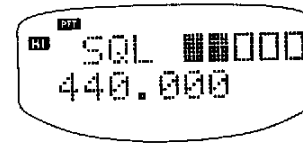

- 3 Turn the **ENC** control to select the desired squelch level using the squelch indicator on the Display as reference. The default is "2".
- 4 Press **[PTT]** to exit.

## SELECTING FREQUENCIES

Your operating frequency can be selected in VFO mode via the **ENC** control or the keypad.

### ■ ENC Control

- 1 Press [**BAND**] to select the Operating band.
- 2 Press [**VFO**] to select VFO mode.
- 3 Turn the **ENC** control to select a frequency.
  - Clockwise rotation increases the frequency one frequency step at a time.
  - Counterclockwise rotation decreases the frequency one frequency step at a time.

If you cannot select a particular frequency, the frequency step size needs to be changed. See "SELECTING FREQUENCY STEP SIZE" {page 19} for further information.

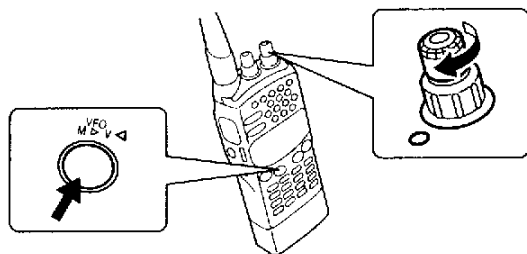

### ■ Keypad Direct Frequency Entry

Entering the desired frequency directly via the keypad can be the fastest way of selecting a different frequency. If the new frequency is hundreds of kHz or more from the current frequency, and you don't have the new frequency stored in any memory channels, use direct entry.

- 1 Press [**BAND**] to select the Operating band.
- 2 Press [**VFO**] to select VFO mode.
- 3 Enter the desired frequency using the numeric keys.
  - For versions with receive coverage wider than 10 MHz, the 10 MHz digit must be entered. Otherwise, begin entering from the 1 MHz digit.
  - When the current step size is 5 kHz, 10 kHz, 15 kHz, or 20 kHz, enter numeric values down to the 1 kHz digit. Enter either 0 or 5 for the 1 kHz digit.
  - When the current step size is 12.5 kHz or 25 kHz, entering the 10 kHz digit completes frequency setting. The 10 kHz and subsequent digits are set according to which key is pressed for the 10 kHz digit as shown in the chart.

10 kHz Key	Frequency (kHz)	10 kHz Key	Frequency (kHz)
0	00	5	50
1	12.5	6	62.5
2	25	7	75
3	37.5	8	87.5
4	37.5	9	87.5

- Except for the 1 kHz digit, entering a digit that is outside the allowable range causes the nearest digit within range to be displayed. For the 1 kHz digit, pressing [0] to [4] selects "0" and pressing [5] to [9] selects "5".
- If any key other than [0] to [9], [MONI], or [LAMP] is pressed, or if the next entry is not made within 10 seconds, the previous frequency will be restored.
- If [VFO] is pressed while entering the frequency, the new data is accepted for the digits entered and the previous data remains unchanged for the digits not yet entered.
- Turning the **ENC** control while entering the frequency cancels the new numeric data entered, and raises or lowers the previously displayed frequency.

## PROGRAMMABLE VFO

This function sets limits for the minimum and maximum frequencies that are selectable with the **ENC** control. Limits can be set or modified at any time, and are configurable for both bands on the dual bander.

- 1 Press [MENU].
- 2 Turn the **ENC** control to select "Prog VFO" (13) for the VHF band, or "Prog VFO" (14) for the UHF band.
  - The numbers indicate the minimum and maximum frequencies in MHz that are selectable for the VFO limits on your version of dual bander (Example below shows the U.S.A./ Canada version).

Prog VFO  
118-173 13

- 3 Press [SET] to select "Lower Freq".
  - The default is the minimum frequency.
- 4 Turn the **ENC** control to select the desired lower VFO limit.

Lower Freq  
145.



- 5 Press **[SET]** to select "Upper Freq".
  - The default is the maximum frequency.
- 6 Turn the **ENC** control to select the desired upper VFO limit.

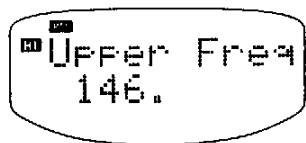

- 7 Press **[SET]**.
- 8 Press **[MENU]** to exit.

**Note:**

- ◆ *The lower limit must be equal to or lower in frequency than the upper limit.*
- ◆ *The minimum programmable range is 1 MHz, and only ranges in multiples of 1 MHz can be programmed.*

## SELECTING FREQUENCY STEP SIZE

Choosing the correct step size when operating is essential in order to select your exact operating frequency with the **ENC** control. The best step size is the largest step that will still allow you to use the **ENC** control to select all frequencies on which you plan to operate. Using the best step size reduces the time required to select new frequencies with the **ENC** control; operating becomes easier.

- 1 Press **[BAND]** to select the Operating band.
- 2 Press **[VFO]** to select VFO mode.
- 3 Press **[F]**, **[STEP]**.

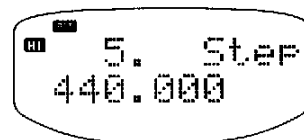

- 4 Turn the **ENC** control to switch between available frequency steps.
  - As you turn the **ENC** control clockwise or counterclockwise, the following selections appear:

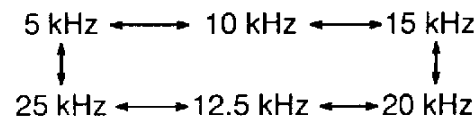

5 Press **[STEP]** to store the selected value and exit.

- VFO mode is restored.

**Note:**

- ◆ The step size can be set separately for the VFO, Call channel, and memory channels.
- ◆ When using the UHF/UHF configuration, the frequency steps of 5 kHz and 15 kHz cannot be selected on the A band (upper Display). Only 10 kHz, 20 kHz, 12.5 kHz, and 25 kHz can be selected.

■ **1 MHz Frequency Step**

The 1 MHz Step function allows rapid frequency excursions up or down the band with a minimum of key strokes.

- 1 Press **[BAND]** to select the Operating band.
- 2 Press **[VFO]** to select VFO mode.
- 3 Press **[MHz]**.

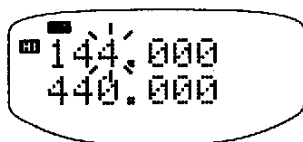

- 4 Turn the **ENC** control to select the desired MHz digit.
- 5 Press **[MHz]** to restore the previous frequency step.

**Note:** 1 MHz Step does not work in Memory Recall or Call channel modes.

■ **Changes in Displayed Frequencies**

Changing between step sizes may result in a change of the displayed frequency. When a change occurs, and by how much, is shown in the accompanying charts.

**5, 10, 15, or 20 kHz Step → 12.5 or 25 kHz Step**

Before (10 kHz/ 1 kHz Digits)	After (10 kHz/ 1 kHz Digits)
00, 05, 10, 15	00
20, 25, 30, 35	25
40, 45, 50, 55	50
60, 65, 70, 75, 80, 85, 90, 95	75

**12.5, or 25 kHz Step → 5, 10, 15, or 20 kHz Step**

Before (10 kHz/ 1 kHz/ 500 Hz Digits)	After (10 kHz/ 1 kHz Digits)
00	00
12.5	10
25	20
37.5	30
50	50
62.5	60
75	70
87.5	80

# TRANSMITTING

## SELECTING OUTPUT POWER

It's wise, and required by law, to select the lowest power that allows reliable communication. This saves battery power which extends battery life, and lowers the risk of interfering with others on the band.

- 1 Press **[BAND]** to select the Operating band.
- 2 Press **[LOW]** to select the transmit power you require.
  - Each time this key is pressed, the transmit output power changes as below. The default is High power.

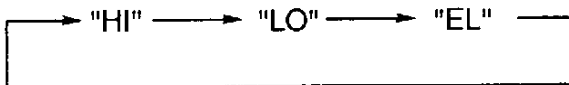

Batteries	Output Power (approx.)					
	VHF Band			UHF Band		
	HI	LO	EL	HI	LO	EL
PB-30	1.5 W	0.5 W	30 mW	1.5 W	0.5 W	30 mW
PB-32/33	2.7 W	0.5 W	30 mW	2.0 W	0.5 W	30 mW
PB-34	5.0 W	0.5 W	30 mW	5.0 W	0.5 W	30 mW
Alkaline	2.0 W	0.5 W	30 mW	1.5 W	0.5 W	30 mW

### Note:

- ◆ The transmit output power cannot be changed while transmitting.
- ◆ The horizontal bars that appear on the Display while transmitting indicate the relative battery level.

## PTT SWITCH

When ready to begin transmitting, press and hold **[PTT]** and speak in a normal tone of voice holding the dual bander about 5 cm (2 in.) from your mouth. Speaking too close to the microphone, or too loudly, may increase distortion and reduce intelligibility of your signal at the receiving station. Release **[PTT]** to return to the Receive mode.

The RX/TX indicator for the selected Operating band lights red while you are transmitting.

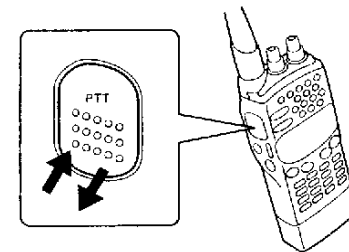

## TRANSMIT INHIBIT

The transmit function can be disabled to prevent unauthorized individuals from transmitting, or to eliminate the risk of yourself accidentally transmitting.

- 1 Press **[MENU]**.
- 2 Turn the **ENC** control to select "Tx Stop" (4).



- 3 Press **[SET]** to toggle between inhibit "Off" and inhibit "On".
  - Inhibit "Off" enables the transmitter and inhibit "On" inhibits the transmitter. The default is "Off".
- 4 Press **[MENU]** to exit.

If **[PTT]** is pressed while Transmit Inhibit is ON, your dual bander beeps, "Tx Stop" appears on the Operating band Display, and transmission is not possible. The PTT switch on any microphone configured for remote control with this dual bander also will be disabled. On European versions, 1750 Hz cannot be transmitted while Transmit Inhibit is activated.

## TIME-OUT TIMER (TOT)

It is sometimes necessary or desirable to restrict a single transmission to a maximum time. This function can be useful when accessing repeaters to prevent repeater time-outs, or when particularly trying to conserve battery power.

The timer is fixed at 10 minutes and is not configurable. Also, TOT cannot be disabled.

## MEMORY CHANNELS

A total of 80 memory channels (0 to 79) are available for storing frequencies and related data. Each memory channel can be used either as a simplex channel or split channel. Alternatively, a standard or non-standard frequency offset and offset direction required for using repeaters can be stored. Refer to "OPERATING THROUGH REPEATERS" {page 31}.

The data listed below can be stored in each memory channel:

Parameter	Simplex Channel	Split Channel
RX frequency	YES	YES
TX frequency		YES
Tone (CTCSS) frequency	YES	YES
Tone or CTCSS status	YES	YES
Frequency step	YES	YES
Shift status, REV status	YES	N/A
DTSS code, DTSS status	YES	YES

**YES:** Can be stored in memory.  
**N/A:** Not applicable

## STORING DATA IN MEMORY

There are 2 methods of storing transmit/receive frequencies and associated data in memory channels:

- RX frequency = TX frequency (Simplex)
- RX frequency  $\neq$  TX frequency (Split)

### ■ Simplex Memory Channels

1 Select the desired frequency and associated data (Tone, CTCSS, DTSS, etc.) using VFO mode, Memory Recall or the Call channel.

2 Press [F].

- $\blacktriangleright$ : Channel contains data.
- $\blacktriangleright$ : Channel is empty.

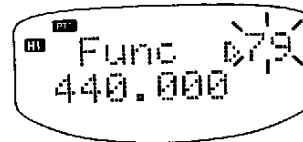

3 Select the desired memory channel using the **ENC** control.

4 Press [MR IN].

- The selected frequency and associated data are stored in the memory channel. A transmit

frequency from a split memory channel or split Call channel is not stored.

- If the memory channel selected in the previous step already contained data, the new data overwrites the previous data.
- The previous mode is restored.

### ■ Split Memory Channels

- 1 After storing the receive frequency using "Simplex Memory Channels" {page 23}, select the desired transmit frequency.
- 2 Press **[F]**.
- 3 Turn the **ENC** control to select the memory channel containing the receive frequency.
- 4 Press **[PTT]+[MR IN]**.
  - The transmit frequency is stored and the previous mode is restored.
  - If the memory channel selected does not contain a receive frequency, your dual bander beeps and restores the previous mode.
  - Associated data such as Tone status/frequency, frequency step, and DTSS status/code are not overwritten. However, Transmit Offset status and Reverse status are erased.

## RECALLING MEMORY CHANNELS

### ■ Using the ENC Control

- 1 Press **[BAND]** to select the Operating band.
- 2 Press **[MR]**.
  - The memory channel used last is recalled.
  - If all memory channels are empty, your dual bander beeps and Memory Recall is not selected.
- 3 Turn the **ENC** control to select the desired memory channel.
  - Clockwise: Increases the channel number.
  - Counterclockwise: Decreases the channel number.

### ■ Using the Keypad

- 1 Press **[BAND]** to select the Operating band.
- 2 Press **[MR]**.
  - The memory channel used last is recalled.
- 3 Enter a 2-digit number (00 to 79) to select the desired memory channel.

**Note:**

- ◆ Empty memory channels cannot be recalled.
- ◆ UHF frequencies that are selected with a 5, 10, 15, or 20 kHz step and then are saved in memory channels cannot be recalled while the A band (upper Display) is the Operating band if you are using the UHF/UHF configuration. In this case, select the B band (lower Display) as the Operating band to recall these memory channels.

## MEMORY → VFO TRANSFERS

Transferring the contents of a memory channel or the Call channel to the VFO can be useful if you wish to search for other stations or a clear frequency near the selected memory channel or Call channel frequency. This is a quick operation that will be used frequently, especially if you enjoy exploring the band.

- 1 Press **[BAND]** to select the Operating band.
- 2 Press **[MR]** to select Memory Recall, or **[CALL]** to select the Call channel. Skip the next step if the Call channel was selected.
- 3 Recall the desired memory channel using the **ENC** control.
- 4 Press **[F]**, **[M▶V]**.
  - The complete contents of the memory channel or the Call channel are copied to the VFO.
  - A transmit frequency from a split memory channel or split Call channel is not transferred to the VFO.

## ERASING MEMORY CHANNEL DATA

Although it is possible to overwrite existing data in any of the memory channels with new data, at times you may wish to erase data from memory channels without entering new data. It's convenient to erase channel data that is no longer needed so you can identify channels that are free for memorizing new frequencies.

- 1 Press **[BAND]** to select the Operating band.
- 2 Press **[MR]** to select Memory Recall.
- 3 Select the desired memory channel using the **ENC** control or numeric keys.
- 4 Press **[MR]+ POWER ON**.
  - "Ch XX Clr? Press MR" appears. "XX" represents the memory channel number selected above.

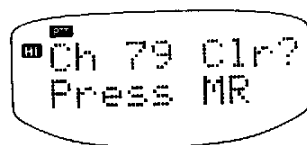

- 5 Press **[MR]**.
  - The contents of the memory channel are erased and transferred to the VFO.
  - The VFO mode is restored.

## MEMORY CHANNEL IDS

To help you remember each memory channel's purpose, the dual bander has the ability to store an identifier (ID) for each channel. This ID can be a callsign, repeater name, city, person's name, etc. that can be formed from the character library. All 80 memory channels can be assigned an ID of up to 7 characters.

### ■ Storing IDs

- 1 Press **[BAND]** to select the Operating band.
- 2 Press **[MR]** and select the memory channel for which you want to store an ID.
- 3 Press **[F]**, **[ID IN]** to enter ID Input mode.

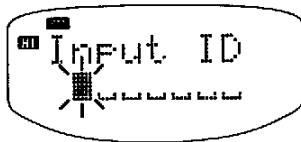

- 4 Turn the **ENC** control to select the first character.
  - Pressing **[◀]** deletes the previous character. Press **[◀]** repeatedly to position the blinking cursor, if necessary.
  - To search more quickly through the character library, hold **[MONI]** down and turn the **ENC** control. Each step of the **ENC** control then moves you 5 characters. Clockwise rotation moves you ahead; counterclockwise moves you back in the library.

- Pressing **[CLR]** aborts ID Entry mode and returns you to Memory Recall.

5 Press **[▶]**.

6 Repeat Steps 4 and 5 until all characters are entered.

- It is not necessary to enter **[▶]** after the final character.



7 Press **[SET]** to exit.

### ■ Character Library

<b>LETTERS: Upper Case</b>	A B C D E F G H I J K L M N O P Q R S T U V W X Y Z Å Ä Æ Ç É Ñ Ö Ü
<b>LETTERS: Lower Case</b>	a b c d e f g h i j k l m n o p q r s t u v w x y z á â ã ä å æ ç é ê ë è í î ï ñ ó ô õ ö ù û ü ù ÿ
<b>NUMERALS</b>	0 1 2 3 4 5 6 7 8 9
<b>SYMBOLS</b>	ª º ¿ ¬ ¬ ¡ « » ¡ ! " # \$ % & ' ( ) * + , - . / : ; < = > ? @ [ ] ^ _ ` {   } → ← ¢ £ ¥ Pt f

<sup>1</sup> Space character



## ■ Confirming ID/Frequency Pairings

- 1 Press **[BAND]** to select the Operating band.
- 2 Press **[MR]**.
- 3 Turn the **ENC** control to display the ID that you want to check.

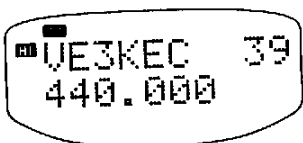

- 4 Press **[F]**, **[ID ↔ f]** to display the associated frequency.

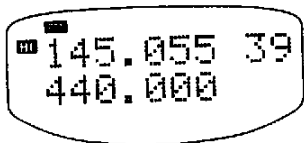

- 5 Press **[F]**, **[ID ↔ f]** again to re-display the ID.

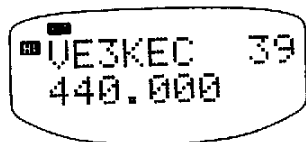

## ■ Erasing IDs

- 1 Press **[BAND]** to select the Operating band.
- 2 Press **[MR]**.
- 3 Turn the **ENC** control to display the ID that you want to erase.
- 4 Press **[F]**, **[ID IN]** to enter ID Input mode.

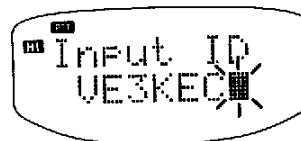

- 5 Press **[◀]** repeatedly to erase each character.

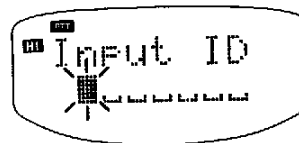

- 6 Press **[SET]** to exit.
- 7 Repeat Steps 3 to 6 if you want to erase other IDs on the same band.

## CALL CHANNEL (EXCLUDING EUROPEAN VERSIONS)

The Call channel can be used to store any frequency within your dual bander operating range that you wish to make your main operating frequency. No matter what mode the dual bander is in, the Call channel always can be selected quickly. You may wish to dedicate the Call channel on a group-wide basis as an emergency channel only to be used for urgent communications.

### ■ Recalling the Call Channel

- 1 Press **[BAND]** to select the Operating band.
- 2 Press **[CALL]** to retrieve the contents of the Call channel.

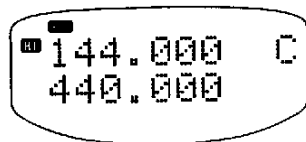

- If **[CALL]** is pressed again, the previous mode is restored.
- The **ENC** control does not function while the Call channel is selected.

Version	Defaults (MHz)	
	VHF	UHF
U.S.A. / Canada	144.000	440.000
General	144.000	430.000

### ■ Changing Call Channel Contents (Simplex)

- 1 Select the desired frequency and associated data (Tone, CTCSS, DTSS, etc.) using VFO mode or Memory Recall.
- 2 Press **[F]**, **[CALL IN]**.
  - The selected frequency and associated data are stored in the Call channel, and the previous mode is restored.
  - The ID of a recalled memory channel is not copied to the Call channel.

### ■ Changing Call Channel Contents (Split)

- 1 After storing the receive frequency using "Changing Call Channel Contents (Simplex)", select the desired transmit frequency.
- 2 Press **[F]**, **[PTT]+[CALL IN]**.
  - The selected transmit frequency is stored in the Call channel, and the previous mode is restored.

*Note:* A memory ID cannot be assigned to the Call channel.

## CLONE (U.S.A. ONLY)

Clone copies the total contents of all memory channels to other TH-79A dual banders, at one time, via DTMF signals. Memory channel IDs are copied also.

- 1 Select any frequency on the source TH-79A within its transmit frequency range, then press **[0]+ POWER ON**.
  - "CLONE" appears on the Display.
- 2 Match the frequency on a target TH-79A with the source dual bander, then press **[0]+ POWER ON**. Repeat for all other target dual banders.
  - "CLONE" appears on each target dual bander.
- 3 Press **[PTT]** on the source dual bander to start.
- 4 On completion of a successful transfer, the source dual bander restores its frequency display automatically, and the target dual banders display "END". If a transmission failure occurred, "ERROR" appears on the target dual banders. In this case, repeat the procedure from Step 1. In all cases, restore their frequency displays by switching the target dual banders OFF then back ON.

### Note:

- ◆ "EL" output power is used for Clone. To reduce the influence of extraneous signals and achieve the best Clone performance, remove the antennas from the target dual banders but leave the supplied antenna connected to the source dual bander. In addition, place the source dual bander close to the target dual banders so that the latter indicate maximum received signal strength while the source dual bander is transmitting.
- ◆ Confirm the contents written into the target dual banders even when transmission ends normally. Also, if the input power to a dual bander fails during transmission, data that was received by that dual bander may be lost. Repeat the procedure from Step 1.

## CHANNEL DISPLAY FUNCTION

Switching this function ON selects Memory Recall on the dual bander, then replaces the operating frequencies on the Display with memory channel numbers.

Press **[BAND]+ POWER ON** to toggle Channel Display ON or OFF.



**Note:** Channel Display can be used only when data has been stored in at least 1 memory channel on each band.

Certain functions cannot be used if Channel Display is activated. The following chart identifies these functions.

Non-functional with Channel Display ON	Page Ref.
VFO mode	17
Call channel	28
Band Scan	41
Memory → VFO transfer	25
Frequency Step change	19
1 MHz Step	20
Memory channel save	23
Call channel save	28
Memory channel clear	25
VFO Reset	30
All Reset	30

## INITIALIZING MEMORY

If your dual bander seems to be malfunctioning, initializing the memory may resolve the problem.

Remember that initializing the memory channels requires that you re-enter any memory channel data again after the reset if you wish to use those channels. On the other hand, if you want to erase all data from all channels, initialization is a quick way to do this.

*Note: Memory initialization is not possible if the Channel Display or Key Lock function is ON.*

### ■ VFO Reset (Partial Reset)

- 1 Press [VFO]+ POWER ON.
  - "VFO Reset? Press VFO" appears.
- 2 Press [VFO].

### ■ All Reset (Full Reset)

- 1 Press [F]+ POWER ON.
  - "All Reset? Press F" appears.
- 2 Press [F].

Version	VHF Defaults			UHF Defaults		
	VFO Freq.	Freq. Step	Tone Freq.	VFO Freq.	Freq. Step	Tone Freq.
Canada U.S.A.	144.000 MHz	5 kHz	88.5 Hz	440.000 MHz	25 kHz	88.5 Hz
Europe	144.000 MHz	12.5 kHz	1750 Hz	430.000 MHz	25 kHz	1750 Hz
General	144.000 MHz	12.5 kHz	88.5 Hz	430.000 MHz	25 kHz	88.5 Hz

## OPERATING THROUGH REPEATERS

### TRANSMITTER OFFSETS (SHIFT)

All Amateur Radio voice repeaters use a separate receive and transmit frequency. The receive frequency may be higher or lower than the transmit frequency but the difference in frequencies will be a standard amount, or "standard split". Most repeater configurations fall into one of the following categories:

Offset Direction	TH-79A/E VHF	TH-79A UHF	TH-79E UHF
+	+ 600 kHz	+ 5 MHz	+ 1.6 MHz
-	- 600 kHz	- 5 MHz	- 1.6 MHz
- -	N/A	N/A	- 7.6 MHz

Whether using the VFO, Memory Recall, or the Call channel, the transmit offset direction and amount can be changed.

### SELECTING OFFSET DIRECTION

This function sets the transmit frequency either higher (+) or lower (-) than the receive frequency by a fixed amount. Refer to "SELECTING OFFSET VALUES MANUALLY" {page 33} if you want to change the offset amount.

- 1 Press **[BAND]** to select the Operating band.
- 2 Press **[SHIFT]**.
  - The default is simplex (no offset). Each time **[SHIFT]** is pressed, the offset changes as follows:

#### TH-79A/E VHF TH-79A UHF

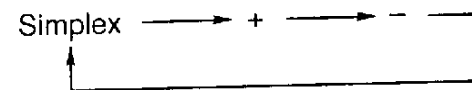

#### TH-79E UHF

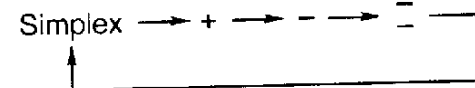

If the offset transmit frequency falls outside the transmit band, transmit is inhibited until the transmit frequency is brought within the band limits by one or more of the following methods:

- Move the receive frequency further inside the band.
- Reduce the offset amount.
- Reverse the offset direction.

## AUTOMATIC TRANSMIT OFFSET

On some versions, the dual bander takes care of setting the required transmit offset automatically when you select a frequency in VFO mode on the 144 MHz band. Due to Automatic Offset, a manually assigned offset direction is only effective until the frequency is changed.

### ■ U.S.A. and Canada Versions

Automatic Offset is programmed according to the standard ARRL (American Radio Relay League) Band Plan for repeater offset direction. You can override this programming by following the "SELECTING OFFSET DIRECTION" procedure in the preceding section.

144.0	145.5	146.4	147.0	147.6				
145.1	146.0	146.6	147.4	148.0 MHz				
S	-	S	+	S	-	+	S	-

S: Simplex

### ■ European Versions

The TH-79E Automatic Offset is programmed as follows:

144.0	145.6	145.8	146.0 MHz
S	-	S	

S: Simplex

### ■ Canceling Automatic Offset

There may be times when you don't want the Automatic Offset function to be active. For example, in your specific area, it is possible that national band plans are not in effect and it would be inconvenient if the dual bander kept assigning an offset automatically which you did not require. Or, when traveling with your dual bander in other countries, it may be more convenient to manually assign an offset if required.

- 1 Press **[MENU]**.
- 2 Turn the **ENC** control to select "Auto Shift" (6).

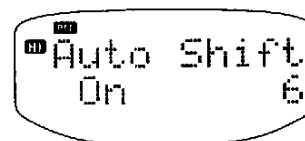

- 3 Press **[SET]** to toggle between "Off" and "On".
  - The default is "On" on the 144 MHz band for dual banders sold in the U.S.A., Canada, and Europe.
- 4 Press **[MENU]** to exit.

**Note:** After turning ON Automatic Offset again, or after transferring memory channel contents to a VFO, the function resumes when a new frequency is selected.

## SELECTING OFFSET VALUES MANUALLY

- 1 Press **[MENU]**.
- 2 Turn the **ENC** control to select "VHF Shift" (11) or "UHF Shift" (12).

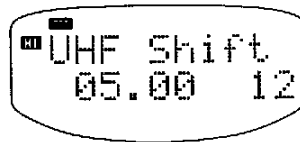

- 3 Press **[SET]**.

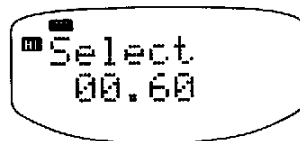

- 4 Turn the **ENC** control to select an offset value. The control selects in 50 kHz steps.
  - Select an offset that places the transmit frequency within the transmit range.
- 5 Press **[SET]** to store the selected value.
- 6 Press **[MENU]** to exit to the previous mode.

### Note:

- ◆ It is not possible to set different offset values for VFO mode and the memory channels.
- ◆ The new manually selected value will be used even if Automatic Offset is switched ON.

**TH-79E:** The offset can be changed from the default 1.6 MHz value; however, the 7.6 MHz value is not configurable.

## REVERSE FUNCTION

Reverse allows you to manually check the signal strength of a station accessing a repeater by switching your dual bander's transmit and receive frequencies on the selected band.

Press **[REV]** to toggle the function ON or OFF.

- The receive frequency and transmit frequency on the selected band are exchanged. "R" appears when the function is ON. The default is OFF.
- If reversal would place the receive frequency outside the receiver frequency range, an error beep sounds when **[REV]** is pressed. No reversal occurs.
- If the transmit frequency would go out of the transmitter frequency range if **[PTT]** were pressed, then pressing **[PTT]** causes an error beep and Receive is selected.
- Reverse cannot be activated while **[PTT]** is held down.
- Automatic Offset cannot be used while Reverse is ON.

## TONE FUNCTION

The Tone frequencies listed below can be selected:

No.	Freq. (Hz)	No.	Freq. (Hz)	No.	Freq. (Hz)	No.	Freq. (Hz)
01	67.0	11	97.4	21	136.5	31	192.8
02	71.9	12	100.0	22	141.3	32	203.5
03	74.4	13	103.5	23	146.2	33	210.7
04	77.0	14	107.2	24	151.4	34	218.1
05	79.7	15	110.9	25	156.7	35	225.7
06	82.5	16	114.8	26	162.2	36	233.6
07	85.4	17	118.8	27	167.9	37	241.8
08	88.5	18	123.0	28	173.8	38	250.3
09	91.5	19	127.3	29	179.9	(39) <sup>1</sup>	(1750) <sup>1</sup>
10	94.8	20	131.8	30	186.2		

<sup>1</sup> TH-79E only

### ■ Selecting Tone Frequencies

- 1 Press **[BAND]** to select the Operating band.
- 2 Press **[F]**, **[TONE SEL]**.

- 3 Turn the **ENC** control to select the desired Tone frequency.
- 4 Press **[TONE SEL]** to store the selected value.

### ■ Using the Tone Function

- 1 Press **[BAND]** to select the Operating band.
- 2 Press **[F]**, **[TONE]** on the TH-79A, or **[TONE]** on the TH-79E to toggle the Tone function ON and OFF.

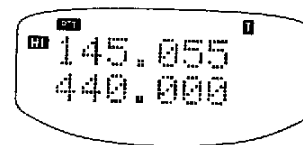

#### TH-79E:

- ◆ When **[TONE]** is pressed with 1750 Hz selected, 1750 Hz is transmitted. "T" appears during this period. Releasing **[TONE]** stops transmission and "T" goes OFF. Pressing **[PTT]+[TONE]** also transmits 1750 Hz.
- ◆ Each time **[TONE]** is pressed when any frequency other than 1750 Hz is selected, the Tone function toggles between ON and OFF.
- ◆ When 1750 Hz is selected while the Tone function is OFF, pressing **[TONE]** does not change the Tone/CTCSS status. When 1750 Hz is selected while the Tone or CTCSS function is ON, "T" or "CT" goes OFF.



## DUAL TONE MULTI-FREQUENCY (DTMF) FUNCTIONS

### ■ Making DTMF Calls

To make a DTMF call, hold down [PTT] and press [0] to [9], [A], [B], [C], [D], [∗], or [#].

- The microphone is muted and the corresponding DTMF tones are transmitted. You can monitor the tones as they are sent by listening to the speaker audio.
- If two keys are pressed, only the tone combination for the key pressed first is sent.

### ■ Activating DTMF Transmit Hold

It's easier to enter a long string of digits if you don't have to hold down [PTT] while entering the digits. Your dual bander remains in the transmit state for 2 seconds after pressing each key when this function is activated.

- 1 Press [MENU].
- 2 Turn the **ENC** control to select "DTMF 2sec" (16).

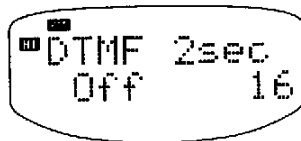

- 3 Press [SET] to toggle between "Off" and "On".
  - The default is "Off".
- 4 Press [MENU] to exit.

### ■ Storing DTMF Numbers for the Automatic Dialer

To store a DTMF number in any of the 10 dedicated memory channels (0 to 9), follow the procedure below.

- 1 Press [MENU].
- 2 Turn the **ENC** control to select "DTMF memory" (9).

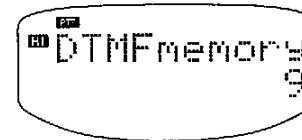

- 3 Press [SET].
- 4 Turn the **ENC** control to select the desired DTMF memory.

**Example:** DTMF Memory 5

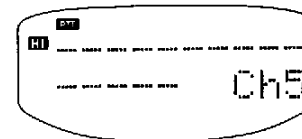

5 Press **[SET]**.



6 Enter the first DTMF digit by pressing **[0]** to **[9]**, **[A]**, **[B]**, **[C]**, **[D]**, **[\*]**, or **[#]**.

- Alternatively, turn the **ENC** control to select a digit, then press **[▶]** to store the digit.
- Press **[◀]** to erase the last digit entered.

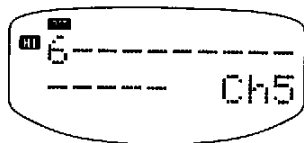

7 Repeat the previous step until all DTMF digits have been entered.

- You may enter a maximum of 15 digits.

8 Press **[SET]**.

9 Press **[MENU]** to exit.

## ■ Confirming Stored DTMF Numbers

1 Press **[MENU]**.

2 Turn the **ENC** control to select "DTMF memory" (9).

3 Press **[SET]**.

4 Select the DTMF memory channel (0 to 9) to be confirmed by turning the **ENC** control.

- The stored DTMF digits are displayed.

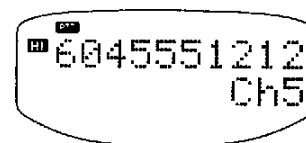

5 Press **[CLR]** twice after confirming the desired DTMF memories to return to the previous mode.

## ■ Storing DTMF Memory IDs

The character library for DTMF memory IDs is the same library that is used for memory channel IDs {page 26}.

- 1 Press **[MENU]**.
- 2 Turn the **ENC** control to select "DTMF memory" (9).

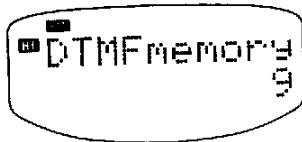

- 3 Press **[SET]**.
- 4 Press **[▶]** to select the DTMF Memory ID Confirmation mode.
- 5 Turn the **ENC** control to select the desired DTMF memory.

**Example:** DTMF Memory 5

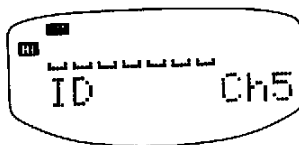

- 6 Press **[SET]** to select ID Entry mode.

- 7 Turn the **ENC** control to select the first character.
  - Pressing **[◀]** deletes the previous character. Press **[◀]** repeatedly to position the blinking cursor, if necessary.
  - To search more quickly through the character library, hold **[MONI]** down and turn the **ENC** control.
  - Pressing **[CLR]** aborts ID Entry mode and returns you to the previous mode.
- 8 Press **[▶]**.
- 9 Repeat Steps 7 and 8 until all characters up to a maximum of 7 are entered.
  - It is not necessary to enter **[▶]** after the final character.
- 10 Press **[SET]** to exit.

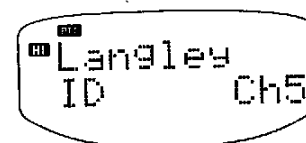

- 11 Press **[CLR]** twice to return to the previous mode.

### **Note:**

- ◆ Repeat Steps 1 to 5 to confirm an entered ID. Press **[CLR]** twice after confirmation is complete.
- ◆ Pressing **[SET]** after all characters have been cleared from the Display will erase these characters from memory.

■ **Transmitting Stored DTMF Numbers  
(Automatic Dialer)**

- 1 Press **[PTT]+[MHz]** and continue holding **[PTT]** down.

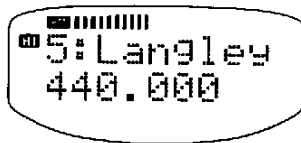

- 2 Select the DTMF memory channel (0 to 9) to be transmitted by one of the following methods:
  - a) Press the corresponding numeric key, or
  - b) Turn the **ENC** control and press **[MHz]**.
  - The stored DTMF digits are displayed as they are transmitted.
  - Transmission continues until all digits are sent. Releasing **[PTT]** will not interrupt the digits being sent or stop transmission.
  - Selecting a DTMF memory channel that has no DTMF number stored causes the previous display to be restored.

■ **Autopatch (U.S.A. and Canada)**

The DTMF function allows you to access the telephone network through some repeaters.

Press **[PTT]+DTMF** keys.

*Note: Some repeaters require a special key sequence to activate Autopatch. Check with the repeater control operator.*

**DTMF Tones**

Freq. (Hz)	1209	1336	1477	1633
697	1	2	3	A
770	4	5	6	B
852	7	8	9	C
941	*	0	#	D

*Note: Press [VFO] before pressing [1] to [8] for single-frequency tones. Press [VFO] to return to dual-frequency mode.*

**Single-Frequency Tones**

Frequency (Hz)	Key	Frequency (Hz)	Key
697	1	1209	5
770	2	1336	6
852	3	1477	7
941	4	1633	8

## SCAN

Scan is a useful function for hands-off monitoring of your favorite frequencies. After becoming comfortable with how to use all types of Scan, the monitoring flexibility gained will increase your operating efficiency.

Scan Type	Purpose
Memory Scan	Quick activity update of your favorite frequencies.
Band Scan	General update on band activity.
Program Scan	Similar to Band Scan except over a narrower segment of the band.
MHz Scan	Scan all frequencies within a 1 MHz range.

**Note:**

- ◆ If PF keys on a microphone being used for remote control of your dual bander are assigned the UP/DOWN functions, scan direction can be reversed using these PF keys. Refer to page 56 for identification of the microphone PF keys and further information.
- ◆ If Page or Tone Alert is ON, Scan will not function.
- ◆ For CTCSS operation, Scan stops and the squelch opens only for signals that contain the same CTCSS tone that is stored in your dual bander.
- ◆ For DTSS operation, Scan stops for any signal received; however, the squelch opens only for signals that contain the same DTSS code that is stored in your dual bander.
- ◆ When both CTCSS and DTSS are ON, Scan stops for signals that contain the matching CTCSS tone. However, the squelch opens only when the matching DTSS code is received.

### SCAN RESUME METHODS

When using Scan, it's necessary to decide under what condition you want your dual bander to continue scanning after detecting and stopping for a signal. You can choose Time-operated Scan or Carrier-operated Scan. The default is Time-operated Scan.

#### ■ Time-Operated Scan

Your dual bander stops scanning after detecting a signal, remains there for approximately 5 seconds, and then continues to scan even if the signal is still present.

#### ■ Carrier-Operated Scan

Your dual bander stops scanning after detecting a signal and remains on the same frequency until the signal drops out. There is a 2 second delay between signal drop-out and scan resumption to allow time for any responding stations to begin transmitting.

## SELECTING SCAN RESUME METHOD

Use the following procedure to switch your dual bander between Time-operated Scan and Carrier-operated Scan.

- 1 Press **[MENU]**.
- 2 Turn the **ENC** control to select "Scan Mode" (17).

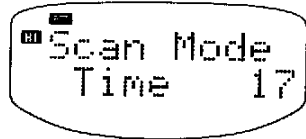

- 3 Press **[SET]** to toggle between "Time" and "Carrier".
  - The default is "Time".
- 4 Press **[MENU]** to exit.

*Note: Holding [MONI] down while scanning halts Scan regardless whether Time-operated or Carrier-operated Scan is selected. Resume scanning by releasing [MONI].*

## MEMORY SCAN

Memory Scan allows all memory channels containing data to be scanned. At least 2 or more memory channels must contain data for Scan to function.

- 1 Press **[BAND]** to select the Operating band.

- 2 Press **[MR]** (1 s).
  - Scan starts with the channel last recalled, then ascends up through the memory channels.
- 3 To reverse the scan direction, turn the **ENC** control.
  - Upward scan: Turn **ENC** clockwise.
  - Downward scan: Turn **ENC** counterclockwise.
- 4 Press **[PTT]** to cancel Memory Scan.

## ■ Locking Out Memory Channels

Memory channels that you prefer not to monitor while scanning can be locked out. By default, all memory channels are not locked out.

- 1 Press **[BAND]** to select the Operating band.
- 2 Press **[MR]** to select Memory Recall.
- 3 Select the memory channel to be locked out using the **ENC** control or the numeric keys.
- 4 Press **[F]**, **[L.OUT]** to lock out the selected channel.
  - A small dot appears before the memory channel number to indicate the channel has been locked out.

Lock-out for an individual channel can be canceled by repeating the above procedure.

## BAND SCAN

Band Scan lets you scan all frequencies from the lowest frequency to the highest frequency on each band. The current frequency step size for each band is used.

- 1 Press **[BAND]** to select the Operating band.
- 2 Press **[VFO]** (1 s).
  - Scan starts at the frequency currently displayed, then ascends upward.

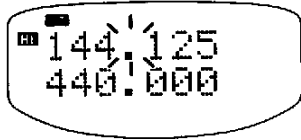

- 3 To reverse the scan direction, turn the **ENC** control.
  - Upward scan: Turn **ENC** clockwise.
  - Downward scan: Turn **ENC** counterclockwise.
- 4 Press **[PTT]** to cancel Band Scan.

## PROGRAM SCAN

Program Scan lets you set limits to restrict the frequency range of the scan. Both limits for a range must be on the same band with equal frequency steps, and the lower limit must be lower in frequency than the upper. Two scan ranges can be stored for each band.

## ■ Setting Scan Limits – VHF Band

- 1 Press **[BAND]** to select the VHF band.
- 2 Press **[VFO]** to select VFO mode.
- 3 Turn the **ENC** control to select the desired lower (or upper) VHF frequency limit for the first range.
- 4 Press **[F]**.
- 5 Turn the **ENC** control to select L1 for the lower limit (or U1 for the upper limit).



- 6 Press **[MR IN]**.
- 7 Repeat Steps 3 to 6 to select and store the other VHF frequency limit in U1 (or L1) for this range.
- 8 Repeat Steps 3 to 7 for the second range using L2 and U2 to store the limits.

## ■ Setting Scan Limits – UHF Band

- 1 Press **[BAND]** to select the UHF band.
- 2 Press **[VFO]** to select VFO mode.
- 3 Turn the **ENC** control to select the desired lower (or upper) UHF frequency limit for this range.
- 4 Press **[F]**.

- 5 Turn the **ENC** control to select L1 for the lower limit (or U1 for the upper limit).
- 6 Press **[MR IN]**.
- 7 Repeat Steps 3 to 6 to select and store the other UHF frequency limit in U1 (or L1) for this range.
- 8 Repeat Steps 3 to 7 for the second range using L2 and U2 to store the limits.

#### ■ Confirming the Programmable Limits

- 1 Press **[BAND]** to select the band to be checked.
- 2 Press **[MR]**.
- 3 Turn the **ENC** control to check the lower limits (L1 and L2).
- 4 Turn the **ENC** control to check the upper limits (U1 and U2).

#### ■ Using Program Scan

- 1 Press **[BAND]** to select the Operating band.
- 2 Press **[VFO]** to select VFO mode, and select a frequency equal to one of the scan limits or between the limits.
  - Selecting a frequency outside the programmed scan limits causes the dual bander to begin Band Scan automatically in the next step.
  - The frequency step size of the VFO must equal the step size of the programmed limits.

- 3 Press **[VFO] (1 s)**.
  - Scan starts at the frequency currently displayed, then ascends upward.
- 4 To reverse the scan direction, turn the **ENC** control.
  - Upward scan: Turn **ENC** clockwise.
  - Downward scan: Turn **ENC** counterclockwise.
- 5 Press **[PTT]** to cancel Program Scan.

*Note: When requirements for both L1/U1 and L2/U2 are satisfied, L1/U1 is given priority. For example, if a frequency is selected that lies within both the L1/U1 and L2/U2 ranges, Program Scan will scan between L1 and U1.*

### MHz SCAN

MHz Scan lets you scan a 1 MHz range of frequencies. The current 1 MHz digit determines the limits of the scan. For example, if the current frequency is 145.010 MHz, then MHz Scan would scan from 145.000 MHz to 145.995 MHz. The upper limit depends on the step size selected.

- 1 Press **[BAND]** to select the Operating band.
- 2 Press **[VFO]** to select VFO mode.
- 3 Press **[MHz] (1 s)** to start MHz Scan.
- 4 Press **[PTT]** to cancel MHz Scan.



## AUXILIARY FUNCTIONS

### BATTERY SAVER

Battery Saver becomes active when the squelch is closed and no key is pressed for more than 10 seconds. This function becomes passive whenever any key is pressed or the squelch is opened. Once the squelch closes and 10 seconds pass with no further key entries, Battery Saver becomes active again.

Battery Saver does not function while scanning.

- 1 Press **[MENU]**.
- 2 Turn the **ENC** control to select "Save" (1).

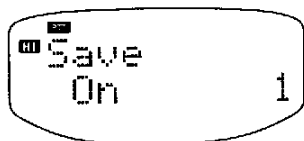

- 3 Press **[SET]** to toggle between "Off" and "On".
  - The default is "On".
- 4 Press **[MENU]** to exit.

### AUTOMATIC POWER OFF (APO)

After 1 hour elapses with no key entries, APO turns OFF the power; however, 1 minute before the power turns OFF, the APO indicator begins blinking and an audio tone sounds. When the power is turned OFF by APO, the frequency disappears from the Display. If the receiver squelch opens or any keys are pressed during the 1 hour period while APO is ON, the timer resets. When the squelch closes or key entry stops, the 1 hour timer begins counting again from 0. APO does not turn OFF the power if Tone Alert is ON.

- 1 Press **[MENU]**.
- 2 Turn the **ENC** control to select "APO" (2).

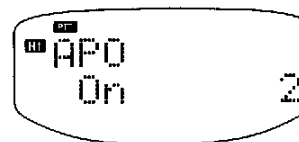

- 3 Press **[SET]** to toggle between "Off" and "On".
  - The default is "On".
- 4 Press **[MENU]** to exit.

To restore power after APO has activated, switch the dual bander power OFF then ON again using the **PWR/VOL** control.

## AUTOMATIC BAND CHANGE (A.B.C.)

A.B.C. automatically but temporarily switches the Receive only band to be the Operating band while in Dual Band mode. This occurs after a signal that opens the squelch is received on the Receive only band. Therefore, replying to a caller is easier without manually selecting the correct band.

Press [F], [A.B.C.] to toggle the A.B.C. function ON or OFF.

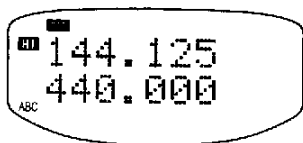

- On receipt of a signal, the "PTT" indicator moves to the band on which the signal was received. All keys are locked except [PTT], [LAMP], [MONI], [SQL], [F], [BAND], and [A.B.C.].
- You have 2 seconds to return a call after the squelch closes, otherwise the original Transmit/Receive band configuration is restored. The A.B.C. function remains active.
- Press [PTT] to cancel A.B.C. and transmit.
- The Operating band when A.B.C. is canceled remains the Operating band.

*Note: While using A.B.C., CTCSS frequencies are checked, however, DTSS/Page codes are not.*

## KEY LOCK

Occasionally, you may want to lock the keys and the **ENC** control to prevent accidentally changing any dual bander settings.

Slide the Lock switch up to lock all keys except [MONI], [LAMP], [PTT], and [SQL]. [TONE] on the TH-79E functions normally if 1750 Hz is selected. Also, microphone PF keys function normally; however, no new functions can be assigned to the PF keys until Key Lock is switched OFF. Refer to page 56 for identification of the microphone PF keys and further information.

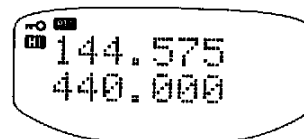

### ■ ENC Lock Release

This function allows the **ENC** control to be used normally even if Key Lock is ON.

- 1 Press [MENU].
- 2 Turn the **ENC** control to select "ENC" (3).

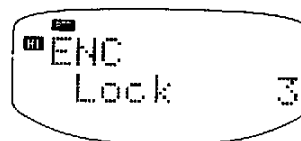

- 3 Press **[SET]** to toggle between "Lock" and "Unlock".
  - The default is "Lock".
- 4 Press **[MENU]** to exit.

## BEEP TONE

The dual bander beeps each time you press a key with the exception of **[MONI]**, **[LAMP]**, and **[PTT]**. The dual bander also beeps to report an alarm condition. Beep volume can be varied by the **VOL** controls.

- 1 Press **[MENU]**.
- 2 Turn the **ENC** control to select "Beep" (15).

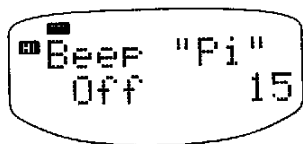

- 3 Press **[SET]** to toggle between "Off" and "On".
  - The default is "On".
- 4 Press **[MENU]** to exit.

## FULL DUPLEX

Full Duplex allows transmission on one band while receiving simultaneously on the other. This operation closely resembles speaking over a telephone.

Each press of the key combination **[F]**, **[DUP]** switches the dual bander as follows:

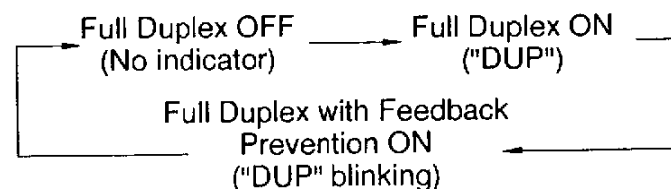

- Full Duplex cannot be switched ON or OFF while using Single Band, VHF/VHF, or UHF/UHF.
- Selecting Single Band mode cancels Full Duplex until Dual Band mode is selected again.
- If Full Duplex is already ON, selecting the VHF/VHF or UHF/UHF configuration cancels Full Duplex.

*Note: When using Full Duplex, connect an earphone to the SP jack. Using an earphone will prevent feedback that can cause the dual bander to emit a howling sound.*

## DISPLAY DEMONSTRATION MODE (SHOW-OFF MODE)

The dual bander displays a pre-programmed message in this mode.

- 1 Press **[PTT]+[F]+ POWER ON** to activate the function.
  - Wait approximately 10 seconds for the pre-programmed message to start scrolling across the Display.
- 2 Press **[LAMP]** to deactivate the function.

## POWER-ON MESSAGE

One way of personalizing your dual bander is to program a unique power-on message. This 7-character message will be displayed each time you switch ON your dual bander. The character library is the same as shown for Memory Channel ID {page 26}.

- 1 Press **[MENU]**.
- 2 Turn the **ENC** control to select "PWR On MSG" (10).

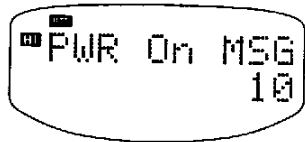

- 3 Press **[SET]**.
- 4 Turn the **ENC** control to select the first character.
  - Pressing **[◀]** deletes the previous character. Press **[◀]** repeatedly to position the blinking cursor, if necessary.
  - To advance more quickly through the character library, hold **[MONI]** down and turn the **ENC** control.
  - Pressing **[CLR]** aborts Message Entry mode and returns you to the previous mode.
- 5 Press **[▶]**.

- 6 Repeat Steps 4 and 5 until all characters are entered.
  - It is not necessary to enter **[▶]** after the final character.

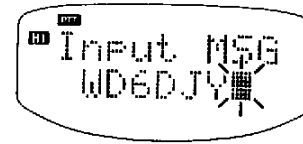

- 7 Press **[SET]**.
- 8 Press **[CLR]** to exit.

## LAMP FUNCTION

Press **[LAMP]** to illuminate the Display. Approximately 5 seconds after releasing **[LAMP]**, the light goes OFF if no other key is pressed. Pressing any key except **[LAMP]** while the Display is lit restarts the 5 second timer. Otherwise, pressing **[LAMP]** turns OFF the light immediately. To latch the light ON, press **[F]**, **[LAMP]**. The Display remains lit until **[F]**, **[LAMP]** is pressed again.

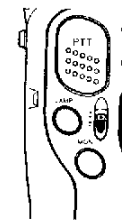

TH-79A

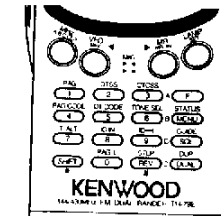

TH-79E

## CONTINUOUS TONE CODED SQUELCH SYSTEM (CTCSS)

The CTCSS function is available only when the TSU-8 CTCSS unit is installed. The U.S.A./ Canada version is supplied with the TSU-8 already installed.

CTCSS functions by using a subaudible tone that is superimposed by a transmitter on a transmitted signal to control a receiver's squelch. When used in combination with the noise squelch, CTCSS provides a simple method to selectively choose which stations will be heard. This dual bander offers a total of 38 standardized CTCSS frequencies. Monitoring is less tiring when using CTCSS since you hear only those stations on a particular frequency that are transmitting the Tone that you have selected.

### SELECTING CTCSS FREQUENCIES

Refer to the chart of frequencies available and the procedure for selecting the desired frequency on page 34. The TH-79E cannot use 1750 Hz for CTCSS operation.

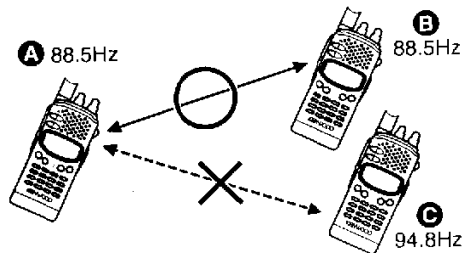

### USING CTCSS

- 1 Press [BAND] to select the Operating band.
- 2 Press [F], [CTCSS].

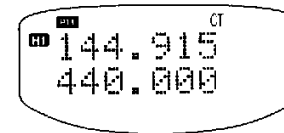

- Although "CT" appears even if the TSU-8 is not installed, CTCSS will not function.

After switching ON the CTCSS function, the squelch will not open until a signal is received that has the selected CTCSS Tone superimposed on the signal. If CTCSS and Tone Alert are ON, there is no speaker output except the alarm tone even if a signal is received with the correct Tone.

**Note:** When using DTSS or Page with CTCSS, the squelch opens only if the correct CTCSS tone is received and the received DTSS or Page code matches the code stored in your dual bander.

**TH-79E:** Selecting 1750 Hz inhibits CTCSS operation. In addition, selecting 1750 Hz switches the CTCSS function OFF automatically if this function is ON at the time. As soon as any Tone frequency other than 1750 Hz is selected, the previous CTCSS status (ON or OFF) is restored.

## DUAL TONE SQUELCH SYSTEM (DTSS)

DTSS provides a more refined method than CTCSS to selectively communicate with specific stations. A total of 1000 3-digit DTMF (Dual Tone Multi-Frequency) codes are available to be used as addresses for stations with which you want to communicate. These codes can be changed easily and regularly as required. Due to the quantity of different codes, large networks can be set up that use DTSS for selective calling and receiving.

If your needs are simpler, DTSS also serves a useful purpose when you only want direct communication with a few close friends on your favorite frequency. A good example of this application is at Hamventions when a particular frequency can be virtually unusable due to overcrowding. If your group switches the DTSS function ON, your squelch only opens when a call is received encoded with the same code that is stored in your dual bander. If no signal is received for more than 2 seconds after DTSS has opened the squelch, the squelch then closes. Anytime you want to monitor all activity on the channel, you simply switch the DTSS function OFF.

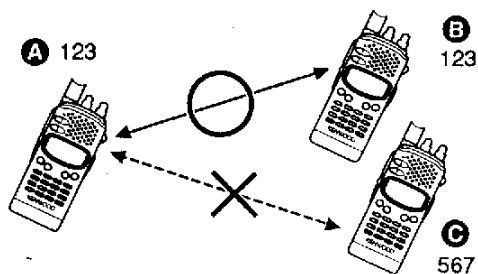

### USING DTSS

The squelch must be closed {page 16} on both bands before beginning this procedure.

- 1 Press **[BAND]** to select the Operating band.
- 2 Press **[F]**, **[DTSS]** to toggle the DTSS function ON or OFF.
- 3 Press **[PTT]** to transmit your DTSS code, then speak into the microphone to call the other station.

To change your stored DTSS code to any number from 000 to 999, continue with the following steps.

- 4 Press **[F]**, **[DT CODE]** to activate Code Select.
  - The default code is 000.

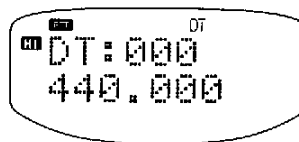

- 5 Enter a 3-digit number using the numeric keys.
  - If you press keys other than the numeric keys, **[LAMP]**, or **[MONI]**, or if you do not make the entry within 10 seconds, the values just entered will clear. The previously set code remains stored.

**Note:**

- ◆ *DTSS may not function in the following situations:*
  - *DTSS is switched ON for both the VHF and UHF bands.*
  - *The other station is using a battery saver function.*
  - *A repeater ID and the DTSS code are received simultaneously.*
- If difficulty is experienced in these cases, press [MR] while still holding [PTT] down to resend the code. Alternatively, release [PTT] then press [PTT] again. Remember to switch ON the DTSS function in advance.*
- ◆ *When [F], [DTSS] is pressed with Page ON, Page is automatically switched OFF, and DTSS is switched ON.*
- ◆ *Both DTSS status and a DTSS code can be stored in a memory channel or the Call channel. Further, when recalling either a memory channel or the Call channel with DTSS status ON while using the VFO with Page switched ON, Page is given priority and the DTSS status switches OFF.*
- ◆ *The microphone is inhibited while the DTSS code is transmitted.*
- ◆ *It's advisable to switch OFF the Battery Saver when you use DTSS.*
- ◆ *If DTSS and Tone Alert are ON, there is no speaker output except the alarm tone even if a signal is received with the correct DTSS code.*

## DTSS AND REPEATERS

Pressing [PTT] transmits the DTSS signal after a short delay. This delay helps avoid losing DTSS data when using repeaters with long response times that may miss receiving a portion of the DTSS code.

The delay time is 350 ms during simplex operation. When using a transmit offset or a split frequency, you can select either 350 ms (default) or 550 ms.

- 1 Press [MENU].
- 2 Turn the **ENC** control to select "CSQL Delay" (8).

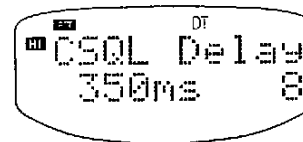

- 3 Press [SET] to toggle between "350" ms and "550" ms.
- 4 Press [MENU] to exit.

**Note:** *DTSS cannot be used with some repeaters. Also, DTSS may not function if a repeater ID and the DTSS code are received simultaneously. Press [MR] while still holding [PTT] down, or press [PTT] again to re-transmit the DTSS code.*

## PAGE

### OVERVIEW

Similar to DTSS, Page uses DTMF codes to address a single station or a group of stations. Page is useful when waiting to receive a call from a specific station. A common Group Page code and individual Station codes should be agreed on in advance. You can select codes from the range 000 to 999 inclusive.

Unlike DTSS, Page offers the added benefit of identifying who called you. The calling station's code appears on the target dual bander's display. If called with an individual Station code, that station's code appears; if called with a Group code, the Group code appears. This characteristic of Page helps reduce the activity level on a frequency when operators are temporarily absent from their stations. There is no longer a need for repeated calls when your target station is not listening. On return to his or her operating position, their dual bander display will show your Station code. They will know immediately that you called.

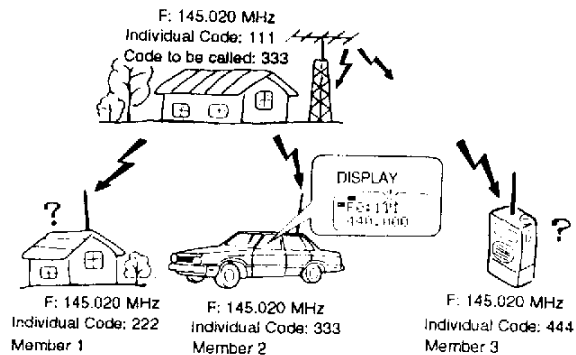

### PAGE CODE MEMORY

The dual bander has 8 Page memories on each band.

<b>A</b>	Stores your Station code.
<b>0</b>	Stores the calling station's code. The dual bander automatically stores this code while in Receive. You also can use the stored code to respond to the other station.
<b>1 to 6</b>	Stores Group codes or Station codes that you want to call.

#### Group Communication Network Example

Predetermined frequency	<b>145. 020 MHz</b>
Your Individual code	<b>111</b>
Member 1	Individual code <b>222</b>
Member 2	Individual code <b>333</b>
Member 3	Individual code <b>444</b>
Group code	<b>789</b>

Your memory	
A	111
0	
1	222
2	333
3	444
4	
5	789

Member 1	A	222
	2	789

Member 2	A	333
	3	789

Member 3	A	444
	4	789



## STORING PAGE CODES

- 1 Press **[BAND]** to select the Operating band.
- 2 Press **[F]**, **[PAG]** to switch ON the Page function.

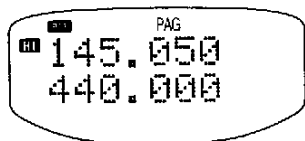

- 3 Press **[F]**, **[PAG CODE]** to activate Code Select.

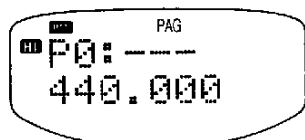

- 4 Turn the **ENC** control to select Page memory A.
- 5 Enter your Station code (000 to 999) using the numeric keys.

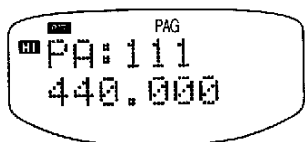

- 6 Select Page memory 1 to 6 by turning the **ENC** control.
- 7 Using the numeric keys, enter a 3-digit Group code or individual Station code.

- 8 To store additional Page codes, repeat Steps 6 and 7.
- 9 Press **[CLR]** to exit Code Select.

You can immediately use the code that was stored or selected last.

## CALLING

The squelch must be closed {page 16} on both bands before beginning this procedure.

- 1 Press **[BAND]** to select the Operating band.
- 2 Tune to the prearranged frequency.
- 3 Press **[F]**, **[PAG]** to switch ON the Page function.
- 4 Press **[F]**, **[PAG CODE]** to select Code Select.
- 5 Turn the **ENC** control to select the Page memory where the desired Group code or individual Station code has been stored.
  - If you have not stored the desired Page code yet, select memory 0 and store the Page code now.
- 6 Press and hold **[PTT]**, then call the other station after the code transmission completes.

### Note:

- ◆ *Page may not function in the following situations:*
  - *Page is switched ON for both the VHF and UHF bands.*
  - *The other station is using a battery saver function.*
  - *A repeater ID and the Page code are received simultaneously.*

If difficulty is experienced in these cases, press **[MR]** while still holding **[PTT]** down to resend the code. Alternatively, release **[PTT]** then press **[PTT]** again. Remember to switch ON the Page function in advance.

- ◆ When Page is ON, Scan cannot be used on the same band.
- ◆ When Page is ON, choosing the VFO, the Call channel, or a memory channel does not affect the Page status. Page remains ON.
- ◆ When Page is switched ON while DTSS is ON, DTSS is switched OFF automatically.

## RECEIVING

The squelch must be closed {page 16} on both bands before beginning this procedure.

- 1 Press **[BAND]** to select the Operating band and select the prearranged frequency.
- 2 Press **[F]**, **[PAG]** to switch ON the Page function.
  - "PAG" appears.

You are ready to receive a call addressed with your Station code or a Group code. If no signal is received for more than 2 seconds after a Page has opened the squelch, the squelch then closes.

### ■ Receiving a Call with your Station Code

When a signal is received encoded with your individual Station code, the squelch opens and you hear an alert tone from the speaker. In addition, the Display shows "P0" and the calling station's code.

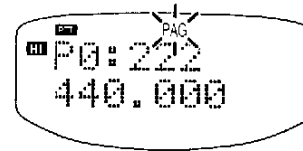

Press **[PTT]** while "PAG" is blinking to respond to the calling party.

### ■ Receiving a Call with a Group Code

When a signal is received encoded with the correct Group code, the squelch opens and you hear an alert tone from the speaker. In addition, the Display shows the received Group code and in which memory (1 to 6) that Group code has been stored.

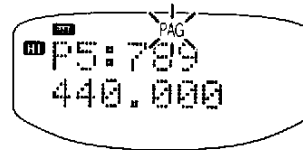

Press **[PTT]** while "PAG" is blinking to respond to the calling party.

#### Note:

- ◆ "Err" appears on the display if your dual bander fails to receive the Page code correctly.
- ◆ The microphone is inhibited while the Page code is transmitted.
- ◆ It's advisable to turn OFF Battery Saver when you use Page.

## LOCKING OUT CODES

This function is useful if you wish to inhibit the dual bander from receiving specific Group Page codes. Page Lockout does not inhibit the dual bander from receiving stations calling your individual Station code. Although the codes are locked out from the receiver, the transmitter still transmits a Page on the locked out codes.

- 1 Press **[BAND]** to select the Operating band.
- 2 Press **[F]**, **[PAG]** to switch ON the Page function.
- 3 Press **[F]**, **[PAG CODE]** to select Code Select.
- 4 Turn the **ENC** control to display a Page code.
- 5 Press **[F]**, **[L.OUT]**.
  - This step toggles the selected Page code between locked out and not locked out.

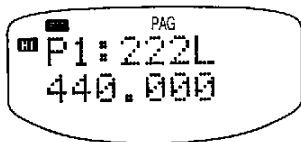

- 6 Press **[CLR]** to exit Code Select.

**Note:** You cannot lock out memory 0 that stores the calling station's code.

## AUTO PAGE CANCEL

After successfully paging another station, it is useful to turn OFF Page to eliminate sending a Page code each time you transmit. Auto Page Cancel handles this situation automatically when a station that you called responds using the correct Page code to open your dual bander's squelch. On your next transmission, your dual bander then switches OFF its Page function.

- 1 Press **[MENU]**.
- 2 Turn the **ENC** control to select "PAG Cancel" (7).

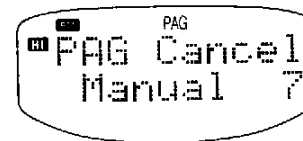

- 3 Press **[SET]** to toggle between "Manual" and "Auto".
  - The default is "Manual".
- 4 Press **[MENU]** to exit.

## PAGE ANSWER BACK (U.S.A./ CANADA ONLY)

Page Answer Back is a confirmation signal consisting of your Station code sent by your station back to the station that initiated a Page call. The purpose is to inform the other station that your station received the Page call. Your station only sends the answer back signal if the station that paged you used a Page code that matched your Station code or Group code, and you have Page Answer Back and Tone Alert switched ON.

- 1 Press **[MENU]**.
- 2 Turn the **ENC** control to select "AnswerBack" (18).

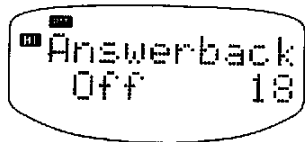

- 3 Press **[SET]** to toggle between "Off" and "On".
- 4 Press **[MENU]** to exit.

To use Page Answer Back, activate the Page function and the Tone Alert function.

## PAGE CODE AND REPEATERS

Pressing **[PTT]** transmits the Page code after a short delay. This delay helps avoid losing Page data when using repeaters with long response times that may miss receiving a portion of the Page code.

The delay time is 350 ms during simplex operation. When using a transmit offset or a split frequency, you can select either 350 ms (default) or 550 ms.

- 1 Press **[MENU]**.
- 2 Turn the **ENC** control to select "CSQL Delay" (8).

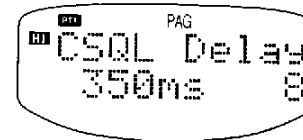

- 3 Press **[SET]** to toggle between "350" ms and "550" ms.
- 4 Press **[MENU]** to exit.

*Note:* Page cannot be used with some repeaters. Also, Page may not function if a repeater ID and the Page code are received simultaneously. Press **[MR]** while still holding **[PTT]** down, or press **[PTT]** again to re-transmit the Page code.

## TONE ALERT

Tone Alert provides an audible alarm to indicate when someone is transmitting on the frequency you are monitoring.

Tone Alert is an effective partner with CTCSS, Page, or DTSS. When the correct signaling comes through, your dual bander beeps to alert you of an incoming call from a specific station.

### ACTIVATING TONE ALERT

- 1 Press **[BAND]** to select the Operating band, and select the prearranged frequency.
- 2 Activate CTCSS, Page, or DTSS if you want to use these together with Tone Alert.
- 3 Press **[F]**, **[T.ALT]**.
  - A Bell icon appears. Each time this key combination is pressed, Tone Alert toggles ON and OFF.
  - If Tone Alert is ON, there is no speaker output except the alarm when a signal is received. To hear receive audio, press **[MONI]**.
- 4 When the correct signal is received, the dual bander rings and the Bell icon begins blinking.
  - The Display shows the number of hours and minutes elapsed after the signal was received. After 99 hours and 59 minutes pass, counting stops. When the next signal is received, the time resets to 00.00 and counting continues. Each time a new signal is received, the time resets to 00.00.
- 5 When the Bell icon is blinking, exit Tone Alert by pressing **[PTT]**.
  - Pressing **[TONE]** on the TH-79E also cancels this function.

#### Note:

- ◆ If Tone Alert is ON, APO does not turn the power OFF.
- ◆ For Tone Alert to function correctly with CTCSS, the incoming signal must be present for approximately 1 second.
- ◆ If Tone is ON, Scan cannot be used on the same band.
- ◆ For Tone Alert to function correctly with DTSS or Page, the correct code must accompany the incoming signals.
- ◆ If you find Tone Alert does not work reliably, your receive signal may contain distortion or a high level of ignition noise. One remedy is to install a TSU-8 CTCSS unit and select a Tone of 141.3 Hz or lower frequency to act as a filter.

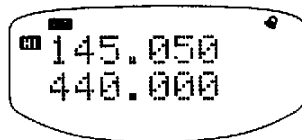

## REMOTE CONTROL

The optional SMC-33 or SMC-34 can be used to remotely control the dual bander for added convenience. The default assignments for the PF keys on these options are as follows:

[1]: [VFO] [2]: [MR]

[3]: [CALL] (TH-79A), [LOW] (TH-79E)

### REASSIGNING THE PF KEYS

Use the default assignments without further change or, if you prefer, customize the key functions.

- 1 Switch OFF the Key Lock function on the dual bander.
- 2 Press [1], [2], or [3]+ POWER ON.

**Example:** Press [1]+ POWER ON.

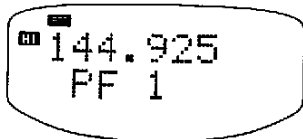

- 3 Press the dual bander key for the function that you wish to assign to the option key pressed in Step 2.

Repeat the same procedure if you wish to assign different functions to the other keys on the option.

## CONNECTING EQUIPMENT FOR REMOTE CONTROL

Make connections as shown below when controlling equipment remotely.

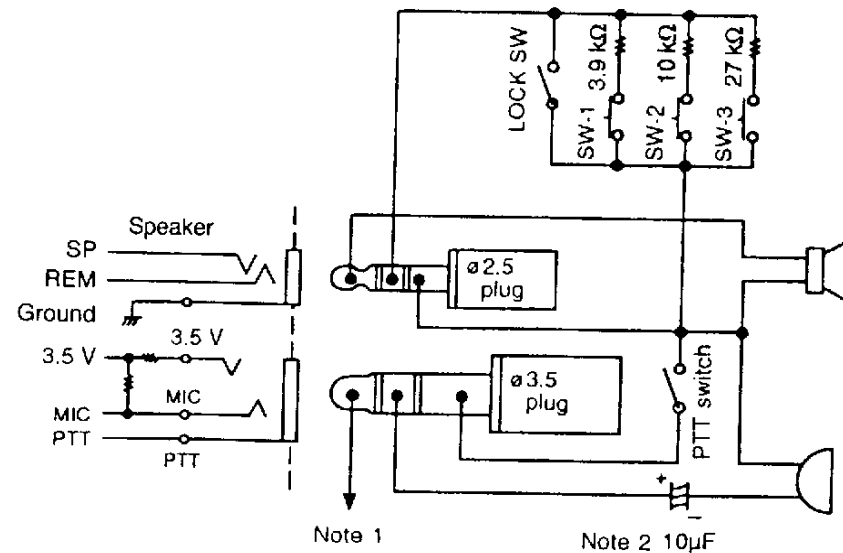

**Note 1:** Voltage is developed across the 100  $\Omega$  resistor in the 3.5 V line in the dual bander. When 2 mA flows, approximately 3.3 V is developed.

**Note 2:** A 10  $\mu$ F capacitor is not required in the following cases. Make direct connections.

- ◆ When the other equipment has DC blocking capacitors.
- ◆ When a 2-terminal condenser microphone is used.

Assignable Functions for PF Keys	Key Entry
Menu select/exit	[MENU]
Status read	[F], [STATUS]
Guide select/exit	[F], [GUIDE]
Band select	[BAND]
VHF/VHF or UHF/UHF mode	[F], [VxV, UxU]
Dual/Single band select	[DUAL]
TX power select	[LOW]
TX offset direction	[SHIFT]
VFO select	[VFO]
VFO/MR select	[PTT]
Squelch set	[SQL]
Monitor ON/OFF	[MONI]
Frequency step	[F], [STEP]
MHz step	[MHz]
Frequency select (UP)	ENC clockwise
Frequency select (DOWN)	ENC counterclockwise
Memory channel recall	[MR]
Memory channel store	[F], [MR IN]
ID store	[F], [ID IN]
ID/frequency select	[F], [ID ↔ f]
Memory → VFO transfer	[F], [M>V]

Assignable Functions for PF Keys	Key Entry
Call channel recall (TH-79A)	[CALL]
Call channel store (TH-79A)	[F], [CALL IN]
Tone ON/OFF (TH-79A)	[F], [TONE]
Tone ON/OFF (TH-79E)	[TONE]
Tone select	[F], [TONE SEL]
Reverse ON/OFF	[REV]
CTCSS ON/OFF	[F], [CTCSS]
DTSS ON/OFF	[F], [DTSS]
DTSS code select	[F], [DT CODE]
Page ON/OFF	[F], [PAG]
Page code select	[F], [PAG CODE]
Memory channel/Page lock out	[F], [L.OUT]
Tone Alert ON/OFF	[F], [T.ALT]
Full Duplex mode	[F], [DUP]
Automatic Band Change (A.B.C.)	[F], [A.B.C.]
Lamp ON/OFF	[LAMP]
Lamp latch ON/OFF	[F], [LAMP]

**Note:**

- ◆ Switch OFF dual bander power before connecting the option.
- ◆ Locking the dual bander keys with Key Lock does not lock the [1], [2], and [3] keys on the options, but they are not functional while transmitting.
- ◆ Pressing a PF key that is assigned the memory channel store function (or Call channel store function) stores the current data on the Display into the last memory channel (or Call channel) that was recalled.

## MAINTENANCE

Your dual bander has been factory aligned and tested to specification before shipment. Under normal circumstances, the dual bander will operate in accordance with these operating instructions. All adjustable trimmers, coils and resistors in the dual bander were preset at the factory. They should only be readjusted by a qualified technician who is familiar with this dual bander and has the necessary test equipment. Attempting service or alignment without factory authorization can void the dual bander warranty. When operated properly, the dual bander will provide years of service and enjoyment without requiring further realignment.

### SERVICE NOTE

If it is ever necessary to return the equipment to your dealer or service center for repair, pack the dual bander in its original box and packing material. Include a full description of the problems experienced. Include your telephone number along with your name and address in case the service technician needs to call for further explanation while investigating your problem. Don't return accessory items unless you feel they are directly related to the service problem.

You may return your dual bander for service to the authorized **KENWOOD** Dealer from whom you purchased it or any authorized **KENWOOD** service center. A copy of the service report will be returned with the dual bander. Please do not send

subassemblies or printed circuit boards. Send the complete dual bander. Tag all returned items with your name and call sign for identification. Please mention the model and serial number of the dual bander in any communication regarding the problem.

If you desire to correspond on a technical or operational problem, please type or print a note that is short, complete, and to the point. Help us help you by providing the following:

- 1 Model and serial number of equipment
- 2 Question or problem you are having
- 3 Other equipment in your station pertaining to the problem
- 4 Meter readings
- 5 Other related information

**CAUTION:** Do not pack the equipment in crushed newspapers for shipment! Extensive damage may result.

**Note:**

- ◆ Record the date of purchase, serial number and dealer from whom the dual bander was purchased.
- ◆ For your own information, retain a written record of any maintenance performed on the dual bander.
- ◆ When claiming warranty service, please include a photocopy of the bill of sale, or other proof-of-purchase showing the date of sale.
- ◆ Remove controls from the dual bander before cleaning them. Use only neutral detergents; no strong chemicals.



## TROUBLESHOOTING

The problems described on the following pages are commonly encountered operational malfunctions. These types of difficulties are usually caused by improper hook-up, accidental incorrect control settings, or operator error due to incomplete programming. These problem symptoms are not caused by circuit failures. Please review this table, and the appropriate section(s) of this Instruction Manual, before assuming your dual bander is defective.

Problem Symptom	Probable Cause	Corrective Action	Page Ref.
Nothing appears on the Display when the dual bander is switched ON, or the Display is blinking ON and OFF.	<ol style="list-style-type: none"> <li>1 Low supply voltage</li> <li>2 If using the optional DC cable:               <ol style="list-style-type: none"> <li>a) Bad power cable or connections</li> <li>b) Open (blown) power supply fuse</li> </ol> </li> </ol>	<ol style="list-style-type: none"> <li>1 Recharge the battery pack or replace the batteries.</li> <li>2               <ol style="list-style-type: none"> <li>a) Check power cable and connections, then repair/replace as necessary.</li> <li>b) Investigate the cause for the open fuse. Replace the fuse.</li> </ol> </li> </ol>	3, 4  i, 66  i, 66
No sound comes from the speaker.	Squelch is closed since no stations are on frequency.	None necessary. The speaker output is muted automatically if no signals are being received. Press <b>[MONI]</b> to override the squelch and verify no stations are on frequency.	7

Continued

**Note:** Unmodulated carriers may be received due to internal frequency relationships.

Problem Symptom	Probable Cause	Corrective Action	Page Ref.
No sound comes from the speaker; stations are on frequency.	<ol style="list-style-type: none"> <li>1 The squelch is closed.</li> <li>2 DTSS is ON ("DT" is visible); DTSS codes that you are receiving are different from the code set in your dual bander.</li> <li>3 Page is ON ("PAG" is visible); Page codes that you are receiving are different from those set in your dual bander.</li> <li>4 If the TSU-8 CTCSS is installed, CTCSS is ON ("CT" is visible); CTCSS tones that you are receiving are different from the tone frequency set in your dual bander.</li> <li>5 Tone Alert is ON (Bell icon is visible).</li> </ol>	<ol style="list-style-type: none"> <li>1 Set the squelch threshold again.</li> <li>2 To monitor activity, press <b>[F]</b>, <b>[DTSS]</b> to switch OFF the DTSS function. To contact stations using DTSS, review "DTSS".</li> <li>3 To monitor activity, press <b>[F]</b>, <b>[PAG]</b> to switch OFF the Page function. To contact stations using Page, review "PAGE".</li> <li>4 To monitor activity, press <b>[F]</b>, <b>[CTCSS]</b> to turn OFF the CTCSS function. To contact stations, review "CTCSS".</li> <li>5 Press <b>[F]</b>, <b>[T.ALT]</b> to switch OFF the Tone Alert function.</li> </ol>	<p>16</p> <p>48</p> <p>52</p> <p>47</p> <p>55</p>
Most keys and the <b>ENC</b> control do not function.	<ol style="list-style-type: none"> <li>1 Key Lock is ON (Key icon is visible).</li> <li>2 Tone Alert is ON (Bell icon is visible).</li> </ol>	<ol style="list-style-type: none"> <li>1 Slide the <b>LOCK</b> switch down to turn OFF the Key Lock function.</li> <li>2 Press <b>[F]</b>, <b>[T.ALT]</b> to switch OFF the Tone Alert function.</li> </ol>	<p>44</p> <p>55</p>
Memory channels cannot be recalled.	There is no data stored in any of the memory channels.	Review "STORING DATA IN MEMORY".	23

Continued

Problem Symptom	Probable Cause	Corrective Action	Page Ref.
The Display shows indicators that are not described in this manual or digits are incomplete. Or, functions do not work as described.	The dual bander needs to be reset.	Review "INITIALIZING MEMORY".	30
The <b>ENC</b> control will not select the exact frequency desired.	The current frequency step needs to be changed.	Select a new frequency step as explained in "SELECTING FREQUENCY STEP SIZE".	19
The dual bander will not transmit. A beep is heard each time <b>[PTT]</b> is pressed.	A frequency outside the transmit range of the dual bander is selected.	Select a frequency within the transmit range of one of the bands.	17
The dual bander switches OFF for no apparent reason.	The Automatic Power Off (APO) function is ON.	Switch OFF the APO function.	43

Continued

Problem Symptom	Probable Cause	Corrective Action	Page Ref.
Packet operation results in no connects with other stations.	<ol style="list-style-type: none"> <li>1 Physical connections between the dual bander, computer, and TNC are incorrect, or software settings in the TNC are wrong.</li> <li>2 Different transmit and receive frequencies are being used. Usually, you must use the same transmit and receive frequency for packet.</li> <li>3 The modulation level from the TNC is incorrect.</li> <li>4 There is multi-path distortion.</li> </ol>	<ol style="list-style-type: none"> <li>1 Recheck all connections using this manual, your TNC manual and your computer hardware manual as reference.</li> <li>2 If using VFO mode, switch OFF the transmit offset. If using Memory Recall, select a simplex memory channel.</li> <li>3 Adjust the TNC modulation level according to the TNC manual.</li> <li>4 Reorient the antenna. The strongest signal does not always provide the best operation on packet.</li> </ol>	<p style="text-align: center;">66</p> <p style="text-align: center;">31, 24</p> <p style="text-align: center;">-</p> <p style="text-align: center;">-</p>
The dual bander does not respond correctly after you press key combinations per instructions in this manual.	Keys are not being pressed in the correct manner.	Review "CONVENTIONS FOLLOWED IN THIS MANUAL". Different functions are selected depending on how long a key is held down or whether a key is released before the next key is pressed, etc.	2

## OPTIONAL ACCESSORIES

CTCSS Unit  
**TSU-8**

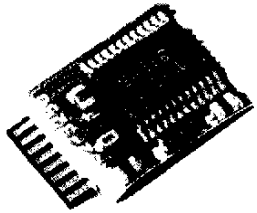

Speaker Microphone  
**SMC-31**



Speaker Microphone  
**SMC-32**



Remote Control  
Speaker Microphone  
**SMC-33**



Remote Control  
Speaker Microphone  
**SMC-34**



Headset with VOX/PTT  
**HMC-2**



Clip Microphone with  
Earphone  
**EMC-1**



2 m/ 70 cm  
Telescopic Antenna  
**RA-5**



Standard Battery Pack  
(4.8 V/ 600 mAh)  
**PB-30**



Standard Battery Pack  
(6 V/ 600 mAh)  
**PB-32**



Long-life Battery Pack  
(6 V/ 1200 mAh)  
**PB-33**



High-power Battery Pack  
(9.6 V/ 600 mAh)  
**PB-34**



Battery Case  
BT-9



Wall Charger  
BC-17



Rapid Charger  
KSC-14

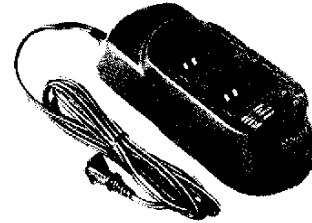

DC Cable  
PG-2W

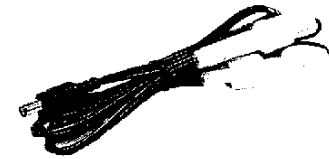

Filtered Cigarette Lighter  
Cable  
PG-3J



Hand Strap  
HB-2



Swivel Mount  
BH-6



Water-resistant Bag  
(Not suitable for U.S.A./  
Canada version)  
WR-2



Soft Case with  
Shoulder Belt  
SC-40

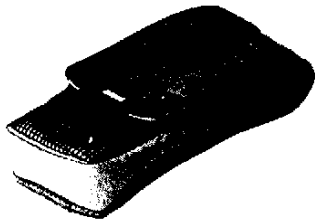

Soft Case  
(for PB-30 & PB-32)  
SC-41



Soft Case  
(for BT-9)  
SC-42



Soft Case  
(for PB-33 & PB-34)  
SC-43



## INSTALLING OPTIONS

### INSTALLING THE TSU-8 CTCSS UNIT (TH-79A (GENERAL), TH-79E)

**CAUTION:** Always switch OFF the power before installing the TSU-8.

- 1 Remove the CTCSS slot cover using a small flat-bladed screwdriver.

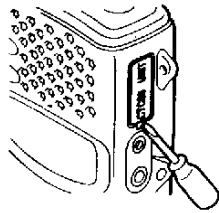

- 2 Trim the excess plastic from the tab on the CTCSS unit.

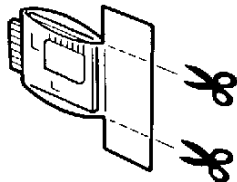

- 3 Fold the plastic tab over the large IC, and position the CTCSS unit in the slot cover as shown.

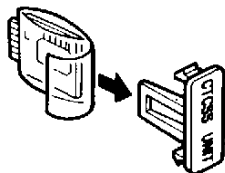

- 4 Insert the CTCSS unit into the CTCSS slot mating the edge connector on the unit with the connector in the dual bander.
- The words "CTCSS UNIT" on the slot cover must be oriented as shown in the diagram.

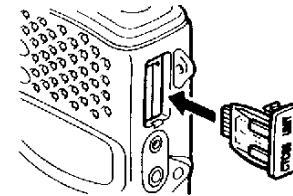

### REMOVING THE TSU-8 CTCSS UNIT

**CAUTION:** Always switch OFF the power before removing the TSU-8.

Remove the CTCSS slot cover using a small flat-bladed screwdriver, then remove the CTCSS unit from the dual bander by pulling on the unit's plastic tab.

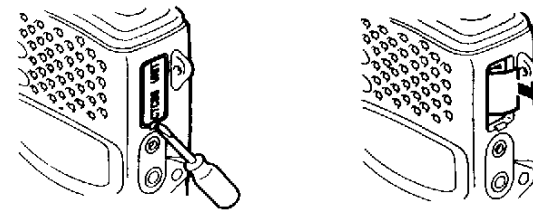

## CONNECTING AN EXTERNAL POWER SOURCE

**CAUTION:** Refer to important information pertaining to using external power sources that is included in PRECAUTIONS on page i.

### ■ Using a Regulated Power Supply

**CAUTION:** Always switch OFF the power before making any connections. Also, only use power supplies recommended by KENWOOD for this application.

- 1 Connect the red lead of the optional PG-2W DC cable to the positive (+) terminal on the power supply. Connect the black lead of this cable to the negative (-) terminal.
- 2 Connect the barrel plug on the DC cable to the DC jack on the side of the dual bander.

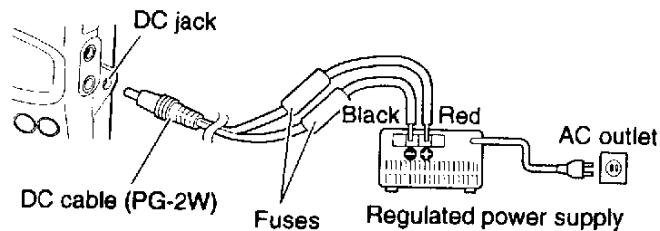

### ■ Using a Cigarette Lighter Socket

Connect the dual bander to the cigarette lighter socket using the optional PG-3J Cigarette Lighter cable.

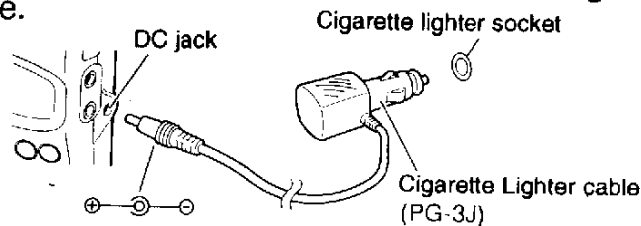

To connect an external 24 V power source via a DC-DC converter, only use a PG-3J Cigarette Lighter cable.

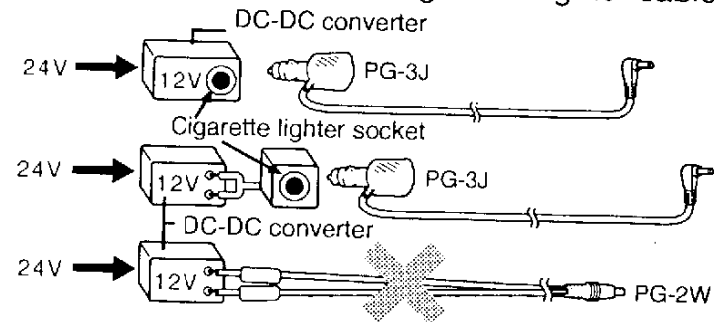

**CAUTION:** NEVER use a PG-2W DC cable in this situation; doing so may cause a fire.

## CONNECTING OTHER EXTERNAL EQUIPMENT

When connecting an external speaker, an external microphone, or other equipment such as a TNC for packet radio to the SP jack or MIC jack, refer to the diagram below.

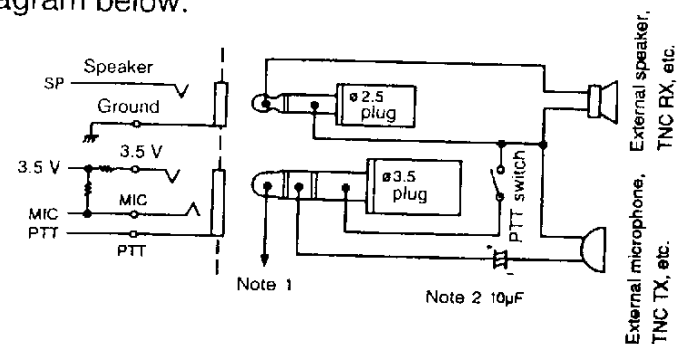

**Note 1:** Voltage is developed across the 100  $\Omega$  resistor in the 3.5 V line in the dual bander. When 2 mA flows, approximately 3.3 V is developed.

**Note 2:** A 10  $\mu$ F capacitor is not required in the following cases. Make direct connections.

- ◆ When the other equipment has DC blocking capacitors.
- ◆ When a 2-terminal condenser microphone is used.



## SPECIFICATIONS

General		144 MHz Band		430/440 MHz Band	
		V	V <sup>2</sup>	U	U <sup>2</sup>
Frequency range					
U.S.A./Canada		144 ~ 148 MHz	144 ~ 148 MHz	438 ~ 450 MHz	438 ~ 450 MHz
Europe		144 ~ 146 MHz	144 ~ 146 MHz	430 ~ 440 MHz	430 ~ 440 MHz
General market		144 ~ 148 MHz	144 ~ 148 MHz	430 ~ 440 MHz	430 ~ 440 MHz
Mode		F3E (FM)			
Usable temperature range		-20°C ~ +60°C (-4°F to +140°F)			
Grounding		Negative ground			
Dimensions <sup>1</sup> ( W x H x D )		56 mm x 129.5 mm x 24.5 mm / 2.20 in x 5.10 in x 0.965 in			
Dimensions <sup>1</sup> ( projections included )		63.5 mm x 144.0 mm x 31.0 mm / 2.50 in x 5.67 in x 1.22 in			
Weight <sup>2</sup>		Approx. 325 g / 11.5 oz			
Microphone impedance		2 kΩ			
Antenna impedance		50 Ω			
Supply voltage (rated voltage)	External power, DC jack	5.5 V ~ 16.0 V (13.8 V)			
	Battery terminals	4.5 V ~ 15.0 V (6.0 V)			
Current	RX (no signal)(dual-band)	Approx. 80 mA			
	RX (no signal)(single-band)	Approx. 45 mA			
	Battery Saver ON	Approx. 20 mA			
	TX (HI, 13.8 V, DC jack)	Approx. 1.3 A			Approx. 1.8 A
	TX (HI, 9.6 V, battery terminals)	Approx. 1.3 A			Approx. 1.8 A
	TX (HI, 6.0 V, battery terminals)	Approx. 1.3 A			Approx. 1.8 A
	TX (HI, 4.8 V, battery terminals)	Approx. 1.2 A			Approx. 1.6 A
	TX (LO, 6.0 V, battery terminals)	Approx. 0.6 A			Approx. 0.6 A
	TX (EL, 6.0 V, battery terminals)	Approx. 300 mA			

<sup>1</sup> PB-32 included.

<sup>2</sup> Antenna, hand strap, belt hook, and PB-32 included.

Transmitter		144 MHz Band	430/440 MHz Band
Output power	HI, 13.8 V, DC jack	Approx. 5 W	Approx. 5 W
	HI, 9.6 V, battery terminals	Approx. 5 W	Approx. 5 W
	HI, 6.0 V, battery terminals	Approx. 2.7 W	Approx. 2.0 W
	HI, 4.8 V, battery terminals	Approx. 1.5 W	Approx. 1.5 W
	LO, 6.0 V, battery terminals	Approx. 0.5 W	
	EL, 6.0 V, battery terminals	Approx. 30 mW	
Modulation		Reactance	
Maximum frequency deviation		Within $\pm 5$ kHz	
Spurious emissions		-60 dB or less	
Receiver		144 MHz Band	430/440 MHz Band
Circuitry		Double conversion superheterodyne	
1st intermediate frequency		38.85 MHz	45.05 MHz
2nd intermediate frequency		450 kHz	455 kHz
Sensitivity (12 dB SINAD)	V or U	0.16 $\mu$ V or less	0.18 $\mu$ V or less
	V <sup>2</sup> or U <sup>2</sup>	0.25 $\mu$ V or less	0.25 $\mu$ V or less
Squelch sensitivity		0.1 $\mu$ V or less	
Selectivity (-6 dB)		12 kHz or more	
Selectivity (-40 dB)		28 kHz or less	
Audio output (10% distortion, 8 $\Omega$ load)		200 mW or higher	

- Specifications apply only when using the V or U band. They do not apply to the V<sup>2</sup> or U<sup>2</sup> band.
- Specifications are subject to change without notice due to developments in technology, and are guaranteed within Amateur bands only.

## INDEX

Accessories: Optional (Pictures) .....	63, 64	Getting Acquainted Picture .....	6, 7	Reset .....	30
Supplied (Table) .....	1	Guide: Function, Index (Table) .....	11, 13	Reverse .....	33
Audio Separation .....	14	Function Identification .....	2	Scan .....	39-42
Automatic: Band Change (A.B.C.) .....	44	Initializing Memory .....	30	Service Note .....	58
Dialer .....	35, 38	Key Lock .....	44	Single Band Mode .....	16
Offset & Canceling .....	32	Keypad: Using .....	24	Specifications Table .....	67, 68
Page Cancel .....	53	Direct Frequency Entry .....	17	Squelch Adjust .....	16
Power Off (APO) .....	43	Lamp Function .....	46	Table(s): Accessories Supplied .....	1
Autopatch (U.S.A. & Canada) .....	38	Locator, Rapid-Find Function Key .....	9	Battery Operating Time (Hours) .....	5
Auxiliary Functions .....	43	Lock, Key & ENC .....	44	Channel Display Function .....	29
Band: Scan .....	41	Maintenance .....	58	Character Library .....	26
Select .....	15	Memory: Channels .....	23~27	CTCSS .....	34
Battery: Information .....	3~5	Initializing .....	30	Displayed Frequencies, Changes In .....	20
External Power Source .....	66	Page Code .....	50	DTMF .....	38
Saver .....	43	Scan .....	40	Function & DTMF Keypad Locator .....	9
Call Channel .....	28	Menu: Setup & Functions Table .....	11, 12	Guide Index .....	13
Channel Display Function & Table .....	29	Offset (Shift) .....	31~33	Menu Functions .....	12
Contents .....	ii-iv	Page .....	50~54	Output Power, Selecting .....	21
Continuous Tone Coded Squelch Sys.(CTCSS) ..	47	PF Keys, Reassigning & Table .....	56, 57	Programmable Function Keys .....	57
Conventions, Key Stroke & Text .....	2	Pictures: Belt Clip & Hand Strap .....		Scan Methods .....	39
Diagrams: Block .....	INSERT	Installation .....	1	Specifications Table .....	67, 68
External Equipment, Connecting Other .....	66	DTMF Keypad and Function Keys .....	8	Status Display .....	13
Remote Control, Connecting For .....	56	Getting Acquainted .....	6, 7	Tone .....	34
Schematics .....	INSERTS (2 pages)	Accessories, Optional .....	63, 64	Troubleshooting .....	59-62
Display .....	10	Power: Auto Off (APO) .....	43	Time-Out Timer (TOT) .....	22
Channel Display Function .....	29	Battery Information .....	3~5	Tone: Alert .....	55
Demonstration (Show-Off) Mode .....	45	Battery Saver .....	43	Beep .....	45
DTMF: Auto Dialer .....	35~38	External Source .....	66	Transmit & Table .....	34
Keypad & Function Keys Picture & Table .....	8, 9	On/Off Switch .....	14	Transmit .....	21, 22
Dual Tone Squelch System (DTSS) .....	48, 49	-On Message .....	46	DTMF Hold .....	35
Duplex, Full .....	45	Precautions .....	i	Inhibit .....	22
Encoder: For Memory Channels .....	24	Programmable: Functions Keys & Table .....	56, 57	Offset (Shift) .....	31~33
Frequency Selection .....	17	VFO .....	18	Tone & Table .....	34
Lock Release .....	44	Rapid-Find Function Key Table .....	9	Troubleshooting Tables .....	59-62
FCC Information .....	INSIDE FRONT COVER	Receiving .....	14~20	UHF/UHF Configuration .....	15
Features .....	1	Remote Control & Connection Diagram .....	56	VFO: Programmable .....	18
Frequency, Changes, Step & Entry .....	17~20	Repeaters: Operating Through .....	31	Reset (Partial Reset) .....	30
Function and .....		And DTSS .....	49	VHF/VHF Configuration .....	15
DTMF Keypad Locator & Table .....	8, 9	And Page .....	54	Volume Controls .....	14

KENWOOD

# TH-79A

## ADDENDUM

# KENWOOD

KENWOOD CORPORATION

©PRINTED IN JAPAN B59-0491-10  
95/ 12 11 10 9 8 7 6 5 4 3 2 1 94/12

### CHANNEL DISPLAY FUNCTION:

This function is toggled ON and OFF by pressing **[BAND]+POWER ON**, as described on page 29 of the Instruction Manual. Channel Display can also be locked ON by performing an internal modification.

Two types of modification are available. One type only locks the Channel Display function to ON. The other modification locks both the Channel Display and Key Lock functions ON (page 44 of the Instruction Manual). If you prefer the latter modification with the **ENCODER** control functional, select "ENC Unlock" by following the steps on page 44 under "ENC Lock Release" before the modification is performed.

Contact your local **KENWOOD** Authorized Amateur Radio Dealer for modification details.

#### NOTE:

To restore your TH-79A to original operation, it must be internally modified again.

### CROSS BAND REPEATER:

Your TH-79A is capable of operating as a "Cross-Band Repeater". In this condition, the TH-79A repeats signals originating from either the VHF or UHF band. For example: When a signal is received on the VHF band, it is retransmitted on the UHF band. The transmitter will remain keyed approximately 500mS after the incoming signal ceases. Similarly, if a signal is received on the UHF band, it is retransmitted on the VHF band.

To operate in the Cross-Band Repeater mode, first set the desired VHF and UHF operating frequencies. To activate the feature, press the **[F]+[MONI]** keys while in the dual band mode. To deactivate the feature, simply press the **MONI** key. The PTT indicator will flash as a visual reminder that the TH-79A is in the Cross-Band Repeater mode.

#### NOTE:

Cross-Band Repeater cannot be switched ON if:  
The VHF/VHF or UHF/UHF configurations are selected (page 15).  
The Operating Band has Tone Alert switched ON (page 55).

When Cross-Band Repeater is ON, Tone Alert (page 55) and Automatic Band Change (page 44) cannot be turned ON.

Tone Alert is turned OFF on the non Operating Band, when Cross-Band Repeater is turned on.

The Automatic Band Change function turns OFF when Cross-Band Repeater is turned ON.

The Time-Out Timer is set to 3 minutes when Cross-Band Repeater is turned ON.