

**KENWOOD**

# Service Manual



**144-/ 220/ 440 Mhz FM TRIBANDER**

## TH-F6A

**144/430 Mhz FM DUAL BANDER**

## TH-F7E



**KENWOOD CORPORATION**



NO.	REV.	DATE	BY	CHKD.

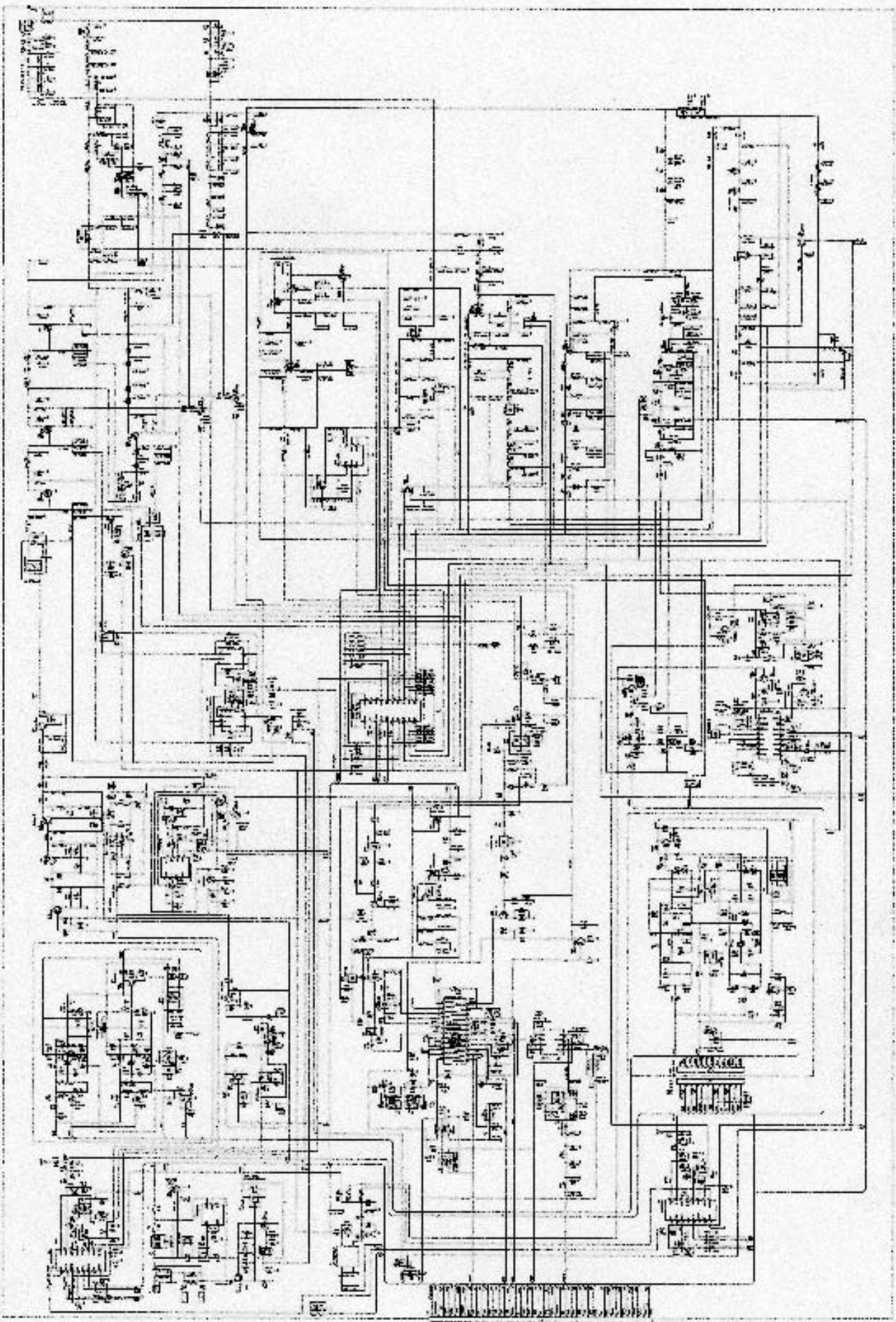



REV	DATE	BY	CHKD
1			
2			
3			
4			
5			
6			
7			
8			
9			
10			

REV	DATE	BY	CHKD
1			
2			
3			
4			
5			
6			
7			
8			
9			
10			

REV	DATE	BY	CHKD
1			
2			
3			
4			
5			
6			
7			
8			
9			
10			

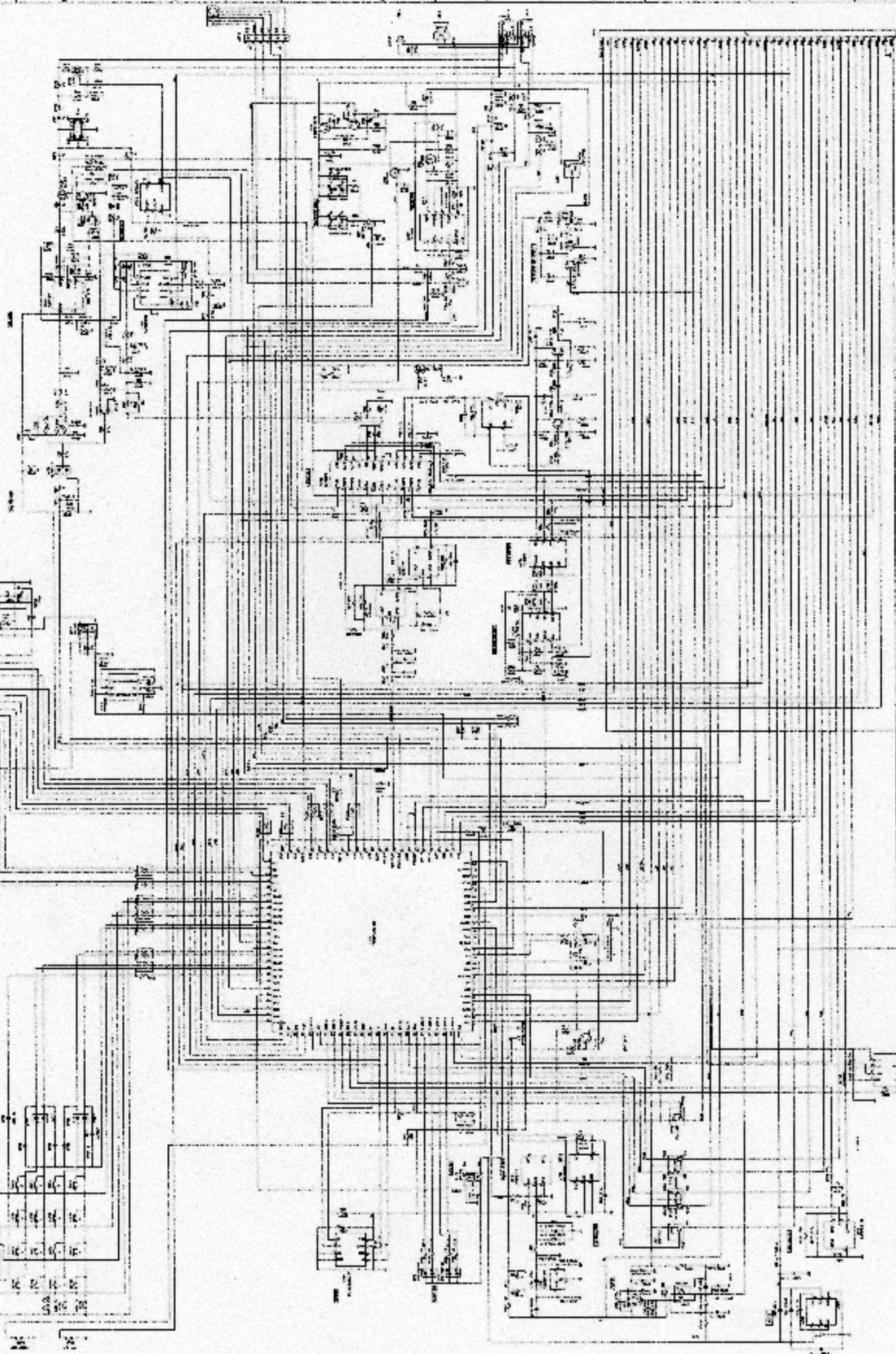

REV	DATE	BY	CHKD
1			
2			
3			
4			
5			
6			
7			
8			
9			
10			

REV	DATE	BY	CHKD
1			
2			
3			
4			
5			
6			
7			
8			
9			
10			

Kenwood TH-F6A/TH-F7E  
Protocol Specification  
Version 1.4

# Warranty, Disclaimer, Assumption of Risk, and Indemnification

ALL DATA AND INFORMATION PROVIDED IN THIS DOCUMENT IS FOR INFORMATIONAL PURPOSES ONLY AND IS AN EXPRESSION OF FREE SPEECH.

**Definition:** The term "person" as used in this section includes not only a natural person but also any entity, (including natural persons). The term "author" is the person or persons who wrote this document. The term "reader" is the user of this document.

**NO WARRANTIES:** TO THE EXTENT PERMITTED BY APPLICABLE LAW, NEITHER THE AUTHOR OF THIS DOCUMENT, NOR ANY PERSON, EITHER EXPRESSLY OR IMPLICITLY, WARRANTS ANY ASPECT OF THIS DOCUMENT, INCLUDING ANY OUTPUT OR RESULTS OF THE USE OF THIS DOCUMENT. UNLESS AGREED TO IN WRITING. THIS DOCUMENT IS BEING PROVIDED "AS IS", WITHOUT ANY WARRANTY OF ANY TYPE OR NATURE, EITHER EXPRESS OR IMPLIED, INCLUDING, BUT NOT LIMITED TO, THE IMPLIED WARRANTIES OF MERCHANTABILITY AND FITNESS FOR A PARTICULAR PURPOSE, AND ANY WARRANTY THAT THIS DOCUMENT IS FREE FROM DEFECTS.

**ASSUMPTION OF RISK:** THE RISK OF ANY AND ALL LOSS, DAMAGE, OR UNSATISFACTORY PERFORMANCE DOCUMENT RESTS WITH THE READER. TO THE EXTENT PERMITTED BY LAW, NEITHER THE AUTHOR OF THIS DOCUMENT, NOR ANY PERSON EITHER EXPRESSLY OR IMPLICITLY, MAKES ANY REPRESENTATION OR WARRANTY REGARDING THE APPROPRIATENESS OF THE USE, OUTPUT, OR RESULTS OF THE USE OF THIS DOCUMENT IN TERMS OF ITS CORRECTNESS, ACCURACY, RELIABILITY, BEING CURRENT OR OTHERWISE. NOR DO THEY HAVE ANY OBLIGATION TO CORRECT ERRORS, MAKE CHANGES, SUPPORT THIS DOCUMENT, DISTRIBUTE UPDATES, OR PROVIDE NOTIFICATION OF ANY ERROR OR DEFECT, KNOWN OR UNKNOWN. IF THE READER RELIES UPON THIS DOCUMENT, THE READER DOES SO AT THEIR OWN RISK, AND THE READER ASSUMES THE RESPONSIBILITY FOR THE RESULTS. SHOULD THIS DOCUMENT PROVE DEFECTIVE OR INCORRECT, THE READER ASSUMES THE COST OF ALL LOSSES, INCLUDING, BUT NOT LIMITED TO, ANY NECESSARY SERVICING, REPAIR OR CORRECTION OF ANY PROPERTY INVOLVED.

**DISCLAIMER:** IN NO EVENT, UNLESS REQUIRED BY APPLICABLE LAW OR AGREED TO IN WRITING, SHALL THE AUTHOR, OR ANY PERSON, OTHER THAN THE READER, BE LIABLE FOR ANY LOSS, EXPENSE OR DAMAGE, OF ANY TYPE OR NATURE ARISING OUT OF THE USE OF, OR INABILITY TO USE THIS DOCUMENT, INCLUDING, BUT NOT LIMITED TO, CLAIMS, SUITS OR CAUSES OF ACTION INVOLVING ALLEGED INFRINGEMENT OF COPYRIGHTS, PATENTS, TRADEMARKS, TRADE SECRETS, OR UNFAIR COMPETITION.

"REVERSE ENGINEERING" OR VIOLATING THE COPYRIGHT OF KENWOOD COMMUNICATIONS CORPORATION OR ANY OTHER THIRD PARTY DID NOT OCCUR IN OBTAINING THE INFORMATION IN THIS DOCUMENT. THE INFORMATION OBTAINED FOR THIS DOCUMENT WAS DISCOVERED BY TRYING ALL ONE, TWO, THREE, AND FOUR LETTER ALPHABETIC COMMANDS SENT TO THE TRANSCEIVER THROUGH A TERMINAL PROGRAM AND LOOKING AT AND EVALUATING THE RESPONSE FROM THE TRANSCEIVER OR BY EXAMINING THE TEXT FILE CREATED BY THE KENWOOD SOFTWARE. THE SCREEN SHOTS OF KENWOOD CORPORATION'S SOFTWARE VIOLATES NO COPYRIGHT SINCE THESE SCREEN SHOTS ARE FOUND IN THE PUBLIC DOMAIN. IT IS THE AUTHOR'S OPINION AS TO WHAT COMMANDS ARE USED TO OBTAIN INFORMATION IN THE KENWOOD SOFTWARE.

**INDEMNIFICATION:** TO THE EXTEND PERMITTED BY LAW THROUGH THIS AGREEMENT, THE READER AGREES TO INDEMNIFY AND HOLD HARMLESS THE AUTHOR OF THIS DOCUMENT, OR ANY PERSON FROM AND AGAINST ALL CLAIMS, LIABILITIES, LOSSES, CAUSES OF ACTION, DAMAGES, JUDGMENTS, AND EXPENSES, INCLUDING THE REASONABLE COST OF ATTORNEYS' FEES AND COURT COSTS, FOR INJURIES OR DAMAGES TO THE PERSON OR PROPERTY OF THIRD PARTIES, INCLUDING, WITHOUT LIMITATIONS, CONSEQUENTIAL DAMAGES AND ECONOMIC LOSSES, THAT ARISE OUT OF OR IN CONNECTION WITH THE READERS USE, MODIFICATION, OR DISTRIBUTION OF THIS DOCUMENT, ITS DERIVATIVES, OR ANY OTHER ACCOMPANYING DOCUMENTATION.



## **Kenwood TH-F6A/TH-F7E Protocol Specification**

This document describes the serial commands used to program and control the Kenwood TH-F6A/TH-F7E handheld transceiver via its serial port.

### **Introduction:**

The Kenwood TH-F6A/TH-F7E transceiver can be programmed through the serial port using a suitable interface optional PC interface cable (PG-4P). This allows memory management (as used by the Kenwood MCP software) as well as software control of the radio.

The information obtained for this document was gathered using the following equipment and software:

Apple Macintosh 17" PowerBook 1Ghz G4 Computer.  
ZTERM V 1.1Beta 7 Terminal Software.  
BBEdit Version 7.02 Text Editing Software.  
Microsoft Word X for Macintosh – Service Release 1.  
KeySpan USA-19QW USB to Serial Port Adaptor.  
Kenwood TH-F6 FM Transceiver.  
Kenwood PG-4P Programming Interface.  
HP 18180A RS-232C/V.24/RS-449 Serial Port Interface.  
HP 4952A Protocol Analyzer.

Here's how I did it. I wrote files that contained all possible one, two, three, and four letter commands using BBEEdit. These files also had each command alone or with a "0" following each command. I sent these files to the TH-F6 using the "Send Text..." menu command in the ZTERM terminal program. Monitored and recorded the communications using the HP 4952A Protocol Analyzer. Edited the recorded responses from the TH-F6 using BBEEdit. In BBEEdit, I setup a regular expression that searched for a response from the TH-F6 that was not a "?". Recorded the commands that had a valid response. Then I went back, with much patience, and "played" with each valid command until I determined its function and syntax. The results of my research were recorded in Microsoft Word.



## List of Tables

Table #	Description
1	APO
2	Balance
3	Band
4	Band Limits
5	Band Switch
6	Battery Saver
7	Battery Type
8	Busy
9	Call Key
10	Character
11	Contrast
12	DCS Code
13	DTMF
14	DTMF Memory Locations
15	DTMF Pause
16	DTMF Speed
17	Dual Mode
18	Fine Tuning Step Size
19	Frequency
20	Frequency Value
21	Ham Band
22	ID
23	Language
24	Lock
25	Logic
26	Memory Channel
27	Memory Group
28	Memory Recall
29	Modulation Mode
30	Name/Frequency Mode
31	Packet Speed
32	Power Level
33	Return Code
34	Scan Resume Method
35	Serial Port Parameters
36	Squelch
37	State
38	Step Size
39	System Reset
40	Tone/CTCSS Frequency Codes
41	VFO Mode
42	VOX Delay
43	VOX Gain

## 1. APO Table

[val]	Time
0	Off
1	30 min
2	60 min

## 2. Balance Table

<b>[val]</b>	<b>A Band</b>	<b>B Band</b>
0	100%	0%
1	75%	25%
2	50%	50%
3	25%	75%
4	0%	100%

### 3. Band Table

[band]	A/B Band	Freq
0	A	2m
1	A	1.25m
2	A	70cm
4	B	AM
5	B	HF
6	B	6m
7	B	FM
8	B	Air
9	B	2m
a	B	VHF TV
b	B	1.25m
c	B	70cm
d	B	UHF TV
e	B	23cm

#### 4. Band Limits Table

[band]	A/B Band	[list]
0	A	2m lower – 2m upper
		1.25m lower – 1.25m upper
		70cm lower – 70cm upper
1	B	AM lower – AM upper
		HF lower – HF upper
		6m lower – 6m Upper
		FM lower – FM upper
		Air lower – Air upper
		2m lower – 2m upper
		VHF TV lower – VHF TV upper
		1.25m lower – 1.25m upper
		70cm lower – 70cm upper
		UHF TV lower – UHF TV upper
		23cm lower – 23cm upper

## 5. Band Switch Table

[val]	A/B
0	A
1	B

## 6. Battery Saver Table

[val]	Time
0	Off
1	0.2
2	0.4
3	0.6
4	0.8
5	1.0 (default)
6	2.0
7	3.0
8	4.0
9	5.0

## 7. Battery Type Table

[val]	Type
0	Lithium
1	Alkaline



## **8. Busy Table**

<b>[stat]</b>	<b>State</b>
0	Not busy
1	Busy

## 9. Call Key Table

[val]	Time
0	Call
1	1750 Hz

## 10. Character Table

Available Characters (TH-F6A)									
A	B	C	D	E	F	G	H	I	J
K	L	M	N	O	P	Q	R	S	T
U	V	W	X	Y	Z	[	]	^	_
`	a	b	c	d	e	f	g	h	i
j	k	l	m	n	o	p	q	r	s
t	u	v	w	x	y	z	{		}
~	\	<i>SP</i>	!	“	#	\$	%	&	‘
(	)	*	+	,	-	.	/	0	1
2	3	4	5	6	7	8	9	:	;
<	=	>	?	@					
Additional Characters (TH-F7E)									
À	Á	Â	Ã	Ä	Å	Æ	Ç	È	É
Ê	Ë	Ì	Í	Î	Ï	Ǝ	Ñ	Ò	Ó
Ô	Õ	Ö		Ø	Ù	Ú	Û	Ü	†
	ß	Œ	à	á	â	ã	ä	å	æ
ç	è	é	ê	ë	ì	í	î	ï	›
ñ	ò	ó	ô	õ	ö	œ	ø	ù	ú
û	ü	‡	ÿ	ÿ					

**11. Contrast Table**

[val]	A
00	(Minimum)
01	
02	
03	
04	
05	
06	
07	
08	Default
09	
10	
11	
12	
13	
14	
15	
16	Maximum

## 12. DCS Code Table

<b>Code</b>	<b>Code</b>	<b>Code</b>	<b>Code</b>
023	152	311	466
025	155	315	503
026	156	325	506
031	162	331	516
032	165	332	523
036	172	343	526
043	174	346	532
047	205	351	546
051	212	356	565
053	223	364	606
054	225	365	612
065	226	371	624
071	243	411	627
072	244	412	631
073	245	413	632
074	246	423	654
114	251	431	662
115	252	432	664
116	255	445	703
122	261	446	712
125	263	452	723
131	265	454	731
132	266	455	732
134	271	462	734
143	274	464	743
145	306	465	754

### 13. DTMF Table

Dual Tone Multi-Frequency (DTMF) Table					
		High-Group Frequencies			
		1209 Hz	1336 Hz	1477 Hz	1633 Hz
Low-Group Frequencies	697 Hz	1	ABC 2	DEF 3	A
	770 Hz	GHI 4	JKL 5	MNO 6	B
	852 Hz	PRS 7	TUV 8	XYZ 9	C
	941 Hz	* 0	OPER 0	#	D

Dual Tone Multi-Frequency, or DTMF is a method for instructing a telephone switching system of the telephone number to be dialed. The DTMF dialing system was developed by AT&T in the 1960s and was deployed within the AT&T telephone network as a way for customers to direct calls using in-band signaling. This was marketed by AT&T under the registered trade name Touch-Tone®.

The DTMF system uses eight different frequency signals transmitted in pairs to represent sixteen different numbers, symbols and letters. This table shows how the frequencies are organized. The frequencies used were chosen to prevent any harmonics from being incorrectly detected by the receiver as some other DTMF frequency. The transmitter of a DTMF signal simultaneously sends one frequency from the high-group and one frequency from the low-group. This pair of signals represents the digit or symbol shown at the intersection of row and column in the table. For example, sending 1209Hz and 770Hz indicates that the "4" digit is being sent.

**14. DTMF Memory Locations Table**

<b>DTMF Memory Locations</b>		
<b>[cc]</b>	<b>Number</b>	<b>Name</b>
00		
01		
02		
03		
04		
05		
06		
07		
08		
09		

## 15. DTMF Pause Table

<b>[val]</b>	<b>Duration</b>
0	100 ms
1	250 ms
2	500 ms
3	750 ms
4	1000 ms
5	1500 ms
6	2000 ms



## **16. DTMF Speed**

<b>[val]</b>	<b>Speed</b>
0	Slow
1	Fast

## 17. Dual Mode Table

[val]	Mode
0	Single
1	Dual

## **18. Fine Tuning Step Size Table**

<b>[val]</b>	<b>Step Size</b>
0	33 Hz
1	100 Hz
2	500 Hz
3	1000 Hz

## 19. Frequency Table

<b>Field</b>	<b>Value</b>	<b>Description</b>	<b>Split Use</b>
freq	11 digits	See Frequency Value Table	yes
step	0-9	See Step table	yes
shift/offset	0, 1, 2	0 = none or split, 1 = positive, 2 = negative	no
rev	0, 1	0 = Reverse off, 1 = Reverse on.	no
tone	0, 1	0 = Tone off, 1 = tone on	no
CTCSS	0, 1	0 = CTCSS off, 1 = CTCSS on	no
DCS	0, 1	0 = DCS off, 1 = DCS on	no
tone freq	1-39	See Tone/CTCSS Frequency Codes Table	no
CTCSS freq	1-39	See Tone/CTCSS Frequency Codes Table	no
DCS code	023 - 754	See DCS Code Table	no
offset freq	9 digits	9 digits in Hz	no
mode	0 - 5	See Mode Table	no
lockout	0, 1	0 = no, 1 = yes	no

## 20. Frequency Value Table

<b>[freq]</b>	
5 digit value	nnnnn – frequency in MHz
11 digit value	nnnnnnnnnnnn – frequency in Hertz

If the frequency is a five (5) digit value, then the frequency is in MHz. If the frequency is an 11 digit value, then the frequency is in Hertz. For example, 00137 is 137.000 MHz, where 00163275000 is 163.275 MHz.

## 21. Ham Band Table

[band]	Ham Band
0	2m
1	1.25m
2	70cm

## 22. ID Table

[id]
TH-F6
TH-F7

## 23. Language Table

<b>[lang]</b>	<b>Language</b>
0	English
1	Japanese (Katakana)



## 24. Lock Table

[val]	State
0	Unlocked
1	Locked

## 25. Logic Table

[val]	State
0	Off
1	On

## 26. Memory Channel Table

<b>[name]</b>	<b>Step Size</b>
000 - 399	400 memory channels
L0 – L9	10 lower scan limit channels
U0 – U9	10 upper scan limit channels
I0 – I9	10 information channels
PR1, PR2	2 priority channels
n/a	3 call channels (one for each of the three bands)
n/a	3 A-band VFO settings
n/a	11 B-band VFO settings
n/a	10 DTMF memories

## **27. Memory Group Table**

<b>1</b>	<b>2</b>	<b>3</b>	<b>4</b>	<b>5</b>	<b>6</b>	<b>7</b>	<b>8</b>
0	1	2	3	4	5	6	7
space	space	space	space	space	space	space	space

Each column contains the valid character for the respective positions. For example, position number five (5) may contain either a four (4) character or an ASCII space character. If the four character is present, the fourth group is linked. If the fifth position contains an ASCII space, the fourth group is not a member of this link.

## **28. Memory Recall Table**

<b>[val]</b>	<b>Method</b>
0	All bands
1	Current band

## 29. Modulation Mode Table

<b>[mode]</b>	<b>Modulation</b>
0	FM
1	WFM
2	AM
3	LSB
4	USB
5	CW

### 30. Name/Frequency Mode Table

[val]	Mode
0	Name
1	Frequency

### **31. Packet Speed Table**

<b>[val]</b>	<b>Speed</b>
0	1200 bps
1	9600 bps



## 32. Power Level Table

<b>[pwr]</b>	<b>Output</b>
0	H
1	L
2	EL

### **33. Return Code Table**

<b>Return Code</b>	<b>Description</b>
N	Radio recognized command, but it was used incorrectly or the invalid parameters were specified.
?	Radio does not recognize the command
command	Command accepted by radio. May be followed by additional values or parameters.

### **34. Scan Resume Table**

<b>[val]</b>	<b>Method</b>
0	Time
1	Carrier
2	Seek

### **35. Serial Port Parameters Table**

<b>Name</b>	<b>Value</b>
speed	9600 Baud
bits	8
parity	none
stop bits	1

## 36. Squelch Table

[val]	
00	No Squelch
01	
02	
03	
04	
05	Highest Squelch

The squelch values range from 00 (no squelch) to 05 (highest squelch). The higher the level, the stronger the signals must be to un-mute the speaker and allow the signal to be received.

### **37. State Table**

<b>[val]</b>	<b>State</b>
0	Disabled
1	Enabled

### 38. Step Size Table

<b>Number</b>	<b>Step Size</b>
0	5.0 kHz
1	6.25 kHz
2	10.0 kHz
3	12.5 kHz
4	15.0 kHz
5	20.0 kHz
6	25.0 kHz
7	30.0 kHz
8	50.0 kHz
9	100.0 kHz

### 39. System Reset Table

Number	Step Size
0	No
1	VFO
2	Menu
3	Full



#### **40. Tone/CTCSS Frequency Codes Table**

<b>#</b>	<b>Tone</b>	<b>#</b>	<b>Tone</b>	<b>#</b>	<b>Tone</b>	<b>#</b>	<b>Tone</b>
01	67.0	12	97.4	23	141.3	34	206.5
02	69.3	13	100.0	24	146.2	35	210.7
03	71.9	14	103.5	25	151.4	36	218.1
04	74.4	15	107.2	26	156.7	37	225.7
05	77.0	16	110.9	27	162.2	38	229.1
06	79.7	17	114.8	28	167.9	39	233.6
07	82.5	18	118.8	29	173.8	40	241.8
08	85.4	19	123.0	30	179.9	41	250.3
09	88.5	20	127.3	31	186.2	42	254.1
10	91.5	21	131.8	32	192.8		
11	94.8	22	136.5	33	203.5		

## 41. VFO Mode Table

[mode]	Mode
0	VFO
1	MR
2	CALL

## 42. VOX Delay Table

<b>[val]</b>	<b>Time</b>
0	250 ms
1	500 ms
2	750 ms
3	1000 ms
4	1500 ms
5	2000 ms
6	3000 ms

### **43. VOX Gain Table**

<b>[val]</b>	
00	Least Sensitive
01	
02	
03	
04	Default
05	
06	
07	
08	
09	Most Sensitive

The VOX Gain value varies from 00 (least sensitive) to 09 (most sensitive). The level should be set to allow the transceiver to reliably switch to transmit mode each time the operator speaks without allowing background noise to trigger the transceiver.

# Commands

## Command Summary

Command	Description	Menu Item
ANT	Bar Antenna	26
APO	Automatic Power Off (APO)	18
ARO	Auto Repeater Offset	05
ATT	Attenuator	n/a
ASC	Auto Simplex Check	n/a
BAL	Volume Balance	n/a
BAT	Battery Type	30
BC	Band Control	n/a
BEL	Tone Alert	n/a
BEP	Beep Function	19
BY	Busy	n/a
CKEY	Call Key	23
CNT	Contrast	16
CR	Call Channel Read	n/a
CW	Call Channel Write	n/a
DATP	Packet Speed	28
DL	Dual	n/a
DLK	DTMF Lock	14
DM	Get/Set DTMF Memory Number Location	10
DMN	Get/Set DTMF Memory Name Location	10
DW	Down	n/a
ELK	Tune Enable	07
FL	Frequency Limits	n/a
FQ	Current Frequency and Step Size	n/a
FST	Fine Tuning Step Size	n/a
ID	Identity of Radio	n/a
LAN	Get/Set Default Language	27
LK	Lock	n/a
LMP	Lamp	n/a
MC	Memory Channel Frequency and Step Size	n/a
MD	Modulation Mode	n/a
MES	Get/Set Power on Message	15

<b>Command</b>	<b>Description</b>	<b>Menu Item</b>
MGL	Memory Group Link	02
MNA	Memory Name	n/a
MNF	Memory Name Frequency	n/a
MR	Memory Channel Read	n/a
MRM	Memory Recall Method	03
MW	Memory Write	n/a
NAR	FM Narrow	29
NSFT	Beat Shift	25
PC	Power Control	n/a
PT	DTMF Pause	13
PV	Program VFO Limits	04
RBN	Set Band	n/a
RX	Receive	n/a
SCR	Scan Resume	01
SQ	Squelch	n/a
SR	Reset	31
SV	Battery Saver	17
TH	1750 Hold	24
TXS	Transmit Inhibit	08
TXH	DTMF Hold	12
TSP	DTMF Speed	11
TT	Transmit Tone	n/a
TYD	Radio Type	n/a
TX	Transmit	n/a
UP	Up	n/a
VMC	Mode of the VFO band	n/a
VOX	VOX Transmit	n/a
VR	VFO Read	n/a
VW	VFO Write	n/a
VXB	VOX on Busy	20
VXD	VOX Delay	22
VXG	VOX Gain	21

## Command Description Format

Mnemonic	Short Description
<i>Description:</i>	Long description of command function.
<i>Function:</i>	Description of what command does to transceiver.
<i>Send:</i>	Format of command sent to transceiver. Parameters for each command are enclosed in [].
<i>Return:</i>	Format of the response from the transceiver.
<i>Where:</i>	A description of the parameters for the command.
<i>Notes:</i>	Any additional information.
<i>Example:</i>	Examples illustrating command use.



ANT	Bar Antenna													
<p><i>Description:</i></p> <p>Enables or disables the bar antenna. <span style="float: right;"><i>Menu Item #</i> 26</span></p>														
<p><i>Function:</i></p> <p>Due to the size limitations of the helical antenna, it may not be suitable for low HF band reception. The transceiver has a built-in bar antenna for reception of HF frequencies. This function allows the transceiver to automatically switch to the bar antenna when a frequency is selected a below 10.1 MHz for the B-band.</p>														
<p><i>Send:</i></p> <table border="1" data-bbox="240 772 1382 814"> <tr> <td>Status:</td> <td>ANT</td> </tr> </table> <table border="1" data-bbox="240 848 1382 890"> <tr> <td>Modify:</td> <td>ANT [val]</td> </tr> </table>			Status:	ANT	Modify:	ANT [val]								
Status:	ANT													
Modify:	ANT [val]													
<p><i>Return:</i></p> <table border="1" data-bbox="240 1035 1382 1077"> <tr> <td>ANT [val]</td> <td></td> </tr> </table>			ANT [val]											
ANT [val]														
<p><i>Where:</i></p> <table border="1" data-bbox="240 1224 1382 1266"> <tr> <td>[val]</td> <td>see State Table</td> </tr> </table>			[val]	see State Table										
[val]	see State Table													
<p><i>Notes:</i></p>														
<p><i>Example:</i></p> <table border="1" data-bbox="240 1560 1382 1633"> <tr> <td>Sent:</td> <td>ANT</td> <td>Requesting status of bar antenna.</td> </tr> <tr> <td>Return:</td> <td>ANT 0</td> <td>Transceiver says that bar antenna is off.</td> </tr> </table> <table border="1" data-bbox="240 1675 1382 1749"> <tr> <td>Sent:</td> <td>ANT 1</td> <td>Requesting bar antenna to be on.</td> </tr> <tr> <td>Return:</td> <td>ANT 1</td> <td>Confirming that bar antenna is now on.</td> </tr> </table>			Sent:	ANT	Requesting status of bar antenna.	Return:	ANT 0	Transceiver says that bar antenna is off.	Sent:	ANT 1	Requesting bar antenna to be on.	Return:	ANT 1	Confirming that bar antenna is now on.
Sent:	ANT	Requesting status of bar antenna.												
Return:	ANT 0	Transceiver says that bar antenna is off.												
Sent:	ANT 1	Requesting bar antenna to be on.												
Return:	ANT 1	Confirming that bar antenna is now on.												

APO		Automatic Power Off	
<i>Description:</i>			
Gets or sets the Automatic Power Off (APO) feature.		<i>Menu Item #</i> 18	
<i>Function:</i>			
The transceiver switches OFF automatically if no keys or controls are pressed or adjusted, and no signal is received for the selected time. A warning beep sounds one minute before the transceiver switches OFF.			
<i>Send:</i>			
Status:	APO		
Modify:	APO [val]		
<i>Return:</i>			
APO [val]			
<i>Where:</i>			
[val]	see APO Table		
<i>Notes:</i>			
<i>Example:</i>			
Sent:	APO	Requesting status of automatic power off.	
Return:	APO 1	Transceiver says that automatic power off is on.	
Sent:	APO 0	Requesting automatic power off is off.	
Return:	APO 0	Confirming that automatic power off is off.	

ARO	Auto Repeater Offset	
<i>Description:</i>		
Turns on or off or gets state of the Auto Repeater Offset (ARO) function.		<i>Menu Item #</i> 05
<i>Function:</i>		
This function automatically selects an offset direction, according to the frequency that you select on the 2 m and 1.25 m (TH-F6A only) bands.		
<i>Send:</i>		
Status:	ARO	
Modify:	ARO [val]	
<i>Return:</i>		
ARO [val]		
<i>Where:</i>		
[val]	see Logic Table	
<i>Notes:</i>		
<i>Example:</i>		
Sent:	ARO	Requesting status of ARO
Return:	ARO 0	Transceiver says that ARO is off.
Sent:	ARO 1	Requesting ARO to be on
Return:	ARO 1	Confirming that ARO is now on.

ASC	Auto Simplex Check	
<i>Description:</i>		
Get or set Auto Simplex Check for a given band.		<i>Menu Item #</i> n/a
<i>Function:</i>		
Periodically checks the signal strength of received signal to see if it is strong enough to allow contact without a repeater.		
<i>Send:</i>		
Status:	ASC [band]	
Modify:	ASC [band],[val]	
<i>Return:</i>		
ASC [band],[val]		
<i>Where:</i>		
[band]	see Band Switch Table	
[val]	see Logic Table	
<i>Notes:</i>		
<i>Example:</i>		
Sent:	ASC 0	Status of Auto Simplex Check on A band.
Return:	ASC 0,0	Auto Simplex Check is off on A band.
Sent:	ASC 1,1	Request that B band ASC be on.
Return:	ASC 1,1	Transceiver confirms.

ATT	Attenuator													
<p><i>Description:</i></p> <p>Gets or sets the attenuator. <span style="float: right;"><i>Menu Item #</i> <i>n/a</i></span></p>														
<p><i>Function:</i></p> <p>Use to attenuate nearby or extremely strong signals to prevent erroneously control and overload. The attenuator is approximately 20 DB when ON.</p>														
<p><i>Send:</i></p> <table border="1" data-bbox="240 701 1382 741"> <tr> <td>Status:</td> <td colspan="2">ATT</td> </tr> </table> <table border="1" data-bbox="240 779 1382 819"> <tr> <td>Modify:</td> <td colspan="2">ATT [val]</td> </tr> </table>			Status:	ATT		Modify:	ATT [val]							
Status:	ATT													
Modify:	ATT [val]													
<p><i>Return:</i></p> <table border="1" data-bbox="240 968 1382 1008"> <tr> <td>ATT [val]</td> <td colspan="2"></td> </tr> </table>			ATT [val]											
ATT [val]														
<p><i>Where:</i></p> <table border="1" data-bbox="240 1152 1382 1192"> <tr> <td>[val]</td> <td colspan="2">see Logic Table</td> </tr> </table>			[val]	see Logic Table										
[val]	see Logic Table													
<p><i>Notes:</i></p>														
<p><i>Example:</i></p> <table border="1" data-bbox="240 1486 1382 1562"> <tr> <td>Sent:</td> <td>ATT</td> <td>Requesting status of attenuator.</td> </tr> <tr> <td>Return:</td> <td>ATT 1</td> <td>Transceiver says that attenuator is on.</td> </tr> </table> <table border="1" data-bbox="240 1600 1382 1675"> <tr> <td>Sent:</td> <td>ATT 0</td> <td>Requesting attenuator is off.</td> </tr> <tr> <td>Return:</td> <td>ATT 0</td> <td>Confirming that attenuator is off.</td> </tr> </table>			Sent:	ATT	Requesting status of attenuator.	Return:	ATT 1	Transceiver says that attenuator is on.	Sent:	ATT 0	Requesting attenuator is off.	Return:	ATT 0	Confirming that attenuator is off.
Sent:	ATT	Requesting status of attenuator.												
Return:	ATT 1	Transceiver says that attenuator is on.												
Sent:	ATT 0	Requesting attenuator is off.												
Return:	ATT 0	Confirming that attenuator is off.												

BAL	Volume Balance													
<p><i>Description:</i></p> <p>Gets or sets the volume balance between A and B bands. <span style="float: right;"><i>Menu Item #</i> n/a</span></p>														
<p><i>Function:</i></p> <p>While receiving on the A and B bands at the same time, one band's audio output may be too loud. This function adjusts the volume balance level of the bands.</p>														
<p><i>Send:</i></p> <table border="1" data-bbox="240 701 1382 741"> <tr> <td>Status:</td> <td colspan="2">BAL</td> </tr> </table> <table border="1" data-bbox="240 779 1382 819"> <tr> <td>Modify:</td> <td colspan="2">BAL [val]</td> </tr> </table>			Status:	BAL		Modify:	BAL [val]							
Status:	BAL													
Modify:	BAL [val]													
<p><i>Return:</i></p> <table border="1" data-bbox="240 968 1382 1008"> <tr> <td>BAL [val]</td> <td colspan="2"></td> </tr> </table>			BAL [val]											
BAL [val]														
<p><i>Where:</i></p> <table border="1" data-bbox="240 1155 1382 1194"> <tr> <td>[val]</td> <td colspan="2">see Balance Table.</td> </tr> </table>			[val]	see Balance Table.										
[val]	see Balance Table.													
<p><i>Notes:</i></p> <p>Default value is 2 (both A and b bands equal).</p>														
<p><i>Example:</i></p> <table border="1" data-bbox="240 1486 1382 1564"> <tr> <td>Sent:</td> <td>BAL</td> <td>Requesting status of Balance.</td> </tr> <tr> <td>Return:</td> <td>BAL 2</td> <td>Transceiver says that Balance is set to 2.</td> </tr> </table> <table border="1" data-bbox="240 1602 1382 1680"> <tr> <td>Sent:</td> <td>BAL 0</td> <td>Requesting balance to be A band only.</td> </tr> <tr> <td>Return:</td> <td>BAL 0</td> <td>Confirming that balance to be A band only.</td> </tr> </table>			Sent:	BAL	Requesting status of Balance.	Return:	BAL 2	Transceiver says that Balance is set to 2.	Sent:	BAL 0	Requesting balance to be A band only.	Return:	BAL 0	Confirming that balance to be A band only.
Sent:	BAL	Requesting status of Balance.												
Return:	BAL 2	Transceiver says that Balance is set to 2.												
Sent:	BAL 0	Requesting balance to be A band only.												
Return:	BAL 0	Confirming that balance to be A band only.												

BAT	Battery Type													
<p><i>Description:</i></p> <p>Gets or sets the battery type. <span style="float: right;"><i>Menu Item #</i> 30</span></p>														
<p><i>Function:</i></p> <p>Used for estimating the remaining battery capacity. The battery type should be set to the type of battery that is in use (either lithium or alkaline).</p>														
<p><i>Send:</i></p> <table border="1" data-bbox="240 701 1382 741"> <tr> <td>Status:</td> <td colspan="2">BAT</td> </tr> </table> <table border="1" data-bbox="240 779 1382 819"> <tr> <td>Modify:</td> <td colspan="2">BAT [val]</td> </tr> </table>			Status:	BAT		Modify:	BAT [val]							
Status:	BAT													
Modify:	BAT [val]													
<p><i>Return:</i></p> <table border="1" data-bbox="240 968 1382 1008"> <tr> <td>BAT [val]</td> <td colspan="2"></td> </tr> </table>			BAT [val]											
BAT [val]														
<p><i>Where:</i></p> <table border="1" data-bbox="240 1152 1382 1192"> <tr> <td>[val]</td> <td colspan="2">see Battery Type Table</td> </tr> </table>			[val]	see Battery Type Table										
[val]	see Battery Type Table													
<p><i>Notes:</i></p>														
<p><i>Example:</i></p> <table border="1" data-bbox="240 1486 1382 1564"> <tr> <td>Sent:</td> <td>BAT</td> <td>Requesting battery type.</td> </tr> <tr> <td>Return:</td> <td>BAT 0</td> <td>Transceiver says that battery type is lithium.</td> </tr> </table> <table border="1" data-bbox="240 1602 1382 1680"> <tr> <td>Sent:</td> <td>BAT 1</td> <td>Requesting battery type is alkaline.</td> </tr> <tr> <td>Return:</td> <td>BAT 1</td> <td>Confirming that battery type is alkaline.</td> </tr> </table>			Sent:	BAT	Requesting battery type.	Return:	BAT 0	Transceiver says that battery type is lithium.	Sent:	BAT 1	Requesting battery type is alkaline.	Return:	BAT 1	Confirming that battery type is alkaline.
Sent:	BAT	Requesting battery type.												
Return:	BAT 0	Transceiver says that battery type is lithium.												
Sent:	BAT 1	Requesting battery type is alkaline.												
Return:	BAT 1	Confirming that battery type is alkaline.												

BC	Band Control	
<i>Description:</i>		
Gets or sets the current band.		<i>Menu Item #</i> n/a
<i>Function:</i>		
Selects the A band or B band for operation.		
<i>Send:</i>		
Status:	BC	
Modify:	BC [band]	
<i>Return:</i>		
BC [val]		
<i>Where:</i>		
[val]	see Band Switch Table	
<i>Notes:</i>		
<i>Example:</i>		
Sent:	BC	Requesting band control status.
Return:	BC 0	Transceiver says that band is set to A.
Sent:	BC 1	Requesting band to be set to B.
Return:	BC 1	Confirming that band is set to B.



BEP	Beep Function													
<p><i>Description:</i></p> <p>Gets or sets the beep function. <span style="float: right;"><i>Menu Item #</i> 19</span></p>														
<p><i>Function:</i></p> <p>The beep function provides an audible confirmation of entry, error status, and malfunctions of the transceiver.</p>														
<p><i>Send:</i></p> <table border="1" data-bbox="240 701 1382 741"> <tr> <td>Status:</td> <td colspan="2">BEP</td> </tr> </table> <table border="1" data-bbox="240 779 1382 819"> <tr> <td>Modify:</td> <td colspan="2">BEP [val]</td> </tr> </table>			Status:	BEP		Modify:	BEP [val]							
Status:	BEP													
Modify:	BEP [val]													
<p><i>Return:</i></p> <table border="1" data-bbox="240 968 1382 1008"> <tr> <td>BEP [val]</td> <td colspan="2"></td> </tr> </table>			BEP [val]											
BEP [val]														
<p><i>Where:</i></p> <table border="1" data-bbox="240 1152 1382 1192"> <tr> <td>[val]</td> <td colspan="2">see Logic Table</td> </tr> </table>			[val]	see Logic Table										
[val]	see Logic Table													
<p><i>Notes:</i></p>														
<p><i>Example:</i></p> <table border="1" data-bbox="240 1486 1382 1564"> <tr> <td>Sent:</td> <td>BEP</td> <td>Requesting status of beep function.</td> </tr> <tr> <td>Return:</td> <td>BEP 1</td> <td>Transceiver says that beep function is on.</td> </tr> </table> <table border="1" data-bbox="240 1602 1382 1680"> <tr> <td>Sent:</td> <td>BEP 0</td> <td>Requesting beep function is off.</td> </tr> <tr> <td>Return:</td> <td>BEP 0</td> <td>Confirming that beep function is off.</td> </tr> </table>			Sent:	BEP	Requesting status of beep function.	Return:	BEP 1	Transceiver says that beep function is on.	Sent:	BEP 0	Requesting beep function is off.	Return:	BEP 0	Confirming that beep function is off.
Sent:	BEP	Requesting status of beep function.												
Return:	BEP 1	Transceiver says that beep function is on.												
Sent:	BEP 0	Requesting beep function is off.												
Return:	BEP 0	Confirming that beep function is off.												

BEL	Tone Alert													
<p><i>Description:</i></p> <p>Gets or sets the tone alert function. <span style="float: right;"><i>Menu Item #</i> n/a</span></p>														
<p><i>Function:</i></p> <p>Provides an audible alarm when signals are received on the monitored frequency.</p>														
<p><i>Send:</i></p> <table border="1" data-bbox="240 699 1380 741"> <tr> <td>Status:</td> <td>BEL [band]</td> </tr> </table> <table border="1" data-bbox="240 777 1380 819"> <tr> <td>Modify:</td> <td>BEL [band],[val]</td> </tr> </table>			Status:	BEL [band]	Modify:	BEL [band],[val]								
Status:	BEL [band]													
Modify:	BEL [band],[val]													
<p><i>Return:</i></p> <table border="1" data-bbox="240 961 1380 1003"> <tr> <td>BEL [band],[val]</td> <td></td> </tr> </table>			BEL [band],[val]											
BEL [band],[val]														
<p><i>Where:</i></p> <table border="1" data-bbox="240 1150 1380 1192"> <tr> <td>[band]</td> <td>see Band Switch Table.</td> </tr> </table> <table border="1" data-bbox="240 1192 1380 1234"> <tr> <td>[val]</td> <td>see Logic Table.</td> </tr> </table>			[band]	see Band Switch Table.	[val]	see Logic Table.								
[band]	see Band Switch Table.													
[val]	see Logic Table.													
<p><i>Notes:</i></p>														
<p><i>Example:</i></p> <table border="1" data-bbox="240 1522 1380 1606"> <tr> <td>Sent:</td> <td>BEL 0</td> <td>Requesting status of tone alert on A band.</td> </tr> <tr> <td>Return:</td> <td>BEL 0,0</td> <td>Transceiver says that tone alert is off.</td> </tr> </table> <table border="1" data-bbox="240 1638 1380 1722"> <tr> <td>Sent:</td> <td>BEL 1,1</td> <td>Requesting that tone alert is on B band.</td> </tr> <tr> <td>Return:</td> <td>BEL 1,1</td> <td>Confirming that tone alert is on B band.</td> </tr> </table>			Sent:	BEL 0	Requesting status of tone alert on A band.	Return:	BEL 0,0	Transceiver says that tone alert is off.	Sent:	BEL 1,1	Requesting that tone alert is on B band.	Return:	BEL 1,1	Confirming that tone alert is on B band.
Sent:	BEL 0	Requesting status of tone alert on A band.												
Return:	BEL 0,0	Transceiver says that tone alert is off.												
Sent:	BEL 1,1	Requesting that tone alert is on B band.												
Return:	BEL 1,1	Confirming that tone alert is on B band.												

BY	Busy							
<p><i>Description:</i></p> <p>Displays Busy status of a band. <span style="float: right;"><i>Menu Item #</i> <i>n/a</i></span></p>								
<p><i>Function:</i></p> <p>Busy is the status of the transceiver squelch. If the channel is busy, the squelch is open. If the channel is not busy, the squelch is closed.</p>								
<p><i>Send:</i></p> <table border="1" data-bbox="240 701 1382 741"> <tr> <td data-bbox="240 701 428 741">Status:</td> <td data-bbox="428 701 1382 741">BY [band]</td> </tr> </table>			Status:	BY [band]				
Status:	BY [band]							
<p><i>Return:</i></p> <table border="1" data-bbox="240 888 1382 928"> <tr> <td data-bbox="240 888 573 928">BY [band], [stat]</td> <td data-bbox="573 888 1382 928"></td> </tr> </table>			BY [band], [stat]					
BY [band], [stat]								
<p><i>Where:</i></p> <table border="1" data-bbox="240 1075 1382 1157"> <tr> <td data-bbox="240 1075 428 1115">[band]</td> <td data-bbox="428 1075 1382 1115">see Band Switch Table</td> </tr> <tr> <td data-bbox="240 1115 428 1157">[stat]</td> <td data-bbox="428 1115 1382 1157">see Busy Table</td> </tr> </table>			[band]	see Band Switch Table	[stat]	see Busy Table		
[band]	see Band Switch Table							
[stat]	see Busy Table							
<p><i>Notes:</i></p>								
<p><i>Example:</i></p> <table border="1" data-bbox="240 1444 1382 1526"> <tr> <td data-bbox="240 1444 380 1484">Sent:</td> <td data-bbox="380 1444 743 1484">BY 0</td> <td data-bbox="743 1444 1382 1484">Requesting busy status of A band.</td> </tr> <tr> <td data-bbox="240 1484 380 1526">Return:</td> <td data-bbox="380 1484 743 1526">BY 0,1</td> <td data-bbox="743 1484 1382 1526">Transceiver says that A band is busy.</td> </tr> </table>			Sent:	BY 0	Requesting busy status of A band.	Return:	BY 0,1	Transceiver says that A band is busy.
Sent:	BY 0	Requesting busy status of A band.						
Return:	BY 0,1	Transceiver says that A band is busy.						

CKEY	Call Key													
<p><i>Description:</i></p> <p>Gets or select a function for the Call key. <span style="float: right;"><i>Menu Item #</i> 23</span></p>														
<p><i>Function:</i></p> <p>Reassigns the function of the Call key. If Call is selected, the Call key recalls the call channel. If in 1750 Hz mode, pressing the Call key forces the transceiver to transmit a 1750 Hz tone.</p>														
<p><i>Send:</i></p> <table border="1" data-bbox="240 737 1382 779"> <tr> <td>Status:</td> <td colspan="2">CKEY</td> </tr> </table> <table border="1" data-bbox="240 814 1382 856"> <tr> <td>Modify:</td> <td colspan="2">CKEY [val]</td> </tr> </table>			Status:	CKEY		Modify:	CKEY [val]							
Status:	CKEY													
Modify:	CKEY [val]													
<p><i>Return:</i></p> <table border="1" data-bbox="240 999 1382 1041"> <tr> <td>CKEY [val]</td> <td colspan="2"></td> </tr> </table>			CKEY [val]											
CKEY [val]														
<p><i>Where:</i></p> <table border="1" data-bbox="240 1188 1382 1230"> <tr> <td>[val]</td> <td colspan="2">see Call Key Table</td> </tr> </table>			[val]	see Call Key Table										
[val]	see Call Key Table													
<p><i>Notes:</i></p>														
<p><i>Example:</i></p> <table border="1" data-bbox="240 1524 1382 1598"> <tr> <td>Sent:</td> <td>CKEY</td> <td>Requesting status of Call key.</td> </tr> <tr> <td>Return:</td> <td>CKEY 0</td> <td>Transceiver says that Call key is set to Call.</td> </tr> </table> <table border="1" data-bbox="240 1640 1382 1713"> <tr> <td>Sent:</td> <td>CKEY 1</td> <td>Requesting Call key be set to 1750 Hz.</td> </tr> <tr> <td>Return:</td> <td>CKEY 1</td> <td>Confirming that Call key is 1750 Hz.</td> </tr> </table>			Sent:	CKEY	Requesting status of Call key.	Return:	CKEY 0	Transceiver says that Call key is set to Call.	Sent:	CKEY 1	Requesting Call key be set to 1750 Hz.	Return:	CKEY 1	Confirming that Call key is 1750 Hz.
Sent:	CKEY	Requesting status of Call key.												
Return:	CKEY 0	Transceiver says that Call key is set to Call.												
Sent:	CKEY 1	Requesting Call key be set to 1750 Hz.												
Return:	CKEY 1	Confirming that Call key is 1750 Hz.												

CNT	Contrast													
<p><i>Description:</i></p> <p>Gets or Adjust the display contrast. <span style="float: right;"><i>Menu Item #</i> 16</span></p>														
<p><i>Function:</i></p> <p>Used to adjust the LCD Display Contrast level from 01 (weakest) to 16 (strongest).</p>														
<p><i>Send:</i></p> <table border="1" data-bbox="240 663 1382 705"> <tr> <td>Status:</td> <td colspan="2">CNT</td> </tr> </table> <table border="1" data-bbox="240 741 1382 783"> <tr> <td>Modify:</td> <td colspan="2">CNT [val]</td> </tr> </table>			Status:	CNT		Modify:	CNT [val]							
Status:	CNT													
Modify:	CNT [val]													
<p><i>Return:</i></p> <table border="1" data-bbox="240 926 1382 968"> <tr> <td>CNT [val]</td> <td colspan="2"></td> </tr> </table>			CNT [val]											
CNT [val]														
<p><i>Where:</i></p> <table border="1" data-bbox="240 1115 1382 1157"> <tr> <td>[val]</td> <td colspan="2">See Contrast Table.</td> </tr> </table>			[val]	See Contrast Table.										
[val]	See Contrast Table.													
<p><i>Notes:</i></p> <p>Default value is 08.</p>														
<p><i>Example:</i></p> <table border="1" data-bbox="240 1451 1382 1524"> <tr> <td>Sent:</td> <td>CNT</td> <td>Requesting status of display contrast.</td> </tr> <tr> <td>Return:</td> <td>CNT 08</td> <td>Transceiver says that display contrast is at 08.</td> </tr> </table> <table border="1" data-bbox="240 1560 1382 1633"> <tr> <td>Sent:</td> <td>CNT 09</td> <td>Requesting that display contrast be 09.</td> </tr> <tr> <td>Return:</td> <td>CNT 09</td> <td>Confirming that display contrast is 09.</td> </tr> </table>			Sent:	CNT	Requesting status of display contrast.	Return:	CNT 08	Transceiver says that display contrast is at 08.	Sent:	CNT 09	Requesting that display contrast be 09.	Return:	CNT 09	Confirming that display contrast is 09.
Sent:	CNT	Requesting status of display contrast.												
Return:	CNT 08	Transceiver says that display contrast is at 08.												
Sent:	CNT 09	Requesting that display contrast be 09.												
Return:	CNT 09	Confirming that display contrast is 09.												

CR	Call Channel Read	
<i>Description:</i>		
Displays Call channel data.		<i>Menu Item # n/a</i>
<i>Function:</i>		
Returns all the saved data for the Call channel.		
<i>Send:</i>		
Status:	CR [band], [split]	
<i>Return:</i>		
CR [band], [split], [freq]		
<i>Where:</i>		
[band]	see Ham Band Table	
[split]	see Split Channel Table.	
[freq]	See Frequency Table	
<i>Notes:</i>		
<i>Example:</i>		
Sent:	CR 0,0	Requesting call channel data.
Return:	CR 0,0, 00141990000,6,0,0,0,0, 0,25,09,001,000700000,0	Transceiver returns call channel data.

CW		Call Channel Write
<i>Description:</i>		
Enters data to the Call channel.		<i>Menu Item #</i> n/a
<i>Function:</i>		
Saves all data associated with the Call channel		
<i>Send:</i>		
Modify:	CW [split],[freq]	
<i>Return:</i>		
CW		
<i>Where:</i>		
[split]	see Split Channel Table	
[freq]	see Frequency Table.	
<i>Notes:</i>		
<i>Example:</i>		
Sent:	CW 0 00141990000,6,0,0,0,0,0, 25,09,001,000700000,0	Requesting call channel data be set to 00141990000,6,0,0,0,0,0,25,09,001,000700000,0 (see Freq Table).
Return:	CW	Transceiver confirms setting.

<b>DATP</b>	<b>Packet Speed</b>
-------------	---------------------

*Description:*

Get or set Packet Speed. *Menu Item #*  
28

*Function:*

The current packet speed. Options are 1200 or 9600 bps.

*Send:*

Status:	DATP
---------	------

Modify:	DATP [val]
---------	------------

*Return:*

DATP [val]	
------------	--

*Where:*

[val]	see Packet Speed Table
-------	------------------------

*Notes:*

*Example:*

Sent:	DATP	Request Packet Speed.
Return:	DATP 0	Transceiver says Packet Speed in 1200 bps.

Sent:	DATP 1	Request a Packet Speed of 9600 bps.
Return:	DATP 1	Transceiver confirms.



DL	Dual	
<i>Description:</i>		
Gets or sets the dual mode of transceiver.		<i>Menu Item #</i> n/a
<i>Function:</i>		
Toggle the transceiver from displaying one or two frequencies.		
<i>Send:</i>		
Status:	DL	
Modify:	DL [val]	
<i>Return:</i>		
DL [val]		
<i>Where:</i>		
[val]	see Dual Mode Table	
<i>Notes:</i>		
<i>Example:</i>		
Sent:	DL	Requesting Dual Mode status.
Return:	DL 0	Transceiver says that Dual Mode is single.
Sent:	DL 1	Requesting that Dual Mode be dual.
Return:	DL 1	Confirming that Dual Mode is dual.

DLK	DTMF Lock
-----	-----------

*Description:*

Turns on or off or gets state of the DTMF Lock function. *Menu Item # 14*

*Function:*

If the DTMF Lock function is on, the keypad DTMF transmission is disabled.

*Send:*

Status:	DLK
---------	-----

Modify:	DLK [val]
---------	-----------

*Return:*

DLK [val]	
-----------	--

*Where:*

[val]	see Logic Table
-------	-----------------

*Notes:*

*Example:*

Sent:	DLK	Requesting status of DTMF Lock.
Return:	DLK 0	Transceiver says that DTMF Lock is off.

Sent:	DLK 1	Requesting DTMF Lock is on.
Return:	DLK 1	Confirming that DTMF Lock is on.

DM	Get/Set DTMF Memory Number Location													
<p><i>Description:</i></p> <p>Reads or sets one of 10 DTMF memory number locations. <span style="float: right;"><i>Menu Item #</i> 10</span></p>														
<p><i>Function:</i></p> <p>Store a DTMF number in memory.</p>														
<p><i>Send:</i></p> <table border="1" data-bbox="240 663 1382 705"> <tr> <td>Status:</td> <td colspan="2">DM [cc] to get DTMF memory number location.</td> </tr> </table> <table border="1" data-bbox="240 741 1382 783"> <tr> <td>Modify:</td> <td colspan="2">DM [cc], [num] to set number in DTMF memory number location.</td> </tr> </table>			Status:	DM [cc] to get DTMF memory number location.		Modify:	DM [cc], [num] to set number in DTMF memory number location.							
Status:	DM [cc] to get DTMF memory number location.													
Modify:	DM [cc], [num] to set number in DTMF memory number location.													
<p><i>Return:</i></p> <table border="1" data-bbox="240 926 1382 968"> <tr> <td>DM [cc], [num]</td> <td></td> </tr> </table>			DM [cc], [num]											
DM [cc], [num]														
<p><i>Where:</i></p> <table border="1" data-bbox="240 1115 1382 1157"> <tr> <td>[cc]</td> <td>see DTMF Memory Locations.</td> </tr> </table> <table border="1" data-bbox="240 1157 1382 1199"> <tr> <td>[num]</td> <td>see DTMF Digits Table.</td> </tr> </table>			[cc]	see DTMF Memory Locations.	[num]	see DTMF Digits Table.								
[cc]	see DTMF Memory Locations.													
[num]	see DTMF Digits Table.													
<p><i>Notes:</i></p> <p>[num] is a maximum of 16 digits.</p>														
<p><i>Example:</i></p> <table border="1" data-bbox="240 1482 1382 1566"> <tr> <td>Sent:</td> <td>DM 00</td> <td>Requesting the DTMF number stored at 00.</td> </tr> <tr> <td>Return:</td> <td>DM 00,</td> <td>Transceiver says that 00 is an empty location.</td> </tr> </table> <table border="1" data-bbox="240 1598 1382 1682"> <tr> <td>Sent:</td> <td>DM 01,18005551212</td> <td>Requesting that DTMF 01 be 18005551212.</td> </tr> <tr> <td>Return:</td> <td>DM 00,18005551212</td> <td>Confirming that DTMF 01 is 18005551212.</td> </tr> </table>			Sent:	DM 00	Requesting the DTMF number stored at 00.	Return:	DM 00,	Transceiver says that 00 is an empty location.	Sent:	DM 01,18005551212	Requesting that DTMF 01 be 18005551212.	Return:	DM 00,18005551212	Confirming that DTMF 01 is 18005551212.
Sent:	DM 00	Requesting the DTMF number stored at 00.												
Return:	DM 00,	Transceiver says that 00 is an empty location.												
Sent:	DM 01,18005551212	Requesting that DTMF 01 be 18005551212.												
Return:	DM 00,18005551212	Confirming that DTMF 01 is 18005551212.												

<b>DMN</b>	<b>Get/Set DTMF Memory Name Location</b>
------------	--

*Description:*

Reads or sets one of 10 DTMF memory name locations. *Menu Item #  
10*

*Function:*

Store a name to be associated with a DTMF number in memory.

*Send:*

Status:	DMN [cc] to get DTMF memory name location.
---------	--

Modify:	DMN [cc], [name] to set name in DTMF memory name location.
---------	--

*Return:*

DM [cc], [name]	
-----------------	--

*Where:*

[cc]	see DTMF Memory Locations.
------	----------------------------

[name]	see Character Table.
--------	----------------------

*Notes:*

[name] is a maximum of 8 characters.

*Example:*

Sent:	DMN 01	Requesting the name contents of DTMF 01.
Return:	DMN 01,John	Transceiver says that DTMF 01 contains John

Sent:	DMN 09,Home	Requesting that DTMF 09 contents be home.
Return:	DMN 09,Home	Confirming that DTMF 09 contents is home.

DW	Down							
<p><i>Description:</i></p> <p>Instructs transceiver to move down. <span style="float: right;"><i>Menu Item #</i> n/a</span></p>								
<p><i>Function:</i></p> <p>Moves down one memory channel in MR mode or down one frequency step in VFO mode.</p>								
<p><i>Send:</i></p> <table border="1" data-bbox="240 701 1382 741"> <tr> <td data-bbox="240 701 428 741">Modify:</td> <td data-bbox="428 701 1382 741">DW</td> </tr> </table>			Modify:	DW				
Modify:	DW							
<p><i>Return:</i></p> <table border="1" data-bbox="240 888 1382 928"> <tr> <td data-bbox="240 888 573 928">DW</td> <td data-bbox="573 888 1382 928"></td> </tr> </table>			DW					
DW								
<p><i>Where:</i></p> <table border="1" data-bbox="240 1073 1382 1113"> <tr> <td data-bbox="240 1073 428 1113">n/a</td> <td data-bbox="428 1073 1382 1113"></td> </tr> </table>			n/a					
n/a								
<p><i>Notes:</i></p> <p>Same as rotating Tuning Control one click counter-clockwise. See UP.</p>								
<p><i>Example:</i></p> <table border="1" data-bbox="240 1409 1382 1486"> <tr> <td data-bbox="240 1409 380 1446">Sent:</td> <td data-bbox="380 1409 740 1446">DW</td> <td data-bbox="740 1409 1382 1446">Requesting that VFO move down.</td> </tr> <tr> <td data-bbox="240 1446 380 1486">Return:</td> <td data-bbox="380 1446 740 1486">DW</td> <td data-bbox="740 1446 1382 1486">Transceiver confirming that VFO moves down.</td> </tr> </table>			Sent:	DW	Requesting that VFO move down.	Return:	DW	Transceiver confirming that VFO moves down.
Sent:	DW	Requesting that VFO move down.						
Return:	DW	Transceiver confirming that VFO moves down.						

ELK	Tune Enable	
<i>Description:</i>		
Get or set Tune Enable Flag.	<i>Menu Item #</i> 07	
<i>Function:</i>		
If transceiver is locked and Tune Enable in on, Tuning Control may be used to change frequency.		
<i>Send:</i>		
Status:	ELK	
Modify:	ELK [val]	
<i>Return:</i>		
ELK [val]		
<i>Where:</i>		
[val]	See Logic Table	
<i>Notes:</i>		
<i>Example:</i>		
Sent:	ELK	Requesting status of Tune Enable.
Return:	ELK 0	Transceiver says that Tune Enable is off.
Sent:	ELK 1	Request that Tune Enable be set to on.
Return:	ELK 1	Confirming that Tune Enable is set to on.

FL	Frequency Limits							
<p><i>Description:</i></p> <p>Returns list of band limits. <span style="float: right;"><i>Menu Item #</i> <i>n/a</i></span></p> <p>Returns list of band limits.</p>								
<p><i>Function:</i></p> <p>Returns a list of band limits.</p>								
<p><i>Send:</i></p> <table border="1" data-bbox="240 701 1382 741"> <tr> <td data-bbox="240 701 428 741">Status:</td> <td data-bbox="428 701 1382 741">FL [band]</td> </tr> </table>			Status:	FL [band]				
Status:	FL [band]							
<p><i>Return:</i></p> <table border="1" data-bbox="240 890 1382 930"> <tr> <td data-bbox="240 890 573 930">FL [band], [list]</td> <td data-bbox="573 890 1382 930"></td> </tr> </table>			FL [band], [list]					
FL [band], [list]								
<p><i>Where:</i></p> <table border="1" data-bbox="240 1079 1382 1157"> <tr> <td data-bbox="240 1079 428 1119">[band]</td> <td data-bbox="428 1079 1382 1119">see Band Switch Table</td> </tr> <tr> <td data-bbox="240 1119 428 1157">[list]</td> <td data-bbox="428 1119 1382 1157">see Band Limits Table</td> </tr> </table>			[band]	see Band Switch Table	[list]	see Band Limits Table		
[band]	see Band Switch Table							
[list]	see Band Limits Table							
<p><i>Notes:</i></p>								
<p><i>Example:</i></p> <table border="1" data-bbox="240 1449 1382 1596"> <tr> <td data-bbox="240 1449 380 1488">Sent:</td> <td data-bbox="380 1449 740 1488">FL 0</td> <td data-bbox="740 1449 1382 1488">Requesting frequency limits of A band.</td> </tr> <tr> <td data-bbox="240 1488 380 1596">Return:</td> <td data-bbox="380 1488 740 1596">FL 0,00137,00174, 00216,00260, 00410,00470</td> <td data-bbox="740 1488 1382 1596">Transceiver returns limits of A band.</td> </tr> </table>			Sent:	FL 0	Requesting frequency limits of A band.	Return:	FL 0,00137,00174, 00216,00260, 00410,00470	Transceiver returns limits of A band.
Sent:	FL 0	Requesting frequency limits of A band.						
Return:	FL 0,00137,00174, 00216,00260, 00410,00470	Transceiver returns limits of A band.						

FQ		Current Frequency and Step Size
<i>Description:</i>		
Returns or sets the current display frequency and step size.		<i>Menu Item #</i> n/a
<i>Function:</i>		
Returns or sets the current display frequency and step size.		
<i>Send:</i>		
Status:	FQ	
Modify:	FQ [freq], [step]	
<i>Return:</i>		
FQ [freq], [step]		
<i>Where:</i>		
[freq]	is an eleven (11) digit frequency in Hz.	
[step]	see Step Size Table.	
<i>Notes:</i>		
<i>Example:</i>		
Sent:	FQ	Requesting current frequency and step size.
Return:	FQ 00444150000,8	Transceiver returns 444.150 MHz with 50.0 kHz step size.
Sent:	FQ 00142000000,0	Requesting that transceiver be set to 142.000 MHz with a 5.0 kHz step size.
Return:	FQ 00142000000,0	Transceiver confirms.



FST	Fine Tuning Step Size													
<p><i>Description:</i></p> <p>Gets or sets the fine-tuning step size. <span style="float: right;"><i>Menu Item #</i> n/a</span></p>														
<p><i>Function:</i></p> <p>Selects fine tuning frequency step from 33 Hz, 100 Hz, 500 Hz, or 1000 Hz.</p>														
<p><i>Send:</i></p> <table border="1" data-bbox="240 663 1382 705"> <tr> <td>Status:</td> <td>FST</td> </tr> </table> <table border="1" data-bbox="240 741 1382 783"> <tr> <td>Modify:</td> <td>FST [val]</td> </tr> </table>			Status:	FST	Modify:	FST [val]								
Status:	FST													
Modify:	FST [val]													
<p><i>Return:</i></p> <table border="1" data-bbox="240 926 1382 968"> <tr> <td>FST [val]</td> <td></td> </tr> </table>			FST [val]											
FST [val]														
<p><i>Where:</i></p> <table border="1" data-bbox="240 1115 1382 1157"> <tr> <td>[val]</td> <td>see Fine Tuning Step Size Table</td> </tr> </table>			[val]	see Fine Tuning Step Size Table										
[val]	see Fine Tuning Step Size Table													
<p><i>Notes:</i></p>														
<p><i>Example:</i></p> <table border="1" data-bbox="240 1451 1382 1524"> <tr> <td>Sent:</td> <td>FST</td> <td>Request fine-tuning step size.</td> </tr> <tr> <td>Return:</td> <td>FST 0</td> <td>Transceiver says that step size is 33 Hz.</td> </tr> </table> <table border="1" data-bbox="240 1560 1382 1633"> <tr> <td>Sent:</td> <td>FST 3</td> <td>Request that fine tuning step size is 500 Hz.</td> </tr> <tr> <td>Return:</td> <td>FST 3</td> <td>Transceiver confirms.</td> </tr> </table>			Sent:	FST	Request fine-tuning step size.	Return:	FST 0	Transceiver says that step size is 33 Hz.	Sent:	FST 3	Request that fine tuning step size is 500 Hz.	Return:	FST 3	Transceiver confirms.
Sent:	FST	Request fine-tuning step size.												
Return:	FST 0	Transceiver says that step size is 33 Hz.												
Sent:	FST 3	Request that fine tuning step size is 500 Hz.												
Return:	FST 3	Transceiver confirms.												

ID	Identity of Radio							
<p><i>Description:</i></p> <p>Returns the radio identification. <span style="float: right;"><i>Menu Item #</i> n/a</span></p>								
<p><i>Function:</i></p> <p>Returns the radio type as a string. Can be used to validate that the radio is in communication with computer.</p>								
<p><i>Send:</i></p> <table border="1" data-bbox="240 701 1380 741"> <tr> <td data-bbox="240 701 428 741">Status:</td> <td data-bbox="428 701 1380 741">ID</td> </tr> </table>			Status:	ID				
Status:	ID							
<p><i>Return:</i></p> <table border="1" data-bbox="240 888 1380 928"> <tr> <td data-bbox="240 888 573 928">ID [id]</td> <td data-bbox="573 888 1380 928"></td> </tr> </table>			ID [id]					
ID [id]								
<p><i>Where:</i></p> <table border="1" data-bbox="240 1075 1380 1115"> <tr> <td data-bbox="240 1075 428 1115">n/a</td> <td data-bbox="428 1075 1380 1115"></td> </tr> </table>			n/a					
n/a								
<p><i>Notes:</i></p>								
<p><i>Example:</i></p> <table border="1" data-bbox="240 1409 1380 1486"> <tr> <td data-bbox="240 1409 380 1446">Sent:</td> <td data-bbox="380 1409 743 1446">ID</td> <td data-bbox="743 1409 1380 1446">Request ID of transceiver.</td> </tr> <tr> <td data-bbox="240 1446 380 1486">Return:</td> <td data-bbox="380 1446 743 1486">ID TH-F6</td> <td data-bbox="743 1446 1380 1486">Transceiver says that it is a TH-F6.</td> </tr> </table>			Sent:	ID	Request ID of transceiver.	Return:	ID TH-F6	Transceiver says that it is a TH-F6.
Sent:	ID	Request ID of transceiver.						
Return:	ID TH-F6	Transceiver says that it is a TH-F6.						

LAN	Get/Set Default Language	
<i>Description:</i>		
Displays or sets the default language.		<i>Menu Item #</i> 27
<i>Function:</i>		
For selecting either English or Japanese (Katakana) for menu descriptions.		
<i>Send:</i>		
Status:	LAN to get language.	
Modify:	LAN [lang] to set language.	
<i>Return:</i>		
LAN [lang]		
<i>Where:</i>		
[lang]	see Language Table.	
<i>Notes:</i>		
<i>Example:</i>		
Sent:	LAN	Request language.
Return:	LAN 0	Transceiver says language is English.
Sent:	LAN 1	Request that language be Japanese.
Return:	LAN 1	Transceiver confirms that language is Japanese.

LK	Lock													
<p><i>Description:</i></p> <p>Gets or sets the radio lock function. <span style="float: right;"><i>Menu Item #</i> n/a</span></p>														
<p><i>Function:</i></p> <p>The lock function disables most of the keys to prevent accidental activation of a function.</p>														
<p><i>Send:</i></p> <table border="1" data-bbox="240 701 1382 741"> <tr> <td>Status:</td> <td>LK</td> </tr> </table> <table border="1" data-bbox="240 779 1382 819"> <tr> <td>Modify:</td> <td>LK [val]</td> </tr> </table>			Status:	LK	Modify:	LK [val]								
Status:	LK													
Modify:	LK [val]													
<p><i>Return:</i></p> <table border="1" data-bbox="240 968 1382 1008"> <tr> <td>LK [val]</td> <td></td> </tr> </table>			LK [val]											
LK [val]														
<p><i>Where:</i></p> <table border="1" data-bbox="240 1152 1382 1192"> <tr> <td>[val]</td> <td>see Lock Table</td> </tr> </table>			[val]	see Lock Table										
[val]	see Lock Table													
<p><i>Notes:</i></p>														
<p><i>Example:</i></p> <table border="1" data-bbox="240 1486 1382 1564"> <tr> <td>Sent:</td> <td>LK</td> <td>Requesting status of lock.</td> </tr> <tr> <td>Return:</td> <td>LK 0</td> <td>Transceiver says that it is unlocked.</td> </tr> </table> <table border="1" data-bbox="240 1602 1382 1680"> <tr> <td>Sent:</td> <td>LK 1</td> <td>Requesting transceiver to be locked.</td> </tr> <tr> <td>Return:</td> <td>LK 1</td> <td>Confirming that transceiver is locked.</td> </tr> </table>			Sent:	LK	Requesting status of lock.	Return:	LK 0	Transceiver says that it is unlocked.	Sent:	LK 1	Requesting transceiver to be locked.	Return:	LK 1	Confirming that transceiver is locked.
Sent:	LK	Requesting status of lock.												
Return:	LK 0	Transceiver says that it is unlocked.												
Sent:	LK 1	Requesting transceiver to be locked.												
Return:	LK 1	Confirming that transceiver is locked.												

LMP	Lamp													
<p><i>Description:</i></p> <p>Turns on or off or gets state of the light. <span style="float: right;"><i>Menu Item #</i> n/a</span></p>														
<p><i>Function:</i></p> <p>Used to illuminate the transceiver.</p>														
<p><i>Send:</i></p> <table border="1" data-bbox="240 663 1382 705"> <tr> <td>Status:</td> <td colspan="2">LMP</td> </tr> </table> <table border="1" data-bbox="240 741 1382 783"> <tr> <td>Modify:</td> <td colspan="2">LMP [val]</td> </tr> </table>			Status:	LMP		Modify:	LMP [val]							
Status:	LMP													
Modify:	LMP [val]													
<p><i>Return:</i></p> <table border="1" data-bbox="240 926 1382 968"> <tr> <td>LMP [val]</td> <td colspan="2"></td> </tr> </table>			LMP [val]											
LMP [val]														
<p><i>Where:</i></p> <table border="1" data-bbox="240 1115 1382 1157"> <tr> <td>[val]</td> <td colspan="2">see Logic Table</td> </tr> </table>			[val]	see Logic Table										
[val]	see Logic Table													
<p><i>Notes:</i></p>														
<p><i>Example:</i></p> <table border="1" data-bbox="240 1451 1382 1524"> <tr> <td>Sent:</td> <td>LMP</td> <td>Requesting status of transceiver lamp.</td> </tr> <tr> <td>Return:</td> <td>LMP 0</td> <td>Transceiver says lamp is off.</td> </tr> </table> <table border="1" data-bbox="240 1560 1382 1633"> <tr> <td>Sent:</td> <td>LMP 1</td> <td>Requesting lamp to be on.</td> </tr> <tr> <td>Return:</td> <td>LMP 1</td> <td>Confirming that lamp in on.</td> </tr> </table>			Sent:	LMP	Requesting status of transceiver lamp.	Return:	LMP 0	Transceiver says lamp is off.	Sent:	LMP 1	Requesting lamp to be on.	Return:	LMP 1	Confirming that lamp in on.
Sent:	LMP	Requesting status of transceiver lamp.												
Return:	LMP 0	Transceiver says lamp is off.												
Sent:	LMP 1	Requesting lamp to be on.												
Return:	LMP 1	Confirming that lamp in on.												

MC	Memory Channel	
<i>Description:</i>		
Switch display to memory channel or get memory channel of display.		<i>Menu Item #</i> n/a
<i>Function:</i>		
Returns the memory channel stored in the display or will switch the display to a particular memory channel.		
<i>Send:</i>		
Status:	MC [band]	
Modify:	MC [band], [name]	
<i>Return:</i>		
MC [band], [name]		
<i>Where:</i>		
[band]	see Band Switch Table	
[name]	see Memory Channel Table.	
<i>Notes:</i>		
Display must be in MR mode (not VFO or CALL). Can use VMC command to get to MR mode. If command returns an “N”, transceiver is probably not set to MR mode.		
<i>Example:</i>		
Sent:	MC 0	Requesting memory channel for A band.
Return:	MC 0,005	Transceiver says A band set to 005.
Sent:	MC 1,299	Set B Band to memory channel 299,
Return:	MC 1,299	Transceiver confirms that B band set to 299.

MD	Modulation Mode													
<p><i>Description:</i></p> <p>Set or returns current modulation mode. <span style="float: right;"><i>Menu Item #</i> <i>n/a</i></span></p>														
<p><i>Function:</i></p> <p>Set or returns the modulation mode of the current active band (A/B).</p>														
<p><i>Send:</i></p> <table border="1" data-bbox="240 701 1380 741"> <tr> <td>Status:</td> <td colspan="2">MD</td> </tr> </table> <table border="1" data-bbox="240 779 1380 819"> <tr> <td>Modify:</td> <td colspan="2">MD [mode]</td> </tr> </table>			Status:	MD		Modify:	MD [mode]							
Status:	MD													
Modify:	MD [mode]													
<p><i>Return:</i></p> <table border="1" data-bbox="240 966 1380 1005"> <tr> <td>MD [mode]</td> <td colspan="2"></td> </tr> </table>			MD [mode]											
MD [mode]														
<p><i>Where:</i></p> <table border="1" data-bbox="240 1152 1380 1192"> <tr> <td>[mode]</td> <td colspan="2">See Modulation Mode Table.</td> </tr> </table>			[mode]	See Modulation Mode Table.										
[mode]	See Modulation Mode Table.													
<p><i>Notes:</i></p>														
<p><i>Example:</i></p> <table border="1" data-bbox="240 1486 1380 1564"> <tr> <td>Sent:</td> <td>MD</td> <td>Request current modulation mode</td> </tr> <tr> <td>Return:</td> <td>MD 0</td> <td>Transceiver say mode is FM.</td> </tr> </table> <table border="1" data-bbox="240 1602 1380 1680"> <tr> <td>Sent:</td> <td>MD 2</td> <td>Request that mode be set to AM.</td> </tr> <tr> <td>Return:</td> <td>MD 2</td> <td>Transceiver says that mode is AM.</td> </tr> </table>			Sent:	MD	Request current modulation mode	Return:	MD 0	Transceiver say mode is FM.	Sent:	MD 2	Request that mode be set to AM.	Return:	MD 2	Transceiver says that mode is AM.
Sent:	MD	Request current modulation mode												
Return:	MD 0	Transceiver say mode is FM.												
Sent:	MD 2	Request that mode be set to AM.												
Return:	MD 2	Transceiver says that mode is AM.												

MES		Get/Set Power on Message
<i>Description:</i>		
Displays or sets the power on greeting message.		<i>Menu Item #</i> 15
<i>Function:</i>		
The greeting message that is displayed when transceiver is turned on.		
<i>Send:</i>		
Status:	MES to get greeting	
Modify:	MES [message] to set greeting	
<i>Return:</i>		
MES [message]		
<i>Where:</i>		
[message]	see Character Table.	
<i>Notes:</i>		
[message] is a maximum of eight (8) characters.		
<i>Example:</i>		
Sent:	MES	Request power on message.
Return:	MES John May	Transceiver says that message is "John May".
Sent:	MES K6MAY	Requesting that message be "K6MAY".
Return:	MES K6MAY	Transceiver confirms new message.



MGL		Memory Group Link
<i>Description:</i>		
Gets or sets the Memory Group Link Channels.		<i>Menu Item #</i> 02
<i>Function:</i>		
Memory channels are divided into eight (8) groups. Memory Group Link is used to link two or more groups for scanning.		
<i>Send:</i>		
Status:	MGL	
Modify:	MGL [val]	
<i>Return:</i>		
MGL [val]		
<i>Where:</i>		
[val]	Are the linked memory groups (0-7). All groups not displayed are assumed to be free.	
<i>Notes:</i>		
<i>Example:</i> (note: * = a space character)		
Sent:	MGL	Requesting the status of memory group link.
Return:	MGL**1*3*5*7	Transceiver says that 1,3,5,7 groups are linked.
Sent:	MGL***2***6*	Requesting that groups 2 and 6 be linked.
Return:	MGL***2***6*	Transceiver confirms.

MNA	Memory Name	
<i>Description:</i>		
Get or set name of memory channel.	<i>Menu Item #</i> n/a	
<i>Function:</i>		
Get or set the name of a memory channel.		
<i>Send:</i>		
Status:	MNA	
Modify:	MNA [mem],[name]	
<i>Return:</i>		
MNA [mem],[name]		
<i>Where:</i>		
[mem]	see Memory Channel Table.	
[name]	see Character Table.	
<i>Notes:</i>		
[name] is a maximum of eight (8) characters.		
<i>Example:</i>		
Sent:	MNA 001	Request name of memory channel 001
Return:	MNA 001,RPTR	Transceiver says 001 is “RPTR”
Sent:	MNA 256,NASA-TV	Request that channel 256 be “NASA-TV”.
Return:	MNA 256,NASA-TV	Transceiver says channel 256 is “NASA-TV”.

MNF	Memory Name Frequency													
<p><i>Description:</i></p> <p>Set or get the name/frequency mode of display. <span style="float: right;"><i>Menu Item #</i> <i>n/a</i></span></p>														
<p><i>Function:</i></p> <p>Gets or sets the display mode. Display can be a numeric frequency or an alphanumeric name.</p>														
<p><i>Send:</i></p> <table border="1" data-bbox="240 701 1382 741"> <tr> <td>Status:</td> <td colspan="2">MNF</td> </tr> </table> <table border="1" data-bbox="240 779 1382 819"> <tr> <td>Modify:</td> <td colspan="2">MNF [val]</td> </tr> </table>			Status:	MNF		Modify:	MNF [val]							
Status:	MNF													
Modify:	MNF [val]													
<p><i>Return:</i></p> <table border="1" data-bbox="240 968 1382 1008"> <tr> <td>MNF [val]</td> <td colspan="2"></td> </tr> </table>			MNF [val]											
MNF [val]														
<p><i>Where:</i></p> <table border="1" data-bbox="240 1152 1382 1192"> <tr> <td>[val]</td> <td colspan="2">See Name/Frequency Mode Table</td> </tr> </table>			[val]	See Name/Frequency Mode Table										
[val]	See Name/Frequency Mode Table													
<p><i>Notes:</i></p> <p>Changes mode of both A and B channels.</p>														
<p><i>Example:</i></p> <table border="1" data-bbox="240 1486 1382 1562"> <tr> <td>Sent:</td> <td>MNF</td> <td>Requesting the Name/Freq status of display.</td> </tr> <tr> <td>Return:</td> <td>MNF 0</td> <td>Transceiver says display is in Name mode.</td> </tr> </table> <table border="1" data-bbox="240 1600 1382 1675"> <tr> <td>Sent:</td> <td>MNF 1</td> <td>Request that display be in Frequency mode.</td> </tr> <tr> <td>Return:</td> <td>MNF 1</td> <td>Confirming that display is in Frequency Mode.</td> </tr> </table>			Sent:	MNF	Requesting the Name/Freq status of display.	Return:	MNF 0	Transceiver says display is in Name mode.	Sent:	MNF 1	Request that display be in Frequency mode.	Return:	MNF 1	Confirming that display is in Frequency Mode.
Sent:	MNF	Requesting the Name/Freq status of display.												
Return:	MNF 0	Transceiver says display is in Name mode.												
Sent:	MNF 1	Request that display be in Frequency mode.												
Return:	MNF 1	Confirming that display is in Frequency Mode.												

<b>MR</b>	<b>Memory Channel Read</b>
-----------	----------------------------

*Description:*

Reads a memory channel. *Menu Item #  
n/a*

*Function:*

Reads memory channel data. May also be used to check for a split channel.

*Send:*

Status:	MR [split], [mem]
---------	-------------------

*Return:*

MR [split], [mem],[freq]	
--------------------------	--

*Where:*

[split]	see Split Channel Table.
[mem]	see Memory Channel Table
[freq]	see Frequency Table.

*Notes:*

N is returned for an empty memory location.

*Example:*

Sent:	MR 0,001	Requesting to read memory location 001.
Return:	MR 0,001, 00146655000,0,2,0,1,0,0, 24,08,000,000600000,0,0	Transceiver returns values associated with location 001.

MRM	Memory Recall Method													
<p><i>Description:</i></p> <p>Gets or sets the memory recall method. <span style="float: right;"><i>Menu Item #</i> 03</span></p>														
<p><i>Function:</i></p> <p>Used to configure transceiver to recall only the memory channels for the current operating band.</p>														
<p><i>Send:</i></p> <table border="1" data-bbox="240 701 1382 741"> <tr> <td>Status:</td> <td>MRM</td> </tr> </table> <table border="1" data-bbox="240 779 1382 819"> <tr> <td>Modify:</td> <td>MRM [val]</td> </tr> </table>			Status:	MRM	Modify:	MRM [val]								
Status:	MRM													
Modify:	MRM [val]													
<p><i>Return:</i></p> <table border="1" data-bbox="240 968 1382 1008"> <tr> <td>MRM [val]</td> <td></td> </tr> </table>			MRM [val]											
MRM [val]														
<p><i>Where:</i></p> <table border="1" data-bbox="240 1152 1382 1192"> <tr> <td>[val]</td> <td>see Memory Recall Table.</td> </tr> </table>			[val]	see Memory Recall Table.										
[val]	see Memory Recall Table.													
<p><i>Notes:</i></p>														
<p><i>Example:</i></p> <table border="1" data-bbox="240 1486 1382 1564"> <tr> <td>Sent:</td> <td>MRM</td> <td>Requesting current Memory Recall Mode.</td> </tr> <tr> <td>Return:</td> <td>MRM 0</td> <td>Transceiver says the MRM is “All Bands”.</td> </tr> </table> <table border="1" data-bbox="240 1602 1382 1680"> <tr> <td>Sent:</td> <td>MRM 1</td> <td>Request that MRM be “Current Band”.</td> </tr> <tr> <td>Return:</td> <td>MRM 1</td> <td>Confirming that MRM is “Current Band”.</td> </tr> </table>			Sent:	MRM	Requesting current Memory Recall Mode.	Return:	MRM 0	Transceiver says the MRM is “All Bands”.	Sent:	MRM 1	Request that MRM be “Current Band”.	Return:	MRM 1	Confirming that MRM is “Current Band”.
Sent:	MRM	Requesting current Memory Recall Mode.												
Return:	MRM 0	Transceiver says the MRM is “All Bands”.												
Sent:	MRM 1	Request that MRM be “Current Band”.												
Return:	MRM 1	Confirming that MRM is “Current Band”.												

MW		Memory Write
<i>Description:</i>		
Store memory channel.		<i>Menu Item #</i> n/a
<i>Function:</i>		
Command to store frequency and data in a memory channel.		
<i>Send:</i>		
Modify:	MW [split],[mem],[freq]	
<i>Return:</i>		
	MW [split],[mem],[freq]	
<i>Where:</i>		
[split]	see Split Channel Table.	
[mem]	see Memory Channel Table	
[freq]	see Frequency Table.	
<i>Notes:</i>		
<i>Example:</i>		
Sent:	MW 0,020, 00107980000,0,0,0,0,0,0, 00,00,000,000000000,1,0	Set memory channel 020 to 107.98 MHz with a 5.0 kHz step size. No offset, reverse, tone. CTCSS.,DCS or lockout. In FM mode.
Return:	MW	Transceiver confirms.

NAR		FM Narrow	
<i>Description:</i>			
Gets or sets the Narrow FM mode of a band.		<i>Menu Item #</i> 29	
<i>Function:</i>			
Selects between: Off - wide band FM (5 KHz) deviation or On - narrow band FM (2.5 KHz) deviation.			
<i>Send:</i>			
Status:	NAR [band]		
Modify:	NAR [band],[val]		
<i>Return:</i>			
NAR [band],[val]			
<i>Where:</i>			
[band]	see Ham Band Table.		
[val]	see Logic Table.		
<i>Notes:</i>			
<i>Example:</i>			
Sent:	NAR 0	Request status of 2m FM.	
Return:	NAR 0,0	Transceiver says FM is wide.	
Sent:	NAR 1,1	Request that 1.25 m band be narrow FM.	
Return:	NAR 1,1	Transceiver confirms	

NSFT		Beat Shift	
<i>Description:</i>			
Set or get Beat Shift function.		<i>Menu Item #</i> 25	
<i>Function:</i>			
Used the reduce harmonics from microprocessors clock oscillator.			
<i>Send:</i>			
Status:	NSFT		
Modify:	NSFT [val]		
<i>Return:</i>			
NSFT [val]			
<i>Where:</i>			
[val]	see Logic Table.		
<i>Notes:</i>			
<i>Example:</i>			
Sent:	NSFT	Request status of Beat Shift function.	
Return:	NSFT 1	Transceiver says the Beat Shift function is on.	
Sent:	NSFT 0	Request that the beat Shift function be on.	
Return:	NSFT 0	Transceiver confirms.	



PC	Power Control	
<i>Description:</i>		
Sets the transmit power on a band.		<i>Menu Item #</i> n/a
<i>Function:</i>		
Changes the power output level on the current band.		
<i>Send:</i>		
Status:	PC [band]	
Modify:	PC [band], [pwr]	
<i>Return:</i>		
PC [band], [pwr]		
<i>Where:</i>		
[band]	see Band Switch Table	
[pwr]	see Power Level Table	
<i>Notes:</i>		
<i>Example:</i>		
Sent:	PC 0	Requesting the power output for the 2 m band.
Return:	PC 0,0	Transceiver says the power output is H.
Sent:	PC 1,2	Set the power output to EL for 1.25 m band.
Return:	PC 1,2	Transceiver confirms.

PT	DTMF Pause													
<p><i>Description:</i></p> <p>Gets or sets the DTMF pause duration. <span style="float: right;"><i>Menu Item #</i> 13</span></p>														
<p><i>Function:</i></p> <p>Selects the pause duration for a space character entered into a DTMF number field.</p>														
<p><i>Send:</i></p> <table border="1" data-bbox="240 701 1382 741"> <tr> <td>Status:</td> <td>PT</td> </tr> </table> <table border="1" data-bbox="240 779 1382 819"> <tr> <td>Modify:</td> <td>PT [val]</td> </tr> </table>			Status:	PT	Modify:	PT [val]								
Status:	PT													
Modify:	PT [val]													
<p><i>Return:</i></p> <table border="1" data-bbox="240 968 1382 1008"> <tr> <td>PT [val]</td> <td></td> </tr> </table>			PT [val]											
PT [val]														
<p><i>Where:</i></p> <table border="1" data-bbox="240 1152 1382 1192"> <tr> <td>[val]</td> <td>see DTMF Pause Table</td> </tr> </table>			[val]	see DTMF Pause Table										
[val]	see DTMF Pause Table													
<p><i>Notes:</i></p>														
<p><i>Example:</i></p> <table border="1" data-bbox="240 1486 1382 1564"> <tr> <td>Sent:</td> <td>PT</td> <td>Request DTMF pause duration.</td> </tr> <tr> <td>Return:</td> <td>PT 2</td> <td>Transceiver says pause duration is 500 ms.</td> </tr> </table> <table border="1" data-bbox="240 1602 1382 1680"> <tr> <td>Sent:</td> <td>PT 5</td> <td>Request that pause duration be 1500 ms.</td> </tr> <tr> <td>Return:</td> <td>PT 5</td> <td>Confirming a pause duration of 1500 ms.</td> </tr> </table>			Sent:	PT	Request DTMF pause duration.	Return:	PT 2	Transceiver says pause duration is 500 ms.	Sent:	PT 5	Request that pause duration be 1500 ms.	Return:	PT 5	Confirming a pause duration of 1500 ms.
Sent:	PT	Request DTMF pause duration.												
Return:	PT 2	Transceiver says pause duration is 500 ms.												
Sent:	PT 5	Request that pause duration be 1500 ms.												
Return:	PT 5	Confirming a pause duration of 1500 ms.												

PV	Program VFO Limits													
<p><i>Description:</i></p> <p>Displays the VFO limits for a band. <span style="float: right;"><i>Menu Item #</i> 04</span></p>														
<p><i>Function:</i></p> <p>Displays a list of the band limits for A and B bands.</p>														
<p><i>Send:</i></p> <table border="1" data-bbox="240 663 1382 705"> <tr> <td>Status:</td> <td>PV [band]</td> </tr> </table> <table border="1" data-bbox="240 741 1382 783"> <tr> <td>Modify:</td> <td>PV [band],[f1], [f2]</td> </tr> </table>			Status:	PV [band]	Modify:	PV [band],[f1], [f2]								
Status:	PV [band]													
Modify:	PV [band],[f1], [f2]													
<p><i>Return:</i></p> <table border="1" data-bbox="240 926 1382 968"> <tr> <td>PV [band],[f1], [f2]</td> <td></td> </tr> </table>			PV [band],[f1], [f2]											
PV [band],[f1], [f2]														
<p><i>Where:</i></p> <table border="1" data-bbox="240 1115 1382 1230"> <tr> <td>[band]</td> <td>see Band Table. Only used on A band.</td> </tr> <tr> <td>[f1], [f2]</td> <td>is a five (5)-digit frequency representing the lower and upper frequency limits.</td> </tr> </table>			[band]	see Band Table. Only used on A band.	[f1], [f2]	is a five (5)-digit frequency representing the lower and upper frequency limits.								
[band]	see Band Table. Only used on A band.													
[f1], [f2]	is a five (5)-digit frequency representing the lower and upper frequency limits.													
<p><i>Notes:</i></p> <p>This sets the limits used during VFO scans in the band.</p>														
<p><i>Example:</i></p> <table border="1" data-bbox="240 1524 1382 1598"> <tr> <td>Sent:</td> <td>PV 0</td> <td>Request VFO limit of 2 m band.</td> </tr> <tr> <td>Return:</td> <td>PV 0,00137,00173</td> <td>Transceiver says it's 137-173 MHz.</td> </tr> </table> <table border="1" data-bbox="240 1640 1382 1713"> <tr> <td>Sent:</td> <td>PV 1,00216,00259</td> <td>Set VFO limits of 1.25 m band.</td> </tr> <tr> <td>Return:</td> <td>PV 1,00216,00259</td> <td>Transceiver confirms limits of 216-259 MHz.</td> </tr> </table>			Sent:	PV 0	Request VFO limit of 2 m band.	Return:	PV 0,00137,00173	Transceiver says it's 137-173 MHz.	Sent:	PV 1,00216,00259	Set VFO limits of 1.25 m band.	Return:	PV 1,00216,00259	Transceiver confirms limits of 216-259 MHz.
Sent:	PV 0	Request VFO limit of 2 m band.												
Return:	PV 0,00137,00173	Transceiver says it's 137-173 MHz.												
Sent:	PV 1,00216,00259	Set VFO limits of 1.25 m band.												
Return:	PV 1,00216,00259	Transceiver confirms limits of 216-259 MHz.												

RBN	Set Band	
<i>Description:</i>		
Displays or sets the current band, when in VFO mode.		<i>Menu Item #</i> n/a
<i>Function:</i>		
Gets or sets the current band. Transceiver must be in VFO mode.		
<i>Send:</i>		
Status:	RBN	
Modify:	RBN [band]	
<i>Return:</i>		
RBN [band]		
<i>Where:</i>		
[band]	see Band Table	
<i>Notes:</i>		
<i>Example:</i>		
Sent:	RBN	Get current band.
Return:	RBN 0	Current band is 2 m.
Sent:	RBN A	Set current band to VHF-TV.
Return:	RBN A	Transceiver confirms.

RX	Receive							
<p><i>Description:</i></p> <p>Switches transceiver to receive mode. <span style="float: right;"><i>Menu Item #</i> n/a</span></p>								
<p><i>Function:</i></p> <p>Sets transceiver to receive.</p>								
<p><i>Send:</i></p> <table border="1" data-bbox="240 663 1382 705"> <tr> <td data-bbox="240 663 428 705">Modify:</td> <td colspan="2" data-bbox="428 663 1382 705">RX</td> </tr> </table>			Modify:	RX				
Modify:	RX							
<p><i>Return:</i></p> <table border="1" data-bbox="240 852 1382 894"> <tr> <td data-bbox="240 852 571 894">RX</td> <td colspan="2" data-bbox="571 852 1382 894"></td> </tr> </table>			RX					
RX								
<p><i>Where:</i></p> <table border="1" data-bbox="240 1035 1382 1077"> <tr> <td data-bbox="240 1035 428 1077">n/a</td> <td colspan="2" data-bbox="428 1035 1382 1077"></td> </tr> </table>			n/a					
n/a								
<p><i>Notes:</i></p>								
<p><i>Example:</i></p> <table border="1" data-bbox="240 1371 1382 1451"> <tr> <td data-bbox="240 1371 380 1413">Sent:</td> <td data-bbox="380 1371 743 1413">RX</td> <td data-bbox="743 1371 1382 1413">Set transceiver to receiver mode.</td> </tr> <tr> <td data-bbox="240 1413 380 1451">Return:</td> <td data-bbox="380 1413 743 1451">RX</td> <td data-bbox="743 1413 1382 1451">Transceiver confirms.</td> </tr> </table>			Sent:	RX	Set transceiver to receiver mode.	Return:	RX	Transceiver confirms.
Sent:	RX	Set transceiver to receiver mode.						
Return:	RX	Transceiver confirms.						

SCR	Scan Resume	
<i>Description:</i>		
Get or set the Scan Resume method.		<i>Menu Item # 01</i>
<i>Function:</i>		
The method used the continue scanning after the transceiver stops on a detected signal.		
<i>Send:</i>		
Status:	SCR	
Modify:	SCR [val]	
<i>Return:</i>		
SCR [val]		
<i>Where:</i>		
[val]	see Scan Resume Table	
<i>Notes:</i>		
<i>Example:</i>		
Sent:	SCR	Request scan resume method.
Return:	SCR 0	Transceiver says it is Time.
Sent:	SCR 2	Request that scan resume method be Seek.
Return:	SCR 2	Transceiver confirms.

SQ	Squelch													
<p><i>Description:</i></p> <p>Displays or sets the squelch level. <span style="float: right;"><i>Menu Item #</i> <i>n/a</i></span></p>														
<p><i>Function:</i></p> <p>Sets or gets the squelch level for a band.</p>														
<p><i>Send:</i></p> <table border="1" data-bbox="240 663 1380 705"> <tr> <td>Status:</td> <td colspan="2">SQ [band]</td> </tr> </table> <table border="1" data-bbox="240 741 1380 783"> <tr> <td>Modify:</td> <td colspan="2">SQ [band], [lev]</td> </tr> </table>			Status:	SQ [band]		Modify:	SQ [band], [lev]							
Status:	SQ [band]													
Modify:	SQ [band], [lev]													
<p><i>Return:</i></p> <table border="1" data-bbox="240 926 1380 968"> <tr> <td>SQ [band], [lev]</td> <td></td> </tr> </table>			SQ [band], [lev]											
SQ [band], [lev]														
<p><i>Where:</i></p> <table border="1" data-bbox="240 1115 1380 1157"> <tr> <td>[band]</td> <td>see Band Switch Table</td> </tr> </table> <table border="1" data-bbox="240 1157 1380 1199"> <tr> <td>[lev]</td> <td>is a value from 00-05.</td> </tr> </table>			[band]	see Band Switch Table	[lev]	is a value from 00-05.								
[band]	see Band Switch Table													
[lev]	is a value from 00-05.													
<p><i>Notes:</i></p> <p>00 is open squelch.</p>														
<p><i>Example:</i></p> <table border="1" data-bbox="240 1482 1380 1566"> <tr> <td>Sent:</td> <td>SQ 0</td> <td>Request that squelch value for A band.</td> </tr> <tr> <td>Return:</td> <td>SQ 0,05</td> <td>Squelch value for A band is 05.</td> </tr> </table> <table border="1" data-bbox="240 1602 1380 1686"> <tr> <td>Sent:</td> <td>SQ 1,01</td> <td>Request that B band squelch be 01.</td> </tr> <tr> <td>Return:</td> <td>SQ 1,01</td> <td>Transceiver confirms.</td> </tr> </table>			Sent:	SQ 0	Request that squelch value for A band.	Return:	SQ 0,05	Squelch value for A band is 05.	Sent:	SQ 1,01	Request that B band squelch be 01.	Return:	SQ 1,01	Transceiver confirms.
Sent:	SQ 0	Request that squelch value for A band.												
Return:	SQ 0,05	Squelch value for A band is 05.												
Sent:	SQ 1,01	Request that B band squelch be 01.												
Return:	SQ 1,01	Transceiver confirms.												

SR	System Reset							
<p><i>Description:</i></p> <p>Sets and performs the reset function. <span style="float: right;"><i>Menu Item #</i> 31</span></p>								
<p><i>Function:</i></p> <p>Resets various portions of transceiver.</p>								
<p><i>Send:</i></p> <table border="1" data-bbox="240 663 1382 705"> <tr> <td data-bbox="240 663 428 705">Modify:</td> <td data-bbox="428 663 1382 705">SR [val]</td> </tr> </table>			Modify:	SR [val]				
Modify:	SR [val]							
<p><i>Return:</i></p> <table border="1" data-bbox="240 852 1382 894"> <tr> <td data-bbox="240 852 571 894">No return</td> <td data-bbox="571 852 1382 894"></td> </tr> </table>			No return					
No return								
<p><i>Where:</i></p> <table border="1" data-bbox="240 1035 1382 1077"> <tr> <td data-bbox="240 1035 428 1077">[val]</td> <td data-bbox="428 1035 1382 1077">see System Reset Table</td> </tr> </table>			[val]	see System Reset Table				
[val]	see System Reset Table							
<p><i>Notes:</i></p>								
<p><i>Example:</i></p> <table border="1" data-bbox="240 1371 1382 1451"> <tr> <td data-bbox="240 1371 380 1413">Sent:</td> <td data-bbox="380 1371 743 1413">SR 1</td> <td data-bbox="743 1371 1382 1413">Perform VFO Reset.</td> </tr> <tr> <td data-bbox="240 1413 380 1451">Return:</td> <td data-bbox="380 1413 743 1451"></td> <td data-bbox="743 1413 1382 1451">No return value.</td> </tr> </table>			Sent:	SR 1	Perform VFO Reset.	Return:		No return value.
Sent:	SR 1	Perform VFO Reset.						
Return:		No return value.						



SV	Battery Saver													
<p><i>Description:</i></p> <p>Gets or sets the Battery saver time. <span style="float: right;"><i>Menu Item #</i> 17</span></p>														
<p><i>Function:</i></p> <p>Sets the receiver shut-off period for the transceiver. Used to reduce energy consumption, extending battery life.</p>														
<p><i>Send:</i></p> <table border="1" data-bbox="240 701 1382 741"> <tr> <td>Status:</td> <td>SV</td> </tr> </table> <table border="1" data-bbox="240 779 1382 819"> <tr> <td>Modify:</td> <td>SV [val]</td> </tr> </table>			Status:	SV	Modify:	SV [val]								
Status:	SV													
Modify:	SV [val]													
<p><i>Return:</i></p> <table border="1" data-bbox="240 968 1382 1008"> <tr> <td>SV [val]</td> <td></td> </tr> </table>			SV [val]											
SV [val]														
<p><i>Where:</i></p> <table border="1" data-bbox="240 1152 1382 1192"> <tr> <td>[val]</td> <td>see Battery Saver Table</td> </tr> </table>			[val]	see Battery Saver Table										
[val]	see Battery Saver Table													
<p><i>Notes:</i></p>														
<p><i>Example:</i></p> <table border="1" data-bbox="240 1486 1382 1564"> <tr> <td>Sent:</td> <td>SV</td> <td>Get Battery Saver time.</td> </tr> <tr> <td>Return:</td> <td>SV 5</td> <td>Transceiver says Battery Saver time is 1.0 sec.</td> </tr> </table> <table border="1" data-bbox="240 1602 1382 1677"> <tr> <td>Sent:</td> <td>SV 7</td> <td>Request that Battery Saver time be 3.0 sec.</td> </tr> <tr> <td>Return:</td> <td>SV 7</td> <td>Transceiver confirms.</td> </tr> </table>			Sent:	SV	Get Battery Saver time.	Return:	SV 5	Transceiver says Battery Saver time is 1.0 sec.	Sent:	SV 7	Request that Battery Saver time be 3.0 sec.	Return:	SV 7	Transceiver confirms.
Sent:	SV	Get Battery Saver time.												
Return:	SV 5	Transceiver says Battery Saver time is 1.0 sec.												
Sent:	SV 7	Request that Battery Saver time be 3.0 sec.												
Return:	SV 7	Transceiver confirms.												

TH	1750 Hold	
<i>Description:</i>		
Set or gets the 1750 Hz Tone function.		<i>Menu Item #</i> 24
<i>Function:</i>		
Used to hold the transmitted 1750 Hz tone (TH-F7E only).		
<i>Send:</i>		
Status:	TH	
Modify:	TH [val]	
<i>Return:</i>		
TH [val]		
<i>Where:</i>		
[val]	see Logic Table	
<i>Notes:</i>		
<i>Example:</i>		
Sent:	TH	Request status of 1750 Hz Hold function.
Return:	TH 0	Transceiver says 1750 Hz Hold is off.
Sent:	TH 1	Request that 1750 Hz Hold be on.
Return:	TH 1	Transceiver confirms.

TXS	Transmit Inhibit													
<p><i>Description:</i></p> <p>Turns on or off or gets state of the Transmit Inhibit function. <span style="float: right;"><i>Menu Item #</i> 08</span></p>														
<p><i>Function:</i></p> <p>Prevents accidental or unauthorized transmission.</p>														
<p><i>Send:</i></p> <table border="1" data-bbox="240 663 1382 705"> <tr> <td>Status:</td> <td colspan="2">TXS</td> </tr> </table> <table border="1" data-bbox="240 741 1382 783"> <tr> <td>Modify:</td> <td colspan="2">TXS [val]</td> </tr> </table>			Status:	TXS		Modify:	TXS [val]							
Status:	TXS													
Modify:	TXS [val]													
<p><i>Return:</i></p> <table border="1" data-bbox="240 926 1382 968"> <tr> <td>TXS [val]</td> <td colspan="2"></td> </tr> </table>			TXS [val]											
TXS [val]														
<p><i>Where:</i></p> <table border="1" data-bbox="240 1115 1382 1157"> <tr> <td>[val]</td> <td colspan="2">see Logic Table</td> </tr> </table>			[val]	see Logic Table										
[val]	see Logic Table													
<p><i>Notes:</i></p>														
<p><i>Example:</i></p> <table border="1" data-bbox="240 1451 1382 1524"> <tr> <td>Sent:</td> <td>TXS</td> <td>Get state of Transmitter Inhibit.</td> </tr> <tr> <td>Return:</td> <td>TXS 0</td> <td>Transmitter Inhibit is off.</td> </tr> </table> <table border="1" data-bbox="240 1560 1382 1633"> <tr> <td>Sent:</td> <td>TXS 1</td> <td>Request that Transmitter Inhibit be on.</td> </tr> <tr> <td>Return:</td> <td>TXS 1</td> <td>Transceiver confirms new value.</td> </tr> </table>			Sent:	TXS	Get state of Transmitter Inhibit.	Return:	TXS 0	Transmitter Inhibit is off.	Sent:	TXS 1	Request that Transmitter Inhibit be on.	Return:	TXS 1	Transceiver confirms new value.
Sent:	TXS	Get state of Transmitter Inhibit.												
Return:	TXS 0	Transmitter Inhibit is off.												
Sent:	TXS 1	Request that Transmitter Inhibit be on.												
Return:	TXS 1	Transceiver confirms new value.												

TXH	DTMF Hold													
<p><i>Description:</i></p> <p>Turns on or off or gets state of the DTMF Hold function. <span style="float: right;"><i>Menu Item #</i> 12</span></p>														
<p><i>Function:</i></p> <p>Causes the transceiver to remain in transmit mode for two</p>														
<p><i>Send:</i></p> <table border="1" data-bbox="240 663 1382 705"> <tr> <td>Status:</td> <td colspan="2">THX</td> </tr> </table> <table border="1" data-bbox="240 741 1382 783"> <tr> <td>Modify:</td> <td colspan="2">THX [val]</td> </tr> </table>			Status:	THX		Modify:	THX [val]							
Status:	THX													
Modify:	THX [val]													
<p><i>Return:</i></p> <table border="1" data-bbox="240 930 1382 972"> <tr> <td>THX [val]</td> <td colspan="2"></td> </tr> </table>			THX [val]											
THX [val]														
<p><i>Where:</i></p> <table border="1" data-bbox="240 1119 1382 1161"> <tr> <td>[val]</td> <td colspan="2">see Logic Table</td> </tr> </table>			[val]	see Logic Table										
[val]	see Logic Table													
<p><i>Notes:</i></p>														
<p><i>Example:</i></p> <table border="1" data-bbox="240 1455 1382 1528"> <tr> <td>Sent:</td> <td>TXH</td> <td>Request status of DTMF Hold.</td> </tr> <tr> <td>Return:</td> <td>TXH 0</td> <td>Transceiver says DTMF Hold is off.</td> </tr> </table> <table border="1" data-bbox="240 1564 1382 1638"> <tr> <td>Sent:</td> <td>TXH 1</td> <td>Request that DTMF Hold be on.</td> </tr> <tr> <td>Return:</td> <td>TXH 1</td> <td>Transceiver confirms.</td> </tr> </table>			Sent:	TXH	Request status of DTMF Hold.	Return:	TXH 0	Transceiver says DTMF Hold is off.	Sent:	TXH 1	Request that DTMF Hold be on.	Return:	TXH 1	Transceiver confirms.
Sent:	TXH	Request status of DTMF Hold.												
Return:	TXH 0	Transceiver says DTMF Hold is off.												
Sent:	TXH 1	Request that DTMF Hold be on.												
Return:	TXH 1	Transceiver confirms.												

TSP		DTMF Speed	
<i>Description:</i>			
Sets or gets DTMF Speed function.		<i>Menu Item # 11</i>	
<i>Function:</i>			
Adjust DTMF number transmission speed.			
<i>Send:</i>			
Status:	TSP		
Modify:	TSP [val]		
<i>Return:</i>			
TSP [val]			
<i>Where:</i>			
[val]	see DTMF Speed Table		
<i>Notes:</i>			
<i>Example:</i>			
Sent:	TSP	Get current DTMF Speed.	
Return:	TSP 0	DTMF Speed is slow.	
Sent:	TSP 1	Request that DTMF Speed be fast.	
Return:	TSP 1	Transceiver confirms new speed.	

TT	Transmit Tone							
<p><i>Description:</i></p> <p>Transmit a 1750Hz tone. <span style="float: right;"><i>Menu Item #</i> n/a</span></p>								
<p><i>Function:</i></p> <p>Will transmit a 1750 Hz tone until a RX command is received.</p>								
<p><i>Send:</i></p> <table border="1" data-bbox="240 663 1383 705"> <tr> <td>Modify:</td> <td>TT</td> </tr> </table>			Modify:	TT				
Modify:	TT							
<p><i>Return:</i></p> <table border="1" data-bbox="240 852 1383 894"> <tr> <td>TT</td> <td></td> </tr> </table>			TT					
TT								
<p><i>Where:</i></p> <table border="1" data-bbox="240 1041 1383 1083"> <tr> <td>n/a</td> <td></td> </tr> </table>			n/a					
n/a								
<p><i>Notes:</i></p> <p>May be stopped by RX command.</p>								
<p><i>Example:</i></p> <table border="1" data-bbox="240 1377 1383 1451"> <tr> <td>Sent:</td> <td>TT</td> <td>Have transceiver send a 1750 Hz tone.</td> </tr> <tr> <td>Return:</td> <td>TT</td> <td>Transceiver acknowledges,</td> </tr> </table>			Sent:	TT	Have transceiver send a 1750 Hz tone.	Return:	TT	Transceiver acknowledges,
Sent:	TT	Have transceiver send a 1750 Hz tone.						
Return:	TT	Transceiver acknowledges,						

TYD	Radio Type							
<p><i>Description:</i></p> <p>Displays the radio type. <span style="float: right;"><i>Menu Item #</i> <i>n/a</i></span></p>								
<p><i>Function:</i></p> <p>Unknown</p>								
<p><i>Send:</i></p> <table border="1" data-bbox="240 663 1382 705"> <tr> <td data-bbox="240 663 428 705">Status:</td> <td data-bbox="428 663 1382 705">TYD</td> </tr> </table>			Status:	TYD				
Status:	TYD							
<p><i>Return:</i></p> <table border="1" data-bbox="240 852 1382 894"> <tr> <td data-bbox="240 852 571 894">TYD [val1], [val2]</td> <td data-bbox="571 852 1382 894"></td> </tr> </table>			TYD [val1], [val2]					
TYD [val1], [val2]								
<p><i>Where:</i></p> <table border="1" data-bbox="240 1041 1382 1115"> <tr> <td data-bbox="240 1041 428 1083">[val1]</td> <td data-bbox="428 1041 1382 1083">KK for TH-F6</td> </tr> <tr> <td data-bbox="240 1083 428 1115">[val2]</td> <td data-bbox="428 1083 1382 1115">0F for TH-F6</td> </tr> </table>			[val1]	KK for TH-F6	[val2]	0F for TH-F6		
[val1]	KK for TH-F6							
[val2]	0F for TH-F6							
<p><i>Notes:</i></p>								
<p><i>Example:</i></p> <table border="1" data-bbox="240 1451 1382 1524"> <tr> <td data-bbox="240 1451 380 1482">Sent:</td> <td data-bbox="380 1451 740 1482">TYD</td> <td data-bbox="740 1451 1382 1482">Request radio type.</td> </tr> <tr> <td data-bbox="240 1482 380 1524">Return:</td> <td data-bbox="380 1482 740 1524">TYD KK,0F</td> <td data-bbox="740 1482 1382 1524">Transceiver responds.</td> </tr> </table>			Sent:	TYD	Request radio type.	Return:	TYD KK,0F	Transceiver responds.
Sent:	TYD	Request radio type.						
Return:	TYD KK,0F	Transceiver responds.						

TX	Transmit							
<p><i>Description:</i></p> <p>Switches transceiver to transmit mode. <span style="float: right;"><i>Menu Item #</i> n/a</span></p>								
<p><i>Function:</i></p> <p>Transceiver will transmit until an RX command is received.</p>								
<p><i>Send:</i></p> <table border="1" data-bbox="240 663 1382 705"> <tr> <td data-bbox="240 663 428 705">Modify:</td> <td colspan="2" data-bbox="428 663 1382 705">TX</td> </tr> </table>			Modify:	TX				
Modify:	TX							
<p><i>Return:</i></p> <table border="1" data-bbox="240 852 1382 894"> <tr> <td data-bbox="240 852 571 894">TX</td> <td colspan="2" data-bbox="571 852 1382 894"></td> </tr> </table>			TX					
TX								
<p><i>Where:</i></p> <table border="1" data-bbox="240 1035 1382 1077"> <tr> <td data-bbox="240 1035 428 1077">n/a</td> <td colspan="2" data-bbox="428 1035 1382 1077"></td> </tr> </table>			n/a					
n/a								
<p><i>Notes:</i></p> <p>Can be stopped by RX command.</p>								
<p><i>Example:</i></p> <table border="1" data-bbox="240 1371 1382 1451"> <tr> <td data-bbox="240 1371 380 1413">Sent:</td> <td data-bbox="380 1371 743 1413">TX</td> <td data-bbox="743 1371 1382 1413">Have transceiver enter the transmit mode.</td> </tr> <tr> <td data-bbox="240 1413 380 1451">Return:</td> <td data-bbox="380 1413 743 1451">TX</td> <td data-bbox="743 1413 1382 1451">Transceiver confirms.</td> </tr> </table>			Sent:	TX	Have transceiver enter the transmit mode.	Return:	TX	Transceiver confirms.
Sent:	TX	Have transceiver enter the transmit mode.						
Return:	TX	Transceiver confirms.						



UP	Up						
<p><i>Description:</i></p> <p>Moves up one memory channel in MR mode or up one frequency step in VFO mode. <span style="float: right;"><i>Menu Item #</i> n/a</span></p>							
<p><i>Function:</i></p> <p>Moves up one memory channel in MR mode or up one frequency step in VFO mode.</p>							
<p><i>Send:</i></p> <table border="1" data-bbox="240 663 1382 705"> <tr> <td data-bbox="240 663 428 705">Modify:</td> <td data-bbox="428 663 1382 705">UP</td> </tr> </table>		Modify:	UP				
Modify:	UP						
<p><i>Return:</i></p> <table border="1" data-bbox="240 852 1382 894"> <tr> <td data-bbox="240 852 571 894">UP</td> <td data-bbox="571 852 1382 894"></td> </tr> </table>		UP					
UP							
<p><i>Where:</i></p> <table border="1" data-bbox="240 1041 1382 1083"> <tr> <td data-bbox="240 1041 428 1083">n/a</td> <td data-bbox="428 1041 1382 1083"></td> </tr> </table>		n/a					
n/a							
<p><i>Notes:</i></p> <p>Same as rotating Tuning Control one click clockwise. See DW.</p>							
<p><i>Example:</i></p> <table border="1" data-bbox="240 1377 1382 1451"> <tr> <td data-bbox="240 1377 380 1419">Sent:</td> <td data-bbox="380 1377 740 1419">UP</td> <td data-bbox="740 1377 1382 1419">Have transceiver move up.</td> </tr> <tr> <td data-bbox="240 1419 380 1451">Return:</td> <td data-bbox="380 1419 740 1451">UP</td> <td data-bbox="740 1419 1382 1451">Transceiver confirms.</td> </tr> </table>		Sent:	UP	Have transceiver move up.	Return:	UP	Transceiver confirms.
Sent:	UP	Have transceiver move up.					
Return:	UP	Transceiver confirms.					

VMC	Mode of the VFO band													
<p><i>Description:</i></p> <p>Get/Set the mode of the VFO band. <span style="float: right;"><i>Menu Item #</i> n/a</span></p>														
<p><i>Function:</i></p> <p>Will switch the A or B band from VFO, MR, or CALL mode.</p>														
<p><i>Send:</i></p> <table border="1" data-bbox="240 663 1382 705"> <tr> <td>Status:</td> <td colspan="2">VMC [band] to get the mode of band.</td> </tr> </table> <table border="1" data-bbox="240 741 1382 783"> <tr> <td>Modify:</td> <td colspan="2">VMC [band], [mode] to set the mode of band.</td> </tr> </table>			Status:	VMC [band] to get the mode of band.		Modify:	VMC [band], [mode] to set the mode of band.							
Status:	VMC [band] to get the mode of band.													
Modify:	VMC [band], [mode] to set the mode of band.													
<p><i>Return:</i></p> <table border="1" data-bbox="240 926 1382 968"> <tr> <td>VMC [band], [mode]</td> <td></td> </tr> </table>			VMC [band], [mode]											
VMC [band], [mode]														
<p><i>Where:</i></p> <table border="1" data-bbox="240 1115 1382 1157"> <tr> <td>[band]</td> <td>see Band Switch Table</td> </tr> </table> <table border="1" data-bbox="240 1157 1382 1199"> <tr> <td>[mode]</td> <td>see VFO Mode Table</td> </tr> </table>			[band]	see Band Switch Table	[mode]	see VFO Mode Table								
[band]	see Band Switch Table													
[mode]	see VFO Mode Table													
<p><i>Notes:</i></p>														
<p><i>Example:</i></p> <table border="1" data-bbox="240 1486 1382 1566"> <tr> <td>Sent:</td> <td>VMC 0</td> <td>Request mode of A band.</td> </tr> <tr> <td>Return:</td> <td>VMC 0,0</td> <td>Transceiver says A band is in VFO mode.</td> </tr> </table> <table border="1" data-bbox="240 1602 1382 1682"> <tr> <td>Sent:</td> <td>VMC 1,1</td> <td>Request that B band be in MR mode.</td> </tr> <tr> <td>Return:</td> <td>VMC 1,1</td> <td>Transceiver confirms.</td> </tr> </table>			Sent:	VMC 0	Request mode of A band.	Return:	VMC 0,0	Transceiver says A band is in VFO mode.	Sent:	VMC 1,1	Request that B band be in MR mode.	Return:	VMC 1,1	Transceiver confirms.
Sent:	VMC 0	Request mode of A band.												
Return:	VMC 0,0	Transceiver says A band is in VFO mode.												
Sent:	VMC 1,1	Request that B band be in MR mode.												
Return:	VMC 1,1	Transceiver confirms.												

VOX	VOX Transmit	
<i>Description:</i>		
Sets or gets VOX on transmit.		<i>Menu Item # n/a</i>
<i>Function:</i>		
VOX Transmit automatically switches to transmit when the VOX circuitry senses sound in the microphone.		
<i>Send:</i>		
Status:	VOX	
Modify:	VOX [val]	
<i>Return:</i>		
VOX [val]		
<i>Where:</i>		
[val]	see Logic Table	
<i>Notes:</i>		
<i>Example:</i>		
Sent:	VOX	Request status of VOX transmit.
Return:	VOX 0	Transceiver says VOX transmit mode is off.
Sent:	VOX 1	Request that VOX transmit mode be on.
Return:	VOX 1	Transceiver confirms.

VR	VFO Read							
<p><i>Description:</i></p> <p>Read the VFO Setting for specified band. <span style="float: right;"><i>Menu Item #</i> <i>n/a</i></span></p>								
<p><i>Function:</i></p> <p>Reads all data associated with a VFO.</p>								
<p><i>Send:</i></p> <table border="1" data-bbox="240 663 1382 705"> <tr> <td data-bbox="240 663 428 705">Status:</td> <td data-bbox="428 663 1382 705">VR [band]</td> </tr> </table>			Status:	VR [band]				
Status:	VR [band]							
<p><i>Get:</i></p> <p>VR [band],[freq]</p>								
<p><i>Where:</i></p> <table border="1" data-bbox="240 999 1382 1083"> <tr> <td data-bbox="240 999 428 1041">[band]</td> <td data-bbox="428 999 1382 1041">see Band Table</td> </tr> <tr> <td data-bbox="240 1041 428 1083">[freq]</td> <td data-bbox="428 1041 1382 1083">See Freq Table. Lockout value excluded.</td> </tr> </table>			[band]	see Band Table	[freq]	See Freq Table. Lockout value excluded.		
[band]	see Band Table							
[freq]	See Freq Table. Lockout value excluded.							
<p><i>Notes:</i></p>								
<p><i>Example:</i></p> <table border="1" data-bbox="240 1367 1382 1524"> <tr> <td data-bbox="240 1367 380 1409">Sent:</td> <td data-bbox="380 1367 740 1409">VR 0</td> <td data-bbox="740 1367 1382 1409">Request data for 2 m VFO band.</td> </tr> <tr> <td data-bbox="240 1409 380 1524">Return:</td> <td data-bbox="380 1409 740 1524">VR 0, 00142060000,0,0,0,0,1,0, 25,09,001,000700000,0</td> <td data-bbox="740 1409 1382 1524">A frequency of 142.06 MHz. CTCSS is on at a frequency of 88.5 Hz. An offset of 700 KHz.</td> </tr> </table>			Sent:	VR 0	Request data for 2 m VFO band.	Return:	VR 0, 00142060000,0,0,0,0,1,0, 25,09,001,000700000,0	A frequency of 142.06 MHz. CTCSS is on at a frequency of 88.5 Hz. An offset of 700 KHz.
Sent:	VR 0	Request data for 2 m VFO band.						
Return:	VR 0, 00142060000,0,0,0,0,1,0, 25,09,001,000700000,0	A frequency of 142.06 MHz. CTCSS is on at a frequency of 88.5 Hz. An offset of 700 KHz.						

VW		VFO Write
<i>Description:</i>		
Sets the VFO values of the specified band.		<i>Menu Item #</i> n/a
<i>Function:</i>		
Saves all data associated with a VFO.		
<i>Send:</i>		
Modify:	VW [band],[freq]	
<i>Return:</i>		
VW		
<i>Where:</i>		
[band]	See Ham Band Table.	
[freq]	See Freq Table. Lockout value excluded.	
<i>Notes:</i>		
<i>Example:</i>		
Sent:	VW 0, 00142060000,0,0,0,0,1,0, 25,09,001,000700000,0	Request that VFO be set to a frequency of 142.06 MHz. CTCSS be on at a frequency of 88.5 Hz. An offset of 700 KHz.
Return:	VW	Transceiver confirms.

<b>VXB</b>	<b>VOX On Busy</b>
------------	--------------------

*Description:*

Gets or sets the VOX On Busy function.

*Menu Item #*  
20

*Function:*

Configure transceiver to force VOX transmission even if the transceiver is receiving a signal on A or B band.

*Send:*

Status:	VXB
---------	-----

Modify:	VXB [val]
---------	-----------

*Return:*

VXB [val]	
-----------	--

*Where:*

[val]	see Logic Table
-------	-----------------

*Notes:*

*Example:*

Sent:	VXB	Requesting status of VOX on Busy.
Return:	VXB 0	Transceiver says VOX on Busy is off.

Sent:	VXB 1	Request that VOX on Busy be on.
Return:	VXB 1	Transceiver confirms that VOX on Busy is on.

VXD	VOX Delay	
<i>Description:</i>		
Gets or sets the VOX Delay time.		<i>Menu Item #</i> 22
<i>Function:</i>		
Sets or gets the delay time between transmit and receive after sound input stops.		
<i>Send:</i>		
Status:	VXD	
Modify:	VXD [val]	
<i>Return:</i>		
VXD [val]		
<i>Where:</i>		
[val]	see VOX Delay Table	
<i>Notes:</i>		
<i>Example:</i>		
Sent:	VXD	Request VOX delay time.
Return:	VXD 1	Transceiver says VOX delay time is 500 ms.
Sent:	VXD 0	Request that VOX delay time is 250 ms.
Return:	VXD 0	Conformation that VOX delay time is 250 ms.

VXG	VOX Gain	
<i>Description:</i>		
Gets or sets the VOX Gain.		<i>Menu Item # 21</i>
<i>Function:</i>		
Controls the VOX circuit to detect the presence or absence of sound.		
<i>Send:</i>		
Status:	VXG	
Modify:	VXG [val]	
<i>Return:</i>		
VXG [val]		
<i>Where:</i>		
[val]	is a number from 0 to 9. The default value is 4.	
<i>Notes:</i>		
<i>Example:</i>		
Sent:	VXG	Requesting the VOX level.
Return:	VXG 4	Transceiver says the VOX level is 4.
Sent:	VXG 9	Request the VOX level to be 9.
Return:	VXG 9	Confirmation of VOX level of 9.



## Menu Item Summary

Command	Description	Menu Item
SCR	Scan Resume	01
MGL	Memory Group Link	02
MRM	Memory Recall Method	03
PV	Program VFO Limits	04
ARO	Auto Repeater Offset	05
unknown	Offset	06
ELK	Tune Enable	07
THS	Transmit Inhibit	08
unavailable	SP/MIC Jack	09
DM/ DMN	Get/Set DTMF Memory Location	10
TSP	DTMF Speed	11
TXH	DTMF Hold	12
PT	DTMF Pause	13
DLK	DTMF Lock	14
MES	Get/Set Power on Message	15
CNT	Contrast	16
SV	Battery Saver	17
APO	Automatic Power Off (APO)	18
BEP	Beep Function	19
VXB	VOX on Busy	20
VXG	VOX Gain	21
VXD	VOX Delay	22
CKEY	Call Key	23
TH	1750 Hold	24
NSFT	Beat Shift	25
ANT	Bar Antenna	26
LAN	Get/Set Default Language	27
DATP	Packet Speed	28
NAR	FM Narrow	29
BAT	Battery Type	30
SR	Reset	31

Function	Keystroke	Command	Function
LOW	LOW	PC	Select Transmitter Power
BAND	BAND	BC	Select Band
A/B	A/B		Select A/B Band
F	F		Shift
INFO	INFO		Select Information Channels
SQL	SQL	SQ	Adjusting Squelch
BAL	BAL	BAL	Set Volume Balance Between Bands
VFO	VFO		Enter VFO Mode
TONE	TONE		Activate Tone Function
REV	REV		Reverse Rec/Xmit Frequencies
MN-f	MN-f	MNF	Switch Between Memory Name and Frequency
MR	MR		Memory Recall
MHz	MHz		Enter MHz Tuning Mode
FINE	FINE		Enter Fine Tuning Mode
ENT	ENT		Enter Number Entry mode
CALL	CALL		Select Call Channel
BATT	F,LOW		Battery Remaining
MODE	F,BAND		Select Receiving Mode
DUAL	F,A/B	DL	Select Single/Dual Band Operation
(key)	F,F		Enter Locked Mode
VISUAL	F,INFO		Enable Visual Scan
VOX	F,SQL	VOX	Enable VOX
PRI	F,BAL		Priority Scan
M-V	F,VFO		Transfer Memory to VFO
T.SEL	F,TONE		Select Tone Frequency
SHIFT	F,REV		Set Offset Direction
MN.IN	F,MN-f		Enter Memory Name Input Mode
M.IN	F,MR		Store in Memory
L.OUT	F,MHz		Lockout
STEP	F,FINE		Select Fine Tuning Frequency Step
(bell)	F,ENT	BEL	Tone Alert
C.IN	F,CALL		Store Call Channel
	LOW (1s)		
	BAND (1s)		
	A/B (1s)		
Lock Function	F (1s)		
Info Channel Scan Start	INFO (1s)		
	SQL (1s)		
	BAL (1s)		
Band Scan/Program Scan Start	VFO (1s)		
Tone Freq ID Scan	TONE (1s)		

ASC	REV (1s)		
	MN-f (1s)		
Memory Scan Start	MR (1s)		
MHz Scan/Group Scan Start	MHz (1s)		
	FINE (1s)		
	ENT (1s)		
	CALL (1s)		
	F,LOW (1s)		
	F,BAND (1s)		
	F,A/B (1s)		
	F, F (1s)		
	F,INFO (1s)		
	F,SQL (1s)		
	F,BAL (1s)		
	F,VFO (1s)		
CTCSS/DCS ID Scan	F,TONE (1s)		
	F,REV (1s)		
	F,MN-f (1s)		
	F,MR (1s)		
	F,MHz (1s)		
	F,FINE (1s)		
	F,ENT (1s)		
Call Scan Start	CALL (1s)		
1			
2			
3			
A			
4			
5			
6			
B			
7			
8			
9			
C			
*			
0			
#			
D			
VOL			
TUNING			
PTT			

LAMP			
MONI			
Scroll Key			
Power			
	[PTT]+[MR]		
	[PTT]+[▶]		
	[PTT]+[MNU]		
	[MR]+[PWR]		
	[PTT]+[CALL]		
	[A/B]+[PWR]		
	[PTT]+{VFO}+[PWR]		
	[PTT]+[MR]+[PWR]		
	[F]+[PWR]		
	[MHz]+[PWR]		

# Splash Screen

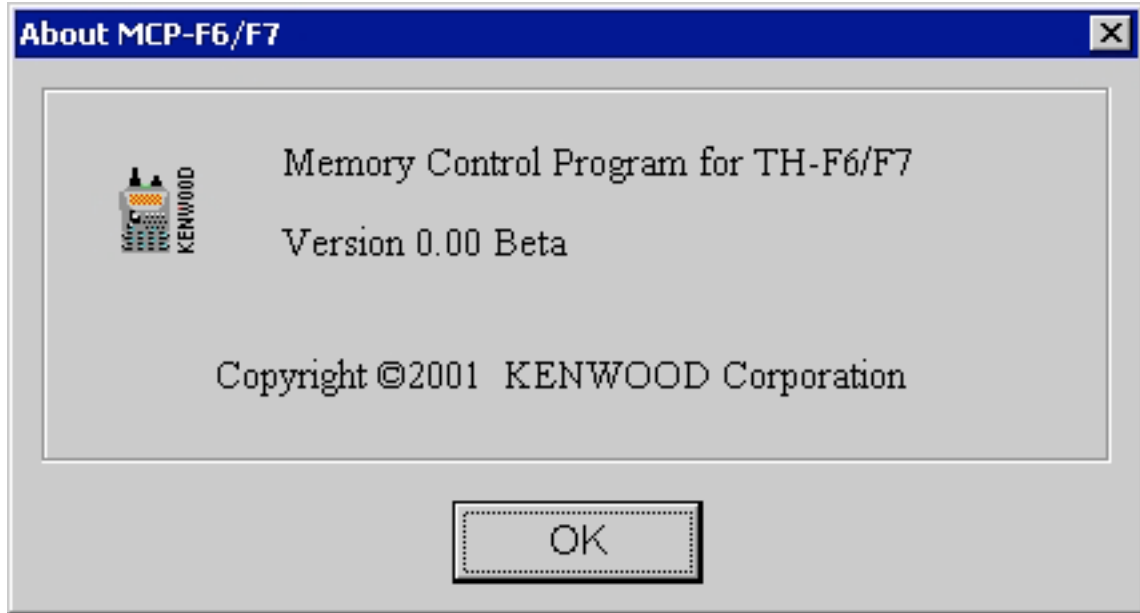

# Memory Screen

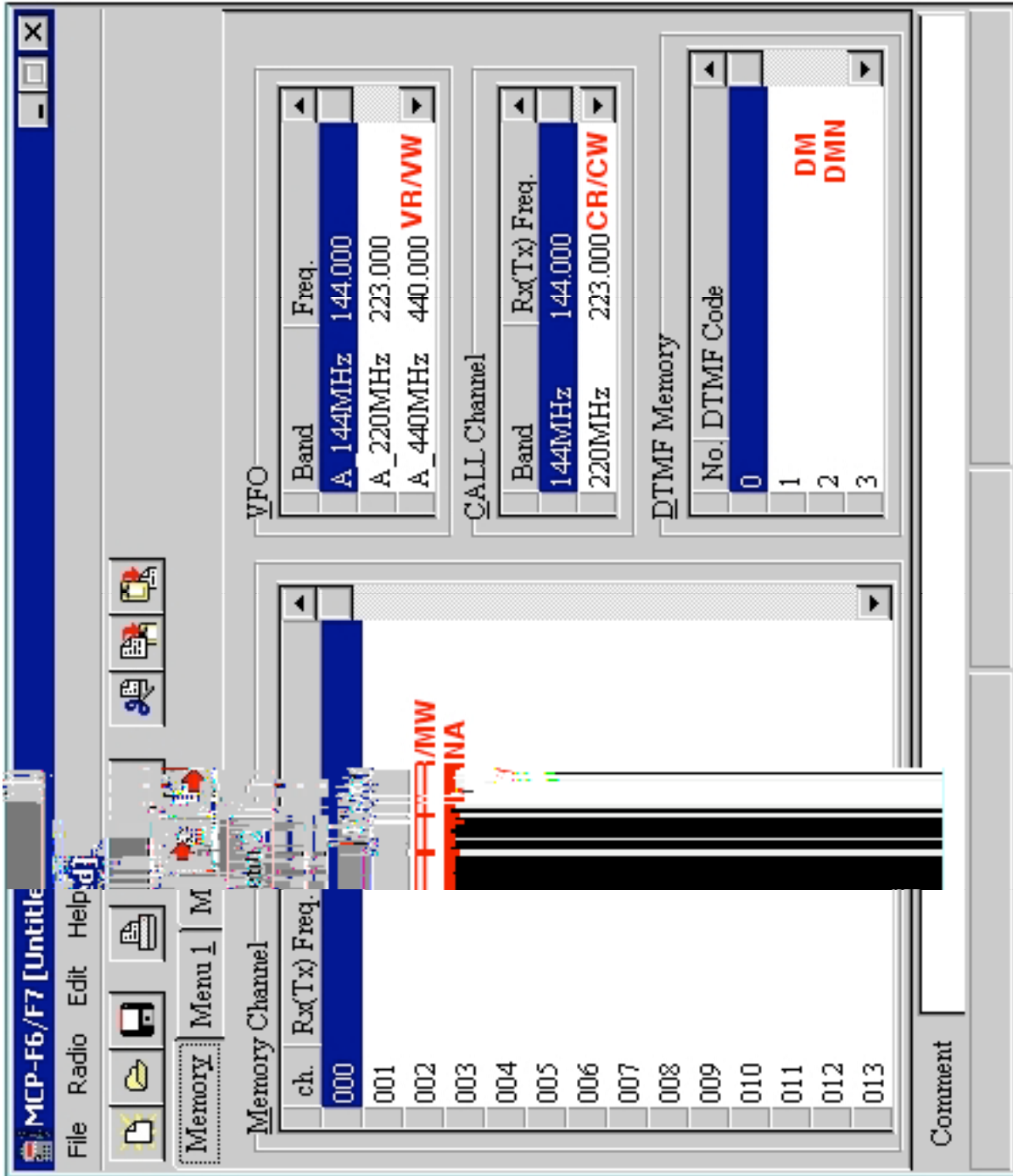

# Menu1 Screen

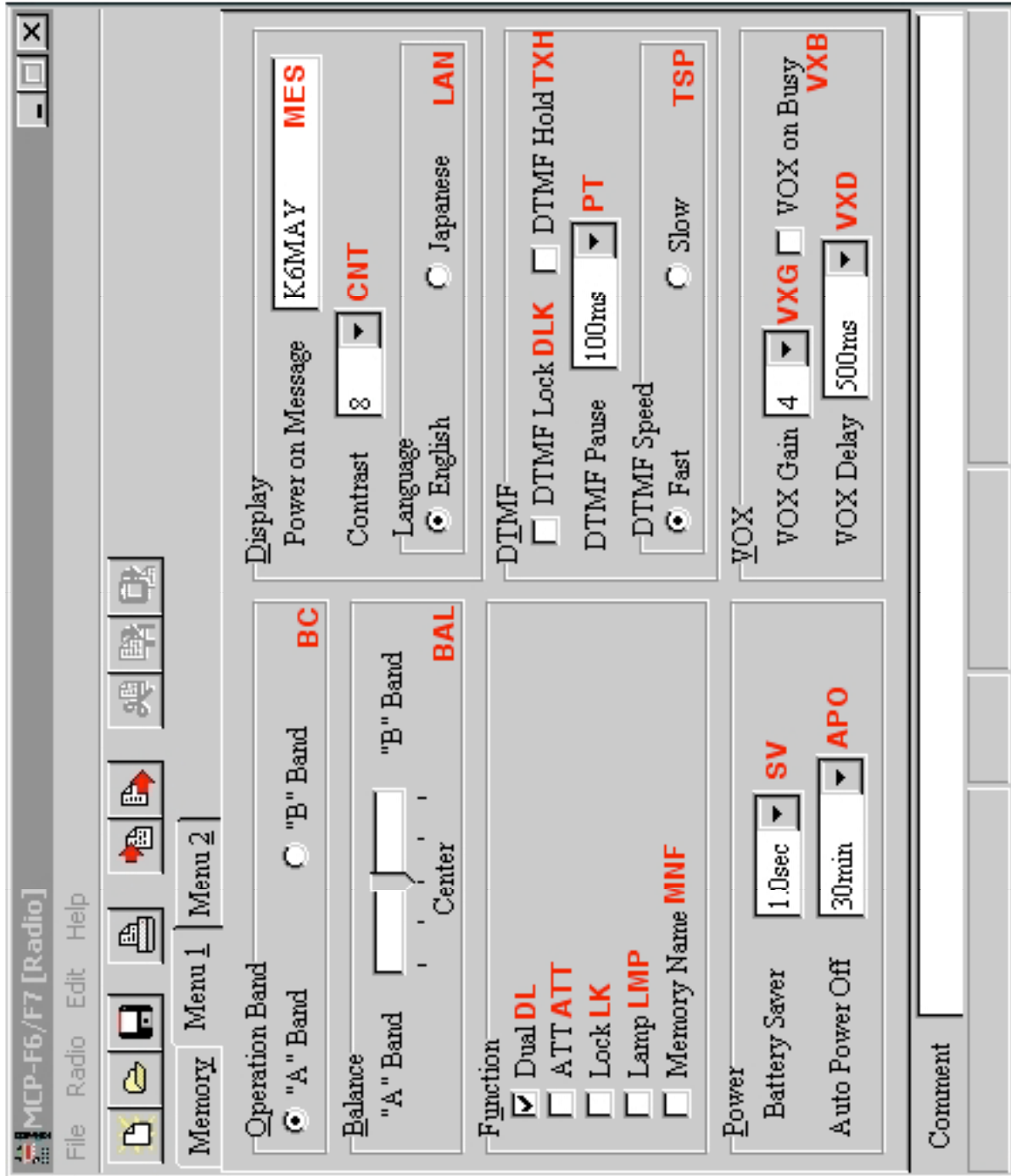

# Menu2 Screen

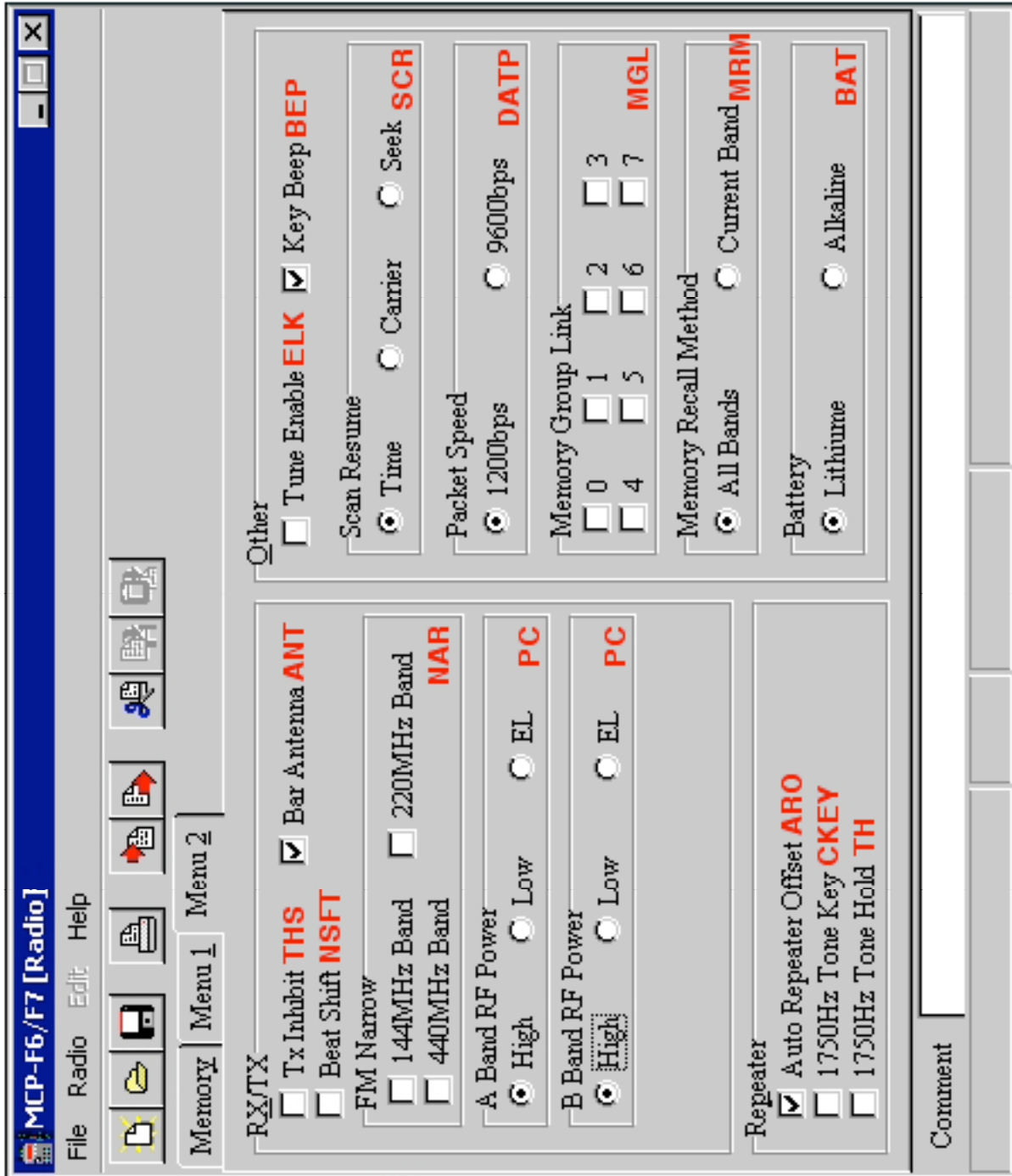



# Memory Channel Entry Screen

The screenshot shows a software window titled "Memory" with a close button in the top right corner. The window contains the following fields and controls:

- Memory Channel Number:** A numeric input field containing the value "0".
- Frequency Section:**
  - Rx Frequency:** A numeric input field containing "144.000" followed by "MHz".
  - Step:** A dropdown menu currently set to "5kHz".
  - Mode:** A dropdown menu currently set to "FM".
  - Offset:** A numeric input field containing "0.60" followed by "MHz".
- Tone/CTCSS/DCS Section:**
  - Three checkboxes: "Tone" (unchecked), "CTCSS" (unchecked), and "DCS" (unchecked).
  - Tone Frequency:** A dropdown menu set to "88.5Hz".
  - CTCSS Frequency:** A dropdown menu set to "88.5Hz".
  - DCS Code:** A dropdown menu set to "023".
- Option Section:**
  - Four radio buttons: "Split Channel" (unchecked), "Simplex" (checked), "Plus Shift" (unchecked), and "Minus Shift" (unchecked).
  - A checkbox labeled "Reverse" (unchecked).
  - Memory Name:** An empty text input field.
  - A checkbox labeled "Lock Out" (unchecked).

At the bottom right of the window are two buttons: "OK" and "Close".

# VFO Entry Screen

The image shows a software dialog box titled "VfoForm" with a close button (X) in the top right corner. The dialog is organized into several sections:

- Band:** A dropdown menu showing "A\_144MHz".
- Frequency:** A section containing:
  - Rx Frequency:** A text input field with "144.000" and "MHz" to its right.
  - Step:** A dropdown menu showing "5kHz".
  - Mode:** A dropdown menu showing "FM".
  - Offset:** A text input field with "0.60" and "MHz" to its right.
  - Shift Options:** Three radio buttons: "Simplex" (selected), "Plus Shift", and "Minus Shift".
  - Reverse:** An unchecked checkbox labeled "Reverse".
- Tone/CTCSS/DCS:** A section containing:
  - Three unchecked checkboxes: "Tone", "CTCSS", and "DCS".
  - Tone Frequency:** A dropdown menu showing "88.5Hz".
  - CTCSS Frequency:** A dropdown menu showing "88.5Hz".
  - DCS Code:** A dropdown menu showing "023".
- Program VFO:** A section containing two text input fields: "137" and "173", separated by a hyphen, with "MHz" to the right.

At the bottom of the dialog are two buttons: "OK" and "Close".

# Call Channel Entry Screen

The screenshot shows a software window titled "CALL Channel" with a close button in the top right corner. The window is divided into several sections for configuring a call channel. At the top, the "Band" is set to "144MHz" via a dropdown menu. Below this, the "Frequency" section contains a text box for "Rx Frequency" with the value "144.000" and the unit "MHz". Underneath are dropdown menus for "Step" (set to "5kHz"), "Mode" (set to "FM"), and "Offset" (set to "0.60" MHz). A group of radio buttons allows selecting the channel type: "Split Channel", "Simplex" (which is selected), "Plus Shift", and "Minus Shift". A "Reverse" checkbox is also present. To the right, the "Tone/CTCSS/DCS" section has three unchecked checkboxes for "Tone", "CTCSS", and "DCS". Below these are dropdown menus for "Tone Frequency" (88.5Hz), "CTCSS Frequency" (88.5Hz), and "DCS Code" (023). At the bottom right, there are "OK" and "Close" buttons.

**CALL Channel** [X]

Band: 144MHz

Frequency

Rx Frequency: 144.000 MHz

Step: 5kHz

Mode: FM

Offset: 0.60 MHz

Split Channel  
 Simplex  Reverse  
 Plus Shift  
 Minus Shift

Tone/CTCSS/DCS

Tone  
 CTCSS  
 DCS

Tone Frequency: 88.5Hz

CTCSS Frequency: 88.5Hz

DCS Code: 023

OK Close

# DTMF Entry Screen

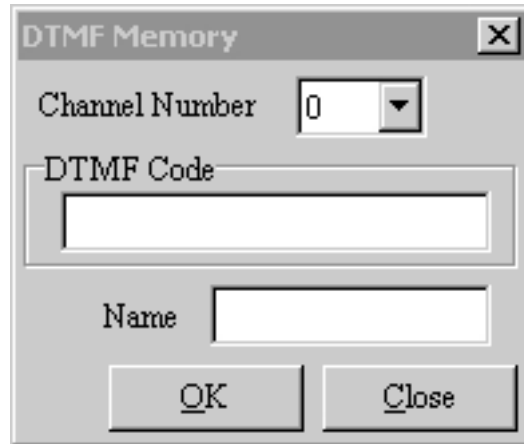

The image shows a dialog box titled "DTMF Memory" with a close button (X) in the top right corner. It contains three input fields: a "Channel Number" dropdown menu currently showing "0", a "DTMF Code" text box, and a "Name" text box. At the bottom, there are two buttons: "OK" and "Close".

# Hardware Interface for Macintosh



# Format of the F6/F7 Kenwood File

	Description
<u>__COMMENT__</u>	The comment that appears at the bottom of main screen. The comments line is stored in the configuration file. The comment has nothing to do with the radio.
<u>MEMORY DATA</u>	
<u>CALL DATA</u>	
<u>VFO DATA</u>	
<u>DTMF DATA</u>	
<u>RADIO MENU</u>	

KENWOOD Memory Control Program for TH-FX

```

__COMMENT__
<character string>
MEMORY DATA
<MR/MW 0 [mem]> <MR/MR 0 [freq]> <MR/MW 1 [freq]> <MNA [name]>
CALL DATA
<CR/CW 0 [band]> <CR/CW 0 [freq]> <CR/CW 1 [freq]>
VFO DATA
<VR/VW [band]> <VR/VW [freq]>
DTMF DATA
<DM [cc]> <DM [num]> <DMN [name]>
RADIO MENU
<PV [band]>,<PV [F1]>,<PV [f2]>
<UNKNOWN>
<BC [val]>
<BAL [val]>
<DL [val]>
<ATT [val]>
<LK [val]>
<LMP [val]>
<MNF [val]>
<PC A Band [pwr]>
<PC B Band [pwr]>
<1.2G A Band Power>
<1.2G B Band Power>
<SCR [val]>
<MGL [val]>
<MRM [val]>
<ARO [val]>
<ELK [val]>
<TXS [val]>

```

<TSP [val]>  
<PT [val]>  
<DLK [val]>  
<TXH [val]>  
<MES [message]>  
<CNT [val]>  
<SV [val]>  
<APO [val]>  
<BEP [val]>  
<VXB [val]>  
<VXG [val]>  
<VXD [val]>  
<CKEY [val]>  
<TH [val]>  
<NSFT [val]>  
<ANT [val]>  
<LAN [lang]>  
<DATP [val]>  
<NAR 0 [val]>  
<NAR 1 [val]>  
<NAR 2 [val]>  
<UNKNOWN>  
<UNKNOWN>  
<BAT [val]>

## Commands to set TH-F6 to factory reset state

```
ANT 1
APO 1
ARO 1
ASC 0,0
ASC 1,0
ATT 0
BAL 2
BAT 0
BC 0
BEP 1
BEL 0,0
BEL 1,0
BY 0,1
BY 1,1
CKEY 0
CNT 08
CW 0,00144000000,0,0,0,0,0,0,08,08,000,000600000,0
CW 0,00223000000,7,0,0,0,0,0,08,08,000,001600000,0
CW 0,00440000000,8,0,0,0,0,0,08,08,000,005000000,0
DATP 0
DL 1
DLK 0
DM 00,
DM 01,
DM 02,
DM 03,
DM 04,
DM 05,
DM 06,
DM 07,
DM 08,
DM 09,
DMN 00,
DMN 01,
DMN 02,
DMN 03,
DMN 04,
DMN 05,
DMN 06,
DMN 07,
DMN 08,
DMN 09,
ELK 0
FL 0,00137,00174,00216,00260,00410,00470,
FL
1,0000010,0000180,0000180,0002970,0002970,0005400,0005400,0010800,001
08,00137,00137,00174,00174,00216,00216,00400,00400,00470,00470,00806,
00806,01300
FQ 00144000000,0
FST 1
```



ID TH-F6  
LAN 0  
LK 0  
LMP 0  
MC 0,  
MC 1,  
MD 0  
MES HELLO !!  
MGL  
MNA 000,  
MNA 001,  
MNA 002,  
MNA 003,  
MNA 004,  
MNA 005,  
MNA 006,  
MNA 007,  
MNA 008,  
MNA 009,  
MNA 010,  
MNA 011,  
MNA 012,  
MNA 013,  
MNA 014,  
MNA 015,  
MNA 016,  
MNA 017,  
MNA 018,  
MNA 019,  
MNA 020,  
MNA 021,  
MNA 022,  
MNA 023,  
MNA 024,  
MNA 025,  
MNA 026,  
MNA 027,  
MNA 028,  
MNA 029,  
MNA 030,  
MNA 031,  
MNA 032,  
MNA 033,  
MNA 034,  
MNA 035,  
MNA 036,  
MNA 037,  
MNA 038,  
MNA 039,  
MNA 040,  
MNA 041,

MNA 042,  
MNA 043,  
MNA 044,  
MNA 045,  
MNA 046,  
MNA 047,  
MNA 048,  
MNA 049,  
MNA 050,  
MNA 051,  
MNA 052,  
MNA 053,  
MNA 054,  
MNA 055,  
MNA 056,  
MNA 057,  
MNA 058,  
MNA 059,  
MNA 060,  
MNA 061,  
MNA 062,  
MNA 063,  
MNA 064,  
MNA 065,  
MNA 066,  
MNA 067,  
MNA 068,  
MNA 069,  
MNA 070,  
MNA 071,  
MNA 072,  
MNA 073,  
MNA 074,  
MNA 075,  
MNA 076,  
MNA 077,  
MNA 078,  
MNA 079,  
MNA 080,  
MNA 081,  
MNA 082,  
MNA 083,  
MNA 084,  
MNA 085,  
MNA 086,  
MNA 087,  
MNA 088,  
MNA 089,  
MNA 090,  
MNA 091,  
MNA 092,

MNA 093,  
MNA 094,  
MNA 095,  
MNA 096,  
MNA 097,  
MNA 098,  
MNA 099,  
MNA 100,  
MNA 101,  
MNA 102,  
MNA 103,  
MNA 104,  
MNA 105,  
MNA 106,  
MNA 107,  
MNA 108,  
MNA 109,  
MNA 110,  
MNA 111,  
MNA 112,  
MNA 113,  
MNA 114,  
MNA 115,  
MNA 116,  
MNA 117,  
MNA 118,  
MNA 119,  
MNA 120,  
MNA 121,  
MNA 122,  
MNA 123,  
MNA 124,  
MNA 125,  
MNA 126,  
MNA 127,  
MNA 128,  
MNA 129,  
MNA 130,  
MNA 131,  
MNA 132,  
MNA 133,  
MNA 134,  
MNA 135,  
MNA 136,  
MNA 137,  
MNA 138,  
MNA 139,  
MNA 140,  
MNA 141,  
MNA 142,  
MNA 143,

MNA 144,  
MNA 145,  
MNA 146,  
MNA 147,  
MNA 148,  
MNA 149,  
MNA 150,  
MNA 151,  
MNA 152,  
MNA 153,  
MNA 154,  
MNA 155,  
MNA 156,  
MNA 157,  
MNA 158,  
MNA 159,  
MNA 160,  
MNA 161,  
MNA 162,  
MNA 163,  
MNA 164,  
MNA 165,  
MNA 166,  
MNA 167,  
MNA 168,  
MNA 169,  
MNA 170,  
MNA 171,  
MNA 172,  
MNA 173,  
MNA 174,  
MNA 175,  
MNA 176,  
MNA 177,  
MNA 178,  
MNA 179,  
MNA 180,  
MNA 181,  
MNA 182,  
MNA 183,  
MNA 184,  
MNA 185,  
MNA 186,  
MNA 187,  
MNA 188,  
MNA 189,  
MNA 190,  
MNA 191,  
MNA 192,  
MNA 193,  
MNA 194,

MNA 195,  
MNA 196,  
MNA 197,  
MNA 198,  
MNA 199,  
MNA 200,  
MNA 201,  
MNA 202,  
MNA 203,  
MNA 204,  
MNA 205,  
MNA 206,  
MNA 207,  
MNA 208,  
MNA 209,  
MNA 210,  
MNA 211,  
MNA 212,  
MNA 213,  
MNA 214,  
MNA 215,  
MNA 216,  
MNA 217,  
MNA 218,  
MNA 219,  
MNA 220,  
MNA 221,  
MNA 222,  
MNA 223,  
MNA 224,  
MNA 225,  
MNA 226,  
MNA 227,  
MNA 228,  
MNA 229,  
MNA 230,  
MNA 231,  
MNA 232,  
MNA 233,  
MNA 234,  
MNA 235,  
MNA 236,  
MNA 237,  
MNA 238,  
MNA 239,  
MNA 240,  
MNA 241,  
MNA 242,  
MNA 243,  
MNA 244,  
MNA 245,

MNA 246,  
MNA 247,  
MNA 248,  
MNA 249,  
MNA 250,  
MNA 251,  
MNA 252,  
MNA 253,  
MNA 254,  
MNA 255,  
MNA 256,  
MNA 257,  
MNA 258,  
MNA 259,  
MNA 260,  
MNA 261,  
MNA 262,  
MNA 263,  
MNA 264,  
MNA 265,  
MNA 266,  
MNA 267,  
MNA 268,  
MNA 269,  
MNA 270,  
MNA 271,  
MNA 272,  
MNA 273,  
MNA 274,  
MNA 275,  
MNA 276,  
MNA 277,  
MNA 278,  
MNA 279,  
MNA 280,  
MNA 281,  
MNA 282,  
MNA 283,  
MNA 284,  
MNA 285,  
MNA 286,  
MNA 287,  
MNA 288,  
MNA 289,  
MNA 290,  
MNA 291,  
MNA 292,  
MNA 293,  
MNA 294,  
MNA 295,  
MNA 296,

MNA 297,  
MNA 298,  
MNA 299,  
MNA 300,  
MNA 301,  
MNA 302,  
MNA 303,  
MNA 304,  
MNA 305,  
MNA 306,  
MNA 307,  
MNA 308,  
MNA 309,  
MNA 310,  
MNA 311,  
MNA 312,  
MNA 313,  
MNA 314,  
MNA 315,  
MNA 316,  
MNA 317,  
MNA 318,  
MNA 319,  
MNA 320,  
MNA 321,  
MNA 322,  
MNA 323,  
MNA 324,  
MNA 325,  
MNA 326,  
MNA 327,  
MNA 328,  
MNA 329,  
MNA 330,  
MNA 331,  
MNA 332,  
MNA 333,  
MNA 334,  
MNA 335,  
MNA 336,  
MNA 337,  
MNA 338,  
MNA 339,  
MNA 340,  
MNA 341,  
MNA 342,  
MNA 343,  
MNA 344,  
MNA 345,  
MNA 346,  
MNA 347,

MNA 348,  
MNA 349,  
MNA 350,  
MNA 351,  
MNA 352,  
MNA 353,  
MNA 354,  
MNA 355,  
MNA 356,  
MNA 357,  
MNA 358,  
MNA 359,  
MNA 360,  
MNA 361,  
MNA 362,  
MNA 363,  
MNA 364,  
MNA 365,  
MNA 366,  
MNA 367,  
MNA 368,  
MNA 369,  
MNA 370,  
MNA 371,  
MNA 372,  
MNA 373,  
MNA 374,  
MNA 375,  
MNA 376,  
MNA 377,  
MNA 378,  
MNA 379,  
MNA 380,  
MNA 381,  
MNA 382,  
MNA 383,  
MNA 384,  
MNA 385,  
MNA 386,  
MNA 387,  
MNA 388,  
MNA 389,  
MNA 390,  
MNA 391,  
MNA 392,  
MNA 393,  
MNA 394,  
MNA 395,  
MNA 396,  
MNA 397,  
MNA 398,



MNA 399,  
MNA L0,  
MNA L1,  
MNA L2,  
MNA L3,  
MNA L4,  
MNA L5,  
MNA L6,  
MNA L7,  
MNA L8,  
MNA L9,  
MNA U0,  
MNA U1,  
MNA U2,  
MNA U3,  
MNA U4,  
MNA U5,  
MNA U6,  
MNA U7,  
MNA U8,  
MNA U9,  
MNA I-0, WEATHER  
MNA I-1, WEATHER  
MNA I-2, WEATHER  
MNA I-3, WEATHER  
MNA I-4, WEATHER  
MNA I-5, WEATHER  
MNA I-6, WEATHER  
MNA I-7, WEATHER  
MNA I-8, WEATHER  
MNA I-9, WEATHER  
MNA PR1,  
MNA PR2,  
MNF 0  
MW 0,000  
MW 0,001  
MW 0,002  
MW 0,003  
MW 0,004  
MW 0,005  
MW 0,006  
MW 0,007  
MW 0,008  
MW 0,009  
MW 0,010  
MW 0,011  
MW 0,012  
MW 0,013  
MW 0,014  
MW 0,015  
MW 0,016

MW 0,017  
MW 0,018  
MW 0,019  
MW 0,020  
MW 0,021  
MW 0,022  
MW 0,023  
MW 0,024  
MW 0,025  
MW 0,026  
MW 0,027  
MW 0,028  
MW 0,029  
MW 0,030  
MW 0,031  
MW 0,032  
MW 0,033  
MW 0,034  
MW 0,035  
MW 0,036  
MW 0,037  
MW 0,038  
MW 0,039  
MW 0,040  
MW 0,041  
MW 0,042  
MW 0,043  
MW 0,044  
MW 0,045  
MW 0,046  
MW 0,047  
MW 0,048  
MW 0,049  
MW 0,050  
MW 0,051  
MW 0,052  
MW 0,053  
MW 0,054  
MW 0,055  
MW 0,056  
MW 0,057  
MW 0,058  
MW 0,059  
MW 0,060  
MW 0,061  
MW 0,062  
MW 0,063  
MW 0,064  
MW 0,065  
MW 0,066  
MW 0,067

MW 0,068  
MW 0,069  
MW 0,070  
MW 0,071  
MW 0,072  
MW 0,073  
MW 0,074  
MW 0,075  
MW 0,076  
MW 0,077  
MW 0,078  
MW 0,079  
MW 0,080  
MW 0,081  
MW 0,082  
MW 0,083  
MW 0,084  
MW 0,085  
MW 0,086  
MW 0,087  
MW 0,088  
MW 0,089  
MW 0,090  
MW 0,091  
MW 0,092  
MW 0,093  
MW 0,094  
MW 0,095  
MW 0,096  
MW 0,097  
MW 0,098  
MW 0,099  
MW 0,100  
MW 0,101  
MW 0,102  
MW 0,103  
MW 0,104  
MW 0,105  
MW 0,106  
MW 0,107  
MW 0,108  
MW 0,109  
MW 0,110  
MW 0,111  
MW 0,112  
MW 0,113  
MW 0,114  
MW 0,115  
MW 0,116  
MW 0,117  
MW 0,118

MW 0,119  
MW 0,120  
MW 0,121  
MW 0,122  
MW 0,123  
MW 0,124  
MW 0,125  
MW 0,126  
MW 0,127  
MW 0,128  
MW 0,129  
MW 0,130  
MW 0,131  
MW 0,132  
MW 0,133  
MW 0,134  
MW 0,135  
MW 0,136  
MW 0,137  
MW 0,138  
MW 0,139  
MW 0,140  
MW 0,141  
MW 0,142  
MW 0,143  
MW 0,144  
MW 0,145  
MW 0,146  
MW 0,147  
MW 0,148  
MW 0,149  
MW 0,150  
MW 0,151  
MW 0,152  
MW 0,153  
MW 0,154  
MW 0,155  
MW 0,156  
MW 0,157  
MW 0,158  
MW 0,159  
MW 0,160  
MW 0,161  
MW 0,162  
MW 0,163  
MW 0,164  
MW 0,165  
MW 0,166  
MW 0,167  
MW 0,168  
MW 0,169

MW 0,170  
MW 0,171  
MW 0,172  
MW 0,173  
MW 0,174  
MW 0,175  
MW 0,176  
MW 0,177  
MW 0,178  
MW 0,179  
MW 0,180  
MW 0,181  
MW 0,182  
MW 0,183  
MW 0,184  
MW 0,185  
MW 0,186  
MW 0,187  
MW 0,188  
MW 0,189  
MW 0,190  
MW 0,191  
MW 0,192  
MW 0,193  
MW 0,194  
MW 0,195  
MW 0,196  
MW 0,197  
MW 0,198  
MW 0,199  
MW 0,200  
MW 0,201  
MW 0,202  
MW 0,203  
MW 0,204  
MW 0,205  
MW 0,206  
MW 0,207  
MW 0,208  
MW 0,209  
MW 0,210  
MW 0,211  
MW 0,212  
MW 0,213  
MW 0,214  
MW 0,215  
MW 0,216  
MW 0,217  
MW 0,218  
MW 0,219  
MW 0,220

MW 0,221  
MW 0,222  
MW 0,223  
MW 0,224  
MW 0,225  
MW 0,226  
MW 0,227  
MW 0,228  
MW 0,229  
MW 0,230  
MW 0,231  
MW 0,232  
MW 0,233  
MW 0,234  
MW 0,235  
MW 0,236  
MW 0,237  
MW 0,238  
MW 0,239  
MW 0,240  
MW 0,241  
MW 0,242  
MW 0,243  
MW 0,244  
MW 0,245  
MW 0,246  
MW 0,247  
MW 0,248  
MW 0,249  
MW 0,250  
MW 0,251  
MW 0,252  
MW 0,253  
MW 0,254  
MW 0,255  
MW 0,256  
MW 0,257  
MW 0,258  
MW 0,259  
MW 0,260  
MW 0,261  
MW 0,262  
MW 0,263  
MW 0,264  
MW 0,265  
MW 0,266  
MW 0,267  
MW 0,268  
MW 0,269  
MW 0,270  
MW 0,271

MW 0,272  
MW 0,273  
MW 0,274  
MW 0,275  
MW 0,276  
MW 0,277  
MW 0,278  
MW 0,279  
MW 0,280  
MW 0,281  
MW 0,282  
MW 0,283  
MW 0,284  
MW 0,285  
MW 0,286  
MW 0,287  
MW 0,288  
MW 0,289  
MW 0,290  
MW 0,291  
MW 0,292  
MW 0,293  
MW 0,294  
MW 0,295  
MW 0,296  
MW 0,297  
MW 0,298  
MW 0,299  
MW 0,300  
MW 0,301  
MW 0,302  
MW 0,303  
MW 0,304  
MW 0,305  
MW 0,306  
MW 0,307  
MW 0,308  
MW 0,309  
MW 0,310  
MW 0,311  
MW 0,312  
MW 0,313  
MW 0,314  
MW 0,315  
MW 0,316  
MW 0,317  
MW 0,318  
MW 0,319  
MW 0,320  
MW 0,321  
MW 0,322

MW 0,323  
MW 0,324  
MW 0,325  
MW 0,326  
MW 0,327  
MW 0,328  
MW 0,329  
MW 0,330  
MW 0,331  
MW 0,332  
MW 0,333  
MW 0,334  
MW 0,335  
MW 0,336  
MW 0,337  
MW 0,338  
MW 0,339  
MW 0,340  
MW 0,341  
MW 0,342  
MW 0,343  
MW 0,344  
MW 0,345  
MW 0,346  
MW 0,347  
MW 0,348  
MW 0,349  
MW 0,350  
MW 0,351  
MW 0,352  
MW 0,353  
MW 0,354  
MW 0,355  
MW 0,356  
MW 0,357  
MW 0,358  
MW 0,359  
MW 0,360  
MW 0,361  
MW 0,362  
MW 0,363  
MW 0,364  
MW 0,365  
MW 0,366  
MW 0,367  
MW 0,368  
MW 0,369  
MW 0,370  
MW 0,371  
MW 0,372  
MW 0,373



MW 0,374  
MW 0,375  
MW 0,376  
MW 0,377  
MW 0,378  
MW 0,379  
MW 0,380  
MW 0,381  
MW 0,382  
MW 0,383  
MW 0,384  
MW 0,385  
MW 0,386  
MW 0,387  
MW 0,388  
MW 0,389  
MW 0,390  
MW 0,391  
MW 0,392  
MW 0,393  
MW 0,394  
MW 0,395  
MW 0,396  
MW 0,397  
MW 0,398  
MW 0,399  
MW 0,L0  
MW 0,L1  
MW 0,L2  
MW 0,L3  
MW 0,L4  
MW 0,L5  
MW 0,L6  
MW 0,L7  
MW 0,L8  
MW 0,L9  
MW 0,U0  
MW 0,U1  
MW 0,U2  
MW 0,U3  
MW 0,U4  
MW 0,U5  
MW 0,U6  
MW 0,U7  
MW 0,U8  
MW 0,U9  
MW 0,I-0,00163275000,0,0,0,0,0,0,0,08,08,000,000000000,0,0  
MW 0,I-1,00162550000,0,0,0,0,0,0,0,08,08,000,000000000,0,0  
MW 0,I-2,00162400000,0,0,0,0,0,0,0,08,08,000,000000000,0,0  
MW 0,I-3,00162475000,0,0,0,0,0,0,0,08,08,000,000000000,0,0  
MW 0,I-4,00162425000,0,0,0,0,0,0,0,08,08,000,000000000,0,0

MW 0,I-5,00162450000,0,0,0,0,0,0,0,08,08,000,000000000,0,0  
MW 0,I-6,00162500000,0,0,0,0,0,0,0,08,08,000,000000000,0,0  
MW 0,I-7,00162525000,0,0,0,0,0,0,0,08,08,000,000000000,0,0  
MW 0,I-8,00161650000,0,0,0,0,0,0,0,08,08,000,000000000,0,0  
MW 0,I-9,00161775000,0,0,0,0,0,0,0,08,08,000,000000000,0,0  
MW 0,PR1  
MW 0,PR2  
MRM 0  
NAR 0,0  
NAR 1,0  
NAR 2,0  
NSFT 0  
PC 0,0  
PC 1,0  
PT 0  
PV 0,00137,00173,173  
PV 1,00216,00259,259  
PV 2,00410,00469,469  
RBN 0  
SCR 0  
SQ 0,02  
SQ 1,02  
SR 0  
SV 5  
TH 0  
TSP 0  
TXH 0  
TXS 0  
TYD KK,0F  
VMC 0,0  
VMC 1,0  
VOX 0  
VW 0,00144000000,0,0,0,0,0,0,0,08,08,000,000600000,0  
VW 1,00223000000,7,0,0,0,0,0,0,08,08,000,001600000,0  
VW 2,00440000000,8,0,0,0,0,0,0,08,08,000,005000000,0  
VW 4,00000540000,4,0,0,0,0,0,0,08,08,000,000000000,2  
VW 5,00003500000,0,0,0,0,0,0,0,08,08,000,000000000,3  
VW 6,00051000000,4,0,0,0,0,0,0,08,08,000,000000000,0  
VW 7,00087900000,B,0,0,0,0,0,0,08,08,000,000000000,1  
VW 8,00118000000,5,0,0,0,0,0,0,08,08,000,000000000,2  
VW 9,00144000000,0,0,0,0,0,0,0,08,08,000,000600000,0  
VW A,00179750000,A,0,0,0,0,0,0,08,08,000,000000000,1  
VW B,00223000000,7,0,0,0,0,0,0,08,08,000,001600000,0  
VW C,00440000000,8,0,0,0,0,0,0,08,08,000,005000000,0  
VW D,00475750000,A,0,0,0,0,0,0,08,08,000,000000000,1  
VW E,01240000000,8,0,0,0,0,0,0,08,08,000,000000000,0  
VXB 0  
VXD 1  
VXG 4



## Notes:

On the "Menu 2" tab, in the "Repeater" group box the second item "1750Hz Tone Key" corresponds to menu item 23 (Call Key).

On the "Memory" tab, if you double-click on an "A" band in the "VFO" section you will get a popup form with a number of fields. The "Program VFO" section (only on the three A bands) corresponds to Menu item 4. The "Offset" (on all bands) corresponds to Menu item 6. Therefore, these two menu items (4 & 6) actually store multiple fields. Two other menu items that also store multiple fields are item 10 (DTMF store) and item 29 (FM narrow).

These items can be configured on the radio but are not present in this program:

- 1) Menu 9 "SP/Mic"

**Notes:**