



KB2LJJ Radio Mods Database and Manuals

KENWOOD TR-2600 A

2m FM SYNTHESIZES HAND-HELD TRANSCEIVER



INSTRUCTION MANUAL

INTRODUCTION

You are the owner of our newest product, the TR-2600A Transceiver. Please read this instruction manual carefully before placing your transceiver in service.

The unit has been carefully engineered and manufactured to rigid quality standards, and should give you satisfactory and dependable operation for many years.

AFTER UNPACKING:

Save the box and packing material in the event your unit needs to be transported for remote operation, maintenance, or service.

The following explicit definitions apply in this manual:

NOTE: If disregarded, inconvenience only, no risk of equipment damage or personal injury.

CAUTION: Equipment damage may occur, but not personal injury.

CAUTION: DO NOT CONNECT AN EXTERNAL DC SUPPLY DIRECTLY TO THE CHARGE TERMINAL. Use only the supplied charger unit, optional base stand ST-2, or mobile stand MS-1. Extensive damage will occur if this is disregarded.

CAUTION: DO NOT ATTEMPT TO MODIFY OR OTHERWISE TOUCH CMOS LSI CIRCUITS. Leave all service to a qualified, experienced technician.

CONTENTS

SPECIFICATIONS	3
Section 1 PREPARATION FOR USE	4
Section 2 CONTROLS AND TERMINALS	7
Section 3 DCS	13
Section 4 KEY BOARD OPERATION	14
Section 5 OPERATION	29
Section 6 ADDITIONAL INFORMATION	30
BLOCK DIAGRAM	32
SCHEMATIC DIAGRAM (another sheet)	

SPECIFICATIONS

[GENERAL]

Frequency Range	144 — 148 MHz
Memory Channels	10 CH
Mode	FM (F3), (F2 in DCS mode)
Operating voltage	8.4 V DC \pm 25%
Power Requirement	8.4 V, 450 mA (Ni-Cd battery pack) 9 V manganese or alkaline (not Ni-Cd) 6 pcs. battery case (option)
Back-up Power Requirement	CR-2032 Lithium battery
Current Drain	Approx. 35 mA in receive mode with no input signal Less than 800 mA in HI transmit mode (at 8.4 V) Less than 400 mA in Low transmit mode (at 8.4 V) Less than 1 μ A for memory back-up
Grounding	Negative
Operating Temperature	-20 °C to +50 °C
Antenna Impedance	50 Ω
Dimensions.....	With Ni-Cd battery: 66(2.6) W \times 168(6.7)H \times 40(1.6)D mm(inch) With manganese battery: 66(2.6) W \times 176(7.0)H \times 40(1.6)D mm(inch)
Weight	With Ni-Cd battery: 520 g (1.2 lbs.) With manganese battery: 510 g (1.2 lbs.)

[TRANSMITTER]

RF Output Power	HI = 2.5 W LOW = 0.3 W approx.
Modulation	Variable reactance direct shift
Frequency Tolerance	Less than $\pm 20 \times 10^{-6}$ (-10°C ~ +50°C)

Maximum Frequency

Deviation	± 5 kHz
Spurious Radiation	Less than -60 dB

[RECEIVER]

Circuitry.....	Double conversion superheterodyne
Intermediate Frequency.....	1st IF = 10.7 MHz 2nd IF = 455 kHz
Sensitivity	Better than 1 μ V for S/N 30 dB Less than 0.25 μ V for 12 dB SINAD
Pass-Band Width	More than 12 kHz (-6 dB)
Selectivity	Less than 24 kHz (-40 dB)
Spurious Response.....	Better than 50 dB
Squelch Sensitivity.....	Less than 0.2 μ V (threshold)
Audio Output Power.....	More than 400 mW (at 10% distortion and 8 Ω load)

NOTE: Circuit and ratings may change without notice due to advances in technology.

Section 1 PREPARATION FOR USE

ACCESSORIES

Carefully unpack your TR-2600A transceiver and check that it is supplied with the following accessories:

- Accessory
- Rubber Flex Antenna
- Ni-Cd Battery Pack
- AC Charger
- Earphone
- MIC-SP Cover
- Hand Strap Ass'y

BATTERY NOTE

The supplied battery pack is not charged at the factory.
Charge the pack for about 15 hours before use.

1. OPERATING TIME

Normal operating time of TR-2600A is 110 minutes for 1 minute transmission and 3 minutes reception using Hi Power mode. The following illustration shows the voltage/power versus time characteristics.

2. BATTERY LOADING

To load the battery pack, slide the pack onto the transceiver until the catch engages ("clicks"). To change or remove the battery pack, press the release button and slide the pack off to the left.

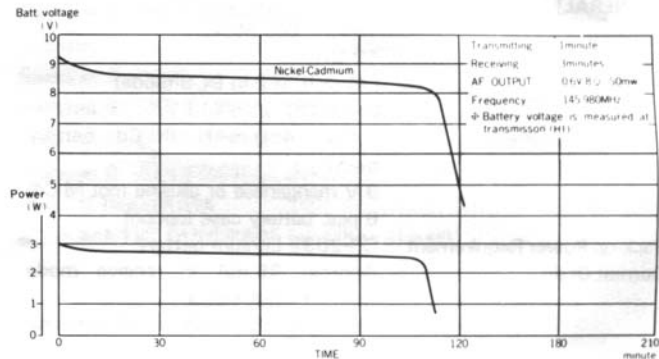

Fig. 1-1 Operating time

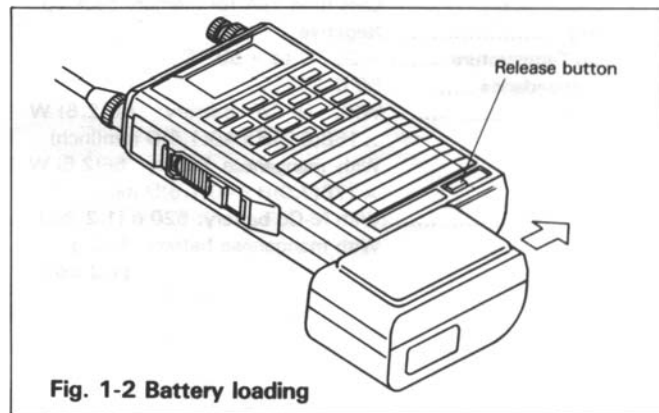

Fig. 1-2 Battery loading

3. CHARGING

When the battery indicator reaches the red zone, the battery should be charged using the supplied AC wall charger.

During charge with the supplied charger, DC power to the TR-2600A is automatically OFF, so the TR-2600A can not be operated. The battery may be charged using a MODEL MS-1 mobile stand or MODEL ST-2 base stand, available as optional accessories.

A fully charged battery will last for about 110 minutes when used at the rate of 1 minute transmission and 3 minutes reception (squelch ON, Hi Power.).

NOTE 1: The PB-26 battery pack is not charged at the factory. Charge the pack before use. If, after purchase or extended storage (more than 2 months) battery capacity is found to be low, the battery needs recharging. Repeating the charge/discharge cycle 2 or 3 times will restore the battery to its full capacity.

NOTE 2: The batteries will charge in 10 to 15 hours, depending on usage. We suggest you establish a charging schedule based on your personal operating habits. You may need to charge the pack every day, or only every other day. Experiment to determine your needs.

NOTE 3: To help you obtain long life from the battery pack, do not always keep the cells "topped", or fully charged. They will develop what is known as a "memory". When you do not exercise NiCad's through normal charge-discharge cycles, they will not perform when needed. They will drain sooner, and may not recharge

after heavy use. To insure good operation, EXERCISE the batteries.

NOTE 4: Use low power to obtain maximum operating time.

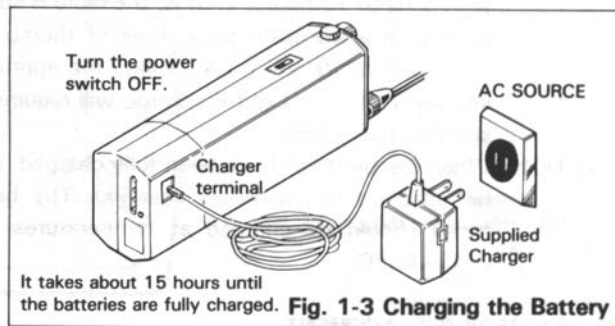

Charger Note: LED indicates charger is delivery current to the battery pack. It does not indicate full charge. Disconnect after 15 hours charging time.

CAUTION: This is a **Charge** terminal **only**. Do not direct wire this terminal to an external power supply.

NOTE: Battery Charge Time: Batteries will charge within 10 to 15 hours. That is, the radio is supplied with a 450mAh pack. Rule of thumb is charge at 1/10 the pack rating, for approximately 14 hours. Light discharge will require a shorter charge time.

CAUTION: When the batteries have been fully charged, do not attempt to continue charging. The batteries should be charged at temperatures of 0°C ~45°C.

4. BATTERY REPLACEMENT

The TR-2600A is supplied with rechargeable nickel-cadmium batteries and an AC charger, eliminating the need for battery replacement. However, if it should become necessary to replace the batteries, use another PB-26 pack, only.

5. MEMORY BACK-UP

The TR-2600A includes a lithium back-up battery to retain memory in the microprocessor. When changing batteries, or if the Ni-Cd batteries should fully discharge, memory will always be retained. Back-up battery life is estimated at about 5 years.

6. MICROPROCESSOR RESET

If the display should, for some reason, display invalid numbers, simply reset the microprocessor. Momentarily press the reset microswitch accessible through the rear case. (All memories are erased in this case.) This may indicate the lithium battery needs replacement. This should be performed by an authorized Kenwood service facility—either a Kenwood dealer, or the factory.

7. LCD displays UL

When the Nickel Cadmium batteries or the lithium battery discharge, the letters UL are displayed on the LCD to show that transmitting and receiving are inhibited. To restore operation, charge the NiCad batteries with the supplied AC charger. When the lithium battery (for microprocessor back up) wears out, have it replaced.

Section 2 CONTROLS AND TERMINALS

DCS switch

Set to ON when operating the DCS (digital code squelch) system. In normal QSO operation, set it to OFF.

C.AL/R switch

Used to restore the squelch opened by DCS (CALL indicator lights orange). When used, CALL indicator goes off.

CALL indicator

TX/BUSY indicator

Lights red when transmitting. Lights green when receiving with squelch opened by signal received. Even in receive mode with no signal, the indicator lights green when the SQL control is set at CCW position where squelch is opened.

REV Switch

This push switch is used to check the repeater input before switching to simplex operation by interchanging the receive and transmit frequencies. The REV annunciator will light on the LCD.

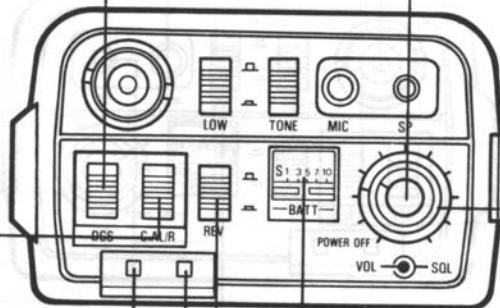

Power Switch and Volume Control

Volume control with Power ON/OFF switch. Power is turned off at the full counter-clockwise position.

SQL control

Used to silence receive noise at no signal condition. Adjust clockwise until the noise threshold is reached when no signal is present. For scan operation (memory scan, programmable scan, auto scan), alert operation, or DCS operation, this control must be set to the threshold point.

S meter

Battery indicator (in transmission). When batteries maintain standard voltage, the meter indicator points to the green zone.

Antenna Connector

Connect the supplied rubber-flex antenna with the BNC connector.

HI/LOW Switch

This switch is used to set transmit output power to either 2.5 W (high) or 300 mW (low). Power is high at the normal out position (■), and is low at the position (▬).

Tone switch

This switch does not activate tone unless the optional tone unit TU-35B is mounted. To mount the tone unit, refer to the tone unit mounting procedure.

SP Jack

To connect an earphone (EP-1), external speaker, or an SMC-30 SPEAKER/MIC.

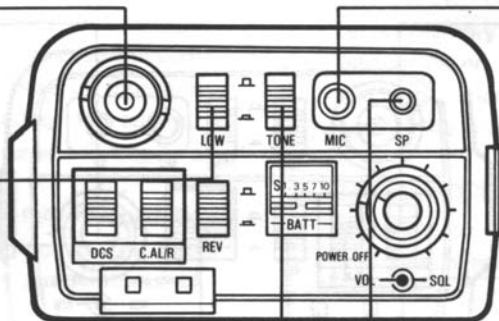

MIC Jack

NOTE: For direct connection of a condenser microphone. Input impedance is 2.2 k Ω and DC output is 4 V.

When a dynamic microphone is used, connect it through a capacitor (0.47 μ F ~ 1 μ F) to block DC voltage.

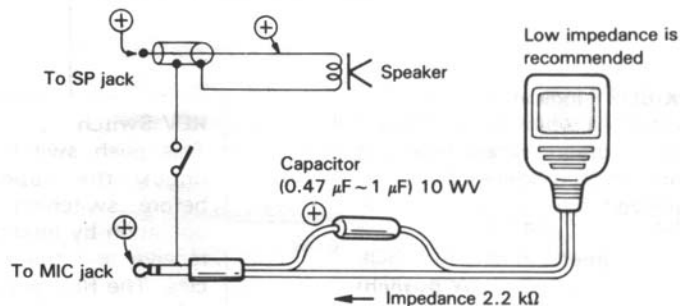

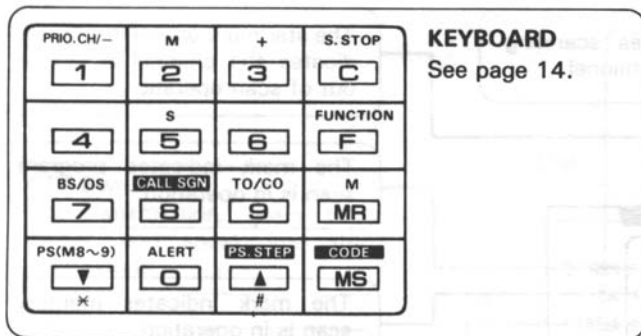

Microphone

An electret condenser mic. Maintain 4~10 cm distance to the mic.

Speaker

Miniature speaker for personal listening.

RELEASE Button

Used to release the battery case for removal. Depress this button, and slide the battery case to the left.

Battery Case

Contains seven Ni-Cd rechargeable batteries. Refer to page 4 for charging.

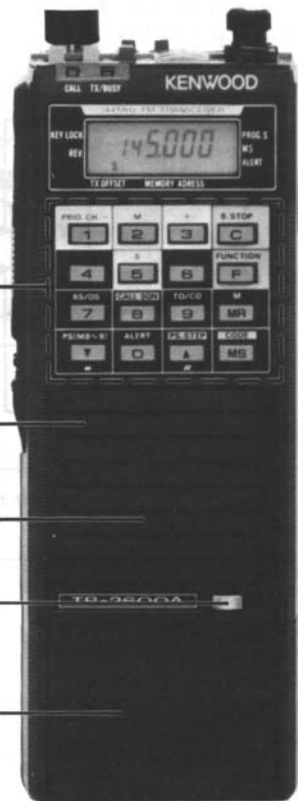

The mark indicates the KEY LOCK switch is set to ON.

The mark indicates scanning stops at an open channel.

The star mark on the display indicates the channel is locked out of scan operation.

The mark indicates program scan is in operation.

The mark indicates memory scan is in operation.

The mark indicates alert function is in operation.

Displays memory channel(s).

The mark indicates resume scan is controlled by carrier.



The mark indicates the REV switch is set to ON.

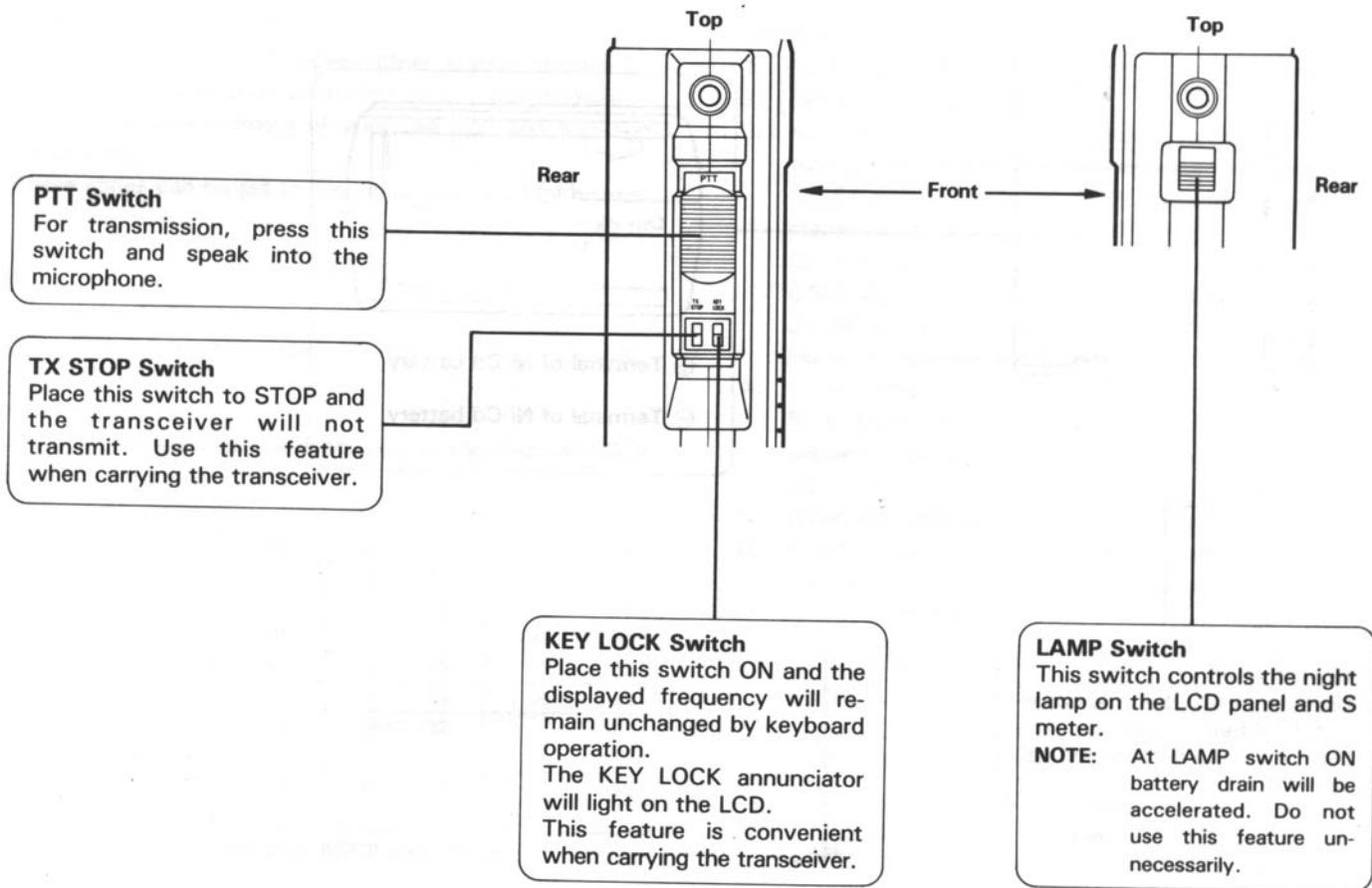

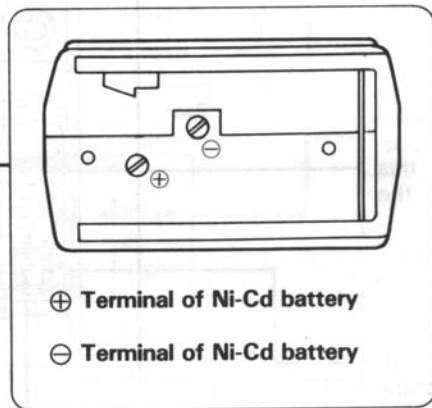
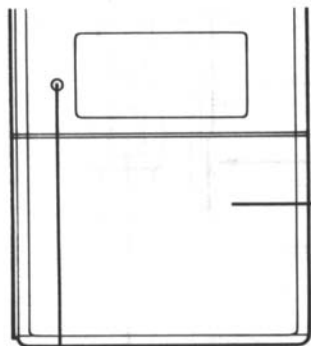

⊕ Terminal of Ni-Cd battery

⊖ Terminal of Ni-Cd battery

Reset Switch

Used to reset the microcomputer when replacing the backup lithium battery and call sign entry.

Section 3 DCS

DCS (Digital Code Squelch):

DCS is a system which opens other station squelch by transmitting digital code controlled by the microcomputer. The digital code consists of your call sign and five-digit digital code.

These codes can be set to any of your desire. In transmitting, only when the digital code corresponds to that of other station, other station squelch will open.

To operate DCS:

DCS does not function unless six digits call sign is stored.

CALL sign entry:

Write your CALL sign corresponding to the decimal ASCII code shown below.

A : 65	B : 66	C : 67	D : 68
E : 69	F : 70	G : 71	H : 72
I : 73	J : 74	K : 75	L : 76
M : 77	N : 78	O : 79	P : 80
Q : 81	R : 82	S : 83	T : 84
U : 85	V : 86	W : 87	X : 88
Y : 89	Z : 90	Space : 32	
0 : 48	1 : 49	2 : 50	3 : 51
4 : 52	5 : 53	6 : 54	7 : 55
8 : 56	9 : 57		

Fig. 3-1 Decimal ASCII code table

Example: CALL sign (JA1YKX) entry procedure

- 1) Turn power ON.
- 2) Set the DCS switch to ON.
- 3) As shown in the figure below, insert a small rod through the opening on the rear case and press the RESET switch. When the RESET switch is pressed, all memories are erased.

On the display, the (•) mark appears to allow your CALL sign entry. In the case of the above example, J : 74, A : 65, 1 : 49, Y : 89, K : 75, X : 88, referring to the decimal ASCII code table.

- 4) To store the CALL sign, press 7, 4, 6, 5, 4, 9, 8, 9, 7, 5, 8, and 8 keys in succession. When the last 8 key is pressed, a beep will sound to indicate that six digit call sign entry is complete.
- 5) When key operation fails, repeat steps 3 and 4.
- 6) A CALL sign once stored remains unchanged unless memory back-up battery is replaced or the RESET switch is pressed.

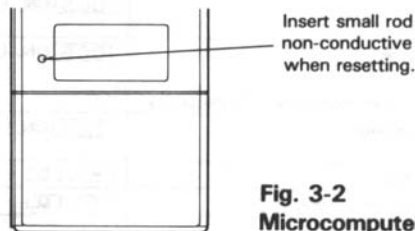

Fig. 3-2
Microcomputer Resetting

Section 4 KEY BOARD OPERATION

4.1 LIST OF KEY BOARDS

Operation	Key(s) used	Manipulation
Frequency setting	[4] ~ [7], [1] ~ [0]	Press 4 ~ 7 key, and 1 ~ 0 keys.
5 kHz step frequency shift	[▲] or [▼]	Press required key momentarily.
5 kHz setp scan initiation	[▲] or [▼]	Keep required key pressed for more than one second and remove your finger.
5 kHz step quick frequency shift	[▲] or [▼]	Keep required key pressed until the operation required.
Storing displayed frequency	[F], [MR], [1] ~ [0]	Press F and MR keys, then specify memory channel by 1 ~ 0 keys.
Memory CH recall	[MR], [1] ~ [0]	Press MR key and specify CH by 1 ~ 0 keys.
Memory CH erasure	[F], [MR], [F], [1] ~ [0]	Press F, MR and F keys and specify CH by 1 ~ 0 keys.
Locking out memory CH from scan	[MS] + [1] ~ [0]	Specify memory CH by 1 ~ 0 keys with MS key kept pressed.
Releasing locked out memory CH	[MS] + [1] ~ [0]	Specify locked out CH by 1 ~ 0 keys with MS key kept pressed.
Memory scan initiation	[MS]	Press MS key (DCS switch OFF).
Busy/Open CH scan setting	[F], [7] (Display → [C])	Press F and 7 keys. Repeat operation switches the setting alternately.
Time/Carrier scan setting	[F], [9] (Display → [C])	Press F and 9 keys. Repeat operation switches the setting alternately.
Programmable scan step frequency setting	[MR] [8] [▲] [F] [▲]	Press the MR and 8 keys to recall the frequency stored in M8 and press ▲ key to set to the first step frequency. Then press F and ▲ keys.
Programmable scan initiation	[F], [▼]	Press F and ▼ keys.
Stop scan operation	[C]	Press C key.
Storing digital code	[DCS] ON, [MS], [1] ~ [0]	Set DCS switch to ON. Press MS key and make 5-digit code by 1 ~ 0 keys.
Recalling digital code	[DCS] ON, [MS]	Set DCS switch to ON. Press MS key periodically until desired code is displayed.
Switching display from digital code to frequency	[C]	Press C key.
Recalling stored call sign	[DCS] ON, [F], [8], [▲]	Set DCS switch to ON. Press F, 8 and ▲ keys 12 times.
Setting alert function	[F], [0]	Press F and 0 keys.
Releasing alert function setting	[F], [0]	Press F and 0 keys.
TX OFFSET setting	[F] ([1], [2], [3], [5])	Press F and the desired TX OFFSET key.

4.2 FREQUENCY SETTING

PRIO. CH/- 1	M 2	+ 3	S. STOP C
4	S 5	6	FUNCTION F
BS/OS 7	CALL SGN 8	TO/CO 9	M MR
PS(MB~9) ▼ *	ALERT 0	PS. STEP ▲ #	CODE MS

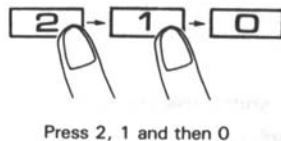

Frequencies are entered in 4 digits, so 4 Set keys should be used. For example, when entering 145.210 MHz, press keys **5**, **2**, **1** and **0** in that order.

If the key setting is found to be incorrect after pressing 4 keys, press the correct keys once again. To correct the setting before all the 4 keys are pressed, press the **C** key and then press the correct Set keys.

NOTE: If a new frequency is not completely entered, the transceiver will continue to operate on the previously retained frequency. Be certain to enter all 4 digits for a new frequency.

4.3 5 kHz STEP SHIFT

PRIO. CH/- 1	M 2	+ 3	S. STOP C
4	S 5	6	FUNCTION F
BS/OS 7	CALL SGN 8	TO/CO 9	M MR
PS(MB~9) X	ALERT 0	PS STEP #	CODE MS



UP



DOWN

• One step shift

Pressing or key once indicates 145.215 or 145.205 on the display. Pressing or key once again indicates 145.220 or 145.200 on the display. Repeating this operation shifts the displayed frequency as shown below.

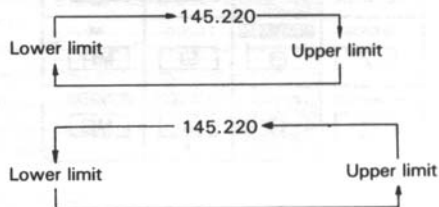

• 5 kHz step scan

Press or key for more than one second and release the finger, then scan starts as shown in figure below. When a signal is received during scan, the scan stops for 5 seconds and resumes.

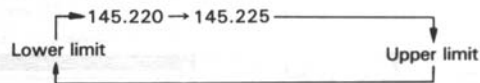

• 5 kHz step quick shift

Keeping or key pressed shifts the frequency on the display quickly, as shown below.

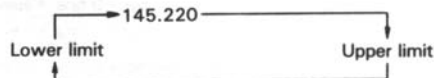

4.4 MEMORIZING FREQUENCY

PRIO.CH/- 1	M 2	+ 3	S. STOP C
4	S 5	6	FUNCTION F
BS/OS 7	CALL SGN 8	TO/CO 9	M MR
PS(M8~9) ▼ x	ALERT 0	PS. STEP ▲ #	CODE MS

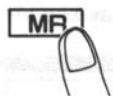
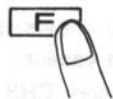

Press 1 ~ 0

Set the frequency to be memorized.



To memorize frequency into memory CH3 for example, press [F], [MR] and [3] keys in that order.



Repeating the procedure in the same manner, 10 channels can be memorized by [1] ~ [0] keys.

4.5 RECALLING MEMORIZED FREQUENCY

PRIO. CH/- 1	M 2	+ 3	S. STOP C
4	S 5	6	FUNCTION F
BS/OS 7	CALL SGN 8	TO/CO 9	M MR
PS(MB~9) ▼ X	ALERT 0	PS. STEP ▲ #	CODE MS



The above figure is the current displayed frequency. To recall memory CH3, press **[MR]** key. Then, the display indicates the following:



NOTE: The above display shows that memory channels **[4]**, **[6]** and **[9]** are vacant.

Press **[3]** key to recall memory CH3. Then, the frequency stored in CH3 is displayed as shown.



4.6 SCAN MODE SETTING

PRIO.CH/- 1	M 2	+ 3	S.STOP C
4	S 5	6	FUNCTION F
BS/OS 7	CALL SGN 8	TO/CO 9	M MR
PS(M8~9) ▼ X	ALERT O	PS.STEP ▲ #	CODE MS

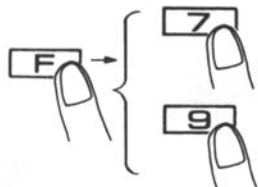

The TR-2600A has two types of scan-stop function.

- Busy-stop: Scan will stop at channel with signal.
- Open-stop: Scan will stop at channel with no signal. Also, this transceiver has two types of resume-scan function.
- Time operated resume-scan: Regardless of signal, resume-scan is operated every 5 seconds after scan-stop.

- Carrier operated resume-scan: In busy-stop scan mode, resume-scan is operated when signal is cut off. In open-stop scan mode, resume-scan is operated when signal is received.

The following is the procedure for setting the scan modes described above:

(Initial setting: Busy-stop scan with time operated resume-scan)

- 1) Pressing the **[F]** and **[7]** keys in that order sets the mark (Ⓞ) on the display. This setting is the open-stop scan.
- 2) By pressing the **[F]** and **[7]** keys in that order again, the mark (Ⓞ) disappears and the scan reverts to busy-stop.
- 3) Pressing the **[F]** and **[9]** keys in that order sets the mark (ⓐ) on the display. This setting is carrier operated resume-scan.
- 4) By pressing the **[F]** and **[9]** keys in that order again, the mark (ⓐ) on the display disappears and the scan reverts to time operated resume scan.

As described, four different scan modes can be set by combining the procedures. When scan mode is specified, auto scan, memory scan and program scan are operated automatically corresponding to the scan mode.

Example: To monitor which stations are operating, the combination of busy-stop scan and time operated resume-scan is useful.

4.7 AUTO SCAN

PRIO.CH/- 1	M 2	+ 3	S. STOP C
4	S 5	6	FUNCTION F
BS/OS 7	CALL SGN 8	TO/CO 9	M MR
PS(M8~9) ▼ *	ALERT 0	PS. STEP ▲ #	CODE MS



Up







Down



Stop

To operate auto scan, proceed as follows:

- 1) Turn the SQUELCH control clockwise to silence noise.
- 2) To shift frequency upward by auto scan, keep the  key pressed for more than one second and auto scan starts when you release your finger.
- 3) To shift frequency downward by auto scan, keep the  key pressed for more than one second and auto scan starts when you release your finger.
- 4) To stop scanning, press any one of ,  and .

4.8 MEMORY SCAN

PRIO. CH/- 1	M 2	+ 3	S. STOP C
4	S 5	6	FUNCTION F
BS/OS 7	CALL SGN 8	TO/CO 9	M MR
PS(M8~9) ▼ X	ALERT 0	PS. STEP ▲ #	CODE MS

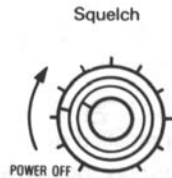

Above figure is the current display frequency.

Current memory channels are:

CH1; CH2; CH3; CH5; CH7; CH8; and CH0

Before starting operation, turn the SQL control clockwise to silence noise. At this time, the DCS switch must be set to OFF.

When the **MS** key is pressed, the memory channel displayed on the display is changed sequentially, as shown below.

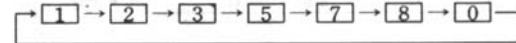

To stop scan at the required memory channel displayed, simply press the **C** key.

To resume scan, press the **MS** key again.

4.9 LOCKING-OUT MEMORY CHANNEL

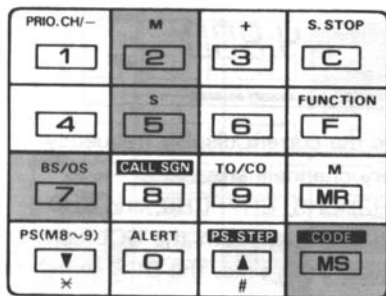

— Locking-out memory channel —

This function locks out the unnecessary memory channels from memory scan operation. This increases the memory scan speed. However, memory data in those channels locked-out are not erased.

Current memory channels are:

Channel 1, 2, 3, 5, 7, 8 and 0 as an example.

- Procedure when lock-out channels are intended. Intended channels are CH2, CH5 and CH7.

Then, keep **MS** key pressed and press **2**, **5** and **7** keys in that order.

When memory channel scan starts, scanned memory channels are the following: (see Fig. 1)

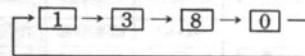

Fig. 1

This indicates memory channels 2, 5 and 7 are skipped.



Fig. 2

When a locked-out memory channel is recalled by pressing **MR** and **2** keys for example, the display indicates as shown as Fig. 2.

The (★) on the display denotes CH2 is locked-out from scan operation.

4.10 RESTORING LOCKED-OUT MEMORY CHANNEL

PRIO.CH/- 1	M 2	+ 3	S. STOP C
4	S 5	6	FUNCTION F
BS/OS 7	CALL SGN 8	TO/CO 9	M MR
PS(MB~9) ▼ X	ALERT 0	PS. STEP ▲ #	CODE MS

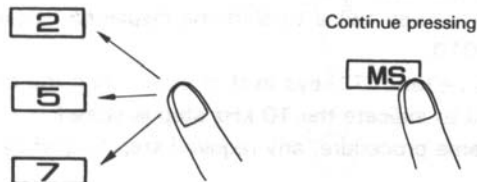

— Condition before the operation —

Current memory channels are:

CH1; CH2; CH3; CH5; CH7; CH8 and CH0.

Current locked-out memory channels are:

CH2; CH5 and CH7.

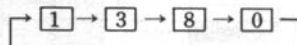

• Procedure:

To restore CH2, CH5 and CH7, keep **MS** key pressed and press **2**, **5** and **7** keys in that order or in any order. Then, channels **2**, **5** and **7** are scanned when scan is operated.

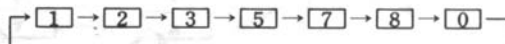

4.11 PROGRAMMABLE SCAN:

PRIO. CH/- 1	M 2	+ 3	S. STOP C
4	S 5	6	FUNCTION F
BS/OS 7	CALL SGN 8	TO/CO 9	M MR
PS(M8~9) X ▼	ALERT 0	PS. STEP # ▲	CODE MS

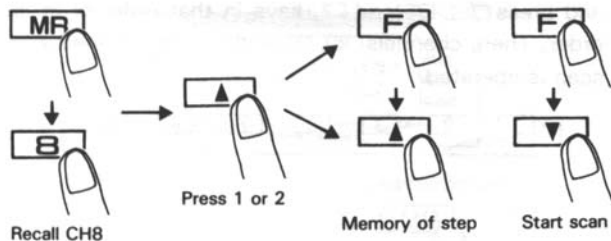

Programmable scan

Programmable scan is an operation for searching a busy or an open channel within set frequency range. The frequency range is programmable between memory CH8 and CH9.

Scan range setting:

Example: Scan within the range 145 MHz – 145.8 MHz. Store 145.0 MHz in CH8 and 145.8 MHz in CH9 by

following the procedure "Frequency entry". Store lower frequency in CH8 and upper frequency in CH9.

Step frequency setting:

• 5 kHz Step:

- 1) Press **MR** and **8** keys in that order to recall memory CH8. The display shows 145.000.
- 2) Press **▲** key once to shift the displayed frequency to 145.050.
- 3) Press **F** and **▲** keys in that order, then the beep will sound to indicate the 5 kHz step is stored.

• 10 kHz Step:

- 1) Press **MR** and **8** keys in that order to recall memory CH8. The display shows 145.000.
- 2) Press **▲** key twice to shift the displayed frequency to 145.010.
- 3) Press **F** and **▲** keys in that order, then the beep will sound to indicate the 10 kHz step is stored.

In the same procedure, any required step frequency can be set.

• Program scan initiation

Pressing the **F** and **▼** keys in that order, when the programmable scan setting is completed, starts program scan.

NOTE: If the step frequency is not stored, program scan will not start.

4.12 ALERT MODE SETTING

PRIO. CH/ - 1	M 2	+ 3	S. STOP C
4	S 5	6	FUNCTION F
BS/OS 7	CALL SGN 8	TO/CO 9	M MR
PS(M8~9) ▼ X	ALERT O	PS. STEP ▲ #	CODE MS



Alert mode

Scan mode

• Alert mode setting procedure

Pressing the **F** and **O** keys in that order sets the (▶) mark as shown on the display.



With alert mode in operation, the channel stored in memory CH1 (PRIO. CH) is monitored.

In busy-stop scan, when CH1 is busy, the beep will sound. The beep sounds once every 6 seconds.

However, when CH1 is a clear channel, the beep will not sound.

• Clearing alert mode

Pressing the **F** and **O** keys in that order eliminated the mark (▶) from the display. This shows alert mode is cleared.

• Pressing the **F** and **7** keys in that order places the mark (⊗) on the display. This setting is open-stop scan. Therefore, when CH1 is a clear channel, the beep will sound.

4.13 MEMORY CHANNEL ERASURE

PRIO. CH/- 1	M 2	+ 3	S. STOP C
4	S 5	6	FUNCTION F
BS/OS 7	CALL SGN 8	TO/CO 9	M MR
PS(M8~9) ▼ x	ALERT 0	PS STEP ▲ #	CODE MS

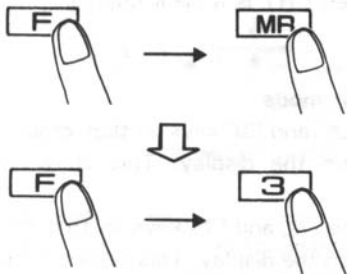

The above figure is the current displayed frequency. Press **[F]** and **[MR]** keys in that order. Then, the display shows the following:



Next, pressing **[F]** and **[3]** keys in that order displays the stored frequency and its memory CH3. This denotes that the data in CH3 is erased.



4.14 DIGITAL CODE MEMORY

PRIO. CH/- 1	M 2	+ 3	S. STOP C
4	S 5	6	FUNCTION F
BS/OS 7	CALL/SGN 8	TO/CO 9	M MR
PS(M8~9) x	ALERT 0	PS/STEP #	CODE MS

[DCS] Press

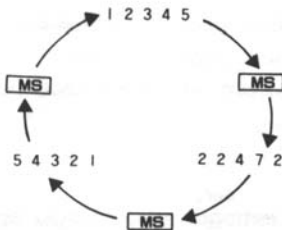

Initial digital code memory procedure:

- 1) Set the DCS switch to ON.
- 2) Press the [MS] key and the display shows the following.



- 3) To store digital code 12345 (example), press the [1], [2], [3], [4] and [5] keys in that order.
- 4) Repeating steps 2) and 3) allows storing of three different digital codes.
- 5) When storing new digital code, repeat steps 1) through 3).

• Digital code selection

- 1) Set the DCS switch to ON.
 - 2) Press the [MS] key as many times as necessary until the required digital code is displayed on the display.
- To switch the display from digital code to frequency, press the key [C].

4.15 CALL SIGN RECALL (for confirmation)

PRIO.CH/-- 1	M 2	+ 3	S.STOP C
4	S 5	6	FUNCTION F
BS/OS 7	CALL SGN 8	TO/CO 9	M MR
PS(M8~9) ▼ x	ALERT 0	PS/STEP ▲ #	CODE MS

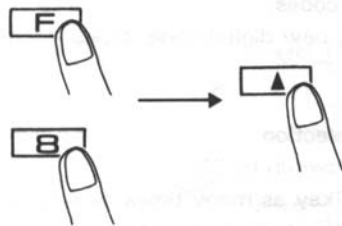

To confirm the stored call sign, proceed as follows:

- 1) Set the DCS switch to ON.
- 2) Press the **F** and **8** keys in that order. The dot mark (•) appears on the display.
- 3) Press the key **▲** twice and the first ASCII code is recalled.
- 4) Repeat step 3) and the following ASCII code is recalled.

- 5) Repeat step 3) until the last digit of call sign ASCII code is displayed. When the last digit call sign is displayed, the display reverts to the frequency.

NOTE: While call sign is displayed, reception and transmission are inhibited.

Example: JA1YKX

Operation	Display
DCS ON	(1)
F 8	(2) •
▲ First	(3) 1.7
▲ Second	(4) 1.74
▲ Third	(5) 2.5
▲ Eleventh	(13) 5.8
▲ Twelfth	(14) 5.88

↓
Beep
↓
Frequency

Section 5 OPERATION

RECEPTION

1. Turn the power switch ON.
2. Turn the squelch control knob to the threshold point.
3. Adjust the MDI control knob to the desired audio output level.
4. Select the desired channel or frequency by using the dot keys (C/D-000), C/D and D/D keys, or by entering a frequency (refer to 'Section 4: KEY BOARD OPERATION').

TRANSMISSION

1. Select the desired channel or frequency.
2. Set the TX OFF/ON operation to the desired setting.
3. Select either Low Power (500mW) or High Power (2.5 W).
4. Press the PTT switch and speak into the microphone. The ON AIR indicator will light. For optimum results, recommended distance to the microphone is 150mm (2-4 inch).

DCS operation

Align the 5-digit digital code (number) and set the DCS switch to ON.

With this operation, squelch noise or reception sound cannot be generated, regardless of the squelch control, until the signal which has the same digital code is received.

To open the squelch of the mate station, press the PTT

switch and transmit. When the transmission is ended, the digital code is transmitted. When the mate station receives the code, the beep signal sounds, the CALL indicator lights, the squelch opens and the squelch noise can be heard. With this system, once the squelch opens, the CALL indicator remains lit.

In this way, it is possible to know that the station is called.

To close the opened squelch, press the C/AL/R switch. The CALL indicator goes off and the unit returns to stand-by mode.

When the CALL indicator is kept lit and the operator knows that the station is called, the operator starts communication. When the digital code of the mate station is received, the beep signal sounds, the CALL indicator lights and the squelch opens.

When both squelch noises opened, set the DCS switch OFF, and continue to talk.

TOUCH TONE KEYS

With the PTT switch held pressed, pressing one of the dot keys generates tone corresponding to the key and hold transmit mode for about 2 seconds. Therefore, press the following desired key within 2 seconds and touch tone operation is activated even with the PTT switch release. The tone can be monitored through the built-in speaker.

Section 6 ADDITIONAL INFORMATION

TX OFFSET SETTING

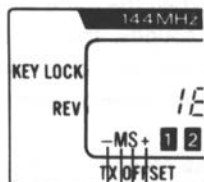

This setting can be set by pressing keys **[F]** and **[3]**. When transmitting with this setting, transmit frequency is set 600 kHz higher than the receive frequency.

This setting can be set by pressing keys **[F]** and **[5]**. With this setting, receive and transmit frequencies are the same.

This setting can be set by pressing key **[F]** and **[2]**. When transmitting with this setting, the frequency stored in CHO is recalled as transmit frequency. This function allows any repeater frequency split operation.

This setting can be set by pressing keys **[F]** and **[1]**. When transmitting with this setting, transmit frequency is set 600 kHz lower than the receive frequency.

GENERAL INFORMATION

Your TR-2600A has been factory aligned and tested to specifications before shipment. Under normal circumstances, the transceiver will operate in accordance with these operating instructions. If your transceiver fails to work, contact the Authorized KENWOOD Dealer from whom you purchased it for quick, reliable repair. All adjustable trimmers and coils in your transceiver were preset at the factory and should only be readjusted by a qualified technician with proper test equipment. Attempting service or alignment without factory authorization can void the transceiver's warranty.

ORDERING SPARE PARTS

When ordering replacement or spare parts for your equipment, be sure to specify the following:

- Model and serial number of your transceiver, schematic number of the part, printed-circuit-board number on which the part is located, part number and name, if known, and quantity desired.

NOTE: A full Service Manual is available as a separate publication.

SERVICE

Should it ever become necessary to return the equipment for repair, pack in its original box and packing, and include.

1. Model and Serial number of the equipment.
2. A full, detailed description of the problems involved.
3. When claiming warranty service, please include a photocopy of the bill of sale, or other proof of purchase showing the date of sale.

You need not return accessory items unless they are directly related to the service problem.

TONE UNIT MOUNTING PROCEDURE

• Installation Procedures

1. Cover removal

Remove the back cover from the transceiver by removing the five screws indicated as shown. (Fig. 6-1)

2. Tone unit installation

Affix the spacer to the back side (the soldered side) of the tone unit, fasten the tone unit inside the transceiver using the two screws provided (see Fig. 6-2). Be careful not to pinch any wires between the the tone unit and the transceiver. Next, carefully install the connector to its mate inside the transceiver.

3. Name-plate replacement

Peel the transceiver name-plate off the back cover and affix the name-plate in the same position. (For the TU-35A only, insert the rubber cap provided into the hole in the name-plate.)

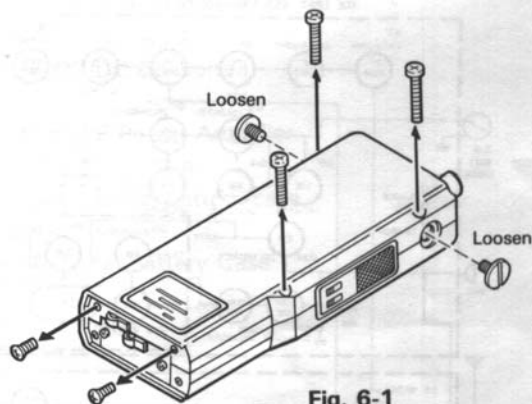

Fig. 6-1

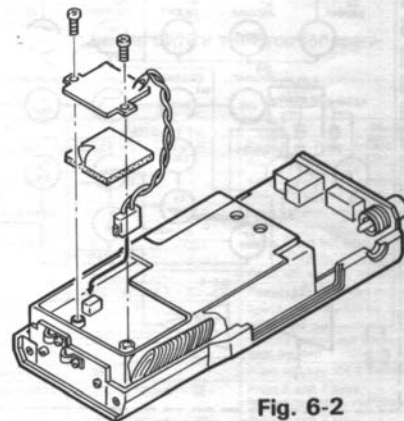
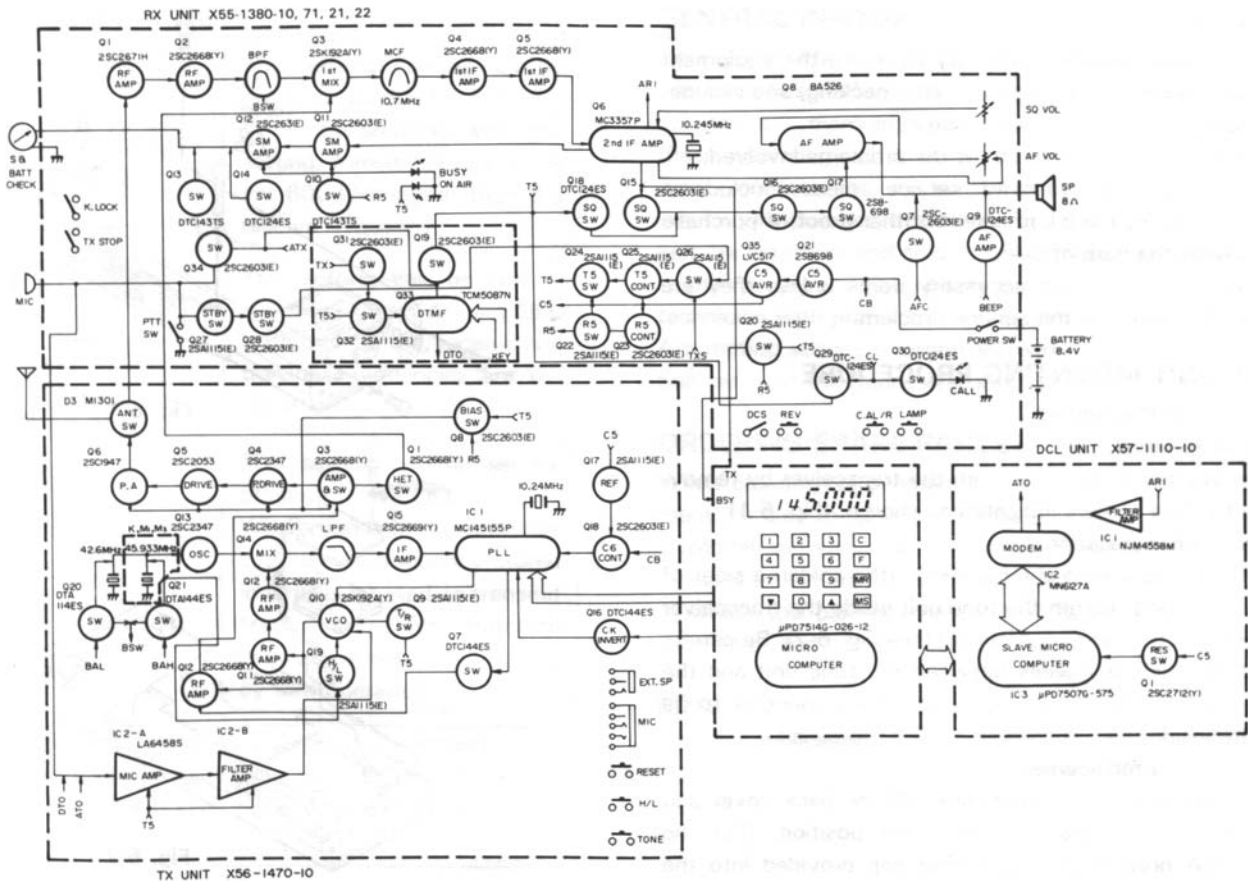

Fig. 6-2

BLOCK DIAGRAM



OPTIONAL ACCESSORIES

1. ST-2 Base Stand

- Built-in quick charger about 1.5 hours with full charge indicator.
- Full operation while charging.
Separate Battery Trickle charge and power feed for extended base operation.
- Drop-in connections.

2. MS-1 Mobile Stand

- Cigar Plug for instant connection.
- Full operation while charging (trickle charge only)
Separate power feed for extended operation.
Built-in illumination for front keyboard.
- Drop-in connections.

3. PB-26 Ni-Cd Battery Pack

4. SMC-30 Speaker Microphone

5. HMC-1 Headsets with mic

6. SC-9 Soft Case with Belt Hook

7. TU-35B Repeater Tone Unit

8. CD-10 Call sign display

9. DC-26 DC-DC Converter

10. VB-2530 RF Power Amplifier

11. BT-3 Manganese battery case

12. EB-3 External Battery Case

13. HS-8 Earphone

If desired, cut off this part and carry it with you for operation aid.

Operation	Key(s) used	Manipulation
Frequency setting	[4] - [7], [1] - [0]	Press 4 - 7 key, and 1 - 0 keys.
5 kHz step frequency shift	[4] or [7]	Press required key momentarily.
5 kHz setp scan initiation	[4] or [7]	Keep required key pressed for more than one second and remove your finger.
5 kHz step quick frequency shift	[4] or [7]	Keep required key pressed until the operation required.
Storing displayed frequency	[F], [MR], [1] - [0]	Press F and MR keys, then specify memory channel by 1 - 0 keys.
Memory CH recall	[MR], [1] - [0]	Press MR key and specify CH by 1 - 0 keys.
Memory CH erasure	[F], [MR], [F], [1] - [0]	Press F, MR and F keys and specify CH by 1 - 0 keys.
Locking out memory CH from scan	[MR] + [1] - [0]	Specify memory CH by 1 - 0 keys with MS key kept pressed.
Releasing locked out memory CH	[MR] + [1] - [0]	Specify locked out CH by 1 - 0 keys with MS key kept pressed.
Memory scan initiation	[MR]	Press MS key (DCS switch OFF).
Busy/Open CH scan setting	[F], [7] (Display - [8])	Press F and 7 keys. Repeat operation switches the setting alternately.
Time/Carrier scan setting	[F], [9] (Display - [8])	Press F and 9 keys. Repeat operation switches the setting alternately.





ST-2



PB-26



SMC-30



HMC-1 Headset with mic



TU-35B



MS-1



DC-26



VB-2530



EB-3

Operation	Key(s) used	Manipulation
Programmable scan step frequency setting	[MR] [0] [0] [0] [0] [0]	Press the MR and 8 keys to recall the frequency stored in MR and press ▲ key to set to the first step frequency. Then press F and ▲ keys.
Programmable scan initiation	[F], [0]	Press F and ▼ keys.
Stop scan operation	[C]	Press C key.
Storing digital code	[DCS] ON, [MR], [0] - [0]	Set DCS switch to ON. Press MS key and make 5-digit code by 1 - 0 keys.
Recalling digital code	[DCS] ON, [MR]	Set DCS switch to ON. Press MS key periodically until desired code is displayed.
Switching display from digital code to frequency	[C]	Press C key.
Recalling stored call sign	[DCS] ON, [F], [0], [0]	Set DCS switch to ON. Press F, 8 and ▲ keys 12 times.
Setting alert function	[F], [0]	Press F and 0 keys.
Releasing alert function setting	[F], [0]	Press F and 0 keys.
TX OFFSET setting	[F] ([0], [0], [0], [0], [0])	Press F and the desired TX OFFSET key.

MEMO

Free Manual from KB2LJJ.COM

KENWOOD CORPORATION

Shionogi Shibuya Building, 17-5, 2-chome Shibuya, Shibuya-ku, Tokyo 150, Japan

TRIO-KENWOOD COMMUNICATIONS

Post Office Box 7065, Compton, California 90224, U.S.A.

KENWOOD COMMUNICATIONS

DIVISION OF KENWOOD ELECTRONICS DEUTSCHLAND GMBH

Rembrücker Str. 15, 6056 Heusenstamm, West Germany

KENWOOD ELECTRONICS BENELUX N.V.

Leuvensesteenweg 504, B-1930 Zaventem, Belgium

TRIO-KENWOOD (AUSTRALIA) PTY. LTD. (INCORPORATED IN N.S.W.)

4E. Woodcock Place, Lane Cove, N.S.W. 2066, Australia