



SERVICE MANUAL

Model TS-660

VOX-4, SP-120, PS-20, MB-100

ALL MODE QUAD BANDER



CONTENTS

SPECIFICATIONS	2	DISPLAY UNIT (X54-1630-00)	18
CIRCUIT DESCRIPTION	2	PARTS LIST	19
OUTSIDE VIEWS	8	DISASSEMBLY	27
PC BOARDS/CIRCUIT DIAGRAMS		LEVEL DIAGRAM	29
SWITCH UNIT (X41-1340-00)	9	ADJUSTMENTS	30
BAND SWITCH UNIT (X41-1350-00)	9,15	BLOCK DIAGRAM	42
ENCODER UNIT (X54-1640-00)	9,15	VOX-4	43
RF UNIT (X44-1440-00)	10	TERMINAL FUNCTIONS	47
FM UNIT (X48-1340-00)	11	PACKING	49
IF UNIT (X48-1330-00)	12,13	SCHEMATIC DIAGRAM	50
CONTROL UNIT (X53-1220-00)	14,15	PS-20	51
PLL UNIT (X50-1740-00)	16	SP-120	BACK COVER
FILTER UNIT (X51-1260-00)	17	MB-100	BACK COVER
FINAL UNIT (X56-1410-00)	17		

TS-660

SPECIFICATIONS/CIRCUIT DESCRIPTION

[GENERAL]

Frequency Range:	15 meter band 21.0000 ~ 21.4500 MHz * 12 meter band 24.5000 ~ 24.9999 MHz (Receive only) 10 meter band 28.0000 ~ 29.7000 MHz 6 meter band 50.0000 ~ 53.9000 MHz
Mode:	FM (F3), SSB (A3j), CW (A1), AM (A3)
Frequency Stability: (At room temperature)	Within ± 200 Hz during the first hour after 1 minute of warmup Within ± 30 Hz during any 30 minutes after warmup
Antenna Impedance:	50 Ω
Power Requirements:	12 ~ 16 VDC (13.8 VDC nominal) Transmit (max.) 4 A (SWR: Less than 1.5) Receive 1 A
Semiconductor Complement:	ICs 35 FETs 22 Transistors 156 Diodes 217 Display tube 1
Dimensions (projections excluded):	241 (9-1/2") W \times 94 (3-11/16") H \times 236 (9-5/16") D mm
Weight:	4.9 kg (10.8 lbs)

[TRANSMITTER SECTION]

RF Output Power:	SSB, CW, FM 10 W AM 4 W
Carrier Suppression:	Better than 40 dB
Sideband Suppression:	Better than 50 dB
Spurious Radiation:	21 ~ 28 MHz band Better than 40 dB 50 MHz band Better than 60 dB
Maximum Frequency Deviation (FM):	± 5 kHz
Microphone Impedance:	500 Ω ~ 50 k Ω
Audio Frequency Response:	400 ~ 2600 Hz (-6 dB)

[RECEIVER SECTION]

Sensitivity:	SSB, CW 0.25 μ V for 10 dB S/N AM 1 μ V for 10 dB S/N FM 1 μ V for 30 dB S/N 0.4 μ V for 12 dB SINAD
Image Ratio:	Better than 60 dB
IF Rejection:	Better than 70 dB
Selectivity:	SSB, CW, AM 2.4 kHz (-6 dB), 4.2 kHz (-60 dB) FM 15 kHz (-6 dB), 32 kHz (-60 dB)
	Optional Filter
	AM filter YK-88A 6 kHz (-6 dB), 11 kHz (-60 dB) CW filter YK-88C 500 Hz (-6 dB), 1.5 kHz (-60 dB) YK-88CN 270 Hz (-6 dB), 1.1 kHz (-60 dB)
Squelch Sensitivity (FM):	0.32 μ V (at threshold)
Audio Output:	1.5 W
Audio Output Impedance:	8 ~ 16 Ω

Note: Circuit and ratings may change without notice due to developments in technology.

* Will transmit on the new 12 meter band. A lead wired for preventing accidental transmission before government amateur authorization.

RECEIVER CIRCUIT

There are two antenna terminals on the TS-660 : one for 50 MHz ANT 1 and one for 21-28 MHz ANT2. The 50 MHz antenna terminal can be switched to operate the full 21-50 MHz range by means of a rear-panel changeover switch S2. When ANT 1 is used for All-BAND operation, ANT 2 is automatically grounded.

The receiver system is single conversion with an IF of 8.830kHz. The FM is dual conversion with a 2nd IF of 455 kHz.

At the RF stage, the 50 MHz and 21-28 MHz inputs are independent, but become common from the mixer stage. The 50 MHz antenna signal enters through the transmission LPF (Filter unit, L7-9) and then to the VHF antenna coils. For HF bands (21-28 MHz), the signal enters the RF unit HF antenna coils directly. Changeover between these transmission and reception antenna paths is accomplished by diode switches. However, relays are used for band changeover. Input signals are stepped up by the RF unit antenna coils ; VHF L3, 4 and HF antenna coils (L9-11) and RF amplified by VHF Q1 : 3SK73, or HF Q5 : 3SK73.

CIRCUIT DESCRIPTION

Either VHF or HF signal then enters the common mixer (Q3, 4 : 3SK74). A 50 MHz signal enters through matching transformer (T12) and helical resonator (L6). Each H.F. BAND has its own BPF (Band Pass Filter) : (21 MHz L17-19, 24.5 MHz L20-22, 28 MHz L23-25).

In this double balanced mixer, the input signal is mixed with the PLL (phase locked loop) VCO (voltage controlled oscillator) output to derive an 8.83 MHz IF (intermediate frequency) signal. Transformers T2, T3, ceramic filter CF-1 (with a bandwidth of about 50 kHz), and T4 couple this IF signal from the mixer output to the first IF amplifier FET (Q7 : 3SK73).

T5 couples this signal into the noise blanker gate (D22- 25) and T6 couples the gate output to the RIF (RX IF), which runs to the IF unit input. The signal to the FM unit is applied from T6 via buffer amplifier (Q7 : 2SC1815). The noise blanker signal is obtained at the output of the 1st IF amplifier (Q7) through FET buffer amplifier (Q10 : 2SK19). This noise signal is amplified by Q11-13 : 2SC460 and detected by D28, 29. Finally the switching driver Q8 : 2SC1815 drives the NB gate to eliminate or reduce pulse-type (ignition) noises.

The signal entering the IF unit from the RF unit is first filtered by the MCF (Monolithic crystal Filter) and then amplified by two IF amplifier stages (Q10, 11 : 3SK73). SSB and CW signals are product detected by D25-28 : 1N60 and fed to the audio preamplifier (Q22 : 2SC2240) via SSB, CW and AM squelch switch transistor (Q43 : 2SC2240).

The AM mode is derived from the output of Q11 through buffer amplifier (Q15 : 2SC1815) and detected by diode (D49 : 1N60). This is amplified by Q25 : 2SC1815 and fed to the squelch switch transistor Q43. SSB and CW or AM mode selection is performed by diode switches (D40, 41). In all cases excluding FM, a squelch signal is taken from the AGC line and amplified by Q39 : 2SC1815 and Q40 : 2SK40. Q41 : 2SA1015 is adjusted by the squelch control. This biases Q42 : 2SC1815 OFF at no signal, and ON when signal is present, to bias Q43 : 2SC2240 on when signal is present.

In the FM mode, the RF unit FMI output is delivered to the FM unit, where the signal is input to Q5 : MC3357, a monolithic IC containing the second conversion oscillator, mixer, limiting amplifier, quadrature discriminator, active filter, squelch, scan control, and mute. Q4 : 2SC2240 buffers the detected output and returns this audio signal (via the FAF line) to the IF unit, D42 switch.

FM signal meter drive (FSM) is derived through amplifiers Q6,7 : 2SC1815 (Y), transformer T3, and rectifiers D5, 6 : 1N60.

Audio signals for each mode are preamplified by Q22, volume controlled, then power amplified by the audio output IC (Q23 : HA1366W).

Item	Rating
Center frequency (fo)	8831.5 kHz ± 250 Hz
-6 dB bandwidth	6 kHz
Attenuation bandwidth	11 kHz
Guaranteed attenuation	80 dB or more
Ripple	2 dB or less
Loss	3 dB ± 2 dB
Input and output impedance	600Ω // 15pF
Temperature	-10°C ~ +50°C

**Table 1 AM Crystal filter YK-88A
(L71-0223-05) Option**

Item	Rating
Center frequency fo	8830.7kHz
Center frequency deviation	fo ± 150Hz at 6dB
6dB bandwidth	± 250Hz or more
60dB bandwidth	± 900Hz or less
Ripple	2dB or less
Loss	6dB ± 2dB
Guaranteed attenuation	80dB or more within fo ± 2kHz to ± 1MHz
Input and output impedance	600Ω/15pF

**Table 2 CW Crystal filter YK-88C
(L71-0211-05) Option**

Item	Rating
Center frequency fo	8830.7kHz
Center frequency deviation	fo ± 50Hz at 6dB
6dB bandwidth	± 125Hz or more
60dB bandwidth	± 600Hz or less
Ripple	2dB or less
Loss	8dB ± 2dB
Guaranteed attenuation	80dB or more within fo ± 2kHz to ± 1MHz
Input and output impedance	600Ω/15pF

**Table 3 CW Crystal filter YK-88CN
(L71-0221-05) Option**

Item	Rating
Nominal center frequency (fo)	455 kHz
3 dB bandwidth	± 5 kHz or more
6 dB bandwidth	± 7.5 kHz or more
60 dB bandwidth	± 16 kHz or less
Guaranteed attenuation	Within 455 ± 100 kHz 45 dB or more Within 0.1 ~ 1.0 MHz 30 dB or more
Ripple	(Within 455 ± 5 kHz) 3 dB or less
Loss	5 dB or less
Input and output impedance	1.5 kΩ

Table 4 Ceramic filter CFT455F2

CIRCUIT DESCRIPTION

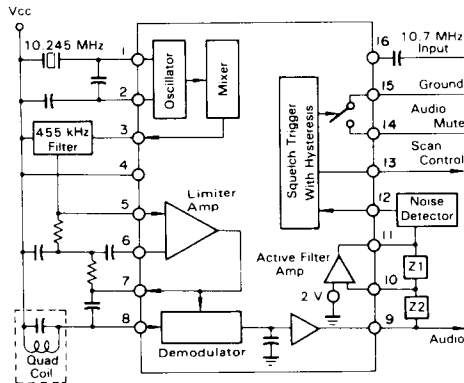

Fig. 1 MC3357P Block diagram

TRANSMITTER CIRCUIT

As in the receiver system, the transmitter is single conversion in the SSB, CW and AM modes and dual conversion in the FM mode.

In SSB and AM modes, the MIC audio signal is amplified in the switch unit by Q1 : 2SC2240, Q2, 3 : 2SC1815, and applied to the balanced modulator (D29-32 : 1N60) on the IF unit, where an 8.83 MHz DSB signal is generated. In SSB mode, this is buffer-amplified by Q17 : 2SK19, and passed through the 8.83 MHz MCF (Monolithic Crystal Filter) exiting as an SSB signal SSB mode. In the AM mode Q17's output is switched through either R91 82Ω or YK-88A AM filter (option) when installed. SSB, CW and AM mode signals are then amplified by the transmitter IF amplifier (Q18 : 3SK73) and are output via the TIF line from the IF to the RF unit.

In the FM mode, the audio signal from the Switch unit microphone amplifier (Q1 : 2SC2240) goes to the FM unit via the FMC line. In the FM-1 unit, the MIC signal is amplified and limited by Q1 : TA7061AP, an OP AMP, and is applied to varicap diode D1 : 1S2208 to modulate crystal X1.

The 8831.5 kHz carrier output generated by oscillator Q2 : 2SC460 and amplified Q3 : 3SK74 is fed via the FMT line to the RF unit (connector 6) and into the transmitter balanced mixers (Q15, 16 : 3SK74).

SSB, CW and AM or FM signal selection is performed by diode switching (D29, 30).

The various mode signals are mixed with the VCO output for each band by the transmitter balanced mixers (Q15, 16) and this output is routed to one of two paths ; one for 50 MHz and the other for 21-28 MHz. Signal path selection is performed by diodes D31, 32. The 50 MHz signal is filtered by helical coils L37 and then amplified by transmitter amplifier Q17 : 3SK73.

This is then further filter by helical coils L38 and amplified

This 50 MHz signal is relay selected (RL1) and is fed to the DRV (DRIVE) terminal and then to the Final unit. 21-28 MHz signals are first Band Pass Filtered, then amplified by wide-band amplifiers Q21 : 2SC1815 and Q22 : 2SC2086. These 50 MHz or 21-28 MHz signals are fed to the Final unit via relay RL1.

The signals input to the Final unit are amplified by a wide band push-pull driver amplifiers (Q1, 2 : 2SC1971), and then amplified by wide band push-pull final amplifiers (Q3, 4 : 2SC1972) to the 10W output level. This RF output is Low Pass Filtered for each band in the Filter unit. ALC detection is provided by Q1, and protection is provided by Q2 (both 2SC1815) before the LPF section.

Item	Condition	Symbol	Rating			Unit
			TYP	MIN	MAX	
Output voltage	$V_i = 15V$ $I_o = 350mA$	V_o	9.00	8.65	9.35	V
MAX output current	$V_i = 15V$	I_o MAX	750	-	-	mA

Table 5 NJM78M09A (V30-1107-16)
Electrical Characteristic

	VCBO	VEBO	VCEO	IC	PC	Tj	Tstg	Ta
Condition			R = $\infty\Omega$		Tc = 25°C			25 $\pm 3^\circ C$
MAX rating	35V	4V	17V	2A	12.5W	+150°C	-55~ +150°C	

Table 6 2SC1971 (V03-1971-16) Max Rating

	VCBO	VEBO	VCEO	IC	PC	Tj	Tstg	Ta
Condition			R = $\infty\Omega$		Tc = 25°C			25 $\pm 3^\circ C$
MAX rating	35V	4V	17V	3.5A	25W	+175°C	-55~ +175°C	

Table 7 2SC1972 (V03-1972-16) Max Rating

PLL CIRCUIT

The TS-660 uses a system of three Phase-Locked Loops to obtain the final VCO (voltage controlled oscillator) output frequency. A 16 MHz master oscillator is employed, from which all other standard fixed frequencies are derived. Frequency control is achieved by a 10 Hz step digital VFO feeding an 8 bit microcomputer (μ PD8048C), which controls the divide ratio of each PLL circuit.

Fig. 2 shows the PLL circuit block diagram. VCO 1 consists of a PLL circuit operating between 6-4 MHz in 2 kHz steps, using a 2 kHz reference frequency and a divide ratio of $1/N1=1/3000-1/2001$. The divider used is a TC9122P. The divide ratio is set as a 13 bit BCD signal. Next, this 6-4 MHz signal is divided by 1/200 to become a 30-20kHz signal in 10 Hz steps. It is then mixed with the 8 MHz standard frequency by MIX 1 and this becomes a 7.97-7.98 MHz output signal, with a bandwidth of 10 kHz

CIRCUIT DESCRIPTION

This signal enters the VCO 2 PLL circuit through MIX2. **Table 8** shows the frequency relationships within the first PLL.

VCO 2 operates between 6–7 MHz in 10 kHz steps using a 10 kHz reference frequency and a divide ratio 1/N2 of 1/197–1/98. The divider used is an MC14569B and the divide ratio is set as an 8 bit binary input, as shown in **Table 9**.

As previously mentioned, VCO 2 is controlled in 10 kHz steps. While VCO 1 operates in 10 Hz steps. The mix of the VCO 1 signal 7.97–7.98 MHz in 10 Hz steps by MIX 2 yields a VCO 2 operating range of 6–7 MHz in 10 Hz steps by the sum of 1/N1 and 1/N2 divide ratios.

This signal is then mixed with the CAR frequency, filtered, and fed into MIX 4. Here, one of two standard frequencies are mixed. For the 21 and 24 MHz bands, 4 MHz is injected. For the 28 and 50 MHz bands, 32 MHz is injected. Therefore, the output for the 21 and 24 MHz bands becomes 18.83–19.83 MHz and for the 28 and 50 MHz bands 46.83–47.83 MHz. This signal is fed into the final PLL circuit through MIX 5.

PLL-3 actually contains three VCO's. The 21 and 24 MHz bands share VCO 3-1 with a 1 MHz coverage.

The 28 MHz band VCO 3-2 covers a 2 MHz range. The 50 MHz band VCO 3-3 covers a 4 MHz range.

This PLL employs an MC4044P phase comparator and a 1 MHz reference frequency, along with a conventional SN74LS163AN TTL-type divider. **Table 10** shows the frequency relationships within the Final Loop circuit.

The RIT (Receiver Incremental Tuning) function uses an 8 MHz VXO (Variable X-TAL Oscillator) circuit which is switched in place of the 8 MHz standard input signal to MIX 1. During CW transmission, the 800 Hz carrier shift is performed by this VXO.

IF shift is easily accomplished, since the carrier frequency is mixed in the PLL circuit.

When the CAR frequency is VXOed, both the IF input (to the MCF), and Product Detector CAR input shift, moving the IF input signal across the MCF Pass Band width. In the TS-660, there are two carrier crystal oscillator circuits. In CW, SSB, and AM TX, CAR 1 operates at 8.8315 MHz. In the FM and AM RX modes, the carrier frequency into PLL MIX 3 is lowered 100 kHz by CAR 2 : 8.7315 MHz. Simultaneously, the divide ratio 1/N2 is changed to raise the VCO 2 frequency 100 kHz. So the final VCO output remains the same.

Displayed frequency	VCO2	1/N2	1/N2(binary)	
			MSB	LSB
50.000.0	6.000	1/197	1 1 0 0 0 1 0 1	
50.010.0	6.010	1/196	1 1 0 0 0 1 0 0	
⋮	⋮	⋮	⋮	
50.500.0	6.500	1/147	1 0 0 1 0 0 1 1	
⋮	⋮	⋮	⋮	
50.980.0	6.980	1/99	0 1 1 0 0 0 1 1	
50.990.0	6.990	1/98	0 1 1 0 0 0 1 0	

Table 9

Display	VCO1(MHz)	1/N1	f3(kHz)	f4(MHz)
0.0 0	6.000	1/3000	30.000	7.970000
0.0 1	5.998	1/2999	29.990	7.970010
⋮	⋮	⋮	⋮	⋮
5.0 0	5.000	1/2500	25.000	7.975000
⋮	⋮	⋮	⋮	⋮
9.9 8	4.004	1/2020	20.020	7.979980
9.9 9	4.002	1/2001	20.010	7.979990

Not displayed

Table 8

BAND	f1(MHz)	VCO3(MHz)	f2	1/N3	Divide ratio				
					D	C	B	A	
21	18.83~19.83	29.83~30.83	11	1/11	0	1	0	1	
24	"	32.83~33.83	14	1/14	0	0	1	0	
28	46.83~47.83	36.83~37.83	10	1/10	0	1	1	0	
39	"	37.83~38.83	9	1/9	0	1	1	1	
50	"	58.83~59.83	12	1/12	0	1	0	0	
51	"	59.83~60.83	13	1/13	0	0	1	1	
52	"	60.83~61.83	14	1/14	0	0	1	0	
53	"	61.83~62.83	15	1/15	0	0	0	1	

Table 10

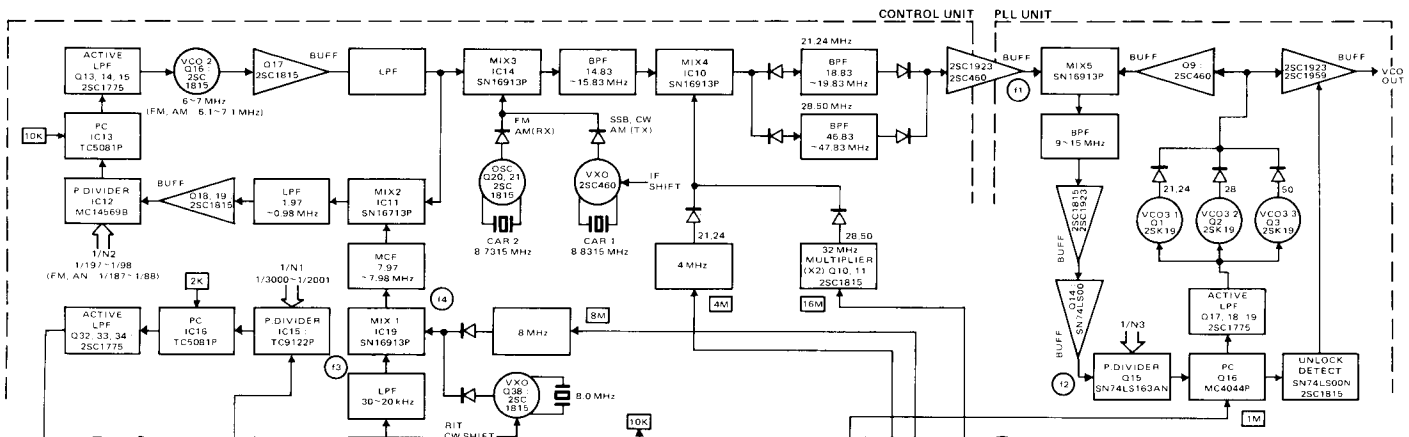

CIRCUIT DESCRIPTION

CONTROL CIRCUIT

● Rotary encoder input circuit

In the encoder unit a 250-slit rotary tuning disk and two photo-interrupters generate two clock signals with a 90° phase difference. This is fed to the Control unit via the EN1, 2 lines. These are waveform shaped by Schmitt trigger gate IC23 (TC4049BP), then multiplied by four through IC21, 22 (TC4011BP) so that a signal of 250 pulses/rotation becomes 1,000 pulses/rotation.

This is input to the microcomputer INT terminal (Pin 6) via one-half of flip-flop IC20-2 (TC4011BP).

The encoder's direction of rotation is identified by phase difference of its two output signals. flip-flop IC20-1 delivers this to microcomputer input T1 (Pin 39). Timing and waveforms are shown in **Fig. 3**.

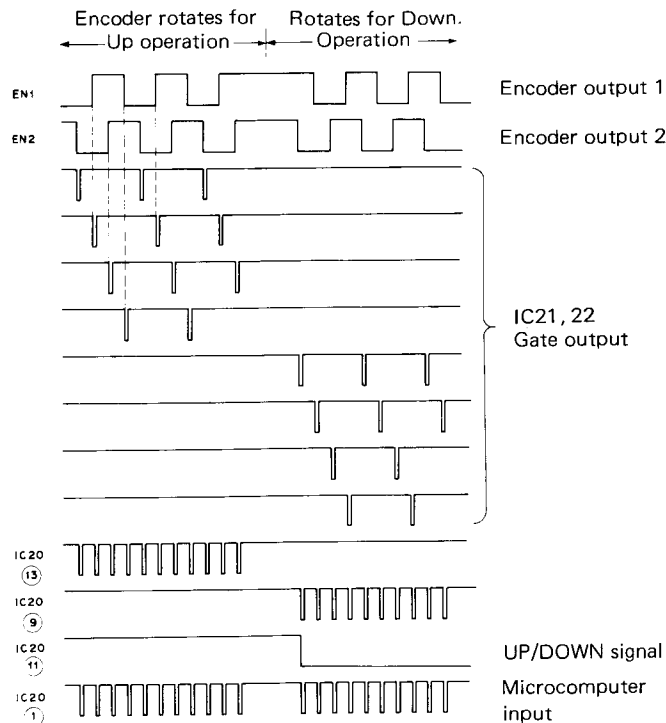

Fig. 3 Encoder output to micro-processor input timing and waveforms

● MIC Frequency shift circuit

The TS-660 permits frequency shift control by microphone-mounted switches. To generate the frequency shift control clock, the TS-660 incorporates a dedicated clock oscillator. The oscillator consists of an astable multivibrator combining two NAND gates (IC24-1 : TC4011BP). Frequency shift is controlled by the interval in which the switch is held down, and is switchable between step-by-step and continuous shifting. Shift speed is determined by CR time constant C149 (0.022 μ F) and R158 (150k Ω) to be approximately 100 Hz to achieve a shift speed of about 1 kHz/sec.

The 1-step shift function involves direct input to the microcomputer to terminal via IC2 (SN74LS151N) and is separate from the Timing circuit.

The interval from the step-by-step to continuous shift is determined by R160 (82k Ω) and C151 (10 μ F).

● Buzzer circuit

In the TS-660, a tone is generated to confirm BAND change, UP/DOWN frequency operation or MEMORY STORE by means of a driver circuit and a ceramic oscillator. When any of these operations occur, a pulse of several μ sec. is output from IC1 terminal P73 (Pin 16). This pulse is multiplied by 10 by a one-shot multiplier circuit IC24-2 (TC4011BP) and RC R6 (83k Ω) and C1 (1 μ F), and a tone is generated by switching on the power supply to the ceramic transducer.

● Switch input circuits

All front-panel switch signals (FUNCTION, MEMORY, CH, M, S HOLD, BAND, etc.) are fed to the control unit and then compiled by diode matrix D7-10, 13-17, 19-22. This information is fed to the microcomputer via two data selector ICs.

IC2 (SN74LS151N) is a 1 bit x 8 ch data selector handling MODE, MIC, BAND UP/DOWN and S HOLD signals. IC3 (TC4019BP) is a 4 bit x 2 ch data selector handling FUNCTION, MEMORY and CH data input.

● Microcomputer power supply circuit

The microcomputer 5V power supply (IC5 : μ PD8048C) has two 5V input terminals : a VCC terminal (No. 40) for microcomputer operation and developed on the Control unit, and a VDD terminal (No. 26) for internal RAM back-up fed from the external main power source. Therefore, the VDD 5V is applied only during back-up to hold the memory.

CIRCUIT DESCRIPTION

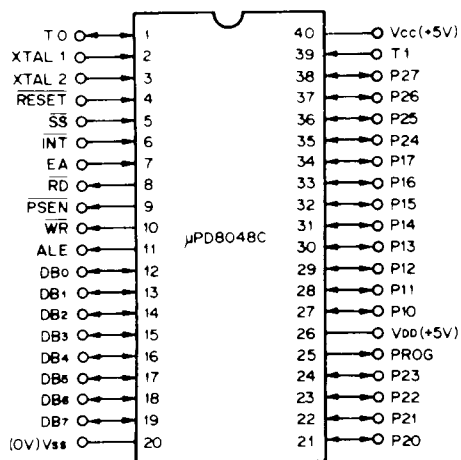

Fig. 4 μPD8048C-292 Terminal name

Item	Symbol	Rating
Operating voltage	V _{cc}	-0.5 ~ +7.0V
	V _{DD}	-0.5 ~ +7.0V
Input voltage	V _i	-0.5 ~ +7.0V
Output voltage	V _o	-0.5 ~ +7.0V
Operating temperature	T _{opt}	0 ~ +70 °C
Storage temperature	T _{stg}	-65 ~ +150 °C

Table 11 μPD8048C-292 Max Rating

Terminal No.	Symbol	Explanation	Terminal No.	Symbol	Explanation
1	T0	DATA SELECTOR input	21	P20	I/O EXPANDER control output
2	X0	Microcomputer CLOCK(5 MHz) input	22	P21	
3	X1	Microcomputer reset input Normally H	23	P22	
4	RST		24	P23	
5	SS	Normally 5V	25	PRG	RAM BACK UP 5V power supply
6	INT	Encoder CLOCK input	26	VDD	
7	EA	Normally GND	27	P10	VCO 2 dividing ratio output (binary)
8		Unused, normally open	28	P11	
9			29	P12	
10			30	P13	
11		VCO 1 dividing ratio output (BCD)	31	P14	
12	B0		32	P15	
13	B1		33	P16	
14	B2		34	P17	
15	B3		35	P24	I/O EXPANDER SELECT H : EX(0) L : EX(1)
16	B4		36	P25	
17	B5		37	P26	DATA SELECTOR control
18	B6	38	P27	Encoder CLOCK latch clear output	
19	B7	39	T1	Encoder UP/DOWN input H : UP, L : DOWN	
20	GND	GND	40	Vcc	Microcomputer 5V power supply

Table 12 μPD8048C-292 Terminal function

Terminal No.	Symbol	Explanation
2	P40	VCO 1 dividing ratio output (BCD)
3	P41	
4	P42	
5	P43	
1	P50	VCO 3 dividing ratio output
23	P51	
22	P52	
21	P53	
20	P60	50 MHz BAND data
19	P61	28 MHz BAND data
18	P62	24 MHz BAND data
17	P63	21 MHz BAND data
13	P70	DATA SELECTOR input
14	P71	
15	P72	
16	P73	

Terminal No.	Symbol	Explanation	
2	P40	Lit by L	
3	P41		Display SEGMENT output a
4	P42		Display SEGMENT output b
5	P43		Display SEGMENT output c
1	P50		Display SEGMENT output d
23	P51		Display SEGMENT output e
22	P52		Display SEGMENT output f
21	P53	Display SEGMENT output g	
20	P60	Display DIGIT output 100 Hz digit	L column lit
19	P61	Display DIGIT output 1k	
18	P62	Display DIGIT output 10k	
17	P63	Display DIGIT output 100k	
13	P70	Display DIGIT output 1M	
14	P71	Display DIGIT output 10M	
15	P72	Display DIGIT output CH display	
16	P73	Buzzer sound output	

Table 14 I/O EXPANDER (1) IC1 : μPD8213C

TS-660

OUTSIDE VIEWS

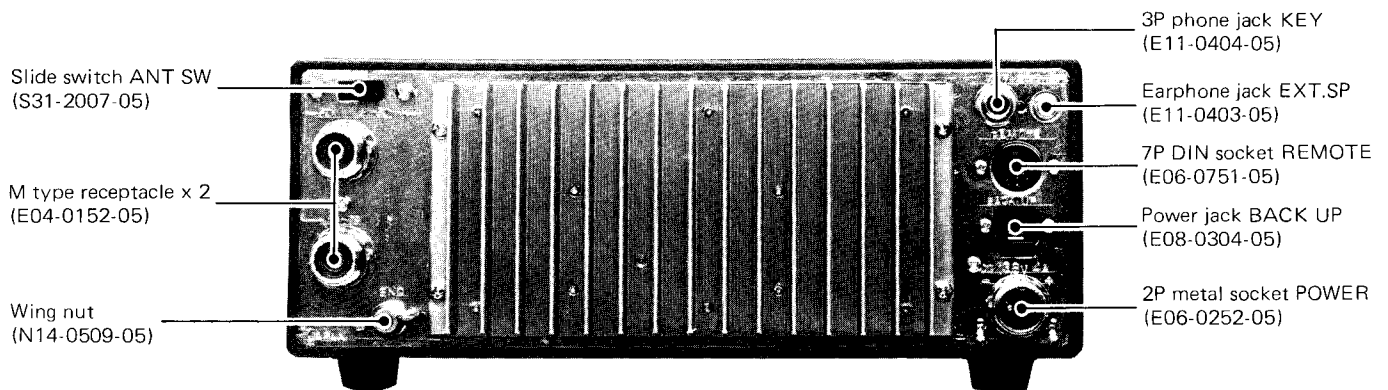
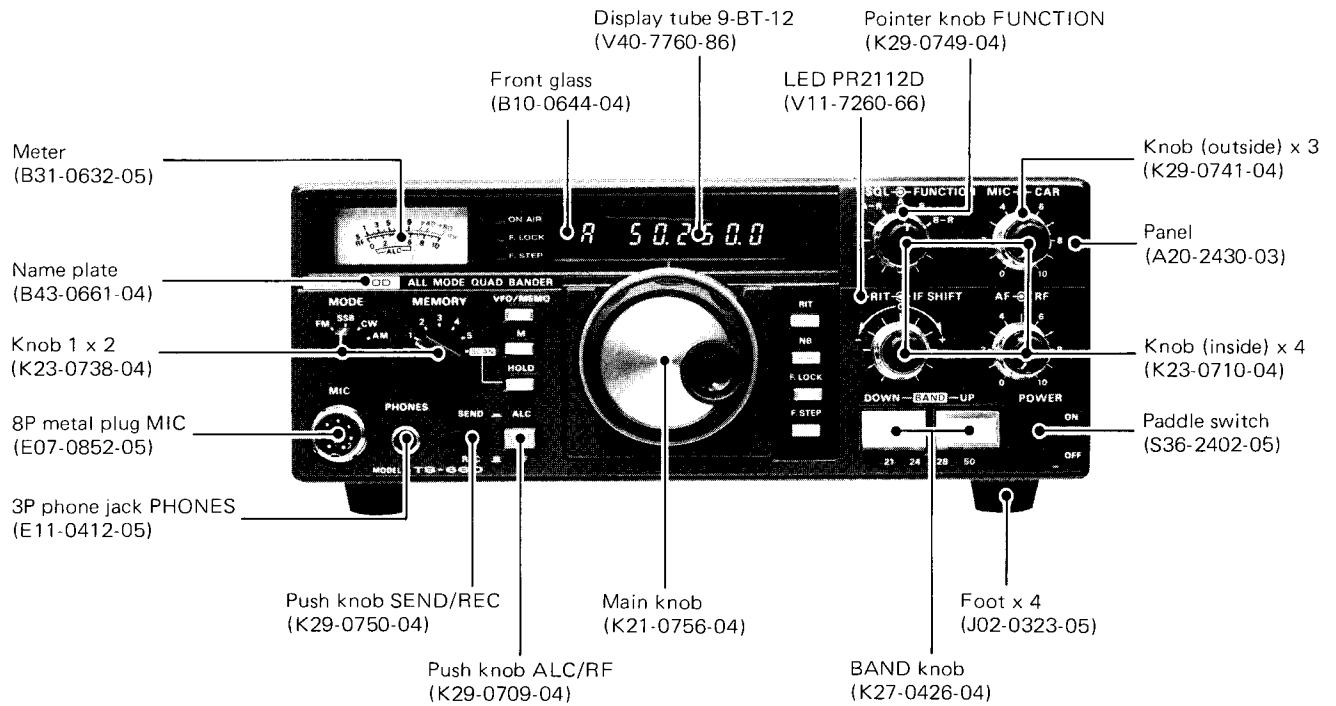

PC BOARD VIEWS TS-660

▼ SWITCH UNIT (X41-1340-00) Components side view

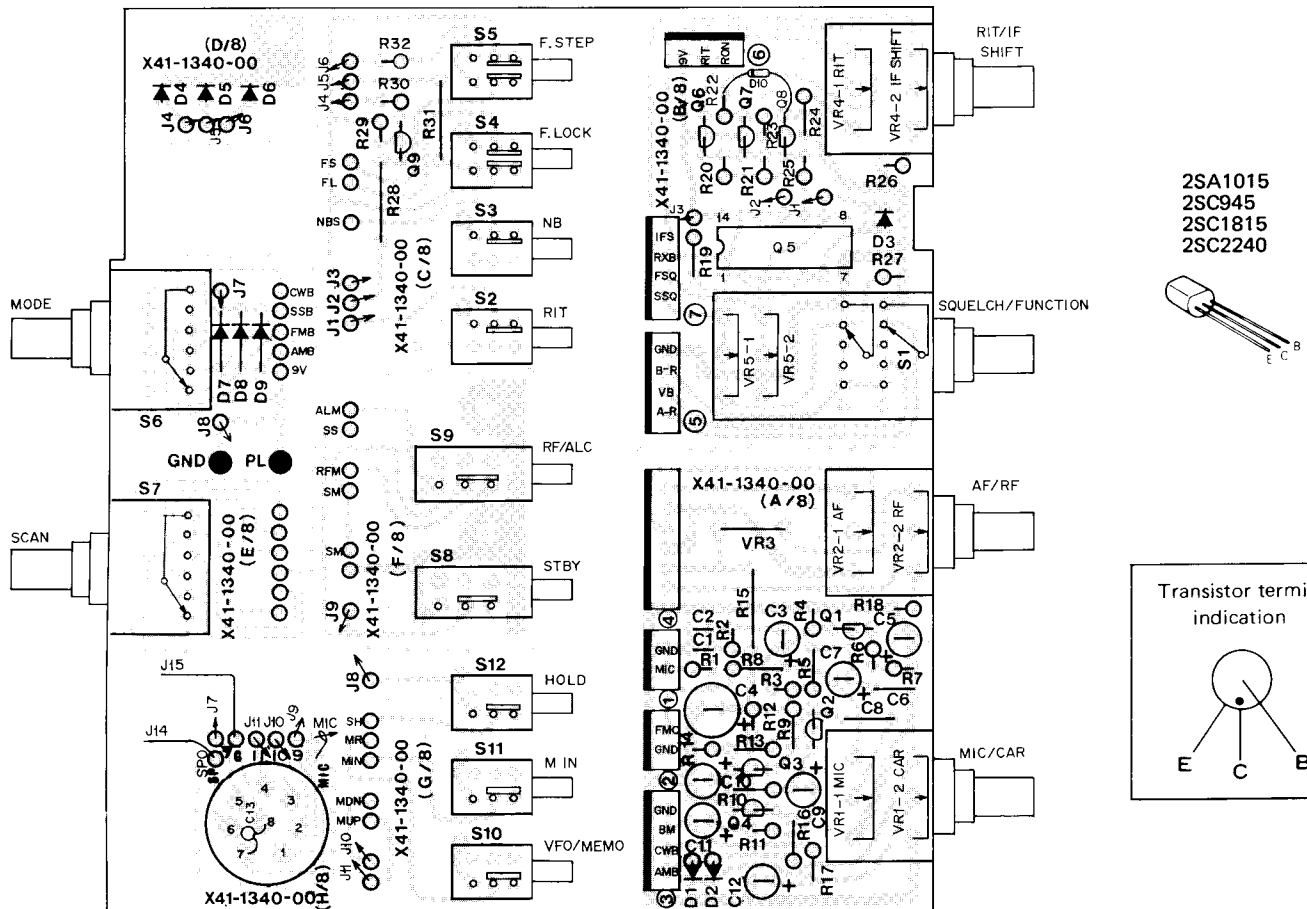

Q1 : 2SC2240(GR) Q2~4 : 2SC1815(Y) Q5 : TC4011BP Q6~9 : 2SC945(R)
D1, 2, 7~9 : 1S1555 D3 : PR2112D D4 : SR538D D5 : SG238D D6 : SY438D D10 : WZ-071

▼ ENCODER UNIT (X54-1640-00) Components side view

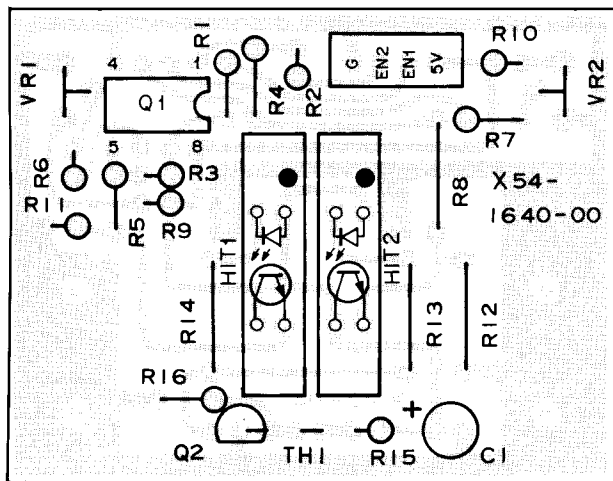

Q1 : LM358P Q2 : 2SA1015(Y) HIT1, 2 : ON1105

ON1105

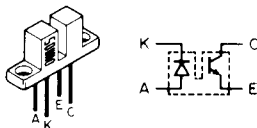

MAX. Rating

VR	IF	PD	IC	V _{CEO}	V _{ECO}	PC	Top.

▼ BAND SWITCH UNIT (X41-1350-00) Components side view

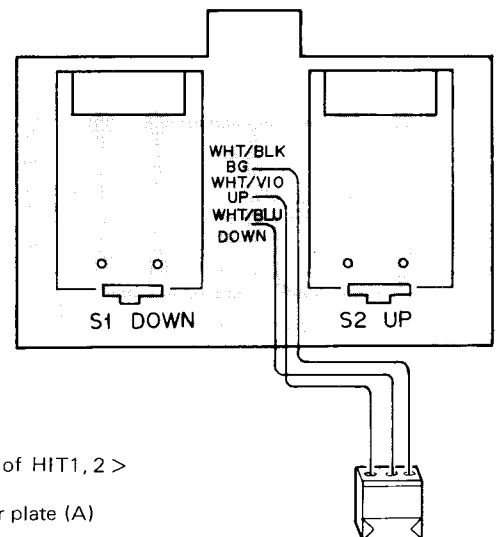

< Attachment method of HIT1, 2 >

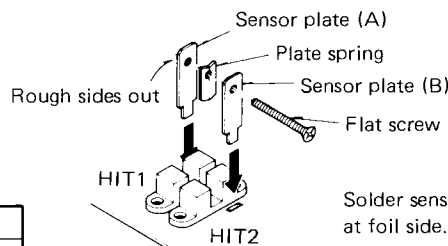

TS-660 PC BOARD VIEW

▼ RF UNIT (X44-1440-00)

Components side view

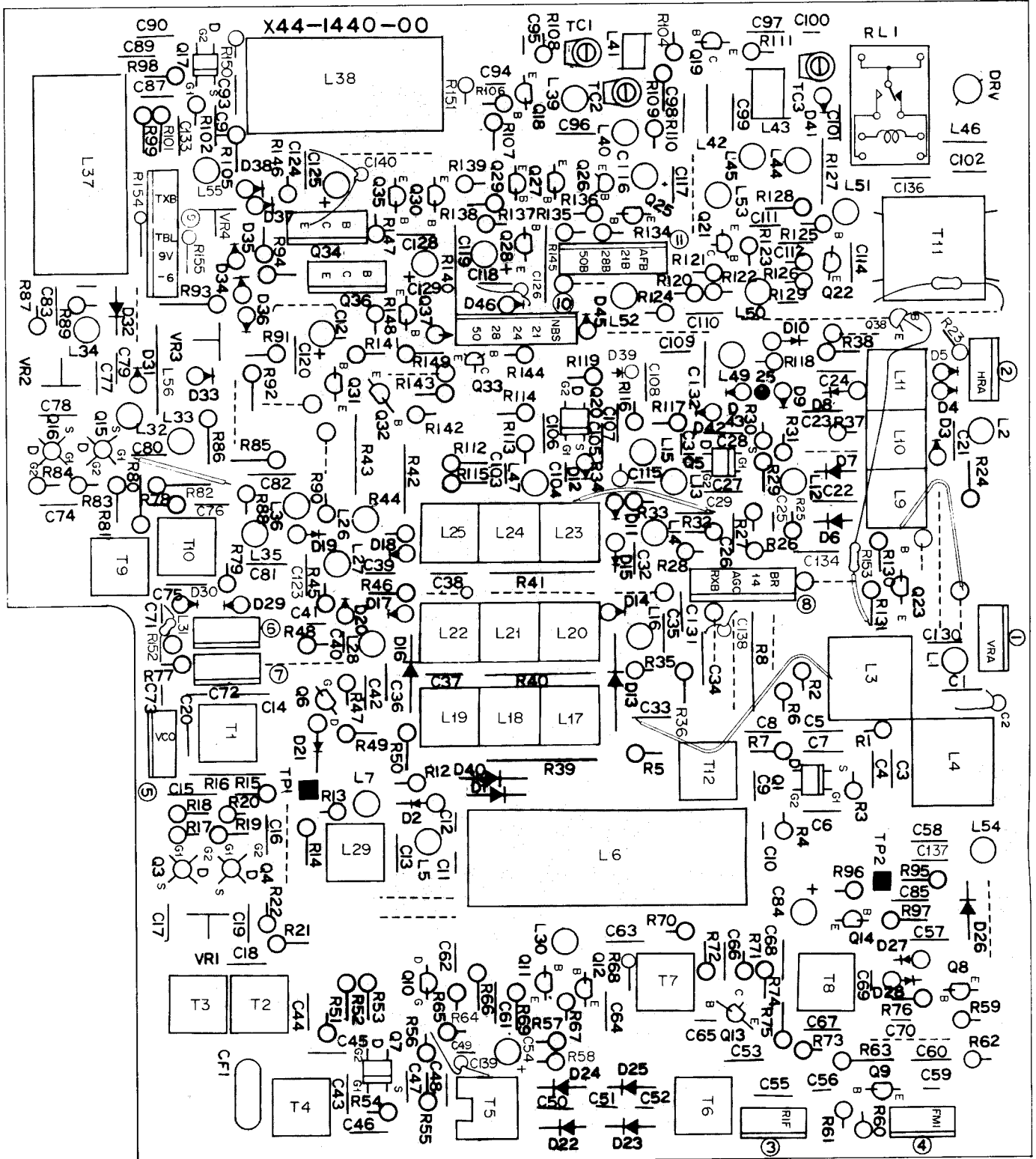

Q1, 5, 7, 17, 20 : 3SK73(GR) Q3, 4, 15, 16 : 3SK74(L) Q6 : 2SK61(GR) Q8, 9, 14, 21, 26, 27, 29, 30, 32, 33, 35, 37, 38 : 2SC1815(Y)
 Q10 : 2SK19(Y) Q11~13 : 2SC460(B) Q18, 19, 22 : 2SC2086 Q23 : 2SA562(Y) Q25, 28, 31 : 2SC1959(Y) Q34, 36 : 2SD880(Y)
 D1, 5, 9, 10, 29, 30~36, 40~46 : 1S1555 D2~4, 21 : 1S2586 D6~8, 11~20, 22~25 : 1S1587 D26 : MV13 D27, 28 : 1N60

PC BOARD VIEW/CIRCUIT DIAGRAM TS-660

▼ FM UNIT (X48-1340-00) Components side view

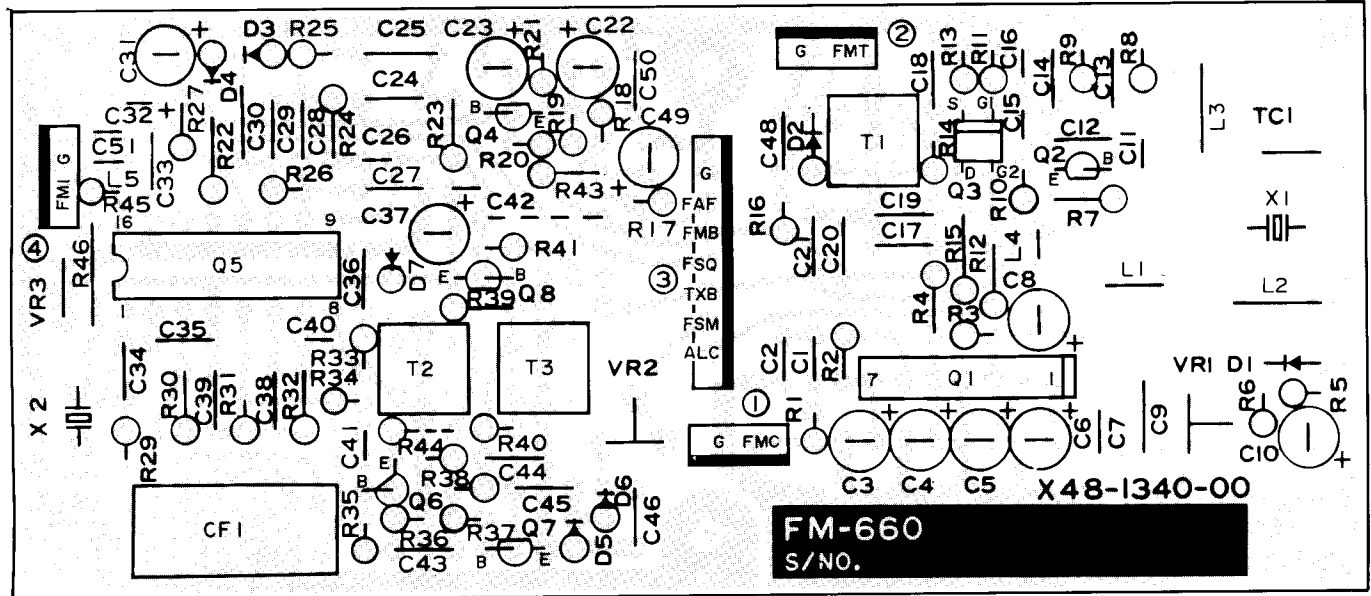

FM UNIT (X48-1340-00)

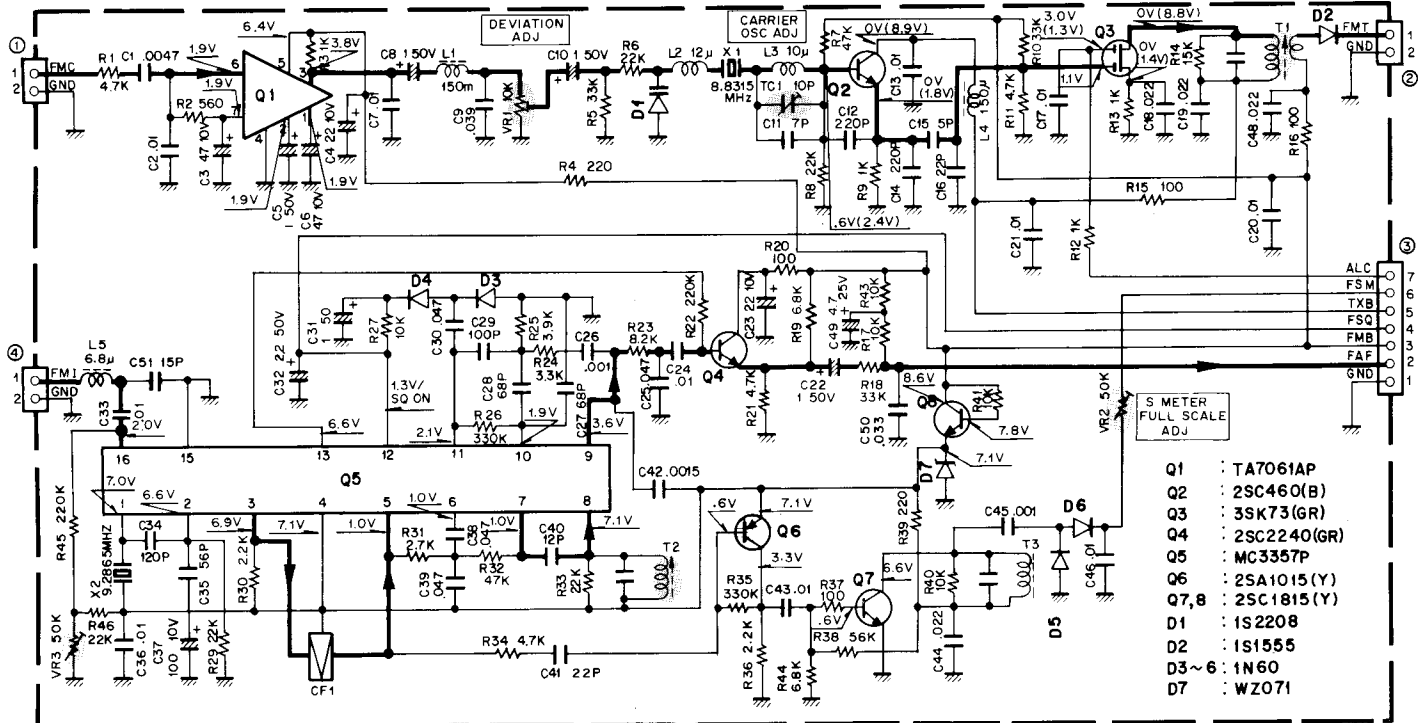

2SC1815
2SC1959
2SC2240

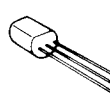

2SC2086

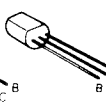

2SC460

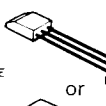

2SA562

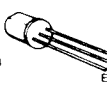

2SD880

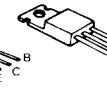

2SK19

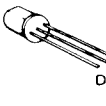

2SK61

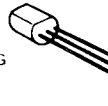

3SK73

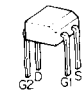

3SK74

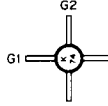

MV-13

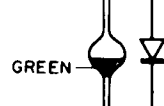

TS-660 PC BOARD VIEW

2SA1015
2SC1815
2SC1959
2SC2240

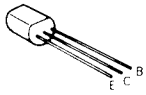

2SA562

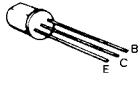

2SC460

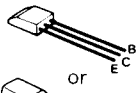

OR

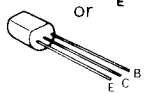

2SD880

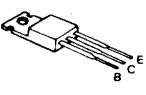

2SK19

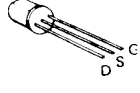

MPC14305H

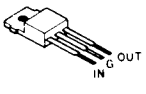

NJM78M09A

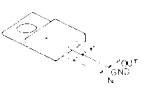

3SK73

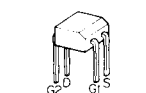

HA1366W

IF UNIT (X48-1330-00) Components side view

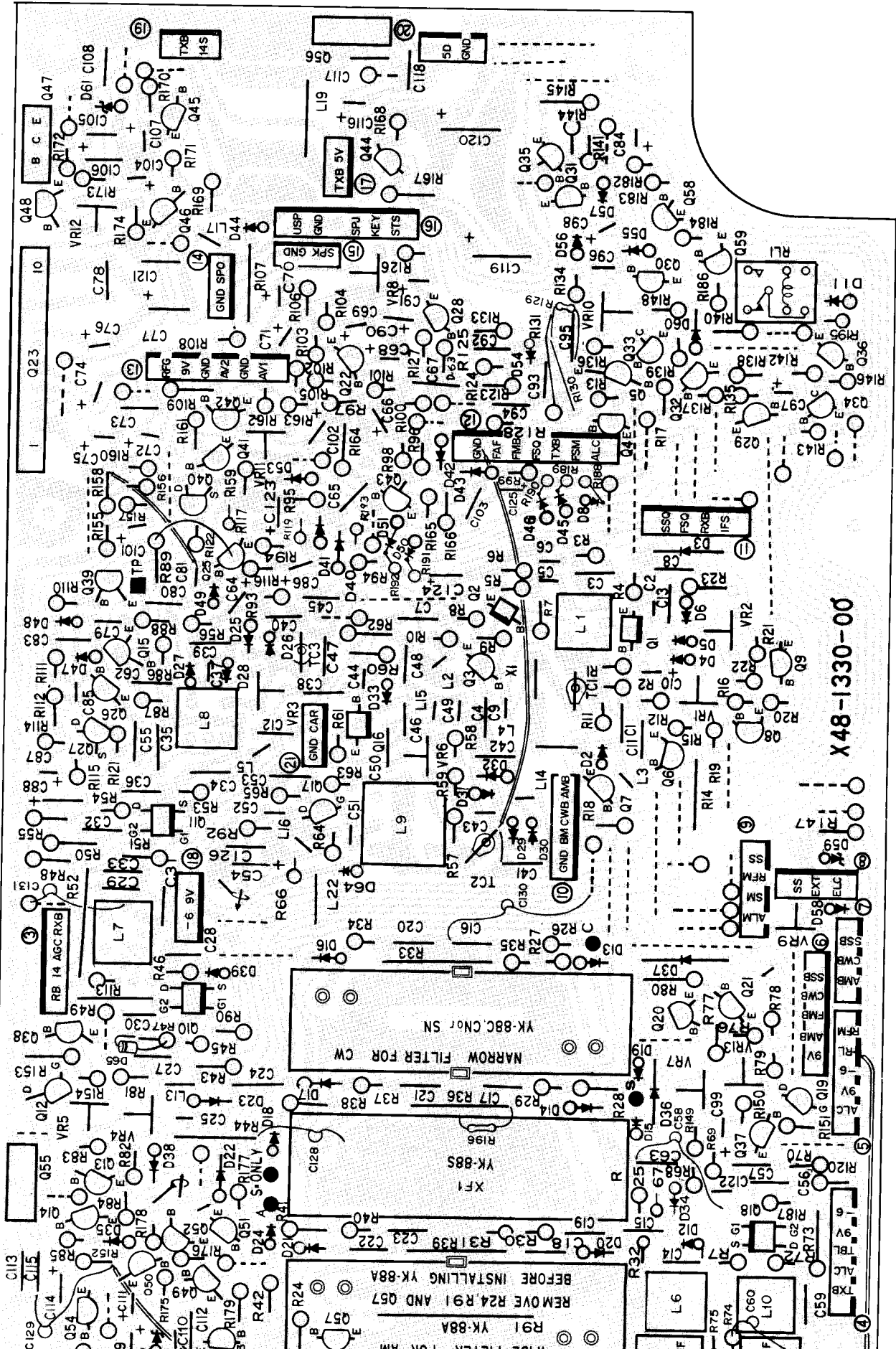

X48-1330-00

REMOVE R24, R91 AND Q57
R91 YK-88A
BEFORE INSTALLING YK-88A

WIDE FILTER FOR AM
NARROW FILTER FOR CW
YK-88C No. 5N

CIRCUIT DIAGRAM TS-660

IF UNIT (X48-1330-00)

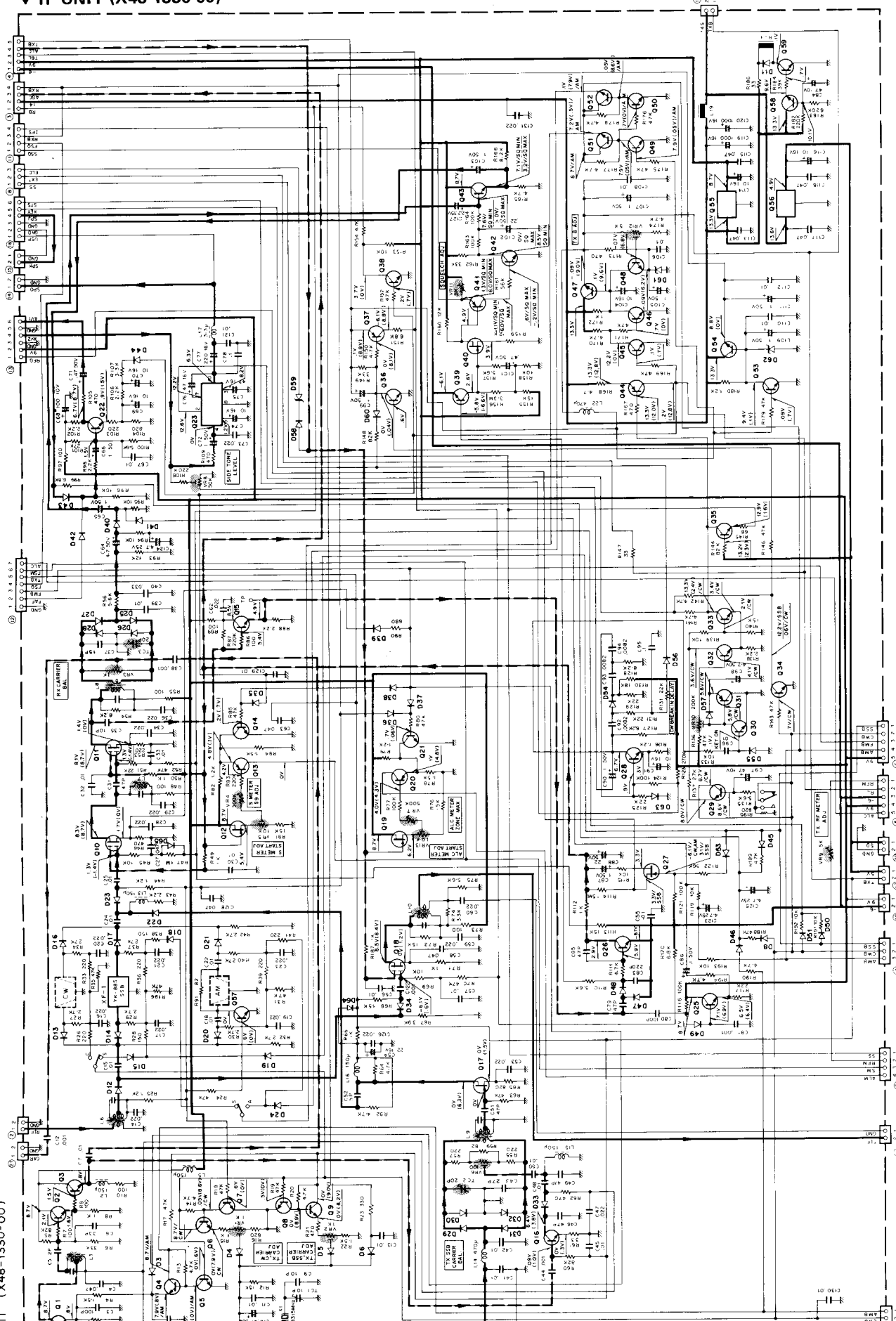

- 010, 11, 18 : 3SK73 (GR)
- 013, 20, 31, 37, 41 : 2SA1015(Y)
- 022, 43 : 2SC2240 (GR)
- 012, 17, 19 : 2SK19 (GR)
- 020 : 2SC460 (B)
- 021 : 2SC1959 (Y)
- 024, 15, 21, 25, 26, 28-30 : 2SC1815 (Y)
- 025, 38, 39, 42, 45, 46 : 2SC1815 (GR)
- 026 : 2SC1815 (GR)
- 027 : 2SC1815 (GR)
- 028 : 2SC1815 (GR)
- 029 : 2SC1815 (GR)
- 030 : 2SC1815 (GR)
- 031 : 2SC1815 (GR)
- 032 : 2SC1815 (GR)
- 033 : 2SC1815 (GR)
- 034 : 2SC1815 (GR)
- 035 : 2SC1815 (GR)
- 036 : 2SC1815 (GR)
- 037 : 2SC1815 (GR)
- 038 : 2SC1815 (GR)
- 039 : 2SC1815 (GR)
- 040 : 2SC1815 (GR)
- 041 : 2SC1815 (GR)
- 042 : 2SC1815 (GR)
- 043 : 2SC1815 (GR)
- 044 : 2SC1815 (GR)
- 045 : 2SC1815 (GR)
- 046 : 2SC1815 (GR)
- 047 : 2SC1815 (GR)
- 048 : 2SC1815 (GR)
- 049 : 2SC1815 (GR)
- 050 : 2SC1815 (GR)
- 051 : 2SC1815 (GR)
- 052 : 2SC1815 (GR)
- 053 : 2SC1815 (GR)
- 054 : 2SC1815 (GR)
- 055 : 2SC1815 (GR)
- 056 : 2SC1815 (GR)
- 057 : 2SC1815 (GR)
- 058 : 2SC1815 (GR)
- 059 : 2SC1815 (GR)
- 060 : 2SC1815 (GR)
- 061 : 2SC1815 (GR)
- 062 : 2SC1815 (GR)
- 063 : 2SC1815 (GR)
- 064 : 2SC1815 (GR)
- 065 : 2SC1815 (GR)
- 066 : 2SC1815 (GR)
- 067 : 2SC1815 (GR)
- 068 : 2SC1815 (GR)
- 069 : 2SC1815 (GR)
- 070 : 2SC1815 (GR)
- 071 : 2SC1815 (GR)
- 072 : 2SC1815 (GR)
- 073 : 2SC1815 (GR)
- 074 : 2SC1815 (GR)
- 075 : 2SC1815 (GR)
- 076 : 2SC1815 (GR)
- 077 : 2SC1815 (GR)
- 078 : 2SC1815 (GR)
- 079 : 2SC1815 (GR)
- 080 : 2SC1815 (GR)
- 081 : 2SC1815 (GR)
- 082 : 2SC1815 (GR)
- 083 : 2SC1815 (GR)
- 084 : 2SC1815 (GR)
- 085 : 2SC1815 (GR)
- 086 : 2SC1815 (GR)
- 087 : 2SC1815 (GR)
- 088 : 2SC1815 (GR)
- 089 : 2SC1815 (GR)
- 090 : 2SC1815 (GR)
- 091 : 2SC1815 (GR)
- 092 : 2SC1815 (GR)
- 093 : 2SC1815 (GR)
- 094 : 2SC1815 (GR)
- 095 : 2SC1815 (GR)
- 096 : 2SC1815 (GR)
- 097 : 2SC1815 (GR)
- 098 : 2SC1815 (GR)
- 099 : 2SC1815 (GR)
- 100 : 2SC1815 (GR)

TS-660 PC BOARD VIEW

▼ CONTROL UNIT (X53-1220-00) Components side view

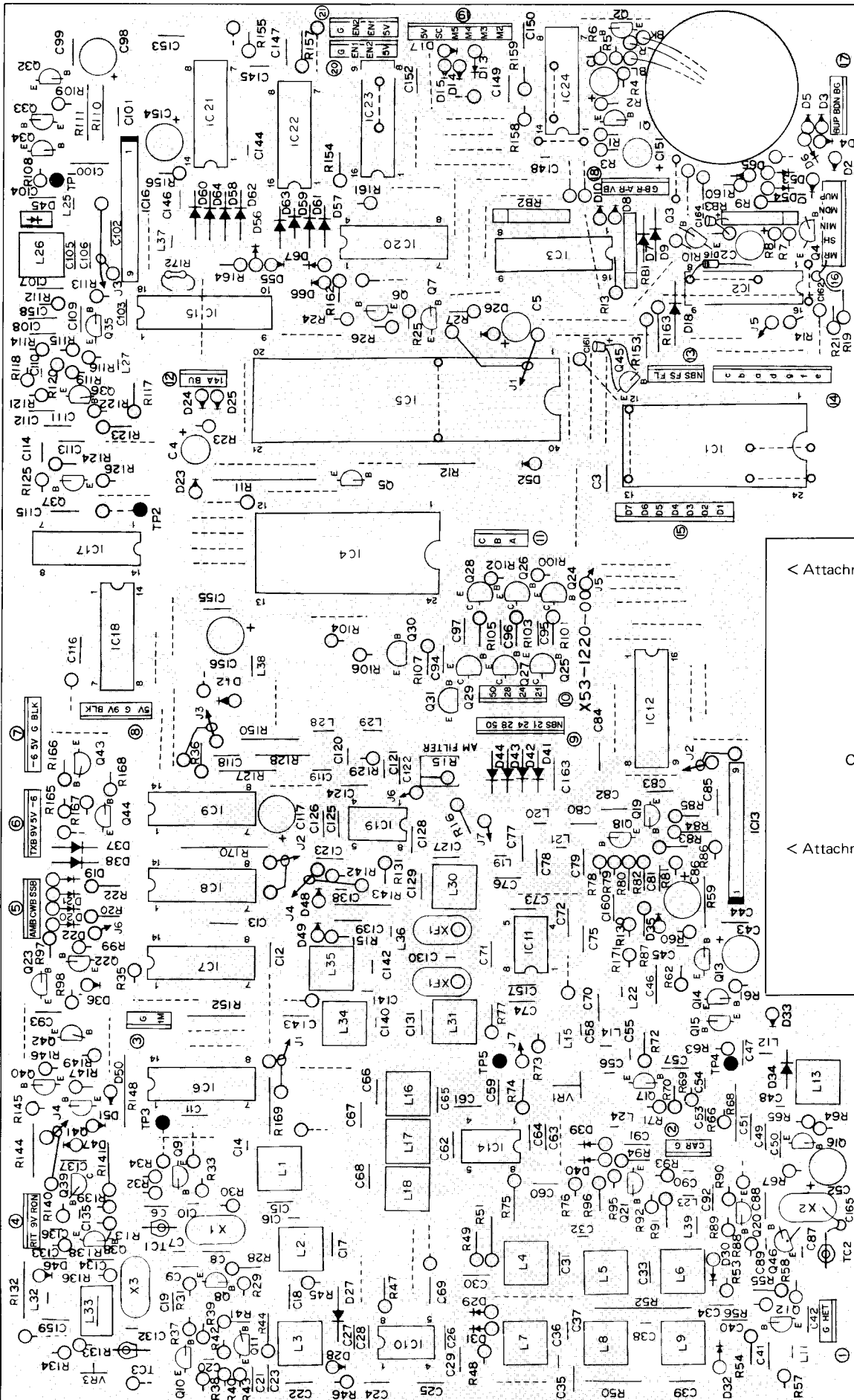

2SA1015
2SC945
2SC1775
2SC1815
2SC1923

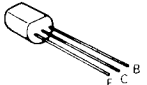

2SC2458

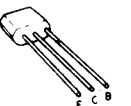

TC5081P

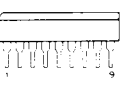

< Attachment direction of D45 >

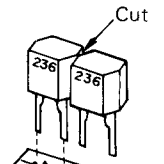

Cut D45 as shown

< Attachment direction of XF1 >



XF1 should be used as a pair.

< Attachment direction of resistor block >

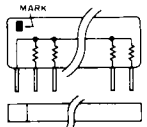

CIRCUIT DIAGRAM TS-660

▼ ENCODER UNIT (X54-1640-00)

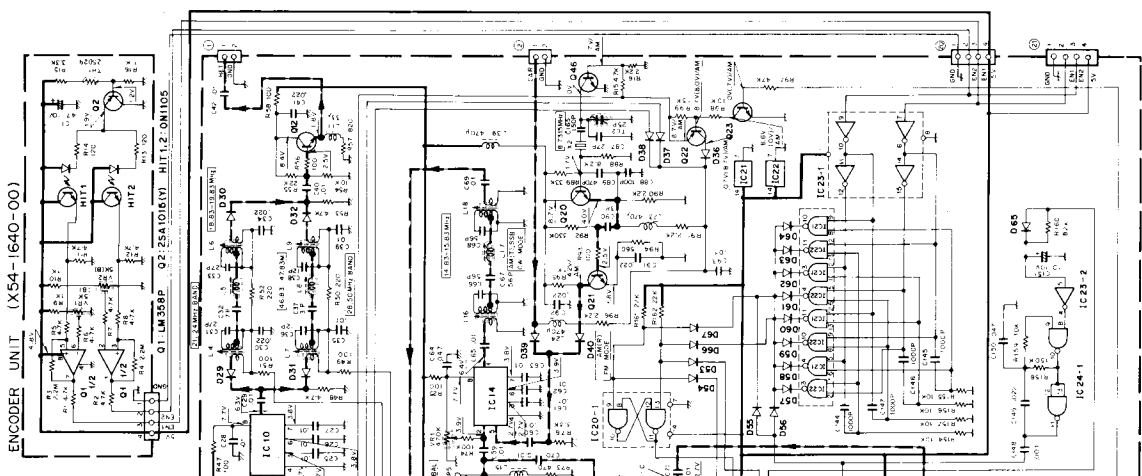

▼ CONTROL UNIT (X53-1220-00)

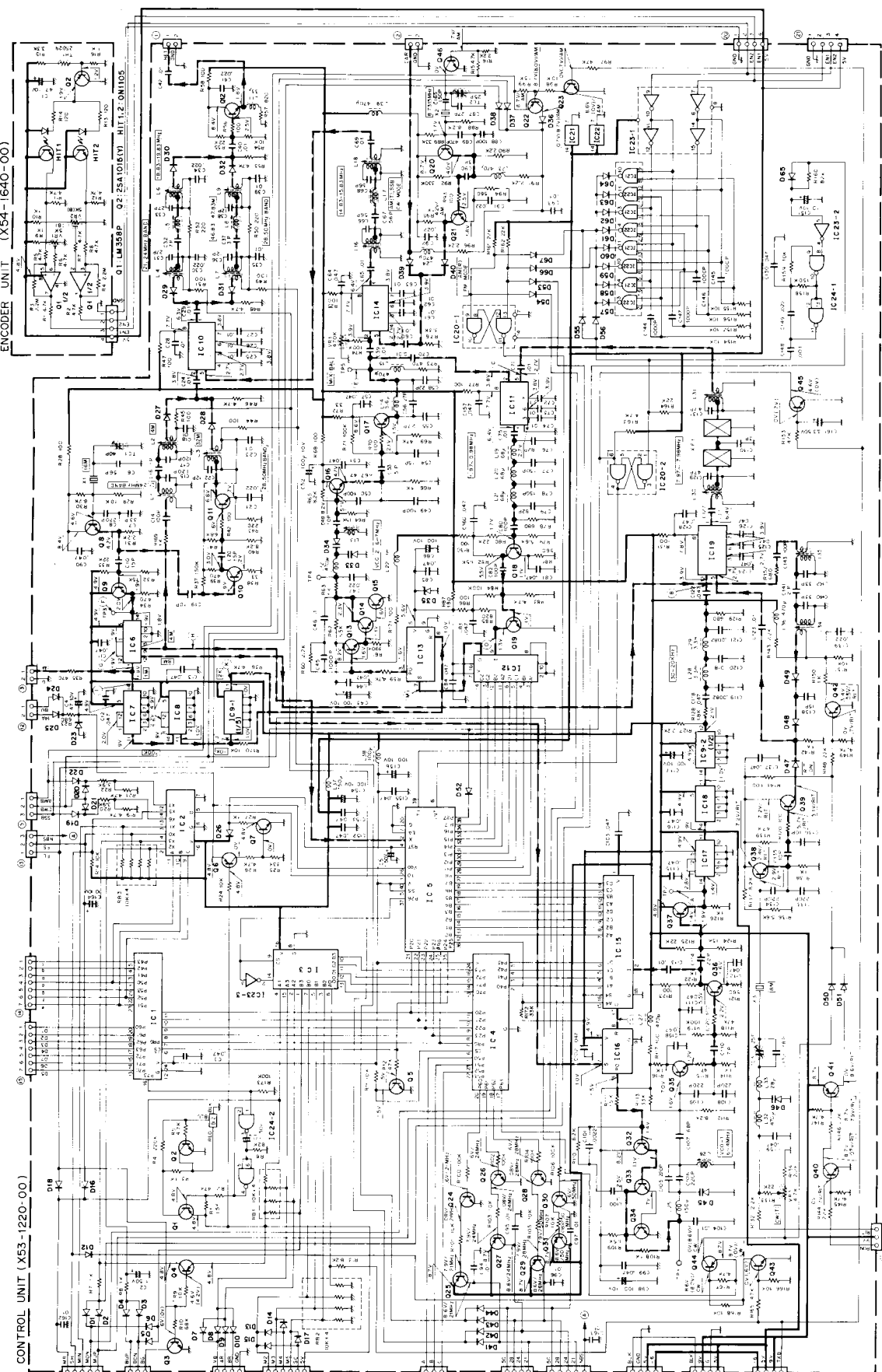

ENCODER UNIT (X54-1640-00)

CONTROL UNIT (X53-1220-00)

SW UNIT (X51-1350-00)

- | | | | | | | | | | | | | | | | | | | | |
|--------|--------|-------------|--------|------|-----------|------|--------|------|--------|------|--------|------|--------|------|--------|------|--------|------|--------|
| IC1, 4 | 74LS00 | IC13, 16 | 74LS00 | IC16 | SN74LS00N | IC18 | 74LS00 | IC19 | 74LS00 | IC20 | 74LS00 | IC21 | 74LS00 | IC22 | 74LS00 | IC23 | 74LS00 | IC24 | 74LS00 |
| IC2 | 74LS04 | IC15 | 74LS00 | IC17 | SN74LS00N | IC18 | 74LS00 | IC19 | 74LS00 | IC20 | 74LS00 | IC21 | 74LS00 | IC22 | 74LS00 | IC23 | 74LS00 | IC24 | 74LS00 |
| IC3 | 74LS00 | IC20-22, 24 | 74LS00 | IC21 | SN74LS00N | IC22 | 74LS00 | IC23 | 74LS00 | IC24 | 74LS00 | IC25 | 74LS00 | IC26 | 74LS00 | IC27 | 74LS00 | IC28 | 74LS00 |
| IC5 | 74LS00 | IC25 | 74LS00 | IC26 | SN74LS00N | IC27 | 74LS00 | IC28 | 74LS00 | IC29 | 74LS00 | IC30 | 74LS00 | IC31 | 74LS00 | IC32 | 74LS00 | IC33 | 74LS00 |

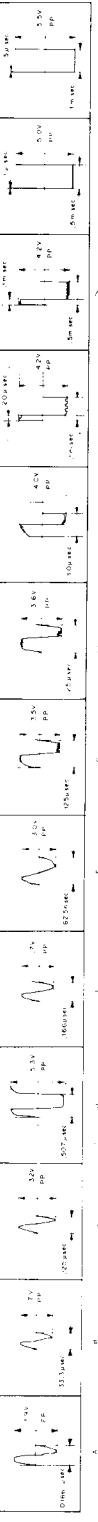

Measurement conditions f = 50,000MHz

TS-660 PC BOARD VIEW/CIRCUIT DIAGRAM

▼ PLL UNIT (X50-1740-00) Components side view

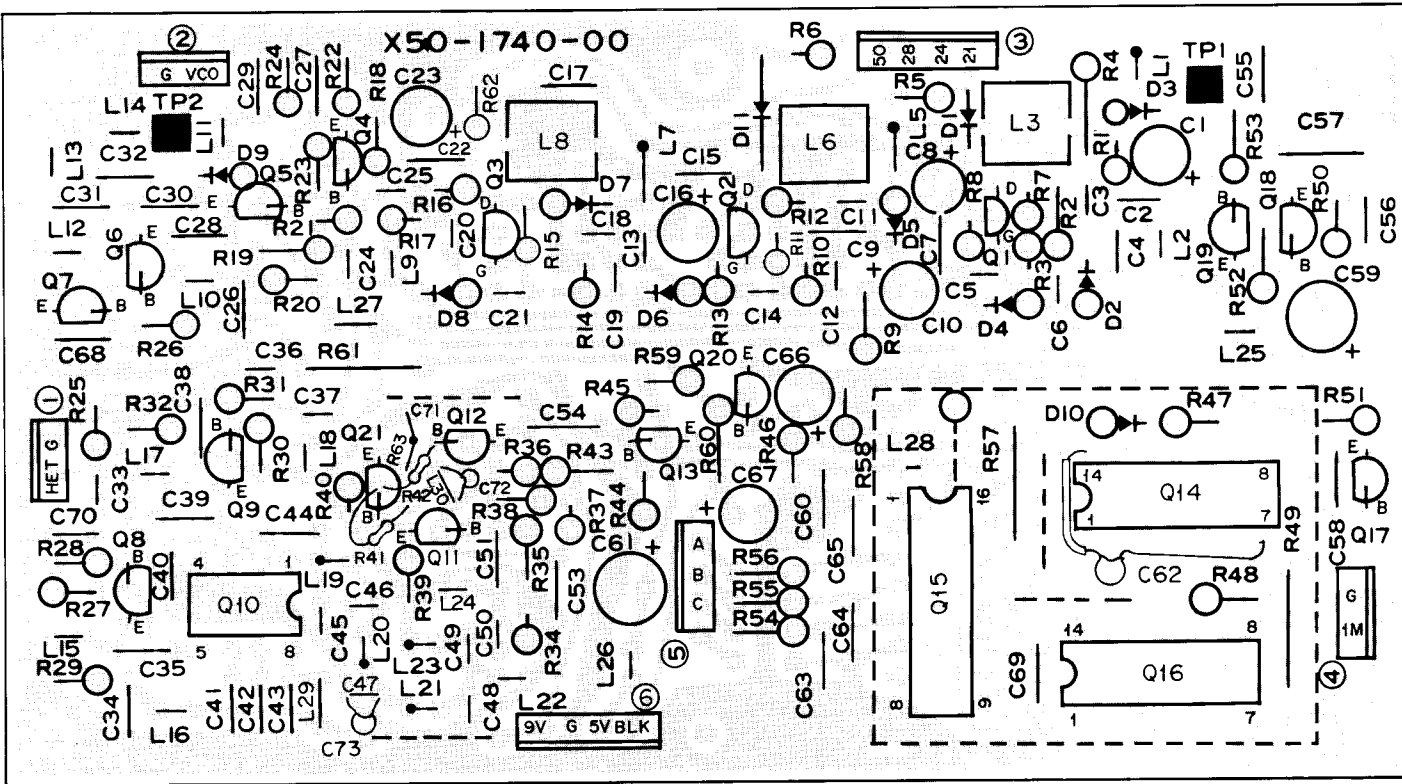

PLL UNIT (X50-1740-00)

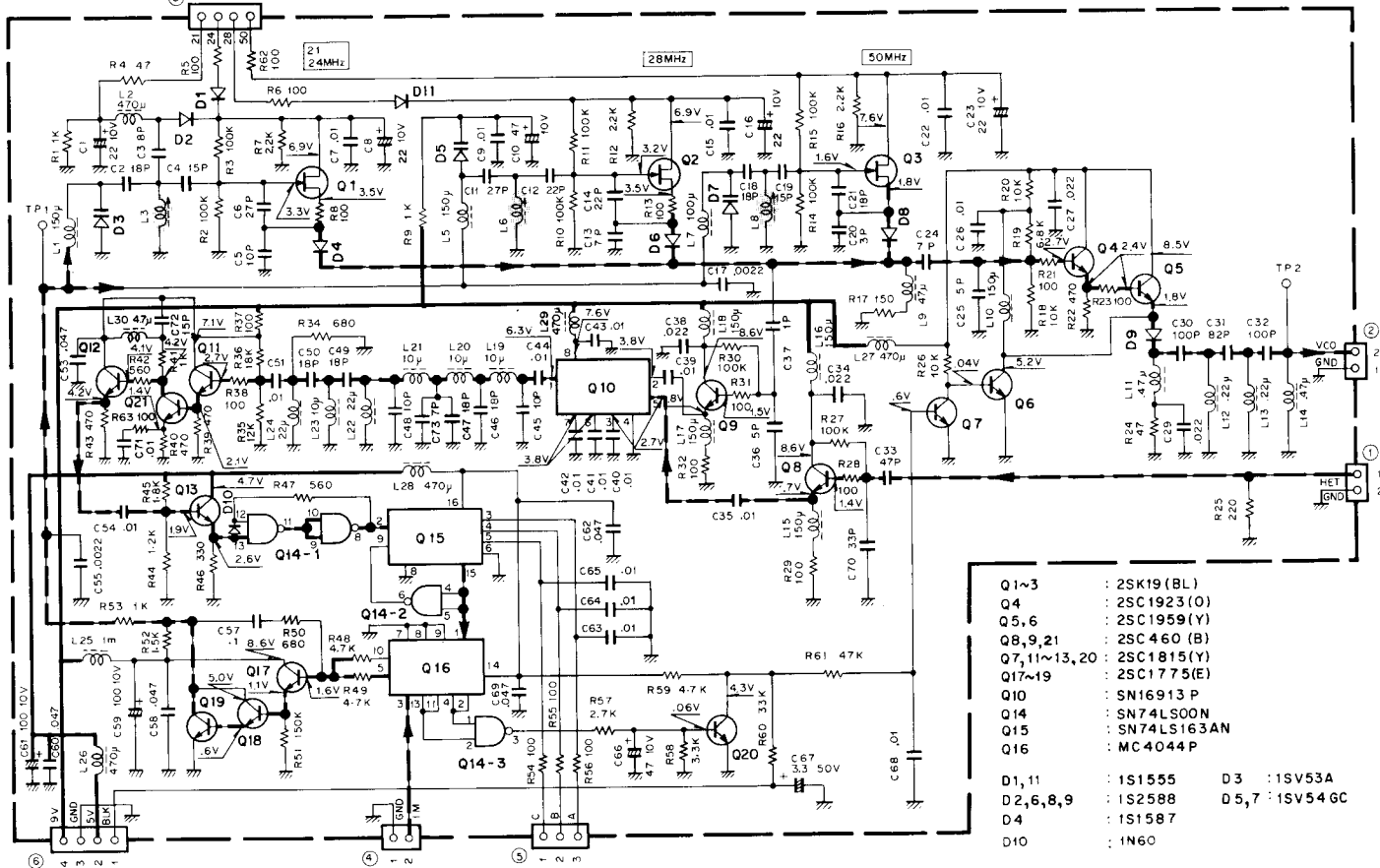

Q1~3	: 2SK19 (BL)	D3	: 15V53A
Q4	: 2SC1923(O)	D2,6,8,9	: 1S2588
Q5,6	: 2SC1959(Y)	D4	: 1S1587
Q8,9,21	: 2SC460 (B)	D10	: 1N60
Q7,11~13,20	: 2SC1815(Y)		
Q17~19	: 2SC1775(E)		
Q10	: SN16913 P		
Q14	: SN74LS00N		
Q15	: SN74LS163AN		
Q16	: MC4044P		

2SC1815 2SC1923 2SC1971 2SC1972 2SK19
 2SC1775 2SC1959 2SC460 2SC496 2SK19

PC BOARD VIEWS TS-660

▼ FILTER UNIT (X51-1260-00) Components side view

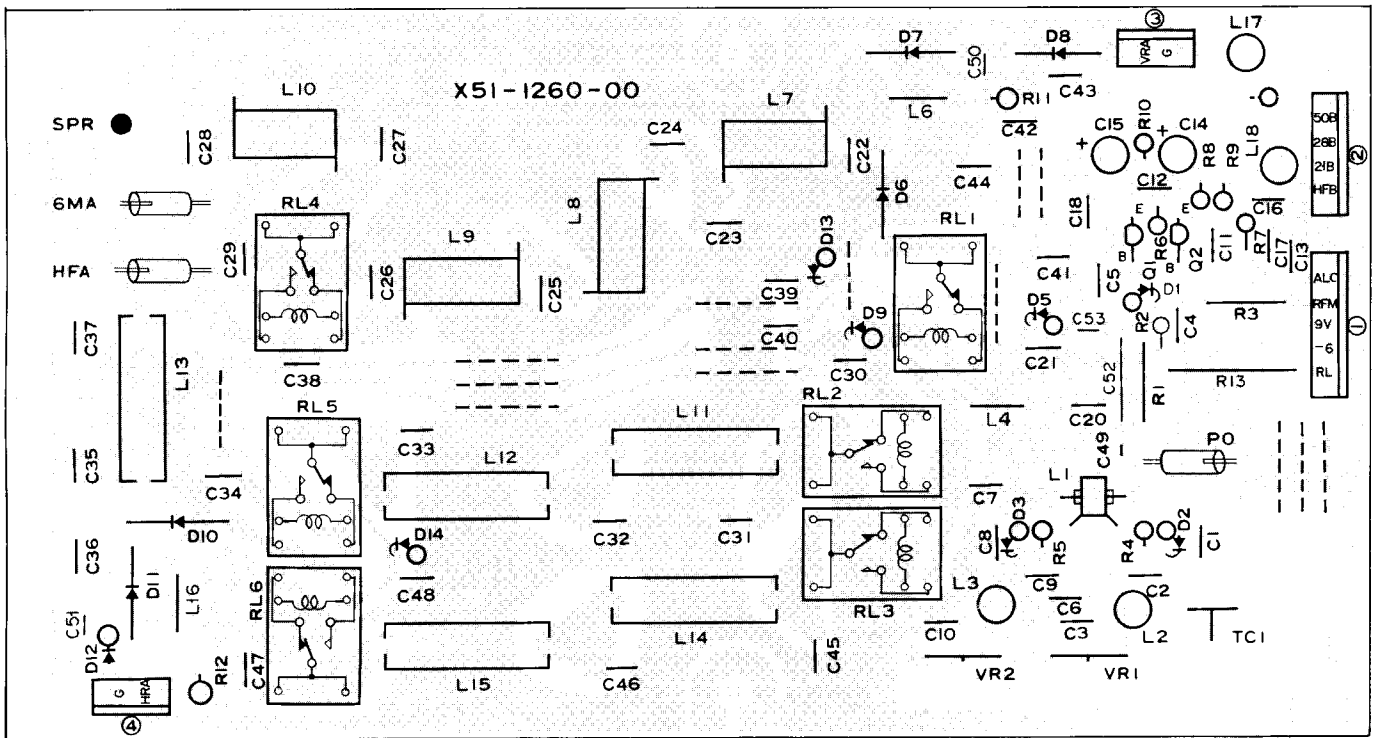

< Attachment direction of L1 >

Q1, 2 : 2SC1815(Y) D1~3 : 1N60 D5, 9, 13, 14 : 1S1555
D6, 7, 10, 11 : MI402 D12 : V06B D8 : MI301

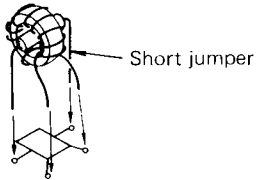

< Disconnecting the coaxial cable >

< Attachment direction of D1, 2 >

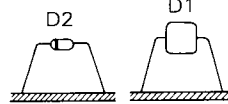
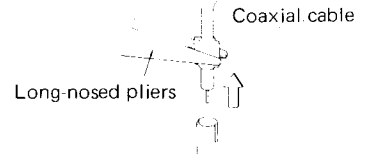

Hold the crimped metal sleeve with Pliers and pull up as shown.
Caution : DO NOT pull on the cable.

▼ FINAL UNIT (X56-1410-00) Components side view

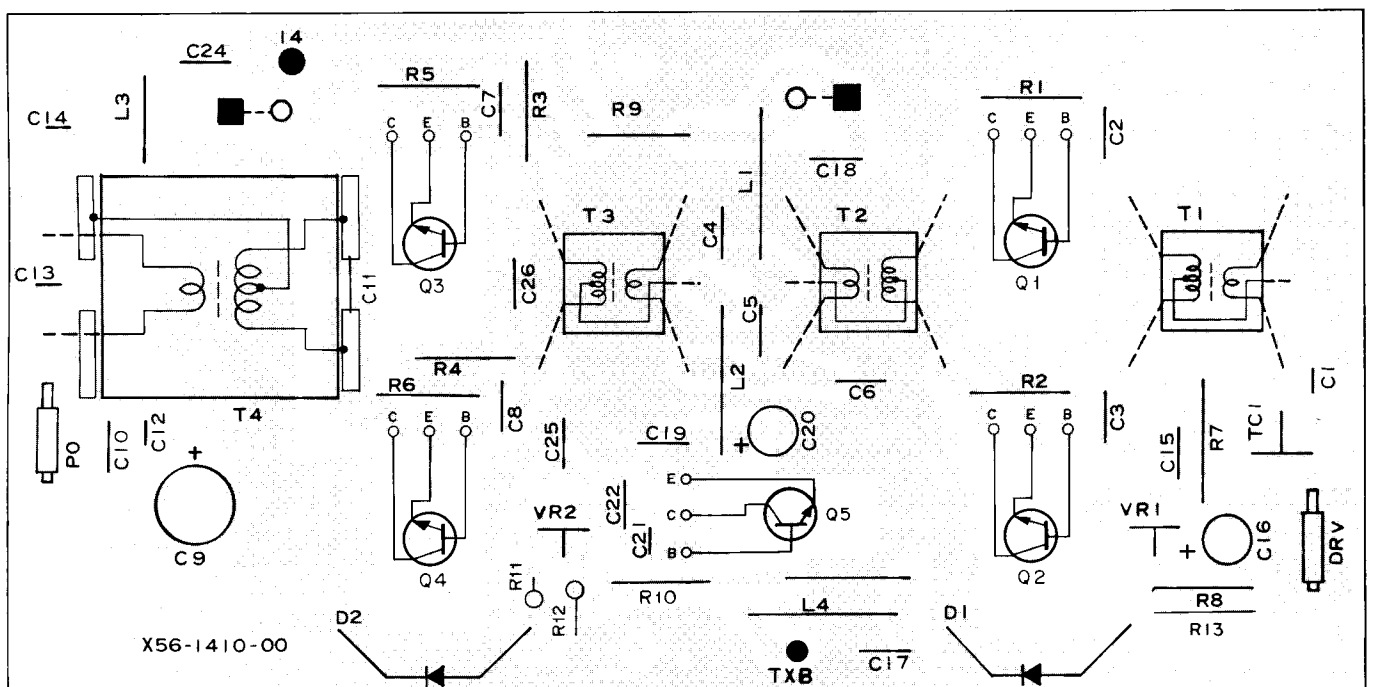

TS-660 PC BOARD VIEW/CIRCUIT DIAGRAM

▼ DISPLAY UNIT (X54-1630-00) Components side view

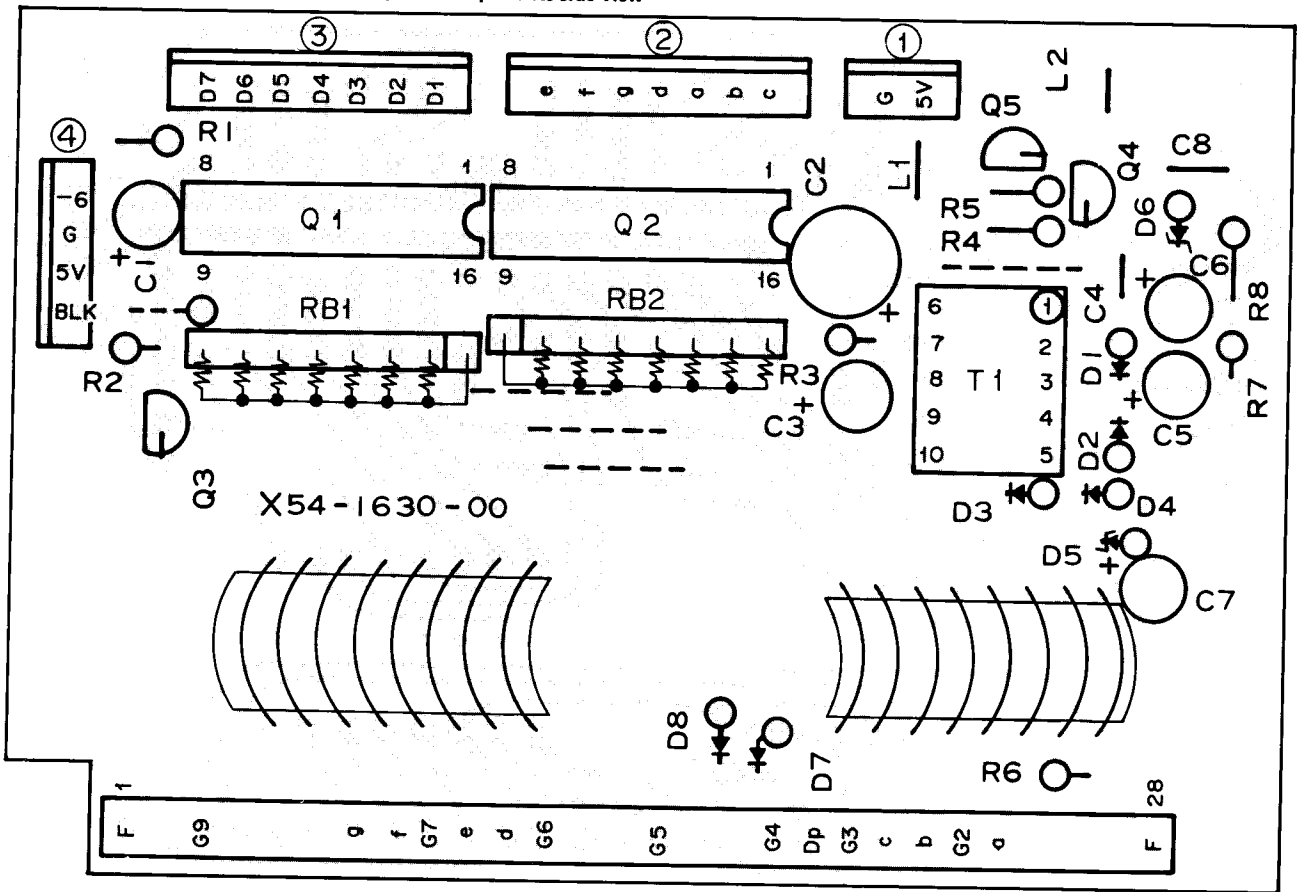

< TC5065BP Blockdiagram >

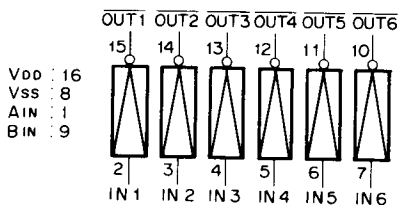

< TC5067BP Blockdiagram >

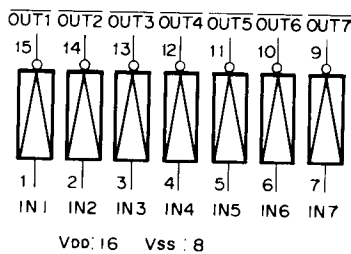

< Display tube 9-BT-12 >

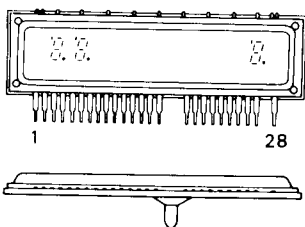

DISPLAY (X54-1630-00)

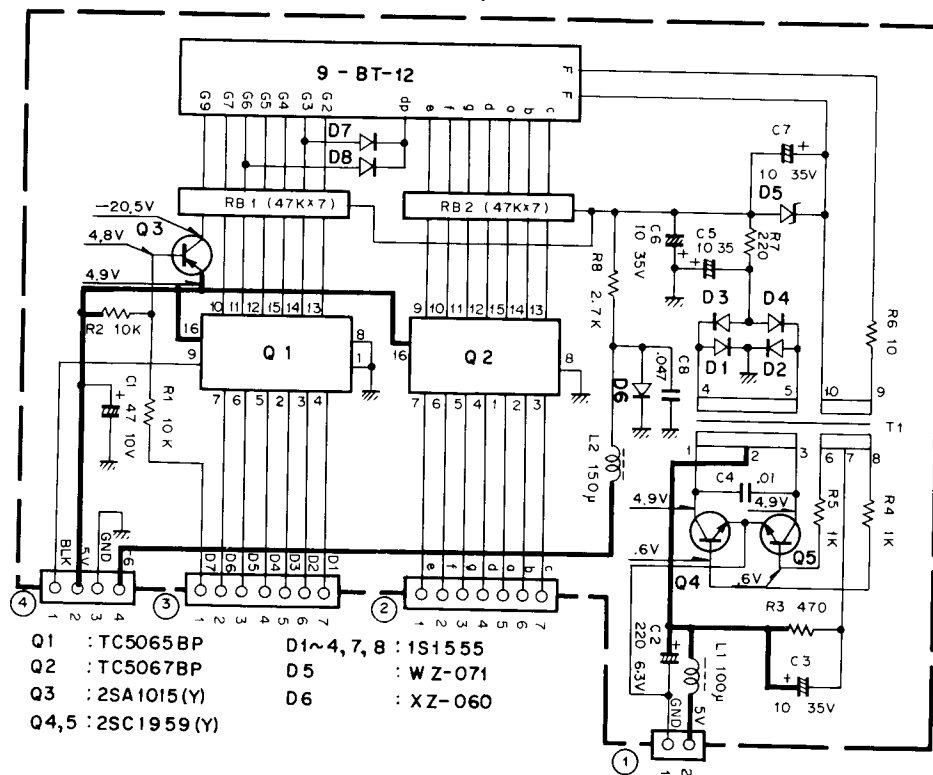

- Q1 : TC5065BP D1~4, 7, 8 : 1S1555
- Q2 : TC5067BP D5 : WZ-071
- Q3 : 2SA1015(Y) D6 : XZ-060
- Q4,5 : 2SC1959(Y)

PIN NO	1	2	3	4	5	6	7	8	9	10	11	12	13	14
CONNECTION	F	Nc	G _a	Nc	Nc	G ₈	g	f	G ₇	e	d	G ₆	Nc	Nc
	15	16	17	18	19	20	21	22	23	24	25	26	27	28

2SA1015
2SC1959

PARTS LIST

Note 1:

K. U.S.A. T. Britain W. Europe X. Australia

Note 2:

Only special type of resistors (example: cement, metal film, etc.) and capacitors (example: electrolytic, tantalum, mylar, temp. coeff. capacitors) are detailed in the PARTS LIST. For the value of all common type components, refer to the schematic diagram of the P.C. board illustration. Resistors not otherwise detailed are carbon type (1/4W or 1/8W). Order carbon resistors and capacitors according to the following example:

A carbon resistor's part number is RD14BY 2E222J

A ceramic capacitor's number is CK45F1H103Z, CC45TH1H220J

RESISTOR

1. Type of the carbon resistor

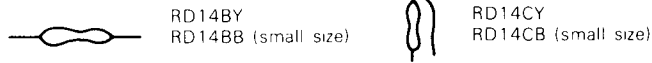

2. Wattage

1W → 3A 3W → 3F 5W → 3H
2W → 3D 4W → 3G

3' = CC45 ○ ○ ...

Ceramic capacitor (type I) temperature coeff. capacitor 1' 3'

1st word (Color)	C (Black)	L (Red)	P (Orange)	R (Yellow)	S (Green)	T (Blue)	U (Violet)
ppm/°C	0	-80	-150	-220	-330	-470	-750

3 = CK45 ○

Ceramic capacitor (type II) 3

Cord	B	D	E	F
Operating temperature °C	-30 +85	-30 +85	-30 +85	-10 +70

6 = Tolerance

Cord	C	D	G	J	K	M	X	Z	P	No cord
(%)	±0.25	±0.5	±2	±5	±10	±20	+40 -20	+80 -20	+100 -0	More than 10 μF -10 ~ +50 Less than 4.7 μF -10 ~ +75

Less than 10 pF

Cord	B	C	D	F	G
(pF)	±0.1	±0.25	±0.5	±1	±2

Abbreviation		Abbreviation	
Cap	Capacitor	ML	Mylar
C	Ceramic	S	Styren
E	Electrolytic	T	Tantalum
MC	Mica		

3. Resistance value

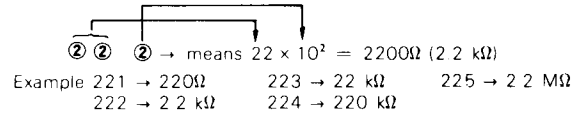

4. Tolerance

J = ±5% (Gold) K = ±10% (Silver)

CAPACITORS

Type I

CC 45 TH 1H 220 J CK 45 F 1H 103 Z

1' 2 3' 4 5 6 1 2 3 4 5 6

1 = Type ceramic, electrolytic, etc 4 = Voltage rating
2 = Shape round, square, etc 5 = Value
3 = Temp range 6 = Tolerance
3' = Temp coefficient

Type II

Ex. CC45TH = -470 ±60 ppm/°C

2nd Word	G	H	J	K	L
ppm/°C	±30	±60	±120	±250	±500

5 = Capacitor value

Example: 010 → 1 pF
100 → 10 pF
101 → 100 pF
102 → 1000 pF = 0.001 μF
103 → 0.01 μF

CC45

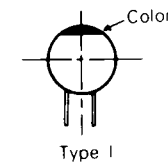

CK45

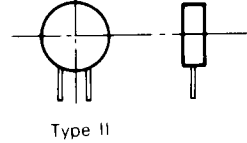

TS-660 SEMICONDUCTOR

N : New parts

Item	Name	Re-marks	Parts No.
Diode	1N60		V11-0051-05
	1S1007		V11-4160-66
	1S1555		V11-0076-05
	1S1587		V11-0370-05
	1S2208		V11-0317-05
	1S2588		V11-0414-05
	KV1236	N	V11-3178-76
	MI301		V11-0255-05
	MI402		V11-5260-16
	U05B		V11-0270-05
V06B		V11-0219-05	
Varistor	MV-13		V21-0004-05
	SV03		V21-0007-05
	SV03		V11-1332-22

Item	Name	Re-marks	Parts No.
Vari-Cap	1SV53A		V11-4161-36
	1SV54GC		V11-4173-46
Zener diode	WZ-050		V11-4102-10
	WZ-061		V11-0243-05
	WZ-071		V11-4160-86
	WZ-090		V11-0240-05
	XZ-055		V11-4105-50
LED	XZ-060		V11-4101-20
	XZ-094		V11-4173-26
	PR2112D		V11-7260-66
	SG238D	N	V11-1278-16
	SG500D	N	V11-1278-06

TS-660

PARTS LIST

Item	Name	Re- marks	Parts No.
Thermistor	SY438D	N	V11-1278-26
	25D29		V11-3360-16
Photo interruptor	ON1105		V11-1173-76
Display tube	9-BT-12		V40-7760-86
TR	2SA562(Y)		V01-0032-05
	2SA1015(Y)		V01-1015-06
	2SC460(B)		V03-0079-05
	2SC496(Y)		V03-0336-05
	2SC945(Q)		V03-0945-06
	2SC945(R)		V03-0316-05
	2SC1775(E)		V03-1775-06
	2SC1815(GR)		V03-1815-16
	2SC1815(Y)		V03-1815-06
	2SC1923(O)		V03-1923-06
	2SC1959(Y)		V03-1959-06
	2SC1971	N	V03-1971-16
	2SC1972	N	V03-1972-16
	2SC2086		V03-2086-06
	2SC2240(GR)		V03-2240-06
	2SC2458(Y)		V03-2458-06
	2SD880(Y)		V04-0880-16
FET	2SK19(BL)		V09-0013-05
	2SK19(GR)		V09-0012-05
	2SK19(Y)		V09-0011-05
	2SK30A(O)		V09-0056-05
	2SK61(GR)		V09-1014-06
	3SK73(GR)		V09-1002-46
	3SK74(L)		V09-1002-56
IC	74LS00N		V30-1111-06
	74LS163N		V30-1037-06
	HA1366W		V30-1045-06
	HD74LS00P		V30-1046-06
	HD74LS163P		V30-1047-06
	LM358P		V30-1024-56
	MC3357P		V30-1003-36
	MC4044P		V30-0173-05
	MC14569B		V30-1100-06
	NJM78M09A	N	V30-1107-16
	SN74LS00N		V30-0301-30
	SN74LS90N		V30-1005-26
	SN74LS93N		V30-1113-06
	SN74LS151N		V30-1240-16
	SN74LS163AN		V30-1154-06
	SN16913P		V30-1048-06
	TA7061AP		V30-0039-05
	TC40118P		V30-0301-70
	TC40198P		V30-1049-06
	TC4049BP		V30-1009-26
	TC5065BP	N	V30-1056-16
	TC5067BP	N	V30-1057-16
	TC5081P		V30-1132-06

Item	Name	Re- marks	Parts No.
	μ PC14305H		V30-1029-36
	μ PD8048C-292	N	V30-1176-36
	μ PD8243C		V30-1177-16

Ref. No.	Parts No.	Re- marks	Description
----------	-----------	--------------	-------------

TS-660 GENERAL

	A01-0901-02	N	Case (A) upper	
	A01-0902-12	N	Case (B) lower	
	A20-2430-03	N	Panel	
	B05-0708-04		SP grill cloth	
	B05-0713-04		Grill cloth Buzzer	
	B10-0644-04	N	Front glass	
	B20-0819-04	N	Dial scale	
	B30-0820-05	N	Pilot lamp 9V, 60mA	
	B31-0632-05	N	Meter	
	B39-0407-04		Spacer x 2 Assistant foot	
	B42-1707-04	N	Switch plate	
	B43-0661-04	N	Name plate	
	B46-0058-10		Warranty card	K
	B50-3910-00	N	Instruction manual	
C1	C90-0806-05	E	2200 μ F 16V	
C7	CC45SL2H100D	C	10pF	
	E04-0152-05		M type receptacle x 2	ANT
	E06-0252-05		2P metal socket	POWER
	E06-0751-05		7P DIN socket	REMOTE
	E07-0252-05		2P metal plug	DC cord ass'y
	E07-0751-05		7P DIN plug (accessory)	REMOTE
	E07-0852-05		8P metal plug	MIC
	E08-0304-05		Power jack	BACK UP
	E11-0403-05		Earphone jack	EXT. SP
	E11-0404-05		3P phone jack	KEY
	E11-0412-05	N	3P phone jack	PHONES
	E12-0001-05		Phone plug (accessory)	EXT. SP
	E22-0207-05		Lug plate x 2	
	E30-1675-05		DC cord ass'y	
	E31-0431-05		Speaker cord	
	F05-4022-05		Fuse 4A	
	F05-4022-05		Fuse 4A (accessory)	
	F29-0420-05		Insulating bushing	
	G01-0804-04		Coil spring Dial scale	
	G02-0505-05		Knob spring x 4	
	G02-0518-04		Gnd spring (C)	
	G02-0531-04		Gnd spring	
	G53-0511-04		Packing	
	H01-2757-04	N	Carton case (inside)	
	H03-2008-04	N	Carton case (outside)	
	H10-2549-02	N	Packing fixture (F)	
	H10-2550-02	N	Packing fixture (R)	
	H12-0482-04	N	Cushion	
	H20-1405-03		Protective cover	
	H25-0079-04		Protective bag MIC	
	H25-0112-04		Protective bag DC cord	
	H25-0116-04		Protective bag	
	J02-0323-05		Foot x 4	

PARTS LIST

Ref. No.	Parts No.	Re- marks	Description	Ref. No.	Parts No.	Re- marks	Description
J02-0407-04			Assistant foot	SWITCH UNIT (X41-1340-00)			
J21-2573-04			Foot mounting hardware x 2	C1, 2	CC45SL1H101J		C 100pF
J31-0141-04			Spacer ring MIC	C3	CE04W1H010M		E 1μF 50V
J61-0401-05			Nylon band x 4	C4	CE04W1A101M		E 100μF 10V
K21-0756-04	N		Main knob	C5	CE04W1E4R7M		E 4.7μF 25V
K23-0710-04			Knob (inside) x 4 SQL, MIC, RIT, AF	C6	CQ92M1H153K		ML 0.015μF
K23-0738-04			Knob 1 x 2 MEMORY, MODE	C7	CE04W1H010M		E 1μF 50V
K27-0414-04			Push knob x 5 RIT, NB, F. STEP, M, HOLD	C8	CQ92M1H473K		ML 0.047μF
K27-0415-04			Push knob x 2 VFO/MEMO, F. LOCK	C9	CE04W1H010M		E 1μF 50V
K27-0426-04	N		BAND knob x 2	C10	CE04W1E4R7M		E 4.7μF 25V
K29-0709-04			Push knob ALC/RF	C11	CE04BW1C3R3M		E 3.3μF 16V (Non-pole)
K29-0741-04			Knob (outside) x 3 CAR, IF SHIFT, RF	C12	CE04W1H010M		E 1μF 50V
K29-0749-04	N		Pointer knob FUNCTION		E06-0853-05		8P male socket MIC
K29-0750-04	N		Push knob SEND/REC		E23-0047-04		Square terminal x 2
N09-0256-05			Gnd screw x 4		E40-0273-05		Mini connect wafer x 2 2P
N14-0115-05			Flange nut GND		E40-0373-05		Mini connect wafer 3P
N14-0509-05			Wing nut GND		E40-0473-05		Mini connect wafer x 3 4P
N15-1040-46			Washer x 2 GND		E40-0673-05		Mini connect wafer 6P
N19-0608-04			Washer x 2 Dial scale	VR1-1, 1-2	R19-3410-05	N	Pot. MIC/CAR, AF/RF
N30-2604-46			Round screw x 15 2.6 x 4	2-1, 2-2			
N30-3004-46			Round screw x 2 ANT SELECT SW	VR3	R12-4020-05		Trim. pot 50kΩ
N30-3008-46			Round screw Panel	VR4-1, 4-2	R19-3411-05	N	Pot. RIT/IF SHIFT
N30-4016-46			Round screw GND	VR5-1, 5-2	S03-2401-05	N	Rotary switch with VR
N32-2606-46			Flat screw 2.6 x 6 LED		R92-0150-05		Short jumper
N32-3006-46			Flat screw x 2 Display unit	S1	S03-2401-05	N	Rotary switch with VR
N33-3006-46			Round flat screw x 8 SP, Panel	S2-5	S40-2419-05		Push switch RIT, NB, F. LOCK, F. STEP
N35-3006-45			Bind screw x 15 Case A, B	S6	S01-2431-05	N	Rotary switch MODE
N87-2606-46			Self tapping screw Front glass	S7	S01-1428-05	N	Rotary switch MEMORY
N87-3006-41			Self tapping screw x 2 Name plate	S8, 9	S40-2405-05		Push switch METER, STBY
N87-3006-46			Self tapping screw x 14	S10	S40-2419-05		Push switch VFO/MEMO
N87-3008-46			Self tapping screw x 4 Final unit	S11	S40-2426-05	N	Push switch M
N87-3012-46			Self tapping screw x 32	S12	S40-2419-05		Push switch HOLD
N88-2606-46			Flat tapping screw x 3 BAND	BAND SWITCH UNIT (X41-1350-00)			
N88-3006-46			Flat tapping screw x 10 Sub, Rear panel	S1, 2	S50-1409-05	N	Tact switch
N89-3005-46			Bind tapping screw x 5 Lug plate, Assistant foot	RF UNIT (X44-1440-00)			
N89-3006-46			Bind tapping screw x 2 IF unit	C1	CC45RH1H820J		C 82pF
S31-2007-05			Slide switch ANT	C2	CC45RH1H101J		C 100pF
S36-2402-05			Paddle switch POWER	C3	CC45RH1H181J		C 180pF
S50-1406-05			Tact switch x 2	C4	CC45RH1H560J		C 56pF
T03-0027-15			Speaker	C9	CC45SL1H101J		C 100pF
T91-0316-15			Microphone	C10	CC45SL1H100D		C 10pF
X41-1340-00	N		Switch unit	C11	CC45SL1H270J		C 27pF
X41-1350-00	N		BAND switch unit	C12	CC45SL1H101J		C 100pF
X44-1440-00	N		RF unit	C20	CC45SL1H220J		C 22pF
X48-1330-00	N		IF unit	C31	CC45SL1H330J		C 33pF
X48-1340-00	N		FM unit	C40	CC45SL1H180J		C 18pF
X50-1740-00	N		PLL unit	C41	CC45SL1H470J		C 47pF
X51-1260-00	N		Filter unit	C48	CC45SL1H050C		C 5pF
X53-1220-00	N		Control unit	C49	CC45SL1H100D		C 10pF
X54-1630-00	N		Display unit	C51, 52	CC45SL1H470J		C 47pF
X56-1410-00	N		Final unit	C54	CE04W1C100M		E 10μF 16V
X60-1170-00	N		Encoder ass'y unit	C56	CC45SL1H100D		C 10pF
				C65	CC45SL1H030C		C 3pF
				C71	CC45SL1H150J		C 15pF
				C72, 73	CC45SL1H180J		C 18pF

PARTS LIST

Ref. No.	Parts No.	Re- marks	Description	Ref. No.	Parts No.	Re- marks	Description
C84	CE04W1H010M		E 1 μ F 50V	L51	L40-3392-02		Ferri-inductor 3.3 μ H
C87	CC45SL1H560J		C 56pF	L52-54	L40-1511-03		Ferri-inductor 150 μ H
C94	CC45SL1H820J		C 82pF	L55	L40-4701-03		Ferri-inductor 47 μ H
C100	CC45SL1H680J		C 68pF	L56	L40-1511-03		Ferri-inductor 150 μ H
C102	CC45SL1H820J		C 82pF	T1	L19-0324-05	N	Wide bandwidth trans
C105	CC45SL1H330J		C 33pF	T2	L30-0506-05		IFT
C109	CC45SL1H101J		C 100pF	T3	L30-0512-05	N	IFT 8.83 MHz
C116, 119, 121, 125, 129	CE04W1H010M		E 1 μ F 50V	T4	L34-0536-05		Tuning coil
TC1-3	C05-0309-05		Ceramic trimmer 40pF	T5	L34-0942-05		Tuning coil
	E04-0154-05		Mini pin jack	T6	L30-0511-05	N	IFT 8.83 MHz, NB
	E23-0046-04		Square terminal x 2	T7	L34-0535-05		Tuning coil
	E23-0512-05		Terminal	T8	L34-0536-05		Tuning coil
	E29-0413-05		1P connector (female)	T9	L19-0324-05	N	Wide bandwidth trans
	E40-0273-05		Mini connect wafer x 7 2P	T10	L34-0697-05		Tuning coil
	E40-0473-05		Mini connect wafer x 2 4P	T11	L19-0328-05	N	Wide bandwidth trans
	E40-0573-05		Mini connect wafer x 2 5P	T12	L34-2026-05	N	ANT coil 28 MHz
	J31-0502-04		PC board collar x 4	CF1	L72-0324-05		Ceramic filter 8.83 MHz
	J42-0428-05		PC board bushing x 4	VR1, 2	R12-0420-05	N	Trim. pot 500 Ω (B)
L1, 2	L40-1511-03		Ferri-inductor 150 μ H	VR3, 4	R12-1415-05		Trim. pot 3k Ω (B)
L3, 4	L34-2027-05	N	ANT coil 50 MHz		R92-0150-05		Short jumper x 32
L5	L40-1511-03		Ferri-inductor 150 μ H	RL1	S51-1404-05		Relay G2E
L6	L79-0484-05	N	Coil block A 50 MHz	IF UNIT (X48-1330-00)			
L7	L40-1511-03		Ferri-inductor 150 μ H	C3	CC45SL1H101J		C 100pF
L9	L34-0983-05		BPF coil 21C	C5	CC45SL1H020C		C 2pF
L10, 11	L34-2025-05	N	ANT coil 24 MHz	C6	CC45SL1H330J		C 33pF
L12	L40-2211-03		Ferri-inductor 220 μ H	C9	CC45UJ1H100D		C 10pF
L13-16	L40-4711-03		Ferri-inductor 470 μ H	C10	CE04W1HR47M		E 0.47 μ F 50V
L17	L34-0981-05		BPF coil 21A	C27	C91-0456-05		C 0.047 μ F
L18	L34-0982-05		BPF coil 21B	C31	CC45SL1H470J		C 47pF
L19	L34-0983-05		BPF coil 21C	C35	CC45SL1H100D		C 10pF
L20	L34-0984-05		BPF coil 24A	C37	CC45SL1H150J		C 15pF
L21	L34-0985-05		BPF coil 24B	C40	CQ92M1H333K		ML 0.033 μ F
L22	L34-0986-05		BPF coil 24C	C43	CC45SL1H220J		C 22pF
L23	L34-0707-05		BPF coil 28A	C46, 49, 51	CC45SL1H470J		C 47pF
L24	L34-0987-05		BPF coil 28B	C52	CC45SL1H050C		C 5pF
L25	L34-0984-05		BPF coil 28C	C54	CE04W1C220M		E 22 μ F 16V
L26	L40-4711-03		Ferri-inductor 470 μ H	C58, 63	C91-0456-05		C 0.047 μ F
L27	L40-3311-03		Ferri-inductor 330 μ H	C64	CE04W1H4R7M		E 4.7 μ F 50V
L28	L40-4711-03		Ferri-inductor 470 μ H	C65	CE04BW1H010M		E 1 μ F 50V
L29	L34-0966-05		Trap coil 8.83 MHz	C66	CE04W1H010M		E 1 μ F 50V
L30	L40-1511-03		Ferri-inductor 150 μ H	C68	CE04W1A101M		E 100 μ F 10V
L31	L40-2282-01		Ferri-inductor 0.22 μ H	C69, 70	CE04W1C100M		E 10 μ F 16V
L32	L40-1011-03		Ferri-inductor 100 μ H	C71	CE04W1HR47M		E 0.47 μ F 50V
L33	L40-4711-03		Ferri-inductor 470 μ H	C72	CE04W1H010M		E 1 μ F 50V
L34	L40-1511-03		Ferri-inductor 150 μ H	C73	CQ92M1H223K		ML 0.022 μ F
L35	L40-1011-03		Ferri-inductor 100 μ H	C74	CE04W1C100M		E 10 μ F 16V
L36	L40-3311-03		Ferri-inductor 330 μ H	C75, 76	CE04W1C470M		E 47 μ F 16V
L37	L79-0485-05	N	Coil block B 50 MHz	C77	CE04W1C221M		E 220 μ F 16V
L38	L79-0486-05	N	Coil block C 50 MHz	C78	CQ92M1H104K		ML 0.1 μ F
L39	L40-3392-02		Ferri-inductor 3.3 μ H	C79	CC45SL1H470J		C 47pF
L40	L40-1001-03		Ferri-inductor 10 μ H	C80	CC45SL1H101J		C 100pF
L41	L34-1021-05	N	Input coil	C84	CE04W1A470M		E 47 μ F 10V
L42	L33-0222-05		Choke coil	C85	CC45SL1H470J		C 47pF
L43	L34-1022-05	N	Output coil	C86	CE04W1H0R1M		E 0.1 μ F 50V
L44	L40-1001-03		Ferri-inductor 10 μ H	C87	CE04W1H010M		E 1 μ F 50V
L45	L40-4791-02		Ferri-inductor 4.7 μ H	C88	CE04W1HR22H		E 0.22 μ F 50V
L46	L33-0222-05		Choke coil	C90	CE04W1H010M		E 1 μ F 50V
L47	L40-2211-03		Ferri-inductor 220 μ H	C91	CE04W1C100M		E 10 μ F 16V
L49	L40-1511-03		Ferri-inductor 150 μ H				
L50	L40-4701-03		Ferri-inductor 47 μ H				

PARTS LIST

Ref. No.	Parts No.	Re- marks	Description	Ref. No.	Parts No.	Re- marks	Description
C92-94	CQ92M1H822K		ML 0.0082μF	VR6	R12-0421-05		Trim. pot 100Ω
C95	CQ92M1H104K		ML 0.1μF	VR7	R12-7403-05	N	Trim. pot 500kΩ
C96	CQ92M1H103K		ML 0.01μF 50V	VR8	R12-4408-05	N	Trim. pot 50kΩ
C97	CE04W1A470M		E 47μF 10V	VR9	R12-2409-05	N	Trim. pot 5kΩ
C98	CE04W1H4R7M		E 4.7μF 50V	VR10	R12-5408-05	N	Trim. pot 200kΩ
C99	CE04W1H010M		E 1μF 50V	VR11, 12	R12-2409-05	N	Trim. pot 5kΩ
C101	CE04W1HR47M		E 0.47μF 50V	VR13	R12-3430-05		Trim. pot 10kΩ
C102	CE04W1HR22M		E 0.22μF 50V		R92-0150-05		Short jumper x 60
C103	CE04BW1H010M		E 1μF 50V	RL1	S51-1410-05	N	Relay OUC-S-112D
C104	CE04W1C100M		E 10μF 16V	FM UNIT (X48-1340-00)			
C105	CE04W1H010M		E 1μF 50V	C1	CQ92M1H472K		ML 0.0047μF
C107	CE04W1H010M		E 1μF 50V	C2	CQ92M1H103K		ML 0.01μF
C109, 111	CE04W1H010M		E 1μF 50V	C3	CE04W1A470M		E 47μF 10V
C113, 115	C91-0456-05		C 0.047μF	C4	CE04W1A220M		E 22μF 10V
C114, 116	CE04W1C100M		E 10μF 16V	C5	CE04W1H010M		E 1μF 50V
C119, 120	C90-0817-05		E 1000μF	C6	CE04W1A470M		E 47μF 10V
C123-125	C90-0839-05		E 4.7μF 25V	C7	CQ92M1H103K		ML 0.01μF
C128	C91-0456-05		C 0.047μF	C8	CE04W1H010M		E 1μF 50V
TC1	C05-0031-15		Ceramic trimmer 10pF	C9	CQ92M1H393K		ML 0.039μF
TC2, 3	C05-0030-15		Ceramic trimmer 20pF	C10	CE04W1H010M		E 1μF 50V
	E23-0046-04		Square terminal	C11	CC45UJ1H070D		C 7pF
	E23-0512-05		Terminal x 4	C12, 14	CC45SL1H221J		C 220pF
	E29-0413-05		1P connector (female)	C15	CC45SL1H050C		C 5pF
	E40-0273-05		Mini connect wafer x 9 2P	C16	CC45SL1H220J		C 22pF
	E40-0373-05		Mini connect wafer x 2 3P	C22	CQ92M1H473K		ML 0.047μF
	E40-0473-05		Mini connect wafer x 4 4P	C23	CE04W1A220M		E 22μF 10V
	E40-0573-05		Mini connect wafer x 3 5P	C24	CQ92M1H103K		ML 0.01μF
	E40-0673-05		Mini connect wafer x 2 6P	C25	CQ92M1H473K		ML 0.047μF
	E40-0773-05		Mini connect wafer 7P	C26	CE04W1A3R3M		E 3.3μF 10V
	F20-0516-05		Insulating sheet	C29	CQ92M1H332K		ML 0.0033μF
	F29-0014-05		Shoulder washer	C30	CQ92M1H473K		ML 0.047μF
	J31-0502-04		PC board collar x 6	C31, 32	CE04W1H010M		E 1μF 50V
	J42-0428-05		PC board bushing x 6	C34	CC45SL1H121J		C 120pF
L1	L32-0201-05		OSC coil	C35	CC45SL1H560J		C 56pF
L2	L40-1511-03		Ferri-inductor 150μH	C37	CE04W1A101M		E 100μF 10V
L3	L40-2211-03		Ferri-inductor 220μH	C40	CC45SL1H120J		C 12pF
L4	L33-0636-05		Choke coil 28μH	C41	CC45SL1H220J		C 22pF
L5	L40-1511-03		Ferri-inductor 150μH	C49	CE04W1E4R7M		E 4.7μF 25V
L6	L34-0708-05		Tuning coil	C50	CQ92M1H103K		ML 0.01μF
L7	L34-0535-05		Tuning coil	C51	CC45SL1H150J		C 15pF
L8	L34-0536-05		Tuning coil	TC1	C05-0031-15		Ceramic trimmer 10pF
L9	L34-0567-05		Tuning coil		E40-0273-05		Mini connect wafer x 3 2P
L10	L34-0535-05		Tuning coil		E40-0773-05		Mini connect wafer 7P
L13	L40-1511-03		Ferri-inductor 150μH		J31-0502-04		PC board collar x 6
L14, 22	L40-4711-03		Ferri-inductor 470μH		J42-0428-05		PC board bushing x 6
L15, 16	L40-1511-03		Ferri-inductor 150μH	L1	L40-1541-27		Ferri-inductor 150mH
L17	L40-3391-03		Ferri-inductor 3.3μH	L2	L33-0640-05	N	Choke coil 12μH
L19	L15-0016-05		Choke trans	L3	L33-0639-05	N	Choke coil 10μH
XF1	L71-0208-05		MCF YK-88S	L4	L40-1511-03		Ferri-inductor 150μH
X1	L77-0485-05		Crystal 8.8315 MHz	L5	L40-6891-01		Ferri-inductor 6.8μH
	N10-2030-46		Nut x 5	T1	L34-0535-05		Tuning coil
	N30-3008-46		Round screw x 3	T2	L30-0503-05		Tuning coil
	N30-3010-46		Round screw x 2	T3	L30-0199-05		Tuning coil
VR1-3	R12-1414-05	N	Trim. pot 1kΩ	CF1	L72-0309-05		Ceramic filter CFT455F2
VR4	R12-7403-05	N	Trim. pot 500kΩ				
VR5	R12-3430-05	N	Trim. pot 10kΩ				

TS-660

PARTS LIST

Ref. No.	Parts No.	Re- marks	Description	Ref. No.	Parts No.	Re- marks	Description
X1	L77-0940-05	N	Crystal 8.8315 MHz	L8	L32-0639-05	N	OSC coil 50M
X2	L77-0939-05	N	Crystal 9.2865 MHz	L9	L40-4701-03		Ferri-inductor 47μH
VR1	R12-3430-05		Trim. pot 10kΩ (B)	L10	L40-1511-03		Ferri-inductor 150μH
VR2	R12-4408-05		Trim. pot 50kΩ (B)	L11	L40-4782-02		Ferri-inductor 0.47μH
VR3	R12-4410-05		Trim. pot 50kΩ (B)	L12, 13	L40-2282-01		Ferri-inductor 0.22μH
	R92-0150-05		Short jumper	L14	L40-4782-02		Ferri-inductor 0.47μH
PLL UNIT (X50-1740-00)				L15-18	L40-1511-03		Ferri-inductor 150μH
C1	CE04W1A220M		E 22μF 10V	L19-21	L40-1001-03		Ferri-inductor 10μH
C2	CC45UJ1H180J		C 18pF	L22	L40-2201-03		Ferri-inductor 22μH
C3	CC45UJ1H080D		C 8pF	L23	L40-1001-03		Ferri-inductor 10μH
C4	CC45TH1H150J		C 15pF	L24	L40-2201-03		Ferri-inductor 22μH
C5	CC45UJ1H100D		C 10pF	L25	L40-1021-03		Ferri-inductor 1000μH
C6	CC45UJ1H270J		C 27pF	L26-29	L40-4711-03		Ferri-inductor 470μH
C8	CE04W1A220M		E 22μF 10V	L30	L40-4791-02		Ferri-inductor 4.7μH
C10	CE04W1A470M		E 47μF 10V		R92-0150-05		Short jumper x 5
C11	CC45UJ1H270J		C 27pF	FILTER UNIT (X51-1260-00)			
C12	CC45TH1H220J		C 22pF	C1	CC45SL2H150J		C 15pF 500V
C13	CC45UJ1H070D		C 7pF	C2	CC45SL1H331J		C 330pF
C14	CC45UJ1H220J		C 22pF	C8	CC45SL2H070D		C 7pF 500V
C16	CE04W1A220M		E 22μF 10V	C9	CC45SL1H331J		C 330pF
C18	CC45UJ1H180J		C 18pF	C14	CE04W1HR47M		E 0.47μF 50V
C19	CC45TH1H150J		C 15pF	C15	CE04W1C100M		E 10μF 16V
C20	CC45UJ1H030C		C 3pF	C22	CC45SL2H390J		C 39pF 500V
C21	CC45UJ1H180J		C 18pF	C23, 25	CC45SL2H820J		C 82pF 500V
C23	CE04W1A220M		E 22μF 10V	C26	CC45SL2H390J		C 39pF 500V
C24	CC45CH1H070D		C 7pF	C27, 28	CC45SL2H470J		C 47pF 500V
C25	CC45CH1H050C		C 5pF	C31	CC45SL2H560J		C 56pF 500V
C29	C91-0457-05		C 0.022μF	C32	CC45SL2H151J		C 150pF 500V
C30	CC45SL1H101J		C 100pF	C33	CC45SL2H680J		C 68pF 500V
C31	CC45SL1H820J		C 82pF	C35	CC45SL2H820J		C 82pF 500V
C32	CC45SL1H101J		C 100pF	C37	CC45SL2H680J		C 68pF 500V
C33	CC45SL1H470J		C 47pF	C45	CC45SL2H470J		C 47pF 500V
C36	CC45CH1H050C		C 5pF	C46	CC45SL2H151J		C 150pF 500V
C37	CC45CH1H010C		C 1pF	C47	CC45SL2H121J		C 120pF 500V
C45	CC45SL1H100D		C 10pF	C49	CC45SL1H220J		C 22pF
C46, 47	CC45SL1H180J		C 18pF	C50	CC45SL1H330J		C 33pF
C48	CC45SL1H100D		C 10pF	C51	CC45SL1H101J		C 100pF
C49, 50	CC45SL1H180J		C 18pF	C52	CC45CH1H0R5C		C 0.5pF
C57	CQ92M1H104K	ML	0.1μF	C53	CC45CH1H020C		C 2pF
C59, 61	CE04W1A101M	E	100μF 10V	TC1	C05-0043-05		Ceramic trimmer 20pF
C66	CE04W1A470M	E	47μF 10V		E04-0157-05		Mini pin jack A x 3
C67	CE04W1H3R3M	E	3.3μF 50V		E23-0512-05		Terminal
C70	CC45SL1H330J	C	33pF		E40-0273-05		Mini connect wafer x 2 2P
C72	CC45SL1H150J	C	15pF		E40-0473-05		Mini connect wafer 4P
C73	CC45SL1H070D	C	7pF		E40-0573-05		Mini connect wafer 5P
	E23-0046-04		Square terminal x 2		J31-0502-04		PC board collar x 6
	E40-0273-05		Mini connect wafer x 3 2P		J42-0428-05		PC board bushing x 6
	E40-0373-05		Mini connect wafer 3P				
	E40-0473-05		Mini connect wafer x 2 4P	L1	L39-0410-15	N	Detector coil
	J31-0502-04		PC board collar x 3	L2, 3	L40-1511-03		Ferri-inductor 150μH
	J42-0428-05		PC board bushing x 3	L4	L33-0641-05	N	Choke coil 47μH
L1	L40-1511-03		Ferri-inductor 150μH	L6	L33-0641-05	N	Choke coil 47μH
L2	L40-4711-03		Ferri-inductor 470μH	L7	L34-3002-05	N	Filter coil
L3	L32-0197-05		OSC coil 21M	L8	L34-3003-05	N	Filter coil
L5	L40-1511-03		Ferri-inductor 150μH	L9	L34-3004-05	N	Filter coil
L6	L32-0198-05		OSC coil 28M	L10	L34-3005-05	N	Filter coil
L7	L40-1011-03		Ferri-inductor 100μH	L11	L34-0830-05		Filter coil
				L12	L34-3006-05	N	Filter coil
				L13	L34-0830-05		Filter coil

PARTS LIST

Ref. No.	Parts No.	Re- marks	Description	Ref. No.	Parts No.	Re- marks	Description
L14	L34-3007-05	N	Filter coil	C108, 109	CC45RH1H221J	C	220pF
L15	L34-3008-05	N	Filter coil	C110	CC45CH1H070D	C	7pF
L16	L33-0641-05	N	Choke coil 47μH	C112	C91-0456-05	C	0.047μF
L17, 18	L40-1511-03		Ferri-inductor 150μH	C114	CC45CH1H220J	C	22pF
R11, 12	RS14AB3A181J		Metal film 180Ω 1W	C117	CE04W1A101M	E	100μF 10V
R13	RS14AB3A470J		Metal film 47Ω 1W	C118	C91-0456-05	C	0.047μF
VR1, 2	R12-4016-05		Trim. pot 50kΩ (B)	C119	CQ92M1H822K	ML	0.0082μF
	R92-0150-05		Short jumper x 17	C120	CQ92M1H183K	ML	0.018μF
RL1-6	S51-1409-05	N	Relay	C121	CQ92M1H822K	ML	0.0082μF
CONTROL UNIT (X53-1220-00)				C122, 125, 126, 128	C91-0456-05	C	0.047μF
C1, 2	CE04W1H010M		E 1μF 50V	C129	CC45RH1H470J	C	47pF
C4	CE04W1A470M		E 47μF 10V	C130	CC45CH1H030C	C	3pF
C5	CE04W1H010M		E 1μF 50V	C131	CC45RH1H470J	C	47pF
C6	CC45CH1H560J		C 56pF	C132	CC45UJ1H180J	C	18pF
C7	CC45CH1H330J		C 33pF	C133, 134	CC45SL1H221J	C	220pF
C8	CC45SL1H271J		C 270pF	C135, 136	CC45CH1H100D	C	10pF
C10	CC45CH1H150J		C 15pF	C137	C91-0456-05	C	0.047μF
C14	CC45SL1H101J		C 100pF	C138	CC45SL1H150J	C	15pF
C15	CC45RH1H121J		C 120pF	C140	CC45RH1H330J	C	33pF
C16	CC45CH1H010C		C 1pF	C141	CC45CH1H020C	C	2pF
C17	CC45RH1H121J		C 120pF	C142	CC45RH1H330J	C	33pF
C19	CC45CH1H100D		C 10pF	C143	CC45SL1H101J	C	100pF
C20	CC45CH1H150J		C 15pF	C149	C91-0457-05	C	0.022μF
C22	CC45RH1H120J		C 12pF	C151	CE04W1A100M	E	10μF 10V
C31	CC45RH1H270J		C 27pF	C154, 156	CE04W1A101M	E	100μF 10V
C32	CC45RH1H070D		C 7pF	C157-159	C91-0456-05	C	0.047μF
C33	CC45RH1H270J		C 27pF	C164	C90-0840-05	C	10μF 16V
C36	CC45RH1H120J		C 12pF	C165	CC45SL1H151J	C	150pF
C37	CC45RH1H030C		C 3pF	TC1	C05-0309-05		Ceramic trimmer 40pF
C38	CC45RH1H120J		C 12pF	TC2, 3	C05-0067-05		Ceramic trimmer 25pF
C41	C91-0457-05		C 0.022μF		E40-0273-05		Mini connect wafer x 4 2P
C43	CE04W1A101M		E 100μF 10V		E40-0373-05		Mini connect wafer x 5 3P
C45	CQ92M1H102K		ML 0.001μF		E40-0473-05		Mini connect wafer x 7 4P
C46	CQ92M1H104K		ML 0.1μF		E40-0573-05		Mini connect wafer x 2 5P
C47	C91-0457-05		C 0.022μF		E40-0673-05		Mini connect wafer 6P
C48	CC45TH1H100D		C 10pF		E40-0773-05		Mini connect wafer x 2 7P
C49, 50	CC45TH1H101J		C 100pF		G11-0605-04		Cushion
C52	CE04W1A101M		E 100μF 10V		J31-0502-04		PC board collar x 7
C53	CC45CH1H050C		C 5pF		J42-0428-05		PC board bushing x 7
C54	CC45CH1H150J		C 15pF	L1, 2	L34-0996-15		Tuning coil 4M
C55, 56	CC45CH1H270J		C 27pF	L3	L34-0710-05		Tuning coil 32M
C58	CC45CH1H220J		C 22pF	L4	L34-2018-05	N	Tuning coil 19M BPF
C66-68	CC45RH1H560J		C 56pF	L5	L34-2019-05	N	Tuning coil 19M BPF
C76	CC45SL1H820J		C 82pF	L6	L34-2018-05	N	Tuning coil 19M BPF
C77, 78	CC45SL1H151J		C 150pF	L7	L34-2020-05	N	Tuning coil 47M BPF
C79	CC45SL1H820J		C 82pF	L8	L34-2023-05	N	Tuning coil 15M BPF
C80, 82	CC45SL1H101J		C 100pF	L9	L34-2020-05	N	Tuning coil 47M BPF
C86	CE04W1A101M		E 100μF 10V	L11	L40-3301-03		Ferri-inductor 33μH
C87	CC45CH1H270J		C 27pF	L12	L40-4711-07		Ferri-inductor 470μH
C88	CC45SL1H101J		C 100pF	L13	L32-0636-05		OSC coil
C90	CC45CH1H030C		C 3pF	L14	L40-5691-02		Ferri-inductor 5.6μH
C98	CE04W1A101M		E 100μF 10V	L15	L40-4711-03		Ferri-inductor 470μH
C100	CQ92M1H104K		ML 0.1μF	L16	L34-2022-05	N	Tuning coil 15M BPF
C101	CQ92M1H222K		ML 0.0022μF	L17	L34-2023-05	N	Tuning coil 15M BPF
C101	CE04W1H3R3M		E 3.3μF 50V	L18	L34-2022-05	N	Tuning coil 15M BPF
C104	C91-0455-05		C 0.01μF	L19-21	L40-6801-03		Ferri-inductor 68μH
C105, 106	CC45RH1H221J		C 220pF	L22	L40-1021-03		Ferri-inductor 1mH
C107	CC45RH1H680J		C 68pF	L23, 24	L40-4711-03		Ferri-inductor 470μH

TS-660

PARTS LIST

Ref. No.	Parts No.	Re- marks	Description	Ref. No.	Parts No.	Re- marks	Description
L25	L40-1511-03		Ferri-inductor 150 μ H		E23-0046-04		Square terminal x 2
L26	L32-0640-05	N	OSC coil		E23-0401-05		Round terminal
L27	L40-4711-03		Ferri-inductor 470 μ H		E23-0512-05		Terminal
L28, 29	L40-3325-04		Ferri-inductor 3.3mH		F01-0761-03	N	Heat sink A
L30, 31	L34-2024-05	N	Tuning coil 8M		F20-0078-05		Insulating board
L32	L40-4711-03		Ferri-inductor 470 μ H		J31-0505-04		Spacer x 6
L33	L33-0636-05		Choke coil 28 μ H	L1, 2	L33-0025-05		RFC 1 μ H
L34, 35	L34-0845-05		Tuning coil 8M	L3	L33-0617-05		RFC
L36	L40-4711-03		Ferri-inductor 470 μ H	L4	L33-0025-05		RFC 1 μ H
L37	L40-1511-03		Ferri-inductor 150 μ H	T1	L19-0315-25		Wide bandwidth trans
L38	L40-1011-04		Ferri-inductor 100 μ H	T2	L19-0325-05	N	Matching trans (A)
L39	L40-4711-03		Ferri-inductor 470 μ H	T3	L19-0326-05	N	Matching trans (B)
X1	L77-0941-05	N	Crystal 16M	T4	L19-0327-05	N	Output trans
X2	L77-0942-05	N	Crystal 8.7315M		N30-2606-46		Round screw
X3	L77-0943-05	N	Crystal 8M		N87-3006-46		Self tapping screw x 4
XF1	L71-0213-05		MCF 7.975M		N87-3010-46		Self tapping screw x 6
RB1-3	R90-0515-05		Resistor block 10k Ω x 4	R9	R92-0601-05		Cement resistor 0.22 Ω
VR1	R12-6401-05		Trim. pot 470k Ω	VR1	R12-1422-05		Trim. pot 1.5k Ω
VR3	R12-1416-05		Trim. pot 4.7k Ω	VR2	R12-0408-05		Trim. pot 100 Ω
	R92-0150-05		Short jumper x 101		R92-0150-05		Short jumper x 3
BZ1	T95-0051-05		Buzzer	ENCODER ASS'Y UNIT (X60-1170-00)			
DISPLAY UNIT (X54-1630-00)					D09-0304-04	N	Encoder slit
C1	CE04W1A470M		E 47 μ F 10V		D21-0818-05	N	Shaft ass'y
C2	CE04W0J221M		E 220 μ F 6.3V		N30-3006-46		Round screw x 4
C3	CE04W1V100M		E 10 μ F 35V		N89-3005-46		Bind tap tight screw x 3
C4	CQ92M1H103K		ML 0.01 μ F		X54-1640-00	N	Encoder unit
C5-7	CE04W1V100M		E 10 μ F 35V	ENCODER UNIT (X54-1640-00)			
C8	C91-0456-05		C 0.047 μ F	C1	CE04W1A470M		E 47 μ F 10V
	E40-0273-05		Mini connect wafer 2P		E40-0474-05		Mini connect wafer 4P
	E40-0473-05		Mini connect wafer 4P		G02-0519-04		Spring plate
	E40-0773-05		Mini connect wafer x 2 7P		J19-1342-04		Sensor mounting hardware (A)
L1	L40-1011-04		Ferri-inductor 100 μ H		J19-1343-04		Sensor mounting hardware (B)
L2	L40-1511-03		Ferri-inductor 150 μ H		N32-3020-46		Flat screw
T1	L19-0305-05		OSC transformer	VR1, 2	R12-2410-05	N	Trim. pot 5k Ω (B)
	N30-3006-46		Round screw x 6	Note : Encoder unit (X54-1640-00) is not available. Please order complete Encoder ASS'Y (X60-1170-00).			
RB1, 2	R90-0521-05		Resistor block 47k Ω x 7				
	R92-0150-05		Short jumper x 5				
FINAL UNIT (X56-1410-00)							
C1	CC45SL1H220J		C 22pF				
C6	CC45SL1H820J		C 82pF				
C9	CE04W1C221M		E 220 μ F 16V				
C11	CC45SL2H820J		C 82pF 500V				
C16, 20	CE04W1C100M		E 10 μ F 16V				
C26	CC45SL2H101J		C 100pF 500V				
TC1	C05-0043-05		Ceramic trimmer 20pF				
	E04-0157-05	N	Mini pin jack A x 2				

DISASSEMBLY

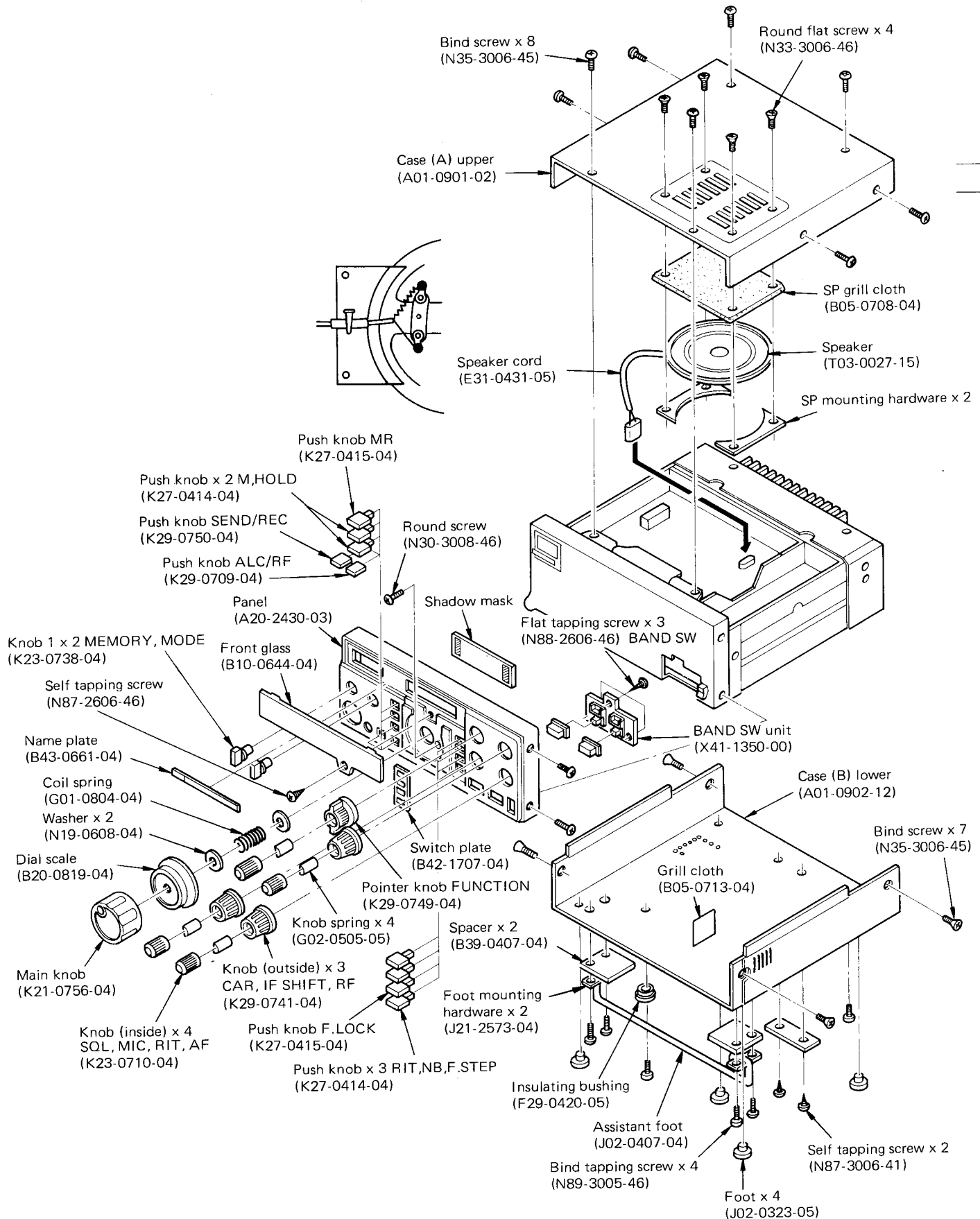

TS-660

DISASSEMBLY

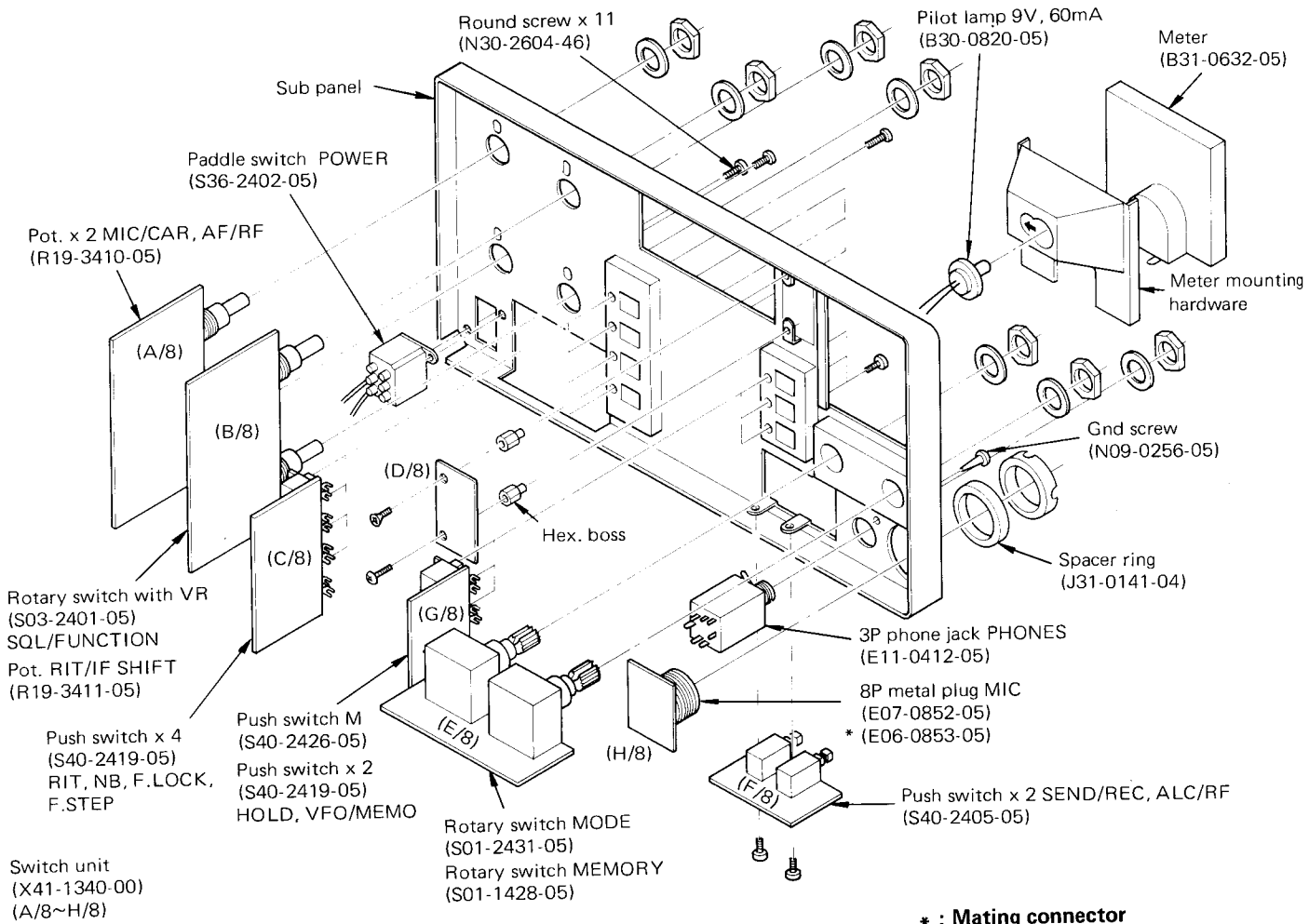

* : Mating connector

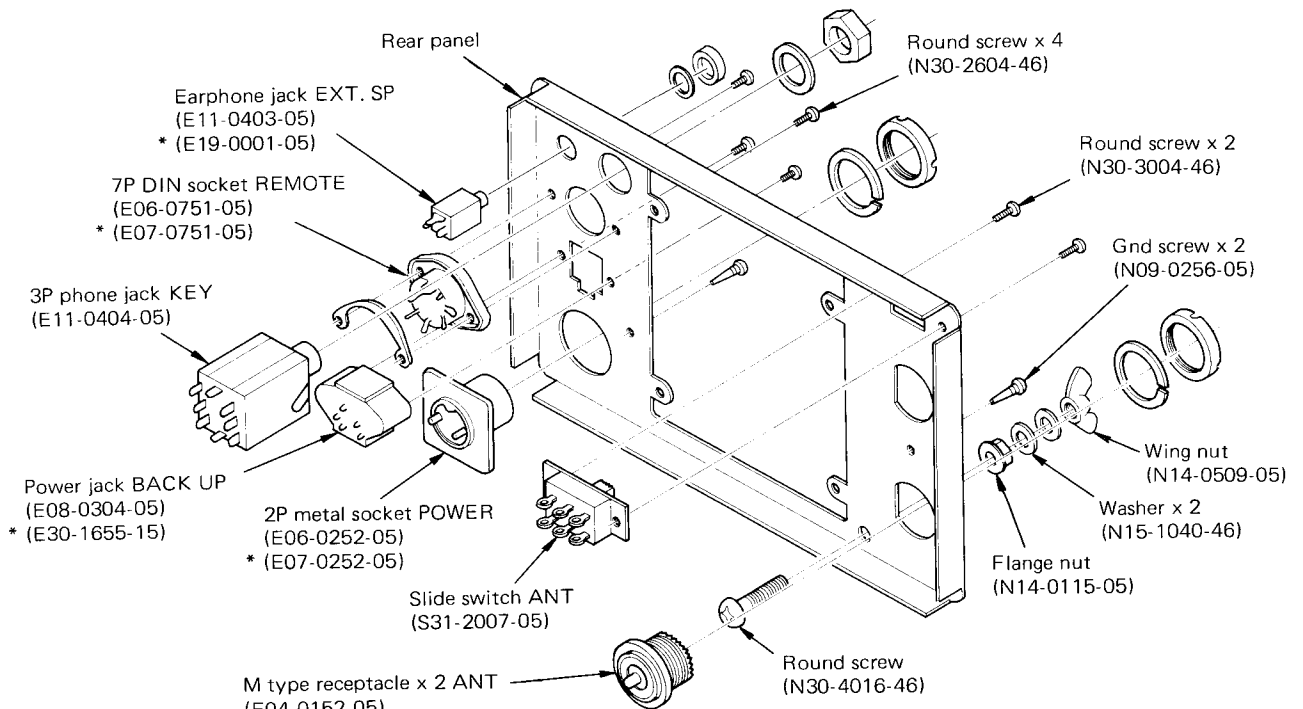

LEVEL DIAGRAM

RECEIVER SECTION (21, 50MHz BAND SSB)

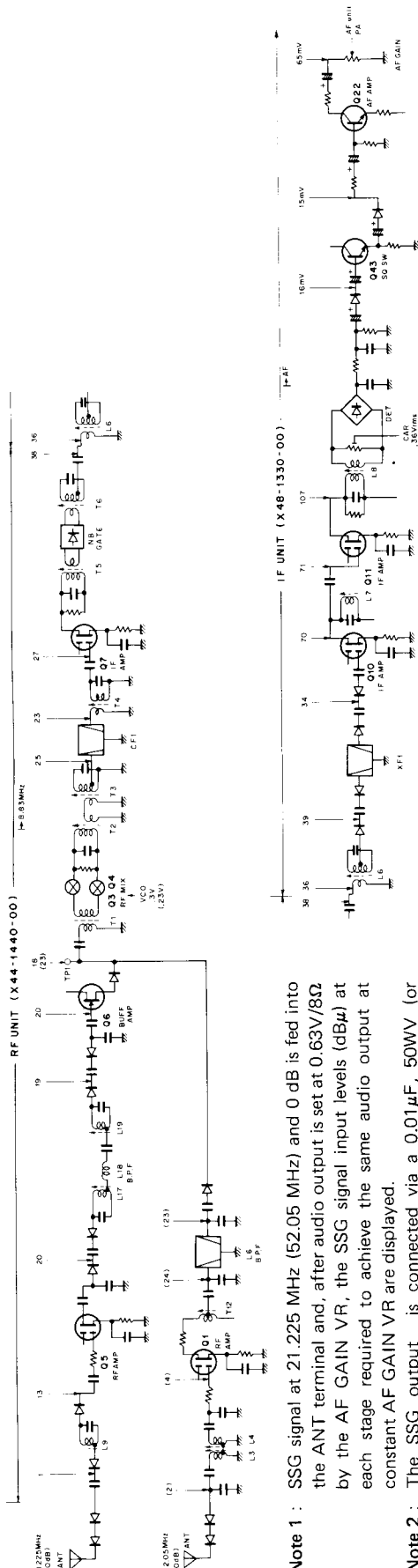

Note 1 : SSG signal at 21.225 MHz (52.05 MHz) and 0 dB is fed into the ANT terminal and, after audio output is set at 0.63V/8 Ω by the AF GAIN VR, the SSG signal input levels (dB μ) at each stage required to achieve the same audio output at constant AF GAIN VR are displayed.

Note 2 : The SSG output is connected via a 0.01 μ F, 50WV (or Greater) capacitor.

RECEIVER SECTION (50MHz BAND FM)

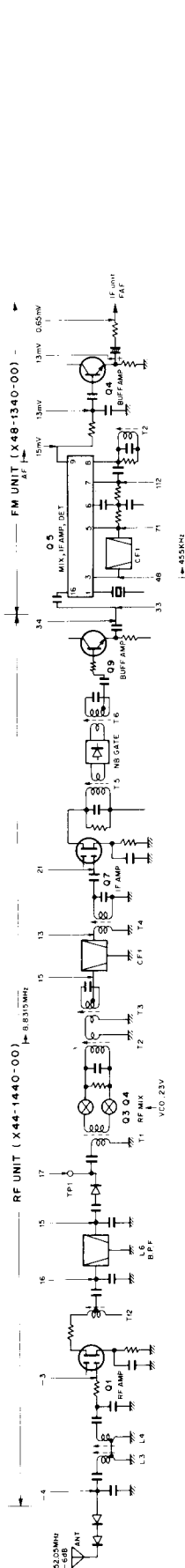

Note 1 : SSG unmodulated signal at 52.05 MHz and -6 dB is fed to the ANT terminal, and the SSG signal input levels (dB μ) required to achieve 20 dB noise quieting in the FM mode.

Note 2 : The SSG output is connected via a 0.01 μ F, 50WV (or Greater) capacitor.

TRANSMITTER SECTION (21, 50MHz BAND CW)

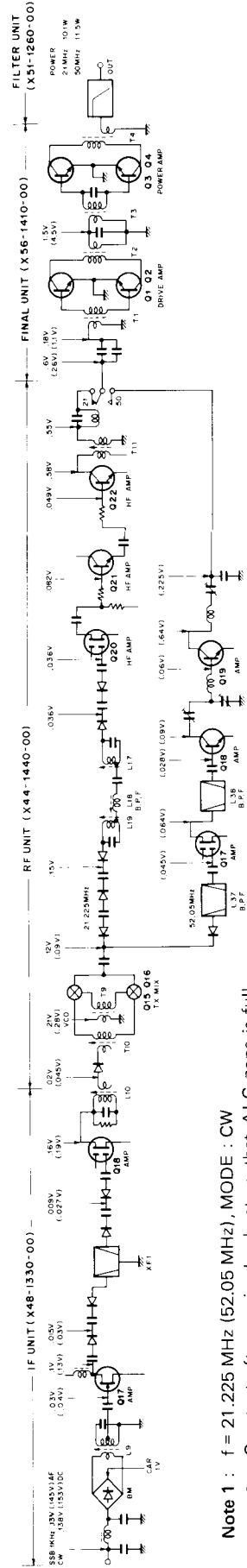

Note 1 : f = 21.225 MHz (52.05 MHz), MODE : CW

Note 2 : Constant after carrier level set so that ALC zone is full scale.

Note 3 : Measurement is made by a P type variable volume, a probe with a input capacity of 3pF or less is used and the ground point is near the extreme measuring point.

ADJUSTMENT

REQUIRED TEST EQUIPMENT

1. DC Voltmeter

- 1) Input resistance : More than 1 M Ω
- 2) Voltage range : 1.5 to 1000V AC/DC

NOTE : A high-precision multimeter may be used. However, accurate readings can not be obtained for high-impedance circuits.

2. DC Ammeter

- 1) Current range : 150 mA, 500 mA, 2A, 10A, High-precision ammeter may be used.

3. RF VTVM

- 1) Input impedance : 1M Ω and less than 3pF, min.
- 2) Voltage range : 10 mV to 300V
- 3) Frequency range : 10 kHz~100 MHz or greater

4. AF Voltmeter

- 1) Frequency range : 50 Hz to 10 kHz
- 2) Input resistance : 1M Ω or greater
- 3) Voltage range : 10 mV to 30 V

5. AF Generator (AG)

- 1) Frequency range : 200 Hz to 5 kHz
- 2) Output : 1mV or less ~1V, low distortion

6. AF Dummy Load

- 1) Impedance : 8 Ω
- 2) Dissipation : 3W or greater

7. Oscilloscope

Requires high sensitivity, and external synchronization capability.

8. Sweep Generator

- 1) Center frequency : 5 MHz~60 MHz
- 2) Frequency deviation : Maximum \pm 16 MHz
- 3) Output voltage : 0.1 V or greater
- 4) Sweep rate : At least 0.5sec/cm

9. Standard Signal Generator (SSG)

- 1) Frequency range : 8 to 60 MHz
- 2) Output : -20 dB/0.1 μ V~120 dB/1V
- 3) Output impedance : 50 Ω
- 4) AM and FM modulation can be possible.

NOTE : Generator must be frequency stable.

10. Frequency Counter

- 1) Minimum input voltage : 50 mV
- 2) Frequency range : 60 MHz or greater

11. Noise Generator

Must generate ignition noise containing harmonics beyond 60 MHz.

12. Power Meter

- 1) Impedance : 50 Ω
- 2) Dissipation : 15W continuous or greater
- 3) Frequency limits : 60 MHz or greater

13. Spectrum Analyzer

- 1) Frequency range : 100 K to 110 MHz or greater
- 2) Bandwidth : 1 kHz to 3 MHz

14. Detector

- 1) For adjustment of TX BPF

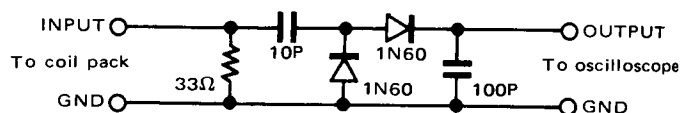

- 2) For adjustment of PLL BPF

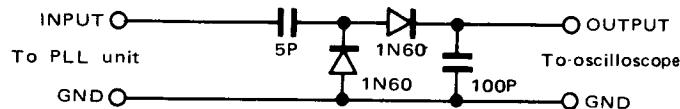

15. Directional Coupler

16. Power supply

13.8 V DC. Min 4A

PREPARATION

Unless otherwise specified, set the controls as follows.

POWER..... ON	RIT SW..... OFF
BAND 50	NB..... OFF
AF MIN	F.LOCK OFF
RF MAX	F.STEP OFF
MIC MIN	VFO/MEMO VFO
CAR MIN	HOLD OFF
FUNCTION..... A	SEND/REC REC
RIT CEN	MEMORY 3
IF SHIFT CEN	MODE SSB
SQL MIN	ALC/RF RF

The output level of SSG is indicated as SSG's open circuit.

ADJUSTMENT

VOLTAGE ADJUSTMENTS

Item	Condition	Measurement			Adjustment			Specification	Remarks
		Test equipment	Unit	Terminal	Unit	Parts	Method		
Voltage adjustment and confirmation	POWER : ON RF GAIN : MAX MODE : SSB STBY : REC	DC V.M	IF	9V				8.55~9.45V	Confirm
				-6V				-5.9~-6.1V	Confirm
				5V				4.75~5.25V	Confirm
				RFG	SW	VR3	3.3V	±0.1V	
				RXB				8.0~9.0V	Confirm
				RB				about 1.5V	Confirm
				TBL				about -5.9V	Confirm
				TXB				0V	Confirm
				TXB	IF	VR12	8.8V	±0.1V ON AIR IND lights	
	RXB				0V	Confirm			
	RB				about -1.4V	Confirm			
	TBL				0.75V	Confirm			
	STBY : SEND						ON AIR IND goes off	Confirm	
STBY : REC									

PLL ADJUSTMENTS

Item	Condition	Measurement			Adjustment			Specification	Remarks			
		Test equipment	Unit	Terminal	Unit	Parts	Method					
1. Adjustment of standard oscillation	1) RIT : OFF RIT VR : CENTER	f. counter	Control	D48 cathode	Control	TC1	8,000,000 Hz	±3 Hz				
	2) RIT : ON					TC3		±50 Hz	RIT IND lights			
	3) RIT : Turn full CW, then full CCW.							±1 kHz or more	Confirm			
	4) RIT : OFF											RIT IND goes off
	5) MODE : CW ANT : DUMMY LOAD STBY : SEND								VR3	8,000,800 Hz	±50 Hz	
	6) STBY : REC											
	7) MODE : FM						D39 cathode	Control	TC2	8,731,500 Hz	±50 Hz	
	8) MODE : AM										±200 Hz	Confirm
2. VCO-1	1) MODE : SSB Display : 51.000.0	DC V.M	Control	TP1	Control	L26	7.0V	±0.1V				
	2) Display : 50.999.9								2.4±0.5V	Confirm		
3. VCO-2	1) MODE : SSB Display : 51.000.0	DC V.M	Control	TP4	Control	L13	2.3V	±0.1V				
	2) Display : 50.999.9								6.0±1.0V	Confirm		
	3) Display : 51.000.0 ↓ 51.009.9	f. counter		TP2				6.000 MHz 2 kHz Steps. 4.002 MHz	This item is confirmed also after adjustment of item 2, VCO-1.			
4. VCO-3-1	1) BAND : 21 Display : 21.999.9	DC V.M	PLL	TP1	PLL	L3	6.5V	±0.1V				
	2) BAND : 24 Display : 24.999.9								6.0 +0.5V -1.0V	Confirm		

TS-660

ADJUSTMENT

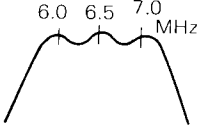
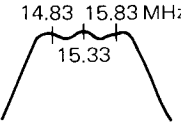
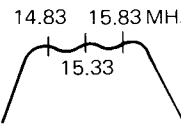
Item	Condition	Measurement			Adjustment		Specification	Remarks	
		Test equipment	Unit	Terminal	Unit	Parts			Method
	4) BAND : 21 Display : 21.000.0						2.5±0.5V		
5. VCO-3-2	1) BAND : 28 Display : 29.999.8	RF V.M	PLL	TP1		L6	1.9V	±0.1V	
	2) Display : 28.000.0							5.0±0.5V	Confirm
6. VCO-3-3	1) BAND : 50 Display : 53.999.9	RF V.M	PLL	TP1		L8	7.7V	±0.1V	
	2) Display : 50.000.0							3.0±0.5V	Confirm
7. VCO output check	1) BAND : 21~50 Display : 1.500.0	RF V.M	PLL	TP2				0.63V +3dB -2dB	Confirm
8. BPF-1	1) MODE : SSB or CW Ground TP4 of control unit. Connect sweep GEN. RF output to control unit TP5.	Sweep generator Oscilloscope Detector	Control	Jumper wire on right of C6	Control	L16~18	Adjust as shown at right.		
9. BPF-2	1) MODE : SSB or CW BAND : 21 or 24	RF V.M	Control	D27 cathode	Control	L1,2	MAX.		
	2) Remove control unit connector (1). Connect sweep GEN. RF output to jumper wire at right of C69 on control unit.	Sweep generator Oscilloscope Detector		Connector (1)		L4~6	Adjust as shown at right.		
10. BPF-3	1) MODE : SSB or CW BAND : 28 or 50	RF V.M	Control	D28 cathode	Control	L3	MAX.		
	2) Remove control unit connector (1). Connect sweep GEN. RF output to jumper wire at right of C69 on control unit.	Sweep generator Oscilloscope Detector		Connector (1)		L7~9	Adjust as shown at right.		
11. BPF-4		RF V.M	Control	IC11 5 PIN	Control	L30,31	MAX.		
12. BPF-5	1) RIT : OFF	RF V.M	Control	D48 cathode	Control	L34,35	MAX.		
13. MIX Balance		Spectrum analyzer	Control	Jumper wire at right of C69	Control	VR1	Adjust for minimum adjacent spurious response.		

ADJUSTMENT

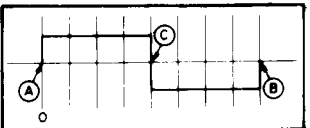
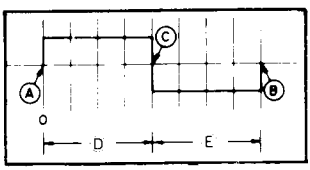
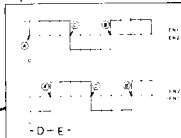
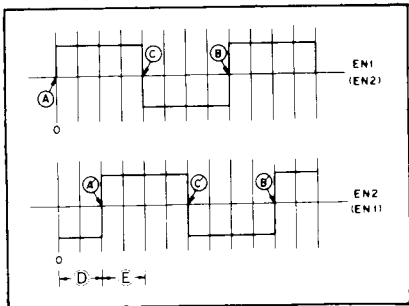
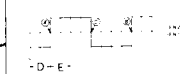
Item	Condition	Measurement			Adjustment			Specification	Remarks	
		Test equipment	Unit	Terminal	Unit	Parts	Method			
14. Encoder adjustment	1) Remove the VFO knob and motor-drive the encoder at approx 300 rpm.	Oscilloscope	Digital	Connector ② EN1 terminal	Encoder	VR1		Point C may be located anywhere. When a motor is not available, manually turn the VFO to check the duty ratio.		
	2) EN1 duty ratio adjustment : Turn a motor CW and CCW						After adjusting with the VFO control turned CW, check that intervals D and E are also identical when the VFO control is turned CCW.			
	3) EN2 duty ratio adjustment : Turn a motor in the both direction.			Connector ② EN2 terminal					VR2	Adjust until intervals D and E are equal to each other with point C placed at the center.
	4) EN1-EN2 phase difference alignment : Same as above.			Connector ② EN1 and EN2 terminals					Phase adjustment screw	
					Adjust until intervals D and E are equal to each other (point A' on EN2 is located in the middle of points A and C on EN1.)					

RX ADJUSTMENTS

Item	Condition	Measurement			Adjustment			Specification	Remarks
		Test equipment	Unit	Terminal	Unit	Parts	Method		
1. CAR level and frequency	1) MODE : SSB IF SHIFT : CEN.	RF V.M	IF	CAR	IF	L1	0.26V Adjust CCW from peak turn slug OUT.		
		f. counter				TC1	8,831,500 Hz	±50 Hz	
							8,831,500 Hz		
							Stopped		
							Stopped		
						VR2	8,831,500 Hz	±10 Hz	
						VR1	8,830,700 Hz		
								8,831,500 Hz	
							Stopped		
9) MODE : CW STBY : REC IF SHIFT : Turn full CW, and CCW.			Center frequency is standard	±900 Hz or more					

TS-660

ADJUSTMENT

Item	Condition	Measurement			Adjustment			Specification	Remarks
		Test equipment	Unit	Terminal	Unit	Parts	Method		
2. 50 MHz BPF	1) BAND : 50 ANT SW : 21~50 Remove connector ⑤ (VCO input). Connect RF output of sweep GEN. to ANT terminal.	Sweep generator Oscilloscope Detector	RF	TP1	RF	L3,4 L6 T12			
3. IF	1) BAND : 52 VFO : 52.100.0 MODE : SSB 2) MODE : FM	SSG		EXT.SP	RF	VR1 T2~6	MAX.	Must be 1V/8Ω or more at maximum AF gain with SSG output of -6dB.	
					IF	L6~8			
4. HF ANT Coil	1) BAND : 21 VFO : 21.225.0	SSG AF VM AF DUMMY LOAD Oscilloscope		EXT.SP	RF	L9	MAX.		
	2) BAND : 24 VFO : 24.920.0				L10				
	3) BAND : 28 VFO : 28.800.0				L11				
5. RX carrier balance	1) IF SHIFT VR : CEN. RF GAIN : Turn full CCW. BAND : 52	RF V.M	IF	TP	IF	VR3 TC3	MIN. Adjust by repeating alternately. Sufficient when RF V.M reads minimum in the 0.03V range.	(0.01V or less)	
6. S Meter	1) BAND : 52 VFO : 52.100.0 RF GAIN : Turn full CW. IF SHIFT : CEN. MODE : CW	SSG S-Meter			IF	VR5	Shut off SSG output. Adjust to mechanical φ point.		
	2) SSG output 6 dB				L7	S-1 adjust CCW from peak. (turn slug OUT).	6 dB±4 dB		
	3) SSG output 20 dB				VR4	S-9	20 dB±6 dB		
	4) MODE : FM SSG output : 30 dB				FM IF	VR2	Full scale		
7. SQ	1) SQ : 12 O'clock MODE : CW	SP.		EXT.SP	IF	VR11	Adjust VR slowly and stop at threshold.		
8. IF trap.	1) BAND : 21 SSG output : 8.830 MHz 80dB	SSG AF V.M AF DUMMY LOAD Oscilloscope		EXT.SP	RF	L29	MIN.	70 dB or more	
9. Noise Blanker	1) BAND : 52 NB : ON SSG output : 52.1 MHz	SSG DC V.M	RF	TP2	RF	T7,8	MIN. (First adjust SSG output to 60 dB, then using the minimum input as possible.)		

ADJUSTMENT

Item	Condition	Measurement			Adjustment			Specification	Remarks
		Test equipment	Unit	Terminal	Unit	Parts	Method		
	2) Connect noise generator output to ANT terminal.	Noise generator			RF	T5	Adjust in core removal direction to effective position at low input level.	Must be effective at large and small outputs.	

TX ADJUSTMENTS

Item	Condition	Measurement			Adjustment			Specification	Remarks
		Test equipment	Unit	Terminal	Unit	Parts	Method		
1. Base idle current	1) Remove DRV connector from RF unit. STBY : SEND	DC A.M	Final	A	Final	VR1	If adjustment to 300 mA is not possible, 200 mA or more at position where reduced about 10 mA from about 10 mA from VR MAX.	300 mA. (200~300 mA)	Remove jumper between A and B
	2) Reconnect DRV connector STBY : REC			B		VR2	Resolder A to B	100 mA	NOTE : First turn power supply off.
2. 50 MHz TX. BPF	1) BAND : 50 Store the following frequencies in memory ① 50.000.0 ② 52.000.0 ③ 53.999.9 VFO/MEMO : MEMO CAR VR : Full CW. Remove connector ⑤ and attach sweep GEN. STBY : SEND	Sweep generator Oscilloscope Detector Power meter Directional coupler		ANT (Directional coupler)	RF	TC1~3 T10	First, connect connector ⑤ and obtain peak at 52M. * There is a 52M marker output at MEMORY 2.		
	Final				TC1				
	2) STBY : REC VFO/MEMO : VFO Reinstall connector ⑤				RF	L37,38 TC1~3	Adjust as shown at right. When adjusting TC1,2,3 tune so that curve is raised to 52M.		1) Adjust at minimum inputs as possible. 2) Use MEMORY as marker.
3. 21 MHz BPF. (Common with RX)	1) BAND : 21 Store the following frequencies in memory ① 21.000.0 ② 21.225.0 ③ 21.450.0 VFO/MEMO : MEMO CAR VR : Full CW Remove connector ⑤ and attach sweep GEN. STBY : SEND	Sweep generator Oscilloscope Detector Power meter Directional coupler		ANT (Directional coupler)	RF	L17~19	Adjust as shown at right.		1) Adjust using the minimum input possible. 2) Use MEMORY as marker.

TS-660

ADJUSTMENT

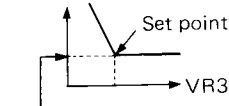
Item	Condition	Measurement			Adjustment			Specification	Remarks					
		Test equipment	Unit	Terminal	Unit	Parts	Method							
13. Deviation	1) BAND : 50 or 28 MODE : FM AG : 20 mV 1 kHz MIC connector Pins ① and ② STBY : SEND	Linear detector Power meter Directional coupler AG		ANT (Directional coupler)	FM,IF	VR1	5 kHz							
	2) AG : 2 mV												3.5 kHz or less	Confirm
	3) STBY : REC													
14. FM.CAR	1) BAND : 50 or 28 MODE : FM STBY : SEND	f.counter	FM,IF	D2 cathode	FM,IF	TC1	8.831.500 Hz	±100 Hz						
15. Side tone	1) MODE : CW AF GAIN : 12 O'clock KEY jack : KEY STBY : SEND	Power meter Oscilloscope AF V.M AF DUMMY LOAD		EXT.SP	IF	VR8	KEY DOWN	0.63V/8Ω	Must be no distortions at 800 Hz level.					
	2) STBY : REC									VR10	KEY DOWN	Confirm to change time to return to RX. Then set to center.		
	3) Remove KEY													
16. ALC,RF meter	1) MODE : SSB MIC GAIN : Full CCW Meter : ALC BAND : 21 STBY : SEND	Power meter Oscilloscope AF V.M AF DUMMY LOAD			IF	VR13	Adjust to mechanical φ point.	Meter reading  Mechanical φ point						
	2) MIC GAIN : Set S scale at S-1. MIC : AG (5 mV, 1.5 kHz)									VR7	1) Raise AG output 3 dB from 5 mV. 2) Adjust to ALC zone maximum.			
	3) Meter SW : RF									VR9	Adjust to S-8.			
	4) STBY : REC													

ADJUSTMENT

Micro-processor operational check

Item	Conditions	Specification
1. BAND	1) Power source connector: connect plug (13.8V) POWER SW : ON	With POWER SW ON, a tone is heard and meter lamps and display tube lights. (50.000.0)
	BAND : Push UP button once.	51.000.0 is displayed and tone is heard.
	Push UP button continuously	24.000.0→28.000.0→29.000.0→50.000.0 21.000.0→53.000.0→52.000.0→51.000.0 Continuous display and simultaneous tones.
	BAND : Push DOWN button once.	Display frequency decreases by 1 and simultaneously tone sounds.
	Push DOWN button continuously	Continuous display in reverse of UP and simultaneous tones heard.
2. FUNCTION	1) ANT : 21-28, 50 Two connections POWER meter FUNCTION : A, B, B-R, A-R MODE : SSB	STBY : REC→SEND→REC A : $\overset{\curvearrowright}{\rightarrow}$ → $\overset{\curvearrowright}{\rightarrow}$ → $\overset{\curvearrowright}{\rightarrow}$ B : $\overset{\curvearrowleft}{\leftarrow}$ → $\overset{\curvearrowleft}{\leftarrow}$ → $\overset{\curvearrowleft}{\leftarrow}$ B-R : $\overset{\curvearrowleft}{\leftarrow}$ → $\overset{\curvearrowright}{\rightarrow}$ → $\overset{\curvearrowleft}{\leftarrow}$ A-R : $\overset{\curvearrowright}{\rightarrow}$ → $\overset{\curvearrowleft}{\leftarrow}$ → $\overset{\curvearrowright}{\rightarrow}$
	3. F.STEP	Frequency changes at one VFO turn, frequency increases CW, decreases CCW.
4. MEMORY read-in	1) F.STEP : OFF MODE : SSB-CW-AM	10 kHz change by one turn of VFO knob.
	2) F.STEP : ON	100 kHz change. IND lamp is lit simultaneously.
	3) MODE : FM	100 kHz change.
	4) F.STEP : OFF	About 500 kHz change, IND lamp extinguished.
4. MEMORY read-in	1) BAND : 21 MEMORY : 1 M : ON	The tone sounds.
	2) BAND : 24 MEMORY : 2 M : ON	The tone sounds.
	3) BAND : 28 MEMORY : 3 M : ON	The tone sounds.

Item	Conditions	Specification
	4) BAND : 29 MEMORY : 4 M : ON	The tone sounds.
	5) BAND : 50 MEMORY : 5 M : ON	The tone sounds.
5. MEMORY Call	1) BAND : 51 VFO/MEMO : MEMO MEMORY : 5	5 50. 4 29. 3 28. 2 24. 1 21.
	2) VFO/MEMO : VFO	51.
6. SCAN and HOLD F.LOCK	1) MEMORY : SCAN STBY seen at SEND and REC.	1) Scan from 1st MEMORY every 2.5 sec. (REC). 2) Stop SCAN by SEND and SCAN again during REC.
	2) HOLD : ON	SCAN stopped.
	3) MEMORY : 1 HOLD : OFF F.LOCK : ON	VFO-BAND operation stopped. IND lamp lights, simultaneously.
	4) VFO/MEMO : MEMO Switch to 1, 2, 3, 4, 5	Switch to normal
	5) VFO/MEMO : VFO F.LOCK : OFF	IND lamp extinguished.
	6) MODE : FM MIC : insert (MIC accessory) Push UP once.	10 kHz display increases by one.
Push UP continuously.	Continuous increases in 10 kHz steps.	
Push DOWN once.	10 kHz display decreases by one	
Push DOWN continuously.	Continuous decreases in 10 kHz step.	

TS-660

ADJUSTMENT

TOP VIEW

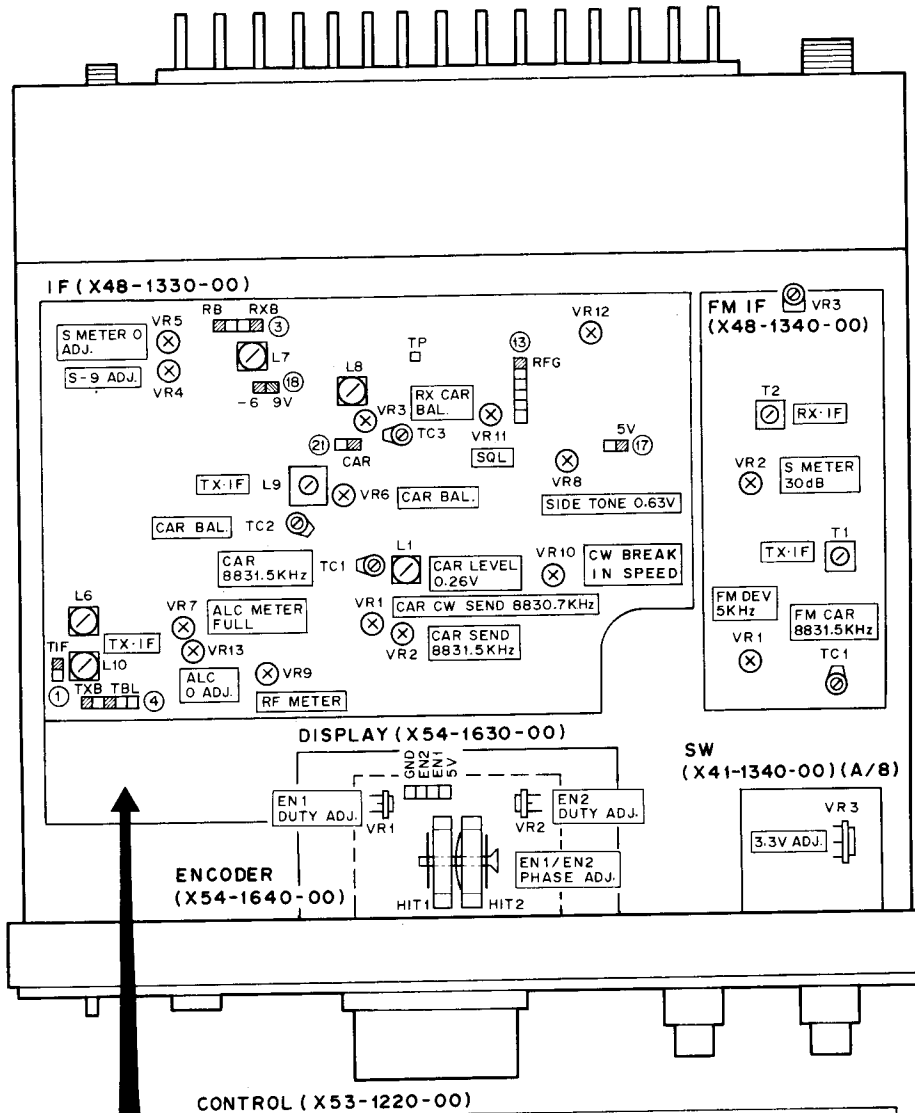

CONTROL (X53-1220-00)

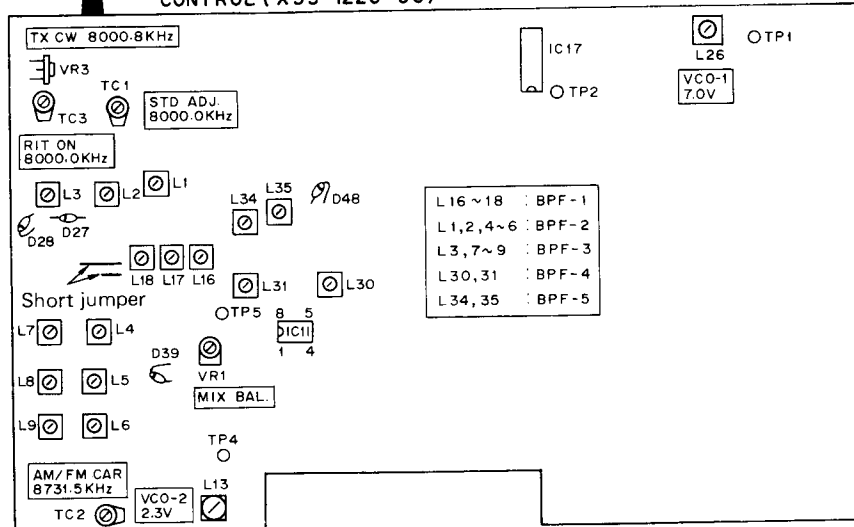

L16~18	BPF-1
L1,2,4~6	BPF-2
L3,7~9	BPF-3
L30,31	BPF-4
L34,35	BPF-5

ADJUSTMENT

BOTTOM VIEW

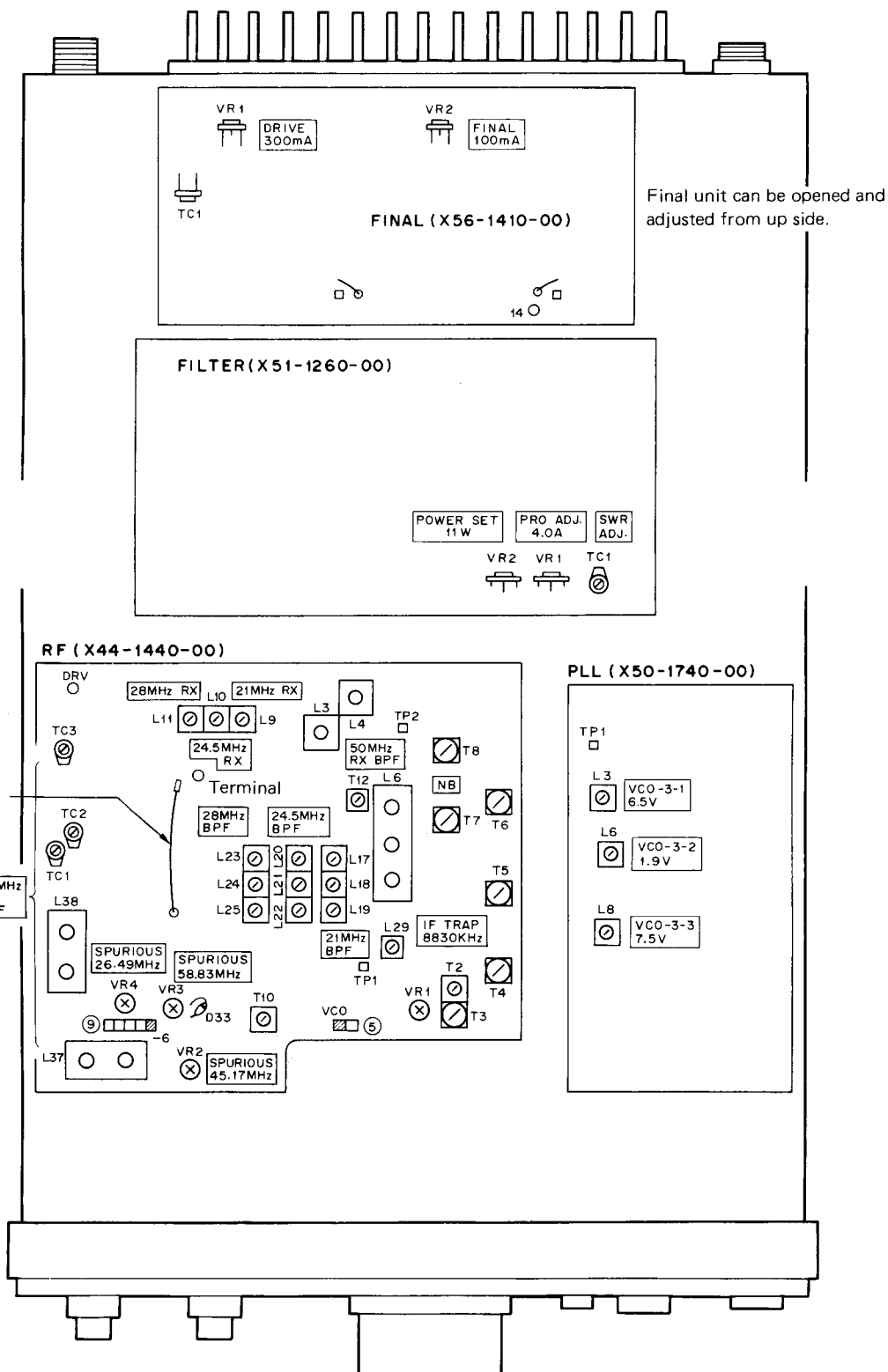

TS-660 BLOCK DIAGRAM

CE3CBQ

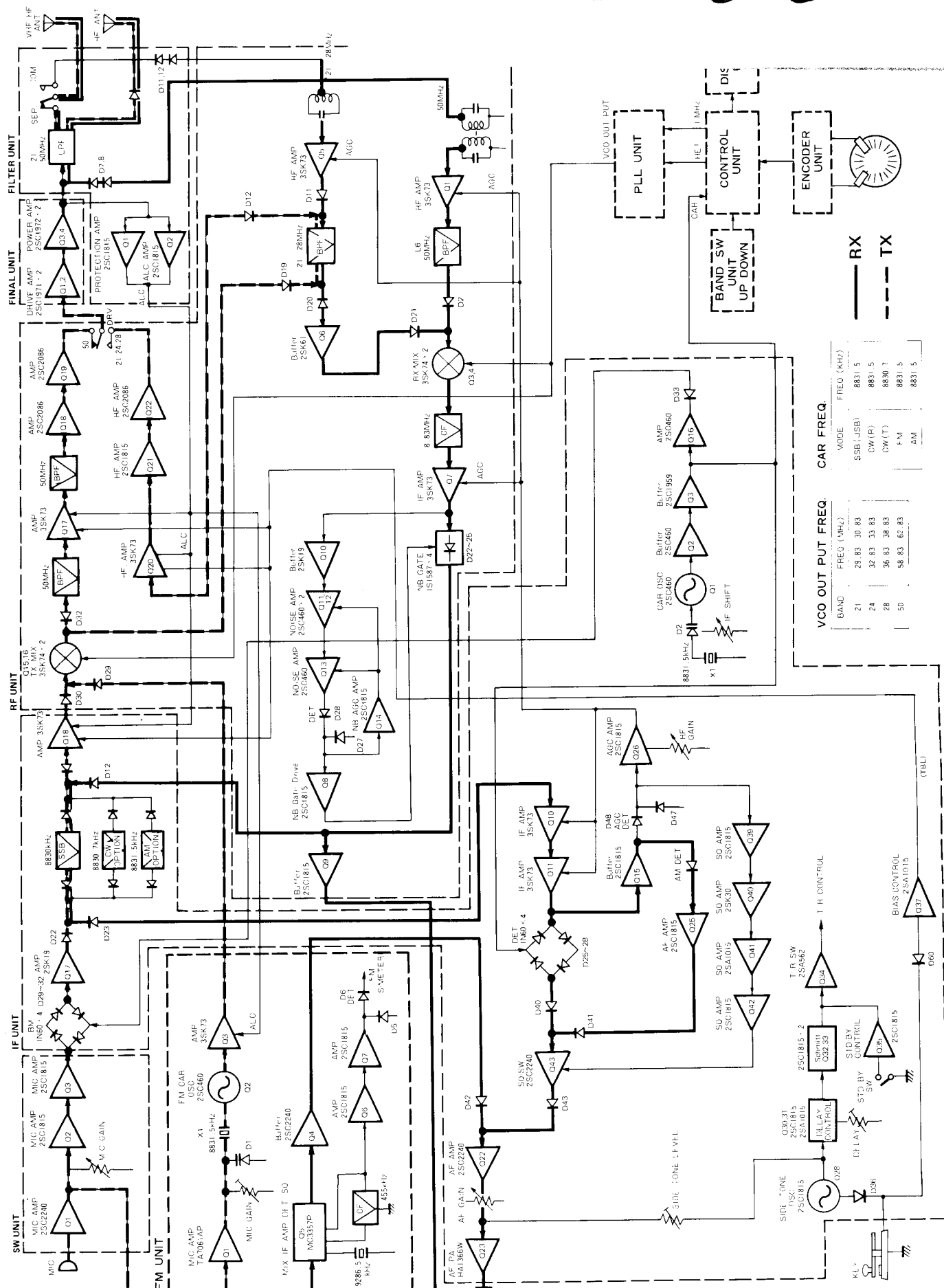

VCO OUT PUT FREQ.		CAR FREQ.	
BAND	FREQ (MHz)	MODE	FREQ (kHz)
21	29.83	SSB(JSB)	8831.5
24	32.83	CW(F)	8831.5
28	36.83	CW(T)	8830.7
50	58.83	F.M	8831.5
		A.M	8831.5

RX
 TX

BAND SW
 UNIT
 UP DOWN

DIS
 CONTROL UNIT
 1 MHz

ENCODER UNIT

VCO UNIT OUT

(TBLU)

CE3CBQ

VOX-4

SPECIFICATIONS

Microphone impedance: 500 Ω ~ 50 k Ω
VOX sensitivity: Less than 5 mV (MIC input at 1.5 kHz, max. VOX GAIN)
Processor: 20 dB (compression) at 1.5 kHz, 10 mV input
Power requirement: DC 9V, 15 mA max. (supplied from transceiver)
Dimensions (mm): 132 (136)W x 39 (46) H x 114 (127) D
 (Figures in () include projections.)
Weight: 0.6 kg (1.3 lbs)

OUTSIDE VIEWS

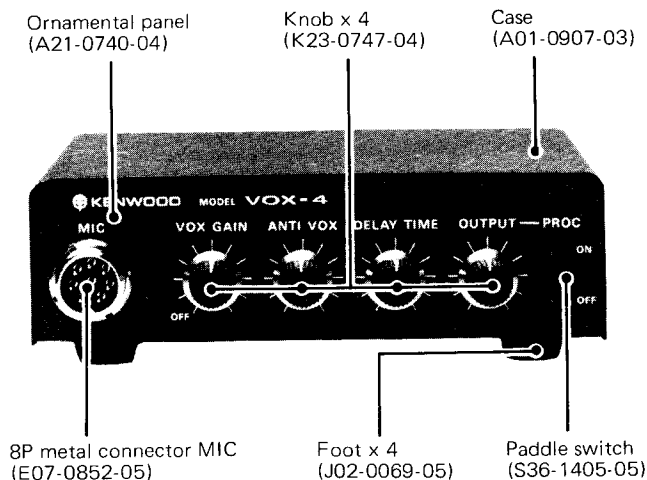

PARTS LIST

N : New parts

Ref. No.	Parts No.	Re- marks	Description
VOX-4 GENERAL			
	A01-0907-03	N	Case
	A21-0740-04	N	Ornamental panel
	B46-0404-00		Warranty card K
	B50-3916-00	N	Operating manual
	E07-0852-05		8P metal connector
	E30-1690-05	N	7P MIC cable
	H01-2767-03	N	Carton case (insdie)
	H12-0484-03	N	Cushion
	H25-0079-04		Protective bag
	J02-0069-05		Foot x 4
	J42-0422-05		Cord bushing
	J61-0019-05		
	J61-0401-05		
	K23-0747-04	N	Knob x 4

Ref. No.	Parts No.	Re- marks	Description
	N13-0308-04	N	Ornamental nut x 4 Pot.
	N30-2004-46		
	N35-3006-45		Bind screw x 4 Case
	N87-3006-46		Self tapping screw x 6
	N89-3006-46		Bind tapping screw x 4 Foot
	R01-1401-05	N	Pot. 1k Ω (B) ANTI VOX
	R01-3418-05	N	Pot. 10k Ω (A) OUTPUT
	R01-4410-05	N	Pot. with SW 50k Ω (B) VOX GAIN
	R01-6402-05	N	Pot. 250k Ω (B) DELAY TIME
	S36-1405-05	N	Paddle switch
	X54-0001-03	N	VOX unit
	X54-1650-00	N	Processor unit

VOX UNIT (X54-0001-03)

C2	CE04W0F470	E	47 μ F 3.15V
C5	CE04W1H3R3M	E	3.3 μ F 50V
C6	CE04W1H010	E	1 μ F 50V
C9, 10	CE04W1H3R3	E	3.3 μ F 50V
C24	CC45SL1H331K	C	330pF
	E23-0005-04		Terminal x 11
T1	L13-0001-05		Input trans
	R92-0150-05		Short jumper
Q1-4	V03-1815-06	TR	2SC1815 (Y)
Q5	V01-1015-06	TR	2SA1015 (Y)
Q6	V03-1815-16	TR	2SC1815 (GR)
Q7	V03-1815-06	TR	2SC1815 (Y)
Q8	V01-0032-05	TR	2SA562 (Y)
D1-4	V11-0051-05		Diode 1N60
D5	V11-0076-05		Diode 1S1555
D6, 7	V11-0051-05		Diode 1N60

PROCESSOR UNIT (X54-1650-00)

C1, 2	CC45SL1H101J	C	100pF
C3	CE04W1H010M	E	1 μ F 50V
C4	CE04W1C100M	E	10 μ F 16V
C5	CQ92M1H153K	ML	0.015 μ F
C6, 8-10, 12	CE04W1H010M	E	1 μ F 50V
C13	CE04W1H4R7M	E	4.7 μ F 50V
C14	CE04W1H010M	E	1 μ F 50V
C15	CE04W1C100M	E	10 μ F 16V
C16	CE04W1H4R7M	E	4.7 μ F 50V
C17	CE04W1A221M	E	220 μ F 10V
	E06-0853-05		8P male socket MIC
	E23-0046-04		Square terminal x 7
VR1	R12-2016-05		Trim. pot 5k Ω
Q1	V03-2240-06	TR	2SC2240 (GR)
Q2	V03-1815-06	TR	2SC1815 (Y)
Q3	V11-1177-26	IC	μ PC1158H2
Q4	V03-1815-06	TR	2SC1815 (Y)
D1	V11-0051-05		Diode 1N60

TS-660

VOX-4

REQUIRED TEST EQUIPMENT

1. AF voltmeter

- 1) Frequency range 50 Hz~10 kHz
- 2) Input resistance More 1MΩ
- 3) Voltage range F.S. = 10 mV~30 V

2. AF generator (AG)

- 1) Frequency range 200 Hz~5 kHz
- 2) Output Max. 1 V, can be reduced to a minimum of 1 mV or less

* Low distortion rate

3. Oscilloscope

* Sensitivity as high as possible and external synchronization possible

4. TS-660

5. Power supply

13.8 VDC minimum 4A.
(Used as TS-660 power source)

Preparatory work

Preset control as follows unless otherwise indicated

	VOX-4	TS-660	
VOX GAIN	OFF	POWER	OFF
ANTI VOX	CEN	MODE	SSB
DELAY TIME	CEN	MIC	MIX
OUTPUT	MIN	IF SHIFT	CEN
PROC	OFF	PUSH SW	all OFF
		RF	MAX
		Others	Optional

Item	Condition	Measurement			Adjustment			Specifications	Remarks
		Test equipment	Unit	Terminal	Unit	Parts	Method		
1. Confirmation of output level	AG 1.5 kHz 10 mV POWER (TS-660) : ON PROC : ON Adjust OUTPUT	AF V.M oscillo- scope AG	Processor	T.G				Normal variation must be possible. Output waveform is not abnormal.	
	PROC : OFF							About 10mV, and not change when OUTPUT turned.	
2. Confirmation of speech processor	1) AG 1.5 kHz 10 mV VOX GAIN : OFF PROC : ON Adjust OUTPUT and set AF V.M level at 20 mV.	AF V.M oscillo- scope	Processor	T.G					
	2) AG 1.5 kHz 1 mV								
3. Confirmation of VOX sensitivity	AG 1.5 kHz 5 mV Adjust VOX GAIN.	AF V.M						ON AIR lights, indicating TX.	
4. Confirmation of ANTI VOX	Connect MIC to MIC terminal of VOX-4, place MIC near speaker, adjust ANTI VOX.							Adjustment must be possible to the point where VOX will not trip. ANTI VOX sensitivity must be at full CW.	
5. DELAY TIME Confirmation	Adjust DELAY TIME							Control must change delay time for maintaining transmission. Maximum time must be at full CW.	
6. Remote UP/DWN	Connect MIC to VOX-4 MIC terminal confirm MIC UP and DOWN operation.							XCVR frequency (and display) must respond to UP and DOWN buttons.	

VOX-4

PROCESSOR UNIT (X54-1650-00)

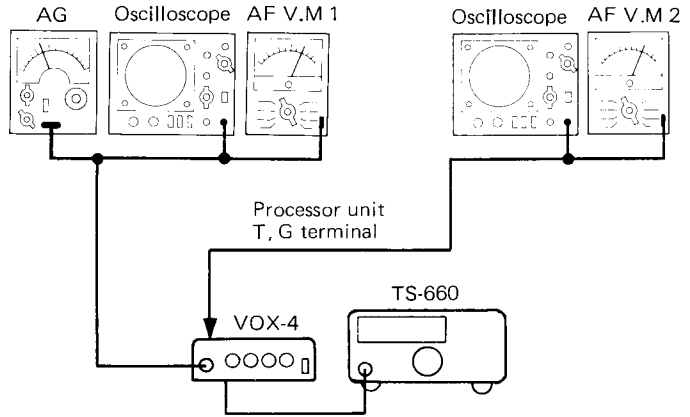
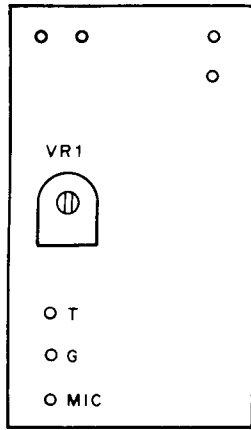

SCHEMATIC DIAGRAM

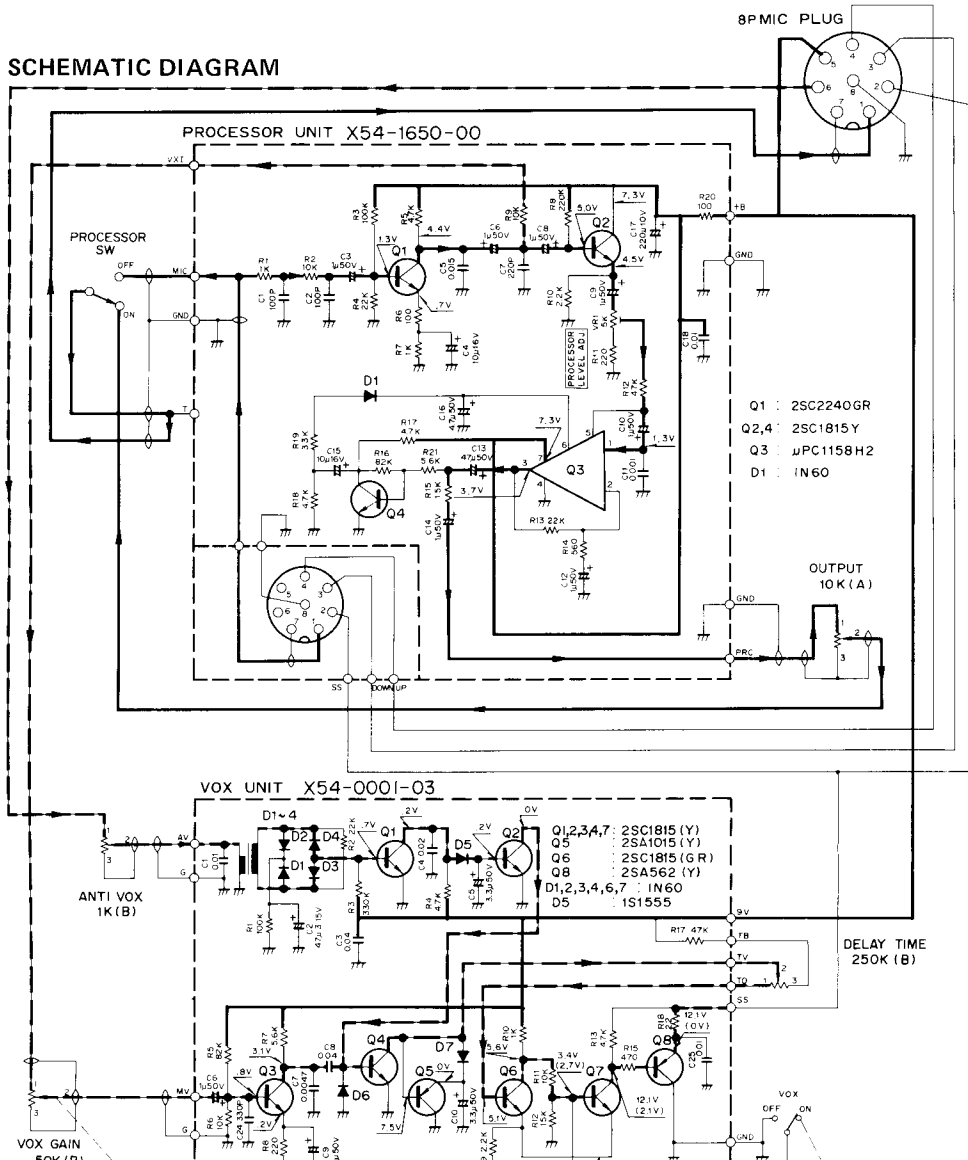

VOX-4

PC BOARDS

▼ VOX UNIT (X54-0001-03) Components side view

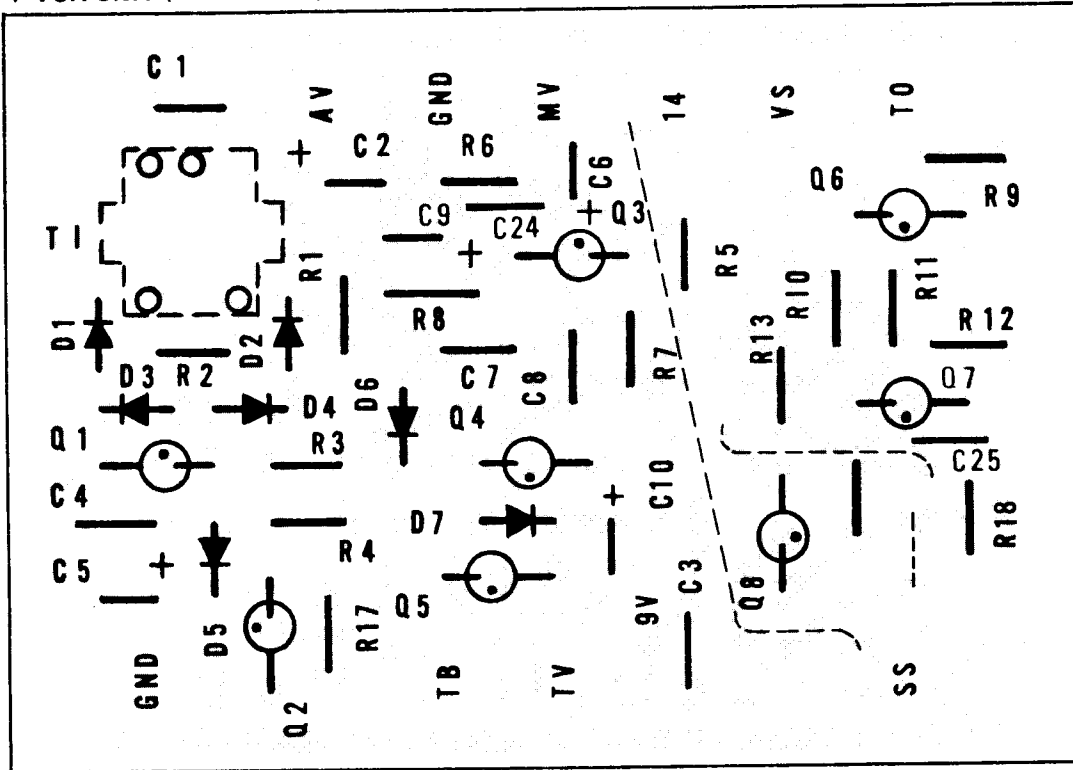

▼ PROCESSOR UNIT (X54-1650-00) Components side view

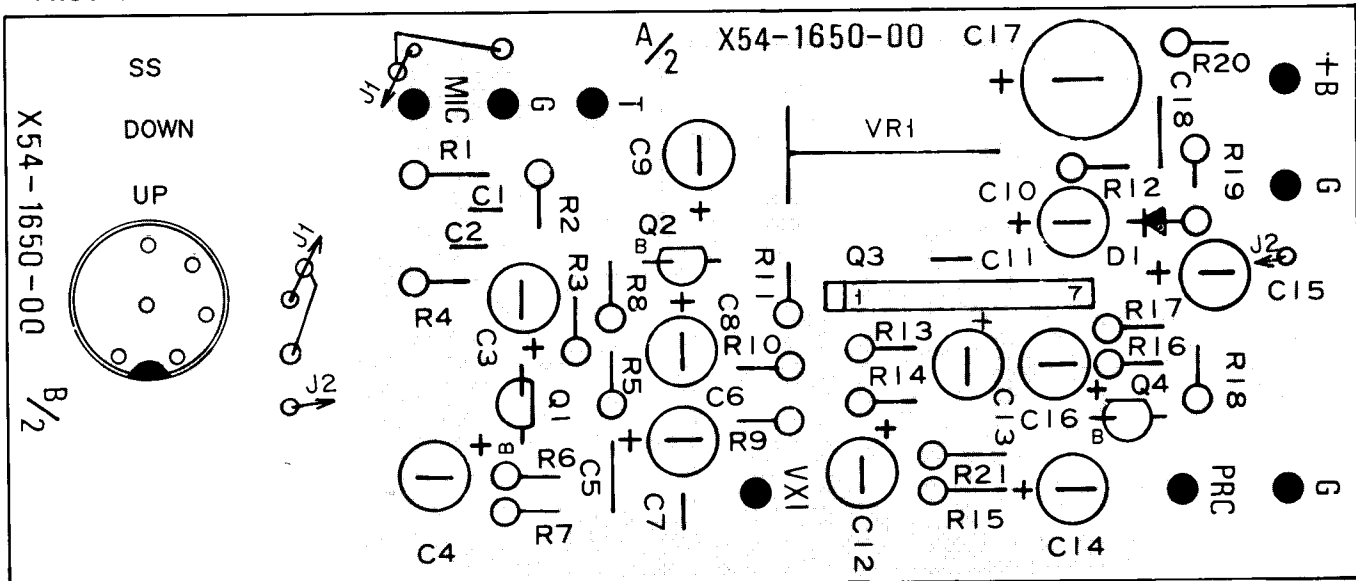

2SA1015
2SC1815
2SC2240

2SA562

μPC1158H2

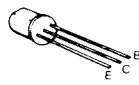
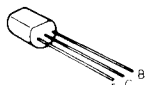

TERMINAL FUNCTIONS

Con- nector No.	Termi- nal No.	Termi- nal name	Function
SWITCH UNIT (X41-1340-00)			
①	1	MIC	MIC AMP input
	2	GND	
②	1	GND	FM MIC AMP Output
	2	FMC	
③	1	AMB	AM 9V
	2	CWB	CW 9V
	3	BM	Balanced MOD. Output
	4	GND	
④	1	RFG	RF GAIN VOL. GND
	2	9V	9V LINE
	3	GND	AF GAIN VOL. GND
	4	AV2	AF GAIN VOL. Center output
	5	GND	AF GAIN VOL. GND
	6	AV1	AF GAIN VOL. Input
⑤	1	A-R	VFO-A : RX VFO-B : TX
	2	VB	VFO-B : TX, RX
	3	B-R	VFO-A : TX VFO-B : RX
	4	GND	
⑥	1	9V	9V LINE
	2	RIT	RIT ON : Control voltage Output
	3	RON	RIT ON : High level Output
⑦	1	SSQ	SSB : SQ VOL. Input
	2	FSQ	FM : SQ VOL. Input
	3	RXB	RX about 9V
	4	IFS	IF SHIFT VOL. Input
RF UNIT (X44-1440-00)			
①	1	GND	VHF RX ANT Input
	2	VRA	
②	1	HRA	HF RX ANT Input
	2	GND	
③	1	RIF	RX IF Output (SSB, CW, AM)
	2	GND	
④	1	FMI	FM RX IF Output
	2	GND	
⑤	1	GND	VCO Input
	2	VCO	
⑥	1	FMT	FM TX IF Input
	2	GND	
⑦	1	TIF	TX IF Input (SSB, CW, AM)
	2	GND	
⑧	1	RB	RX IF, RF AMP, G1 BIAS
	2	14	14V LINE
	3	AGC	AGC LINE
	4	RXB	RX about 9V
⑨	1	-6	-6V LINE
	2	9V	9V LINE
	3	TBL	TX IF, RF AMP G1 BIAS
	4	ALC	ALC LINE
	5	TXB	TX about 9V
⑩	1	50	50M BAND Data input
	2	28	28M BAND Data input
	3	24	24M BAND Data input
	4	21	21M BAND Data input
	5	NBS	NB switch
⑪	1	50B	50M +B Output
	2	28B	24~28M +B Output
	3	21	21M +B Output
	4	HFB	21~28M +B Output

Con- nector No.	Termi- nal No.	Termi- nal name	Function
IF UNIT (X48-1330-00)			
①	1	GND	TX IF Output (SSB, CW, AM)
	2	TIF	
②	1	RIF	RX IF Input (SSB, CW, AM)
	2	GND	
③	1	RB	RX IF, RF AMP, G1 BIAS
	2	14	14V LINE
	3	AGC	AGC LINE
	4	RXB	RX about 9V
④	1	-6	-6V LINE
	2	9V	9V IC Output
	3	TBL	TX IF, RF AMP, G1 BIAS
	4	ALC	ALC LINE
	5	TXB	TX about 9V
⑤	1	RFM	RF METER Input
	2	RL	TXB control
	3	-6	-6V LINE
	4	9V	9V LINE
	5	ALC	ALC
⑥	1	SSB	SSB 9V
	2	CWB	CW 9V
	3	FMB	FM 9V
	4	AMB	AM 9V
	5	9V	9V LINE
⑦	1	SSB	SSB 9V
	2	CWB	CW 9V
	3	AMB	AM 9V
⑧	1	SS	EXT. TX/RX Control
	2	EXT	EXT. Supply for Relay (TX : ON)
	3	ELC	EXT. ALC Input
⑨	1	SS	MIC PTT
	2	RFM	RF METER Output
	3	SM	S METER Output
	4	ALM	ALC METER Output
⑩	1	AMB	AM 9V
	2	CWB	CW 9V
	3	BM	Balanced MOD. Input
	4	GND	
⑪	1	SSQ	SSB SQ Control
	2	FSQ	FM SQ Control
	3	RXB	RX about 9V
	4	IFS	IF SHIFT Control
⑫	1	GND	FM AF Input
	2	FAF	
	3	FMB	
	4	FSQ	
	5	TXB	
	6	FSM	
	7	ALC	
⑬	1	RFG	RF GAIN Control
	2	9V	9V LINE
	3	GND	
	4	AV2	AF GAIN VOL. Output
	5	GND	
	6	AV1	AF GAIN VOL. Input
⑭	1	SPO	AF IC Output
	2	GND	
⑮	1	GND	SPEAKER Output
	2	SPK	

TS-660

TERMINAL FUNCTIONS

Con- nector No.	Termi- nal No.	Termi- nal name	Function
⑬	1	USP	AF EXT. OUT (Unswitched Speaker output)
	2	GND	
	3	GND	
	4	SPJ	EXT. SP Jack to IF
	5	KEY	Key LINE
	6	STS	Sidetone control
⑭	1	5V	5V LINE
	2	TXB	TX about 9V
⑮	1	9V	9V LINE
	2	-6	-6V LINE
⑯	1	TXB	TX about 9V
	2	14S	14V Input
⑰	1	5D	5V IC Output
	2	GND	
⑱	1	CAR	CARRIER Output
	2	GND	
PLL UNIT (X50-1740-00)			
①	1	HET	HET signal Input
	2	GND	
②	1	GND	VCO Output
	2	VCO	
③	1	50	BAND Data 50M BAND : 9V
	2	28	BAND Data 28M BAND : 9V
	3	24	BAND Data 24M BAND : 9V
	4	21	BAND Data 21M BAND : 9V
④	1	GND	1 MHz Standard signal Input
	2	1M	
⑤	1	C	VCO3 Dividing Ratio Data Input
	2	B	VCO3 Dividing Ratio Data Input
	3	A	VCO3 Dividing Ratio Data Input
⑥	1	BLK	Display blanking output
	2	5V	5V LINE
	3	GND	
	4	9V	9V LINE
FILTER UNIT (X51-1260-00)			
①	1	ALC	ALC
	2	RFM	RF METER
	3	9V	9V LINE
	4	-6	-6V LINE
	5	RL	TXB Control
②	1	50B	50 MHz +B
	2	28B	28 MHz +B
	3	21B	21 MHz +B
	4	HFB	21~28 MHz +B
③	1	VRA	VHF RX ANT
	2	GND	
④	1	HRA	HF RX ANT
	2	GND	
CONTROL UNIT (X53-1220-00)			
①	1	HET	HET Output
	2	GND	
②	1	CAR	CAR Input
	2	GND	
③	1	1M	1 MHz Standard signal output
	2	GND	
④	1	RIT	RIT frequency control voltage input
	2	9V	9V LINE
	3	RON	RIT ON signal (ON : 9V)

Con- nector No.	Termi- nal No.	Termi- nal name	Function
⑤	1	AMB	AM 9V
	2	CWB	CW9V
	3	SSB	SSB 9V
⑥	1	-6	-6V LINE
	2	5V	5V LINE
	3	9V	9V LINE
	4	TXB	TX about 9V
⑦	1	-6	-6V Line
	2	5V	5V Line
	3	GND	
	4	BLK	Blanking
⑧	1	5V	5V LINE
	2	GND	
	3	9V	9V LINE
	4	BLK	Blanking
⑨	1	NBS	NB switch
	2	21	21M Band Data
	3	24	24M Band Data
	4	28	28M Band Data
	5	50	50M Band Data
⑩	1	21	21 MHz BAND Data
	2	24	24 MHz BAND Data
	3	28	28 MHz BAND Data
	4	50	50 MHz BAND Data
⑪	1	C	VCO3 Dividing Ratio Output
	2	B	VCO3 Dividing Ratio Output
	3	A	VCO3 Dividing Ratio Output
⑫	1	BU	BACK UP supply input (BACK UP terminal input)
	2	14A	BACK UP supply input (power supply terminal input)
⑬	1	FL	Frequency LOCK SW L : LOCK
	2	FS	F.STEP SW
	3	NBS	NB SW
⑭	1	c	} Display SEGMENT Data output
	2	b	
	3	a	
	4	d	
	5	g	
	6	f	
	7	e	
⑮	1	D1	Display DIGIT Data output 100 Hz
	2	D2	Display DIGIT Data output 1 k
	3	D3	Display DIGIT Data output 10 k
	4	D4	Display DIGIT Data output 100 k
	5	D7	Display DIGIT Data output ch display
	6	D6	Display DIGIT Data output 10 M
	7	D5	Display DIGIT Data output 1 M
⑯	1	MUP	MIC f UP SW
	2	MDN	MIC f DOWN SW
	3	MIN	MEMORY STORE SW
	4	SH	SCAN HOLD SW
	5	MR	MEMO/VFO select switch
⑰	1	BG	BAND SW UNIT GND
	2	BDN	BAND DOWN SW
	3	BUP	BAND UP SW
⑱	1	VB	VFO-B : TX, RX
	2	A-R	VFO-A : RX, VFO-B : TX
	3	B-R	VFO-A : TX, VFO-B : RX
	4	GND	

TERMINAL FUNCTIONS/PACKING

Con- nector No.	Termi- nal No.	Termi- nal name	Function
①	1	5V	5V LINE
	2	SC	MEMORY CH Signal : SCAN
	3	M5	MEMORY CH Signal : 5ch
	4	M4	MEMORY CH Signal : 4ch
	5	M3	MEMORY CH Signal : 3ch
	6	M2	MEMORY CH Signal : 2ch
②	1	GND	
	2	EN2	ENCODER CLOCK Input
	3	EN1	ENCODER CLOCK input
	4	5V	5V LINE(supply for ENCODER)
DISPLAY UNIT (X54-1630-00)			
①	1	GND	
	2	5V	5V LINE (DC-DC converter)
②	1	e	} Display SEGMENT Data input
	2	f	
	3	g	
	4	d	
	5	a	
	6	b	
	7	c	
③	1	D7	Display DIGIT Data input CH Display
	2	D6	Display DIGIT Data input 10 M
	3	D5	Display DIGIT Data input 1 M
	4	D4	Display DIGIT Data input 100 k
	5	D3	Display DIGIT Data input 10 k
	6	D2	Display DIGIT Data input 1 k
	7	D1	Display DIGIT Data input 100 Hz
④	1	BLK	Blanking input (LOW : BLANKING)
	2	5V	5V LINE
	3	GND	
	4	-6	-6V LINE (Output)
ENCODER UNIT (X54-1640-00)			
①	1	GND	
	2	EN2	ENCODER CLOCK Output
	3	EN1	ENCODER CLOCK Output
	4	5V	5V LINE
FINAL UNIT (X56-1410-00)			
		P0	FINAL unit output
		TXB	TX about 9V
		14	14V LINE
		DRV	RF unit output (FINAL unit input)
FM UNIT (X48-1330-00)			
①	1	FMC	FM MIC AMP Input
	2	GND	
②	1	GND	
	2	FMT	FM TX output
③	1	GND	
	2	FAF	FM RX : AF Output
	3	FMB	FM 9V
	4	FSQ	FM SQ output
	5	TXB	TX about 9V
	6	FSM	FM S METER Output
	7	ALC	FM ALC LINE Input
④	1	FMI	FM RX IF Input
	2	GND	

PACKING

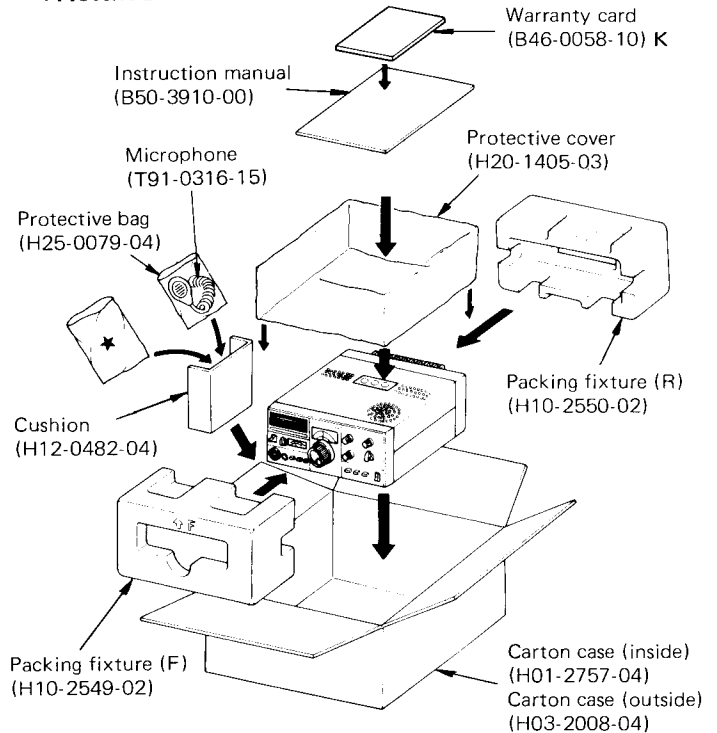

- ★ Protective bag (H25-0112-04)
- DC cord ass'y (E30-1675-05)
- Protective bag (H25-0116-04)
- 7P DIN plug (E07-0751-05)
- Phone plug (E12-0001-05)
- Fuse 4A (F05-4022-05)

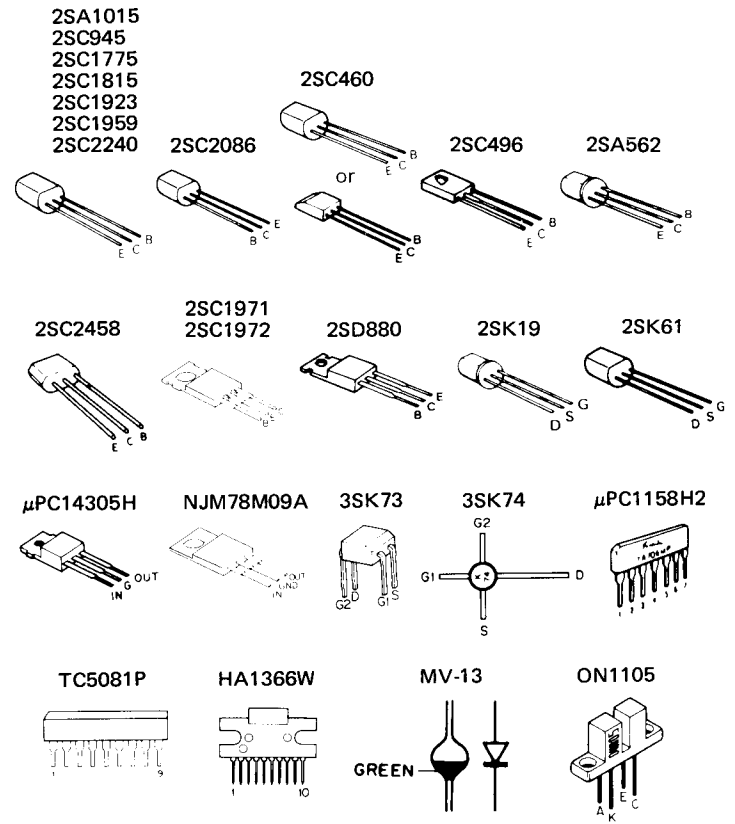

EMATIC DIAGRAM

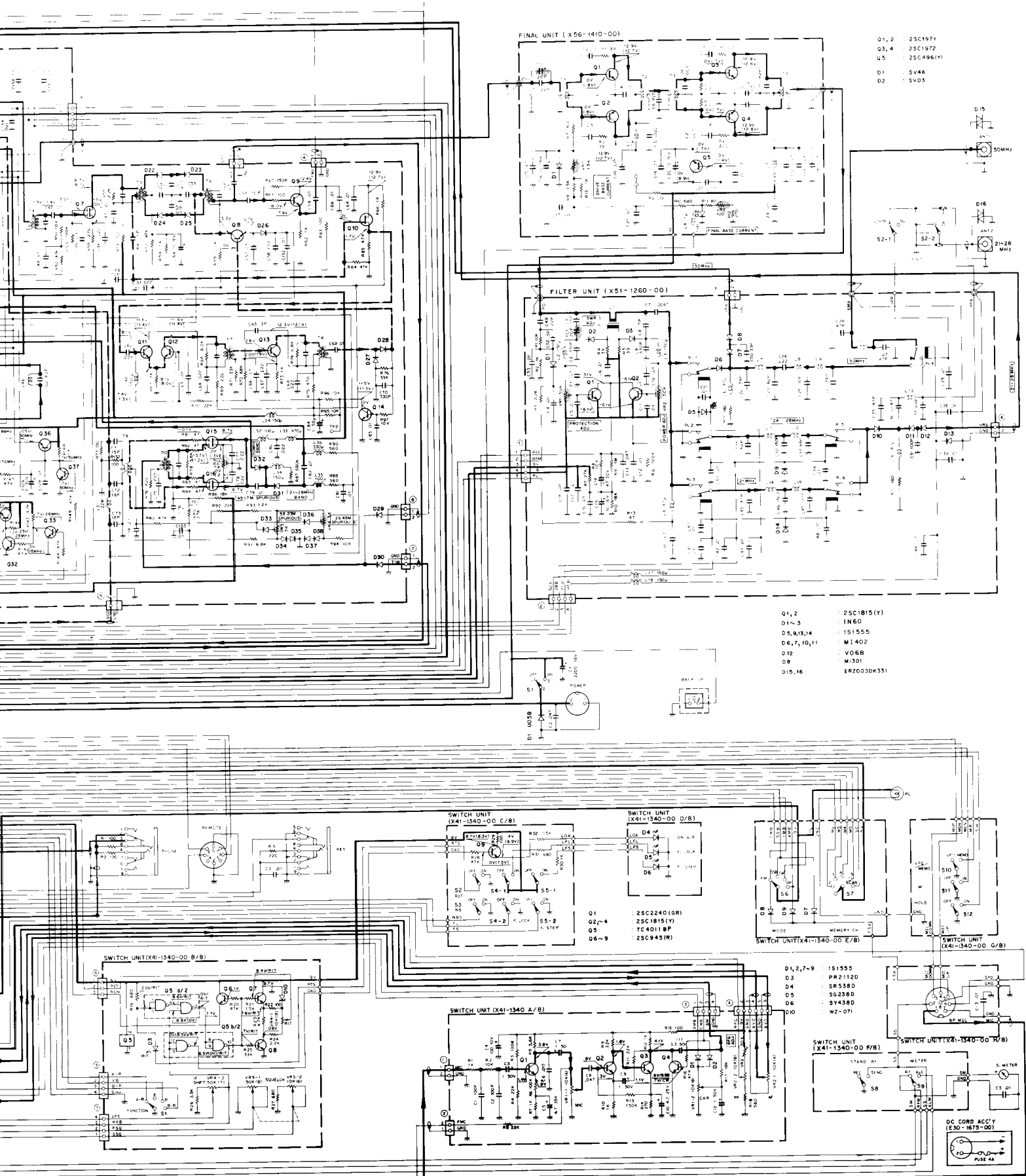

- D1, 2 : 25C1977
- D3, 4 : 25C1972
- D5 : 25C496(V)
- D7 : 5V4A
- D2 : 5V03

- Q1, 2 : 25C1815(Y)
- Q1~3 : 1N60
- D5, 9, 13, 14 : 1S1555
- D6, 7, 10, 11 : M1402
- D12 : V06B
- D8 : M1301
- D15, 16 : ER20030K331

- Q1 : 25C2240(GR)
- Q2~4 : 25C1815(Y)
- Q5 : TC4011BP
- D6~9 : 25C945(R)

- D1, 2, 7, 9 : 1S1555
- D3 : PR2112D
- D4 : SR538D
- D5 : SG238D
- D6 : SY438D
- D10 : W2-071

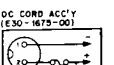

2

3

4

5

6

7

A

B

C

D

E

Signal Line

Control Line

Common DC Line

SCHEMATIC

- 01, 5, 7, 17, 20 : 35K731(GR)
- 03, 4, 15, 16 : 35K74(L)
- 06 : 25K61(GR)
- 08, 9, 14, 21, 26 : 25C1815(V)
- 27, 29, 30, 32 : 25C945(R)
- 33, 35, 37
- Q10 : 25K19(V)
- Q11~13 : 25C460(B)
- Q18, 19, 22 : 25C2086
- Q23 : 25A562(Y)
- Q25, 28, 31 : 25C1959(Y)
- Q34, 36 : 25D880(Y)
- Q38 : 25C945(R)
- Q15, Q10, 29, 30~43, 45, 46
- D2~4, 21, 15, 18 : 152588
- D6~8, 11~14, 16 : 151587
- 17, 19, 20, 22~25
- D26 : MV13
- D27, 28 : 1N60

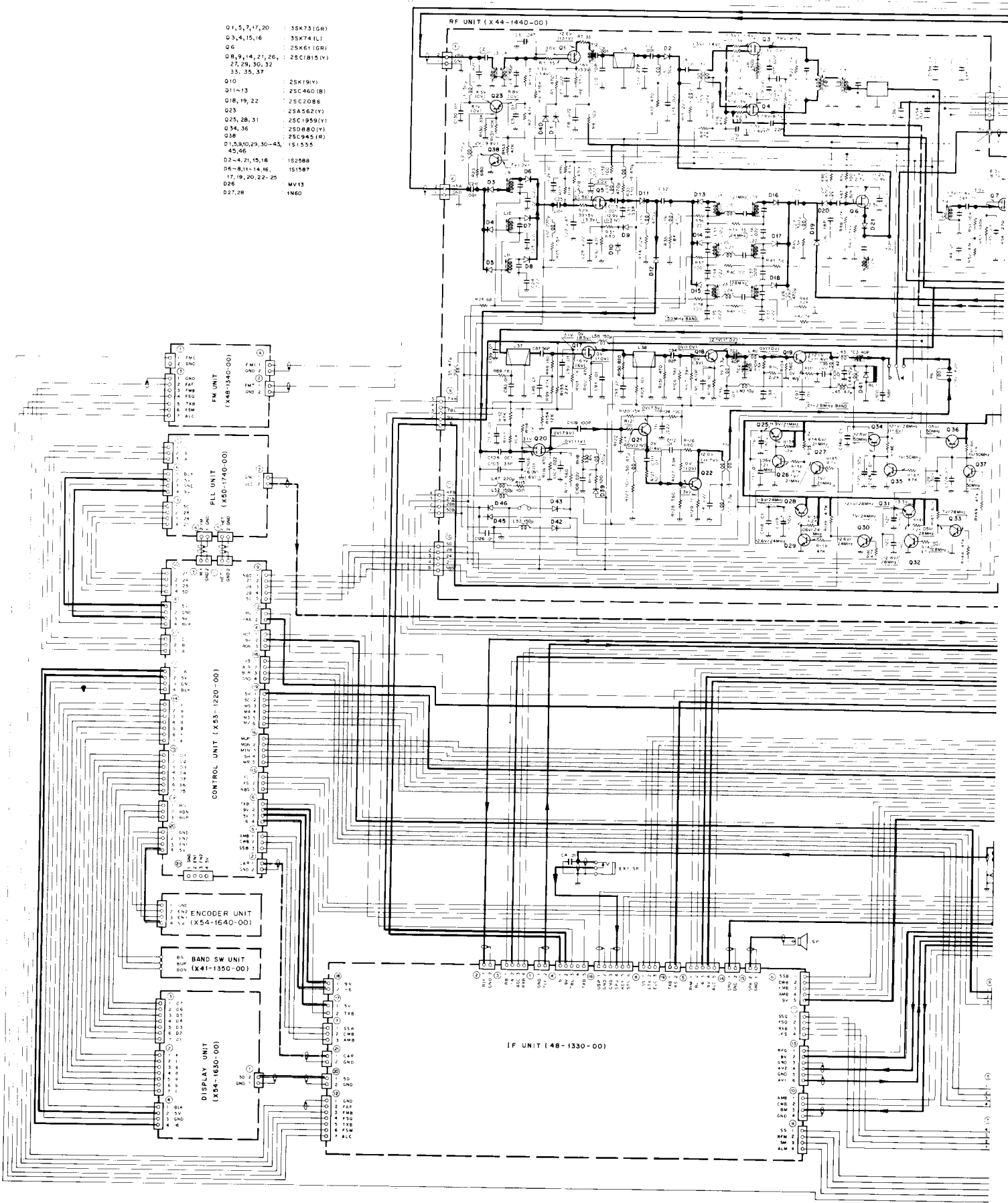

FM UNIT (X48-1340-00)

PLL UNIT (X50-1740-00)

CONTROL UNIT (X53-1220-00)

ENCODER UNIT (X54-1640-00)

BAND SW UNIT (X41-1350-00)

DISPLAY UNIT (X54-1630-00)

RF UNIT (X44-1440-00)

IF UNIT (X48-1330-00)

TS-660

PS-20

SPECIFICATIONS

[Power Supply Section]

Input Voltage: AC120/220V $\pm 10\%$, 50/60 Hz
Output Voltage: DC 13.8V (standard voltage)
Output Current: 4.5A (intermittent load 50% duty cycle)

Continuous Load Current: 4A max
Output Voltage Fluctuation: Within ± 50 mV at AC120/220V $\pm 10\%$ (at load current 4A)

Within 0.1V at 0~4A of load current (at AC120/220V)

Ripple Voltage: Less than 5 mV at 13.8V, 4A (at AC120/220V)

Power Consumption: Approx. 100W (at AC120/220V, DC 13.8V, 4A)

[General]

Dimensions: 123(124) W \times 96(106) H \times 235(250) D mm
 Figures in (): Projections included.

Weight: Approx. 3.8 kg

[Accessories]

Operating Manual: 1
DC Power Cord: 1
Fuse (1A): 1
Fuse (2A): 1
Crimp Style Terminal: 2

NOTE:

The circuit and ratings may change without notice due to development in technology.

ADJUSTMENTS

- Output voltage : Adjust to DC 13.8V by VR1.
- Over current protect : Short output terminals then adjust to DC 0.05V at point of R14 or R15 by VR2.

GENERAL

Ref. No.	Parts No.	Description	Re- marks
—	C90-0808-05	Electrolytic 15000 μ F 25WV	☆
Q1,2	V04-0525-06	Transistor 2SD525	☆
D1	V11-2163-76	Rectifier stack M4B51	☆
S1	S36-2402-05	See saw switch (power)	☆
—	L01-8056-05	Power transformer	☆
—	A01-0732-03	Case (A)	☆
—	A01-0733-02	Case (B)	☆
—	A20-2336-03	Panel (K)	☆
—	B39-0407-04	Spacer (assistance leg)	☆
—	B50-2616-10	Operating manual (K)	☆
—	E07-0252-05	2P Metal plug	☆
—	E20-0282-05	2P Terminal plate	☆
—	E23-0412-05	Crimp, style terminal \times 2	☆
—	E30-0545-05	AC cord with plug	☆
—	E30-1620-05	DC power supply cord	☆
—	F05-2023-05	Fuse (2A) \times 1	☆
—	F05-1023-05	Fuse (1A) \times 1	☆
—	F29-0014-05	Insulating washer \times 2	☆
—	H01-2592-04	Carton case (K)	☆
—	H10-2513-02	Styren foam cushion (F)	☆
—	H10-2514-02	Styren foam cushion (R)	☆
—	H12-0445-04	Cushion	☆
—	H20-1407-03	Protection cover	☆
—	J02-0323-05	Leg \times 4	☆
—	J02-0409-04	Assistance leg	☆
—	J21-2537-04	Leg pushing metal \times 2	☆
—	J32-0133-04	Hex. boss \times 4	☆
—	J41-0024-05	Cord bush	☆
—	X43-1350-00	AVR unit	☆

AVR UNIT (X43-1350-00)

Ref. No.	Parts No.	Description	Re- marks
CAPACITOR			
C1,2	C90-0262-05	Ceramic 0.047 μ F 25WV	
C3	CE04W1C100	Electrolytic 10 μ F 16WV	
C4,5	C90-0262-05	Ceramic 0.047 μ F 25WV	
C6	C90-0810-25	Electrolytic 2200 μ F 16WV	
RESISTOR			
R1~20	RD14BB2E000J	Carbon resistor 000 Ω $\pm 5\%$ 1/4W	
R14,15	R92-0618-05	Metal film 0.1 Ω	☆
SEMICONDUCTOR			
Q1	V01-1015-06	Transistor 2SA1015 (Y)	
Q2	V03-1959-06	Transistor 2SC1959 (Y)	
Q3	V01-0473-06	Transistor 2SA473 (Y)	
Q4,5	V03-1815-06	Transistor 2SC1815 (Y)	
D1	V11-4162-66	Zener diode XZ-060	
D2	V11-4161-76	Zener diode XZ-137	
D3	V11-4162-76	Zener diode XZ-060	
D5	V11-0297-05	Zener diode WZ-130	
D6	V11-5160-66	LED SEL103R	
D7	V11-5160-76	LED SEL303G	
MISCELLANEOUS			
VR1	R12-2015-05	Potentiometer 5k Ω	
VR2	R12-1016-05	Potentiometer 3k Ω	
—	E23-0047-04	Terminal (square) \times 10	
—	J32-0503-05	Beads \times 4	

PS-20

SCHEMATIC DIAGRAM

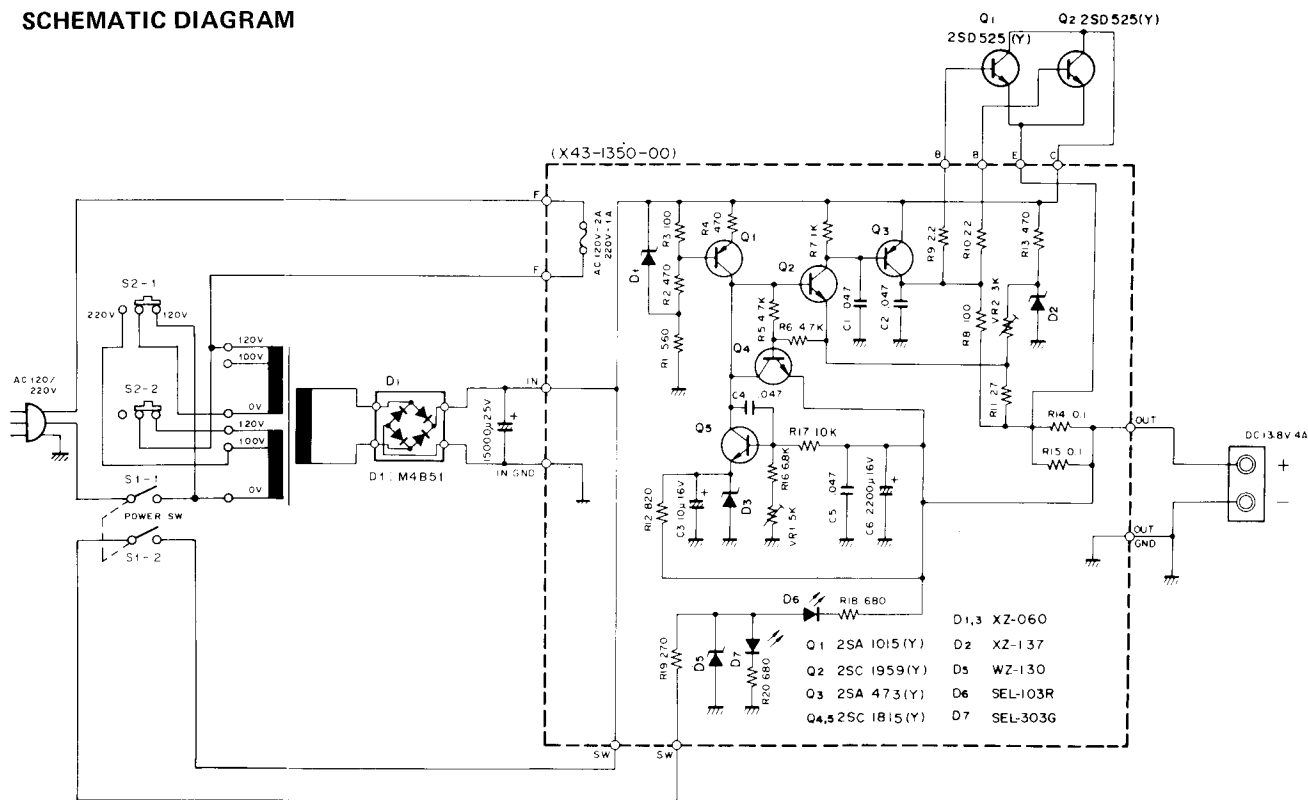

PC BOARD

▼ AVR UNIT (X43-1350-00)

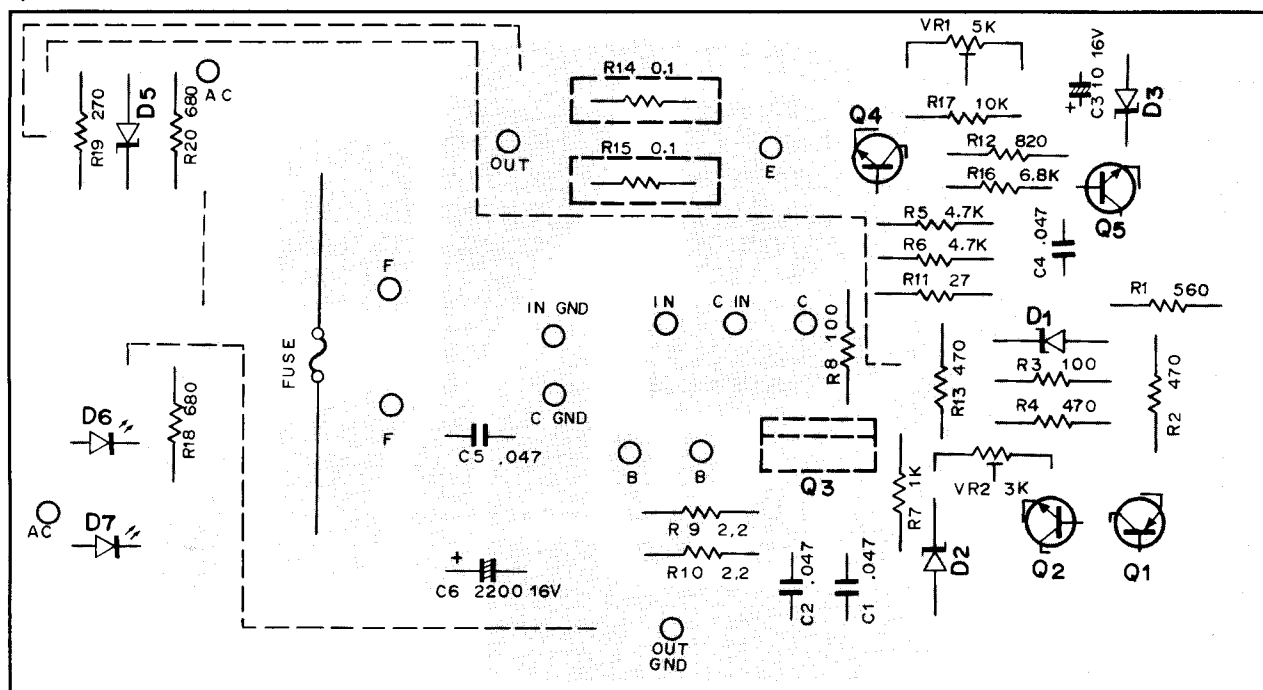

2SA1015
2SC1815
2SC1959

2SA473
2SD525

Q1 Q2
2SD525(OorY) 2SD525(OorY)

TS-660

SP-120/MB-100

SP-120 SPECIFICATIONS

SPEAKER SIZE	3"
RATED INPUT	1.0 watts
IMPEDANCE	8 ohms
FREQUENCY RESPONSE	300 Hz to 5 kHz
DIMENSIONS	4-7/8" wide x 3-3/4" high x 9-1/3" deep (excluding feet)
WEIGHT	3.1 lbs.

MB-100 OUTSIDE VIEW

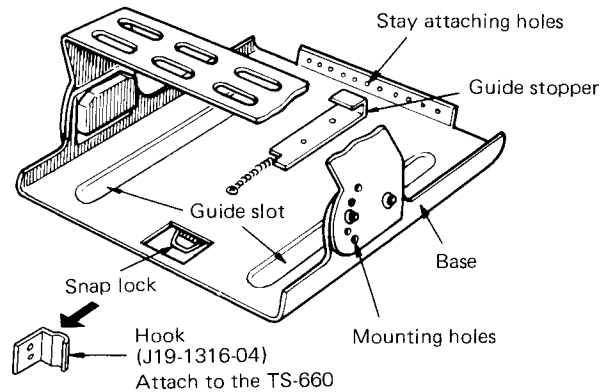

PARTS LIST

N : New parts

Ref. No.	Parts No.	Re- marks	Description
	A01- 0739- 03		Case (A)
	A01- 0740- 03		Case (B)
	A20- 2343- 03		Panel
	A23- 1431- 04		Rear panel
	B04- 0401- 04		SP grill
	B07- 0613- 04		SP ring
	B39- 0407- 04		Spacer x 2
	B50- 2636- 00		Operating manual
	E20- 0208- 04		Terminal plate
	E30- 1629- 05		SP cord
	G53- 0507- 04		Packing x 4
	H01- 2611- 04		Carton case (Inside)
	H10- 2513- 02		Packing fixture (F)
	H10- 2514- 02		Packing fixture (R)
	H12- 0445- 04		Cushion
	H20- 1407- 03		Protective cover
	H25- 0077- 03		Protective bag
	J02- 0323- 05		Foot x 4
	J02- 0409- 04		Assistant foot
	J21- 1144- 14		SP mounting hardware x 2
	J61- 0019- 05		Vinyle tie
	T03- 0027- 15	N	Speaker

PARTS LIST

Ref. No.	Parts No.	Re- marks	Description
	H01- 2604- 04		Carton case (Inside)
	H12- 0450- 03		Cushion
	H20- 1409- 03		Protective cover
	J19- 1316- 04		Hook
	J21- 2633- 04		Guide stopper
	J51- 0006- 15		Snap lock
	J54- 0401- 14		Stay x 2
	J90- 0401- 04		Guide stopper (V)
	N09- 0008- 04		6mm Hex. screw x 6
	N14- 0009- 04		6mm Nut x 6
	N15- 1060- 46		Flat washer
	N16- 0040- 46		Lock washer x 2
	N16- 0060- 46		Lock washer x 6
	N19- 0609- 04		Nylon washer
	N30- 4008- 46		Round screw
	N32- 3006- 46		Flat screw
	N87- 3006- 46		Self tapping screw x 2
	N88- 3006- 46		Flat tapping screw x 2
	N99- 0304- 04		Hex. head screw x 6
	W01- 0401- 04		Allen key

A product of
TRIO-KENWOOD CORPORATION
 17-5, 2-chome, Shibuya, Shibuya-ku, Tokyo 150, Japan

TRIO-KENWOOD COMMUNICATIONS

1111 West Walnut Street Compton, California 90220, U.S.A.

TRIO-KENWOOD COMMUNICATIONS, GmbH

D-6374 Steinbach TS, Industriestrasse 8A, West Germany

TRIO-KENWOOD(AUSTRALIA)PTY. LTD.

4E Woodcock Place, Lane Cove N.S.W. Australia 2066