

 **KENWOOD**

KB2LJJ

**Radio
Mods
Manuals**



HF TRANSCEIVER

Model TS-930S



INSTRUCTION MANUAL

Model TS-930S

Serial No. _____

Date of Purchase _____

Dealer _____

A product of

TRIO-KENWOOD CORPORATION

17-5, 2-chome, shibuya, shibuya-ku Tokyo 150, Japan

TRIO-KENWOOD COMMUNICATIONS

1111 West Walnut Street, Compton, California 90220, U.S.A.

TRIO-KENWOOD COMMUNICATIONS, GmbH

D-6374 Steinbach TS, Industriestrasse 8A, West Germany

TRIO-KENWOOD ELECTRONICS, N.V.

Leuvensesteenweg 504, B-1930 Zaventem, Belgium

TRIO-KENWOOD (AUSTRALIA) PTY. LTD.

4E Woodcock Place, Lane Cove N.S.W. 2066, Australia

AFTER UNPACKING

It is advisable to save all original packing cartons (inner and outer) to protect your valuable transceiver from damage should you wish to transport it for remote operation or ship it for after-sales service.

The following explicit definitions apply in this manual. Be sure to read these definitions:

NOTE: If disregarded, inconvenience only — no damage or personal injury.

CAUTION: Equipment damage may occur, but not personal injury.

NOTE: This manual covers the TS-930S with the AT-930 Automatic antenna tuner installed. If your transceiver does not contain the AT-930, please disregard any mention of Automatic antenna tuner operation.

CAUTION: Read Operating Manual Section 5 before placing transmitter in service.

CONTENTS

SECTION 1. SPECIFICATIONS	3
SECTION 2. INTRODUCTION AND FEATURES	5
SECTION 3. INSTALLATION	7
3.1 Unpacking	
3.2 Operating precautions	
3.3 Operating Location	
3.4 Cabling	
3.5 Microphone	
3.6 Key	
3.7 External Speaker and Headphones	
3.8 Ground	
3.9 Antenna	
SECTION 4. CONTROLS AND THEIR FUNCTIONS	10
4.1 Front Panel	
4.2 Rear Panel	
SECTION 5. OPERATION	14
5.1 Reception (I)	
(1) Basic Procedures for Receive Operation	
(2) WWV Reception	
5.2 Reception (II)	
(1) RF ATT Switch	
(2) RF Gain Control	
(3) AGC (Automatic Gain Control)	
(4) RIT	
(5) SSB SLOPE TUNE Control	
(6) CW VBT Control	
(7) Notch Control	
(8) AF TUNE Circuit	
(9) Noise Blanker (NB)	
5.3 Transmission (I)	
5.4 Transmission (II)	
5.5 BAND Switch	
5.6 Two VFO Operation	
5.7 MEMORY CH Operation	
5.8 TF SET Operation	
5.9 COOLING FAN Operation	
5.10 SHORT WAVE RECEPTION	
SECTION 6. OPTIONAL ACCESSORIES	22
6.1 PERIPHERAL Devices and Options	
6.2 Installation of Accessories	
6.3 Optional Filter Installation	
6.4 AT-930 Installation	
6.5 Remote Control Wiring	
SECTION 7. CIRCUIT DESCRIPTION	33
7.1 BLOCK DIAGRAM	
7.2 Units	
7.3 Auto Antenna Tuner	
SECTION 8. MAINTENANCE AND ALIGNMENT	35
8.1 Preparation	
8.2 Adjustments	
8.3 Maintenance	
8.4 Transmitting WARC bands	
SECTION 9. TROUBLESHOOTING	37
SECTION 10. INTERNAL VIEWS	38
SECTION 11. BLOCK DIAGRAM	39
SECTION 12. SCHEMATIC DIAGRAM	40

SECTION 1. SPECIFICATIONS

[GENERAL]

Transmitter Frequency

Range:	160 m Band 1.8 ~ 2.0 MHz
	80 m Band 3.5 ~ 4.0 MHz
	40 m Band 7.0 ~ 7.3 MHz
	30 m Band 10.1 ~ 10.15 MHz (10.0 MHz WWV)
	20 m Band 14.0 ~ 14.35 MHz
	17 m Band 18.068 ~ 18.168 MHz
	15 m Band 21.0 ~ 21.45 MHz
	12 m Band 24.89 ~ 24.99 MHz
	10 m Band 28.0 ~ 29.7 MHz

Receiver Frequency

Range:	150 kHz - 30 MHz
Mode:	A3J (USB, LSB), A1 (CW), F1 (FSK), A3 (AM)

Antenna Impedance:	50 ohms
With AT-930 antenna tuner	20 - 150 ohms (80 - 10 meter Amateur bands only. However, 30 ~ 100 ohms for 18 MHz and 24.5 MHz.)

Power Requirement: 120/220/240 VAC, 50/60 Hz

Power Dissipation: Max. 510 W during transmission, 80 W during reception

Dimensions: 374(14-3/4")W x 141(5-9/16")H x 350(13-13/16")D mm (inches)

Weight: With antenna tuner: Approx. 18.5 kg (40.8 lbs)
Without antenna tuner: Approx. 16.8 kg (37.0 lbs)

[TRANSMITTER]

Final Power Input:	SSB/CW/FSK 250 W	AM 80 W
--------------------	------------------	---------

Carrier Suppression: Better than 40 dB

Unwanted Sideband Suppression: Better than 50 dB (with 1 kHz modulation)

Harmonic Content: Less than -40 dB

Audio Frequency Response: 400 - 2,600 Hz/ -6 dB

Modulation: SSB: Balanced modulation
AM: Low level modulation (IF stage)

FSK Shift: 170 Hz

Modulation Distortion: Less than -31 dB

FSK Shift: 170 Hz

Modulation Distortion: Less than -31 dB

Microphone Impedance: 500 ohms ~ 50 kohms

ALC Input: -10 V DC MAX

Linear Amplifier

Switching: 200 V DC MAX
100 mA

[RECEIVER]

Circuitry:	Quadruple conversion
Intermediate Frequencies:	1st IF: 44.93 MHz
	2nd IF: 8.83 MHz
	3rd IF: 455 kHz
	4th IF: 100 kHz

Sensitivity (at 10 dB S+N/N)
150 - 500 kHz: Less than 1 μ V for SSB, CW and FSK

500 kHz - 1.8 MHz: Less than 10 μ V for AM
Less than 4 μ V for SSB, CW and FSK

1.8 - 30 MHz: Less than 32 μ V for AM
Less than 0.25 μ V for SSB, CW and FSK

Image Ratio: Less than 2 μ V for AM
More than 80 dB (1.8 MHz ~ 30 MHz)

IF Rejection: More than 70 dB (1.8 MHz ~ 30 MHz)

Selectivity (W-wide, N-narrow filter selection)
SSB, CW(W), FSK(W), AM(N): 2.7 kHz/ -6 dB,
4.0 kHz/ -60 dB

CW(N), FSK(N): Without optional filter: same as CW(W), FSK(W)
With optional YG-455C-1:
500 Hz/ -6 dB,
820 Hz/ -60 dB
With optional YG-455CN-1:
250 Hz/ -6 dB,
480 Hz/ -60 dB
With optional YK-88C-1:
500 Hz/ -6 dB,
1.5 kHz/ -60 dB

AM(W): Without optional filter:
6 kHz/ -6 dB,
18 kHz/ -60 dB

With optional YK-88A-1:
6 kHz/ -6 dB,
11 kHz/ -60 dB

SSB Slope Tune: High-cut: More than 1500 Hz shift/ -6 dB
Low-cut: More than 700 Hz shift/ -6 dB

CW VBT
CW(W), FSK(W)
AM(N): 600 Hz ~ 2.7 kHz/ -6 dB
CW(N), FSK(N): Without optional filter: same as CW(W), FSK(W)
With optional YK-88C-1 and YG-455C-1 installed:
150 Hz ~ 500 Hz -6 dB

AM(W): With optional YK-88A-1:
4 kHz ~ 6 kHz/ -6 dB

Frequency Stability: Within ± 200 Hz during the first hour after turn-on
Within ± 30 Hz any 30 minute period thereafter at constant temperature

Frequency Accuracy: $\pm 1 \times 10^{-5}$ or better (at normal temperatures)

RIT Variable Range: ± 9.99 kHz

Notch Filter Attenuation: More than 40 dB

Phone Patch Output Z: 600 Ω

Audio Output Power: More than 1.5 W across 8 Ω (at 10% distortion)

AT-930 (Automatic Antenna Tuner)

Frequency Range: Amateur bands from 80 ~ 10 m

Input Impedance: 50 Ω , unbalanced

Output Impedance: 20 ~ 150 Ω unbalanced

Insertion Loss: Less than 1 dB at 3.5 MHz (at optimum match)

Through Power: 150 W max.

Motor Stop SWR Value: Less than 1.2

NOTE: The circuit and ratings may change without notice due to developments in technology.

SECTION 2. INTRODUCTION AND FEATURES

2.1 KENWOOD TS-930S

The TS-930S is a highly sophisticated all-solid state transmitter operating on all Amateur bands between 1.8 and 29.7 MHz, and a general coverage short wave receiver covering the 150 kHz to 30 MHz range. The TS-930S includes many built-in features usually found as extras on other transceivers. Included are VOX, 100 kHz calibrator, RIT, RF attenuator, two VFO's and two effective noise blankers. The TS-930S also includes automatic gain control (AGC), automatic level control (ALC), full- and semi-break-in CW with sidetone, an RF speech processor, speaker, built-in AC power supply and an optional built-in automatic antenna tuner.

Designed for operation on SSB, AM, FSK or CW, the TS-930S delivers more than 250 watts PEP input.

Any complicated electronic device may be damaged if operated incorrectly, and this transceiver is no exception. Please read all of the operating instructions before putting your TS-930S on the air.

2.2 FEATURES

- **160-10 Meters, with 150 kHz – 30 MHz General Coverage Receiver**

Covers all Amateur frequencies from 160-10 meters, including the new WARC, 30, 17, and 12 meter bands, on SSB, CW, FSK, and AM. Features an excellent 150 kHz – 30 MHz general coverage receiver. Separate Amateur band access keys allow speedy band selection, and an UP/DOWN bandswitch changes in 1 MHz steps. A new, innovative, quadruple conversion, digital PLL synthesized circuit provides superior frequency accuracy and stability, plus greatly enhanced selectivity.
- **Excellent Receiver Dynamic Range**

The use of dual 2SK125 J FET's in a unique parallel RF amplifier circuit, followed by two 2SK125's each, operated push-pull, in the 1st mixer, buffer amplifier, and 2nd mixer circuits results in outstanding two-signal characteristics and a substantially improved noise floor level. Typical two-tone dynamic range performance for the receiver section is 100 dB (20 meters, 500 Hz CW bandwidth at sensitivity of 0.25 μ v, S/N 10 dB.), with an overall intercept point of +10 dBm, a noise floor level of -140 dBm, and a blocking dynamic range of 135 dB (20 meter, CW bandwidth).
- **Dual Mode Noise Blanker ("Pulse" or "Woodpecker")**

NB-1, with threshold control, for pulse-type noise. NB-2 for longer duration "woodpecker" type noise.
- **SSB IF Slope Tuning**

Allows independent adjustment of the low and/or high frequency slopes of the IF passband, for best interference rejection.
- **CW VBT and Pitch Controls**

The CW VBT (Variable Bandwidth Tuning) control tunes out interfering signals. The CW pitch control shifts the IF passband and simultaneously changes, both the received beat frequency and sidetone pitch. A "Narrow/Wide" filter selector switch is provided.
- **IF Notch Filter**

100 kHz tuneable IF notch provides a deep, sharp, notch, to better than -40 dB. SSB slope tuning, CW VBT, or pitch controls do not affect the notch frequency.
- **Built-in Audio Filter**

Tuneable, peak-type audio filter for CW. Peak center frequency is approximately 800 Hz, adjustable \pm 400 Hz.
- **All Solid State, 28 Volt Operated Final Amplifier**

The final amplifier operates on 28 V DC for the lowest possible IM distortion (3rd order IMD -37 dB, typical). Power input is rated at 250 W PEP on SSB, 250 W DC on CW and FSK, and 80 W DC on AM. RF Power is supplied by two Motorola MRF-422 RF power transistors (Pc=290 W/each) operating push-pull. Final amplifier protection circuits, cooling fan, and an SWR/Power meter are built-in.
- **Automatic Antenna Tuner, Built-In**

Available with the AT-930 Antenna tuner either built-in, or as an option, which covers the 80-10 meter amateur bands, including the new WARC bands. The tuning range is automatically pre-set AT band selection to minimize tuning time. Impedance matching capability is 20 to 150 ohms, unbalanced. An "AUTO-THRU" switch is provided on the front panel.
- **CW Full Break-In**

The CW Full Break-in circuit uses CMOS logic plus reed relays for maximum flexibility, coupled with smooth, quiet operation. Front panel switchable to semi-break-in.
- **RF Speech Processor**

An RF clipper provides higher average "talk-power", plus improved intelligibility. Separate "INPUT" and "OUTPUT" front panel level controls.
- **Dual Digital VFO's**

10 Hz step dual digital VFO's include the band. Mode selector for split frequency or cross-band operation. Each VFO continuously tunes the full receiver range. A

large, heavy, flywheel-type knob is used for ease of tuning. The T.F. Set switch allows fast transmit frequency setting for split-frequency operations. An A=B switch is provided for equalizing one VFO frequency to the other. A VFO "Lock" switch is provided. The RIT control allows ± 9.9 kHz receive frequency shift.

- **Automatic VFO Step change**

Tuning faster than 5.5~6.5 revolutions/second increases the tuning rate for easy QSY.

- **Eight Memory Channels**

These store both frequency and band. VFO-MEMO switch allows use of each memory as either an independent VFO, (the original memory frequency can be recalled at will), or as a fixed frequency. Internal battery memory back-up, estimated 1 year life. (Three "AA" batteries not Kenwood supplied).

- **Fluorescent Tube Digital Display**

Six digit fluorescent tube digital display has an analog type sub-scale with 20 kHz increment markers. A separate 2 digit display always indicates RIT frequency shift. The display also indicates VFO "A" or "B", Memory channel operation, RIT "ON" and VFO "LOCK".

- **AC Power Supply Built-In**

120, 220, or 240 V AC, switch selected. (operates on AC only). Separate automatic fan provided to force-cool the power supply.

Other Features:

- SSB monitor circuit, 3 step RF attenuator, VOX, and 100 kHz marker
- 2.4 kHz SSB and 6 kHz AM filters built-in
- Display and meter dimmer switch

Optional Equipment:

- AT-930 Automatic antenna tuner
- SP-930 External speaker with selectable audio filters
- YG-455C-1 (500 Hz) or YG-455CN-1 (250 Hz) plug-in 455 kHz CW filters
- YK-88C-1 (500 Hz) CW and/or YK-88A-1 (6 kHz) AM plug-in 8.83 MHz filters
- MC-60A Deluxe desk microphone with PTT, PTT lock, and UP/DOWN switches
- TL-922(A) The linear amplifier TL-922A (without 10m band) is available only in U.S.A.
- SM-220 Station monitor for transmit, receive, and trapazoid displays
- PC-1A Hybrid phone patch
- HC-10 Digital World Clock
- HS-6, HS-5, (Deluxe through standard) headphones
HS-4,

IMPORTANT

The MC-60A has a built-in amplifier. When using the microphone connected to the TS-930S, be sure to set the MC-60A MIC AMP switch to OUT.

With the MIC AMP switch set to IN, the microphone output level exceeds the rated input level of the TS-930S.

SECTION 3. INSTALLATION

3.1 UNPACKING

Remove the TS-930S from its shipping container and packing material and examine it for visible damage. If the equipment has been damaged in shipment, notify the transportation company immediately. Save the boxes and packing material for future shipping.

The following accessories should be included with the transceiver.

1. Instruction Manual (B50-3959-20) 1
2. Speaker Plug 1/8" (E12-0001-05) 1
3. 7 Pin DIN Plug (E07-0751-05) 1
4. 8 Pin MIC Plug (E07-0852-05) 1
5. Fuse (6A) (F05-6021-05) or (4A) (F05-4022-05) 1
6. Power cable 1

3.2 OPERATING PRECAUTIONS: READ BEFORE OPERATING

It is suggested you read this instruction manual carefully before attempting operation with your new TS-930S, and that you follow the suggested operating procedures.

Especially note that the final amplifier power transistors might be damaged during transmission if the transceiver is operated into an improper load.

Observe the following transmitter precautions:

1. If the built-in antenna tuner is used, operate only after automatic tuning is completed, tuning must be performed with the MODE switch at the TUNE position.
2. Use only a resonant, 50 Ω antenna which is adjusted for an SWR of 1.5 or less.
3. DO NOT transmit without an Antenna or Dummy Load.

3.3 OPERATING LOCATION

As with any solid state electronic equipment, the TS-930S should be kept from extremes of heat and humidity.

Choose an operating location that is dry and cool, and avoid operating the transceiver in direct sunlight. Also, allow at least 3 inches clearance between the back of the equipment to any object. This space allows an adequate air flow from the ventilating fans to keep the transceiver cool.

CAUTION:

Do not operate the radio in an RF Field greater than 6 V RF. Receiver damage may occur.

3.4 CABLING (See Figure 3-2.)

■ GROUND

To prevent electric shock, and reduce the possibility of TVI and BCI, connect the transceiver to a good earth ground, through as short and heavy a lead as possible. Use ground rods or metal cold water feedline.

NOTE:

A ground connection greater than $1/4 \lambda$ away from the transceiver may be a good DC ground, but NOT an RF Ground.

■ ANTENNA

Connect through a 50 ohm antenna feedline to the coaxial connector on the rear panel.

■ KEY

If CW operation is desired, connect a key to the KEY jack. Use shielded line or coaxial cable.

■ POWER CONNECTIONS

Make sure the POWER switch on the front panel is turned off, the stand-by switch is in the REC position, the VOX is off, and the line voltage is correct. Then connect the power cord to the line source.

■ AC POWER

For fixed station operation, the TS-930S is supplied to operate from a 120 V AC, 220 VAC or 240 VAC 50/60 Hz power source capable of supplying 510 watts or more.

For units shipped to the U.S.A., the switch is set at 120 with a 6-ampere fuse installed.

For units shipped to the European, Central and South American, and African countries, the switch is set at 220 with a 4-ampere fuse installed.

For units shipped to the Oceanian countries, the switch is set at 240 with a 4-ampere fuse installed.

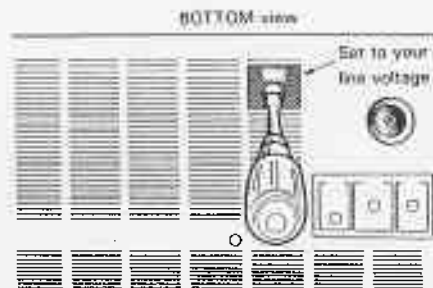

Fig. 3-1A Voltage selector switch

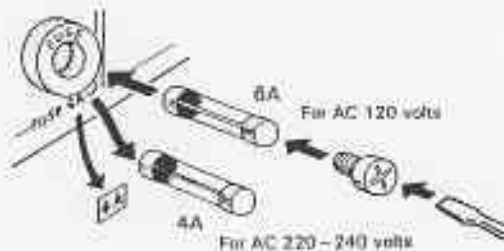

Fig. 3-1B Fuse replacement

should be given serious consideration. The crystal lattice filter in the transceiver provides all the restriction necessary on audio response, and further restriction in the microphone is not required. It is more important to have a microphone with a smooth, flat response throughout the speech range.

Follow the microphone manufacturer's instructions for connecting the microphone cable to the plug. With many microphones, the push-to-talk button must be pressed to make microphone audio available. For VOX operation, this unwanted feature may be eliminated, if desired, by opening the microphone case and permanently bridging the contacts which control the microphone audio.

Standard microphone sensitivity is within the range of -50 dB to -60 dB. If a microphone having a higher sensitivity is used, the ALC and compressor circuits may not function properly. In this case, insert in the mike line an attenuator as shown in Fig. 3-2C. A typical MIC gain control setting is 12 o'clock. If you must run this control at 9 o'clock or less, use an attenuator.

3.6 KEY

If CW operation is desired, connect a key to the KEY jack. Use shielded cable, and a standard (mono or 2P) phone plug.

3.7 EXTERNAL SPEAKER AND HEADPHONES

Receive audio output from the TS-930S is 1.5 watts at 4 to 16 ohms. The TS-930S has a built-in speaker, plus an external speaker jack on the rear panel. The speaker may be an 8-ohm permanent-magnet type, 4 inches or larger. The internal speaker is disconnected when an external speaker is used. Headphones should also be 4 to 16 ohms impedance. When the headphones are connected to the front-panel PHONES jack, the speaker is disabled.

3.8 GROUND

To prevent electric shock, and reduce the possibility of TVI and BCI, connect the transceiver to a good earth ground through as short and heavy a lead as possible.

3.9 ANTENNA

Any of the common antenna systems designed for use on the high frequency amateur bands may be used with the TS-930S, provided the input impedance of the transmission line is not outside the capability of the AT-930 Automatic Antenna Tuner pi-output matching network. The transmission line should be coaxial cable. An antenna system which shows a standing wave ratio of less than 1.5:1 when using 50 ohm coaxial transmission line, or a system that results in a transmission line input impedance that is essentially resistive, and between 20 and 150 ohms will take power from the transceiver through the AT-930. If open wire or balanced type transmission line is used with the antenna, a suitable antenna tuner with balun is recommended between the transceiver and the feed line. Methods of construction and operating such tuners are described in detail in the ARRL Antenna Handbook, or similar publications. For operation on the 160, 75 and 40 meter bands, a simple dipole antenna, cut to resonance in the most used portion of the band, will perform satisfactorily. For operation on the 10, 15 and 20 meter bands, the efficiency of the station will be greatly increased if a good directional rotary antenna is used. Remember that even the most sophisticated transceiver is useless without a good antenna.

CAUTION:

Protect your Equipment - Use a LIGHTNING ARRESTOR

SECTION 4. CONTROLS AND THEIR FUNCTIONS

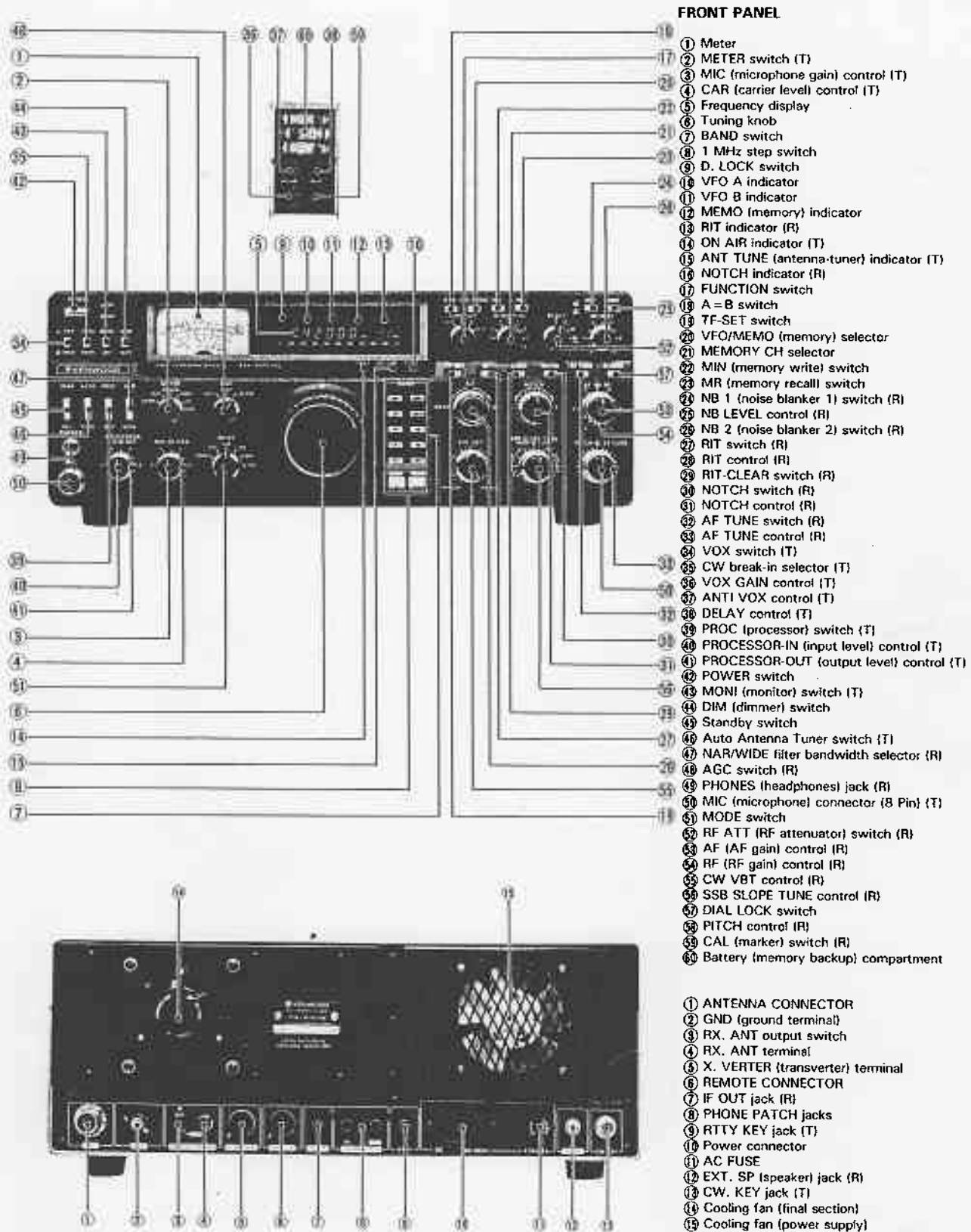

4.1 FRONT AND TOP PANELS

The symbol after the part name indicates:

R: Active only during reception

T: Active only during transmission

No symbol: Always active

[METER]

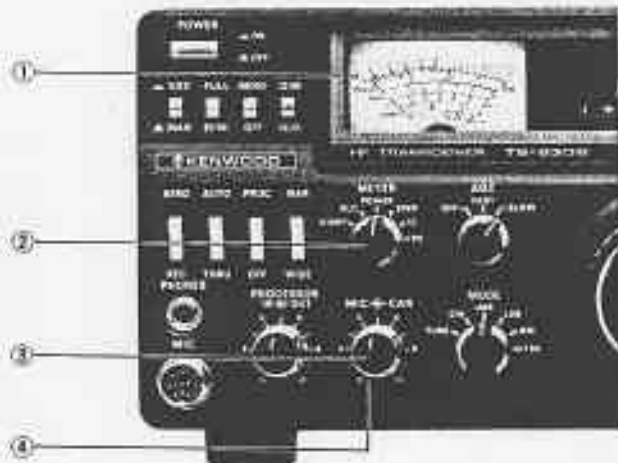

① Meter

The meter monitors seven different functions, depending on the METER switch position. In receive the meter is automatically an S-meter, and shows received signal strength on a scale of 0 to 60 dB over S9. In transmit, meter function depends on the position of the METER switch, as described below. This is an average-responding meter, NOT peak-reading.

② METER switch (T)

This determines the transmit meter function:

• COMP:

This indicates compression level when the speech processor is operating. Do not exceed 10 dB compression.

• ALC (Automatic Level Control):

Monitors internal ALC voltage, or the ALC voltage feedback from a linear amplifier operated in conjunction with the TS-930S. For SSB operation the ALC reading for voice peaks should be within the indicated ALC range. ALC voltage adjustment is made with the MIC control for SSB and with the CAR control for CW. In FSK or when the processor is operating, adjust ALC with the PROCESSOR OUT control (41).

• POWER:

Indicates transmitter RF output power.

• SWR:

Indicates voltage standing wave ratio (VSWR).

• IC:

Indicates the power transistor collector current (IC). Since the IC meter is adjusted to the values in the proximity of the current value which is usually used, its indication may not be correct when a weak current such as the idling current is applied.

• VC:

Indicates the power transistor collector voltage (VC).

③ MIC (microphone gain) control (T)

This control adjusts microphone amplifier gain for SSB operation. Adjust for an on-scale ALC reading on voice peaks. For low-power operation, adjust this control below the ALC range.

④ CAR (carrier level) control (T)

This controls carrier level during CW operation. Adjust the carrier level for an on-scale ALC meter reading. For low-power operation, adjust this control below the ALC range.

[DISPLAY]

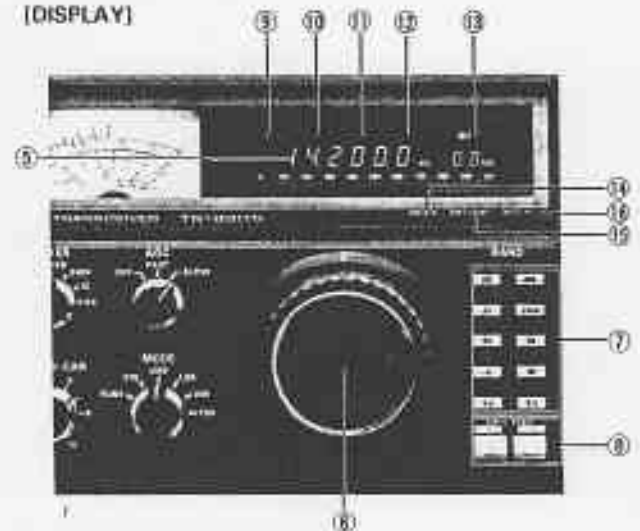

⑤ Frequency display

This custom two color gas display tube independently indicates: Operating frequency to the 100 Hz place, and RIT frequency, up to ± 9.9 kHz offset. An analog-type dial displays in 20 kHz steps.

By mode, the display indicates:

TUNE:	Zero-beat frequency
CW, USB, LSB:	Transmit carrier frequency.
AM:	Filter center frequency.
FSK:	Space frequency.

⑥ Main Tuning knob

This flywheel-weight knob controls the dual digital VFO's, which operate in 10 Hz step at 10 kHz/turn for normal slow tuning. When the knob is spun fast, the tuning rate automatically increases for fast QSY.

⑦ BAND switch

This selects one of the 10 HF amateur radio bands between 1.9 MHz and 29.7 MHz. The 1 MHz step switches (8) allow raising or lowering frequency in 1 MHz steps from 150 kHz to 29.9 MHz. WWV may be tuned at 5, 10, 15, or 20 MHz.

Note:

As supplied, reception only is possible on the 10, 18, and 24.5 MHz bands.

⑧ 1 MHz step switches

These raise or lower frequency in 1 MHz steps within the transceivers full frequency range. Depress UP to raise frequency and DOWN to lower frequency.

⑨ DIAL LOCK indicator

This lights when DIAL LOCK switch (57) is on.

⑩ VFO A indicator

This lights when VFO A is operating.

⑪ VFO B indicator

This lights when VFO B is operating.

⑫ MEMO (memory) indicator

This lights to indicate operation on a fixed memory channel frequency when the VFO/MEMO switch (20) is depressed to MEMO.

⑬ RIT indicator (R)

This lights when the RIT switch (27) is on.

⑭ ON AIR indicator (T)

This lights during transmission mode.

⑮ ANT TUNE (antenna tuner) indicator (T)

This indicates Auto Antenna Tuner operation and lights only when the Auto Antenna Tuner switch (46) is at AUTO, the mode switch is in Tune, carrier is inserted in transmit mode and the motors are running.

⑯ NOTCH indicator (R)

This indicates the notch filter is operating and lights when the NOTCH switch (30) is on.

[VFO operation]

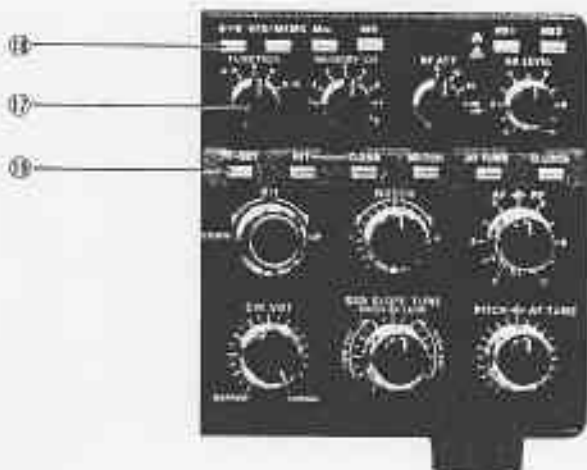

⑰ FUNCTION switch

This selects receive and transmit frequencies. Select position A or B for normal operation.

• **A-R:**

VFO A operates during reception and VFO B during transmission.

• **A:**

VFO A operates, VFO B stands by.

• **B:**

VFO B operates, VFO A stands by.

• **B-R:**

VFO B operates during reception and VFO A during transmission.

⑱ A=B switch

Depress this switch to equalize the frequency of the idle VFO to that of the operating VFO.

⑲ TF-SET switch

Depress this switch to "SPOT", or momentarily interchange reception frequency with transmission frequency. Frequency "SPOTTING" is possible only in receive and is ineffective during transmission.

[MEMORY]

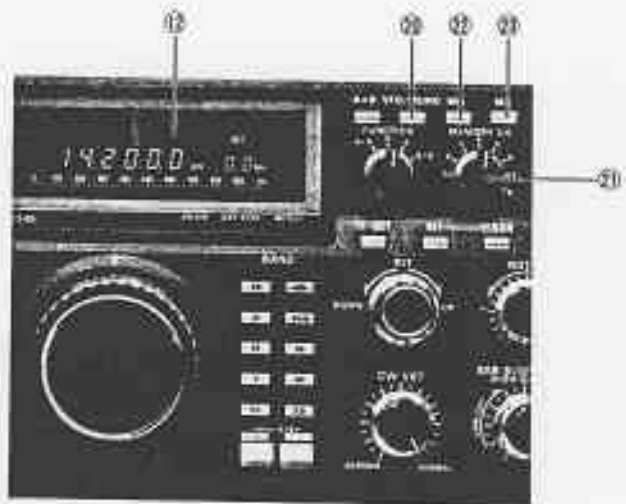

⑳ VFO/MEMO (memory) switch

This selects either VFO or MEMO (memory). At MEMO, the MEMO (memory) indicator (12) lights.

㉑ MEMORY CH selector

This selects one of the eight memory channels. To write in a frequency depress the Min switch and the displayed frequency will store in the selected channel. To recall from a memory channel, select the channel and depress the MR switch.

22 Min (memory write) switch

Use this to memorize a frequency into a selected channel.

23 MR (memory recall) switch

Use this switch to recall a memorized frequency.

[NOISE BLANKERS]



24 NB 1 (noise blanker 1) switch (R)

The noise blanker suppresses impulse noises such as automotive ignition noise, and permits otherwise unreadable weak signals to be received. The NB LEVEL control (25) varies the operating level of the noise blanker.

25 NB LEVEL control (R)

This sets the noise blanker operating level. Use only the minimum level necessary, according to operating conditions and noises. Excessive N.B. level will cause distortion or clipping.

26 NB 2 (noise blanker 2) switch (R)

Turn on NB 2 if "woodpecker" radar pulse noise is the source of interference. Note that when NB 2 operates, signal blanking time is longer than during NB 1 operation. The blanking "hole" will be apparent on the signal. This is not a symptom of trouble. The NB 2 switch actually operates both NB 1 and NB 2 simultaneously. It is recommended that you turn this switch OFF when there is no "woodpecker" noise.

[RIT]



27 RIT switch (R)

This controls the Receiver Incremental Tuning (RIT) circuit. When this switch is on, the RIT indicator (13) lights.

28 RIT control (R)

This permits independently varying the receive from the transmit frequency, up to ± 9.9 kHz, when the RIT is on. The RIT frequency is independently displayed to the 100 Hz order.

29 RIT-CLEAR switch (R)

This resets the RIT frequency to zero offset.

[NOTCH filter]

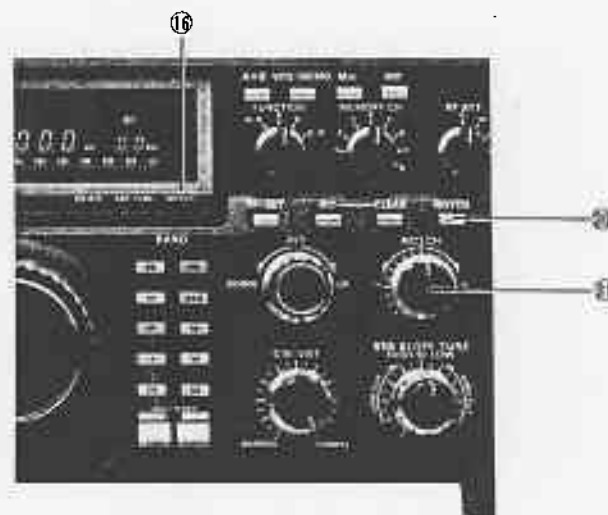

30 NOTCH switch (R)

This switch controls the NOTCH circuit and indicator.

31 NOTCH control (R)

Turn the NOTCH switch ON to activate the Notch filter. Adjust the notch frequency to null beat (carrier interference) signals.

[AF TUNE]



③② AF TUNE switch (R)

During CW reception, this circuit provides a tuneable, peaked AF response. Undesirable signals will be attenuated, while the desired CW signal will be peaked. The AF TUNE control (33) adjusts the peak frequency.

③③ AF TUNE control (R)

With the AF tune switch (32) ON, adjust this for the desired AF peak response.

[VOX & SPEECH PROCESSOR]

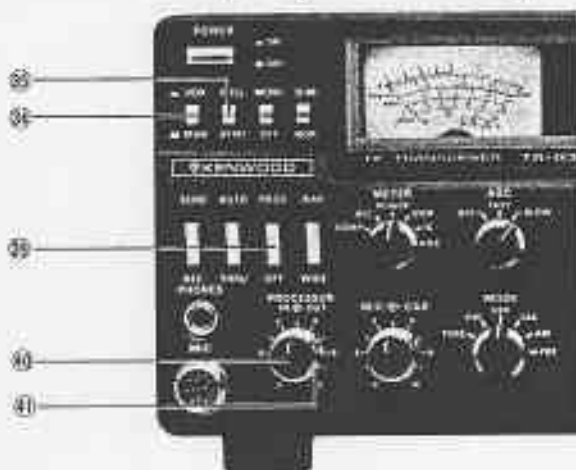
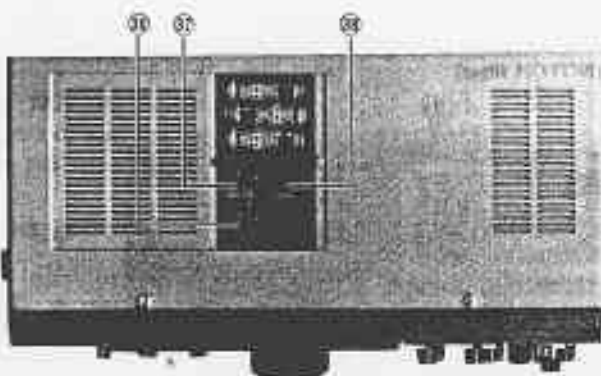

③④ VOX switch (T)

Turn this switch on to activate the VOX (Voice Operated Xmit) during SSB operation or break-in during CW operation.

③⑤ CW break-in selector (T)

During CW operation, this selects either full break-in (receives between keyed characters) at FULL, or semi break-in (holds transmitter on for preset delay by Delay control (38)) at SEMI.

③⑥ VOX GAIN (T)

This controls sensitivity of the VOX (Voice Operated Transmit) circuit. Adjust the gain for consistent key-over by voice, but not back ground noise.

③⑦ ANTI VOX control (T)

During VOX operation, the VOX may be operated by sound from the transceiver's speaker. Use just enough antivox to prevent speaker sound from tripping the VOX. ANTI VOX does not operate when headphones are plugged in on the front panel.

③⑧ DELAY control (T)

This controls hold time for SSB VOX, or CW semi-break-in operation. Adjust to hold the transmitter on between words, at a normal rate of speech, or keying speed.

③⑨ PROC (SPEECH PROCESSOR) SWITCH (T)

This switch is used during SSB operation. Set the switch to the ON position and the speech processor will be activated, increasing average "talk power". Compression level can be adjusted by the processor controls.

④⑩ PROCESSOR-IN (input level) control (T)

This control adjusts compression level. Set the meter switch (2) to the COMP position and adjust this control while observing the meter COMP scale. It is suggested that 10 dB or less compression be used. Use the MONITOR, or an oscilloscope, when adjusting the compression level.

④⑪ PROCESSOR-OUT (output level) control (T)

This varies the speech processor output level. Adjust for an on-scale ALC reading at voice peaks.

[OTHER CONTROLS]

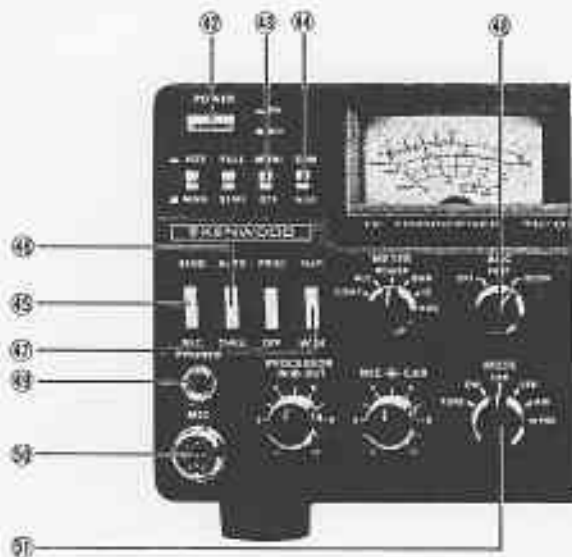

42 MAIN POWER switch

Controls all power to the transceiver. Before operating the POWER switch, confirm that the VOX (34) is off, and the standby switch (45) is set to the reception mode.

43 MONI (MONITOR) SWITCH (T)

This delivers a sample of the demodulated transmit IF signal to the AF circuit for monitoring modulation during SSB operation.

44 DIM (dimmer) switch

For operator convenience, this switch selects either bright or dim intensity of both the digital display, and meter illumination.

45 STAND-BY SWITCH (T)

This two-position level switch selects:

- **REC:**
The transceiver is receiving unless the microphone PTT switch, or the VOX circuit is activated.
- **SEND:**
Locks the unit in transmit.
Transmission is locked out (reception only) if the selected transmission frequency is outside the amateur radio bands, or the final stage thermal-protects (is deactivated due to excessive heat-sink temperature).

46 Auto Antenna Tuner switch (T)

- **AUTO:**
The Auto Antenna Tuner will operate during transmission in the tune mode, with carrier inserted.
- **THRU:**
The Auto Antenna Tuner is deactivated and bypassed during transmission.
When the AUTO mode is selected and the ANT TUNE indicator (15) is lit, the two variable capacitor drive motors are operating. Wait until the indicator goes off before switching to an operating mode.

47 NAR/WIDE filter selector (R)

This switches the IF bandwidth to narrow from the normal wide position. (Narrow filters are optional.) This switch does not operate in SSB mode.

48 AGC SWITCH (R)

This controls the AGC (Automatic Gain Control) circuit:

- **OFF:**
AGC disabled (no AGC).
- **FAST:**
Normally used for CW and FSK operation.
- **SLOW:**
Normally used for SSB and AM operation.

49 PHONES JACK (R)

The headphones jack allows use of a 4 to 16 ohm headphone through a 1/4" phone plug. When phones are used the speaker and antivoice are disabled.

50 MIC (microphone) connector (8 Pins) (T)

Microphone audio input. Frequency UP/DOWN control and PTT lines are included. The optional MC-60A is recommended. Pin assignments of the MIC connector are shown below.

Note:

When operating the microphone, be sure that the MC-60A MIC AMP switch is set to OUT.

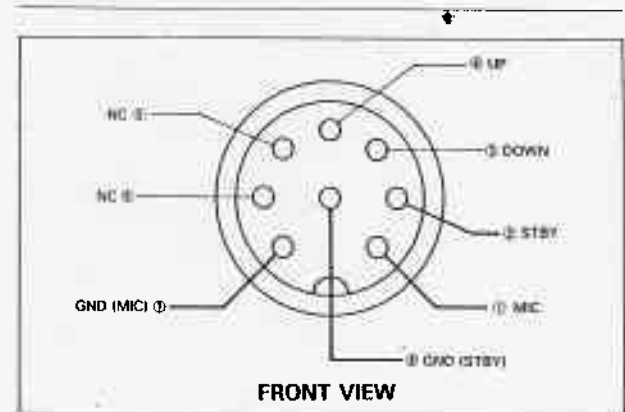

⑤1 MODE SWITCH

The mode switch selects type of emission, and TUNE.

• TUNE:

Always use this position to make antenna tuning and initial linear amplifier tune-up adjustments. Input power to the final amplifiers is reduced approximately 50% to protect the final power transistors from possible damage during adjustments. The key circuit is locked-on and the key is disabled.

• CW:

Select this position for CW operation. If a key is connected it must be closed to obtain transmitter output.

• USB:

Used for upper-sideband operation. International Amateur practice dictates the use of USB on and above the 10 MHz band.

• LSB:

Selects lower-sideband. International Amateur practice dictates the use of LSB on and below the 7 MHz band.

• FSK:

RTTY operation is available with a terminal unit and teletypewriter.

• AM:

Select this position for AM operation.

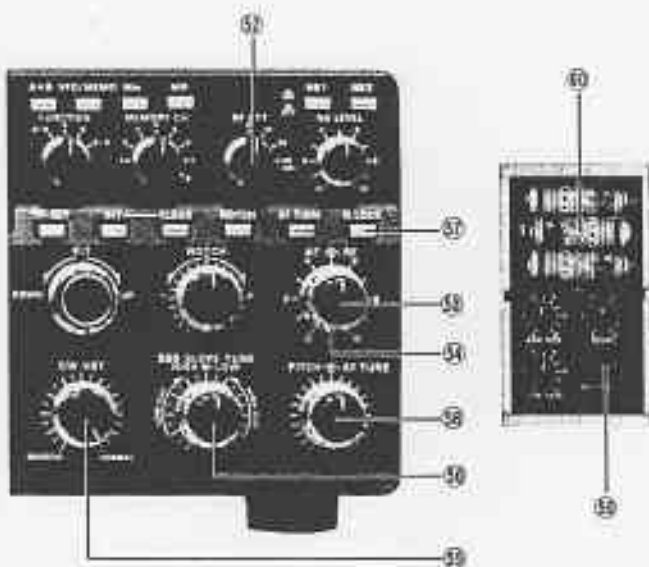

⑤2 RF ATT (RF attenuator) switch (R)

This switch permits insertion of 10, 20, or 30 dB attenuator in the receiver antenna circuit, to protect the RF amplifier and mixer from excessive input signal distortion.

⑤3 AF GAIN (R)

This adjusts receiver audio level. Volume increases clockwise.

⑤4 RF GAIN (R)

This adjusts receiver RF amplifier gain. Turn fully clockwise for maximum gain and a correct S-meter reading.

⑤5 CW VBT CONTROL (R)

The CW VBT (Variable Bandwidth Tuning) continuously adjusts the IF Filter bandwidth to eliminate radio interference. For normal operation, this control may be left fully clockwise (NORMAL Position). If a narrow filter is selected in either the CW, TUNE, FSK, or AM mode, the rate of bandwidth change is reduced for a vernier effect. Normally the control may remain fully clockwise. Without an optional filter, the circuit is effective only when WIDE is selected during CW, TUNE, or FSK, or when NAR is selected during AM operation.

⑤6 SSB SLOPE TUNE control (R)

This permits independently varying the upper and lower IF bandwidths. High and low audio frequencies may be simultaneously cut (tuned). Optimum IF bandwidth may be selected according to interference conditions. This circuit operates only in the SSB mode.

⑤7 D. (DIAL) LOCK switch

This push button electrically locks the frequency of the working VFO. When this switch is on, the tuned frequency does not vary when either the tuning knob or BAND switch is operated. This is convenient when operating on the same frequency for extended periods. The RIT does operate with the D. LOCK switch on. The D. LOCK indicator (9) lights to show operation.

⑤8 CW PITCH control

This permits control of pitch during CW reception. During transmission, this control simultaneously adjusts CW side tone frequency to match that of the received signal.

⑤9 CAL (marker) switch (R)

In the ON position, receive frequency can be calibrated at 100 kHz intervals using the built-in oscillator. The marker is also used when calibrating the internal master reference oscillator. See Figure 8-3 for location and calibration instruction.

⑥0 Battery compartment

Three AA type manganese or alkaline dry cells may be installed for memory backup. Service life of the cells is about one year. If the transceiver is to be stored, it is recommended that the dry cells be removed.

4.2 REAR PANEL

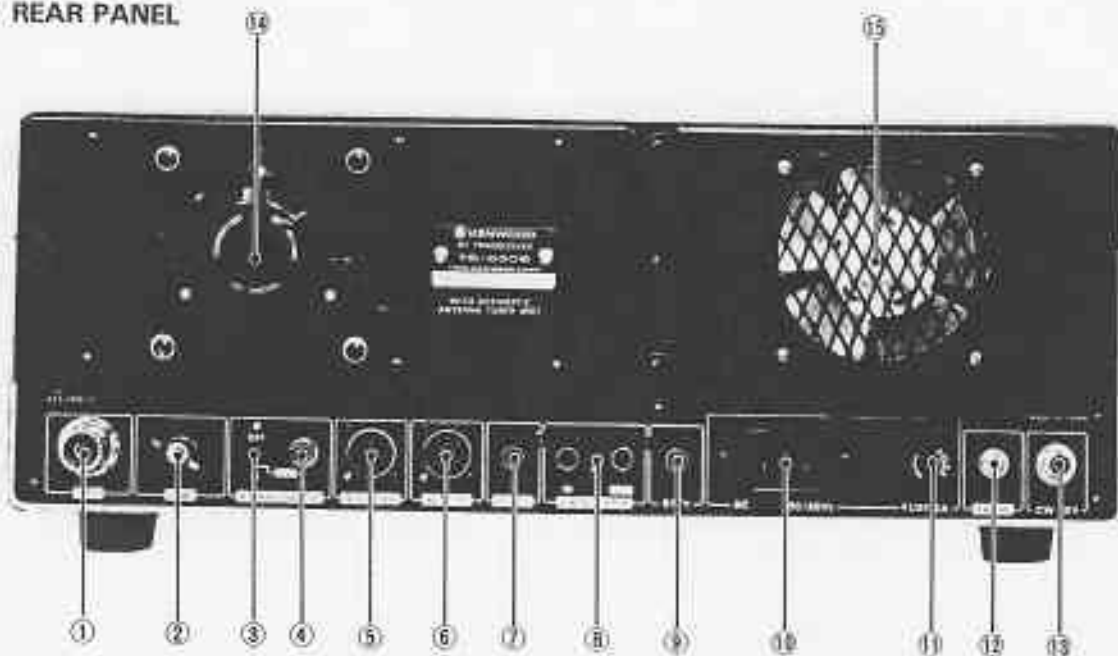

① ANTENNA CONNECTOR

This SO-239 coax connector should be attached to a suitable 50 Ω antenna for transmitting and receiving.

② GND (ground) terminal

To prevent electric shock, as well as RFI and BCI, connect the transceiver to a good earth ground.

③ RX. ANT output switch

When using the RX. ANT terminal to feed another receiver, place this switch to the OUT position. The TS-930S's receiver antenna input will be disconnected.

④ RX. ANT terminal

Terminal to connect an external receiver. Signal from the antenna in use with the TS-930S will be output only during reception to the external receiver.

⑤ XVERTER (transverter) terminal

This 8 Pin DIN connector is used to interface a VHF or UHF transverter.

PIN	FUNCTION	PIN	FUNCTION
1	Ground	5	Transverter input (RX)
2	Relay control (+ on transmit)	6	Transverter ALC input
3	Ground	7	Transverter output (TX)
4	X-verter ON-OFF control	8	HF ANT output

Table 4-1 XVRTR Terminal Pin-OUTS

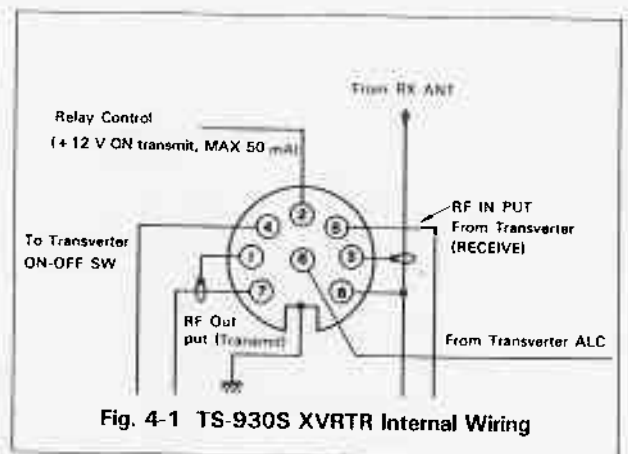

Fig. 4-1 TS-930S XVRTR Internal Wiring

⑥ REMOTE CONNECTOR

This connector is used to interconnect a linear amplifier or other accessory item. See page 32 for details. Use the 7 Pin DIN plug provided for connection.

⑦ IF OUT jack (R)

A high-level, narrow-bandwidth 100 kHz IF output, taken before the receiver produce detector, for scope display of the received signal waveform (to feed an SM-220, verticle input).

⑧ PHONE PATCH jacks

Use the IN terminal for transmitting a 600 Ω low impedance line or audio input (phone patch SSTV, AFSK, or other input). The OUT terminal provides 600 Ω line output for phone patch, SSTV, AFSK or other application.

⑨ RTTY KEY jack (T)

Jack for FSK operation. Connect this directly to the low voltage (5 V DC or less) terminal unit output using an RCA plug. DO NOT connect a 60 MA local-loop direct: use a keying relay to provide a switched ground.

⑩ Power connector

Connector for AC power source. Make certain the transceiver's voltage selector is adjusted to your local line voltage BEFORE turn-on.

⑪ AC FUSE

This fuse protects the power supply against short circuits. Never use a higher amperage fuse than specified; it will eventually cause extensive damage. If the fuse blows, try to determine the cause before replacing. For 120 volt operation, use a 6 ampere fuse. For 220/240 volt, use a 4 ampere fuse.

⑫ EXT. SP (speaker) jack (R)

The receiver audio output can be connected through this jack to an external 4 to 16 ohm speaker. The internal speaker is disconnected when an external speaker is connected.

⑬ CW. KEY jack (T)

Using shielded line, connect a key to this 1/4" phone jack for CW operation. Key open-terminal voltage is approximately 10 V DC.

⑭ Cooling fan (final section)

Electronic-controlled automatic cooling fan for the final amplifier section.

⑮ Cooling fan (power supply)

Electronic-controlled automatic cooling fan for the power supply section.

SECTION 5. OPERATION

5.1 Reception (I)

The numbers in parenthesis refer to switch and control assignments as listed in the preceding chapter.

NOTE:

Set the MIC and CAR controls to minimum to prevent accidental transmission before tune-up. The TS-930S must be operated into a 50 ohm antenna or dummy load with an SWR less than 2:1. Random length wire antennas or light-bulb dummy loads should not be used. Conventional half-wave dipoles and beam antennas should be used only at or near their resonant frequency. Exceeding an SWR of 1.5:1 can damage the output stage of the transceiver.

(1) Basic Procedures for Receive Operation

The TS-930S has many advanced features such as CW, VBT, SSB slope tuning, NOTCH, etc. to assure enhanced receive operation. For the use of these specialized controls and switches, refer to Section 5.2 "Reception (II)".

With a suitable antenna and microphone or key connected to the transceiver, set the controls as described.

[INITIAL SETTING]

	Controls	Reception
Front panel	POWER switch	OFF
	VOX switch	OFF
	MONI switch	OFF
	STAND-BY switch	REC
	SSB reception	SLOW
	CW reception	FAST
	MODE	Selected reception mode
	MEMO switch	VFO
	FUNCTION	A
	RF ATT	0 dB
	RIT	OFF
	NOTCH	OFF
	AF TUNE	OFF
	D. LOCK	OFF
	AF control	Turn fully counterclockwise
RF control	Turn fully clockwise	
SSB slope tune	High	Turn fully clockwise
	Low	Turn fully counterclockwise
Rear panel	RX ANT switch	OFF

Table 5-1

- Turn the POWER switch (42) on. The meter and frequency display group will light, indicating the TS-930S is operating.

- Select a band with the BAND switch (7) or 1 MHz step switches (8).
- Advance the AF gain control (53) clockwise until some receiver noise or signal is heard from the speaker.
- Adjust the main tuning within the frequency range of the selected Amateur band until a signal is heard. Tune the signal for clearest reception.

(2) WWV Reception

Set the band switch to "10" and turn the tuning control to 10.0 MHz.

5.2 RECEPTION (II)

This section covers operation of controls and switches to provide maximum performance from the TS-930S.

1 RF ATT switch

A strong adjacent signal may conceal a desired weak signal, or the S meter may deflect off-scale when the receiver is tuned to a local strong signal. The input to the RF amplifier may be attenuated by 10, 20 or 30 dB using the RF ATT switch. This will reduce or eliminate interference and distortion from excessively strong signals.

2 RF GAIN CONTROL

RF GAIN is controlled by changing the AGC threshold voltage. Adjust the RF GAIN so the S-meter does not deflect excessively. This also reduces noise during reception. For normal operation, this control should be turned fully clockwise for maximum sensitivity.

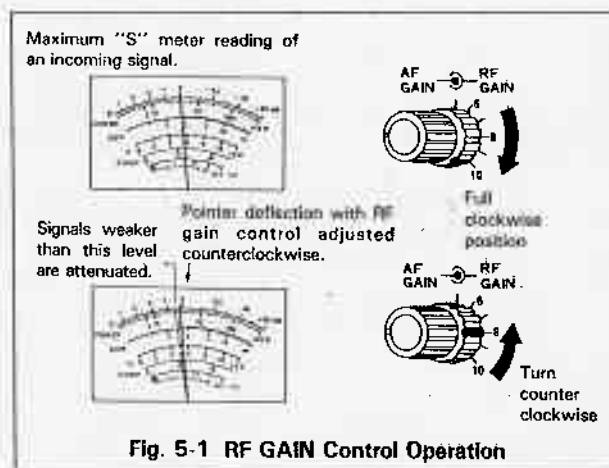

3 AGC (AUTOMATIC GAIN CONTROL)

Set the AGC switch to the appropriate position: Generally for SSB and AM, SLOW, for CW and FSK FAST, and for very weak signals, the AGC may be turned OFF.

Simultaneous Use of the RF GAIN CONTROL and AGC Switch

If a strong signal (such as a local station) appears in the vicinity of the intended receive signal, the S meter may show unusual deflection due to the AGC voltage developed from the strong disturbing signal. If this occurs, turn the RF GAIN down so the meter pointer remains at about the original deflection peak and turn the AGC switch OFF. This will eliminate the unwanted AGC voltage and permit clear reception.

4 RIT

First, cancel any previously programmed offset using the Clear key (29), then turn the RIT switch ON.

The RIT control allows shifting the receive frequency ± 9.9 kHz, displayed to the 100 Hz place, without changing the transmit frequency.

With the RIT switch ON, the RIT indicator will light, and receive frequency can be adjusted by using the RIT control.

NOTE:

When the RIT is ON, transmit frequency is different from the receive frequency. For normal operation, leave the RIT switch OFF. It should be turned ON only when needed.

To reset the RIT, depress the RIT-CLEAR switch.

5 SSB SLOPE TUNE control

During SSB reception, this permits shifting the apparent IF bandwidth to reject interference.

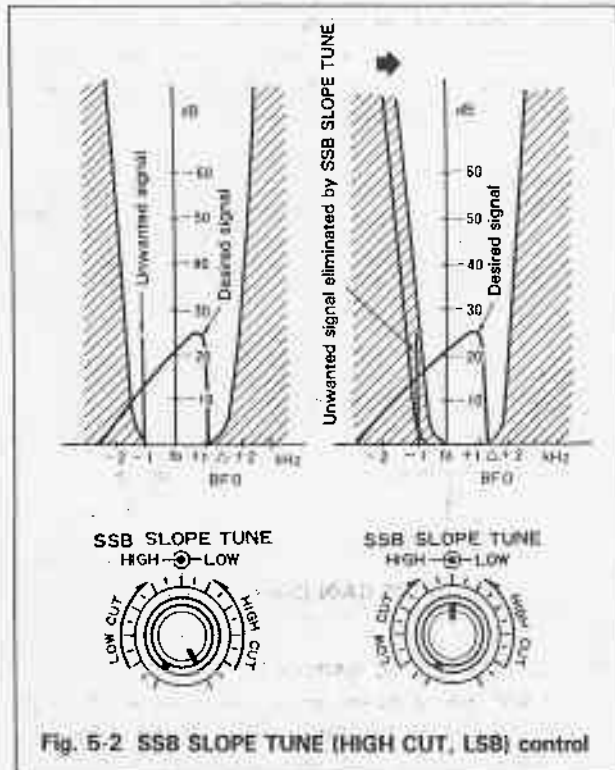

Fig. 5-2 SSB SLOPE TUNE (HIGH CUT, LSB) control

- **SSB SLOPE TUNE HIGH CUT control:**
Adjust the HIGH CUT control counterclockwise, and interference of higher frequency than the desired signal will be rejected. In the resulting AF signal, the high-frequency components are cut.
- **SSB SLOPE TUNE LOW CUT control:**
Turn the LOW CUT control clockwise and interference of lower frequency than the desired signal will be rejected. In the resulting AF signal, the low-frequency components are cut. Maximum bandwidth occurs at low cut full counterclockwise, and high cut full clockwise.

6 CW VBT (Variable Bandwidth Tuning) control

This control is used to eliminate radio interference by changing the IF passband-width. Use this control in conjunction with the NOTCH filter to obtain optimum results.

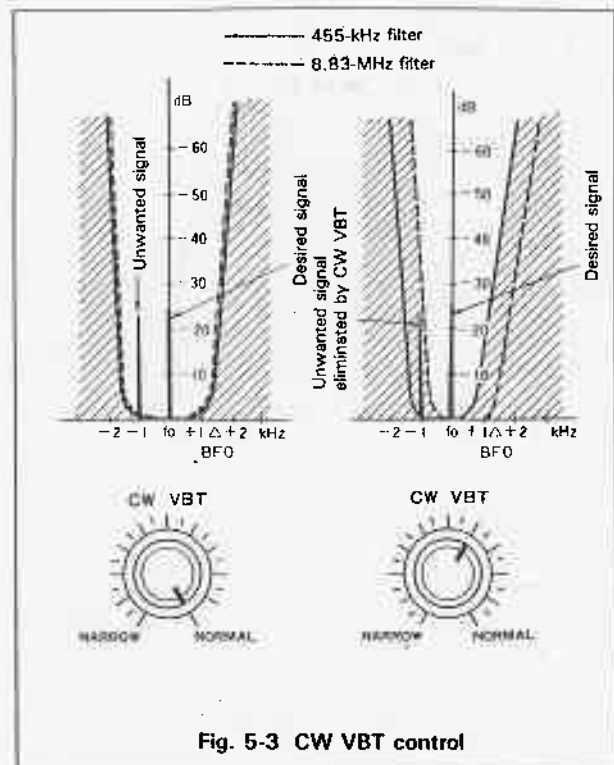

Fig. 5-3 CW VBT control

By setting the CW VBT control to the NORMAL position, maximum passband-width is obtained. The IF filter passband-width is narrowed as the control is adjusted counterclockwise, while center frequency remains unchanged. Fig. 5-3 illustrates operation. The range of variability depends on the type of optional filter used.

- When the filter bandwidth is 2.4 kHz (without an optional filter), the passband-width varies within the range of 2.4 kHz to 600 Hz.
- With an optional YK-88C-1 filter (8.83 MHz, 500 Hz bandwidth) or YG-455C-1 filter (455 kHz, 500 Hz

bandwidth), the passband-width varies from 500 Hz to approximately 150 Hz.

Since an optional filter's center frequency is 700 Hz higher than that of the built-in 2.7 kHz filter, the CW receive tone will be about 800 Hz without using the pitch control. Fig. 5-3 shows the CW VBT function with an optional filter.

7 NOTCH CONTROL

If a single tone such as a CW signal is superimposed on the receive signal, turn the NOTCH ON and adjust the NOTCH control to eliminate or minimize the beat signal. A beat of approximately 1.5 kHz can be eliminated at the center position of the control. In USB, CW, or AM mode, a beat signal lower than 1.5 kHz can be eliminated by turning the control clockwise. In LSB or FSK mode, adjust the control counterclockwise.

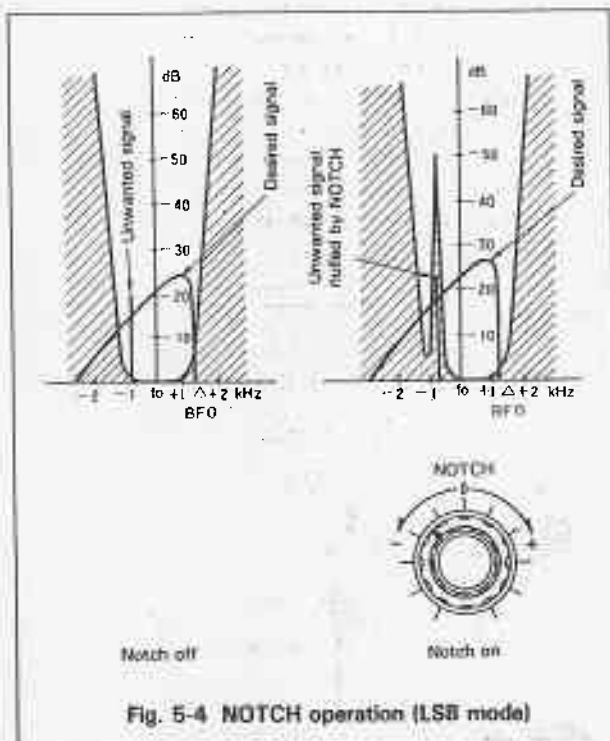

Fig. 5-4 NOTCH operation (LSB mode)

8 AF TUNE circuit

During CW operation, this audio filter having a peak center frequency of approximately 800 Hz, adjustable ± 400 Hz, provides additional rejection of noise and interfering signals whose pitch (tone) falls outside the audio passband.

Turn the AF TUNE switch ON and adjust the AF TUNE control (33) to peak the desired signal.

9 NB (noise blanker) switch

• NB1 switch:

For pulse type noise, such as generated by automotive ignition systems, turn the NB1 switch ON. Adjusting the NB LEVEL control varies the blanker's threshold, eliminating even low level noises.

NOTE:

If high level signal or noise is present on an adjacent frequency, do not use excessive NB threshold LEVEL as it may distort the received signal. If you are operating near other strong signals, use the RF ATT along with the noise blanker level control.

• NB2 switch:

Turn on this switch if "woodpecker" radar pulse noise is the source of interference.

5.3 Transmission (I)

This section covers adjustment of the transceiver for transmission.

1. Transmission output impedance

The TS-930S transmission output impedance is 50 ohms. Use only a 50 Ω antenna, and coaxial feed system.

2. SWR

Adjust antenna SWR to 1.5:1 or better. With the AT-930 Auto Antenna Tuner installed, it is possible to impedance match the antenna to the transceiver within the range of 20 Ω - 150 Ω (However, 30 - 100 ohms for 18 MHz and 24.5 MHz.). In all cases, it is recommended that antenna SWR is below 1.5:1.

3. Antenna terminal

Never operate the transmitter when the antenna terminal is open (neither antenna or dummy load connected).

To test the transceiver, use a 50 Ω , 100 W (minimum) dummy load. If you perform ON-THE-AIR test transmissions with an antenna, you may become the cause of interference with other stations on the band.

4. Initial setting

Refer to Table 5-2 for initial transmitter switch settings.

Table 5-2 Control and switch setting for transmission
(Set the Remaining controls as listed in Table 5-1.)

Switch	Position	Switch	Position
BAND switch	To desired band	RIT switch	OFF
Stand By switch	REC	AUTO switch	OFF
MODE switch	CW	PROC switch	OFF
METER switch	ALC		

Table 5-2

5. Antenna-tuner

If the TS-930S is operated into an antenna with a high SWR, the final stage SWR protection circuit may operate (when SWR is greater than approximately 2:1). Therefore, use the AT-930 Auto Antenna Tuner or AT-230 (option) when antenna SWR is beyond nominal limits.

To operate the AT-930 Auto Antenna Tuner, place the MODE switch to TUNE, AUTO-THRU switch to AUTO and then transmit. Adjust the CAR control so the ALC meter deflects slightly. If, after changing bands, the auto antenna tuner does not stop at match within a reasonable time (within 20 seconds), momentarily return to the receive mode, and then again operate the tuner for a match. The tuner is capable of matching a 20 - 150 Ω load, or approximately up to a 2.5 : 1 VSWR. (However, 30 - 100 ohms for 18 MHz and 24.5 MHz.)

If the antenna and feed system exceed this range, the tuner may not stop, since it is beyond the auto tuner's capability. If the tuner does not stop within 20 seconds, discontinue

auto-tuner operation and verify the VSWR of your system. Some adjustment to the antenna may be required to bring the radiating system within the tuner's capability.

Note:

When adjusting an external antenna tuner other than the AT-930, place the transceiver MODE switch to TUNE for reduce transmitter output.

5.4 Transmission (II)

To obtain maximum transmitter performance from your TS-930S you should understand the proper operation of the following controls and switches.

1. SSB transmission

- (1) Connect a microphone to the MIC input.
- (2) For operation up to the 7 MHz band, place the mode switch to LSB. For operation on or above the 10 MHz band, use the USB mode.
- (3) Place the METER switch to ALC, and the standby switch to SEND, or use the microphone PTT switch (if provided).
- (4) Adjust the MIC gain control for an on-scale ALC reading on voice peaks. (Disregard power and IC meter readings in SSB- they are not accurate or relevant.)

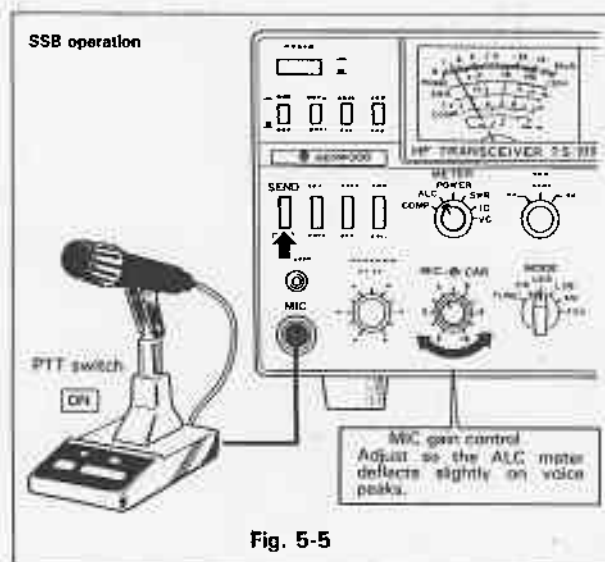

Fig. 5-5

2. CW transmission

(See page 24, CW operation, for details.)

- (1) Using shielded line, connect a key to the rear-panel KEY jack.
- (2) Place the MODE switch to CW, and the meter switch to ALC.
- (3) Place the standby switch to SEND.
- (4) Depress the key and adjust the CAR control for a half scale ALC reading (see Figure 5-7).

In CW mode, sidetone output is controlled by the MONITOR switch.

Note:

The frequency display indicates transmit carrier frequency.

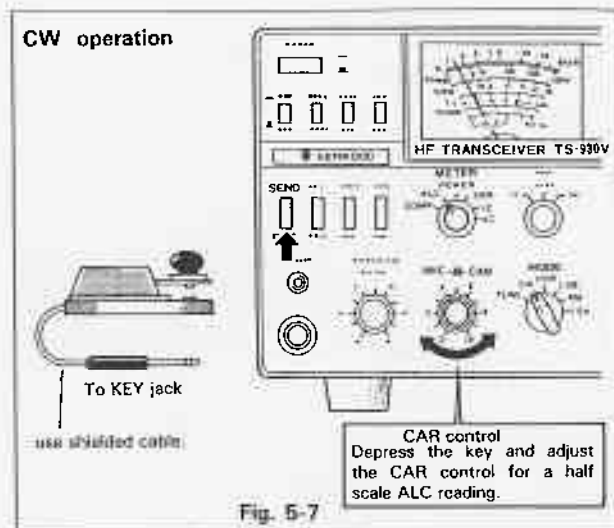
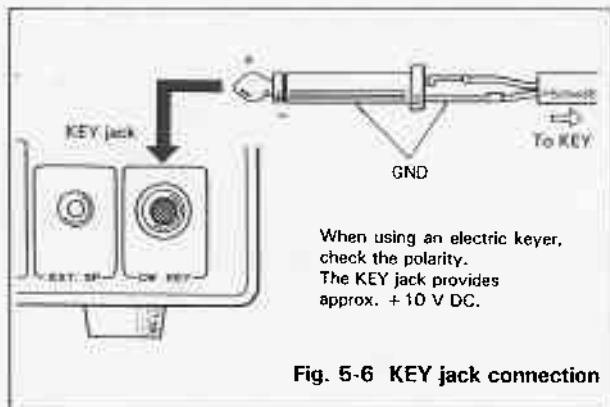

3. RTTY

RTTY operation requires a demodulator and a teletypewriter. A demodulator including 2,125 and 2,295 Hz (170 Hz shift) filters will be acceptable and may be connected directly to the PHONE PATCH OUT jack. To use the transceiver's FSK circuit with older high voltage teletypewriter equipment, use a keying relay in the teletypewriter closed loop and connect the relay contacts to the rear-panel RTTY KEY jack.

Figure 5-8 shows the frequencies relationship between reception and transmission with the TS-930S.

In FSK operation, the space frequency is indicated on the frequency display.

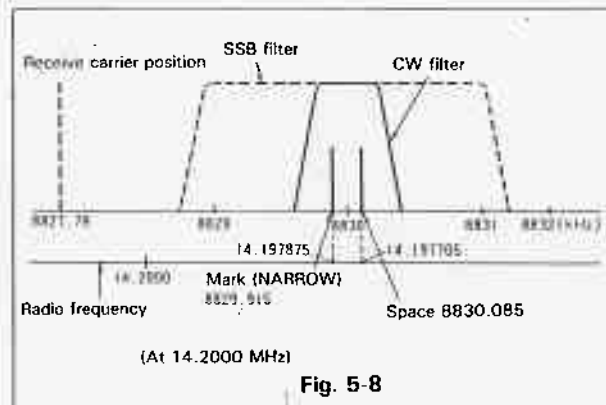

4. FSK transmission

1. Connect an FSK generator or RTTY terminal unit output to the rear-panel FSK KEY jack (9).
2. Place the MODE switch (51) to FSK.
3. Place the standby switch (45) to SEND.
4. Place the METER switch (2) to ALC.
5. Adjust the PROCESSOR-OUT control (41) for an on-scale ALC reading.
6. To receive connect the PHONE PATCH output to the demodulator input terminal.

• Operation

Place the MODE switch to FSK.

CAUTION

When transmission is greater than 15 minutes continuous in the FSK mode, reduce the RF power to approximately 50 W by adjusting the SPEECH PROCESSOR control.

5. AM transmission

Setting the MODE switch to AM allows AM transmission. To adjust carrier, adjust the CAR control so the power meter reading is approx. within 15 - 20 W.

Speak into the microphone and adjust the MIC volume control so the ALC meter deflects a little at the peak voice level. Note that the ALC full scale reading results in distortion.

6. SPEECH PROCESSOR

In SSB operation (particularly DX operation), it may be desirable to increase "talk-power" by using the speech processor. This may make the difference between a marginal, and a copiable signal.

• Operation

The speech processor system in the TS-930S is an RF clipper using two filters.

Turn the PROCESS switch ON and place the METER switch to COMP. Adjust the PROCESSOR IN control while speaking into the microphone in a NORMAL tone of voice for a peak COMP scale reading of no more than 10 dB. Do not overdrive the COMPRESSOR: This will deteriorate voice quality, increase transmitter noise level, and in general make copying your signal more difficult.

Next, set the METER switch to ALC and adjust the PROCESSOR OUT control while speaking into the microphone. Ensure that meter deflection is within the ALC zone.

NOTE:

When a high-output microphone is used, input overload and distortion may result. To prevent this, use an attenuator in the microphone circuit as shown below, or connect a 10 – 33 kΩ resistor (depending on the microphone used) across the microphone input. ("Normal" mic control setting should be approximately 12 o'clock).

The MC-60A microphone is recommended.

Microphone sensitivity: $-56.0 \text{ dB} \pm 3 \text{ dB}/50 \text{ k}\Omega$; $-71.0 \text{ dB} \pm 3 \text{ dB}/500 \Omega$ (preamp. deactivated)

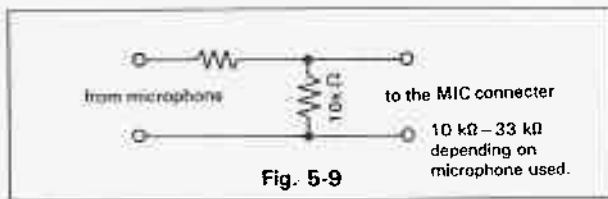

7. Monitor

To monitor transmitted SSB signal quality, turn the MONITOR switch ON to demodulate a sample of the transmit IF signal.

This feature is useful for checking modulation, or when adjusting the speech processor.

When monitoring, use headphones to avoid audio feedback.

If the MIC gain control is incorrectly adjusted, the monitor output may sound distorted.

8. VOX (Voice Operated Transmit) OPERATION

Adjust the transceiver as described in the previous paragraphs. Depress the VOX switch to ON and while speaking into the microphone, increase the VOX GAIN control until the VOX relay just operates. For VOX operation it is sometimes desirable to close-talk the microphone to prevent background noises from tripping the transmitter.

- (1) Check that the ALC reading for voice peaks is still within range on the meter. If necessary, readjust the MIC control for proper ALC reading.
- (2) If the VOX circuit is activated by speaker output, adjust the ANTI-VOX control as necessary for proper VOX operation.
- (3) Do not use excessive VOX or ANTI VOX gain more than necessary to control VOX operation. If the VOX circuit transfers between words, or holds too long, adjust the release time-constant by the DELAY control.

9. CW OPERATION (fig. 5-10)

Using shielded line, connect a key to the rear panel KEY jack, set the MODE switch to CW, and set the stand-by switch to SEND for transmitting.

In CW mode, side tone output is controlled by the MONI switch.

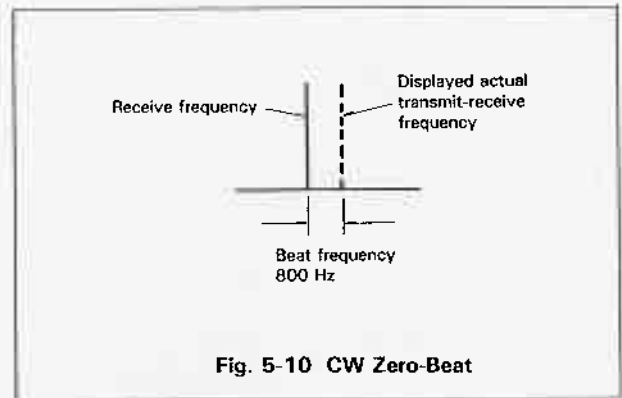

(i) Reception

The TS-930S operates in two different CW modes; WIDE and NARROW. In the WIDE mode, the SSB filter (pass bandwidth 2.4 kHz, -6 dB) is used.

In the NARROW mode, option CW filters (YK-88C-1, YK-88C-CN-1 or YG-455C-1) may be used to narrow the IF pass bandwidth to 500 Hz (-6 dB) or 250 Hz.

During CW reception, the TS-930S operates in the LSB mode.

■ OPERATION WITHOUT CW FILTERS

To receive CW, set the CW Pitch control to its center position and the RIT switch to OFF. Adjust the main tuning for about an 800 Hz beat and your transmit frequency will be tuned (zeroed) to the transmit frequency of the station you are receiving. If zero beat cannot be tuned easily, place the MODE switch to TUNE and adjust the main tuning for zero beat. Then switch back to the CW mode. Your transmit frequency is now adjusted to that of the station you are working, and receive pitch will be approximately 800 Hz. You may now adjust the pitch control to suit your preference. If interference is encountered, adjust the CW VBT. For more convenient and effective CW operation, use of the optional CW filters is suggested.

■ OPERATION WITH CW FILTERS (OPTIONAL)

Set the VBT to normal and the pitch control to its center position with the RIT OFF. Adjust the main tuning for maximum S-meter deflection. Receive signal pitch will be about 800 Hz, indicating correct tuning.

■ KEY CONNECTION (Fig. 5-6)

Your key should be connected as illustrated in Fig. 5-6. Use shielded line from the key to transceiver.

NOTE:

When using an electronic keyer, set polarity of the keyer for positive keying.

■ CW break-in

During CW operation, the transceiver will automatically enter transmission mode when the key is depress, if the VOX switch is turned on in the standby mode.

There are two break-in modes in which TS-930S may operate.

(1) Semi break-in

Place the VOX switch ON and the Semi/Full switch at Semi. The SEND/REC switch remains in receive.

Transmission mode is automatically entered when the key is depressed and will remain on for an adjustable period after the key is released. Adjust the hold time with the VOX DELAY control.

(2) Full break-in

Set-up as for Semi break-in, except place the Semi/Full switch to Full.

The transceiver will immediately transfer to receive mode between keyed characters.

Full break-in capability allows the DX or contest operator to respond mode quickly to the calling station. To the RAG chewer, it allows a mode natural conversation.

CAUTION:

Full break-in operation is not possible in combination with the TL-922(A) linear amplifier.

10. Final protection

The TS-930S incorporates four final stage transistor protection circuits. Two protection circuits monitor antenna VSWR and final amplifier current and automatically reduce output power, if a fault occurs. A third circuit monitors the final heat sink temperature and controls the cooling fan when the temperature elevates to 50°C. This is sufficient to cool the heat sink under normal circumstances. The fourth protection circuit operates if the heat sink temperature has exceeded safe-limits because of poor convection cooling (above 75~80°C). Transmission will automatically be locked-out and the transceiver will return to reception mode.

When the temperature protection circuit is on the cooling fan operates at increases speed for faster cooling. When the heat sink temperature falls below to 65~70°C, this protection circuit resets and the transmitter is again enabled.

The fan will stop when the heat sink returns to 45°C.

5.5 BAND SWITCH

The BAND switch operates separately for VFO A and B. (See also 2 VFO operation.)

(1) BAND switch

These are momentary push switches operating an electronic latch. Data entry is confirmed by a "beep". Depress the pushbutton for any desired band.

(2) 1-MHz step switches

Depress the UP or DOWN switches and the frequency will increase or decrease in 1 MHz steps at each key press.

5.6 2 VFO OPERATION

The TS-930S has two VFOs, A and B, which are controlled by a microprocessor. The display group indicates which VFO is operating, and its full frequency.

FUNCTION switch	Reception	Transmission
A - R	A	B
A	A	A
B	B	B
B - R	B	A

Table 5-3

(1) FUNCTION switch

This selects VFO A, VFO B, VFO A-R, or VFO B-R. In the VFO A-R and VFO B-R modes, either split frequency (in the same band), or cross band operation is available. This system closely approximates the feel of operating a separate receiver and transmitter. The FUNCTION switch selects working VFOs, as summarized above.

In addition, the unused VFO may be used as a memory. For example, when waiting for a scheduled contact, store the schedule frequency in one VFO and continue to operate or search on the other VFO until your scheduled contact.

(2) A=B switch

Use this switch to equalize the frequency of the idle VFO to that of the working VFO.

(3) D. LOCK switch

The D. LOCK switch permits electrically locking the frequency of the working VFO. With this switch on, VFO A and B frequencies will not vary when the tuning control or BAND switch is operated. For convenience, however, the RIT does operate.

5.7 MEMORY CH (MEMORY CHANNEL) OPERATION

Use the MEMORY channels to record often used frequencies.

1. Writing-in memory

Depress the Min switch and the frequency selected by the main tuning control will be written in channel 1-8, as selected by the MEMORY CH switch (21)

2. Recalling from memory

There are two methods available to recall a frequency from memory:

• Recall using the VFO/MEMO switch

Use this to operate on a MEMORY CH as a fixed (non-tuneable) frequency. Returning to VFO operation restores the original VFO frequency.

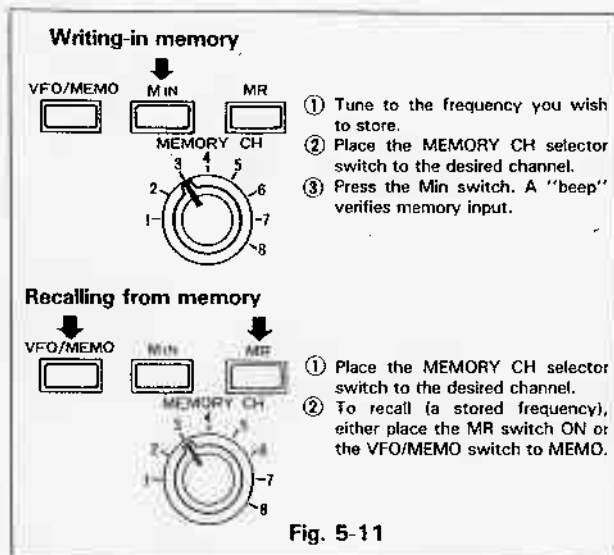

• Recall using the MR switch

Use this to recall a memorized frequency (channel 1-8) to either VFO for tuneable operation. (The original VFO frequency will be lost.)

3. MEMORY channel battery backup

In the TS-930S, frequencies are stored in the microcomputer's RAM (random access memory). Data will be lost if the POWER switch (42) is turned off.

However, the memory may be retained by a battery backup system while the POWER switch is off. The RAM is powered by the batteries installed in the battery compartment (60). Backup current is less than 10 μ A, and service life of the battery pack is approximately one year.

5.8 TF SET OPERATION

(1) Transmission frequency split may be either set or checked by simply depressing this switch.

If you depress this switch during A-R or B-R mode VFO operation, the transmission VFO operates and displays, while the transceiver remains in the reception mode.

If RIT is on, its frequency will be displayed and the transmit VFO will offset. Therefore, when setting transmission frequency, turn the RIT off.

(2) When this switch is released, the mode selected by the FUNCTION switch will be restored. This prevents accidental transmission on the receive frequency during a split-frequency QSO, while permitting quick selection of the transmit frequency.

(3) The TF-SET switch works only when the FUNCTION switch is at the A-R or B-R position (during split-frequency operation where the transmission frequency varies from the reception frequency). The TF-SET switch does not operate during transmission. All modes selected by the FUNCTION switch are indicated by the display group to prevent misoperation.

5.9 COOLING FAN OPERATION

The cooling fan operates automatically when the heat sink temperature rises, and stops when the temperature falls.

The heat sink is die-cast aluminum integral with the rear panel for sufficient heat dissipation. Therefore, the cooling fan will rarely operate during ordinary operation.

When the cooling fan operates, insure adequate ventilation to insure good heat dissipation.

5.10 SHORT WAVE RECEPTION

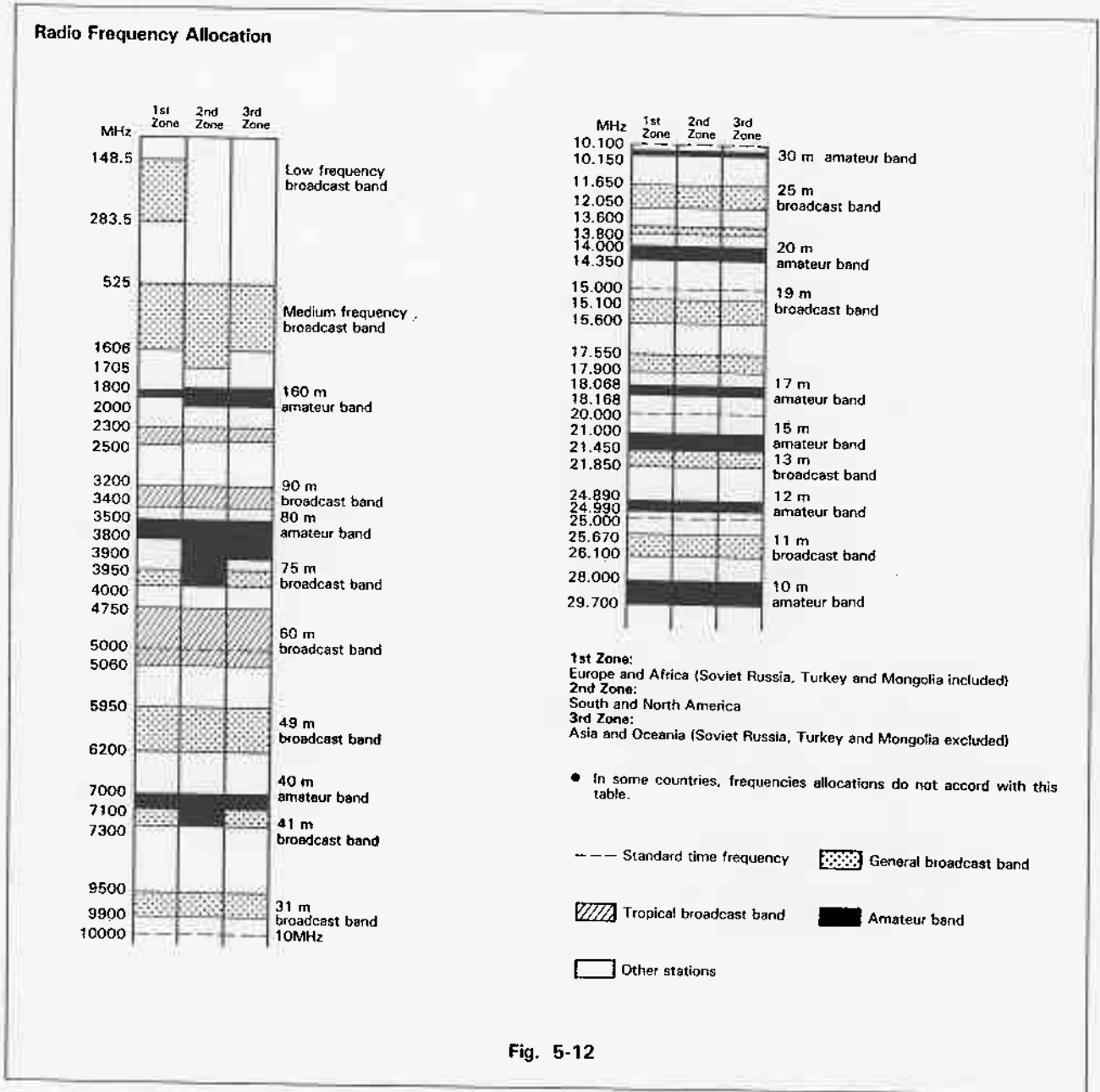

Fig. 5-12

Frequency Distribution in the Broadcast and Amateur Bands.

The TS-930S receiver covers from 150 kHz to 30 MHz, to receive international broadcast and communication services.

As shown in the Frequency Allocation Chart, Fig. 5-12, broadcast and Amateur radio station frequencies are allocated in specific bands expressed in megahertz (MHz) or wavelength in meters (m). Also in Fig. 5-12, the frequencies of "other station" are assigned for fixed station

business use, marine mobile, aviation mobile, land mobile, radio beacon stations, etc.

NOTE:

1. Radio stations throughout the world are listed in the WORLD RADIO TV HANDBOOK or similar publications.
2. Antennas designed for HAM BANDS operation will generally provide satisfactory reception for SW stations near the HAM BANDS. For antenna construction details, see the ARRL ANTENNA HANDBOOK, or similar publications.

SECTION 6. OPTIONAL ACCESSORIES

6.1 PERIPHERAL DEVICES AND OPTIONS

The following optional accessories are available for more efficient and enjoyable operation of the TS-930S.

■ AT-930 AUTOMATIC ANTENNA TUNER

The TS-930S is available either with or without a built-in automatic antenna tuner. The tuning range is automatically pre-selected at band selection. Reflected power and final stage Ic (collector current) are monitored to control the tuning motors for the lowest SWR.

The tuner covers all amateur bands from 80 through 10 meters, including the new WARC bands. Matching capability is 20 to 150 ohms, unbalanced. The front panel "AUTO-THRU" switch allows bypassing the tuner, if desired.

■ SPEAKER SP-930

The SP-930 is a low-distortion speaker with selectable frequency response for high intelligibility in any mode. The frequency response is shaped by selectable built-in audio filters, which are effective in improving signal-to-noise ratio under certain interference conditions, or when receiving weak signals.

■ STATION MONITOR SM-220

Built around a basic 10 MHz oscilloscope, the SM-220 station monitor features, in combination with a built-in two-tone generator, a variety of waveform-observing capabilities.

It cannot be used as a Band Scope.

■ HF LINEAR AMPLIFIER TL-922/TL-922A

The TL-922/TL-922A is an HF linear amplifier operating at maximum legal power, and employing a pair of 3-500Z high performance transmitting tubes. The TL-922A (without 10 m band) is available only in U.S.A.

■ HS-5 COMMUNICATIONS HEADPHONES

Headphones designed for communications equipment. These light-weight open air-type headphones remain comfortable during extended operation. Easily attached ear-pads are provided.

■ HS-6 COMMUNICATIONS HEADPHONES

Deluxe, very lightweight headphones designed for communications equipment.



SP-930



TL-922/TL-922A



HS-6



SM-220



HS-5

■ **MC-60A BASE STATION MICROPHONE**

Communications microphone with push-to-talk and remote frequency UP/DOWN switches.

■ **HC-10: DIGITAL WORLD CLOCK**

The HC-10 is a highly advanced world clock with dual display which can memorized 10 preset world major cities and 2 additional programmable regions.

■ **PC-1A: PHONE PATCH**

(Available only where phone patch operation is legal.)
Hybrid phone patch with VU meter for null and audio gain measurements.

The PC-1A Phone Patch provides interface between the transceiver and telephone line.

Providing excellent performance, it is designed with high isolation between receive input and transmit output.

Its compact design permits easy installation in a limited space.

(FCC Part 68 registered)

■ **SO-1: THERMAL COMPENSATION CRYSTAL OSCILLATOR FOR THE TS-930S**

It is a crystal oscillator used for the purpose of further improving the frequency stability of TS-930S. (Oscillation frequency: 20 MHz, Range of frequency correction: ±60 Hz)

For AM

- **YK-88A-1** (-6 dB bandwidth : 6 kHz, 8,830.0 kHz)
 - Center Frequency : 8,830.0 kHz
 - Passband Width : 6 kHz (-6 dB)
 - Attenuation Bandwidth : 11 kHz (-60 dB)
 - Guaranteed Attenuation : More than 80 dB

For CW

- ***YK-88C-1** (-6 dB bandwidth : 6 kHz, 8,830.0 kHz)
 - Center Frequency : 8,830.0 kHz
 - Passband Width : 6 kHz (-6 dB)
 - Attenuation Bandwidth : 1.5 kHz (-60 dB)
 - Guaranteed Attenuation : More than 80 dB

- ***YG-455C-1** (-6 dB bandwidth : 500 Hz, 455 kHz)
 - Center Frequency : 455.0 kHz
 - Passband Width : 500 Hz (-6 dB)
 - Attenuation Bandwidth : 820 kHz (-60 dB)
 - Guaranteed Attenuation : More than 80 dB

- **YG-455CN-1** (-6 dB bandwidth : 250 Hz, 455 kHz)
 - Center Frequency : 455.0 kHz
 - Passband Width : 250 Hz (-6 dB)
 - Attenuation Bandwidth : 480 Hz (-60 dB)
 - Guaranteed Attenuation : More than 80 dB

* Recommended filter pair



MC-60A



HC-10



SO-1



YG-455CN-1



YG-455C-1



YK-88A-1



YK-88C-1

6.2 INSTALLATION OF ACCESSORIES

1. Preparation

- (1) Prepare the following tools
 - o No. 2 Philips screwdriver
 - o Diagonal cutters
- (2) Unplug the power cord from the AC outlet before starting work.
- (3) Remove the 8 top and 8 bottom case screws and remove the covers.

6.3 OPTIONAL FILTER INSTALLATION

Four optional crystal filters are available.

2. Install up to three filters according to the following procedure

- (1) Remove the top and bottom covers (sixteen screws, total).
- (2) Plug-in filters at their locations on the signal unit board. Tighten the supplied mounting screws.

■ YK-88A-1

- (1) Remove the small circuit board fastened to the YK-88A-1 location.
- (2) Plug-in the YK-88A-1 and replace the filter mounting screws.

■ YK-88C-1

- (1) Plug-in the YK-88C-1 and replace the filter mounting screws.
- (2) Cut one lead of diode D91 mounted on the signal unit board. Plug-in the filter and replace the filter mounting screws.

■ YG-455C-1 or YG-455CN-1

- (1) Remove the jumpered connector at the filter position and plug-in the filter. Replace the filter mounting screws.
- (2) Replace the top and bottom covers.

COMBINATION OF IF FILTERS

MODE switch	NAR-WIDE switch	883MHz IF	455kHz 1F	Overall pass-bandwidth	SSB SLOPE TUNE	CW VBT	AF TUNE *2	NOTCH	Note
SSB *4	WIDE or NARROW	2.7kHz (Built-in)	2.7kHz (Built-in)	2.7kHz	HI-CUT to 1500Hz LOW-CUT to 700Hz	—	—	Yes	
CW/FSK *2	WIDE	2.7kHz	2.7kHz	2.7kHz	—	600Hz ~ 2.7kHz	Yes	Yes	
	NARROW *1	(YK-88C-1 500Hz)	(YG-455C-1 500Hz)	500Hz	—	150Hz ~ 500Hz	Yes	Yes	Filter combination recommended for CW VBT
		2.7kHz	(YG-455CN-1 250Hz)	250Hz	—	*3	Yes	Yes	More narrower
AM	WIDE	— (YK-88A-1 6kHz)	6kHz 6kHz	6kHz 6kHz	—	— 4 ~ 6kHz	—	Yes	
	NARROW	2.7kHz (YK-88A-1 6kHz)	2.7kHz 2.7kHz	2.7kHz 2.7kHz	—	600Hz ~ 2.7kHz *3	—	Yes	

Table 6-1

NOTES:

- () = Optional filter installed.
- *1 Shows recommended optional filter combination for CW.
- *2 AF TUNE in FSK mode does not work.
- *3 Although VBT circuit operates, not recommended.
- *4 No optional SSB filters.

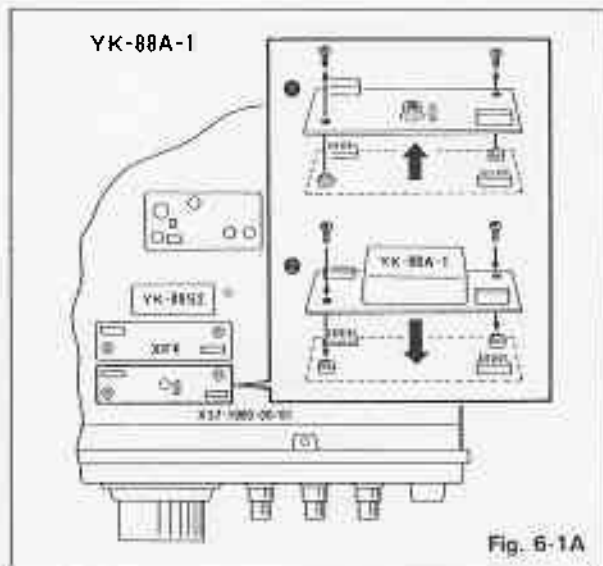

Fig. 6-1A

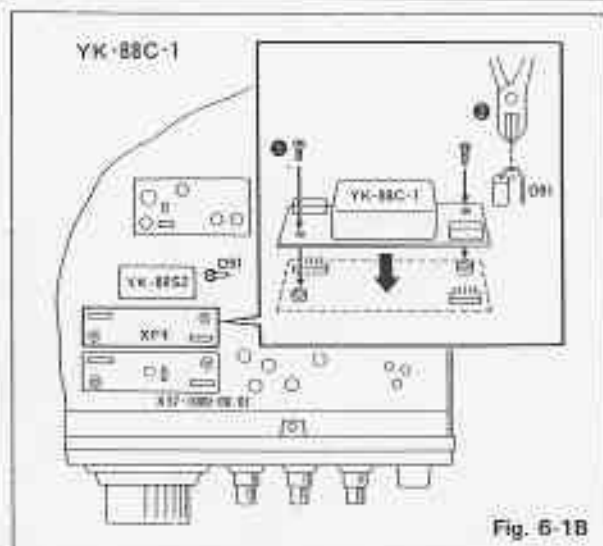

Fig. 6-1B

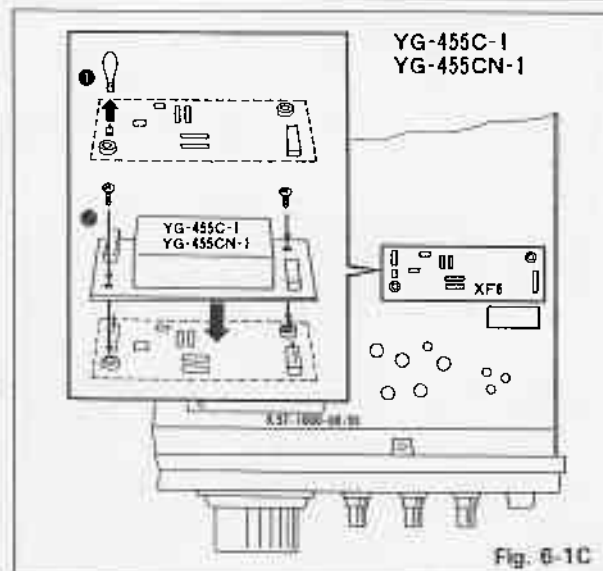

Fig. 6-1C

6.4 AT-930 INSTALLATION

- (1) Remove the top and bottom covers (16 screws, total) from the transceiver.
- (2) Remove the 4 screws and cable retainers located in the AT-930 mounting space.
- (3) Using a long-nosed plier, carefully disconnect the coaxial cable from the filter unit ANT terminal

CAUTION:

Coax leads with connectors are not repairable. When connecting or disconnecting, do not break the male or female connectors.

- (4) Secure the AT-930 to the transceiver using 4 screws.

CAUTION:

Do not pinch any leads between the AT-930 and transceiver chassis.

- (5) Install the multi-connector to the AT-930.
- (6) Connect the coaxial cable, which was removed from the filter unit, to the AT-930 MAT terminal.
- (7) Connect the supplied coaxial cable between the AT-930 ANT terminal and the filter unit ANT terminal.
- (8) Replace the transceiver top and bottom covers. The AT-930 is now ready for automatic operation.

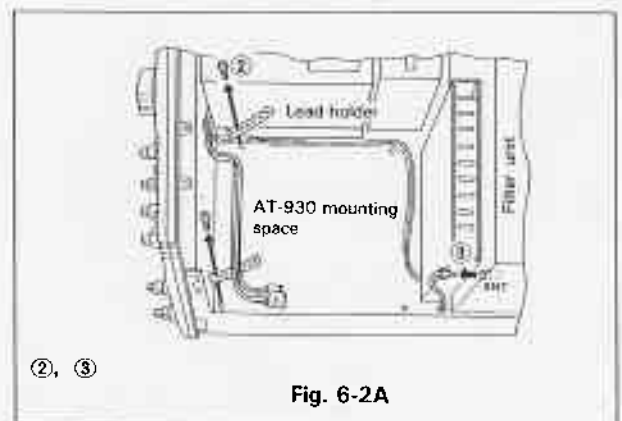

②, ③

Fig. 6-2A

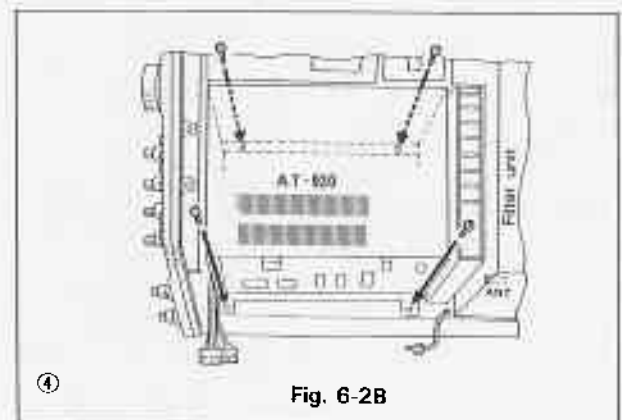

④

Fig. 6-2B

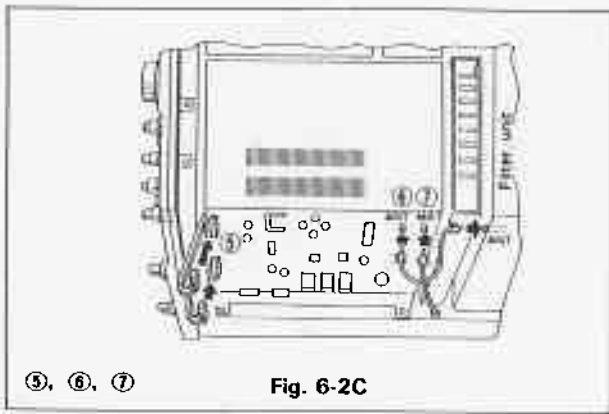

Fig. 6-2C

6.5 REMOTE CONTROL WIRING

Fig. 6-3 shows the REMOTE connector. This 7 pin DIN plug can be used to control a linear amplifier or other external accessories.

Kenwood linear amplifier TL-922 can be connected to this unit with its remote cable. However, when a linear amplifier other than the TL-922(A) is used, change the connection as shown in Fig. 6-4.

This allows remote operation with the relay connected to the terminal 7 of the DIN jack.

NOTE:

ALWAYS use shielded line for all connections.

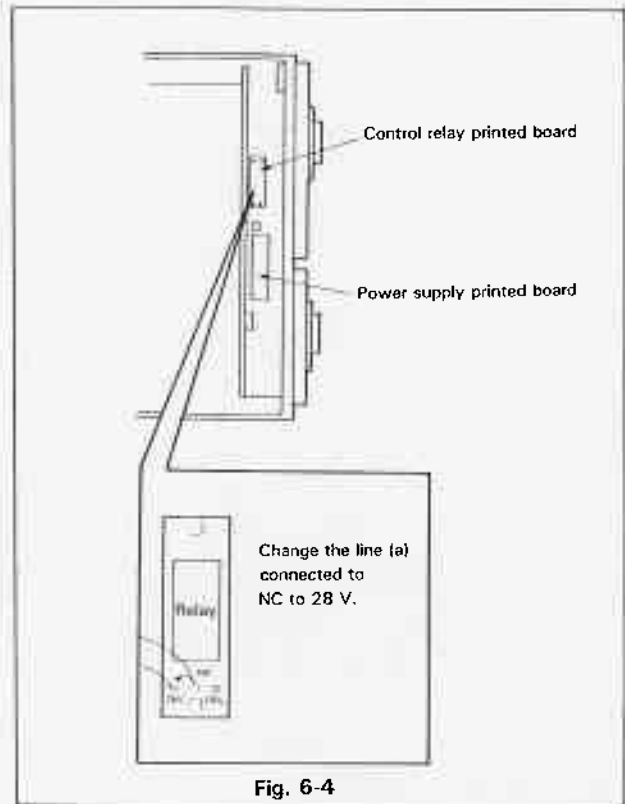
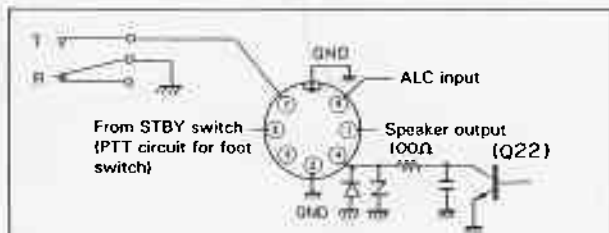
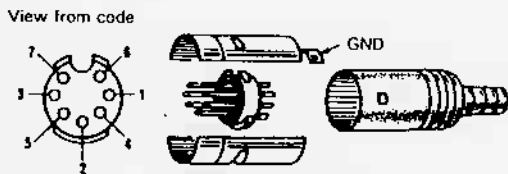

Fig. 6-4



TS-930S Internal Wiring



REMOTE connector

Fig. 6-3 REMOTE connector

PIN	FUNCTION	PIN	FUNCTION
1	Speaker output	5	No connection
2	Ground	6	ALC input ALC threshold level approx. -6 V
3	PTT line	7	Normally opened, closed in transmit See Fig. 6-3.
4	Normally opened, closed in transmit		

Table 6-2

■ OPERATION WITH A LINEAR AMPLIFIER

The TS-930S may be operated with any conventional linear amplifier which will accept up to approximately 125 watts RF drive, has a low current DC operated keying circuit, and returns approximately -8 ~ -10 V DC ALC (adjustable) back to the exciter. Please note that in order to operate QSK (full break-in), the linear amplifier must also be QSK capable.

For operation with a linear amplifier, refer to Fig. 6-3, TS-930S internal wiring.

Pin 6 ALC input

Pin 2 Ground

Pin 4 Control line center conductor

Use shielded line for both ALC and RL (control line).

Initial linear amplifier tune-up should be performed with the exciter in the tune mode, to reduce wear-and-tear on both the linear, and the exciter. Use of a dummy load is strongly suggested, since the bands are already sufficiently crowded.

■ SSTV OR AFSK OPERATION

The TS-930S will adapt to slow scan television AFSK or RTTY operation (besides the built-in FSK mode). For SSTV, the only cabling required are connections between the transceiver phone patch input and the camera output, and between the patch output and the monitor input.

■ PHONE PATCH OPERATION

Most phone patches will work satisfactorily without any modification to the radio. The PC-1 Phone Patch can be used with the TS-930S after some modification to the patch. The PC-1 mic input and output connectors are four pin. These, along with the output control cable, may be changed to eight pin connectors with a six conductor line (one shielded). Operation will be just as described on the PC-1 instruction sheet.

As an alternate, connect the PC-1 RX-IN terminals (top-hot, bottom-ground) to the transceiver line output jack and the patch output line originally at Pin 1 (HOT) and 4 (GROUND) to the transceiver line input jack, using RCA plugs. The PC-1 will operate at ON, but will not automatically disconnect the microphone and speaker from the transceiver.

Connectors required:

8 Pin chassis mount jack

E06-0853-05

8 Pin cord mount plug

E07-0852-05

1 Pin RCA plug

E14-0101-05

Recommended settings are:

PC-1(A)	RX Gain	4
	TX Gain	4
	Null	as necessary
TS-930S	Vox Gain	1
	AF Gain	4
	Mic Gain	5
	Anti Vox Max	

■ FRONT FEET

The front panel can be elevated for operating convenience by extending the front feet.

Turn the front feet left and pull down. Then turn right to lock.

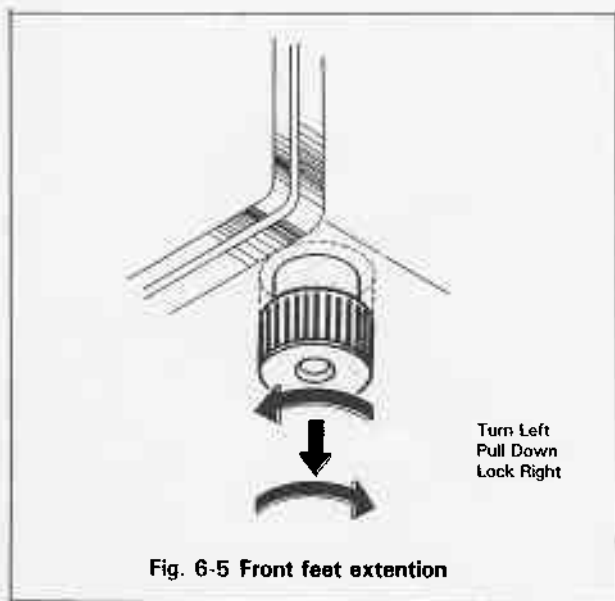

■ OPERATION WITH A SECOND RECEIVER

If you prefer operating another receiver in place of the TS-930S receiver section, you may share the antenna from the TS-930S during receive-time. Flip the rear panel RX-ANT switch (3) to EXTERNAL, and connect the antenna input of your second receiver to the RX ANT terminal (4) using 50 Ω coaxial cable. Reduce the AF Gain setting on the transceiver to zero. Mute the external receiver from Pin 4 and GROUND of the remote connector. If a linear amplifier is also used with the transceiver, diode isolate the external receiver and linear to Pin 4, and be sure combined current is less than the maximum rating for this terminal.

■ OPERATION WITH A SEPARATE RECEIVER ANTENNA

Use the XVRTR port and an 8 Pin DIN Plug, Part E07-0851-05

Pin 8 HF Ant output from the TS-930S

Pin 5 RX Ant input

Pin 3 GND

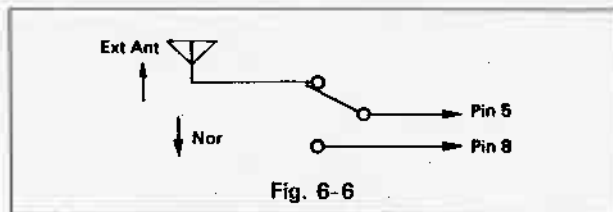

Either wire your extra antenna to pin 5 and ground, and use the DIN plug as the connect/disconnect, or wire pins 8 and 5 and the external antenna through a SPDT switch, as shown.

■ OPERATION AS A SECOND RECEIVER

Use the REMOTE Connector. Connect Pin 3 (PTT line) (and Pin 2, GROUND) to your XMTR control output, to ground Pin 3 in TX. Feed the antenna through the primary transmitter or transceiver antenna relay.

SECTION 7. CIRCUIT DESCRIPTION

7.1 BLOCK DIAGRAM

The TS-930S block diagram is shown on page 39.

7.1-1 General

The TS-930S combines a quadruple conversion superheterodyne receiver with a triple conversion transmitter (double conversion in CW mode) using a filter-type SSB generator. Intermediate frequencies are 44.93 MHz, 8.83 MHz, 455 kHz, and 100 kHz. The 100 kHz IF is used only in receive. Local oscillators incorporated include a VCO (voltage controlled oscillator) controlled by the PLL, a HET (heterodyne) oscillator (36.1 MHz), CAR 1 oscillator (8.83 MHz), and CAR 2 oscillator (8.375 MHz). Both the transmitter and receiver use these local oscillators. The CAR 3 and CAR 4 oscillators permit CW pitch change, and are used only by the receiver.

In the receiver mixer section, first and second mixers are balanced, using two junction FET's (2SK125) each. The third and fourth mixers use dual gate MOS FET's (3SK73). In the transmitter, all mixers (first, second and third) are balanced, using 3SK73, FET's.

The PLL, which consists of three minor loops, controls the VCO frequency (described above), to achieve dual digital VFO operation in 10 Hz steps. In addition, SSB slope tune and CW-VBT are achieved by combined control of the two receiver carrier oscillators.

Many accessory circuits are included. Adding to a monitor, VOX, RF speech processor and etc., which were incorporated in earlier models, new features such as a new Noise Blanker (NB2), automatic SWR meter, and Full Break-in capability are now incorporated.

7.1-2 Transmitter

From the microphone, audio signal comes to the Signal unit X57-1000-00 microphone amplifiers Q147, 146, 82, 83, 84, and to the balanced modulator D140 which converts this signal to a DSB (double sideband) 455 kHz signal. This signal passes a buffer amplifier Q87 and comes to a ceramic filter CF1 which converts this to an SSB (single sideband) signal. The first transmission mixer Q68, 69 then mixes the signal with CAR 2 (frequency 8.375 MHz), converting the signal frequency to 8.83 MHz. The resulting SSB signal passes a monolithic crystal filter (MCF XF1) and enters the second transmission mixer Q55, 56 which converts the signal frequency to 44.93 MHz by mixing with the HET signal (frequency 36.1 MHz). Then the third transmission mixer Q42, 43 mixes the signal with the VCO (frequency 45.08-74.93 MHz), converting the signal frequency to the final transmission frequency. This signal passes through a transmission band-pass filter (1.8-30 MHz) and, after being amplified by Q41, 40, 39, goes to the Final unit X56-1430-00. This unit amplifies signal power (Q1~5). Finally, the Low-pass filter unit X51-1280-00 removes spurious components from the

signal. The resulting signal is supplied to the antenna, either directly, or through the optional Auto antenna tuner (X57-1010-00).

7.1-3 Receiver

Signal from the antenna goes to the Signal unit and passes one of nine band-pass filters. The RF unit X44-1490-00 amplifies (Q1) and mixes (Q2) the signal with the VCO frequency, converting the signal to the first IF frequency (44.93 MHz). The signal passes the post amplifier Q3, 4 and returns to the Signal unit where it passes a band-pass filter composed of two MCFs (XF1, 2). The signal then goes to the second reception mixer Q62, 63 which mixes the signal with the HET frequency, generating the second IF signal (8.83 MHz). The signal then passes the noise blanker gate (D82, 84~86) and MCF XF1 and goes to the third reception mixer Q65, 66 which generates the third IF signal (455 kHz) by mixing with CAR 2 (frequency 8.375 MHz). This third IF signal is amplified by Q67 and passes through ceramic filter CF1 and, after being amplified by Q128, enters the fourth receiver mixer Q129 which generates the fourth IF signal (100 kHz). This signal passes the notch filter (tuned by D217), a final IF amplifier Q130, and then it is demodulated (D238~241). In AM mode, the AM demodulator (D209, 219) operates. In all other modes, the ring demodulator works. The AF amplifiers Q160, 159 and IC3 drive the speaker.

7.2 UNITS

The TS-930S major units include the Signal unit, RF unit, PLL unit, Digital unit, Final unit, Low-pass filter unit, Power unit, and Switch unit.

7.2-1 Signal unit (X57-1000-11)

This unit includes most of the transmission/reception signal circuits, which control signal circuits, local oscillators, and accessory circuits.

Optional crystal filters are installed on this unit. They plug-in, and may be installed much easier than with conventional models.

7.2-2 RF unit (X44-1490-00)

The mixer section of the receiver centers in this unit. Using six junction FET's (2SK125), dynamic range is as high as 100 dB (using a 500 Hz [optional] filter).

7.2-3 PLL unit (X50-1880-00)

This includes three phase-locked loops to achieve digital VFO operation in 10 Hz steps. The reference signal oscillator is easily accessible from outside the case for adjustment.

7.2-4 Digital unit (X54-1670-00)

A 1-chip microprocessor is the heart of this unit. Most

other components are ICs. This unit functions to control frequency, display and the PLL unit.

Besides, the frequency display can be performed to 10 Hz by connecting terminal 8 on connector 8 of the digital unit to the chassis (that is, by grounding).

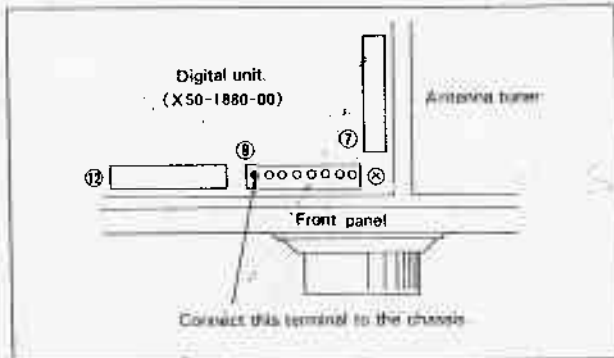

7.2-5 Final unit (X56-1430-00)

This unit includes the transmitter power amplifiers. The TS-930S outputs 100 W. Good IMD characteristics are provided by using a 28 V supply. In the TS-930S, the final stage is comprised of two MRF422 motorola transistors (collector dissipation 290 W) which are fan cooled.

7.2-6 Filter unit (X51-1280-00)

This removes unwanted spurious components such as harmonics from the transmission signal. This unit also detects VSWR to control ALC, and protection, and the SWR indicator circuit.

7.2-7 Power supply unit (X43-1430-00)

This unit supplies all the other units or their on-board regulators with regulated 28 V.

7.2-8 Switch unit (X41-1410-00)

The main front-panel switches and controls are mounted on this unit to simplify wiring.

7.3 AUTO-ANTENNA-TUNER (X57-1010-00)

This consists of a tuner section and a control section. The tuner section is π matching or T matching circuit which consists of coils and two variable capacitors, driven by motors. The control section detects the transmitter output to antenna match, and controls the drive motors to maintain best match.

SECTION 8. MAINTENANCE AND ADJUSTMENT

GENERAL

Your TS-930S has been factory aligned and tested to specification before shipment. Under normal circumstances the transceiver will operate in accordance with these operating instructions. All adjustable trimmers and coils in your transceiver were preset at the factory and should only be readjusted by a qualified technician with proper test equipment.

Attempting service or alignment without factory authorization can void the transceivers warranty.

When operated properly, the transceiver can give years of service without requiring realignment. The information in this section gives some general service procedures which can be accomplished without sophisticated test equipment.

CLEANING

The knobs, front panel and cabinet of the TS-930S are likely to become soiled after extended use. The knobs should be removed from the transceiver and cleaned with a neutral soap and warm water. Use a neutral soap (not harsh chemicals) and damp cloth to clean the cabinet and front panel.

8.1 PREPARATION

1. Removing the covers

Remove the eight screws which fasten the top and eight screws from the bottom case panel. The covers may be lifted away.

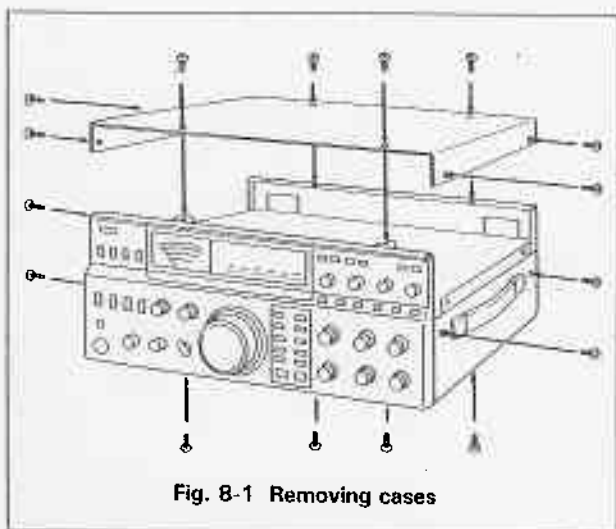

Fig. 8-1 Removing cases

2. Service position

Place the transceiver on its left side, with the final stage up, for proper ventilation.

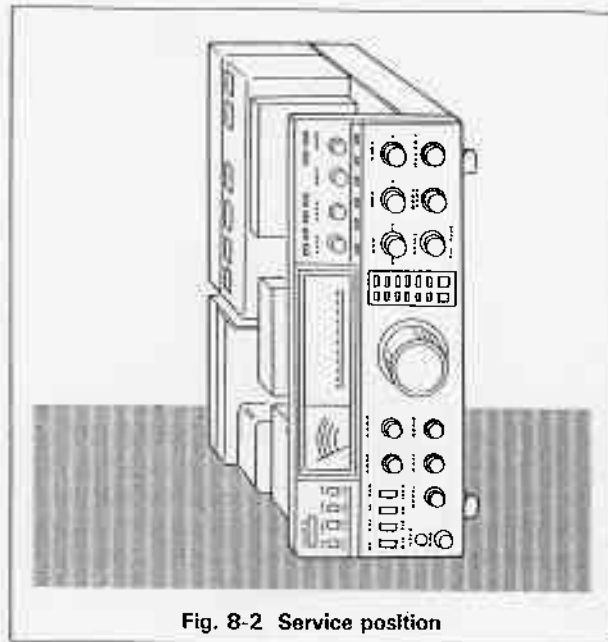

Fig. 8-2 Service position

8.2 ADJUSTMENTS

1. RV voltage adjustment (Signal unit)

Adjust the voltage to 16 V with VR-24.

2. RB voltage adjustment (Signal unit)

Adjust the voltage to 2.15 V with VR-25.

3. Supply voltage adjustment (Power Supply unit)

Adjust the voltage to 28.5 V with VR-1.

4. Digital display calibration

Connect the antenna, place the MODE switch to TUNE, and Zero-Beat to WWV at either 5, 10 or 15 MHz. Next, turn the 100 kHz calibrator ON and the marker signal will be superimposed on the WWV signal. If the calibrator is also at Zero-Beat, adjustment is not necessary.

If the calibrator is not Zero-Beat with WWV, adjust the Standard oscillator trimmer through the reference frequency adjustment access opening (on the side of the TS-930S) so the two signals are again Zero-Beat. Repeat this procedure 2 or 3 times. This completes calibration of the Digital Display. After calibration turn off the CAL switch.

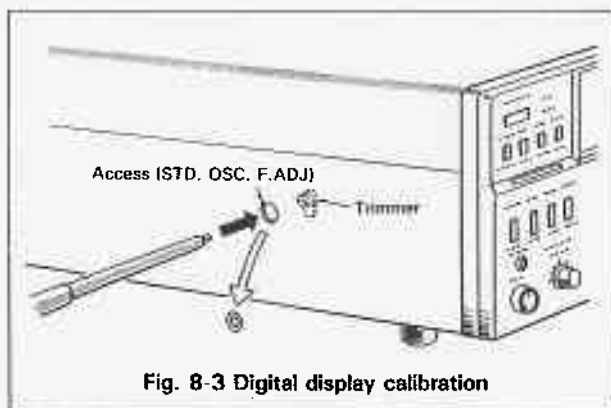

Fig. 8-3 Digital display calibration

5. Carrier balance adjustment (Signal unit)

With a 50 Ω dummy load connected to the ANT terminal, adjust for maximum output at 14.175 MHz. Reduce mic gain to zero. Set the transceiver in LSB mode. The power meter or an oscilloscope will deflect if the carrier is unbalanced. To balance the carrier, alternately adjust trimmer TC2 and trimpot VR-21 until the meter indicates minimum. Switch to USB mode and if the pointer deflects, readjust so the pointer deflects equally for both LSB and USB.

6. Side tone level adjustment (signal unit)

Adjust VR-32 for your preference.

7. "Buzzer" level adjustment (Signal unit)

Adjust VR-33 for your preference.

8. Monitor level adjustment (Signal unit)

Adjust VR-34 for your preference.

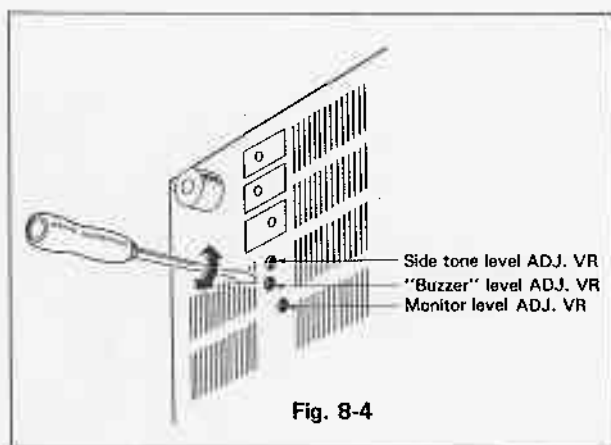

Fig. 8-4

9. S meter adjustment (Signal unit)

Disconnect the antenna with the transceiver in receive mode. Zero-point adjustment:

Adjust VR2 for meter pointer zero indication. If a standard signal generator (SSG) is available, adjust VR3 so the S-meter indicates "S-9", at 14.175 MHz for A 40 dB (50 μV) signal.

10. NOTCH adjustment (Signal unit)

Turn the MARKER switch on and tune for zero-beat in the TUNE mode.

Place the MODE switch to CW and turn the NOTCH switch on.

Adjust the NOTCH control to the 12 o'clock position and fine tune NOTCH for the notch point.

Adjust VR28 for minimum audio output. Repeat the NOTCH control and VR28 adjustments several times for best null.

8.3 MAINTENANCE

1. Semiconductors, resistors, and capacitors

Semiconductors are easily destroyed if a circuit is shorted. Troubleshoot carefully.

If a defective resistor or capacitor is to be replaced, use one of the same specifications.

2. Fuse

When the fuse blows, there is some cause. Be sure to find the cause before attempting operation. Use a 6 amp fuse for the TS-930S, or a 4 A fuse for the TS-930V for 120 V AC operation. Under no circumstances use a higher amperage fuse than specified. This can cause extensive damage. Also, the warranty will be void if an oversized fuse is used.

3. Fan motor lubrication

Every 6 months apply a drop of light machine oil to the front and rear fan motor bearings.

4. Meter lamp Replacement

1. Remove power cable.
2. Remove 8 screws and top cover.
3. Slide METER two meter lamps (with grommets) from their keyed slots on the rear of the METER shield.
4. Desolder the leads from the circuit board adjacent to the power switch.
5. Replace the lamps in reverse order of disassembly. Meter lamp part number is B30-0817-15. These are rated 12 V, 40 mV.

5. AC voltage selection

The TS-930S will operate on 120, 220 or 240 V AC 50 or 60 Hz. For proper operation, select the power setting closest to your local line voltage.

If you are not sure of the local line voltage, contact the utility company. To reset the voltage selector, FIRST DISCONNECT THE POWER CABLE. Use a screwdriver align the selector to the correct voltage.

6. Ordering spare parts

When ordering replacement or spare parts for your equipment, be sure to specify the following information:

Model and serial number of the equipment. Schematic number of the part. Printed circuit board number on which the part is located. Part number and name, if known, and Quantity desired.

NOTE:

A full Service Manual is available as a separate publication.

7. Service

Should it ever become necessary to return the equipment for repair, pack in its original boxes and packing, and include a full description of the problems involved. Also include your telephone number. You need not return accessory items unless directly related to the service problem.

You may return your radio for service to the Authorized Kenwood Dealer from whom you purchased it. A copy of the service report will be returned with the unit. Please do not send sub-assemblies or printed circuit boards. Send the complete unit, in its original boxes and packing.

SERVICE NOTE:

Dear OM, if you desire to correspond on a technical or operational problem, please make your note short, complete, and to the point. And PLEASE make it readable.

Please list: Model and serial number.

The question or problem you are having.

Please give sufficient detail to diagnose: other equipment in the station, meter readings and anything you feel might be usefull in attempting diagnosis.

NOTE:

1. Record the date of purchase, serial number and dealer from whom purchased.
2. For your own information, retain a written record of any maintenance performed on the unit.
3. When claiming warranty service, please include a photocopy of the bill of sale, or other proof of purchase showing the date of sale.

8. WARC bands

1. Unplug the AC power cable.
2. Remove the transceiver top cover (8 screws).
3. Remove four screws from the speaker mount and top panel assembly.
4. Swing the speaker top panel a way and unplug the battery backup leads (red/black) from the digital unit X54-1670-00.
5. As shown, carefully add a wire jumper from IC23, pin 12, to IC24, pin 8 (GROUND). For simplicity, this may be "tacked" on the component side of the P.C.B. Be certain not to pinch any leads under the speaker assembly.
6. This completes the modification.
Reassemble the unit

■ ADJUSTMENT OF SIDE TONE LEVEL (AF-AVR UNIT)

Adjust VR1 to your preference.

■ ADJUSTMENT OF MONITOR LEVEL (IF UNIT)

Adjust VR8 to your preference.

8.4 TRANSMITTING ON WARC BANDS

As supplied, the TS-930S will receive but not transmit the 3 new WARC bands. If transmit capability is desired minor wiring addition is required.

SECTION 9. TROUBLESHOOTING

TRANSMITTER SECTION

SYMPTOM	CAUSE	REMEDY
No output in SSB (No Ic.)	<ol style="list-style-type: none"> 1. Open microphone cable or bad microphone 2. Low microphone gain. 3. PROC switch is to ON with PROC IN/OUT control fully counterclockwise. 	<ol style="list-style-type: none"> 1. Check the microphone. 2. Increase the mic Gain. 3. Increase the PROC IN/OUT settings.
VOX does not operate.	<ol style="list-style-type: none"> 1. VOX GAIN control too low. 2. ANTI VOX control requires adjustment. 	<ol style="list-style-type: none"> 1. See section 5.4.7, VOX operation. 2. See section 5.4.7, VOX operation.
VOX trips by speaker output.	ANTI VOX control requires adjustment.	See section 5.4.7, VOX operation
Mic or radio chassis is "hot" during TX.	Excess RF in the shack. No earth ground, poor ground, or antenna is too close to the radio.	See section 3.8, 3.9.
Poor audio in SSB, TX-feedback.	Excess RF in the shack.	See section 3.8, 3.9.

RECEIVER SECTION

SYMPTOM	CAUSE	REMEDY
Lights do not light and there is no receiver noise when the POWER switch is turned on.	<ol style="list-style-type: none"> 1. Bad power cable or connections. 2. Blown power supply fuse. 	<ol style="list-style-type: none"> 1. Check cables and connections. 2. Check for the cause of the blown fuse and replace the fuse.
An antenna is connected but no signals are heard.	Microphone PTT switch (or stand-by switch) is in the transmit position.	Release the PTT switch
An antenna is connected but S-meter deflects without a received signal.	<ol style="list-style-type: none"> 1. RF GAIN control closed. 2. Low AC line voltage. 	<ol style="list-style-type: none"> 1. Open RF GAIN control. 2. Use a step-up transformer to raise the line voltage.
SSB signal unintelligible.	MODE switch is set to wrong sideband.	Turn MODE switch to the correct sideband.
RIT control inoperative.	RIT switch is off.	Push RIT button
SSB received signal is extremely high cut or low cut.	Slope tuning is out of adjustment.	Set to the NORMAL position.

SECTION 10. INTERNAL VIEWS

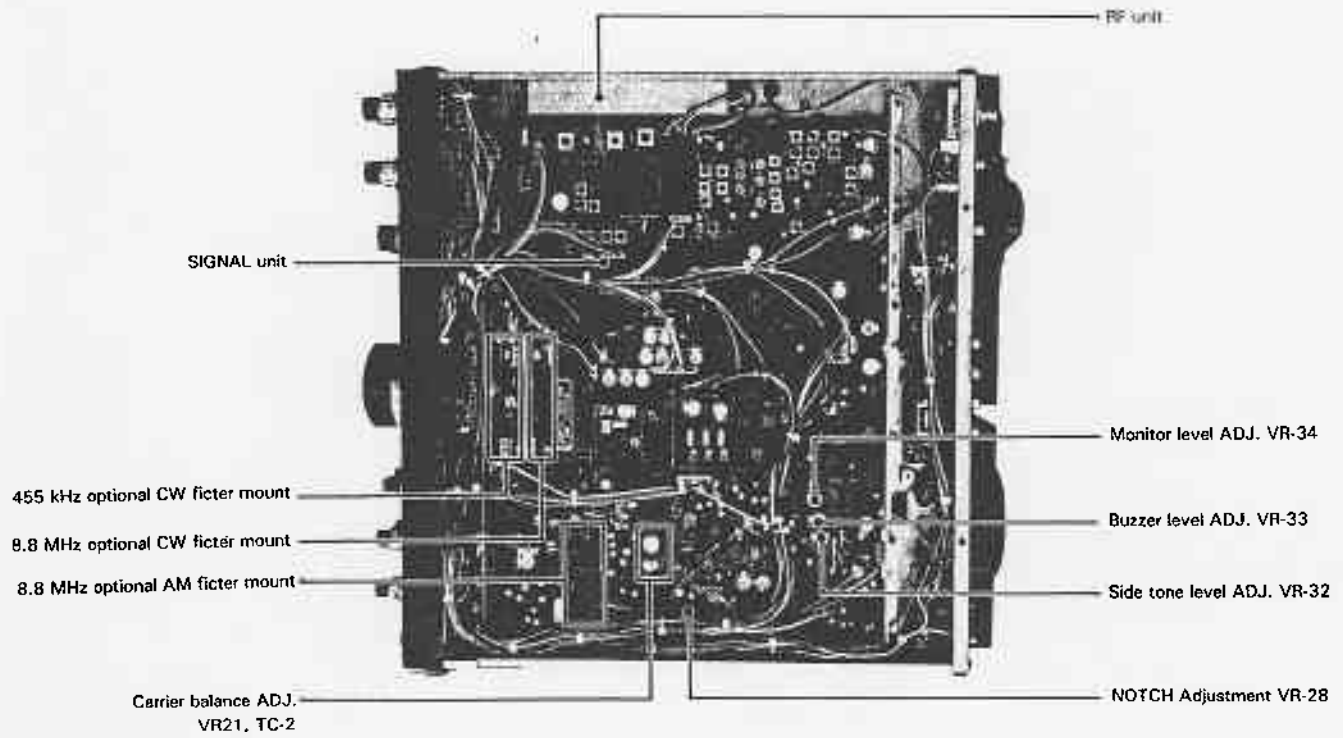
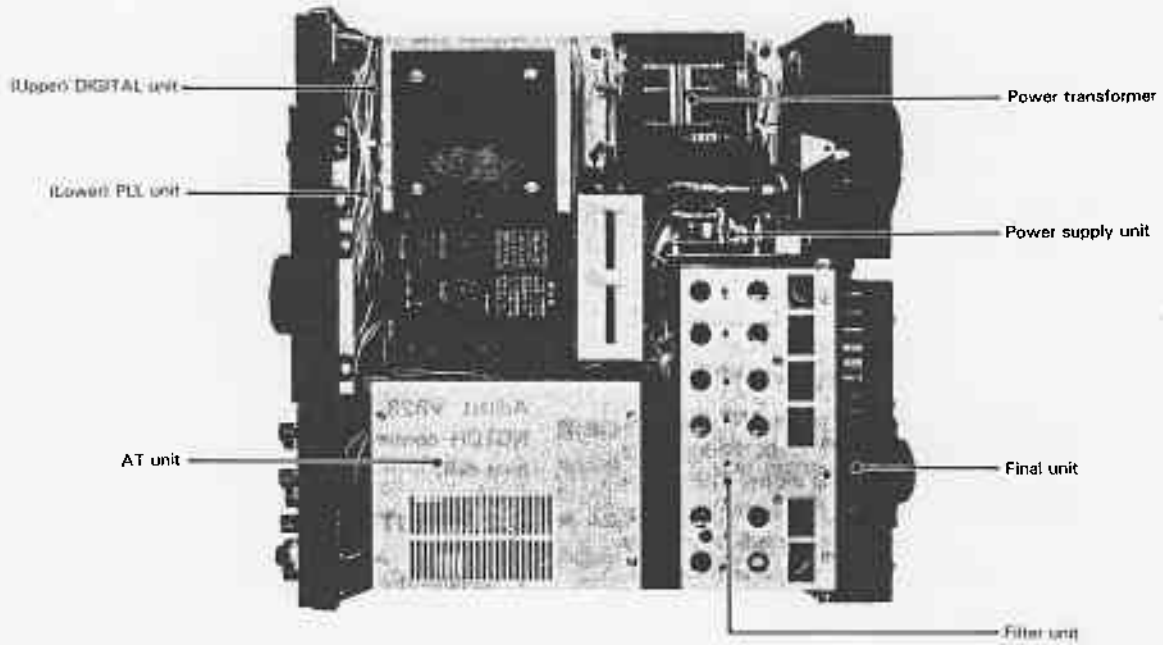

SECTION 11. BLOCK DIAGRAMS

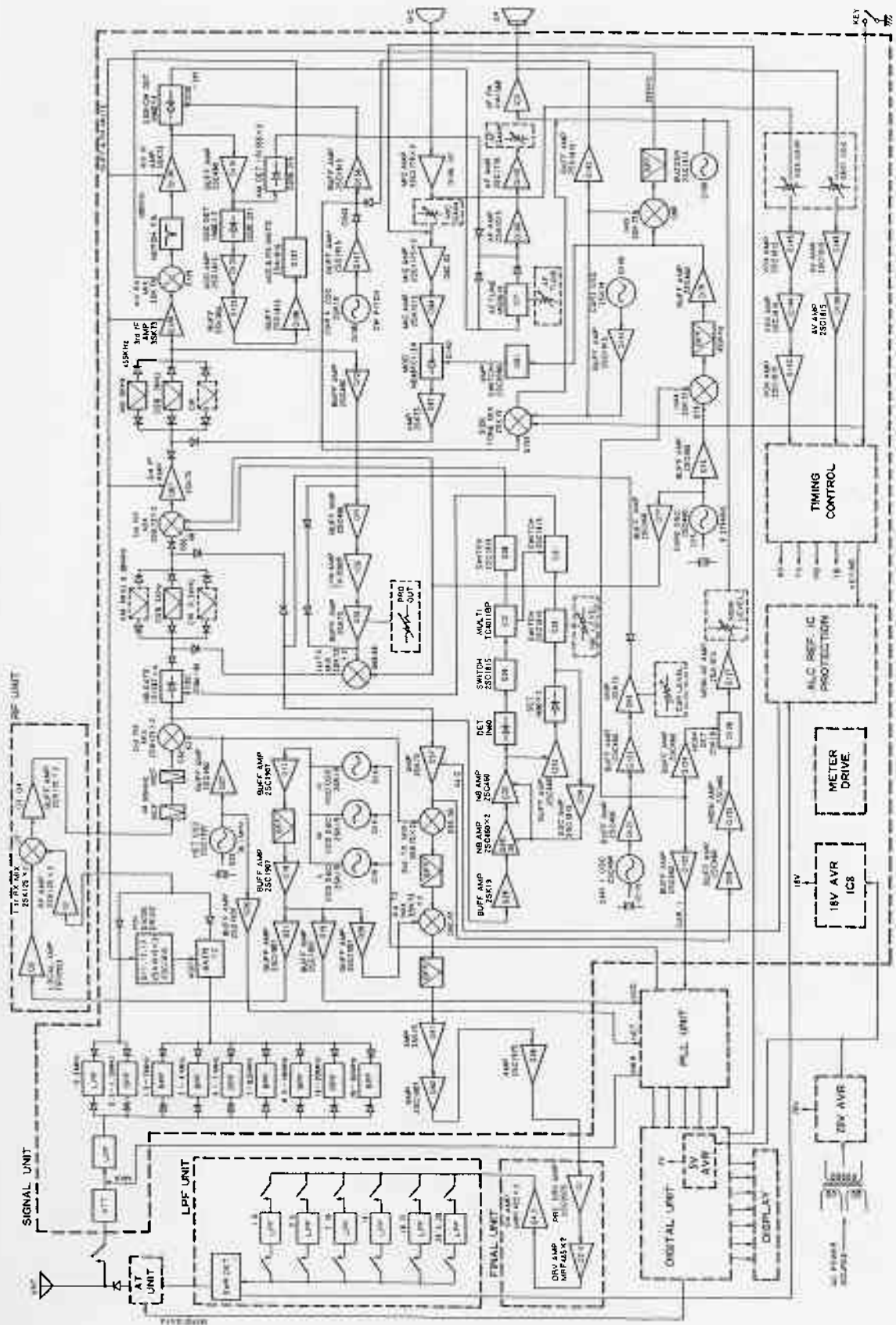

11.2. AT-930 BLOCK DIAGRAM

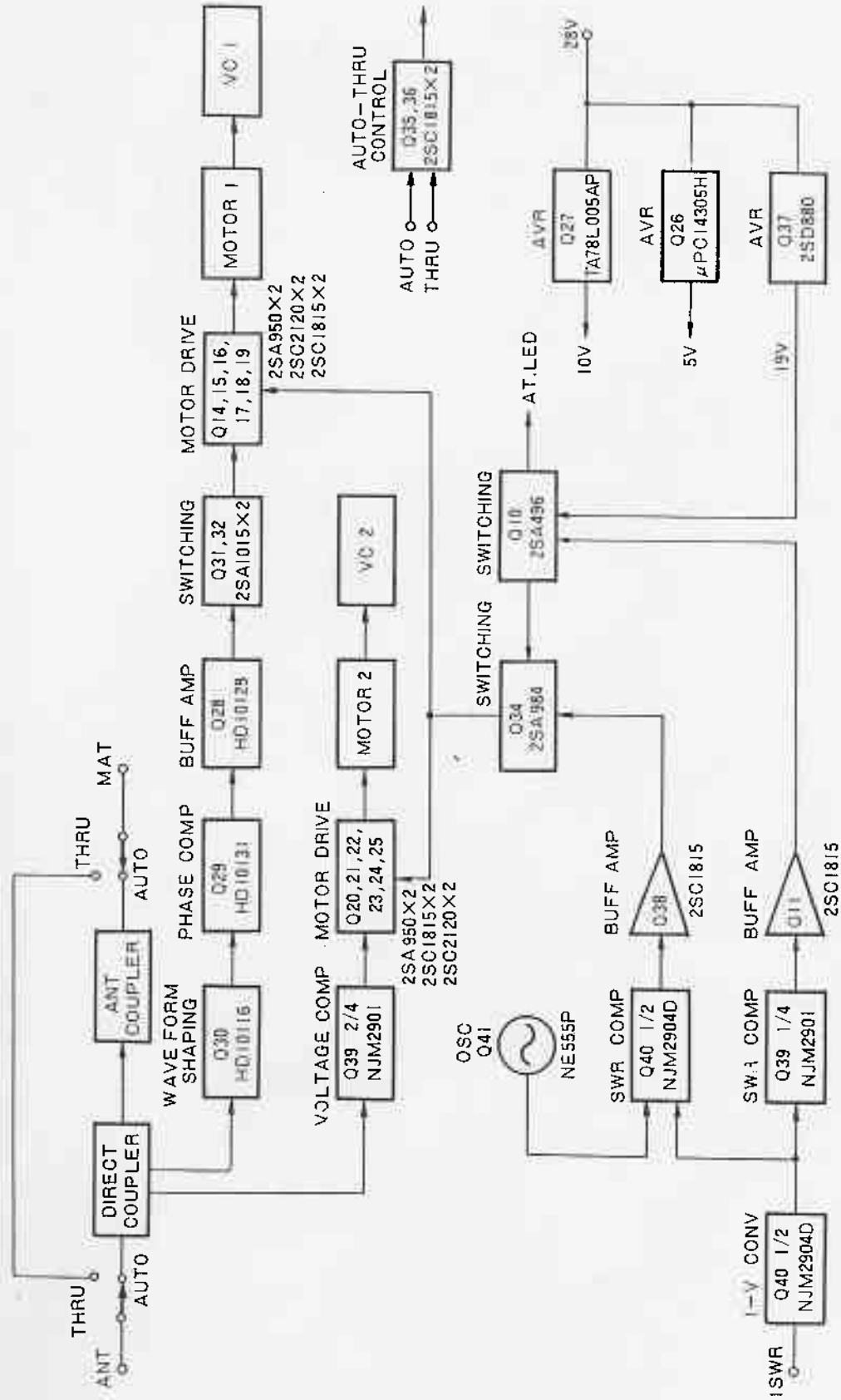

SECTION 12. CIRCUIT DIAGRAMS

SCHMATIC DIAGRAM

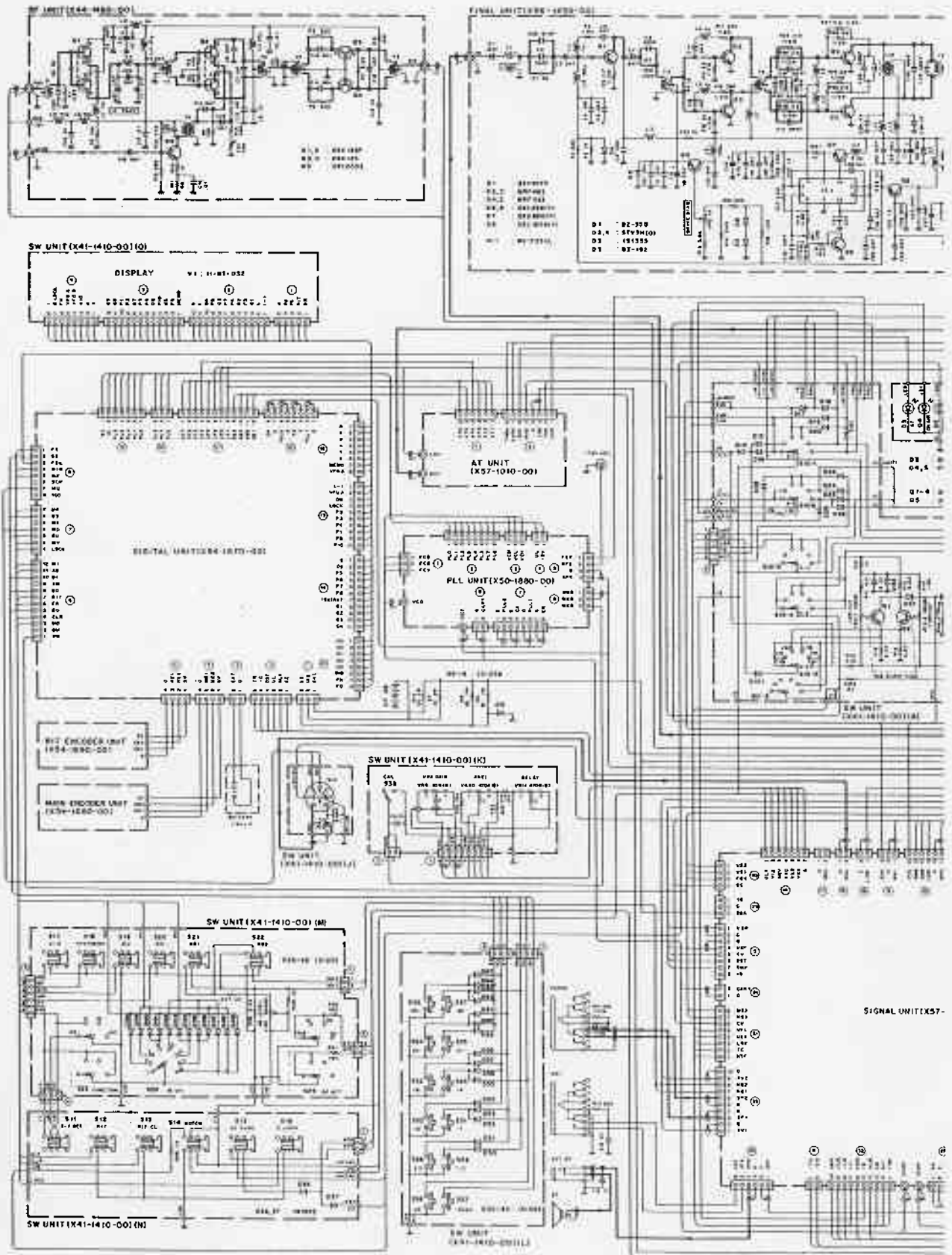

LPF UNIT(X51-1200-00)

- D1-7, 40, 42, 44, 46, 47, 48
- D1 : 1S1295
- D1.8 : 1400
- D11 : EC-080
- D1A : W2-100
- D1B : 1S1007
- D1C : 1S1281
- D1F : X1-085
- D20 : W1-140

SW UNIT (X41-1410-00)(B)

SW UNIT (X41-1410-00)(C)

SW UNIT (X41-1410-00)(D)

- D1 : 1S1295
- D2 : 1S1295
- D3 : 1S1295
- D4 : 1S1295
- D5 : 1S1295

- D1 : 1S1295
- D2 : 1S1295
- D3 : 1S1295
- D4 : 1S1295
- D5 : 1S1295

- D1-7, 15-18
- D8-14, 20, 22, 23
- D21
- D2C : 1S1295
- D2C : 1S1295
- D2C : 1S1295

(X41-1410-00)(E)

SW UNIT(X41-1410-00)(F)

- D1 : 1S1295
- D2 : 1S1295
- D3 : 1S1295
- D4 : 1S1295
- D5 : 1S1295

- D1 : 1S1295
- D2 : 1S1295
- D3 : 1S1295
- D4 : 1S1295
- D5 : 1S1295

SW UNIT (X41-1410-00)(G)

- D1 : 1S1295
- D2 : 1S1295
- D3 : 1S1295
- D4 : 1S1295
- D5 : 1S1295

POWER SUPPLY UNIT(X43-1430-00)

- D1 : 1S1295
- D2-4 : 1S1295
- D5 : 1S1295
- D6 : 1S1295
- D7.8 : 1S1295
- D9 : 1S1295
- D10 : 1S1295
- D11 : 1S1295
- D12 : 1S1295
- D13 : 1S1295
- D14 : 1S1295
- D15 : 1S1295
- D16 : 1S1295
- D17 : 1S1295
- D18 : 1S1295
- D19 : 1S1295
- D20 : 1S1295
- D21 : 1S1295
- D22 : 1S1295
- D23 : 1S1295
- D24 : 1S1295
- D25 : 1S1295
- D26 : 1S1295
- D27 : 1S1295
- D28 : 1S1295
- D29 : 1S1295
- D30 : 1S1295
- D31 : 1S1295
- D32 : 1S1295
- D33 : 1S1295
- D34 : 1S1295
- D35 : 1S1295
- D36 : 1S1295
- D37 : 1S1295
- D38 : 1S1295
- D39 : 1S1295
- D40 : 1S1295
- D41 : 1S1295
- D42 : 1S1295
- D43 : 1S1295
- D44 : 1S1295
- D45 : 1S1295
- D46 : 1S1295
- D47 : 1S1295
- D48 : 1S1295
- D49 : 1S1295
- D50 : 1S1295
- D51 : 1S1295
- D52 : 1S1295
- D53 : 1S1295
- D54 : 1S1295
- D55 : 1S1295
- D56 : 1S1295
- D57 : 1S1295
- D58 : 1S1295
- D59 : 1S1295
- D60 : 1S1295
- D61 : 1S1295
- D62 : 1S1295
- D63 : 1S1295
- D64 : 1S1295
- D65 : 1S1295
- D66 : 1S1295
- D67 : 1S1295
- D68 : 1S1295
- D69 : 1S1295
- D70 : 1S1295
- D71 : 1S1295
- D72 : 1S1295
- D73 : 1S1295
- D74 : 1S1295
- D75 : 1S1295
- D76 : 1S1295
- D77 : 1S1295
- D78 : 1S1295
- D79 : 1S1295
- D80 : 1S1295
- D81 : 1S1295
- D82 : 1S1295
- D83 : 1S1295
- D84 : 1S1295
- D85 : 1S1295
- D86 : 1S1295
- D87 : 1S1295
- D88 : 1S1295
- D89 : 1S1295
- D90 : 1S1295
- D91 : 1S1295
- D92 : 1S1295
- D93 : 1S1295
- D94 : 1S1295
- D95 : 1S1295
- D96 : 1S1295
- D97 : 1S1295
- D98 : 1S1295
- D99 : 1S1295
- D100 : 1S1295

D3.4 : 1S1295

SW UNIT(X41-1410-00)(I)

- D1 : 1S1295
- D2 : 1S1295
- D3 : 1S1295
- D4 : 1S1295
- D5 : 1S1295
- D6 : 1S1295
- D7 : 1S1295
- D8 : 1S1295
- D9 : 1S1295
- D10 : 1S1295
- D11 : 1S1295
- D12 : 1S1295
- D13 : 1S1295
- D14 : 1S1295
- D15 : 1S1295
- D16 : 1S1295
- D17 : 1S1295
- D18 : 1S1295
- D19 : 1S1295
- D20 : 1S1295
- D21 : 1S1295
- D22 : 1S1295
- D23 : 1S1295
- D24 : 1S1295
- D25 : 1S1295
- D26 : 1S1295
- D27 : 1S1295
- D28 : 1S1295
- D29 : 1S1295
- D30 : 1S1295
- D31 : 1S1295
- D32 : 1S1295
- D33 : 1S1295
- D34 : 1S1295
- D35 : 1S1295
- D36 : 1S1295
- D37 : 1S1295
- D38 : 1S1295
- D39 : 1S1295
- D40 : 1S1295
- D41 : 1S1295
- D42 : 1S1295
- D43 : 1S1295
- D44 : 1S1295
- D45 : 1S1295
- D46 : 1S1295
- D47 : 1S1295
- D48 : 1S1295
- D49 : 1S1295
- D50 : 1S1295
- D51 : 1S1295
- D52 : 1S1295
- D53 : 1S1295
- D54 : 1S1295
- D55 : 1S1295
- D56 : 1S1295
- D57 : 1S1295
- D58 : 1S1295
- D59 : 1S1295
- D60 : 1S1295
- D61 : 1S1295
- D62 : 1S1295
- D63 : 1S1295
- D64 : 1S1295
- D65 : 1S1295
- D66 : 1S1295
- D67 : 1S1295
- D68 : 1S1295
- D69 : 1S1295
- D70 : 1S1295
- D71 : 1S1295
- D72 : 1S1295
- D73 : 1S1295
- D74 : 1S1295
- D75 : 1S1295
- D76 : 1S1295
- D77 : 1S1295
- D78 : 1S1295
- D79 : 1S1295
- D80 : 1S1295
- D81 : 1S1295
- D82 : 1S1295
- D83 : 1S1295
- D84 : 1S1295
- D85 : 1S1295
- D86 : 1S1295
- D87 : 1S1295
- D88 : 1S1295
- D89 : 1S1295
- D90 : 1S1295
- D91 : 1S1295
- D92 : 1S1295
- D93 : 1S1295
- D94 : 1S1295
- D95 : 1S1295
- D96 : 1S1295
- D97 : 1S1295
- D98 : 1S1295
- D99 : 1S1295
- D100 : 1S1295

MIT(X57-1000-11)

AT UNIT (X57-1010-00)

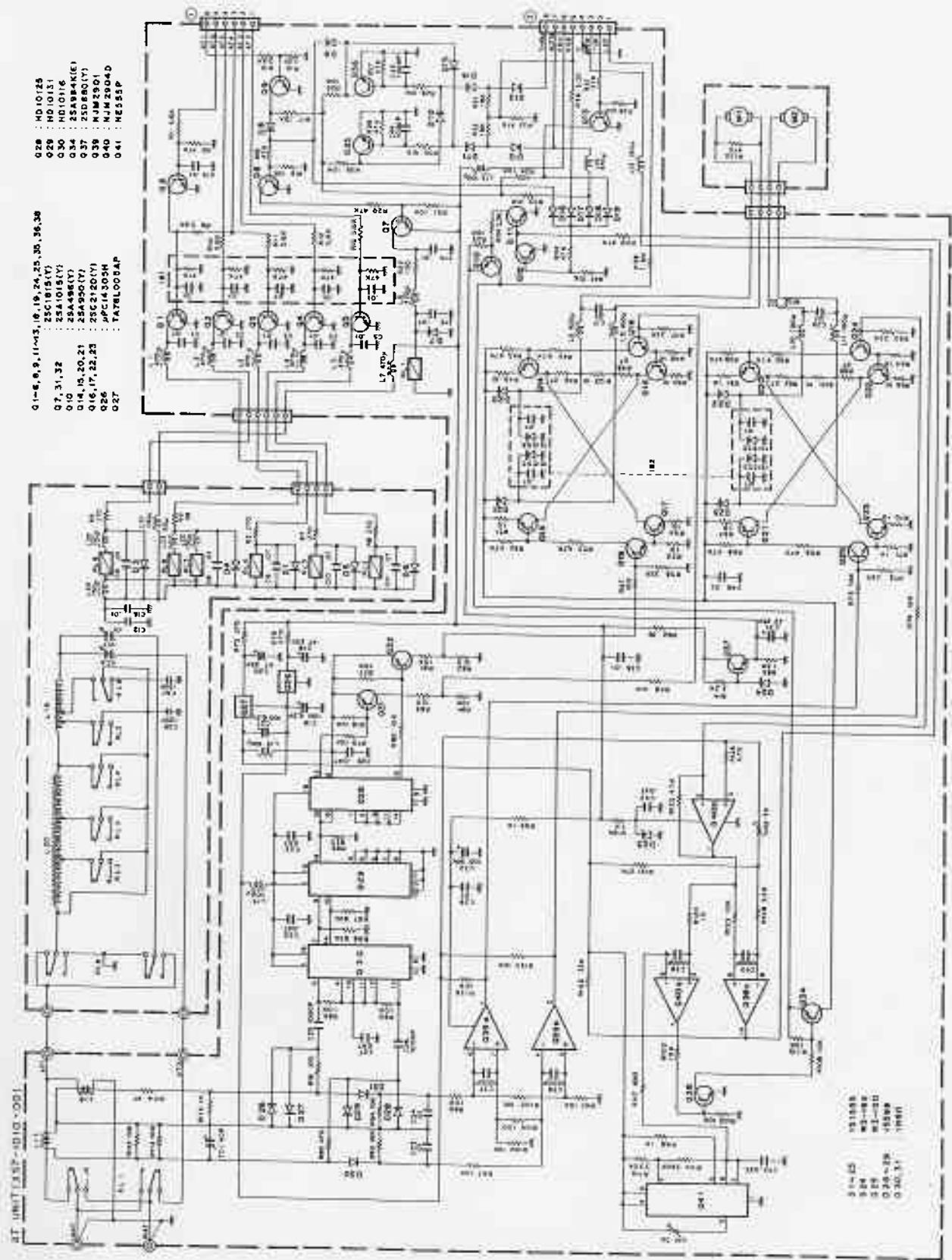

- 016-0, 9, 11, 13, 16, 19, 24, 25, 30, 36, 38
- 028 MD10125
- 029 MD10131
- 030 MD10116
- 034 25A984(K1)
- 037 25D680(Y)
- 038 KJM2901
- 040 KJM2904D
- 041 KES55P

- 07, 31, 32
- 010
- 014, 15, 20, 21
- 016, 17, 22, 23
- 026
- 027

- 25C1815(Y)
- 25A1015(Y)
- 25A456(Y)
- 25A950(Y)
- 25C2120(Y)
- PC143034
- TAT0008AP

131055
 131056
 131057
 131058
 131059
 131060

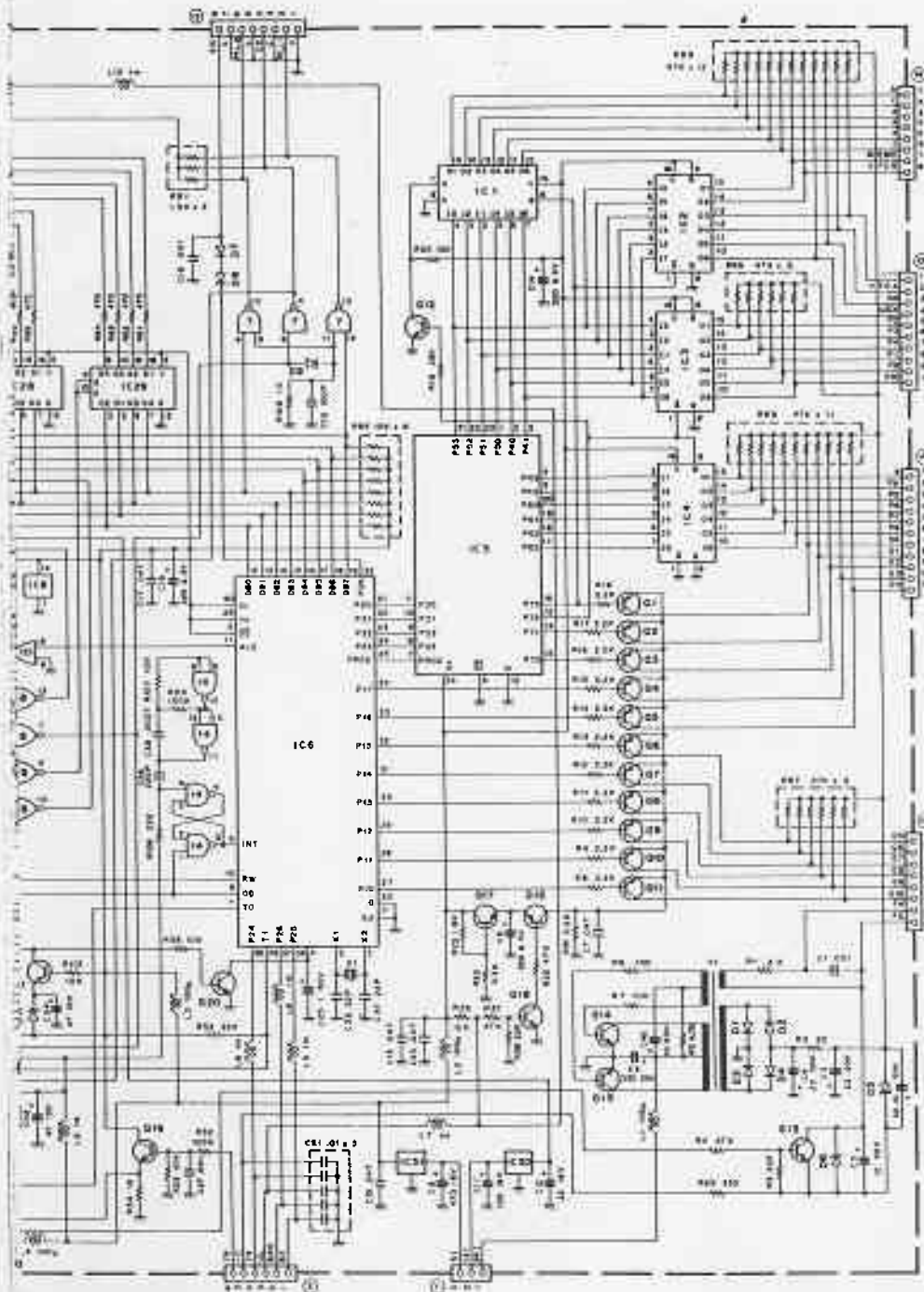

BIT(X54-1660-00)

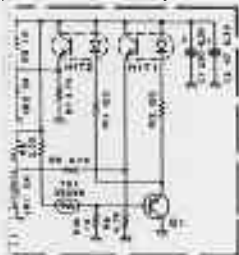

Q1, 16	: 2SA984K(E)	IC4-4	: TC5065P
Q2-11	: 2SA1049(GR)	IC5	: #PDB243C
Q12, 13, 16-20, 22, 24	: 2SC1815(Y)	IC6	: #PDB049C-2(1)
Q14, 15	: 2SC2274K(E)	IC7	: HD74LS01P or SN74LS01N
Q17	: 2SC1959(Y)	IC8, 10	: HD74LS02P or SN74LS02N
Q21, 23	: 2SA1015(Y)	IC9	: HD74LS00P or SN74LS00N
Q25	: 2SC1923(O)	IC11, 12, 20-29	: HD74LS75P or SN74LS75N
D1-4	: 1N4448	IC13	: #PD5101LC
D5	: WE-080	IC14, 15	: TC4011BP
D6	: WE-150	IC16, 19, 20	: TC4001BP
D7-9, 23-33	: 1S1587	IC17, 18	: MC14077B
D10, 12-21	: 1S1589	IC25-24	: HD74LS151P or SN74LS151N
B11	: 1N601	IC30	: #PC14312
		IC31	: #PC14305

AT UNIT (X57-1010-00)

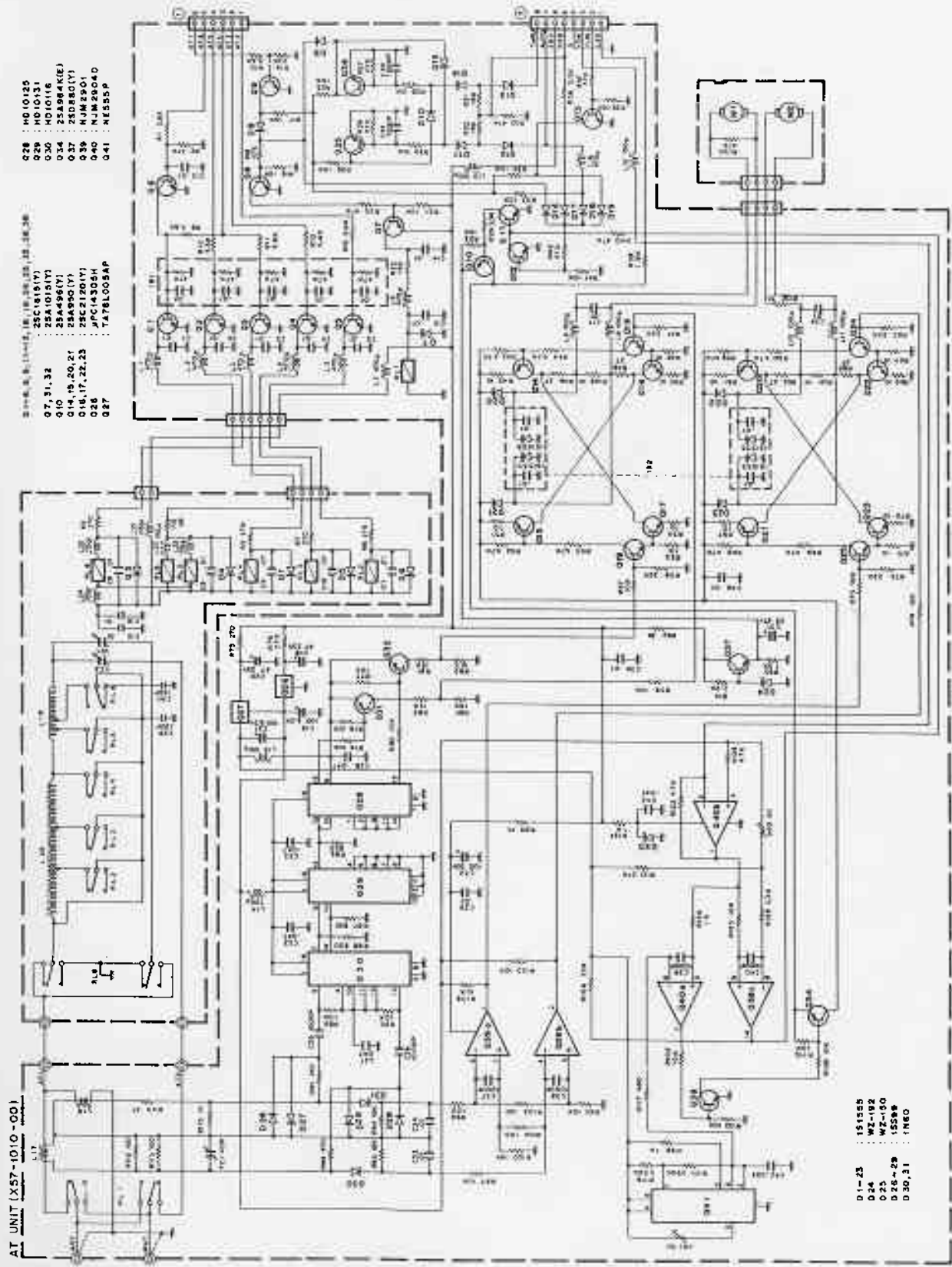

- 028 : KD1020
- 029 : KD1031
- 030 : KD1016
- 034 : 25A984(KZ)
- 037 : 25DR80(Y)
- 039 : KJM2901
- 040 : NJM2904D
- 041 : NES55P

- 07, 31, 33 : 25C1815(Y)
- 010 : 25A1015(Y)
- 014, 19, 20, 21 : 25A990(Y)
- 015, 17, 22, 23 : 25C2120(Y)
- 025 : µPC14305H
- 027 : T476L008AP

AT UNIT (X57-1010-00)

- D 1-23 : 151555
- D 24 : W2-192
- D 25 : W2-150
- D 26-29 : 15588
- D 30, 31 : 1NE0