

KENWOOD

TW-4000A

2 m · 70 cm FM DUAL BANDER

INSTRUCTION MANUAL



You are the owner of our latest product, the new TW-4000A transceiver. Please read this instruction manual carefully before placing your transceiver in service. The unit has been carefully engineered and manufactured to rigid quality standards, and should give you satisfactory and dependable operation for many years.

CONTENTS:

1. FEATURES.....	3
2. CONTROLS AND THEIR FUNCTIONS	4
3. INSTALLATION AND CONNECTION	10
4. OPERATION	14
5. ACCESSORIES	20
6. ADDITIONAL INFORMATION	22
7. BLOCK DIAGRAM	23
8. SPECIFICATIONS.....	23

Note:
As this unit is controlled by a microprocessor, a malfunction sometimes occurs due to noise and the display shows an incorrect indication. If this happens, reset the microprocessor. For resetting, refer to page 19.

■ ACCESSORIES



Carefully unpack your TW-4000A and check that it is supplied with the following accessories:

- | | | |
|---|--|----------|
| 1 | Electret condenser microphone
(with U/D switch) | 1 piece |
| 2 | Mounting kit | 1 piece |
| a | Bracket | 1 piece |
| b | Hex. head bolt | 4 pieces |
| c | Self tapping screw | 4 pieces |
| d | Flat head screw | 4 pieces |
| e | Washer (large) | 4 pieces |
| f | Washer (small) | 4 pieces |
| g | Spring washer | 4 pieces |
| h | Boss | 4 pieces |
| i | Nut | 4 pieces |
| 3 | Bail | 1 piece |
| 4 | DC power cord | 1 piece |
| 5 | Spare fuse (8 A) | 1 piece |
| 6 | 4-pin AUX plug | 1 piece |
| 7 | Antenna ID sticker | 2 sheets |
| 8 | Instruction manual | 1 book |

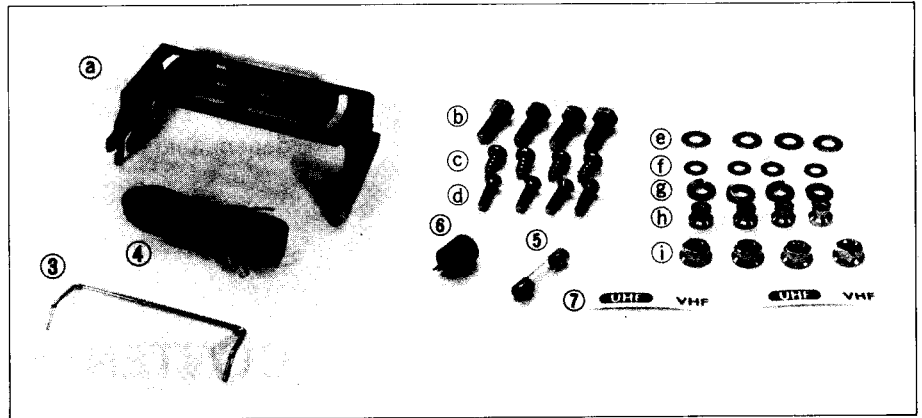
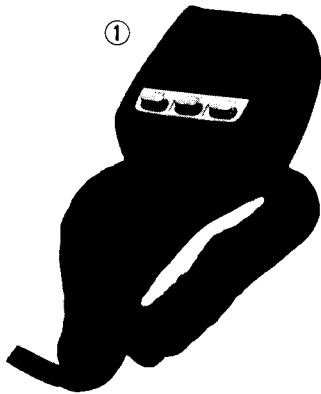

AFTER UNPACKING

Shipping container:

Save the boxes and packing in the event your unit needs to be transported for remote operation, maintenance, or service.

The following explicit definitions apply in this manual:

Note: If disregarded, inconvenience only, no risk of equipment damage or personal injury.

Caution: Equipment damage may occur, but not personal injury.

CAUTION WHEN REMOVING THE CASE COVER.

The case cover of TW-4000A incorporates several wirings. Be careful not to damage the wirings when removing the case cover.

Refer to page 19 on the method of removing the case cover.

1. FEATURES

- **Compact dual band transceiver:** Multi function dual band FM transceiver operating in the 2 m and 70 cm bands.

2 m band transceiver and 70 cm band transceiver are combined in a compact housing. This results in providing an improved operation capability, economical advantage, and novel design technique.

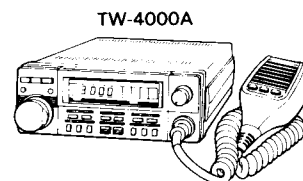

- **Large LCD display for good visibility:** A large LCD display enables you to verify operation and control conditions.
- **Front layout designed for simple operation:** The display and keyboard on the unit provides easy operation. Operating 2 m and 70 cm bands is as simple as operating one band.
- **Newly developed microcomputer:** Compact but offering multi functions.
- **Use of hybridized ICs:** Circuits are hybridized with ICs to achieve high performance and high density.

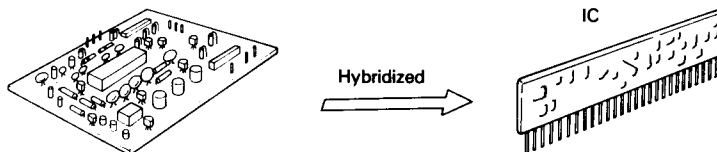

- **Use of diecast frame:** A diecast aluminum frame is used.

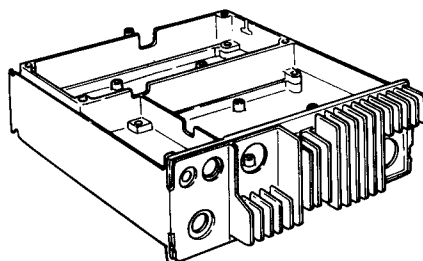

- **Memory back-up lithium battery:** The built-in lithium battery for memory back-up lasts approx. 3 years.
- **Synthesized voice system:** When operating the TW-4000A with the VS-1 (option) installed, a synthesized voice tells you the operation condition. For example, frequency setting can be verified by voice without seeing the display.

2. CONTROLS AND THEIR FUNCTIONS

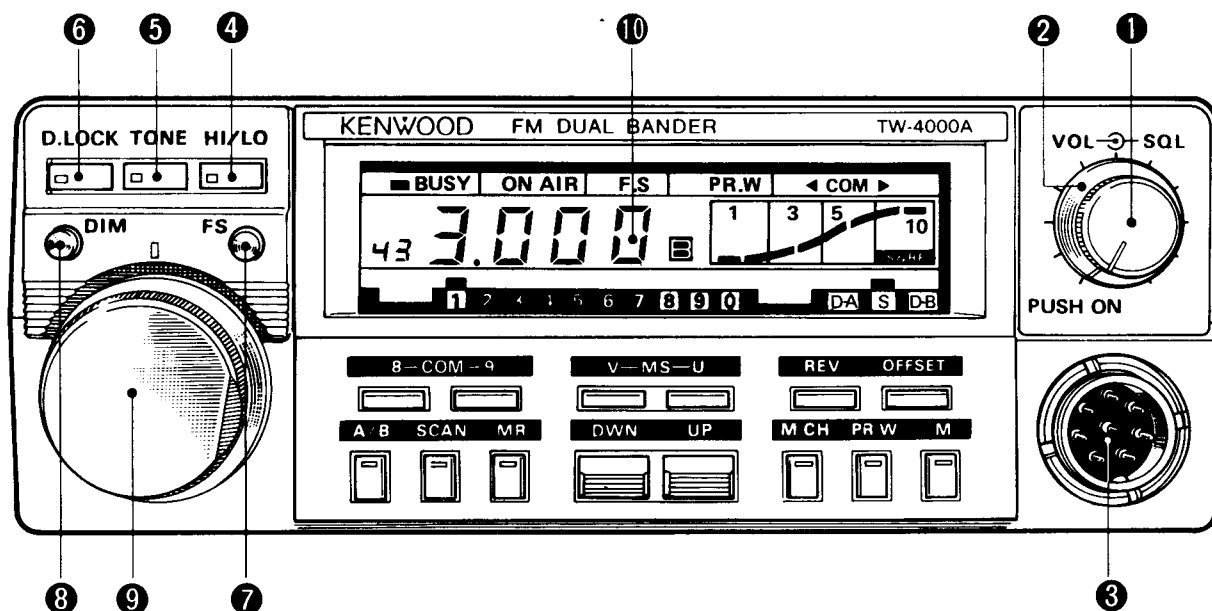

FRONT PANEL

- 1 VOL (volume)/Power switch** Power ON-OFF switch and volume control are combined. Pushing the switch turns power ON and OFF. Clockwise rotation will increase the volume.
- 2 SQL (squelch) control** The squelch control is used to eliminate noise during no-signal time. Normally, this control is adjusted clockwise until the noise disappears and the BUSY indicator goes off (threshold level). For scan operation, this control must be set to the threshold point.
- 3 Microphone connector (8 Pins)** Microphone audio input. Frequency UP/DWN control and PTT lines are included. Pin assignments of the MIC connector are shown below.

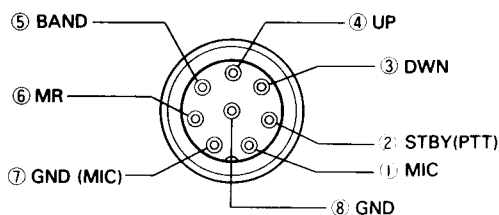

Note: Never apply any voltage to pins 2 through 6, or the TW-4000A is damaged.

- 4 HI/LO switch**

HI/LO
□
- 5 TONE switch**

TONE
□
- 6 D. LOCK switch**

D.LOCK
□

Out — High output. (■)
In — Low output. (▲)

When this switch is pressed, the repeater control tone signal (1,750 Hz) circuit is activated and the unit is set in the transmit mode.

With this switch ON, the displayed frequency is locked regardless of the TUNING DIAL operation. However, frequency controlled by the controls other than the TUNING DIAL is not locked.

7 F.S (frequency step) switch

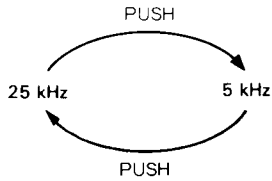

Depressing the switch alternates the VFO steps as shown: 25 kHz to 5 kHz, 5 kHz to 25 kHz...

The F.S. indicator lights when the frequency step is set to 5 kHz.

8 DIM (dimmer) switch



For operator convenience, this switch selects either bright or dim intensity of both the digital display, and meter illumination.

9 TUNING DIAL

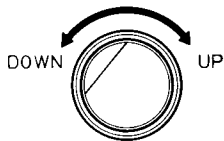

Clockwise rotation shifts the displayed frequency up. Counterclockwise rotation shifts it down. As the control rotates, the displayed frequency varies endlessly in 2 m and 70 cm bands respectively.

Note: One click rotation shifts the displayed frequency one step up or down. However, the frequency step may not be changed due to microcomputer transient.

10 Display panel and keyboard

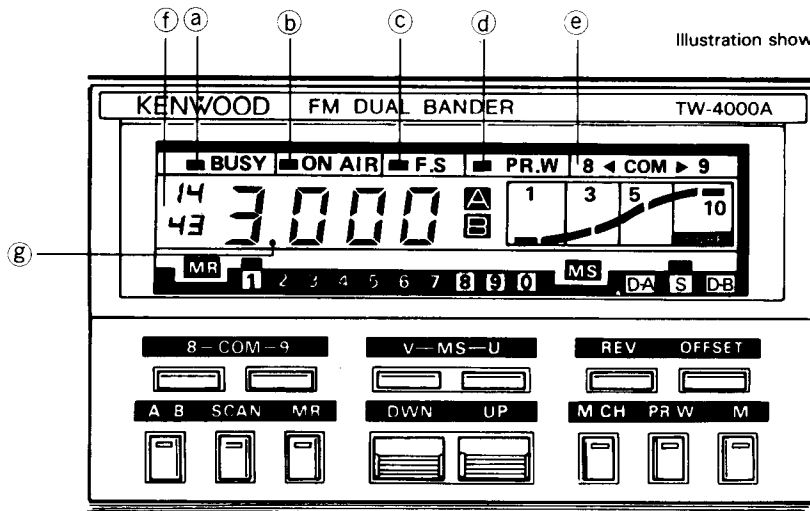

Illustration shows all indicators lit.

a BUSY indicator
■ BUSY

Lights when squelch is opened in receive mode and indicates channel is busy.

b ON AIR indicator
■ ON AIR

This lights during transmission mode.

c F.S. indicator:
■ F.S

Lights when the frequency step is set to 5 kHz.

d PR. W (priority watch) indicator:
■ PR.W

Lights when the PR. W switch is ON.

e COM indicator:
8 < COM > 9

Indicates "8" when the COM-8 switch is ON.
Indicates "9" when the COM-9 switch is ON.

f BAND indicator:
14
43

Indicates "14" when operating in 2 m band.
Indicates "43" when operating in 70 cm band.

g Scan indicator:

The dot (•) flashes while scan is in operation.

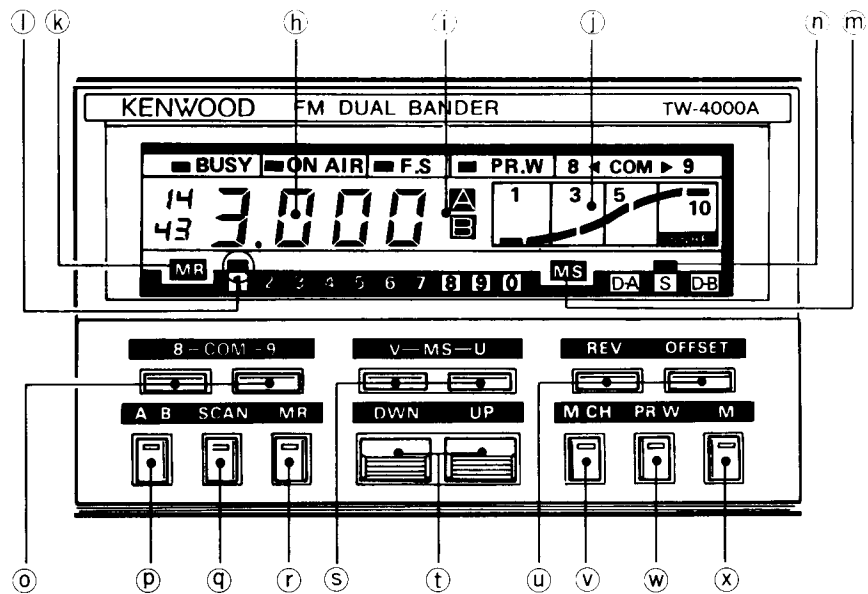

(h) Frequency display:



Indicates frequency.

All frequencies are indicated down to 1 kHz digit.

(i) VFO A/B indicator



VFO A indicator: lights when VFO A is operating.

VFO B indicator: lights when VFO B is operating.

(j) S/RF Level indicator

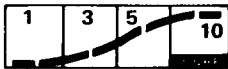

This LCD level meter indicates relative receive input signal strength or transmit RF output. With the HI/LO switch set to LO, mic input can be checked by LCDs.

(k) MR indicator



Lights while the MR key is ON and indicates (specified) memory channel.

(l) Memory channel indicator

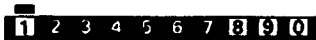

Lights up on a specified memory channel.

(m) MS indicator



Lights during memory scan operation.

(n) OFFSET indicator



[S] denotes that transmit and receive frequencies are the same.

[D-A] denotes that transmit frequency is shifted -600 kHz (-7.6 MHz) from the receive frequency in 2 m (70 cm) band.

[D-B] denotes that transmit frequency is shifted +600 kHz (+1.6 MHz) from the receive frequency in 2 m (70 cm) band.

Note: The following key operations generate a "beep" to verify activation.

(o) COM key



Depressing the COM-8 key recalls the content in CH 8 which has a priority over all other functions.

Depressing the COM-9 key recalls the content in CH 9 which has a priority over all other function.

Initial setting for both the CH 8 and CH 9 are: 145.000 for CH 8; 433.000 for CH 9. The contents for both CH 8 and CH 9 can be programmed at will. Frequencies in COM channels are displayed in 4 digits.

p) **VFO A/B key**



Used to select VFO A or VFO B. Each time the key is depressed, VFO is alternated from A to B, B to A...
This key is used to release VFO scan and also used to restore COM, MR operation to VFO.

q) **SCAN key**



Used to initiate scan operation. Depress the key to resume the scan from BUSY stop. For details of VFO, MR and COM scans, refer to page 17.

r) **MR key (Memory recall)**



Depressing the key recalls the specified memory channel. The recalled memory channel can be changed by depressing the M.CH, UP or DWN key or mic UP or DWN key. For a memory channel without a stored frequency, channel number only is displayed.

s) **MS key**



Used to select a band (either 2 m or 70 cm band) and initiate scan. MS-V key initiates scan in 2 m band. MS-U key initiates scan in 70 cm band. During scan, any vacant channels and specified skip channels are skipped. For MS key operation, refer to page 17.

t) **UP/DWN key**

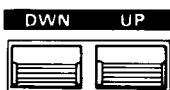

In VFO operation, depressing the key shifts the displayed frequency by 1 MHz steps in the 2 m or 70 cm band. Depressing the UP key once shifts the displayed frequency 1 MHz up. The DWN key performs the opposite operation. Holding the key depressed continuously shifts the displayed frequency up or down. During MR, the key operation shifts the memory channel up or down. During MS or MR scan, the key operation orients the scan direction. When the key is held depressed, the scan speed increases.

u) **REV/OFFSET key**



<OFFSET key>

Used to set transmit frequency (± 600 kHz in 2 m band or -7.6 MHz, -1.6 MHz in 70 cm band) shifted from the displayed receive frequency when operating a repeater. For operation other than that of a repeater, depress this key repeatedly until the OFFSET indicator "S" (Simplex) lights up. This equalizes the transmit frequency with the receive frequency. Repeated operation of this key lights the OFFSET indicator in the following order S, D-A, D-B, S...

This key operation is only effective in VFO, MR, or COM operation.

<REV key>

Used to check the input frequency for a repeater signal.

Depressing the key reverses the receive and the transmit frequencies. When transmitting with the key held depressed, the reversed frequency is restored.

v) **M.CH key**



Used to select a memory channel. Depressing the key once selects the next higher memory channel. Holding the key depressed selects the memory channel from lower to higher. During MS or MR scan, this key operation is disregarded.

w) **PR. W key**



Used to monitor whether the priority channel (CH 1) is busy or not. When this key is used, the receiver switches to the frequency stored in memory CH 1 for about one second (a beep will sound) in every about 10 seconds.

To cancel this function, depress the key.

This functions does not operated during transmission.

During priority channel (CH 1) reception, the FS switch and keyboard operations are inhibited.

x) **M key**



Used to store the frequency set by the VFO into memory channels. During COM operation, MS scan, or MR scan, this key operation is inhibited. In MR operation, unwanted memory channel can be skipped by this key.

REAR PANEL

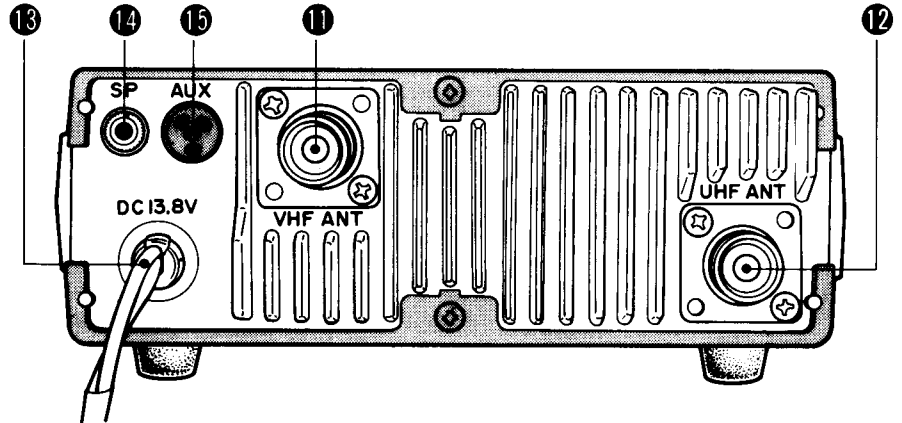

⑪ VHF ANT connector

⑫ UHF ANT connector

⑬ DC power cable

⑭ SP Terminal

⑮ AUX jack

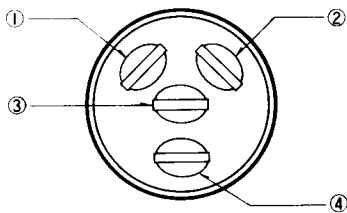

View from rear panel

An impedance of each VHF ANT/UHF ANT connector is 50Ω . Be sure to connect terminals. The VHF ANT terminal is an M type. The UHF ANT terminal is an N type.

Input voltage is 13.8 V DC.

Caution:

Observe plus (red) and minus (black) polarity!

External speaker terminal. Connect a 4~16 ohm speaker using the supplied plug.

This jack has the tone-pad input terminal for Auto-patch operation. **When used, note the load current through the pin terminals 1 and 4.**

(See page 18.)

Terminal No.	Terminal function	Application
①	43C	70 cm BAND DC 8 V 10 mA load
②	14C	2 m BAND DC 8 V 10 mA load
③	E (GND)	Earth
④	8T	Transmission DC 8 V 10 mA load

Note:

Do not apply any voltage to pins 1, 2 and 4.

Do not short pins 1 and 4 to the ground.

BOTTOM

⑯ VOICE ON-OFF switch

Activates the voice-synthesizer unit (option).

With the switch ON, all voice generating functions are activated. With the switch OFF, these functions are deactivated.

However, the following verifications still function.

- "Power ON" is announced when power is ON.
- The beep will sound.
- "Operation status" is announced when the V.RCL switch on the front panel is used.

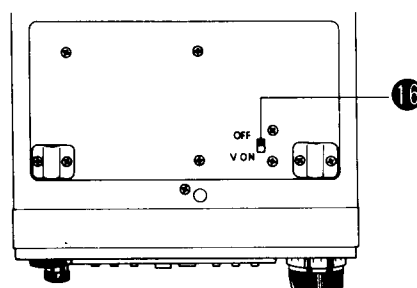

■ MICROPHONE

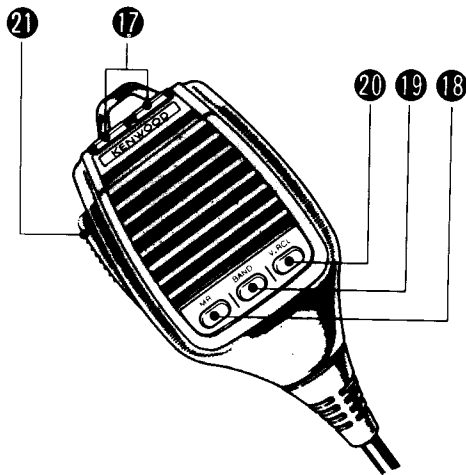

Notes: For a microphone to be used with this transceiver.

1. Using a microphone other than that supplied with this transceiver may cause damage of this transceiver.
2. If the microphone supplied with this transceiver is used with other transceivers, it may cause damage of those transceivers.
3. The mic circuit and the mic connector of the TW-4000A are illustrated below. When using another microphone with this transceiver or using the supplied microphone with another transceiver, ensure that the mic plug corresponds to the mic connector jack.

However, careless use of a microphone may cause damage of the transceiver and void the warranty.

17 UP/DWN switch

Controls three kinds of functions

< Frequency up and down function >

In VFO operation, depressing the UP or DWN key momentarily shifts the displayed frequency one step up or down. Holding the key depressed continuously shifts the frequency up or down within the same band. During VFO scan, depressing the UP or DWN key controls up or down scan and rapid scan.

< 1 MHz steps up or down function >

With the BAND switch ON, depressing the UP or DWN key momentarily shifts the displayed frequency 1 MHz up or down. Holding the key depressed continuously shifts in one MHz steps up or down.

< Memory channel up or down function >

In MR operation, depressing the UP or DWN key momentarily recalls the memory channel upwards or downwards. Holding the key depressed continuously recalls the memory channel upwards or downwards. During MR scan or MS operation, scan direction can be selected by depressing the UP or DWN key. During this operation, holding the key depressed initiates rapid scan.

18 MR switch

Used to recall memory.

With the switch ON, only the REV, OFFSET, PR.W and M keys on the keyboard are operable.

19 BAND Switch

With the switch ON, depressing the UP (or DOWN) switch shifts the displayed frequency 1 MHz steps up (or down).

20 V.RCL switch

To use this switch, the optional voice generating unit must be installed. When depressed, the mode of operation is indicated by voice.

21 PTT Switch

Press-to-talk switch is used for transmission. This will also releases scan operation.

Supplied mic circuit (T91-0327-05)

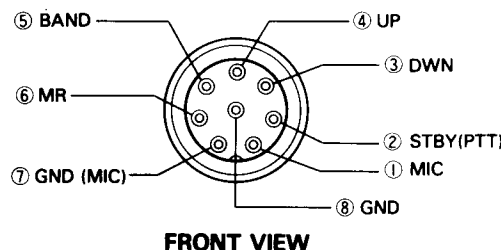
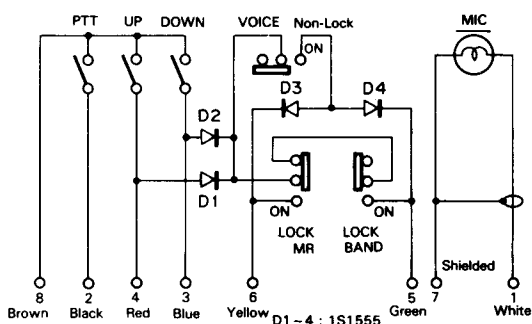

Note: Never apply any voltage to pins ② through ⑥, or the TW-4000A is damaged.

3. INSTALLATION AND CONNECTION

■ ANTENNA

The performance of the transceiver depends upon the type of antenna to be used. To ensure the maximum performance of the TW-4000A, select a suitable antenna and adjust it for low VSWR.

Antenna connection

Two antenna connectors are provided.

<For individual connection of both 2 m and 70 cm antenna>

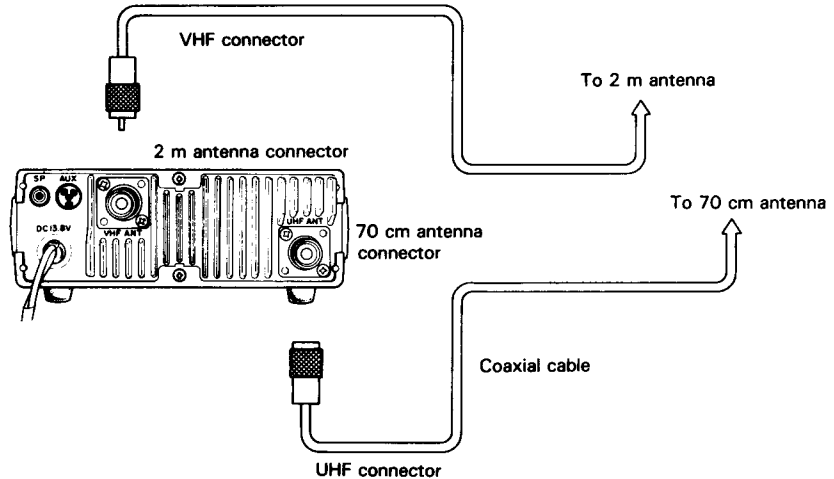
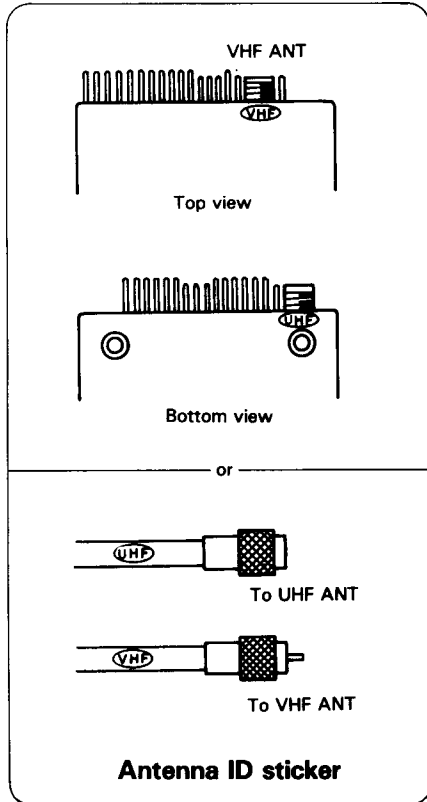

Be sure to connect a VHF and a UHF antenna to their correct connectors. Affix the supplied antenna identification sheet to each antenna coaxial cable to prevent reversed hook-up.

<Common Antenna for 2 m/70 cm Operation>

The TW-4000A is designed so that two different transmit outputs (2 m band and 70 cm band) are supplied to individual antennas. Use of individual antennas is recommended as it simplifies antenna matching and minimizes the loss caused by the antenna. However, the figure shows the connection of a single antenna coupled through a duplexer. This is a convenient for mobile installation. Before installation, ensure how to connect the duplexer and antenna to the transceiver. The optional common antenna MA-4000 is available.

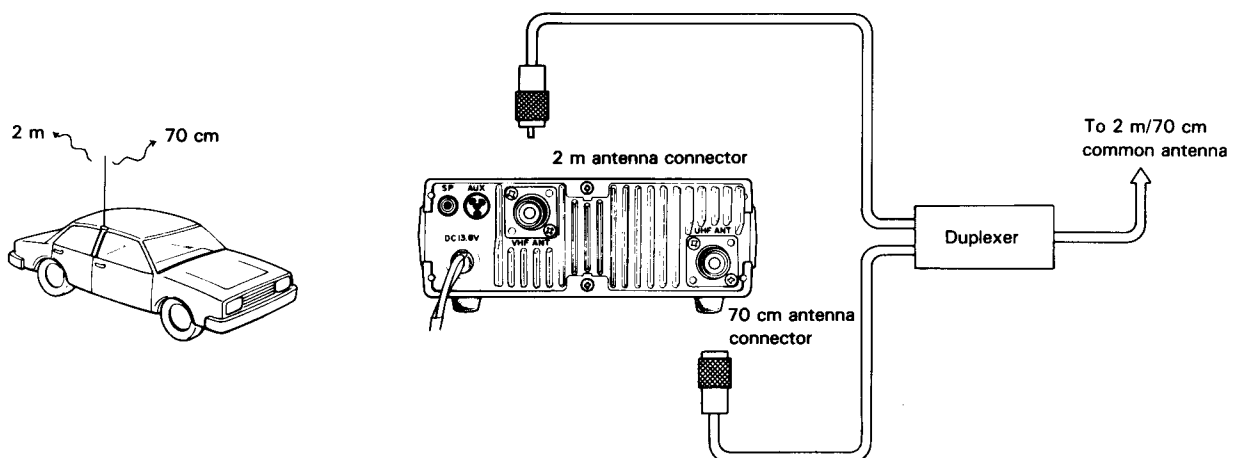

Notes:

1. A common antenna should be connected through a duplexer (some types of common antenna have built-in duplexer).
2. An antenna selector (up to 70 cm band) may be used in lieu of a duplexer.
3. Never attempt to connect a common antenna without using a duplexer.

MOBILE INSTALLATION

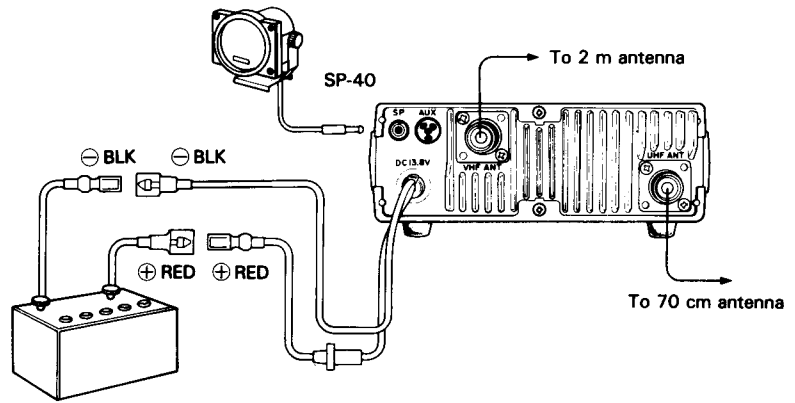

Interconnection

The TW-4000A is equipped with a speaker. However, the SP-40 (option) external speaker can be used.

Installation location

Using the supplied mounting bracket, install the transceiver under the dashboard or on the side of the console in your car as shown.

If your car is equipped with an electronic fuel injector, the transceiver should be as far from the control equipment as possible.

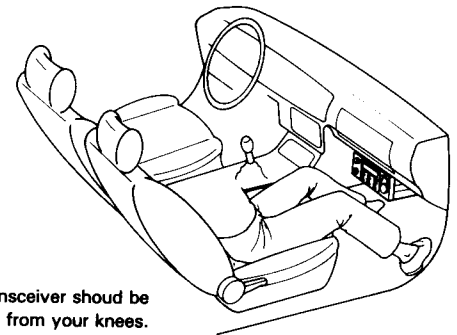
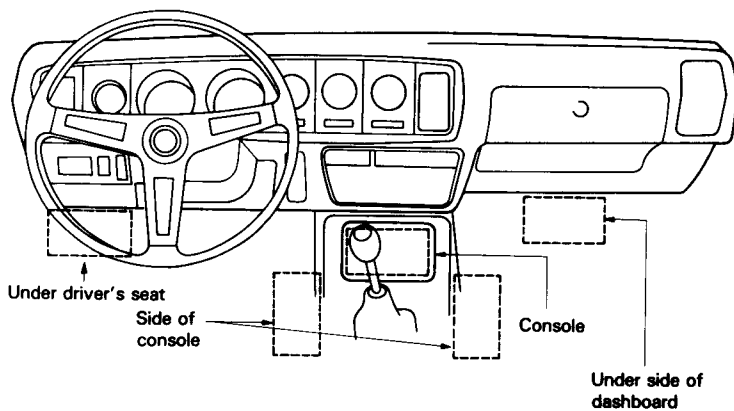

The transceiver should be located from your knees.

Coaxial cable

For satisfactory transceiver operation, coaxial cable must be used. When the transceiver is used for fixed station service, the coaxial cable becomes relatively long, so low loss (large diameter) coaxial cable of the shortest length possible should be used, as cable loss cannot be neglected when operating in the VHF and UHF bands.

When the coaxial cable must be 10 m or more in length, use cable of larger diameter such as RG8/U.

• Mobile Installation

Note:

For installation, use the supplied mobile boss and angle. If the unit is directly installed in the angle, use an M4 screw with a length of up to 12 mm. If a longer screw is used, a short-circuit may result.

To secure the supplied mounting bracket and to mount the transceiver, proceed as follows:

1. Secure 2 bosses on each side of the transceiver as shown in Fig. a.
2. Attach the bracket to a mounting place, and mark a guide to be drilled. Make guide holes ($\phi 4 \pm 0.2$) with a drill.
3. Secure the bracket as shown in Fig. b.
4. Insert transceiver's bosses into the bracket grooves and slide the transceiver backward until it is secured. See Fig. c.

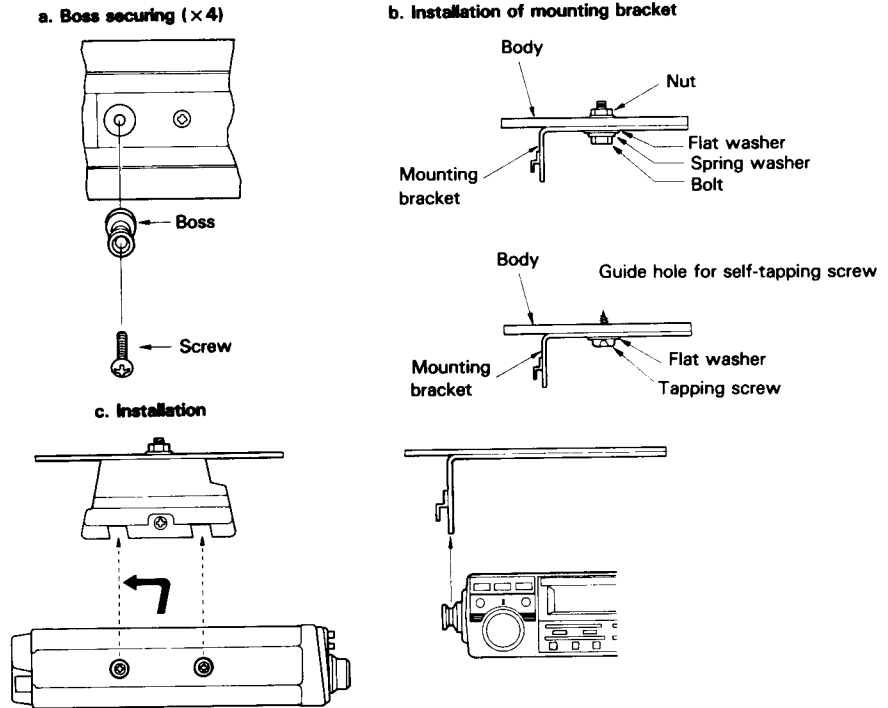

• Antenna Installation

Various types of antennas for VHF, UHF mobile operation are available.

Note:

For gutter-mount installation, the antenna bracket must be grounded to the car body as shown below. Affix the antenna securely, referring to the antenna instruction.

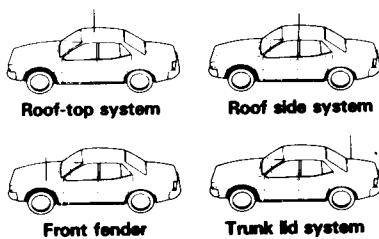

Installation for mobile operation.
Be sure to use a duplex mobile antenna.

Coax. cable routing

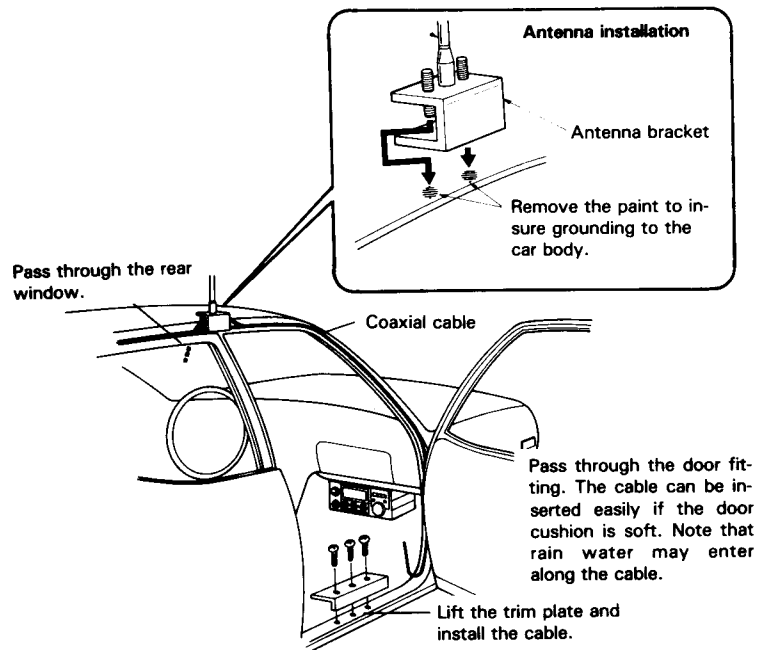

• **Power supply**

Connect the supplied power cable with fuse directly to the battery terminals. Connecting to the cigarette lighter socket can cause a poor connection, and excessive voltage drop.

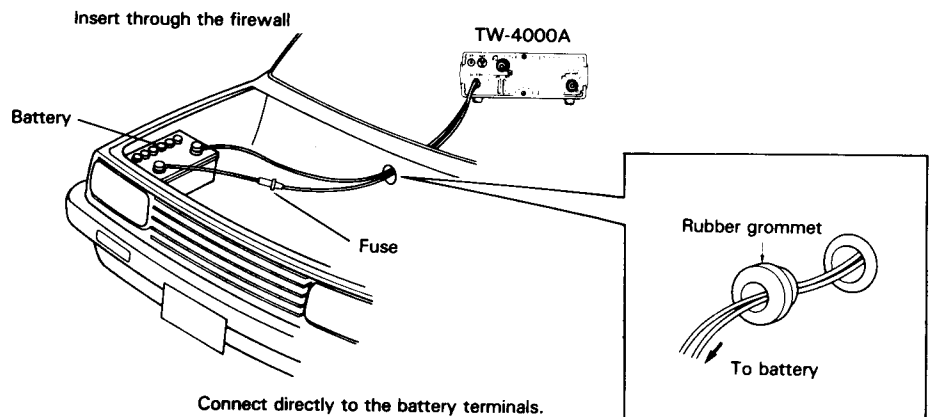

• **Ignition noise**

The transceiver is designed to suppress ignition noise; however, if excessive noise is present, it may be necessary to use suppressor spark plugs (with resistors).

For this purpose, the Kenwood PG-3A is available.

■ **FIXED STATION INSTALLATION [general]**

• **Power supply**

A regulated DC power supply (13.8 V DC, 8A or more) is required. It is recommended that the Kenwood PS-430 be used for a power supply.

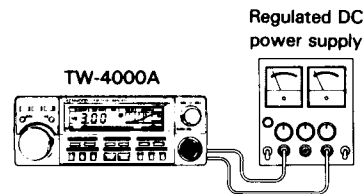
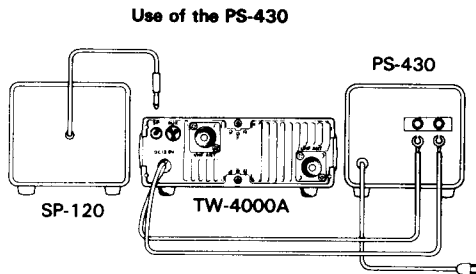

NOTE:
Preferably, voltage should be adjusted to 13.8 V DC. Current capacity is more than 8 A.

The regulated supply should be equipped with a built-in protection circuit for both overcurrent and over-voltage.

CAUTION
A battery charging power supply cannot be used.

• **Antenna**

Various types of fixed station antennas are commercially available, select your desired antenna according to your installation space and application.

Note that the SWR of your antenna should be less than 1.5. A high SWR will cause the TW-4000A protective circuit to operate, reducing the transmit output power.

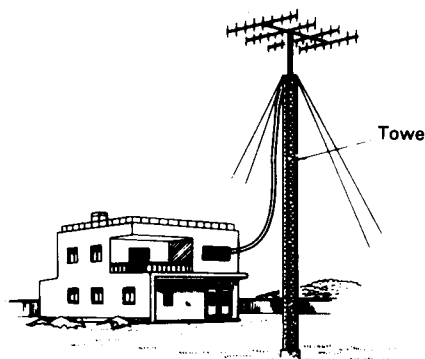
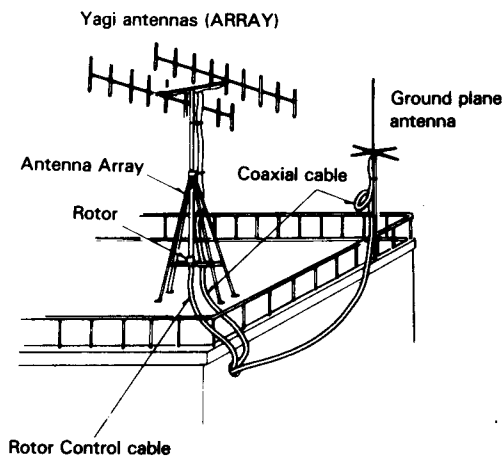

Transceiver performance depends largely on the type of antenna used. For fixed station operation there are ground plane antennas (omni-directional) and Yagi antennas (uni-directional). The Yagi antenna is suitable for long distance operation (DX) or communication with a specific party. (having excellent directivity and antenna is generally used for local operation.)

4. OPERATION

■ RECEPTION

When power and antenna connections are complete, set the controls and switches as follows:

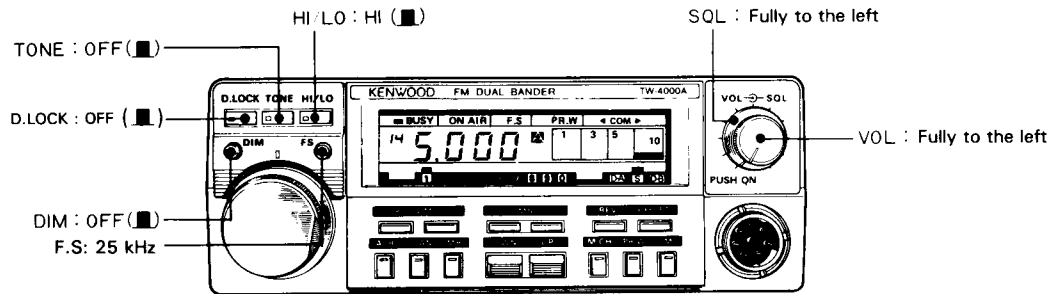

After verifying the initial setup of controls and switches, proceed as follows:

- (1) Depress the VOL control to turn on power. The indicators on the display light to show the transceiver is operating. (Indicators function correctly after about 0.5 seconds.)
- (2) As the VOL control is turned clockwise, either noise or a QSO is heard.
- (3) To eliminate the no-signal noise, use the SQL control. For SQL control operation, refer to next explanation.
- (4) Tune to the desired frequency using the tuning dial together with the UP and DWN keys.
- (5) To recall COM channel memory, depress the COM-8 or the COM-9 key. COM channel memory (Initial setup for CH 8 is 145.000 MHz and for CH 9 is 433.000 MHz) can be recalled during any mode. For details, refer to "Memory operation" on page 15.

• SQL (squelch) control

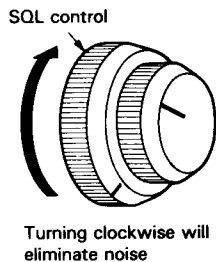

To eliminate receiver noise at the no-signal condition, slowly adjust the squelch clockwise until the noise disappears and the BUSY indicator goes off (threshold point).

The squelch will open, the BUSY indicator will light and the speaker will operate when a signal is received.

The squelch control is also used for scan operation control. If the signal is weak or fades during mobile operation, readjust the squelch for consistent reception.

■ PR. W OPERATION (Priority channel watch)

The PR.W key is used to monitor memory CH 1. When the key is depressed, CH 1 can be monitored for about one second at about 10 second intervals regardless of any other mode operation. When CH 1 is monitored, the beep will sound. Depressing this key turns the priority watch function ON and OFF. When the PR.W function is ON, the PR.W indicator lights. When transmitting during CH 1 reception, the reception is interrupted.

■ TRANSMISSION

To transmit, first select frequency to be used and see whether it is busy or not. If it is not busy, simply depress the mic PTT switch for transmission. The ON AIR indicator lights.

• Transmitter precautions

- The TW-4000A antenna (both 2 m and 70 cm) impedance is 50 ohms. Be sure to use only an antenna of 50 ohms impedance. This transceiver operates in both the VHF and UHF bands. Thus, (both) antennas should be connected to these jacks.
- Check the intended transmit frequency before operating to prevent interference with other stations.
- Pressing the microphone PTT switch places the transceiver in transmit mode; the ON AIR indicator will light and the LCD bar meter shows transmitter power. Recommended talk distance to the microphone is approximately 5 cm.

Note:

Microphone sensitivity can be set according to your necessity by adjusting the VR2 on the transceiver RX-TX unit.

• HI/LO power switch

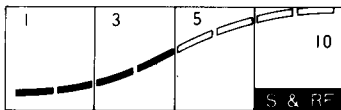

QSO between locals can be enjoyed with less interference to others and with less power consumption by reducing the RF output power. This is accomplished by depressing the HI/LO switch, which reduces power from 25 W to approx. 5 W. Power indication will drop to approximately "3~5" on the meter. Up to 10 W (approx.) can be internally set with the HI/LO switch in the LO position.

■ MEMORY INPUT OPERATION

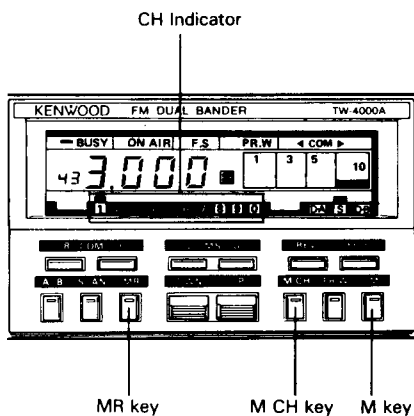





Use of the memory is recommended to store frequencies (Club channels, etc.). TX OFFSET setting can be stored simultaneously. Initial memory channel settings for this unit are as follows:

- CH 1 Vacant (Priority watch function)
- CH 2 - CH 7 Vacant
- CH 8 145.000 MHz
- CH 9 433.000 MHz
- CH 0 Vacant (Dual memories for transmission and reception)

In CH 8 and CH 9, initial settings are stored at the factory. These settings can be programmed at will. The contents of both can be recalled in any mode. In CH 0, transmit frequency and receive frequency can be stored individually.

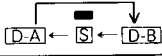
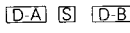
• Memory input procedure

Procedure	Operation	Activation	Example	Remark
1	Memory channel setting  Depress	Depressing the M CH key once shifts the memory channel one channel higher. Holding the key depressed shifts the memory channel.	Storing 145.500 in CH 5. 1 2 3 4 5 6 7 8 9 0	During MR or MS scan, the key operation is disregarded.
2	Frequency setting Set the frequency to be stored.		¹⁴ 5500	In VFO
3	TX OFFSET setting  Depress	Each time the key is depressed, the indicator shifts in the following order. 		During scan, this key operation is disregarded.
4	Memory input  Depress	Frequency and OFFSET settings are stored in the specified memory channel.		A "beep" will sound.

• Memory input in CH 0

To store transmit frequency and receive frequency in CH 0, proceed as follows: Repeat steps 1 through 4 of the previous procedure.

Procedure	Operation	Activation	Example	Remark
1	Transmit frequency setting Receive (observe) for a while with the frequency set for transmission.		Transmit frequency 433.500 ₄₃ 3500	In VFO
2	Transmit mode setting Depress the PTT switch.	ON AIR lights.	■ ON AIR	
3	Memory input Hold the transmit mode and depress the M key.	The transmit frequency (not the same as receive frequency) is stored in CH 0.		A "beep" will sound.

• Memory recall (MR)

Designate a memory channel to be recalled by pressing the M CH key and press the MR key to recall the memory.

Example: To recall 145.500 in CH 5.

- ① Press the M CH key so that the channel indicator lights up at CH 5.
- ② Press the MR key.

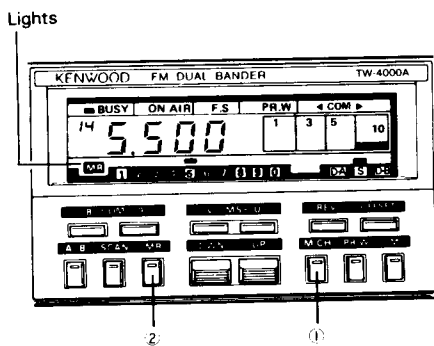







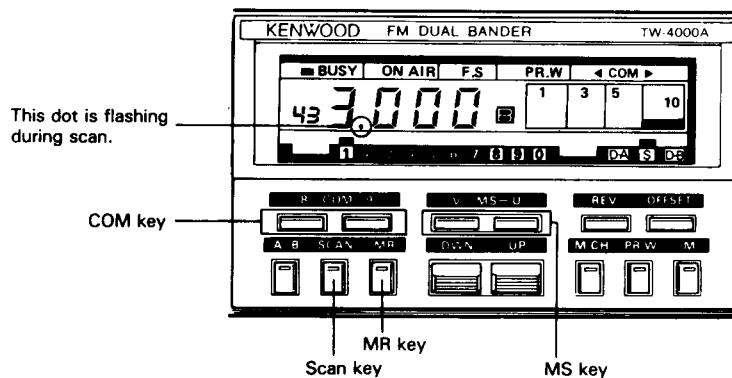

Notes:

- When depressing the M key during MR operation, skip a memory channel while scanning. Refer to "SCAN LOCKOUT OPERATION" on page 17.
- To renew memory, simply store a new frequency over an old one. Initial setting can be restored by resetting.
- Frequency is not displayed when the memory channel is empty.
- In MR operation, the OFFSET setting can be rewritten by pressing the OFFSET key.

■ SCAN OPERATION

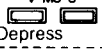
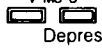

Before operating scan, turn the SQL control clockwise until, no-signal noise disappears.

Scan mode	Mode before scanning	Operation	Activation	Stop scan	Remark
VFO scan	When VFO A or B is in operation.	 Depress	The scan operates within the band 1 MHz in 25 kHz steps.	 Depress or transmit	While the F.S indicator lights, frequency varies in 5 kHz
MR scan	When memory is in operation.	 Depress	The memory channels are scanned repeatedly until the MR key, or the mic PTT switch is depressed for transmission.	 Depress or transmit.	With the mic MR switch ON, MR scan will not work.
COM scan	COM channel 8 or 9 is in operation.	 Depress	COM channels 8 and 9 are scanned alternatively every 5 seconds.	 Depress COM-8 or COM-9 key, or transmit.	No BUSY stop in this operation. When holding the scan by the COM key, the depressed COM channel is operated.
MS scan VHF/UHF memory scan		 Depress  Depress	2 m band memory channels only are scanned. 70 cm band memory channels only are scanned.	 Depress or transmit.	Transmit operation restores the mode to MR operation.

- To resume scan while stopped at a busy station, proceed in accordance with the type of scan.
- Scan hold after a signal goes off is approx. one second.
- MR or MS scan will begin from the specified memory address.
- In MR scan or MS (memory scan) operation, scan direction can be selected by either the UP or DWN key of the transceiver, or the mic UP or DWN switch.
The scan direction cannot be selected individually in MR and MS operations. In VFO scan, the mic UP and DWN switches designate the scan direction. The scan direction will not change unless designated.
- In MR scan or MS operation, empty channel and skip channel are skipped.
- When specified memory channels are all skipped channels, MR scan or MS operation is not available.

■ SCAN LOCKOUT (Skip) OPERATION

In MR operation when the M key is depressed, the scan indicator (dot) goes off. This denotes that the displayed memory channel is skipped during MR or MS scan. Depressing the M key again restores the dot to show that the channel lockout is released.

■ TX OFFSET OPERATION

The "D-A" indication shows that transmit frequency is shifted -600 kHz (-7.6 MHz) from receive frequency in 2 m (70 cm) band.

The "D-B" indication shows that transmit frequency is shifted $+600$ kHz (-1.6 MHz) from receive frequency in 2 m (70 cm) band.

When operating without a repeater, set the transceiver in Simplex mode "S". Transmit and receive frequencies are the same. When transmit frequency goes out of band by OFFSET setting, the transceiver is automatically set in Simplex mode and the beep will sound.

■ MICROPHONE OPERATION

Do not use a microphone other than that supplied.

Remote control (UP-DWN operation)

Depressing the UP or DWN switch once shifts the displayed frequency one step up or down. Holding the UP (or DWN) switch depressed shifts the frequency up (or down).

TW-4000A mode Mic-switch	VFO A/B	MR
UP	Freq. upwards	Channel upwards
DWN	Freq. downwards	Channel downwards

In scan operation, scan direction can be selected and rapid scan can be operated.

Scan Mic-switch	VFO	MR	MS
UP	Freq. upwards	Channel upwards	Channel upwards
DWN	Freq. downwards	Channel downwards	Channel downwards

- During MR or MS scan, holding the UP or the DWN switch depressed stops the scan until the switch is released.
- During VFO scan, holding both the UP and DWN switches depressed stops the scan until the switches are released.

Remote operation with microphone switches

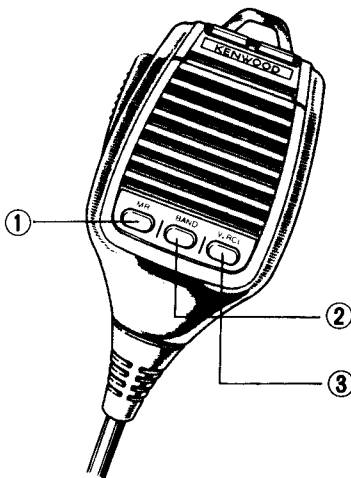

- ① With the mic MR switch depressed, memory channel is controlled up or down by the mic UP or DWN switch
- ② With the mic BAND switch depressed, band is controlled up or down by the mic UP or DWN switch.
 - The mic MR switch has priority over the transceiver keys. Be sure to release this switch before operating transceiver keys.
 - The BAND switch is operable only when VFO is in operation.

Voice synthesizer operation

- ③ The V.RCL switch does not activate unless the voice synthesizer unit is installed in the transceiver. Setting the mic V.RCL switch to ON and OFF activates operations as follows:
 1. With the voice ON/OFF switch ON, depressing the V.RCL switch once generates voice to indicate the operation condition.
 2. With the switch OFF, voice is generated when the V.RCL switch is held depressed to indicate the operation condition.

Note:

When a commercially available Touch-Tone encoder is used through AUX jack, set the deviation to 3 kHz with both the 3 and 6 keys of the encoder held depressed. Next, hold both the 2 and 3 keys depressed to verify the deviation being within 1.2 kHz \pm 0.3 kHz.

■ COVER REMOVAL



- Remove four screws securing the top cover. Slide the cover about one inch to the rear and lift it off.
- Remove four screws securing the bottom cover. Slide the cover and lift it, then unplug speaker and voice ON-OFF switch connectors before removal.

Note:

The case cover of TW-4000A incorporates several wirings. Be careful not to damage the wirings when removing the case cover.

■ MEMORY BACK-UP LITHIUM BATTERY

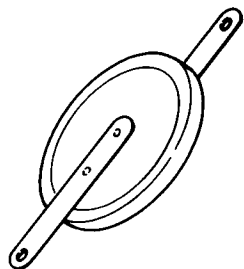

A lithium battery is contained in the transceiver to retain memory. Therefore, turning off the POWER switch, disconnecting the power cable, or a power failure will not clear the memory. The battery will last approximately three years. However, note that frequent operation of the power switch ON and OFF may lessen the life of the battery. When the battery discharges an erroneous display may appear on the LCD. Lithium battery replacement should be performed by an authorized Trio-Kenwood service facility either your Trio-Kenwood dealer, or the factory.

Note:

When the lithium battery is replaced, the microprocessor must be reset.

■ RESETTING THE MICROPROCESSOR

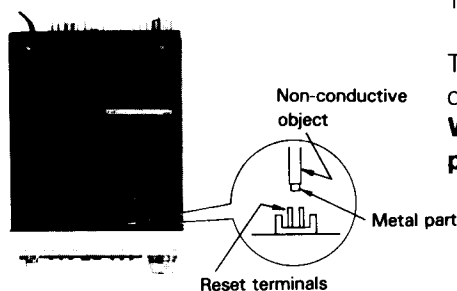

The microprocessor can be reset as follows:

Turn on power and set the transceiver in receive mode. Short the 2P terminal once for microprocessor reset as shown. Use a conductive tip of lod as shown. **When resetting, be sure not to short any pins other than the 2P terminal to prevent the microprocessor from being damaged.**

■ MIC INPUT MONITORING FUNCTION

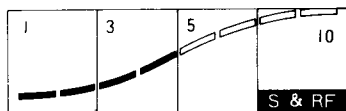

Using the RF indicator, mic input level can be monitored to show whether the mic is working or not.

When transmitting with the HI/LO power switch set at LO, 3~5 LCDs on the RF indicator light. When speaking into the microphone, the reset of the meter display lights according to the strength of the mic signal.

■ BAIL MOUNTING

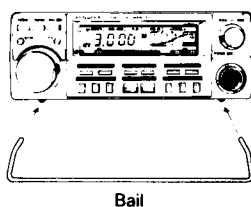

To raise the front part of the transceiver, insert the supplied bail as shown.

5. ACCESSORIES

■ VS-1 (VOICE SYNTHESIZER UNIT)

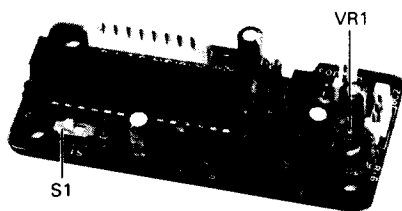

- Voice output

- Language selector switch

- VS-1 Talk speed selection

The place in which a jumper wire to be placed.

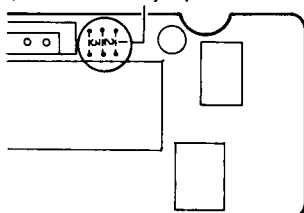

- Voice output level adjustment

- Voice ON-OFF switch

- The voice synthesizer operates

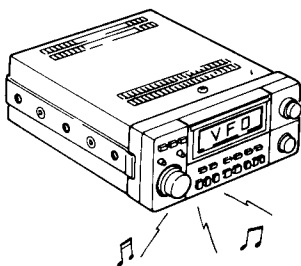

Memory content can be verified by voice synthesizer system even with the operation in VFO.

By installing the voice synthesizer unit in your TW-4000A, a voice output is provided to inform you of the current operating status.

When operating the transceiver, voice output is produced to inform you of the current operating status. By depressing the front panel V.RCL switch, the current status can be confirmed without seeing the transceiver.

Switch S1 selects either English (EN) or Japanese (JA) language.

Speed is factory set at "standard" talk speed. Three different speeds can be selected.

Speed Jumper place	Std. speed	30% more than Std.	60% more than Std.
1	×	×	○
2	×	×	○
3	×	○	×

Symbol (○) denotes the place in which a jumper wire is placed.

Note:

When placing the jumper, solder carefully.

Voice output level is factory adjusted. This level can be readjusted with VR1.

With the voice ON-OFF switch set to OFF, the synthesizer is deactivated. However, the "beep" will still sound to indicate other operations. "Power On" also announced when the power is switched ON. When the V.RCL switch is depressed, operation status can be verified by voice even with the synthesizer ON-OFF switch set to OFF.

- When power is switched on, "power on" is announced.
- When frequency is changed, V (VHF) or U (UHF) is announced and then frequency is announced.

Example: 145.320 MHz

"V" for VHF, "five" for 145 MHz, "point", "three", "two" and "zero" are announced.

- When the VFO A/B switch is used, "V" for VHF or "U" for UHF is announced and then "A" for VFO A or "B" for VFO B.

Example: When VFO A is used in VHF band, "V" and "A" are announced.

- When memory recall is used, channel number (1-9,0), "V" for VHF or "U" for UHF, "frequency", and TX OFFSET setting are announced. However, SIMPLEX setting is not announced.

Example 1: When memory recall is 145.320 MHz in channel 3, the following is announced:

"Three" for CH3, "V" for VHF, "five" for 145 MHz, "point", "three", "two", and "zero".

Example 2: When memory recall is 435.320 MHz (TX OFFSET "D-A") in channel 3, the following is announced:

"Three" for CH3, "U" for UHF, "five" for 435 MHz, "point", "three", "two", "zero", and "D", "A".

When the recalled channel is empty, "channel number" and "open" are announced.

- Each time memory channel is changed, "channel number" (1-9,0), "V" for VHF or "U" for UHF, "frequency" and "TX OFFSET" setting are announced.
- When setting TX OFFSET, "SIMPLEX", "D", "A" or "D", "B" is announced according to the setting.

■ MA-4000 VHF/UHF DUAL BAND MOBILE ANTENNA (Duplexer supplied)

The MA-4000 is a dual band (2 m/70 cm) mobile antenna supplied with a duplexer.

The duplexer connects to both the 2 m band and 70 cm band antenna terminals on a dual band transceiver.

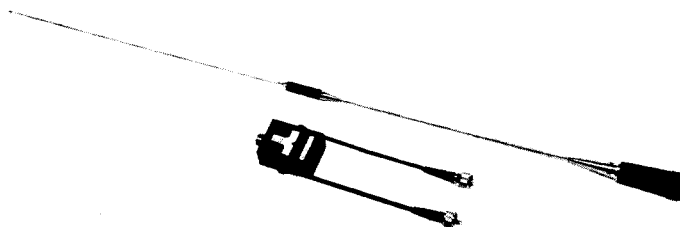

■ FIXED STATION DC POWER SUPPLY PS-430

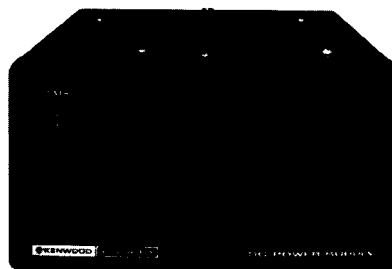

■ SP-40 MOBILE SPEAKER

Specifically designed for mobile operation to provide low distortion and high efficiency. Matches any car interior.



6. ADDITIONAL INFORMATION

■ GENERAL INFORMATION

Your TW-4000A has been factory aligned and tested to specification before shipment. Under normal circumstances, the transceiver will operate in accordance with these operating instructions.

If your transceiver fails to work, contact the authorized dealer from which you purchased it for quick, reliable repair. All adjustable trimmers and coils in your transceiver were preset at the factory and should only be readjusted by a qualified technician with proper test equipment.

Attempting service or alignment without factory authorization.

■ HOW THE TX FINAL MODULE ARE PROTECTED

Final module protection is provided by sampling the reflected power. As the reflected power is increased (higher SWR) transmitter drive is reduced, thus decreasing input to the final module. This in turn reduces collector loss, protecting the final transistor.

■ BATTERY PRECAUTION

When charging your vehicle battery, or when jumpstarting a dead battery, ALWAYS disconnect the power cable from the back of the transceiver.

■ ORDERING SPARE PARTS

When ordering replacement or spare parts for your equipment, be sure to specify the following:

- Model and serial number of your transceiver. Schematic number of the part. Printed circuit board number on which the part is located. Part number and name, if known, and quantity desired.

Note:

A full service manual is available as a separate publication.

■ SERVICE

Should it ever become necessary to return the equipment for repair, pack in its original box and packing, and include a full description of the problems involved. Also include your telephone number. You need not return accessory items unless directly related to the service problem. Tag all returned items with your call for identification.

Please mention the model and serial number of your radio in any correspondence, whether phone or written. For future reference, record this information in the space provided on the back cover of this manual.

Note:

When claiming warranty service, please include a photocopy of the bill of sale, or other proof of purchase showing the date of sale.

7. BLOCK DIAGRAM

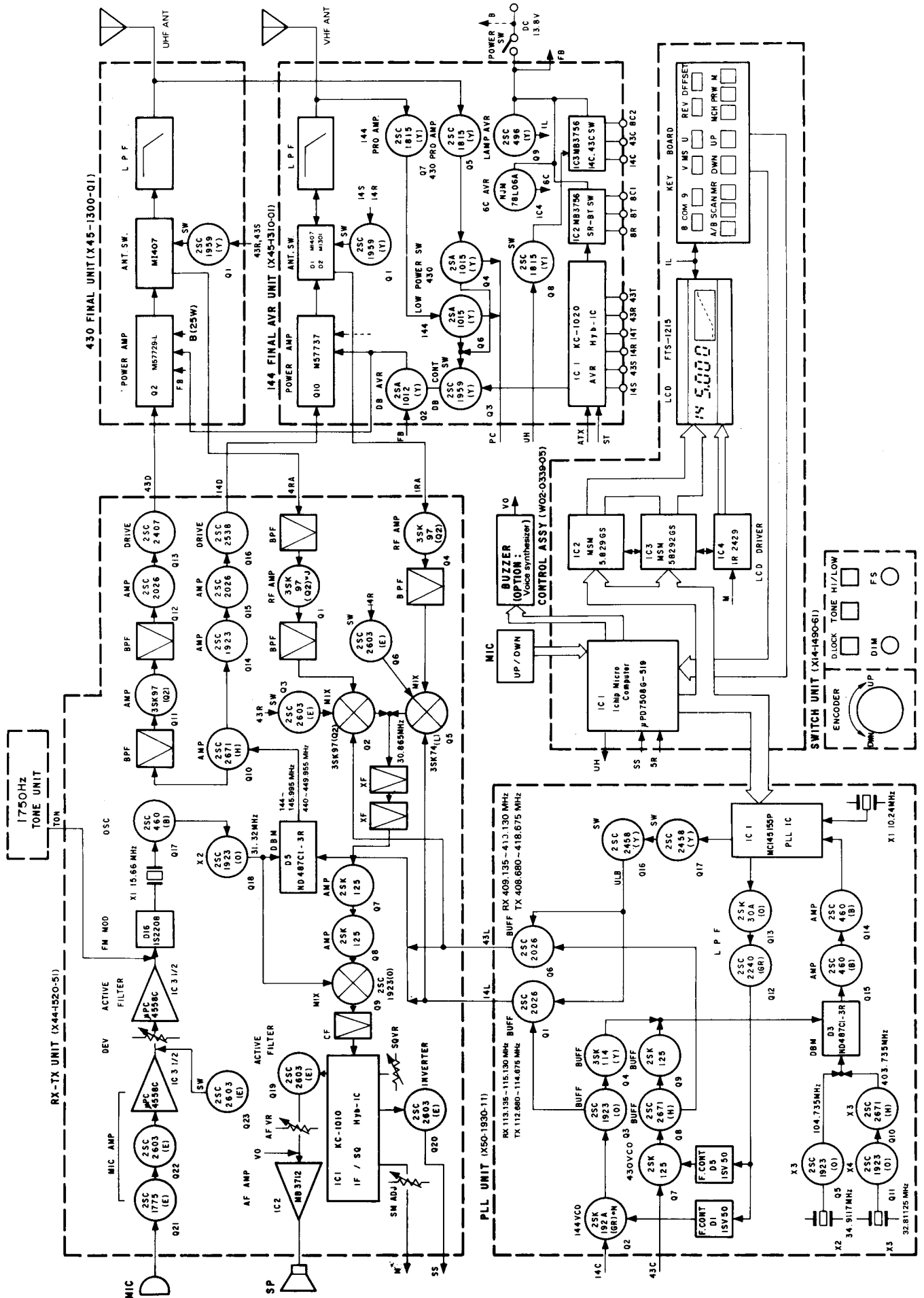

8. SPECIFICATIONS

[General]

Semiconductors	MPU	1
	ICs	18
	Transistors	44
	FETs	12
	Diodes	62
Frequency range	VHF	144.0 to 146.0 MHz
	UHF	430.0 to 440.0 MHz
Mode	FM	(F3)
Antenna impedance	50 ohms (Both VHF and UHF)	
Power requirement	13.8V DC \pm 15%	
Grounding	Negative	
Operating temperature	-20°C to +50°C	
External speaker impedance	8 ohms	
Current drain	0.6 A in receive mode with no input signal	
	Max. 7.5 A in HI transmit mode	
	3.3 A in LOW transmit mode (Approx.)	
	2 μ A for back up	
Dimensions	161 mm (6.3") wide	
	60 mm (2.7") high	
	217 mm (8.5") deep	
	(projections not included)	
Weight	2.0kg (4.18lbs)	

[Transmitter]

RF output power (at 13.8V DC, 50 Ω load)	HI	25 Watts min. (2 m/70 cm)
	Low	5 Watts approx. (adjustable up to about 10 W)
Modulation	Reactance	
Frequency tolerance (-10°C ~ +50°C)	Less than $\pm 15 \times 10^{-6}$	
Spurious radiation	Less than -60 dB	
Maximum frequency deviation (FM)	± 5 kHz	
Audio distortion	3% max. (300 Hz ~ 3.000 Hz)	

[Receiver]

Circuitry	Double superheterodyne	
Intermediate frequency	1st	30.865 MHz
	2nd	455 kHz
Receiver sensitivity	SINAD 12 dB less than 0.17 μ V	
	S+N/N more than 50 dB at 1 mV input	
Receiver selectivity	More than 14 kHz (-6 dB)	
	Less than 28kHz (-60 dB)	
Spurious response	Better than 70dB (without IF/2)	
Squelch sensitivity	Less than 0.1 μ V (threshold)	
Auto scan stop level	Less than 0.16 μ V (threshold)	
Audio output	More than 2.0 watts across 8 ohms load (10% dist.)	

[Microphone supplied]

Semiconductors	Diodes	4
Impedance	500 ohms	

Note: Circuit and ratings are subject to change without notice due to developments in technology.



Model TW-4000A

Serial No. 6016935

Date of Purchase 12.09.1986

Dealer _____

Kenwood Radio
Company Ltd.
1-1-1, Nishi-Shinjyuku
Tokyo 163-0292, Japan

TRIO-KENWOOD CORPORATION

Shionogi Shibuya Building, 17-5, 2-chome Shibuya, Shibuya-ku, Tokyo 150, Japan

TRIO-KENWOOD COMMUNICATIONS

1111 West Walnut Street, Compton, California 90220, U.S.A.

TRIO-KENWOOD COMMUNICATIONS

DIVISION OF TRIO-KENWOOD ELECTRONICS GmbH

Rembrücker Str. 15, 6056 Heusenstamm, West Germany

TRIO-KENWOOD ELECTRONICS, N.V.

Leuvensesteenweg 504, B-1930 Zaventem Belgium

TRIO-KENWOOD (AUSTRALIA) PTY. LTD. (INCORPORATED IN N.S.W.)

4E. Woodcock Place, Lane Cove, N.S.W. 2066, Australia

VS-1

Voice Synthesizer Unit

ACCESSORIES

Screws	4
Instructions	1

For installation to the transceiver TS-670, TS-711 series, TS-811 series and TS-940S, refer to the corresponding instruction manual.

INSTALLATION FOR TW-4000A

Before proceeding, disconnect power.

TW-4000A top cover removal

1. Remove four screws securing the cover.
2. Slide the cover about 1 inch to the rear (as shown), and lift off.

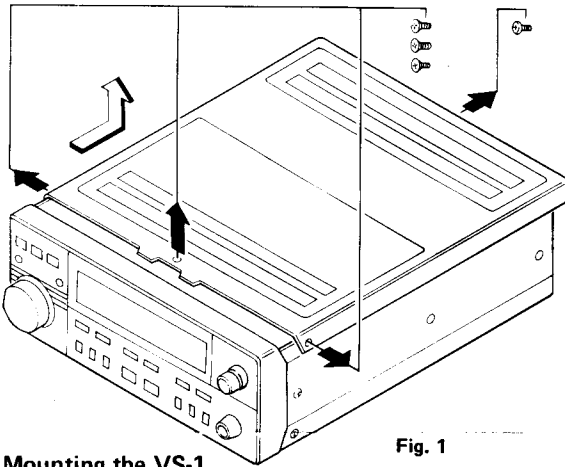

Fig. 1

Mounting the VS-1

1. Unplug the 3-pin and 2-pin connectors (two 3-pin connectors for Europe and England) and the 8-pin connector from the beeper unit.

Note: Unplug by grasping the connector.

2. Remove two screws securing the beeper unit, and remove the unit.
3. Mount the VS-1 with four screws as shown in Fig.3. Be sure not to pinch any wires between the chassis and the subassembly.
4. If two connectors are both 3-pin connectors, plug each connector corresponding to color indicated in Fig. 3.

For unit with 2-pin and 3-pin connectors, simply replace the connectors in their original sockets.

Plug the blue connector into the blue pin jack and the white connector into the white pin jack.

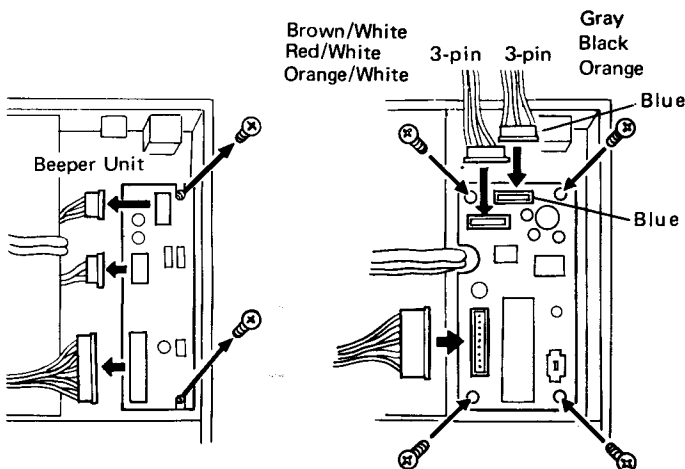

Fig. 2

Fig. 3

VS-1 unit ON-OFF switch.

1. Remove four screws securing the TW-4000A bottom cover.
2. Slide the cover about 1 inch to the rear, and swing forward as shown in Fig. 4
3. Use a diagonal cutter to cut the jumper wire as shown.
4. For VS-1 operation, refer to the TW-4000A instruction manual.

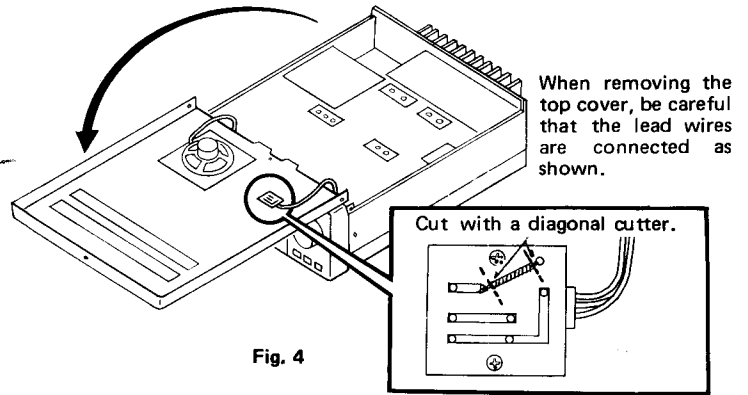

Fig. 4

Voice output level adjustment (VR1)

The VS-1 voice output level is adjusted at the factory. This level can be readjusted with VR1. (See Fig. 5)

Language selector switch (S1)

Either English or Japanese language can be selected with switch S1.

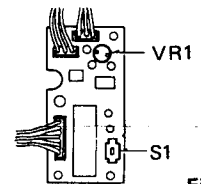

Fig. 5

Talk speed adjustment

By jumping 1, 2 or 3, two different talk speeds are available. With no jumper wire connected, talk speed is set at "Standard". When changing speed, solder carefully.

VS-1 unit ON-OFF operation

The VS-1 can be turned ON and OFF with the switch on the TW-4000A bottom cover. With the switch OFF, the beeper still functions and "power on" is announced when power is turned on.

Notes:

1. Talk speed is factory set. However, this can be reset by moving a jumper wire. See the TW-4000A instruction manual.
2. Because the beeper function has priority over other functions, the Voice Synthesizer does not function while the beeper is in operation.
3. When the Voice is in operation, another operation may interrupt the voice announcement.

TRIO-KENWOOD CORPORATION

Shionogi Shibuya Building, 17-5, 2-chome Shibuya, Shibuya-ku, Tokyo 150, Japan

TRIO-KENWOOD COMMUNICATIONS
1111 West Walnut Street, Compton, California 90220, U.S.A.

TRIO-KENWOOD COMMUNICATIONS
DIVISION OF TRIO-KENWOOD ELECTRONICS GmbH
Rembrücker Str. 15, 6056 Heusenstamm, West Germany

TRIO-KENWOOD ELECTRONICS, N.V.
Leuvensesteenweg 504, B-1930 Zaventem Belgium

TRIO-KENWOOD (AUSTRALIA) PTY. LTD. (INCORPORATED IN N.S.W.)
4E, Woodcock Place, Lane Cove, N.S.W. 2066, Australia