

# KENWOOD

# INSTRUCTION MANUAL

INTERACTIVE VISUAL COMMUNICATOR  
VC-H1

KENWOOD CORPORATION

© B62-0974-10 (K)  
09 08 07 06 05 04 03 02 01



## NOTICES TO THE USER

One or more of the following statements may be applicable:

### **FCC WARNING**

*This equipment generates or uses radio frequency energy. Changes or modifications to this equipment may cause harmful interference unless the modifications are expressly approved in the instruction manual. The user could lose the authority to operate this equipment if an unauthorized change or modification is made.*

### **INFORMATION TO THE DIGITAL DEVICE USER REQUIRED BY THE FCC**

*This equipment has been tested and found to comply with the limits for a Class B digital device, pursuant to Part 15 of the FCC Rules. These limits are designed to provide reasonable protection against harmful interference in a residential installation.*

*This equipment generates, uses and can generate radio frequency energy and, if not installed and used in accordance with the instructions, may cause harmful interference to radio communications. However, there is no guarantee that the interference will not occur in a particular installation. If this equipment does cause harmful interference to radio or television reception, which can be determined by turning the equipment off and on, the user is encouraged to try to correct the interference by one or more of the following measures:*

- *Reorient or relocate the receiving antenna.*
- *Increase the separation between the equipment and receiver.*
- *Connect the equipment to an outlet on a circuit different from that to which the receiver is connected.*
- *Consult the dealer for technical assistance.*

## THANK YOU!

Thank you very much for purchasing this Interactive Visual Communicator. It was designed for plug-and-play color slow-scan television (SSTV). This portable unit includes a slow-scan converter, CCD camera, and LCD monitor. You can enjoy SSTV anywhere just by making a single connection with your amateur radio.

**KENWOOD** believes that this product will provide more fun in your outdoor ham activities.

## FEATURES

This Communicator has the following main features:

- Includes all equipment required for SSTV; a slow-scan converter, CCD color camera, and LCD color monitor.
- Can store up to 10 images in memory. You may select the best image to send, from those images.
- Functions as a speaker microphone of a handy transceiver.
- Compatible with 8 popular SSTV modes besides the newly developed Fast FM mode.
- Equipped with a video input terminal to take in images from a digital camera or 8 mm VTR.

## SUPPLIED ACCESSORIES

Check that everything listed below is included in your package.

| Accessory          | Part Number | Quantity |
|--------------------|-------------|----------|
| Connection cable   | E30-3301-XX | 1        |
| AC adapter         | W08-0559-XX | 1        |
| Strap              | J69-0344-XX | 1        |
| Cloth              | W01-0439-XX | 1        |
| Warranty card      | —           | 1        |
| Instruction manual | B62-0974-XX | 1        |

# CONTENTS

|  |           |   |           |
|--|-----------|---|-----------|
| PRECAUTIONS .....                          | 1         | BATTERY SAVER .....                               | 11        |
| CONVENTIONS FOLLOWED IN THIS MANUAL .....  | 1         | SUPERIMPOSING A CALL SIGN .....                   | 12        |
| <b>GETTING ACQUAINTED</b> .....            | <b>2</b>  | AUTO TRANSMIT .....                               | 13        |
| ORIENTATION .....                          | 2         | AF MUTING .....                                   | 13        |
| CONNECTOR DESCRIPTIONS .....               | 2         | DISPLAY CONTRAST CHANGE .....                     | 13        |
| <b>PREPARATION</b> .....                   | <b>3</b>  | <b>MAINTENANCE</b> .....                          | <b>14</b> |
| INSTALLING ALKALINE BATTERIES .....        | 3         | GENERAL INFORMATION .....                         | 14        |
| ATTACHING THE STRAP .....                  | 4         | SERVICE .....                                     | 14        |
| CONNECTING THE AC ADAPTER .....            | 4         | SERVICE NOTE .....                                | 14        |
| CONNECTION WITH A HANDY TRANSCEIVER .....  | 5         | CLEANING .....                                    | 14        |
| REMOVING/ REINSTALLING THE CAMERA UNIT ... | 5         | TROUBLESHOOTING .....                             | 15        |
| <b>QUICK USE</b> .....                     | <b>6</b>  | <b>APPENDIX</b> .....                             | <b>16</b> |
| <b>OPERATING BASICS</b> .....              | <b>7</b>  | VC-H1 DATA PORT PIN FUNCTIONS .....               | 16        |
| SWITCHING POWER ON/OFF .....               | 7         | CONNECTION DIAGRAM WITH TS-570<br>OR TS-870 ..... | 16        |
| SELECTING A SSTV MODE .....                | 7         | COMPUTER CONTROL .....                            | 17        |
| CAPTURING IMAGES .....                     | 8         | <b>SPECIFICATIONS</b> .....                       | <b>19</b> |
| TRANSMITTING IMAGES .....                  | 9         |   |           |
| RECEIVING IMAGES .....                     | 10        |   |           |
| <b>AUXILIARY FUNCTIONS</b> .....           | <b>11</b> |   |           |
| MEMORY PROTECTION .....                    | 11        |   |           |
| MEMORY RESET .....                         | 11        |   |           |

## PRECAUTIONS

Please observe the following precautions to prevent fire, personal injury, or product damage:

- Never open this product. You will get an electric shock if you touch the circuit on which high voltage is applied.
- Do not install batteries in a hazardous environment where sparks could cause an explosion.
- Never discard old batteries in fire because extremely high temperatures can cause batteries to explode.
- Do not modify this product unless instructed by **KENWOOD** documentation.
- Do not apply excessive force to the monitor display.
- Do not expose this product to long periods of direct sunlight nor place it close to heating appliances.
- Do not place this product in excessively dusty areas, humid areas, wet areas, nor on unstable surfaces.
- If an abnormal odor or smoke is detected coming from this product, turn OFF the power immediately and remove the batteries from the product. When using AC power, also remove the AC adapter from an AC outlet. Contact your authorized **KENWOOD** dealer, customer service, or service station.

## CONVENTIONS FOLLOWED IN THIS MANUAL

The writing conventions described below have been followed to simplify instructions and avoid unnecessary repetition.

| Instruction                            | What to Do  |
|--|---|
| Press <b>[KEY]</b> .                   | Press and release <b>KEY</b> .  |
| Press <b>[KEY1]+[KEY2]</b> .           | Press and hold <b>KEY1</b> , then press <b>KEY2</b> .   |
| Press <b>[KEY]+ POWER ON</b> .         | With VC-H1 power OFF, press and hold <b>KEY</b> , then slide the <b>PWR</b> switch upward.                  |
| Press <b>[KEY1]+[KEY2]+ POWER ON</b> . | With VC-H1 power OFF, press and hold <b>KEY1</b> and <b>KEY2</b> , then slide the <b>PWR</b> switch upward. |

**Note:** Pressing the same key again immediately after pressing **[KEY]+ POWER ON** causes the setting to be changed back.

# GETTING ACQUAINTED

## ORIENTATION

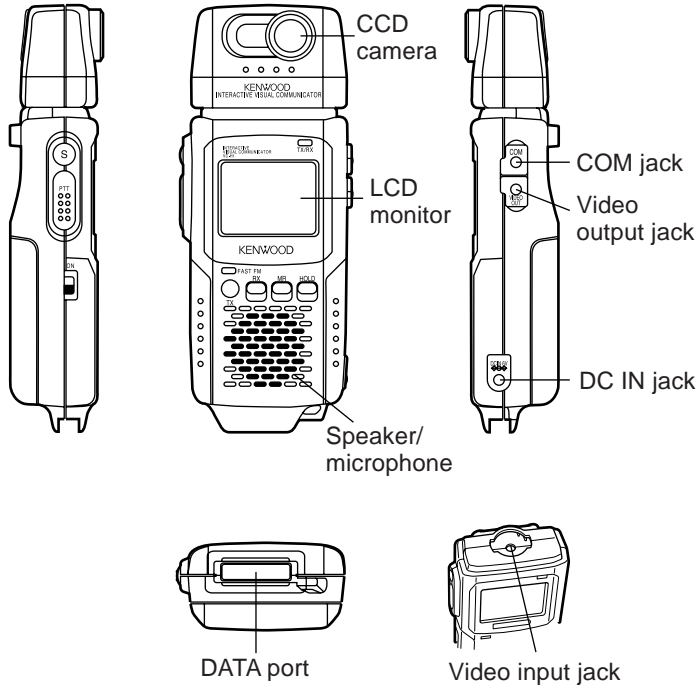

## CONNECTOR DESCRIPTIONS

### ① Video input jack

This jack accepts a 3.5 mm (1/8") diameter, 3-conductor plug. You may connect a digital camera or 8 mm VTR to take in images (acceptable video signals: 75  $\Omega$ , 1 V<sub>P-P</sub> (140 IRE)  $\pm$ 15%, NTSC).

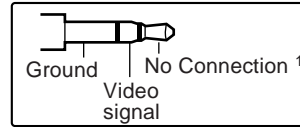

<sup>1</sup> When connecting a device other than the provided camera unit, using this conductor could cause the device to be damaged.

### ② COM jack

Connect a personal computer in which a dedicated program has been installed. For details, contact your authorized **KENWOOD** dealer, customer service, or service center.

### ③ Video output jack

Connect an external monitor, if you prefer. This jack accepts a 2.5 mm (1/10") diameter, 2-conductor plug.

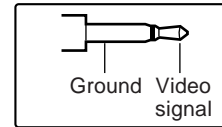

### ④ DC IN jack

Connect the provided AC adapter to use power supplied from an AC outlet.

### ⑤ DATA port

Connect your transceiver. See page 5.

# PREPARATION

## INSTALLING ALKALINE BATTERIES

### WARNING!

- ◆ DO NOT INSTALL THE BATTERIES IN A HAZARDOUS ENVIRONMENT WHERE SPARKS COULD CAUSE AN EXPLOSION.
- ◆ NEVER DISCARD OLD BATTERIES IN FIRE BECAUSE EXTREMELY HIGH TEMPERATURES CAN CAUSE BATTERIES TO EXPLODE.

- 1 To remove the battery cover, slide the cover outward while slightly pushing on the grooves on the cover.

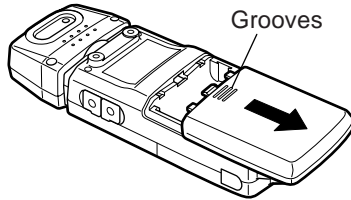

- 2 Insert four AA (LR6) alkaline batteries.

- Be sure to match the battery polarities with those marked on the VC-H1.

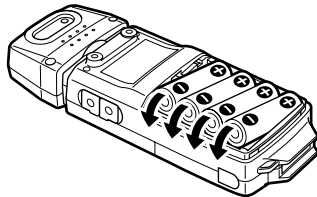

- 3 Align the three tabs on the battery cover, then slide the cover inward until the center tab clicks.

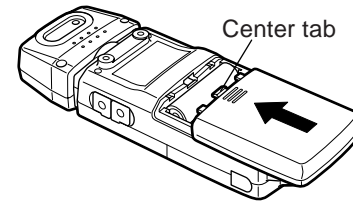

### Note:

- ◆ It is strongly recommended to use high quality alkaline batteries rather than manganese batteries, to enjoy longer periods of battery life. Do not use commercially available NiCd batteries.
- ◆ If you will not use the VC-H1 for a long period, remove the batteries from the VC-H1.
- ◆ Do not use different kinds of batteries together.
- ◆ When the battery voltage is low, replace all four old batteries with new ones.

The approximate lives of alkaline batteries depending on the operation status are shown below:

|                              |            |
|------------------------------|------------|
| Camera ON                    | 50 minutes |
| Monitor ON (memory recalled) | 2 hours    |
| Monitor OFF                  | 6 hours    |

When the batteries become almost empty while the TX/RX indicator is green, the indicator starts blinking. Replace the batteries at that time. This function, however, does not operate while Fast FM mode is currently selected.

## ATTACHING THE STRAP

If you want, attach the provided strap to the bottom of the VC-H1. The strap can be used to hang the VC-H1 around your neck.

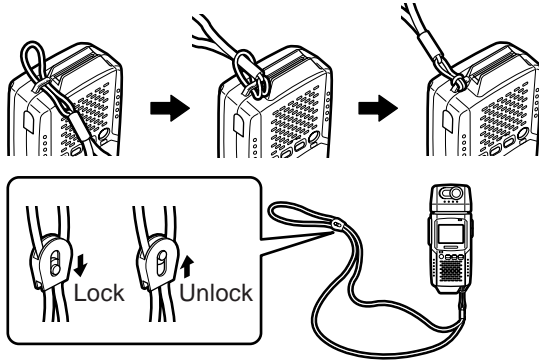

## CONNECTING THE AC ADAPTER

Use the provided AC adapter to connect the VC-H1 to an AC outlet if you want to use AC power.

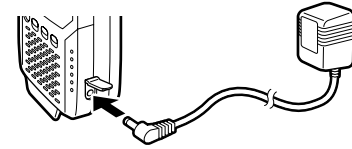

### **WARNING!**

- ◆ *USING AN AC ADAPTER OTHER THAN THE PROVIDED ADAPTER CAN CAUSE FIRE OR PRODUCT DAMAGE.*
- ◆ *DO NOT USE AN EXTENSION CABLE UNLESS ABSOLUTELY NECESSARY. IMPROPER EXTENSION CABLES CAN CAUSE FIRE OR ELECTRIC SHOCK.*

**Note:** *The provided AC adapter does not function as a battery charger.*



## CONNECTION WITH A HANDY TRANSCEIVER

Use the provided cable to connect the VC-H1 with a handy transceiver.

**Note:** The VC-H1 functions as a speaker microphone only when connected with a handy transceiver. You need not switch ON the VC-H1.

- 1 Confirm that the power switches of both the VC-H1 and transceiver are OFF.
- 2 Connect the appropriate end of the provided cable to the DATA port of the VC-H1.
  - To remove the cable from the VC-H1, pull the cable connector downward while pushing its tabs from both sides.

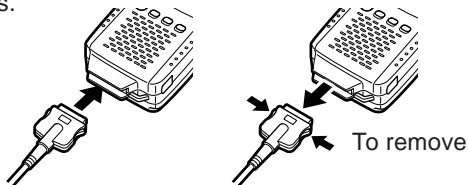

- 3 Connect the other end of the cable to the speaker/microphone jacks on your handy transceiver.

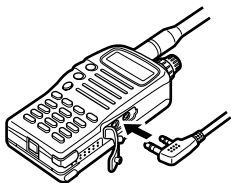

**Note:** The compatible handy transceivers are TH-26, TH-46, TH-27, TH-47, TH-28, TH-48, TH-22, TH-42, TH-77, TH-78, TH-79, and TH-G71. An optional PG-4T cable is available for connecting with a TM-255, TM-455, TM-733, TM-V7, or TM-G707 transceiver. To make a cable for connecting with a TS-570 or TS-870 transceiver, you may obtain an optional connector kit (E59-0407-08) which mates with the VC-H1 DATA port. For the above options, contact your authorized **KENWOOD** dealer, customer service, or service center.

## REMOVING/ REINSTALLING THE CAMERA UNIT

**Note:** Turn OFF the power to the VC-H1 before removing or reinstalling the camera unit.

To remove the camera unit, first turn it so that it crosses at right angles with the main unit.

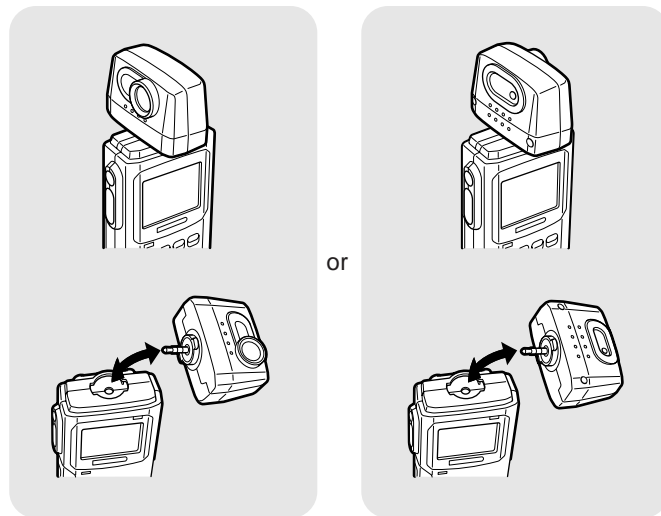

To reinstall the camera unit, first position the port on the camera unit over the port on the main unit so that the two units cross at right angles.

**Note:** The camera unit has a structure that allows the plug assembly to be slightly moved. This is aimed at absorbing stress to be caused when the camera unit is turned.

## QUICK USE

If you have a handy transceiver, the steps given here will allow you to try SSTV with your friend right away.

**Note:** To correctly receive or transmit images, you and your friend have to select the same SSTV mode. If you prefer using a mode other than Robot (color) 36 which is the factory default, see "SELECTING A SSTV MODE" (page 7) and "RECEIVING IMAGES" (page 10).

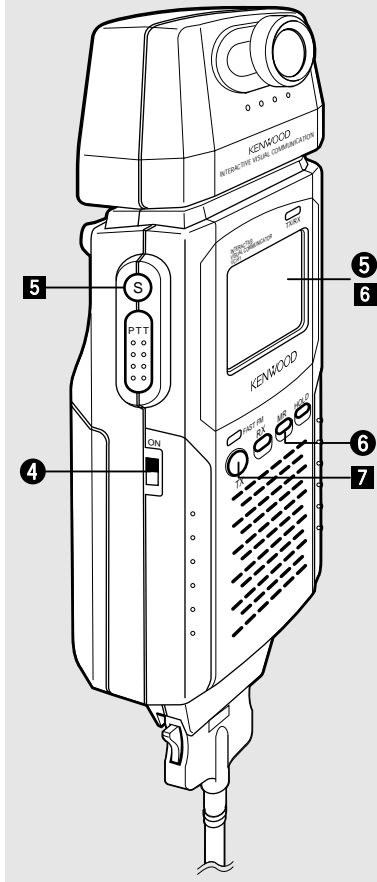

- 1 Confirm that the VC-H1 has been correctly connected with the transceiver (page 5).

On the transceiver:

- 2 Turn ON the power to the transceiver.
- 3 Select the same frequency as the other party.

On the VC-H1:

- 4 Slide the **PWR** switch upward to turn the power ON.
  - The TX/RX indicator lights green.

To receive and store an image in memory:

- 5 When an image signal is received, the image is displayed on the monitor.
  - The TX/RX indicator lights orange while an image is being received.
  - If the TX/RX indicator is green even when the monitor is deactivated by the Battery Saver (page 11), the VC-H1 can receive an image.
- 6 To store the received image in memory, press **[MR]**.

To transmit an image:

- 5 Press **[S]** to activate both the camera and LCD monitor.
  - The TX/RX indicator goes out.
- 6 While looking at the LCD monitor, turn and focus the camera onto an object.
- 7 Press **[TX]** to capture and transmit the image.
  - You need not press the PTT switch.
  - The TX/RX indicator lights red during transmission.
  - A horizontal line appears and slowly moves downward to show the progress of transmission.

# OPERATING BASICS

## SWITCHING POWER ON/OFF

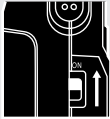

- 1 Slide the **PWR** switch upward to turn the power ON.
  - The TX/RX indicator lights green.



- 2 To turn the power OFF, slide the **PWR** switch downward.

## SELECTING A SSTV MODE

To correctly transmit or receive images, you and the other party have to select the same SSTV mode. So first consult with your party about the mode to be used. You can select either Robot (color) 36 or Fast FM; the factory default is Robot (color) 36.

**Note:** *The Fast FM mode is available only when using a TM-255, TM-455, TM-733, TM-V7, or TM-G707 transceiver; 9600 bps must be selected on the transceiver as the data transfer rate. For details, contact your authorized **KENWOOD** dealer, customer service, or service center. In Fast FM mode, the VC-H1 does not output audio from the speaker while receiving an image, and does not function as a speaker microphone.*

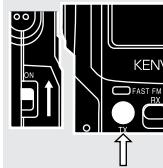

Press **[TX]+ POWER ON** to switch the mode.

- The FAST FM indicator shows which mode is selected.
  - Lights red: Fast FM
  - Goes out: Robot (color) 36

The VC-H1 is also compatible with the following modes. See “RECEIVING IMAGES” {page 10} and “COMPUTER CONTROL” {page 17}.

- Robot (color) 72
- AVT 94
- Scottie S2
- Martin M2
- AVT 90
- Scottie S1
- Martin M1

## CAPTURING IMAGES

The VC-H1 has 10 memory channels to store captured images.



- 1 Slide the **PWR** switch upward to turn the power ON.
  - The TX/RX indicator lights green.



- 2 Press **[S]** to activate both the camera and LCD monitor.
  - The TX/RX indicator goes out.

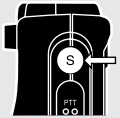

- 3 While looking at the LCD monitor, turn and focus the camera onto an object.
- 4 Press **[S]** again to capture the image.
  - When capturing is completed, the camera is deactivated and the TX/RX indicator lights green again.

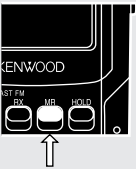

- 5 Press **[MR]** to store the captured image in a memory channel.
  - You may skip this step if you do not store the image.

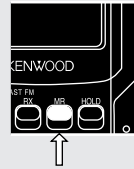

- 6 Repeat step 2 to 5 to capture and store a maximum of 10 desired images.
  - When all channels are full, the currently selected channel is overwritten with a newly captured image.
- 7 To confirm the stored images, press **[MR]**.
  - The currently selected channel number appears at the top right of the monitor.



- Each press of **[MR]** increments the channel number.

### Note:

- ◆ While capturing images, the VC-H1 does not receive images sent from other parties.
- ◆ If no operation is performed for approximately 30 seconds with Battery Saver ON (page 11), the camera and monitor are deactivated; the default is ON.
- ◆ Pressing **[S]** again immediately after activating the camera and monitor may cause the captured image to be distorted; the camera is not yet ready for image capture.
- ◆ The VC-H1 does not allow you to specify an individual image to be erased. To erase unnecessary images, use one of the following methods:
  - Perform Memory Reset to erase all images at one time (page 11).
  - When all channels are full, recall the unnecessary image, capture a new image, then press **[MR]**.

## TRANSMITTING IMAGES

When an appropriate SSTV mode and a desired image is selected, the VC-H1 is ready to transmit images.

**Note:** AF Mute must be switched OFF (page 13) to transmit an image using Fast FM mode; the default is ON.

- 1 Confirm that the VC-H1 has been correctly connected with the transceiver (page 5).

On the transceiver:

- 2 Turn ON the power to the transceiver.
- 3 Select the same frequency as the other party.

On the VC-H1:

- 4 Slide the **PWR** switch upward to turn the power ON.
  - The TX/RX indicator lights green.
- 5 Press **[MR]** to recall an image to be transmitted.
  - The currently selected channel number appears at the top right of the monitor.
  - Each press of **[MR]** increments the channel number.

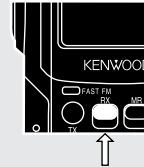
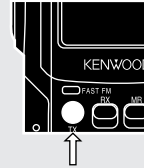
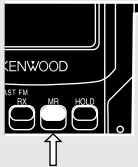

- You may just look at the LCD monitor and focus the camera onto an object instead of recalling an image; you need not press **[S]** to capture an image.

### 6 Press **[TX]** to transmit the image.

- You need not press the **PTT** switch.
- The TX/RX indicator lights red during transmission.
- A horizontal line appears and slowly moves downward to show the progress of transmission.
- To interrupt transmission, press **[RX]**.

### **Note:**

- ◆ While transmitting, do not place the VC-H1 and the connection cable close to the transceiver antenna. The image on the monitor may be distorted or erased.
- ◆ The VC-H1 cannot receive images while transmitting.
- ◆ If no operation is performed for approximately 30 seconds after transmission, with Battery Saver ON (page 11), the monitor is deactivated; the default is ON.
- ◆ If you press **[RX]** after recalling an image, Battery Saver (page 11) deactivates the monitor.

## RECEIVING IMAGES

When the VC-H1 receives an image signal, it automatically identifies and sets the appropriate SSTV mode. The compatible modes are listed below:

- Robot (color) 36
- AVT 90
- Scottie S1
- Martin M1
- Fast FM
- Robot (color) 72
- AVT 94
- Scottie S2
- Martin M2

**Note:** AF Mute must be switched OFF {page 13} to receive an image transmitted using Fast FM mode; the default is ON.

- 1 Confirm that the VC-H1 has been correctly connected with the transceiver {page 5}.

On the transceiver:

- 2 Turn ON the power to the transceiver.
- 3 Select the same frequency as the other party.
- 4 Adjust the volume control to a medium level.

On the VC-H1:

- 5 Slide the **PWR** switch upward to turn the power ON.
  - The TX/RX indicator lights green.
- 6 Tell the other party that you are ready to receive an image.



- 7 When an image signal is received, the image is displayed on the monitor.

- The TX/RX indicator lights orange while an image is being received.
- If the TX/RX indicator is green even when the monitor is deactivated by the Battery Saver {page 11}, the VC-H1 can receive an image.

- 8 To store the received image in an empty memory channel, press **[MR]**.

- If the size of the received image is too large to be stored in one channel, the next channel is also used.
- When all channels are full, the currently selected channel is overwritten with a received image.

### Note:

- ◆ When you fail to receive the first portion of an image signal in a mode other than AVT 90, AVT 94, and Fast FM, pressing **[RX]** allows you to receive the remaining portion. However, because of possible insufficient synchronization, the VC-H1 could show an inappropriate color of an image, or fail to receive an image even if the TX/RX indicator lights orange.
- ◆ The automatically identified SSTV mode is used for your next transmission unless the mode is manually changed. If the identified mode is neither Robot (color) 36 nor Fast FM, switching OFF the VC-H1 causes it to restore the previously selected mode; Robot (color) 36 or Fast FM.
- ◆ If using a handy transceiver, switch OFF Battery Saver. When Battery Saver is ON, the transceiver may fail to receive an image.
- ◆ If using a TH-G71 transceiver, increasing the audio volume beyond a certain amount may cause the transceiver to fail to receive an image. Select the volume in the range shown to the left.

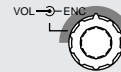
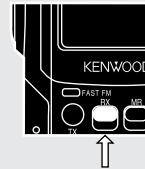
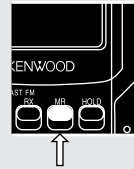

# AUXILIARY FUNCTIONS

## MEMORY PROTECTION

You can protect the captured or received images from being accidentally erased.

- 1 Slide the **PWR** switch upward to turn the power ON.
  - The TX/RX indicator lights green.
- 2 Press **[MR]** to recall the desired image.
  - Each press of **[MR]** increments the channel number.
  - If no operation is performed for approximately 30 seconds with Battery Saver ON, the monitor is deactivated; the default is ON.
- 3 Press **[HOLD]** to switch Protection ON (or OFF).
  - When the channel is protected, its number on the monitor turns red.

**Note:** When the protected memory channel is currently selected, the VC-H1 may still capture or receive an image to display on the monitor. However, the protected channel will not be used to store the newly displayed image.

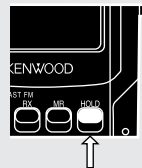
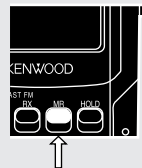

## MEMORY RESET

You may sometimes want to reset all settings back to the factory defaults and clear the memory channels.

Press **[S]+[HOLD]+ POWER ON**.

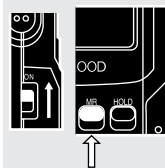
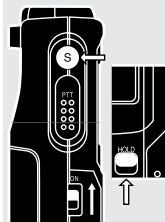

## BATTERY SAVER

If no operation is performed for approximately 30 seconds, Battery Saver automatically turns OFF the power to the camera and monitor units. Pressing **[S]** activates the units again.

To switch Battery Saver ON (default) or OFF, press **[MR]+ POWER ON**.

- “SAVE-ON” or “SAVE-OFF” appears to indicate the new status.
- The TX/RX indicator lights green when Battery Saver deactivates the camera and monitor.
- The VC-H1 can still receive images when Battery Saver is ON.

## SUPERIMPOSING A CALL SIGN

The VC-H1 allows you to superimpose your call sign onto an image to be transmitted. You can enter up to 8 alphanumeric characters.

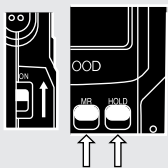

- 1 Press **[MR]+[HOLD]+ POWER ON** to switch the function ON (or OFF).

- A window for entering digits appears when the function is switched ON.

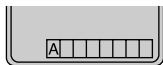

- 2 Press **[TX]** or **[RX]** to select the first digit.

- The selectable characters are "0" to "9", "A" to "Z", and "/".

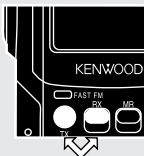

- 3 Press **[MR]** to move to the next digit.

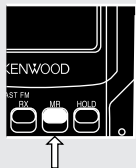

- 4 Repeat step 2 and 3 to enter up to 8 characters.

- After selecting the 8th digit, you need not press **[MR]**.
- To correct the entered digits, start with step 1 again. You cannot correct specific digits individually.

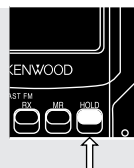

- 5 Press **[HOLD]** to complete the entry.

- When you transmit an image next time, the entered call sign will be superimposed.
- To correct the stored call sign, repeat the procedure which starts with step 1. In step 1, only "A" is shown in the window, whereas the previously entered call sign is still present in memory. You cannot correct specific digits individually.
- After transmitting an image, press **[MR]** to store the call sign in memory with the image, if necessary.

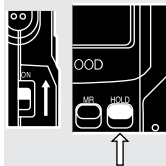
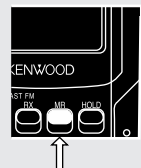

After entering a call sign, you may prefer not superimposing it onto some images. You can also deactivate auto superimposing. Press **[HOLD]+ POWER ON** to activate (default) or deactivate auto superimposing.

- "CALL-ON" or "CALL-OFF" appears to indicate the new status.



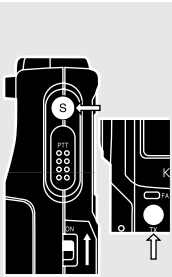

## AUTO TRANSMIT

The VC-H1 is capable of automatically capturing and transmitting images every 3 minutes. Press **[S]+[TX]+ POWER ON** to switch Auto Transmit ON or OFF (default).

- Keep pressing **[S]** and **[TX]** for longer than 2 seconds.
- “A/TX-ON” or “A/TX-OFF” appears to indicate the new status.
- If you have entered a call sign, it will be superimposed onto an image to be transmitted.
- To interrupt transmission, press **[RX]**.

### Note:

- ◆ When in Auto Transmit mode, the VC-H1 does not receive images.
- ◆ When in Auto Transmit mode, you cannot perform key operations other than **[S]+[TX]+ POWER ON** and **[RX]**.

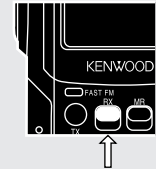

## AF MUTING

You can specify whether the VC-H1 will mute only image signals or both audio and image signals. Press **[RX]+ POWER ON** to switch AF ON (default) or OFF.

- AF ON: Only image signals are muted.
- AF OFF: Both audio and image signals are muted.
- “AF-ON” or “AF-OFF” appears to indicate the new status.

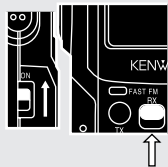

## DISPLAY CONTRAST CHANGE

You may sometimes need to adjust the display contrast on the monitor, depending on the ambient conditions.

### 1 Press **[TX]+[RX]+ POWER ON**.

- “CONTRAST” appears.

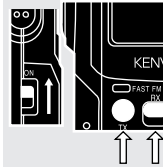

### 2 Press **[TX]** or **[RX]** to change the contrast.

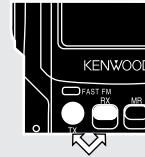

### 3 Press **[MR]** to complete the adjustment.

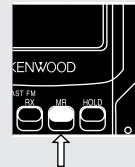

# MAINTENANCE

## GENERAL INFORMATION

This product has been factory aligned and tested to specification before shipment. Attempting service or alignment without factory authorization can void the product warranty.

## SERVICE

When returning this product to your dealer or service center for repair, pack it in its original box and packing material. Include a full description of the problems experienced. Include your telephone number along with your name and address in case the service technician needs to call you; if available, include also your fax number and E-mail address. Don't return accessory items unless you feel they are directly related to the service problem.

You may return this product for service to the authorized **KENWOOD** dealer from whom you purchased it, or any authorized **KENWOOD** service center. Please do not send subassemblies or printed circuit boards. Send the complete product. A copy of the service report will be returned with the product.

## SERVICE NOTE

If you desire to correspond on a technical or operational problem, please make your note short, complete, and to the point. Help us help you by providing the following:

- 1 Model and serial number of equipment
- 2 Question or problem you are having
- 3 Other equipment in your station pertaining to the problem

**CAUTION: DO NOT PACK THE EQUIPMENT IN CRUSHED NEWSPAPERS FOR SHIPMENT! EXTENSIVE DAMAGE MAY RESULT DURING ROUGH HANDLING OR SHIPPING.**

**Note:**

- ◆ Record the date of purchase, serial number and dealer from whom this product was purchased.
- ◆ For your own information, retain a written record of any maintenance performed on this product.
- ◆ When claiming warranty service, please include a photocopy of the bill of sale, or other proof-of-purchase showing the date of sale.

## CLEANING

When the camera lens or monitor display becomes dirty, gently wipe its surface using the provided cloth. Be careful not to apply excessive force to the monitor display; the monitor could be damaged.

To clean the case of this product, use a neutral detergent (no strong chemicals) and a damp cloth.

## TROUBLESHOOTING

The problems described in this table are commonly encountered operational malfunctions and are usually not caused by circuit failure.

| Problem   | Probable Cause  | Corrective Action  | Page Ref. |
|---|---|--|-----------|
| The VC-H1 cannot be switched ON.  | 1 The batteries have not been correctly loaded.   | 1 Load the batteries so that their polarities match those marked on the VC-H1. | 3         |
|   | 2 The batteries became dead.  | 2 Replace the batteries.   | 3         |
|   | 3 An AC adapter other than the provided one has been used.  | 3 Use the AC adapter that came with the VC-H1.                                 | 4         |
|   | 4 Shorting the video input terminal power line with an external element caused the internal fuse to blow. | 4 Contact your <b>KENWOOD</b> dealer, customer service, or service station.    | —         |
| The power to the camera and monitor units are automatically turned OFF.                 | The Battery Saver is ON.  | If necessary, switch OFF the Battery Saver.                                    | 11        |
| The color of a recalled image differs from that of an image shown when [S] was pressed. | The lens was affected by direct light from a light source such as the sun.                                | Be careful not to expose the lens to any direct light.                         | —         |
| An image cannot be transmitted or received.   | 1 The operating frequency selected on the transceiver did not match that of the other party.              | 1 Select the exact same operating frequency as the other party.                | —         |
|   | 2 The selected SSTV mode did not match that of the other party.   | 2 Select the same SSTV mode as the other party.                                | 7         |
|   | 3 The VC-H1 and transceiver have not been correctly connected.  | 3 Check the connections between the VC-H1 and transceiver.                     | 5         |
|   | 4 An interference signal was received.  | 4 Move to another frequency with the other party.                              | —         |
| No audio is output from the VC-H1 speaker.  | AF Mute is OFF.   | Switch AF Mute ON.   | 13        |

# APPENDIX

## VC-H1 DATA PORT PIN FUNCTIONS

| Pin No. | Pin Name | Function                                      |
|---------|----------|---|
| 1       | NC       | No connection                                 |
| 2       | SSDO     | Image data output (not usually used)          |
| 3       | 6V       | +6 V output (not usually used)                |
| 4       | DG       | Digital signal ground                         |
| 5       | TXD      | Serial data transmission                      |
| 6       | RXD      | Serial data reception                         |
| 7       | SSPTT    | Image data PTT                                |
| 8       | FSSDO    | Image data output (Fast FM mode) <sup>1</sup> |
| 9       | SSDI     | Image data input                              |
| 10      | NC       | No connection                                 |
| 11      | PTT      | Audio PTT                                     |
| 12      | 3MS      | +3.5 ~ +6 V input                             |
| 13      | SP       | Audio input (0.5 W/ 8 Ω)                      |
| 14      | MIC      | Microphone input                              |
| 15      | MSP      | Audio input <sup>2</sup>                      |
| 16      | G        | Ground  |

<sup>1</sup> This pin is used for a connection with the DATA connector on a TM-255, TM-455, TM-733, TM-V7, or TM-G707 transceiver.

<sup>2</sup> This pin is used when AF power is over 0.5 W/ 8 Ω.

## CONNECTION DIAGRAM WITH TS-570 OR TS-870

**Note:** Pin 1 of the connector, which mates with the VC-H1 DATA port, can be identified with a triangle mark on the connector. Pin 1 is located just below the mark.

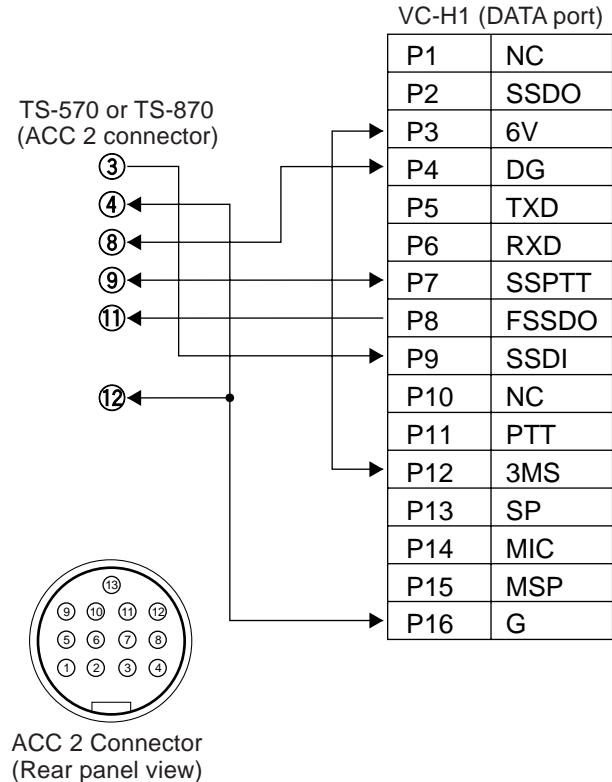

## COMPUTER CONTROL

If the dedicated program is installed, your personal computer can be connected with the COM jack of the VC-H1, then the VC-H1 can be easily controlled via the computer. For details, contact your authorized **KENWOOD** dealer, customer service, or service center.

You can also connect a computer to the DATA port of the VC-H1 in order to control the VC-H1 via the computer. This, however, asks you to manually send ST commands to the VC-H1 through the computer.

**Note:** Pin 1 of the connector, which mates with the VC-H1 DATA port, can be identified with a triangle mark on the connector. Pin 1 is located just below the mark.

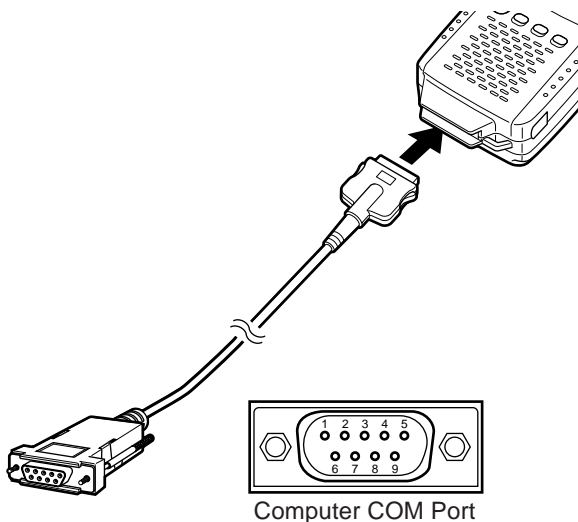

## Computer COM Port Pin Functions (9-Pin Port)

| Pin No. | Pin Name | Function            | To                  |
|---------|----------|---------------------|---------------------|
| ①       | DCD      | No connection       | —                   |
| ②       | RXD      | RX data             | Pin 5 <sup>1</sup>  |
| ③       | TXD      | TX data             | Pin 6 <sup>1</sup>  |
| ④       | DTR      | Data Terminal Ready | DSR <sup>2</sup>    |
| ⑤       | GND      | Signal ground       | Pin 16 <sup>1</sup> |
| ⑥       | DSR      | Data Set Ready      | DTR <sup>2</sup>    |
| ⑦       | RTS      | TX request          | CTS <sup>2</sup>    |
| ⑧       | CTS      | TX enable           | RTS <sup>2</sup>    |
| ⑨       | RI       | No connection       | —                   |

<sup>1</sup> Pins of the DATA port on the VC-H1

<sup>2</sup> No connection with the VC-H1

Use an appropriate communications program to set the following parameters on your personal computer.

- Transfer rate: 9600 bps
- Data length: 8 bit
- Stop bit: 1 bit
- Parity: Non
- Flow control: Non
- Data format: ASCII

## ■ Commands List

| Pin No. | Pin Name | Function  |
|---------|----------|---|
| ①       | STS      | SSTV mode switch/<br>Inquiry of current SSTV mode |
| ②       | STC      | Call sign superimposition                         |
| ③       | STM      | Message superimposition                           |
| ④       | STR      | RSV superimposition                               |
| ⑤       | STP      | Image capture                                     |
| ⑥       | STT      | Image transmission                                |

## ■ Commands Format

**Note:** Use capital letters to enter a command name.

A STS command should consist of a command name, space, parameter, and [CR]; ex. STS□0 [CR].

| Parameter | Function                           | Parameter | Function                |
|-----------|------------------------------------|-----------|-------------------------|
| Non       | Inquiry of<br>current SSTV<br>mode | 4         | Scottie S1 <sup>1</sup> |
| 0         | Robot 36                           | 5         | Scottie S2 <sup>1</sup> |
| 1         | Robot 72                           | 6         | Martin M1 <sup>1</sup>  |
| 2         | AVT 90 <sup>1</sup>                | 7         | Martin M2 <sup>1</sup>  |
| 3         | AVT 94 <sup>1</sup>                | 8         | Fast FM                 |

<sup>1</sup> Compatible

A STC command should consist of a command name, space, call sign, comma, color parameter, and [CR]; ex. STC□JA1YKX, 1 [CR]. You can enter up to 8 characters as a call sign, using “0” to “9”, “A” to “Z”, “/”, “-”, “!”, “?”, or a space. The parameters of call sign colors are listed below:

| Parameter | Function | Parameter | Function   |
|-----------|----------|-----------|------------|
| 0         | black    | 4         | green      |
| 1         | blue     | 5         | light blue |
| 2         | red      | 6         | yellow     |
| 3         | purple   | 7         | white      |

The formats of STM and STR commands are the same as of STC commands except that a message or RSV replaces a call sign; ex. STM□CQ SSTV, 2[CR]. The characters which can be entered are also the same as for STC commands.

- Up to 9 characters can be entered as a message.
- Up to 10 characters can be entered for a RSV.

STP and STT commands consist of a command name and [CR]; ex. STP[CR].

# SPECIFICATIONS

Specifications are subject to change without notice due to developments in technology.

|   |   |                                    |
|---|---|------------------------------------|
| Still picture modulation method                     | SCFM through digital signal processing  |                                    |
| Still picture demodulation method                   | Arc tangent angle change detection through digital signal processing  |                                    |
| Still image mode                                    | Robot (color) 36/<br>Robot (color) 72/ AVT 90 1/<br>AVT 94 1/ Scottie S1 1/<br>Scottie S2 1/ Martin M1 1/<br>Martin M2 1/ Fast FM |                                    |
| Modulation mode (transceiver to be connected with:) | F5  |                                    |
| Microphone  | External bias/ Electret condenser microphone  |                                    |
| Speaker   | 1 W (max.), 16 Ω  |                                    |
| LCD   | 1.8 inch TFT/ color LCD, coated for preventing surface reflection   |                                    |
| Rated voltage                                       | External power input (DC IN)  | 6.0 V DC ±10%                      |
|   | Battery terminals   | 6.0 V DC (4 AA alkaline batteries) |
| Video signal input                                  | 75 Ω, 1 V <sub>p-p</sub> (140 IRE) ±15%, NTSC/ Sub-carrier frequency: within ±200 Hz/ Non DC offset                               |                                    |
| Video signal output                                 | 75 Ω, 1 V <sub>p-p</sub> (140 IRE) ±15%, NTSC   |                                    |

<sup>1</sup> Compatible

|   |                           |  |
|---|---------------------------|--|
| Still picture signal input                        |                           | 50 mV <sub>p-p</sub> ~ 3.0 V <sub>p-p</sub><br>600 Hz ~ 6.8 kHz (Fast FM)<br>1.0 kHz ~ 2.4 kHz (other than Fast FM)          |
| Still picture signal output (level: not variable) | Microphone                | 1 V <sub>p-p</sub> ±20% (Fast FM)<br>50 mV <sub>p-p</sub> ±20% (other than Fast FM)  |
|   | SSDO                      | 50 mV <sub>p-p</sub> ±20%  |
|   | FSSDO                     | 1.5 V <sub>p-p</sub> ±20% (Fast FM only)   |
| Image memory                                      |                           | 1 display buffer (175K bytes, non-compressed)/<br>10 compressed images (max.) conform to JPEG/ Approx. 4 years memory backup |
| Expansion port                                    |                           | 115 kbps, RS232C level computer interface/<br>Asynchronous 8 bit/ 1 stop bit/ No parity/ Non flow control                    |
| Transceiver interface                             |                           | 9600 bps, CMOS level output (TXD)/ RS232C level input (RXD)/ Negative logic input and output                                 |
| Current consumption                               | Image capture in progress | 650 mA (max.)  |
|   | LCD in use                | 450 mA (average)   |
|   | Standby                   | 100 mA (average)   |
| Temperature range                                 | Use                       | 0°C ~ +40°C  |
|   | Storage                   | -20°C ~ +60°C  |

KENWOOD