

User's Guide



Disney · PIXAR: ELECTRONICS

2-WAY FRS RADIO



6881041B05-A



2-Way Radio Quick Reference

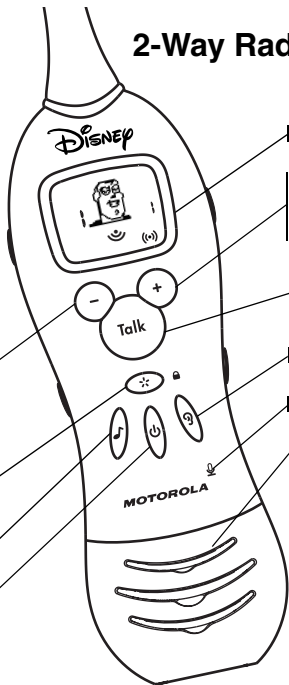

Display

Raise sound

Move up through options for each radio setting

Talk

Save radio settings

Monitor channel activity

Microphone

Speaker

Lower sound

Move down through options for each radio setting

Move through different radio settings

Lock/unlock keypad (when held down in Standby mode)

Send call tone

Turn radio on and off



Changing Radio Settings

Press ***** to move through radio settings.
Press **-** and **+** to move through options for each radio setting.
Press **Talk** to save radio settings.

Call Tone

Settings: 1 through 5



Channel

Settings: 1 through 14



Interference Eliminator Code

Settings: 0 through 38

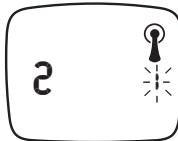

Talk Confirmation Tone

Settings: ☺ (On), ☹ (Off)



Keypress Alert Tone

Settings: ☺ (On), ☹ (Off)

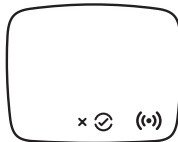

Introduction

Disney Motorola 2-way radios operate on Family Radio Service (FRS) frequencies. This license-free, 2-way radio service is for family and group recreational use. Use of this radio outside the country where it was intended to be distributed is subject to government regulations and may be prohibited. Read this manual carefully and make sure you know how to properly operate radio before use.

For a copy of a large-print version of this guide, or for product-related questions, contact:

1-800-353-2729 U.S.A.

1-800-461-4575 Canada

1-888-390-6456 TTY (Text Telephone)

On the web, refer to: www.motorola.com/talkabout

Congratulations on your purchase of a Motorola 2-way radio!

Product registration is an important step toward enjoying your new Motorola radio. Registering helps us with warranty service, and permits us to contact you should your Motorola 2-way radio require an update or other service. Registration is not required for warranty coverage. To register your product on-line, visit www.motorola.com/warranty/radios.

Retain your original dated sales receipt for your records. For warranty service of your Motorola 2-way radio you will need to provide a copy of your dated sales receipt to confirm warranty status.

Contents

Introduction	17
Safety and General Information	1
Getting Started	9
Turning On Your Radio	9
Sharing Radio Channels	9
Parts of Your Radio	10
What is on Your Display	11
Installing Batteries	12
Talking and Listening	13
Talk Range	13
Making Radio Sound Quieter or Louder ..	14
Sending Call Tones	14
Changing Call Tones	15
Changing Channels	16
Changing Interference Eliminator Code	17
Listening to a Channel	18
Time-Out Timer	18
Locking the Keypad	19
Alerts	20
Talk Confirmation Tone	20
Keypress Alert Tone	21
Fixing Problems	23
Use and Care	25
Limited Warranty	27
FCC License Not Required	34
Software Copyright Notice	34
Export Law Assurances	35

SAFETY AND GENERAL INFORMATION

IMPORTANT INFORMATION ON SAFE AND EFFICIENT OPERATION

READ THIS INFORMATION BEFORE USING YOUR RADIO

The information provided in this document supersedes the general safety information contained in user guides published prior to July 2000.

This device complies with Part 15 of the FCC Rules. Operation is subject to the following two conditions: (1) this device may not cause harmful interference, and (2) this device must accept any interference received, including interference that may cause undesired operation.

Transmit and Receive Procedure

Your two-way radio contains a transmitter and a receiver. To transmit (talk), you must push the Talk button; to receive (listen), release the Talk button.

Exposure To Radio Frequency Energy

Your Motorola radio is designed to comply with the following national and international standards and guidelines regarding exposure of human beings to radio frequency electromagnetic energy:

- United States Federal Communications Commission, Code of Federal Regulations; 47 CFR part 2 sub-part J

- American National Standards Institute (ANSI) / Institute of Electrical and Electronic Engineers (IEEE) C95. 1-1992
- Institute of Electrical and Electronic Engineers (IEEE) C95.1-1999 Edition
- International Commission on Non-Ionizing Radiation Protection (ICNIRP) 1998
- Ministry of Health (Canada) Safety Code 6. Limits of Human Exposure to Radiofrequency Electromagnetic Fields in the Frequency Range from 3 kHz to 300 GHz, 1999
- Australian Communications Authority Radiocommunications (Electromagnetic Radiation - Human Exposure) Standard 2001 (applicable to wireless phones only)
- ANATEL, Brasil Regulatory Authority, Resolution 256 (April 11, 2001) "additional requirements for SMR, cellular and PCS product certification."

To assure optimal radio performance and make sure human exposure to radio frequency electromagnetic energy is within the guidelines set forth in the above standards, always adhere to the following procedures:

PORTABLE RADIO OPERATION AND EME EXPOSURE

Antenna Care

Use only the supplied or an approved replacement antenna. Unauthorized antennas, modifications, or attachments could damage the radio and may violate FCC regulations.

DO NOT hold the antenna when the radio is “IN USE.” Holding the antenna affects call quality and may cause the radio to operate at a higher power level than needed.

Two-way Radio Operation

When using your radio as a traditional two-way radio, **hold the radio in a vertical position with the microphone one to two inches (2.5 to 5 cm) away from the lips.**

Body-worn Operation

To maintain compliance with FCC/Health Canada RF exposure guidelines, if you wear a radio on your body when transmitting, always place the radio in a Motorola supplied or approved clip, holder, holster, case, or body harness for this product. Use of non-Motorola-approved accessories may exceed FCC/Health Canada RF exposure guidelines. If you do not use one of the Motorola-supplied or approved body-worn accessories, and are not using the radio held in the normal use position, **ensure the radio and its antenna are at least one inch (2.5 cm) away from your body when transmitting.**

To control your exposure and ensure compliance with the general population/uncontrolled environment exposure limits, always adhere to the following procedure:

- Transmit no more than 50% of the time.
- To transmit (talk), push the Talk button.
- To receive calls, release the Talk button.

Transmitting 50% of the time, or less, is important because the radio generates measurable RF energy exposure only when transmitting (in terms of measuring standards compliance).

Data Operation

If applicable, when using any data feature of the radio, with or without an accessory cable, **position the radio and its antenna at least one inch (2.5 cm) away from the body.**

Approved Accessories

For a list of approved Motorola accessories visit our website at www.mot.com.

ELECTROMAGNETIC INTERFERENCE/COMPATIBILITY

Note: Nearly every electronic device is susceptible to electromagnetic interference (EMI) if inadequately shielded, designed or otherwise configured for electromagnetic compatibility.

- **FACILITIES**

To avoid electromagnetic interference and/or compatibility conflicts, turn off your radio in any facility where posted notices instruct you to do so. Hospitals or health care facilities may be using equipment that is sensitive to external RF energy.

- **AIRCRAFT**

When instructed to do so, turn off your radio when on board an aircraft. Any use of a radio must be in accordance with applicable regulations per airline crew instructions.

- **MEDICAL DEVICES**

Pacemakers

The Advanced Medical Technology Association recommends that a minimum separation of 6 inches (15 centimeters) be maintained between a handheld wireless radio and a pacemaker. These recommendations are consistent with the independent research by, and recommendations of, the United States Food and Drug Administration.

Persons with pacemakers should:

- ALWAYS keep the radio more than six inches (15 centimeters) from their pacemaker when the radio is turned ON.
- not carry the radio in the breast pocket.
- use the ear opposite the pacemaker to minimize the potential for interference.
- turn the radio OFF immediately if you have any reason to suspect that interference is taking place.

Hearing Aids

Some digital wireless radios may interfere with some hearing aids. In the event of such interference, you may want to consult your hearing aid manufacturer to discuss alternatives.

Other Medical Devices

If you use any other personal medical device, consult the manufacturer of your device to determine if it is adequately shielded from RF energy. Your physician may be able to assist you in obtaining this information.

Safety and General Use While Driving

Check the laws and regulations on the use of radio in the area where you drive. Always obey them.

When using your radio while driving, please:

- Give full attention to driving and to the road.
- Use hands-free operation, if available.
- Pull off the road and park before making or answering a call if driving conditions so require.

OPERATIONAL WARNINGS

• FOR VEHICLES WITH AN AIR BAG

Do not place a portable radio in the area over an air bag or in the air bag deployment area. Air bags inflate with great force. If a portable radio is placed in the air bag deployment area and the air bag inflates, the radio may be propelled with great force and cause serious injury to occupants of the vehicle.

• POTENTIALLY EXPLOSIVE ATMOSPHERES

Turn off your radio prior to entering any area with a potentially explosive atmosphere, unless it is a radio type especially qualified for use in such areas as “Intrinsically Safe.” Do not remove, install, or charge batteries in such areas. Sparks in a potentially explosive atmosphere can cause an explosion or fire resulting in bodily injury or even death.

Note: The areas with potentially explosive atmospheres referred to above include fueling areas such as below decks on boats, fuel or chemical transfer or

storage facilities, areas where the air contains chemicals or particles, such as grain, dust or metal powders, and any other area where you would normally be advised to turn off your vehicle engine. Areas with potentially explosive atmospheres are often but not always posted.

BLASTING CAPS AND AREAS

To avoid possible interference with blasting operations, turn off your radio when you are near electrical blasting caps, in a blasting area, or in areas posted: "Turn off two-way radio." Obey all signs and instructions.

OPERATIONAL CAUTIONS

- **ANTENNAS**

Do not use any portable radio that has a damaged antenna. If a damaged antenna comes into contact with your skin, a minor burn can result.

- **BATTERIES**

All batteries can cause property damage and/or bodily injury such as burns if a conductive material such as jewelry, keys, or beaded chains touch exposed terminals. The conductive material may complete an electrical circuit (short circuit) and become quite hot. Exercise care in handling any charged battery, particularly when placing it inside a pocket, purse, or other container with metal objects.

Getting Started

Turning On Your Radio

Do This

Press and hold  for 2 seconds.

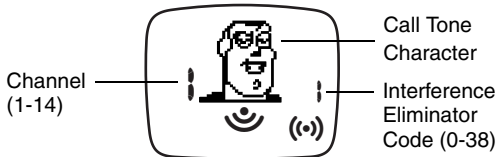

Result

The radio display shows the Standby screen.



See page 11 for descriptions of other things you might see on the screen.

Sharing Radio Channels

Your radio has 14 channels that you share with other groups on a “take turns” basis. Other groups may be talking on the channels. Do not talk over someone who is already using the channel – your message may not be completely heard. If someone is using your channel, change to a different channel and press  to see if it is clear. If you hear static while holding down , the channel is clear to use.

Parts of Your Radio

Press - to:

- Lower the sound
- Move down through options when changing radio settings

Press * to:

- Move through different radio settings
- Lock/unlock the keypad (when held down in Standby screen)

Press to:

Send call tone

Press and hold to:

- Turn radio on and off

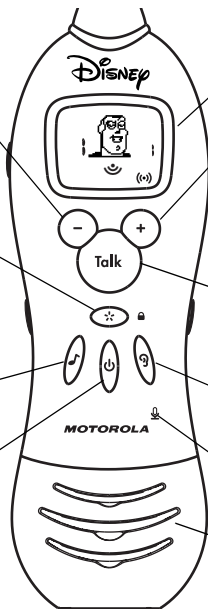

Display

Press + to:

- Raise the sound
- Move up through options when changing radio settings

Press and hold Talk to:

- Talk

Press Talk to:

- Save a radio setting

Press to:

- Monitor channel activity

Microphone

Speaker

What is on Your Display

The following picture shows some of the things you might see while using your radio.

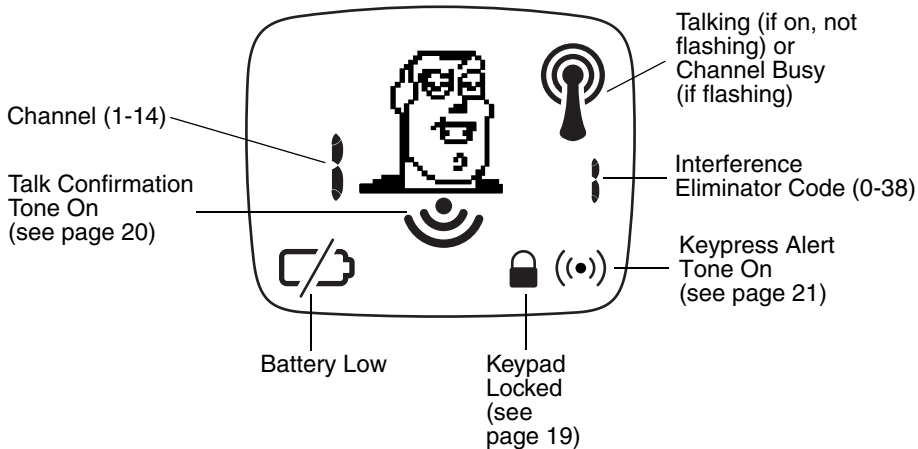

Installing Batteries

1. With back of radio facing you, press down cover latch with a screwdriver.
2. Remove cover.
3. Insert 4 AAA Alkaline batteries as shown.
4. Put cover back on and press down.

Note: Do not mix old and new batteries.

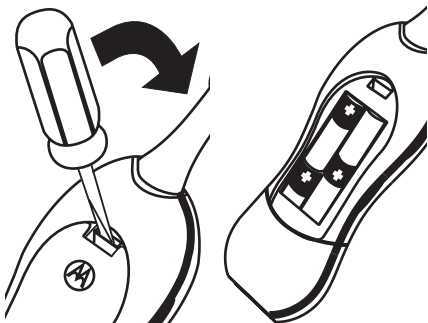

Low Battery Alert

When batteries are low,  appears on the display. Also, the radio beeps:

- 1 to 2 seconds after turning radio on
- Every 10 minutes in Standby mode
- After you release **Talk** button

Talking and Listening

All radios in your group must be set to the same channel (1-14) and interference eliminator code (0-38).

- Hold radio 2 to 3 inches from mouth.
- Press and hold the **Talk** button and talk into the microphone. The 📻 indicator appears on the right side of the display while you talk.
- To listen to others, release **Talk** button.

Talk Range

Do not use the radios closer than 5 feet apart.



Best Range Outdoors

Flat, open areas



Medium Range Outdoors

Buildings or trees
Also near houses



Worst Range Outdoors

Forests or mountains
Also inside some buildings

Making Radio Sound Quieter or Louder

Do This

1. Press **-** to make sound quieter or **+** to make sound louder.

Result

Display shows  and current volume setting (1-16).



2. Press **Talk** to save setting.

Display returns to Standby screen.

Sending Call Tones

Call tones are sounds you can send to get your listener's attention before you start talking. Your radio has 5 different sounds you can send. Each sound is a different Disney character's voice. The picture on the radio display shows the selected character.

To send a call tone, press . Listeners who are using the same channel and code will hear your call tone.

Changing Call Tones

Do This

1. From Standby screen, press ***** one time.

Result

Display shows  next to the Disney character's picture.

Note: Character pictures and their call tones vary by radio model.



2. Press **-** or **+** to change and hear the other character sounds.



3. When the character you want is shown, press **Talk** button.

Display returns to Standby screen, showing new character.

Changing Channels

If other groups are using the current channel:

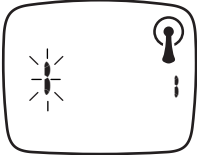
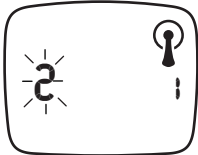
Do This	Result
1. From Standby screen, press * two times.	Current channel number flashes. 
2. Press - or + to change channel.	
3. Press Talk to save channel.	Display returns to Standby screen, showing new channel.

Changing Interference Eliminator Code

If there is too much noise on a channel, try changing the interference eliminator code to reduce the noise.

Do This

1. From Standby screen, press ***** three times.

Result

Current interference eliminator code flashes.

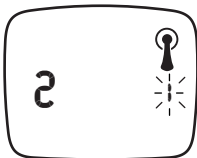

2. Press **-** or **+** to change code.

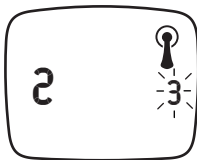

3. Press **Talk** to save code.

Display returns to Standby screen, showing new code.

You can set a different code for each channel. To set a channel and code:

1. Press ***** two times and then press **-** or **+** to go to the channel you want.
2. Press ***** again and then press **-** or **+** to go to the code you want.
3. Press **Talk** to save the channel and code.

To set another channel and code, do these steps again.

Listening to a Channel

Pressing **9** lets you hear how loud the radio sounds when someone is not talking to you. If you need to, you can make the sound louder or quieter. It also lets you hear if someone is talking on the channel before you talk.

Time-Out Timer

The time-out timer helps make your battery last longer by sounding a warning tone if **Talk** is pressed accidentally for too long. After one minute, the radio stops transmitting.

Locking the Keypad

To keep you from accidentally changing how your radio works, you can lock the keypad. When the keypad is locked, the *****, **-**, and **+** buttons do not work. You will not be able to change the call tone, channel, or interference eliminator code.

Do This

1. Press and hold ***** for 3 seconds.

Result

A  appears on the display, telling you the keypad is locked.



2. To unlock, press and hold ***** for 3 seconds.

The  disappears, telling you the keypad is unlocked.

Alerts

Talk Confirmation Tone

When you turn on the talk confirmation tone, your radio sends a unique tone when you finish talking and release the **Talk** button. It's like saying "Roger" or "Over" and lets others know you're finished talking.

There is a different talk confirmation tone for each call tone you select. (See page 14.) When this tone is turned on, ☺ appears on the Standby screen.

To turn the talk confirmation tone on or off:

Do This	Result
1. From Standby screen, press * four times.	Display shows ☺. 

Do This

Result

2. Press **+** or **-** to turn the talk confirmation tone on or off. ☑ means the tone is on. ☒ means the tone is off.



Display returns to Standby screen.

3. When the setting you want is shown, press **Talk** button.

Keypress Alert Tone

When you turn on the keypress alert tone, your radio sounds a tone whenever you press a button on the keypad. When you turn on this tone, (☑) appears on the Standby screen.

To turn the keypress alert tone on or off:

Do This

Result

1. From Standby screen, press * five times.

Display shows (☎).

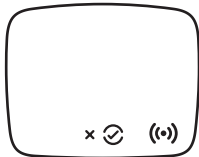

2. Press + or - to turn the alert tone on or off.
☎ means the tone is on.
☒ means the tone is off.

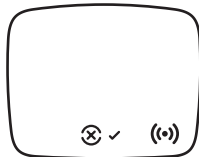

3. When the setting you want is shown, press **Talk** button.

Display returns to Standby screen.

Fixing Problems

Problem	Try This
No Power	Make sure the batteries are put in right or change batteries.
Erratic Display	Make sure the batteries are put in right or change batteries.
Message Not Sent	Make sure Talk is completely pressed while you talk. Make sure the batteries are put in right or change batteries. The channel may be in use. Try another channel.
Message Not Received	Make sure radios have same channel settings and/or interference eliminator code (helps reduce noise). Make sure Talk is not accidentally pressed. Make sure the batteries are put in right or change batteries. Big things like trees, buildings, or mountains, and use in buildings and in cars or trucks may keep others from hearing you or talking to you. Change where you are. Check that the sound is turned up.

Problem**Try This**

Hearing Other
People Talking
or Noise on a
Channel

Channel may be in use. Try another channel.

Radio Can't
Reach Other
Radios

Buildings, lots of trees, and use in buildings and in cars or trucks will keep your radio from reaching other radios. Check for clear straight line to other radio(s).

Wearing radio close to body, like in a pocket or on a belt, will decrease range. Change where you have the radio.

Too Much Noise

Radios too close. Radios must be at least 5 feet apart; move farther apart.

Radios too far apart. Move closer to other radio.

Buildings, lots of trees, and use in buildings and in cars or trucks will keep your radio from reaching other radios. Change where you are.

Use and Care



To clean the radio, use a soft damp cloth.



Do not put in water.



Do not use alcohol or cleaners.

If the radio gets wet...



Turn it off and take out batteries.



Dry with soft cloth. Wipe battery contacts with a dry, lint-free cloth.



Do not use until radio is dry.

Motorola Limited Warranty for the United States and Canada

What Does this Warranty Cover?

Subject to the exclusions contained below, Motorola, Inc. warrants its telephones, pagers, and consumer and professional two-way radios (excluding commercial, government or industrial radios) that operate via Family Radio Service or General Mobile Radio Service, Motorola-branded or certified accessories sold for use with these Products (“Accessories”) and Motorola software contained on CD-ROMs or other tangible media and sold for use with these Products (“Software”) to be free from defects in materials and workmanship under normal consumer usage for the period(s) outlined below. This limited warranty is a consumer's exclusive remedy, and applies as follows to new Motorola Products, Accessories and Software purchased by consumers in the United States or Canada, which are accompanied by this written warranty:

Products and Accessories

Products Covered	Length of Coverage
Products and Accessories as defined above, unless otherwise provided for below.	One (1) year from the date of purchase by the first consumer purchaser of the product unless otherwise provided for below.
Decorative Accessories and Cases. Decorative covers, bezels, PhoneWrap™ covers and cases.	Limited lifetime warranty for the lifetime of ownership by the first consumer purchaser of the product.

Products Covered	Length of Coverage
Monaural Headsets. Ear buds and boom headsets that transmit mono sound through a wired connection.	Limited lifetime warranty for the lifetime of ownership by the first consumer purchaser of the product.
Consumer and Professional Two-Way Radio Accessories.	Ninety (90) days from the date of purchase by the first consumer purchaser of the product.
Products and Accessories that are Repaired or Replaced.	The balance of the original warranty or for ninety (90) days from the date returned to the consumer, whichever is longer.

Exclusions

Normal Wear and Tear. Periodic maintenance, repair and replacement of parts due to normal wear and tear are excluded from coverage.

Batteries. Only batteries whose fully charged capacity falls below 80% of their rated capacity and batteries that leak are covered by this limited warranty.

Abuse & Misuse. Defects or damage that result from: (a) improper operation, storage, misuse or abuse, accident or neglect, such as physical damage (cracks, scratches, etc.) to the surface of the product resulting from misuse; (b) contact with liquid, water, rain, extreme humidity or heavy perspiration, sand, dirt or the like, extreme heat, or food; (c) use of the Products or Accessories for commercial purposes or subjecting the Product or Accessory to abnormal usage or conditions; or (d) other acts which are not the fault of Motorola, are excluded from coverage.

Use of Non-Motorola Products and Accessories. Defects or damage that result from the use of Non-Motorola branded or certified Products, Accessories, Software or other peripheral equipment are excluded from coverage.

Unauthorized Service or Modification. Defects or damages resulting from service, testing, adjustment, installation, maintenance, alteration, or modification in any way by someone other than Motorola, or its authorized service centers, are excluded from coverage.

Altered Products. Products or Accessories with (a) serial numbers or date tags that have been removed, altered or obliterated; (b) broken seals or that show evidence of tampering; (c) mismatched board serial numbers; or (d) nonconforming or non-Motorola housings, or parts, are excluded from coverage.

Communication Services. Defects, damages, or the failure of Products, Accessories or Software due to any communication service or signal you may subscribe to or use with the Products Accessories or Software is excluded from coverage.

Software

Products Covered	Length of Coverage
Software. Applies only to physical defects in the media that embodies the copy of the software (e.g. CD-ROM, or floppy disk).	Ninety (90) days from the date of purchase.

Exclusions

Software Embodied in Physical Media. No warranty is made that the software will meet your requirements or will work in combination with any hardware or software applications provided by third parties, that the operation of the software products will be uninterrupted or error free, or that all defects in the software products will be corrected.

Software NOT Embodied in Physical Media. Software that is not embodied in physical media (e.g. software that is downloaded from the internet), is provided “as is” and without warranty.

Who is Covered?

This warranty extends only to the first consumer purchaser, and is not transferable.

What Will Motorola Do?

Motorola, at its option, will at no charge repair, replace or refund the purchase price of any Products, Accessories or Software that does not conform to this warranty. We may use functionally equivalent reconditioned/refurbished/pre-owned or new Products, Accessories or parts. No data, software or applications added to your Product, Accessory or Software, including but not limited to personal contacts, games and ringer tones, will be reinstalled. To avoid losing such data, software and applications please create a back up prior to requesting service.

How to Obtain Warranty Service or Other Information?

USA	Phones 1-800-331-6456 Two-Way Radios 1-800-353-2729 Pagers 1-800-548-9954
Canada	All Products 1-800-461-4575
TTY	TTY 1-888-390-6456
For Accessories and Software , please call the telephone number designated above for the product with which they are used.	

You will receive instructions on how to ship the Products, Accessories or Software, at your expense, to a Motorola Authorized Repair Center. To obtain service, you must include: (a) a copy of your receipt, bill of sale or other comparable proof of purchase; (b) a written description of the problem; (c) the name of your service provider, if applicable; (d) the name and location of the installation facility (if applicable) and, most importantly; (e) your address and telephone number.

What Other Limitations Are There?

ANY IMPLIED WARRANTIES, INCLUDING WITHOUT LIMITATION THE IMPLIED WARRANTIES OF MERCHANTABILITY AND FITNESS FOR A PARTICULAR PURPOSE, SHALL BE LIMITED TO THE DURATION OF THIS LIMITED WARRANTY, OTHERWISE THE REPAIR, REPLACEMENT, OR REFUND AS PROVIDED UNDER THIS EXPRESS LIMITED WARRANTY IS THE EXCLUSIVE REMEDY OF THE CONSUMER, AND IS PROVIDED IN LIEU OF ALL OTHER WARRANTIES, EXPRESS OR IMPLIED. IN NO EVENT SHALL MOTOROLA BE LIABLE, WHETHER IN CONTRACT OR TORT (INCLUDING NEGLIGENCE) FOR DAMAGES IN EXCESS OF THE PURCHASE PRICE OF THE PRODUCT, ACCESSORY OR SOFTWARE, OR FOR ANY INDIRECT, INCIDENTAL, SPECIAL OR CONSEQUENTIAL DAMAGES OF ANY KIND, OR LOSS OF REVENUE OR PROFITS, LOSS OF BUSINESS, LOSS OF INFORMATION OR DATA, SOFTWARE OR APPLICATIONS OR OTHER FINANCIAL LOSS ARISING OUT OF OR IN CONNECTION WITH THE ABILITY OR INABILITY TO USE THE PRODUCTS, ACCESSORIES OR SOFTWARE TO THE FULL EXTENT THESE DAMAGES MAY BE DISCLAIMED BY LAW.

Some states and jurisdictions do not allow the limitation or exclusion of incidental or consequential damages, or limitation on the length of an implied warranty, so the above limitations or exclusions may not apply to you. This warranty gives you specific legal rights, and you may also have other rights that vary from state to state or from one jurisdiction to another.

Laws in the United States and other countries preserve for Motorola certain exclusive rights for copyrighted Motorola software such as the exclusive rights to reproduce and distribute copies of the Motorola software. Motorola software may only be copied

into, used in, and redistributed with, the Products associated with such Motorola software. No other use, including without limitation disassembly of such Motorola software or exercise of the exclusive rights reserved for Motorola, is permitted.

FCC License Not Required

Changes or modifications not expressly approved by Motorola may void the user's authority granted by the FCC to operate this radio and should not be made. To comply with FCC requirements, transmitter adjustments should be made only by or under the supervision of a person certified as technically qualified to perform transmitter maintenance and repairs in the private land mobile and fixed services as certified by an organization representative of the user of those services. Replacement of any transmitter component (crystal, semiconductor, etc.) not authorized by the FCC equipment authorization for this radio could violate FCC rules.

Software Copyright Notice

The Motorola products described in this manual may include copyrighted Motorola and third party software stored in semiconductor memories or other media. Laws in the United States and other countries preserve for Motorola and third party software providers certain exclusive rights for copyrighted software, such as the exclusive rights to distribute or reproduce the copyrighted software. Accordingly, any copyrighted software contained in the Motorola products may not be modified, reverse-engineered, distributed, or reproduced in any manner to the extent allowed by law. Furthermore, the purchase of the Motorola products shall not be deemed to grant either directly or by implication, estoppel, or otherwise, any license under the copyrights, patents, or patent applications of Motorola or any third party software provider, except for the normal, non-exclusive, royalty-free license to use that arises by operation of law in the sale of a product.

Patent Information

This product is manufactured under one or more of the following United States patents.

5896277 5894292 5864752 5699006 5742484 D408396 D399821 D387758
D389158 5894592 5893027 5789098 5734975 5861850 D395882 D383745
D389827 D389139 5929825 5926514 5953640 6071640 D413022 D416252
D416893 D433001

Export Law Assurances

This product is controlled under the export regulations of the United States of America and Canada. The Governments of the United States of America and Canada may restrict the exportation or re-exportation of this product to certain destinations. For further information contact the U.S. Department of Commerce or the Canadian Department of Foreign Affairs and International Trade.

- **Up to 2 Mile Range***

*Range will vary based on terrain and conditions

- **Character Voices**

Get others' attention before you start talking

- **Animated Character Display**

- **No License Fee or Airtime Charges!**

- **14 Channels, each with 38 Codes**

- **Low Battery Alert**

Audible tone and visual display tell you your batteries are running down

- **Keypad Lock**

Prevents your settings from being accidentally changed

- **Weather-Resistant**

- **Durable, Fixed Antenna**
Maximizes talk range

- **Batteries (not included)**
Requires 4 AAA Alkaline batteries

- **1 Year Limited Warranty**
To obtain a copy of this warranty prior to purchase, please ask retailer.

- **User's Guide Included**

Disney 2-Way FRS Radio



Proof of Purchase

Ages 3 and Up

Disney/Pixar elements © Disney/Pixar

MOTOROLA, the Stylized M Logo, and all other trademarks indicated as such herein are trademarks of Motorola, Inc. ® Reg. U. S. Pat. & Tm. Off. All other product or service names are the property of their respective owners. © 2002 Motorola, Inc. All rights reserved.