



MOTOROLA

User's Guide

TALKABOUT®









TWO-WAY RADIO



6864110R05-O

Model T6400

Contents

	Safety/General Information . . .	i		Privacy	25
	FCC License Information	1		Eavesdrop Reducer	25
	Getting Started	3		Quiet6000™	26
	Installing Batteries	4		Advanced Two-Way	27
	CommPort™ Charging Dock . . .	7		Lock	27
	Basic Operation of Radio . . .	10		LockPlus	27
	Belt Clip	10		Channel Scanning	27
	Backlight	14		Talk Confirmation Tone	28
	Talking	15		Button Beeps	28
	Before You Can Talk	15		Automatic Power Off	29
	To Talk	17		Monitor	29
	Call Tone and Call Display . . .	19		Reset	31
	Alerts	20		Setting the Battery Type	31
	VibraCall® Alert	20		Use and Care	31
	Keeping Time	21		Frequency and Code Charts	34
	Setting the Time	21			
	Setting the Alarm	22			
	Stopwatch	23			
	Hands-Free Use (VOX)	24		Troubleshooting	37
				Motorola Limited Warranty . .	40

SAFETY AND GENERAL INFORMATION

IMPORTANT INFORMATION ON SAFE AND EFFICIENT OPERATION
READ THIS INFORMATION BEFORE USING YOUR RADIO.

The information provided in this document supersedes the general safety information contained in user guides published prior to July 2000. For information regarding radio use in a hazardous atmosphere please refer to the Factory Mutual (FM) Approval Manual Supplement or Instruction Card, which is included with radio models that offer this capability.

RF Operational Characteristics

Your radio contains a transmitter and a receiver. When it is ON, it receives and transmits radio frequency (RF) energy. The radio operates in the frequency range of 462 MHz to 467 MHz. The output power level typically may vary over a range from 0.5 watts to 1.0 watt.

Exposure To Radio Frequency Energy

Your Motorola radio is designed to comply with the following national and international standards and guidelines regarding exposure of human beings to radio frequency electromagnetic energy:

- United States Federal Communications Commission, Code of Federal Regulations; 47 CFR part 2 sub-part J
- American National Standards Institute (ANSI) / Institute of Electrical and Electronic Engineers (IEEE) C95. 1-1992
- Institute of Electrical and Electronic Engineers (IEEE) C95.1-1999 Edition
- National Council on Radiation Protection and Measurements (NCRP) of the United States, Report 86, 1986
- International Commission on Non-Ionizing Radiation Protection (ICNIRP) 1998

- Ministry of Health (Canada) Safety Code 6. Limits of Human Exposure to Radio frequency Electromagnetic Fields in the Frequency Range from 3 kHz to 300 GHz, 1999
- Australian Communications Authority Radio communications (Electromagnetic Radiation - Human Exposure) Standard 1999 (applicable to wireless phones only)

To assure optimal radio performance and make sure human exposure to radio frequency electromagnetic energy is within the guidelines set forth in the above standards, always adhere to the following procedures:

PORTABLE RADIO OPERATION AND EME EXPOSURE

Antenna Care

Use only the supplied or an approved replacement antenna. Unauthorized antennas, modifications, or attachments could damage the radio and may violate FCC regulations.

DO NOT hold the antenna when the radio is “IN USE.” Holding the antenna affects call quality and may cause the radio to operate at a higher power level than needed.

Two-way Radio Operation

When using your radio as a traditional two-way radio, **hold the radio in a vertical position with the microphone one to two inches (2.5 to 5 cm) away from the lips.**

Body-worn Operation

To maintain compliance with FCC/Health Canada RF exposure guidelines, if you wear a radio on your body when transmitting, always place the radio in a **Motorola supplied or approved clip, holder, holster, case, or body harness for this product**. Use of non-Motorola-approved accessories may exceed FCC/Health Canada RF exposure guidelines. **If you do not use a body-worn accessory**, and are not using the radio held in the normal use position at the ear, **ensure the radio and its antenna are at least one inch (2.5 cm) from your body when transmitting.**

Data operation

When using any data feature of the radio, with or without an accessory cable, **position the radio and its antenna at least one inch (2.5 cm) from the body.**

Approved Accessories

For a list of approved Motorola accessories visit our website at www.motorola.com.

ELECTROMAGNETIC INTERFERENCE/COMPATIBILITY

Note: Nearly every electronic device is susceptible to electromagnetic interference (EMI) if inadequately shielded, designed or otherwise configured for electromagnetic compatibility.

FACILITIES

To avoid electromagnetic interference and/or compatibility conflicts, turn off your radio in any facility where posted notices instruct you to do so. Hospitals or health care facilities may be using equipment that is sensitive to external RF energy.

AIRCRAFT

When instructed to do so, turn off your radio when on board an aircraft. Any use of a radio must be in accordance with applicable regulations per airline crew instructions.

MEDICAL DEVICES

Pacemakers

The Advanced Medical Technology Association recommends that a minimum separation of 6 inches (15 centimeters) be maintained between a handheld wireless radio and a pacemaker. These recommendations are consistent with the independent research by, and recommendations of, the United States Food and Drug Administration.

Persons with pacemakers should:

- ALWAYS keep the radio more than six inches (15 centimeters) from their pacemaker when the radio is turned ON.
- not carry the radio in the breast pocket.
- use the ear opposite the pacemaker to minimize the potential for interference.
- turn the radio OFF immediately if you have any reason to suspect that interference is taking place.

Hearing Aids

Some analogue wireless radios may interfere with some hearing aids. In the event of such interference, you may want to consult your hearing aid manufacturer to discuss alternatives.

Other Medical Devices

If you use any other personal medical device, consult the manufacturer of your device to determine if it is adequately shielded from RF energy. Your physician may be able to assist you in obtaining this information.

SAFETY AND GENERAL USE WHILE DRIVING

Check the laws and regulations on the use of radio in the area where you drive. Always obey them.

When using your radio while driving, please:

- Give full attention to driving and to the road.
- Use hands-free operation, if available.
- Pull off the road and park before making or answering a call if driving conditions so require.

OPERATIONAL WARNINGS FOR VEHICLES WITH AN AIR BAG

Do not place a portable radio in the area over an air bag or in the air bag deployment area. Air bags inflate with great force. If a portable radio is placed in the air bag deployment area and the air bag inflates, the radio may be propelled with great force and cause serious injury to occupants of the vehicle.

POTENTIALLY EXPLOSIVE ATMOSPHERES

Turn off your radio prior to entering any area with a potentially explosive atmosphere, unless it is a radio type especially qualified for use in such areas as "Intrinsically Safe." Do not remove, install, or charge batteries in such areas. Sparks in a potentially explosive atmosphere can cause an explosion or fire resulting in bodily injury or even death.

Note: The areas with potentially explosive atmospheres referred to above include fueling areas such as below decks on boats, fuel or chemical transfer or storage facilities, areas where the air contains chemicals or particles, such as grain, dust or metal powders, and any other area where you would normally be advised to turn off your vehicle engine. Areas with potentially explosive atmospheres are often but not always posted.

BLASTING CAPS AND AREAS

To avoid possible interference with blasting operations, turn off your radio when you are near electrical blasting caps, in a blasting area, or in areas posted: "Turn off two-way radio." Obey all signs and instructions.

OPERATIONAL CAUTIONS

ANTENNAS

Do not use any portable radio that has a damaged antenna. If a damaged antenna comes into contact with your skin, a minor burn can result.

BATTERIES

All batteries can cause property damage and/or bodily injury such as burns if a conductive material such as jewelry, keys, or beaded chains touch exposed terminals. The conductive material may complete an electrical circuit (short circuit) and become quite hot. Exercise care in handling any charged battery, particularly when placing it inside a pocket, purse, or other container with metal objects.

Charging Safety Instructions

Before using the battery charger, read all instructions and cautionary markings on the:

1. battery
2. battery charger, and
3. radio using the battery.

Caution: To reduce the risk of injury, charge only the rechargeable batteries listed. Other types of batteries may burst, causing personal injury and damage.

Single-Unit Charger

Kit Number	Description
NTN9393	110V - NiMH Charging Adapter

Batteries

Kit Number	Capacity in milliampere-hour mAH	Description	Composition
NTN9395	550 mAH	T6000-Series	NiMH

Save these Instructions

1. Do not expose the charger to rain or snow.
2. Do not operate the charger if it has received a sharp blow, or has been dropped or damaged in any way.

3. Do not disassemble the charger if it has received a sharp blow, or has been dropped or damaged in any way.
4. Never alter the AC cord or plug provided with the unit. If plug will not fit the outlet, have proper outlet installed by a qualified electrician. An improper condition can result in a risk of electric shock.
5. To reduce risk of damage to cord or plug, pull the plug rather than the cord when disconnecting charger from AC receptacle.
6. To reduce the risk of electric shock, unplug the charger from the outlet before attempting any maintenance or cleaning.
7. Use of an attachment not recommended or sold by Motorola may result in a risk of fire, electric shock, or personal injury.
8. Make sure that the cord is located so that it will not be stepped on, tripped over, or subjected to damage or stress.
9. An extension cord should not be used unless absolutely necessary. Use of an improper extension cord could result in a risk of fire and/or electric shock. If an extension cord must be used, make sure:
 - That the pins on the plug of the extension cord are the same number, size and shape as those on the plug of the charger.
 - That the extension cord is properly wired and in good electrical condition, and
 - That the cord size is 18 AWG for lengths up to 100 feet, and 16 AWG for lengths up to 150 feet.
10. The supply cord of this charger cannot be replaced. If the cord is damaged, the charger should be discarded or returned to the point of purchase if within 90 days of purchase.

FCC Licensing Information

Your Motorola radio operates on General Mobile Radio Service (GMRS) frequencies and is subject to the Rules and Regulations of the Federal Communications Commission (FCC). The FCC requires that all operators using General Mobile Radio Service (GMRS) frequencies obtain a radio license before operating their equipment.

To have the FCC forms faxed to you, contact the Fax-On-Demand system at: 1-202-418-0177 from your fax machine and request document **000605** for all forms and instructions.

To have the forms mailed to you, call the FCC forms hotline at:

1-800-418-FORM (1-800-418-3676)

For questions about the license application, contact the FCC at:

1-888-CALL-FCC (1-888-225-5322)

Or: <http://www.fcc.gov>

Before filling out your application, you must decide which frequency(ies) you can operate on. See on page 34. For questions on determining your radio frequency, please call Motorola Product Services at: 1-800-448-6686

Changes or modifications not expressly approved by Motorola may void the user's authority granted by the FCC to operate this radio and should not be made. To comply with FCC requirements, transmitter adjustments should be made only by or under the supervision of a person certified as technically qualified to perform transmitter maintenance and repairs in the private land mobile and fixed services as certified by an organization representative of the user of those services. Replacement of any transmitter component (crystal, semiconductor, etc.) not authorized by the FCC equipment authorization for this radio could violate FCC rules.

Note: Use of this radio outside the country where it was intended to be distributed is subject to government regulations and may be prohibited.



Getting Started



Hi, I'm QuickStart and I'm going to help you get started!

The Motorola® Talkabout® T6400 radio is a durable two-way radio that allows you to stay connected to family, friends, and companions. The T6400 operates on Family Radio Service (FRS) frequencies and General Mobile Radio Service (GMRS) frequencies; FRS requires no service fee or license, and can be used anywhere in the United States and other areas as listed by the FCC, but GMRS are subject to FCC licensing requirements.

These radios offer more than just a way of keeping in touch. They also help you and your group stay on schedule because a clock, alarm, and stopwatch are built into each model.

A detachable Quick Reference Card is included.

Please read this manual to aid in understanding how your radio works.



Installing Batteries

Your radio uses three AA batteries or a rechargeable Nickel-Metal Hydride (NiMH) battery.

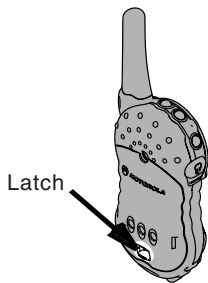

- Turn off the radio (see page 13).
- Push latch up until it clicks.
- Lift back cover off.

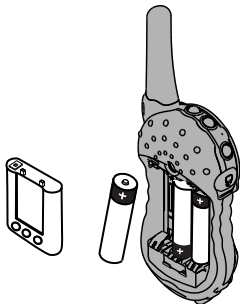





- Remove and replace batteries so the + and - markings match the ones in the compartment or the NiMH charge contacts are facing out.



- Hook back cover on the hinges.
- Align tabs.
- Close battery door, pressing lightly until latch clicks.

Note: The radio keeps the clock settings if battery changes are made in less than 20 seconds. Try replacing one battery at a time.



The battery meter on the top-left corner of the display shows how much battery power you have. It shows  (full),  (two-thirds full),  (one-third full) and  (almost empty). When it's , the radio beeps every ten minutes. So, change or charge those batteries!



Charging the NiMH battery (Optional Accessory, part number 56319)

Charge the NiMH overnight (12 to 16 hours) before using it for the first time, it will need up to four hours of charging thereafter.

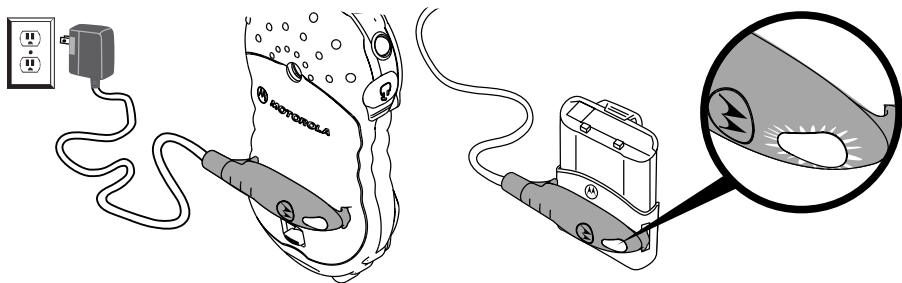



- Turn off the radio (see page 13) or place the NiMH battery in the charger adapter cover.
- Plug in the charger.
- At the contacts on the back of the radio, or if charging just the battery, at the battery contacts:
- Position the charger with the hook on the LED end of the charger placed over the larger slot.
- Snap the hook on the cord end into the smaller slot.

Note: If you notice the LED flashing red for more than a minute while clamping the charger onto the charger adapter cover, the battery is faulty and must be replaced.

- When the LED turns solid green, the battery is fully charged.

Note: When charging the battery by itself, remove the charger from the charger adapter cover before removing the battery.



CommPort™ Charging Dock (Included with Optional Accessory, part number 56319)

The CommPort™ charging dock provides drop-in charging convenience. The charging dock can be mounted or placed on any flat surface (such as a wall or workbench) and turns your radio into a stationary intercom while keeping it charged and ready for any adventure.

- To mount the charging dock:
- Wrap the power cord under the charging dock. Use the cutouts to hold the cord in place.
- Attach using two #6 x $\frac{3}{4}$ " screws appropriate for the mounting surface.

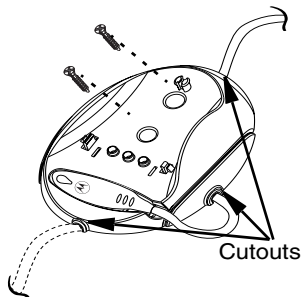



- Position the charger with the hook on the LED end over the left slot.
- Snap the hook on the cord end into the right slot, clamping the charger onto the charging dock contacts
- Plug in the charger.
- Place the radio, or the NiMH battery in the charger adapter cover, into the CommPort charging dock.
- When the LED turns solid green, the battery is fully charged.

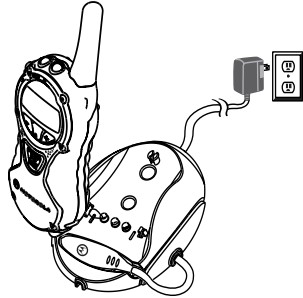
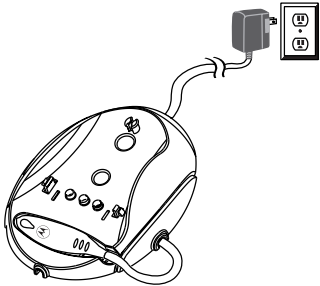



Charging Status

The LED charger indicates charging status when the charger is connected to the radio, the NiMH battery, or the CommPort™ charging dock.

Color	Charging Status and Description	Charging Level Complete
Solid Red	Rapid charging	Up to 90%
Flashing Green	Top-off charging	90% to 100%
Solid Green	Charging complete	100%
Flashing Red	Battery faulty. If flashing red persists for more than one minute, the battery is faulty and should be replaced.	-
Flashing Yellow	Standby Battery waiting to charge. Temperature out of range for charging; - must be between 5° to 40° C or 41° to 104° F	-

Basic Operation of Your Radio

Use **Ⓜ** to --

- Turn power on/off

Use **MODE** to --

- Scroll through mode selections
- Return to two-way mode (when held down)

Use **🎵** to --

- Transmit call tone
- Start and stop stopwatch

Microphone --

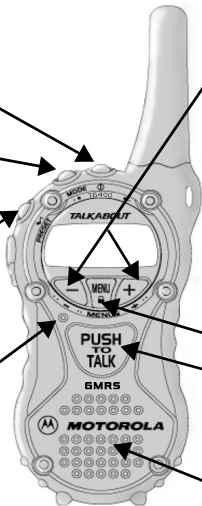

Use **-** and **+** to --

- Change the volume
- Scroll through and select settings

Use **MENU** to --

- Scroll through menus
- Lock the keypad (when held down and not in a menu)
- Exit the menu (when held down while in a menu)

Use **PUSH TO TALK** to --

- Talk on the radio
- Save a setting

Speaker --



Belt Clip

- Squeeze the top and bottom of the clip to attach or detach the clip from the radio.

Note: The belt clip holds the radio while being worn on your belt. It was designed for your convenience and is not meant to secure your radio under all circumstances.

NiMH Battery Charging Contacts

- When using audio accessories with your radio, Motorola recommends that the volume level be kept at a comfortable listening level.

Accessory Connector

- For audio accessories, such as speaker/microphone and flexible ear receiver.

Note: Connector(s) shown with the cover plug in place. Both connectors cannot be used at the same time.

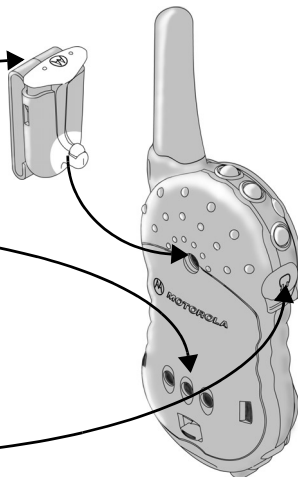

Check out the Accessory Brochure for other cool stuff available from Motorola.



Using your radio is easier than catching a wave!



Turning On Your Radio

Press

To Display

Then

①

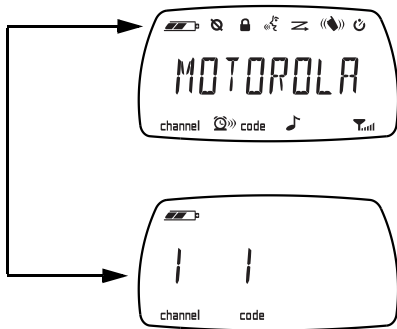

The radio beeps and ① flashes every three seconds.



Your Radio's Display

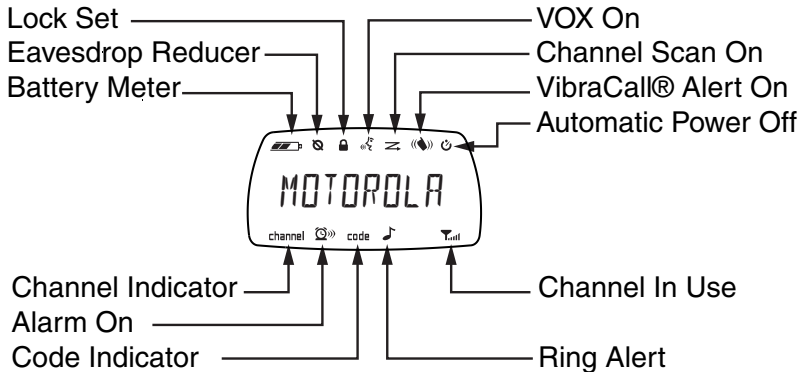

Turning Off Your Radio

To turn off your radio, press and hold  until the radio beeps and the display goes blank.









Modes

Your radio can transmit and receive in all modes. The T6400 standard modes are: *TWO WAY*, *TIME*, *STPWATCH*, and *SETTINGS*.





Key Sequence

Almost everything you can do with your radio is done using the same basic key sequence! Use your radio's mode and menu screens to select options and set features the way you want them. All the features that work using this key sequence are described on the following pages.

Press	To Display	Then Press
	the mode you want	 to display the associated menus
	the menu you want	 or  to select the menu
 or 	the setting you want	 or wait ten seconds to save the setting or press and hold 



Backlight

Being in the dark is never a problem. Your radio has a backlight that turns on automatically any time you press a button, except  and . The backlight turns off when you're talking on the radio and turns itself off automatically after five seconds.



Talking

Before You Can Talk



Have you ever tried to talk to someone who's on a "different wavelength?" It's not easy, is it? Well, you can't talk with someone else on your two-way radio unless you ARE BOTH on the same channel and using the same interference eliminator code. The interference eliminator codes help minimize interference by providing you with a choice of code combinations.*

The channel is the radio frequency wave your radio uses to transmit.

*The interference eliminator code filters out static, noise, and unwanted messages. Refer to the Frequency and Code Charts beginning on page 34 for channel and code choices.

Your T6400 two-way radio has 22 channels:

Channel Numbers	Description	Transmit Power
Channels 1-7	GMRS Interstitial 1-7 also FRS 1-7	1 watt
Channels 8-14	FRS 8-14	0.5 watt
Channels 15-22	GMRS Primary 1-8	1 watt



Your T6400 is compatible with both General Mobile Radio Service (GMRS) and Family Radio Service (FRS) channels. You can talk to FRS radios on channels 1-14. Remember that FRS radios operate at 0.5 watt of transmit power. On channels 1-7, the T6400 operates at 1 watt. In certain situations, when talking to FRS radios on channels 1-7, it is possible that they will be able to hear you, but you will not be able to hear them. This is because you are transmitting with more power (1 watt) than the FRS radio (0.5 watt). If this occurs, you must move closer to the other person to have clear, two-way communication.

Setting the Channel

Remember that basic key sequence? Use it now!

To set the channel, select the *TWO WAY* mode and the *SET CHAN* menu.

Setting the Code

To set the code, select the *TWO WAY* mode and the *SET CODE* menu.

Channel Frequency in Use

Your radio displays  whenever the channel frequency is in use. Keep scrolling until you get a clear one.

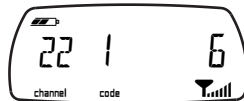



Your radio can save a specific code for each channel. Set the channel and code and while operating, press  and then scroll between selected channel and code settings.





Radio Volume



Can we talk yet?

Sure, but you should adjust the volume first. Press  or  until it's just right. If you want to, sound your call tone by pressing .

To Talk

Press and hold  and talk two-to-three inches away from the microphone. When you're finished, just let  go. While transmitting,  glows red.

Talking Range



Optimal Range

Flat, open areas



Medium Range

Buildings or trees





Minimal Range

Dense foliage or mountains



Using Accessories

Make sure the radio is turned off before plugging audio accessories into the accessory port. Before you place an accessory on your head or in your ear, turn the volume down. After placing the accessory on your head or in your ear, adjust the volume by pressing  to .

Signal Strength Indicator

The signal strength indicator can help you determine when a radio is moving out of range. It is a number displayed when you're receiving on the same channel and code as another transmitting radio and it indicates the relative signal strength of the transmitting radio: 1 is weakest (usually farthest away) and 6 is strongest (usually closest).

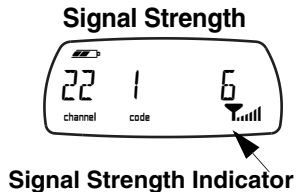

Note: Obstacles that block the signal path may affect the signal strength indicator function.



Call Tone and Call Display



Don't you hate it when you miss a call?

I mean it could be someone really important.

A call you need to take right away.

Or worse, someone you're trying to reach may not know that you've called because their surroundings are too noisy.

Your radio can transmit ten different call tones. To set your call tone, select the **TWO WAY** mode and the **SET CALL** menu. The radio plays a sample of each tone as you scroll through them. To use your call tone, just press  to transmit it to others.

You can always tell if someone using a T6000-Series radio is trying to reach you when your radio displays the call received screen.





Alerts

You can determine how your radio will alert you when you're receiving: vibrate, ring, or both. Your radio will notify you with your selected alert if 30 seconds have passed since your last transmission or incoming call.

VibraCall[®] Alert

Your radio features VibraCall[®] alert, a vibrating alert to notify you of two-way radio reception in noisy environments.

OFF -- your radio doesn't sound an alert except for the audio reception when receiving.



VID ON -- your radio
VIBRATES to alert you.



RING -- your radio RINGS
your call tone when receiving.

VID+RING -- your radio vibrates and rings your call tone when receiving.

To set VibraCall[®] alert, select the **SETTINGS** mode and the **SET VID** menu.



Keeping Time

Your radio has several features to help you keep track of time: stopwatch, alarm, and the clock display can be set as your standby screen.

Setting the Time

Setting the time is easy! Use the basic key sequence to select the *TIME* mode and the *SET TIME* menu, then

Press	To Display	Then Press
 and  to set hours and minutes		 to move between hours and minutes

Setting the Clock Display

To display the clock, select the *TIME* mode and the *SET DISP* menu.

If you choose to display the clock, the time screen becomes your two-way radio's standby screen. It appears whenever the radio is on and nothing else is happening.



Setting the Alarm

To set the time the alarm will sound, select the *TIME* mode and the *ALARM TIME* menu, and set the alarm time the same way you set the clock time.



The alarm volume is the same as the radio volume, so make sure it's loud enough.

To set the alarm, select the *TIME* mode and the *SET ALARM* menu. Press and to select *ALARM ON* (or *ALARM OFF*).

"I'm all shook up."



Your alarm will now sound your call tone at the set time every day.

Alarm Turned On

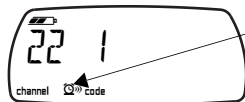

Alarm On Indicator

Turning Off the Alarm

When the alarm rings and flashes, turn it off by pressing any button. If you don't turn off the alarm, it rings and flashes every ten seconds for up to one minute.

If your radio is turned off, it turns on automatically at the same time every day when the alarm sounds. And, the radio stays on if you don't turn off the alarm. So turn it off and save your batteries!



Stopwatch

If you're running laps, or just feel like you are, you can use the stopwatch to time yourself.

Press

To Display

Then Press



 until **STPWATCH**
appears



 to start or stop
timing



 to reset
stopwatch when it
is stopped

Your stopwatch has a lap timer function too. While the stopwatch is running, press  to obtain the lap time. Press  again to switch back to stopwatch.

Note: If you turn off the radio or take it out of stopwatch mode, the stopwatch time resets.





Hands-Free Use (VOX)



LOOK, NO HANDS!!

Your radio has built-in Voice Operated Transmission (VOX), which allows you to transmit “hands-free” just by talking or using VOX accessories. After VOX has been set and turned on, you can use it anytime you want your hands free for other things.

To set VOX, select the **SETTINGS** mode and the **SET VOX** menu, select **VOX ON**. When **VOX** is set to **ON**, your display shows **☞**.

To turn on VOX, quickly press and release  and **☞** will begin to flash. Your radio will now transmit every time you talk. Press  to turn off VOX and return to the regular way of transmitting. The **☞** will stop flashing. To reset VOX use, select **VOX OFF**.

The VOX sensitivity level allows you to compensate for background noise. This minimizes the chance of unintended noises triggering a transmission.

To set the VOX sensitivity level, select the **SETTINGS** mode and the **SET SENS** menu, then select high (**HI**) for quiet environments, medium (**MED**), or low (**LO**) for noisy environments. **VOX MED** is recommended for most situations, although you may need to experiment until you get the right setting.

When you connect a VOX accessory, the radio will automatically set to **VOX ON** and **☞** will begin to flash, indicating that the radio is ready to transmit each time you talk.

When you transmit using a VOX headset, you'll hear yourself talking through the accessory speaker. This feature lets you know VOX is working.



Privacy

Eavesdrop Reducer

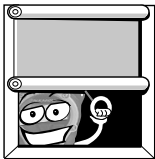

Just between you and me, there are many things we need to keep under wraps ...

Your radio has the Eavesdrop Reducer feature, a scramble code that makes your transmissions sound garbled to anyone listening. It doesn't guarantee secrecy, but it adds an extra layer of privacy. Don't forget -- all the radios have to be set to the same scramble code for the transmissions to be clear.

To set the scramble code, select the *TWO WAY* mode and the *SETSCRAM* menu, then select code *SCRAM 1*, *SCRAM 2* or *SCRAM 3*. Your display will now show . To turn scramble code off, select *SCRAM OFF*.



Quiet6000™

The Quiet6000™ function helps ensure uninterrupted communication between Motorola Talkabout T6000-series radios - it helps to prevent you from hearing transmissions from anything other than these radios. If you and your companions use only the Motorola Talkabout T6000-series radios with Quiet6000 on, you'll minimize the chance of being interrupted by others (but they can hear you).

To turn the Quiet6000 function on or off, select the `SETTINGS` mode and the `SET QUIET` menu. All the radios have to be set to `QUIET ON` to avoid interruptions. You need to transmit a call tone before talking, other radios on your channel and code can then receive and transmit until 30 seconds of inactivity occurs which resets the Quiet6000 function. `#` is displayed in the signal strength area of the two-way mode display to indicate that the Quiet6000 function is on, and it flashes while on a call with another Motorola Talkabout T6000-series radio.





Advanced Two-Way

Lock





You can make sure your menu settings won't be changed accidentally.

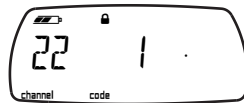

Just turn on the menu lock by pressing  for three seconds. Now you'll see a  on the display like this--



Locked Screen



Lock only locks  settings. You can turn off the menu lock by pressing  for three seconds again.  disappears from your display when it's turned off.

LockPlus

The LockPlus feature locks all the buttons except ,  and . Meaning that you can only turn the two-way radio on and off and transmit.

Turn on the LockPlus feature by pressing  for six seconds, the display will show a flashing . You can turn off the LockPlus feature by pressing  for six seconds once again.



Channel Scanning



*By using **SCAN**, you can monitor channels and codes for transmissions and lock in on the one that interests you. You don't have to set a new channel or code, the radio just resets itself temporarily to that channel and code and you can start talking. However, if no transmissions take place for five seconds, scanning resumes.*

After you turn on **SCAN**, your radio scans channels and codes until it finds an active one and locks on to it. If you do not begin talking or no one else transmits within a short time, it will resume scanning.



If you want to scan channel frequencies without interference eliminator codes, change your code to **0**.

Turning on Channel Scanning

To set channel scanning, select the **TWO WAY** mode and the **SET SCAN** menu. Your channel/code screen displays **≧** and scrolls through channels when scanning is turned on.



Scan List

You can select which channels are to be scanned by putting them in a list. To set your scan list after you turn on **SCAN**, select the **TWO WAY** mode and the **SCANLIST** menu. Your radio displays **IN** or **OUT** and a channel number. Use  to change the **IN** or **OUT** setting and  to scroll to the next channel. Select **IN** to add the channel to your scan list, if you don't wish to scan a certain channel select **OUT**.

Note: To scan channels 15 through 22, you must turn these channels to 'ON' in your scan list.

Talk Confirmation Tone



Whenever you turn on the talk confirmation tone feature, your two-way radio transmits a unique tone when you finish transmitting. It's like saying "Roger" or "Over" and lets others know when to begin talking.

To set this feature, select the **SETTINGS** mode and the **SETRoger** menu.

Button Beeps

The button beeps feature allows you to control whether the radio beeps every time you press a button. Turn it off if you want quiet radio operation. To set the button beeps feature, select the **SETTINGS** mode and the **SETBEEPS** menu. To turn off the button beeps feature, select **BEEPSOFF**; to turn on the button beeps feature, select **BEEPS ON**. For a shortcut method of turning off the button beeps feature, press and hold  when turning on the radio.

Call Tones are not heard on the transmitting radio when button beeps are off.



Automatic Power Off

You can program your radio to turn itself off after a certain period of inactivity. This helps save battery life.

To set the automatic power off feature, select the **SETTINGS** mode and the **SETPWRDOWN** menu. Choose the number of hours **HOURS 1-8**, after which, power shuts off. Choose **HOURS --** to turn off the automatic power off feature. **Ⓞ** displays on the screen when the automatic power off feature is set.

Monitor

Using the monitor feature helps to improve the reception of your radio if you're frequently almost out of range. It also allows you to listen to a channel frequency without codes (carrier squelch) to tell whether it's currently in use. To use the monitor, select the **TWO WAY** mode and the **SET MON** menu.

Your channel and code screen will look like this.



You'll hear static if the channel frequency is unused.

Changing from two-way mode will turn monitor off.



Monitor On



Reset

You can reset your menu settings to the default settings by turning your radio off and then pressing , , and  at the same time.

Setting the Battery Type

The **SET BATT** feature allows the battery meter to recognize and properly display the power usage for either alkaline or aftermarket rechargeable single-cell nickel cadmium (NiCd) batteries. To set the battery type feature, select the **SETTINGS** mode and then **SET BATT**. Press  or  until your choice of **ALKALINE** or **RECYCLE** appears, then press  to set.

Use and Care



Use a soft cloth moistened with soap and water to clean the exterior.



Do not immerse in water.



Do not use alcohol or cleaning solutions.

If the radio gets wet...



Turn it off and remove batteries.



Dry with soft cloth.



Do not use until completely dry.

Contact Information



Repairs



Warranty



Questions

**1-800-353-2729 (U.S.)
1-800-461-4575 (Canada)**

1-800-739-7834 (TTY)

On the web, please refer to the Two-Way Radio section of www.motorola.com/store



Frequency and Code Charts

The charts on these pages provide frequency and code compatibility information. These charts are useful when using Motorola Talkabout two-way radios with other two-way radios.

T6400 Frequency Chart

Channel Display	Talkabout Distance Channel	Channel Type	Frequency (MHz)	Power (Watts)
1	1	GMRS/FRS	462.5625	1
2	2	GMRS/FRS	462.5875	1
3	3	GMRS/FRS	462.6125	1
4	4	GMRS/FRS	462.6375	1
5	5	GMRS/FRS	462.6625	1
6	6	GMRS/FRS	462.6875	1
7	7	GMRS/FRS	462.7125	1
8		FRS	467.5625	0.5
9		FRS	467.5875	0.5
10		FRS	467.6125	0.5
11		FRS	467.6375	0.5



T6400 Frequency Chart

Channel Display	Talkabout Distance Channel	Channel Type	Frequency (MHz)	Power (Watts)
12		FRS	467.6625	0.5
13		FRS	467.6875	0.5
14		FRS	467.7125	0.5
15		GMRS	462.5500	1
16	A	GMRS	462.5750	1
17		GMRS	462.6000	1
18	B	GMRS	462.6250	1
19		GMRS	462.6500	1
20	C	GMRS	462.6750	1
21		GMRS	462.7000	1
22		GMRS	462.7250	1

Carrier squelch (0) disables interference eliminator codes. The interference eliminator codes help minimize interference by providing you with a choice of code combinations. This allows you to monitor all activity on the channel you are using.

Interference Eliminator Codes

Talkabout Code	Hz Freq	Talkabout Code	Hz Freq	Talkabout Code	Hz Freq
1	67.0	14	107.2	27	167.9
2	71.9	15	110.9	28	173.8
3	74.4	16	114.8	29	179.9
4	77.0	17	118.8	30	186.2
5	79.7	18	123.0	31	192.8
6	82.5	19	127.3	32	203.5
7	85.4	20	131.8	33	210.7
8	88.5	21	136.5	34	218.1
9	91.5	22	141.3	35	225.7
10	94.8	23	146.2	36	233.6
11	97.4	24	151.4	37	241.8
12	100.0	25	156.7	38	250.3
13	103.5	26	162.2		

Troubleshooting

No Power

Reposition or replace alkaline batteries.

Recharge or replace NiMH battery.

Message not transmitted

Make sure  is completely pressed as you transmit.

Reposition, replace, or recharge batteries.

Confirm radios have the same channel and interference eliminator code settings.

Make sure  is not being pressed.

Message not received

Reposition, replace, or recharge batteries.

Quiet6000 feature is on, transmit call tone before talking.

Obstructions and operating indoors, or in vehicles, may interfere -- change location.

Others hear you but you can't hear them	<p>If others are using FRS radios, move closer together.</p> <p>When closer, use channels 8-14 to communicate.</p>
Hearing other noises or conversation on a channel	<p>Confirm interference eliminator code is set.</p> <p>Shared channel or interference eliminator code may be in use, try another.</p>
Message scrambled	<p>Eavesdrop Reducer scramble code is on or setting doesn't match other radios; all radios must use the same scramble code.</p>
Limited talk range	<p>Steel and/or concrete structures, heavy foliage, use in buildings or vehicles decrease range. Check for clear line of sight to improve transmission.</p> <p>Wearing radio close to body such as in a pocket or on a belt decreases range. Change location of radio.</p>
Heavy static or interference	<p>Radios are too close, they must be at least five feet apart.</p> <p>Radios are too far apart or obstacles interfering with transmission.</p>

Channel and/or code locked	Make sure radio is unlocked. See page 27.
Low batteries	Replace alkaline batteries. Recharge or replace NiMH battery. Extreme operating temperatures affect battery life.
Charger LED double flashing	Charger not properly positioned. Reposition charger and ensure it is firmly clamped to the radio, battery, or charging dock. Battery power is very low; battery is charging up slowly before it starts to quick charge.
Cannot activate VOX	Feature not set and on. See page 24.

Motorola Limited Warranty

I. What this Warranty Covers

- Products. Defects in materials and workmanship in wireless cellular telephones, pagers, and/or two-way radios, and certain accessories that are sold with them, such as the battery, battery charger and holster manufactured and/or sold by Motorola (Products).
- Batteries. Defects in materials and workmanship in batteries that are manufactured by Motorola and/or sold with Products are covered by this warranty only if the fully-charged capacity falls below 80% of rated capacity or they leak.
- Software. Physical defects in the media that tangibly embodies each copy of any software supplied with the Products.

II. What the Period of Coverage Is

From the date the Products are purchased by the first end-user:

- Products. The warranty is for one year. Exception: The warranty for Spirit GT series and Talkabout series two-way radio accessories is for 90 days.
- Software. The warranty is for 90 days.
- Repairs / Replacements. The warranty is for the balance of the original warranty or for 90 days from the date you receive it, whichever is longer.

III. Who is Covered

This warranty extends to the first end-user purchaser, only.

IV. What We Will Do to Correct Warranty Problems

At no charge to you, we have the option to repair or replace the Products or software that do not conform to the warranty, or to refund the Products' purchase price. We may use functionally equivalent reconditioned/refurbished/pre-owned or new Products or parts. No software updates are provided.

V. How to Get Warranty Service

Please call:

USA

Cellular	1-800-331-6456
Paging	1-800-548-9954
Two-Way	1-800-353-2729
TTY	1-888-390-6456 (Text Telephone)

Canada

All Products	1-800-461-4575
TTY	1-888-390-6456 (Text Telephone)

You will receive instructions on how to ship the Products to Motorola. You must ship the Products to us with freight, duties and insurance prepaid. Along with the Products you must include: (a) a copy of your receipt, bill of sale or other comparable proof of purchase; (b) a written description of the problem; (c) the name of your service provider (if this Product requires subscription service); (d) the name and location of the installation facility (if applicable) and, most importantly; (e) your address and telephone number. If requested, you must also return all detachable parts such as antennas, batteries and chargers. **RETAIN YOUR ORIGINAL PROOF OF PURCHASE.**

We will ship repaired or replacement Products at our expense for the freight and insurance, but at your expense for any duties. If additional information is needed, please contact us at the telephone number listed above.

VI. What This Warranty Does Not Cover

- Products that are operated in combination with ancillary or peripheral equipment or software not furnished by Motorola for use with the Products (“ancillary equipment”), or any damage to the Products or ancillary equipment as a result of such use. Among other things, “ancillary equipment” includes batteries, chargers, adaptors, and power supplies not manufactured or supplied by Motorola. Any of these voids the warranty.
- Someone other than Motorola (or its authorized service centers) tests, adjusts, installs, maintains, alters, modifies or services the Products in any way. Any of these voids the warranty.

- Rechargeable batteries that: (a) are charged by other than the Motorola-approved battery charger specified for charging such batteries; (b) have any broken seals or show evidence of tampering; (c) are used in equipment other than the Product for which they are specified; or (d) are charged and stored at temperatures greater than 60 degrees centigrade. Any of these voids the warranty.
- Products that have: (a) serial numbers or date tags that have been removed, altered or obliterated; (b) board serial numbers that do not match each other, or board serial numbers that do not match the housing; or (c) nonconforming or non-Motorola housings or parts. Any of these voids the warranty.
- Defects or damage that result from: (a) use of the Products in a manner that is not normal or customary; (b) improper operation or misuse; (c) accident or neglect such as dropping the Products onto hard surfaces; (d) contact with water, rain, extreme humidity or heavy perspiration; (e) contact with sand, dirt or the like; or (f) contact with extreme heat, or spills of food or liquid.
- Physical damage to the surface of the Products, including scratches, cracks or other damage to a display screen, lens or other externally exposed parts.
- Failure of Products that is due primarily to any communication service or signal you may subscribe to or use with the Products.
- Coil cords that are stretched or that have any broken modular tabs.
- Products that are leased.

Flat-rate repair rates may apply to Products not covered by this warranty. To obtain information about Products needing repairs that are not covered by this warranty, please call the telephone number previously listed. We will provide information on repair availability, rates, methods of payment, where to send the Products, etc.

VII. Some Other Limitations

This is Motorola's complete warranty for the Products, and states your exclusive remedies. This warranty is given in lieu of all other express warranties. Implied warranties, including without limitation, the implied warranties of merchantability and fitness for a particular purpose, are given only if specifically required by applicable law. Otherwise, they are specifically excluded.

No warranty is made as to coverage, availability, or grade of service provided by the Products, whether through a service provider or otherwise.

No warranty is made that the software will meet your requirements or will work in combination with any hardware or applications software products provided by third parties, that the operation of the software products will be uninterrupted or error free, or that all defects in the software products will be corrected.

In no event shall Motorola be liable, whether in contract or tort (including negligence) for damages in excess of the purchase price of the Product, or for any indirect, incidental, special or consequential damages of any kind, or loss of revenue or profits, loss of business, loss of information or data, or other financial loss arising out of or in connection with the ability or inability to use the Products, to the full extent these damages may be disclaimed by law.

VIII. Patent and Software Provisions

At Motorola's expense, we will defend you, and pay costs and damages that may be finally awarded against you, to the extent that a lawsuit is based on a claim that the Products directly infringe a United States patent. Our obligation is conditioned on: (a) you notifying us promptly in writing when you receive notice of the claim; (b) you giving us sole control of the defense of the suit and all negotiations for its settlement or compromise; and (c) should the Products become, or in Motorola's opinion be likely to become, the subject of a claim of infringement of a United States patent, you permit us, at our option and expense, either to: procure for you the right to continue using the Products; replace or modify them so that they become non-infringing; or grant you a credit for such Products, as depreciated, and accept their return. The depreciation will be an equal amount per year over the lifetime of the Products, as established by Motorola.

Motorola will have no liability to you with respect to any claim of patent infringement that is based upon the combination of the Products or parts furnished under this limited warranty with ancillary equipment, as defined in VI., above.

This is Motorola's entire liability with respect to infringement of patents by the Products.

Laws in the United States and other countries preserve for Motorola and other third party software providers certain exclusive rights for copyrighted software, such as the exclusive rights to reproduce in copies and distribute copies of such software. The software may be copied into, used in and redistributed with only those Products that are associated with such software. No other use, including without limitation, disassembly or reverse engineering of such software or exercise of exclusive rights in such software is permitted.

IX. State Law and Other Jurisdiction Rights

Some states and other jurisdictions do not allow the exclusion or limitation of incidental or consequential damages, or limitation on the length of an implied warranty, so the above limitations or exclusions may not apply to you.

This warranty gives you specific legal rights, and you may also have other rights, which vary from jurisdiction to jurisdiction.

To obtain information on Motorola Personal Communications Products, including warranty service, accessories and optional Extended Warranties on selected Products, please call:

USA

Cellular **1-800-331-6456**
Paging **1-800-548-9954**
Two-Way **1-800-353-2729**
TTY **1-888-390-6456**
 (Text Telephone)

Canada

All Products **1-800-461-4575**
TTY **1-888-390-6456**
 (Text Telephone)

To correspond with Motorola about the Products, please write us at <http://www.motorola.com/talkabout> or at:

In the USA:











Motorola, Inc.
600 North U.S. Highway 45
Libertyville, IL 60048

In Canada:

Motorola Canada Limited
5875 Whittle Road
Mississauga, ON L4Z 2H4

Motorola® Talkabout® T6400-Series Radio Quick Reference Card:





Icons:

	Battery meter
	Eavesdrop Reducer on
	Lock set
	VOX on
	Channel scan on
<hr/>	
	VibraCall® alert on
channel	One of 22 channels
	Alarm on
code	One of 38 codes
	Ring alert
	Channel in use
	Automatic power off

Standard Features

		STOPWATCH	
Modes →	TWO WAY	TIME	SETTINGS
Menus ↓	SET CHAN	SET TIME	SETQUIET
	SET CODE	SETALARM	SET VID
	SETSCRAM	ALARMTIME	SETROGER
	SET CALL	SET DISP	SETWRDN
	SET MON		SETBEEPS
	SET SCAN		SET VOX
	SCANLIST		

Buttons

- ① • Turn power on/off
- Scroll through mode selections
- MODE • Return to two-way mode (when held down while in a menu)
- Transmit call tone
- Start and stop stopwatch
-  • Talk on the radio
- Save a setting
- Scroll through menus
-  • Lock the keypad (when held down and not in a menu)
-  • Change the volume
- or
-  • Scroll through and select settings

Software Copyright Notice

The Motorola products described in this manual may include copyrighted Motorola and third party software stored in semiconductor memories or other media. Laws in the United States and other countries preserve for Motorola and third party software providers certain exclusive rights for copyrighted software, such as the exclusive rights to distribute or reproduce the copyrighted software. Accordingly, any copyrighted software contained in the Motorola products may not be modified, reverse-engineered, distributed, or reproduced in any manner to the extent allowed by law. Furthermore, the purchase of the Motorola products shall not be deemed to grant either directly or by implication, estoppel, or otherwise, any license under the copyrights, patents, or patent applications of Motorola or any third party software provider, except for the normal, non-exclusive, royalty-free license to use that arises by operation of law in the sale of a product.

Patent Notice

This product is covered by one or more of the following United States patents.

5896277	5894292	5864752	5699006	5742484	D408396	D399821	D387758
D389158	5894592	5893027	5789098	5734975	5861850	D395882	D383745
D389827	D389139	5929825	5926514	5953640	6071640	D413022	D416252
D416893							

Export Law Assurances

EXPORT LAW ASSURANCES: This product is controlled under the export regulations of the United States of America and Canada. The Governments of the United States of America and Canada may restrict the exportation or re-exportation of this product to certain destinations. For further information contact the U.S. Department of Commerce or the Canadian Department of Foreign Affairs and International Trade.

- **Up to 5-mile range**
*Range will vary based on terrain and conditions
- **22 Channels including 8 GMRS 7 GMRS/FRS (shared), and 7 FRS, each with 38 codes**
First Motorola GMRS/FRS two-way radio to feature 22 channels. GMRS channels feature increased power for longer range; 14 FRS channels ensure backward compatibility with FRS two-way radios. 38 interference eliminator codes per channel help minimize interference from other groups.
- **Motorola Quality**
Shock/drop/temperature tested to meet Motorola's High standards.
- **Digital Audio Processing**
Provides crisper audio quality
- **1-Year Limited Warranty**
For details, call 1-800-353-2729
- **Illuminated Display - Easy to read**

- **Voice Compression Technology**
For better sound at longer distances.
- **Helical Antenna**
Helps maximize talk range
- **Talk Hands-Free (VOX/iVOX)**
Advanced voice activation lets you talk hands-free.
- **VibraCall® Alert**
Vibrate alert, perfect privacy to signal an incoming call
- **Eavesdrop Reducer**
Helps enhance privacy.
- **Quiet6000™**
Helps reduce outside group disturbance/ring tones/conversation
- **Built-in Clock, Alarm, Stopwatch**
Features work when the radio is off
- **Signal Strength Indicator**
Visual indicator lets you know when other radios are heading out of range while you're communicating
- **Batteries (not included)**
Requires only 3 AA alkaline batteries or 1 NiMH rechargeable battery
- **"Roger" Beep**
Signals you're done talking

T6400 Radio Specification Chart

Transmit Power	1 W GMRS; .5 W FRS (typical)
Receiver Sensitivity	0.18uV
Audio Output	500 mW
Receiver Technology	Digital Direct Conversion - DZIF

- **Accessories for T6400 series - Convenient headphones, some with hands-free talk capabilities, mesh and waterproof carry cases, and rechargeable battery packs available from your retailer or www.motorola.com**

MOTOROLA, the Stylized M Logo, TALKABOUT, and all other trademarks indicated as such herein are trademarks of Motorola, Inc. ® Reg. U.S. Pat. & Tm. Off. All other product or service names are the property of their respective owners. © 2001 Motorola, Inc. All rights reserved. Printed in the U.S.A.

Motorola® Talkabout® T6400



Proof of Purchase

FCC GMRS
License required.

⚠ WARNING CHOKING HAZARD
SMALL PARTS

Not for children under 3 years.
This product is not intended to be used
as a toy or plaything.