



MOTOROLA
TALKABOUT®
TWO-WAY RADIO



6864110R94-O

Models T7100 and T7200

Introduction

Congratulations on your purchase of a Motorola Product!

Product registration is an important step toward enjoying your new Motorola Product. Registering helps us facilitate warranty service, and permits us to contact you should your Motorola Product require an update or other service. Registration is not required for warranty coverage. To register your product on-line, visit www.motorola.com/warranty/radios.

Please retain your original dated sales receipt for your records. For warranty service of your Motorola Personal Communications Product you will need to provide a copy of your dated sales receipt to confirm warranty status.

Product Specifications

Frequency	UHF 462.550-467.7250 MHz
Channels	22 T7100 30 T7200
Codes	38 CTCSS
Channel Spacing	12.5/25kHz Consumer selectable when FCC permits
Power Source	1 NiMH Battery pack or 4 AA Alkaline

Motorola, the Stylized M Logo, and all other trademarks indicated as such herein are trademarks of Motorola, Inc.

® Reg. U.S. Pat. & Tm. Off.

© 2002 Motorola, Inc. All rights reserved. Printed in the U.S.A.

Motorola
Consumer Products Division
1705 Belle Meade Court
Lawrenceville, GA 30043

For a copy of a large-print version of this guide, or for product-related questions, please call the following numbers:

1-800-353-2729 (U.S.A.)
1-800-461-4575 (Canada)
1-888-390-6456 TTY (Text Telephone)

On the web, please refer to the following url:
www.motorola.com/talkabout

Contents

Safety and General Information	1
FCC Licensing Information	9
Getting Started	11
Turning On/Off Your Radio	11
Diagram of Your Radio's Display	12
Installing Batteries	13
Charging	15
Diagram of Your New Talkabout	18
Operating Your T7000-Series Radio 19	
Talking Range	19
Changing Your Radio's Settings	20
Accessing the Backlight	21
Lock	21
Checking Monitor/ Signal Strength Indicator	21
"Roger" Beeps/ Talk Confirmation Tone	22
Button Beeps	22
Changing Settings	23
Setting the Channel	23
Interference Eliminator Code	23
Eavesdrop Reducer (T7200 Only)	24
Call Tone	24

Microphone Gain	25
Hands-Free Use/VOX	25
Scanning	27
Setting the Battery Type	28
Battery Life	29
Menu Functions	30
Advanced Features	33
Selecting Bandwidth	33
Advanced Features (T7200)	34
Understanding Repeater Channels	34
Setting Repeater Channels	35
Interference Eliminator Codes	35
Scanning Repeater Channels	36
Weather (T7200)	37
Turning On Weather Channel Reception	37
Setting the Weather Channel	38
Using Accessories	39
Use and Care	41
Frequency and Code Charts	42
Troubleshooting	45
Motorola Limited Warranty	48

SAFETY AND GENERAL INFORMATION

IMPORTANT INFORMATION ON SAFE AND EFFICIENT OPERATION READ THIS INFORMATION BEFORE USING YOUR RADIO

The information provided in this document supersedes the general safety information contained in user guides published prior to July 2000. For information regarding radio use in a hazardous atmosphere please refer to the Factory Mutual (FM) Approval Manual Supplement or Instruction Card, which is included with radio models that offer this capability.

Transmit and Receive Procedure

Your two-way radio contains a transmitter and a receiver. To transmit (talk), you must push the Push-to-Talk button; to receive (listen), release the Push-to-Talk button.

Exposure To Radio Frequency Energy

Your Motorola radio is designed to comply with the following national and international standards and guidelines regarding exposure of human beings to radio frequency electromagnetic energy:

- United States Federal Communications Commission, Code of Federal Regulations; 47 CFR part 2 sub-part J

- American National Standards Institute (ANSI) / Institute of Electrical and Electronic Engineers (IEEE) C95. 1-1992
- Institute of Electrical and Electronic Engineers (IEEE) C95.1-1999 Edition
- National Council on Radiation Protection and Measurements (NCRP) of the United States, Report 86, 1986
- International Commission on Non-Ionizing Radiation Protection (ICNIRP) 1998
- Ministry of Health (Canada) Safety Code 6. Limits of Human Exposure to Radiofrequency Electromagnetic Fields in the Frequency Range from 3 kHz to 300 GHz, 1999
- Australian Communications Authority Radiocommunications (Electromagnetic Radiation - Human Exposure) Standard 1999 (applicable to wireless phones only)

To assure optimal radio performance and make sure human exposure to radio frequency electromagnetic energy is within the guidelines set forth in the above standards, always adhere to the following procedures:

PORTABLE RADIO OPERATION AND EME EXPOSURE

Antenna Care

Use only the supplied or an approved replacement antenna.

Unauthorized antennas, modifications, or attachments could damage the radio and may violate FCC regulations.

DO NOT hold the antenna when the radio is “IN USE.” Holding the antenna affects call quality and may cause the radio to operate at a higher power level than needed.

Two-way Radio Operation

When using your radio as a traditional two-way radio, **hold the radio in a vertical position with the microphone one to two inches (2.5 to 5 cm) away from the lips.**

Body-worn Operation

To maintain compliance with FCC/Health Canada RF exposure guidelines, if you wear a radio on your body when transmitting, always place the radio in a Motorola supplied or approved clip, holder, holster, case, or body harness for this product. Use of non-Motorola-approved accessories may exceed FCC/Health Canada RF exposure guidelines. If you do not use one of the Motorola-supplied or approved body-worn accessories, and are not using the radio held in the normal use position, **ensure the radio and its antenna are at least one inch (2.5 cm) from your body when transmitting.**

Data operation

When using any data feature of the radio, with or without an accessory cable, **position the radio and its antenna at least one inch (2.5 cm) from the body.**

Approved Accessories

For a list of approved Motorola accessories visit our website at www.mot.com.

ELECTROMAGNETIC INTERFERENCE/COMPATIBILITY

Note: Nearly every electronic device is susceptible to electromagnetic interference (EMI) if inadequately shielded, designed or otherwise configured for electromagnetic compatibility.

- **FACILITIES**

To avoid electromagnetic interference and/or compatibility conflicts, turn off your radio in any facility where posted notices instruct you to do so. Hospitals or health care facilities may be using equipment that is sensitive to external RF energy.

- **AIRCRAFT**

When instructed to do so, turn off your radio when on board an aircraft. Any use of a radio must be in accordance with applicable regulations per airline crew instructions.

- **MEDICAL DEVICES**

Pacemakers

The Advanced Medical Technology Association recommends that a minimum separation of 6 inches (15 centimeters) be maintained between a handheld wireless radio and a pacemaker. These recommendations are consistent with the independent research by, and recommendations of, the United States Food and Drug Administration.

Persons with pacemakers should:

- ALWAYS keep the radio more than six inches (15 centimeters) from their pacemaker when the radio is turned ON.
- not carry the radio in the breast pocket.
- use the ear opposite the pacemaker to minimize the potential for interference.
- turn the radio OFF immediately if you have any reason to suspect that interference is taking place.

Hearing Aids

Some digital wireless radios may interfere with some hearing aids. In the event of such interference, you may want to consult your hearing aid manufacturer to discuss alternatives.

Other Medical Devices

If you use any other personal medical device, consult the manufacturer of your device to determine if it is adequately shielded from RF energy. Your physician may be able to assist you in obtaining this information.

Safety and General Use While Driving

Check the laws and regulations on the use of radios in the area where you drive. Always obey them.

When using your radio while driving, please:

- Give full attention to driving and to the road.
- Use hands-free operation, if available.
- Pull off the road and park before making or answering a call if driving conditions so require.

OPERATIONAL WARNINGS

• FOR VEHICLES WITH AN AIR BAG

Do not place a portable radio in the area over an air bag or in the air bag deployment area. Air bags inflate with great force. If a portable radio is placed in the air bag deployment area and the air bag inflates, the radio may be propelled with great force and cause serious injury to occupants of the vehicle.

- **POTENTIALLY EXPLOSIVE ATMOSPHERES**

Turn off your radio prior to entering any area with a potentially explosive atmosphere, unless it is a radio type especially qualified for use in such areas as “Intrinsically Safe.” Do not remove, install, or charge batteries in such areas. Sparks in a potentially explosive atmosphere can cause an explosion or fire resulting in bodily injury or even death.

Note: The areas with potentially explosive atmospheres referred to above include fueling areas such as below decks on boats, fuel or chemical transfer or storage facilities, areas where the air contains chemicals or particles, such as grain, dust or metal powders, and any other area where you would normally be advised to turn off your vehicle engine. Areas with potentially explosive atmospheres are often but not always posted.

- **BLASTING CAPS AND AREAS**

To avoid possible interference with blasting operations, turn off your radio when you are near electrical blasting caps, in a blasting area, or in areas posted: “Turn off two-way radio.” Obey all signs and instructions.

OPERATIONAL CAUTIONS

- **ANTENNAS**

Do not use any portable radio that has a damaged antenna. If a damaged antenna comes into contact with your skin, a minor burn can result.

- **BATTERIES**

All batteries can cause property damage and/or bodily injury such as burns if a conductive material such as jewelry, keys, or beaded chains touch exposed terminals. The conductive material may complete an electrical circuit (short circuit) and become quite hot. Exercise care in handling any charged battery, particularly when placing it inside a pocket, purse, or other container with metal objects.

BATTERY CHARGER SAFETY INSTRUCTIONS

Save these Charger Instructions

1. Do not expose the charger to rain or snow.
2. Do not operate the charger if it has received a sharp blow, or has been dropped or damaged in any way.
3. Do not disassemble the charger if it has received a sharp blow, or has been dropped or damaged in any way.
4. Never alter the AC cord or plug provided with the unit. If plug will not fit the outlet, have proper outlet installed by a qualified electrician. An improper condition can result in a risk of electric shock.
5. To reduce risk of damage to cord or plug, pull the plug rather than the cord when disconnecting charger from AC receptacle.
6. To reduce the risk of electric shock, unplug the charger from the outlet before attempting any maintenance or cleaning.
7. Use of an attachment not recommended or sold by Motorola may result in a risk of fire, electric shock, or personal injury.

8. Make sure that the cord is located so that it will not be stepped on, tripped over, or subjected to damage or stress.
9. An extension cord should not be used unless absolutely necessary. Use of an improper extension cord could result in a risk of fire and/or electric shock. If an extension cord must be used, make sure:
 - That the pins on the plug of the extension cord are the same number, size and shape as those on the plug of the charger.
 - That the extension cord is properly wired and in good electrical condition, and
 - That the cord size is 18 AWG for lengths up to 100 feet, and 16 AWG for lengths up to 150 feet.
10. The supply cord of this charger cannot be replaced. If the cord is damaged, call Motorola Product Services at:
 - 1-800-353-2729 (U. S. A.)
 - 1-800-461-4575 (Canada)
 - 1-888-390-6456 TTY (Text Telephone)

FCC Licensing Information

Your Motorola radio operates on General Mobile Radio Service (GMRS) frequencies and is subject to the Rules and Regulations of the Federal Communications Commission (FCC). The FCC requires that all operators using General Mobile Radio Service (GMRS) frequencies obtain a radio license before operating their equipment. To obtain the FCC forms please request Form **605** which includes all forms and instructions. If you wish to have the document faxed, mailed or have questions, please use the following contact information.

Faxed Contact the Fax-On- Demand system at:	Mailed Call the FCC forms hotline at:	Questions regarding FCC license Contact the FCC at:
1-202-418-0177	1-800-418-FORM 1-800-418-3676	1-888-CALL-FCC 1-888-225-5322 Or: http://www.fcc.gov

See the Frequency and Code Charts on page 42. For questions on determining your radio frequency, please call Motorola Product Services at:

1-800-353-2729

Changes or modifications not expressly approved by Motorola may void the user's authority granted by the FCC to operate this radio and should not be made. To comply with FCC requirements, transmitter adjustments should be made only by or under the supervision of a person certified as technically qualified to perform transmitter maintenance and repairs in the private land mobile and fixed services as certified by an organization representative of the user of those services. Replacement of any transmitter component (crystal, semiconductor, etc.) not authorized by the FCC equipment authorization for this radio could violate FCC rules.

Note: Use of this radio outside the country where it was intended to be distributed is subject to government regulations and may be prohibited.

Getting Started

Turning On/Off Your Radio

Turn Knob	Display	Normal Menu Mode
-----------	---------	------------------



Turn Knob on the top of the radio clockwise to use. Turn the Knob counterclockwise to turn the radio Off. The radio chirps and displays all feature icons that your radio has available for approximately one second.

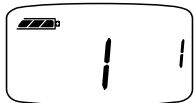

Depending upon your radio model; T7100 will have the Channel 1-22 and the Interference Eliminator Code (0-38) left on display. Previous usage dictates Interference Eliminator Code.

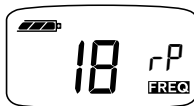

For T7200 the Channel 1-22 and/or Repeater Channel 15 r^P - 22 r^P will be left on display.

A Diagram of your New T7000-Series Radio and its Functions is on page 18.

Note: The red indicator light under the antenna flashes every three seconds, unless it has been disabled as described on page 20.

Diagram of Your Radio's Display

NORMAL USE FOR ALL MODELS

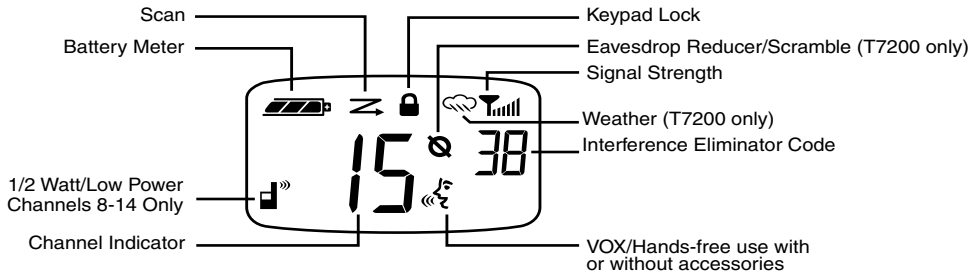

T7200 ONLY WITH REPEATER ENABLED

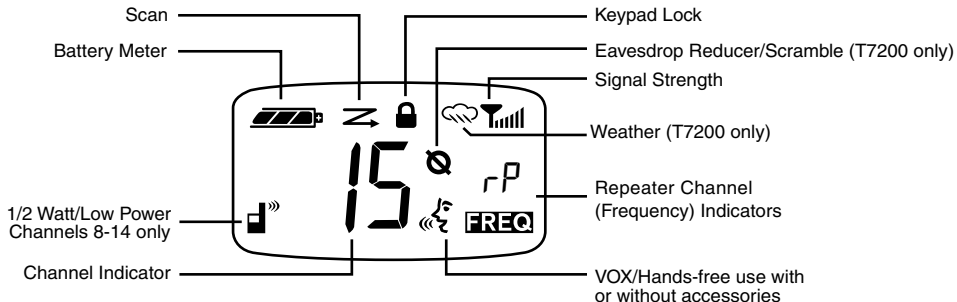

Installing Batteries

Some radio packages include a rechargeable Nickel-Metal Hydride (NiMH) battery (NTN8971 or NNTN4190), or you may use 4 AA Alkaline batteries. If you would like to obtain the battery, the charger or the Rechargeable Upgrade Kit (Accessory 53897), please call the following numbers to locate the dealer nearest you:

(U.S.A.) 1-800-353-2729

(Canada) 1-800-461-4575

You may also obtain accessory items via Motorola's Talkabout website:

www.motorola.com/talkabout

NiMH Battery Installation

Your radio uses one rechargeable Nickel-Metal Hydride Battery pack (Motorola part numbers NTN8971 or NNTN4190). These cells provide 13 hours of radio use; Based upon 5/5/90 duty cycle (5% Transmit, 5% Receive, 90% Standby).

- To begin, slide the Ribbed Latch on the bottom of the radio away from the back cover, or toward the contacts.

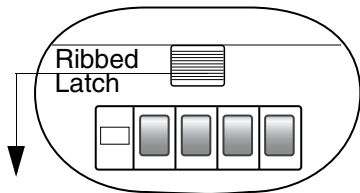

- Slide and lift the back cover off.
- Position the battery with the Motorola Logo side up, and the charge contacts are facing the bottom of the radio. Insert the top of the battery into the radio and push the battery up and into the battery compartment to fit tightly into place.
- Slide and snap the cover back into place

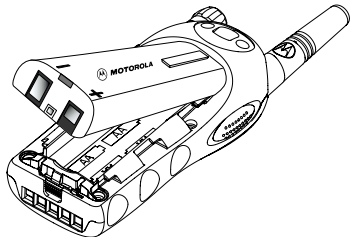

AA Alkaline Batteries Installation

Your radio also uses 4 AA alkaline batteries. These cells provide 22 hours of radio use; Based upon 5/5/90 duty cycle.

- Push the Ribbed Latch on the bottom of the radio away from the battery door.
- Slide and lift the battery door off.
- Place AA batteries so that the + markings match the markings in the compartment.
- Slide and snap the battery cover into place.

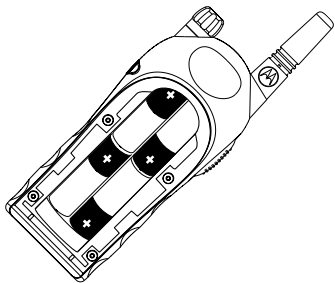

Charging

The NiMH Battery with Plug-in Charger Part No. NNTN4078

- Make sure NiMH battery (Motorola part numbers NNTN8971 or NNTN4190) is left inside the radio.
- Make sure the radio is Off.
- Plug the charger into an electric outlet.
- Lift Accessory cover and plug the Charger firmly into the jack socket. Please see figure.

Note: The light on the charger will glow red continuously while charging. Charge the battery overnight (16 hours) before using it for the first time. It will need up to ten (10) hours of charging thereafter. For optimum battery life, the battery must not be left charging for prolonged periods after reaching full charge. If radio is On while charging, additional time is required to charge the battery.

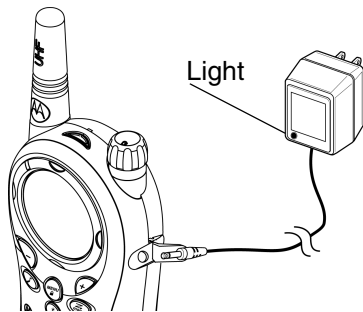

The approved NiMH Battery-pack (NNTN8971 or NNTN4190) and Plug-in Charger (NNTN4078) are included in the T7000 Series Rechargeable Upgrade Kit (53897).

The approved NiMH Battery-pack is included in the NiMH Rechargeable Battery Accessory Package (53871).

With Standard Drop-In Charging Tray

The Drop-In Charging Tray can be placed on any flat surface and provides drop-in charging convenience.

- Connect Plug-in Charger and Drop-In Charging Tray by inserting the pin into the rear of Drop-In Charging Tray. The charger pin does not have to be plugged in all the way to function properly. Insert the pin as far as possible, then stop.
- To charge the battery, drop the radio into the Drop-In Charging Tray with the front of the radio facing toward you.

Note: The battery (Motorola part numbers NNTN8971 or NNTN4190) can be charged while inside the radio or separately. The battery's silver contacts must face down and the Motorola Logo must face the front of Charger.

The light on the Plug-in Charger will glow continuously when radio/battery is inserted.

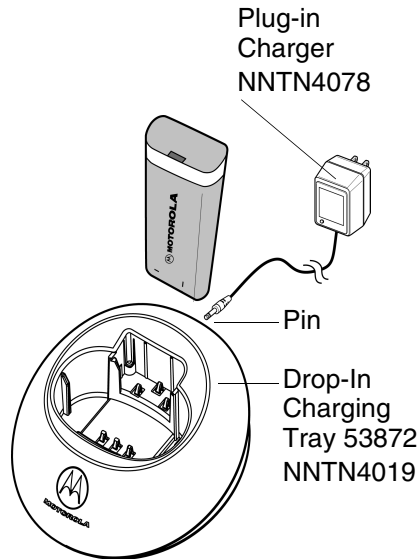

Note: Allow up to 10 hours for the battery to reach full charge.

With Rapid Drop-In Charging Tray

The Drop-In Charging Tray can be placed on any flat surface and provides drop-in charging convenience.

- Connect Plug-in Charger and Drop-In Charging Tray by inserting the pin into the rear of Drop-In Charging Tray.
- To charge the battery, drop the radio into the Drop-In Charging Tray with the front of the radio facing toward you.

Note: The battery (Motorola part numbers NNTN8971 or NNTN4190) can be charged while inside the radio or separately. The battery's silver contacts must face down and the Motorola Logo must face the front of Charger.

The light on the Plug-in Charger will glow continuously when radio / battery is inserted.

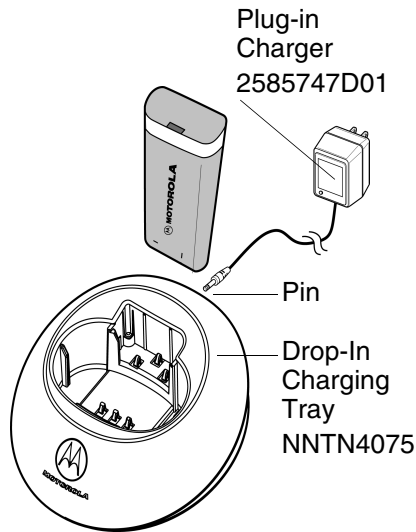

Note: Allow up to 2 hours for the battery to reach full charge.

The Rapid Charger is packaged as an Accessory Kit (Part No. 53875).

Diagram of Your New Talkabout T7000 Series Radio and its Functions

Indicator Light

Use  to
Talk
Exit a menu

Use  to
Transmit Call Tone

Use  to
Turn on Backlight
(short press)
Press and hold to
switch between
Weather Mode & Two-
way Mode
(T7200 only)

Microphone

Speaker

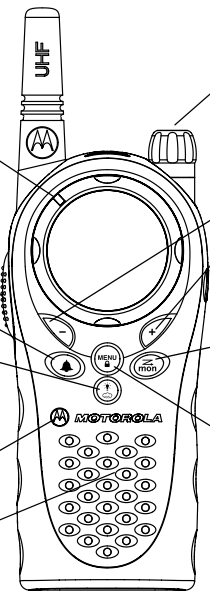

Use  (Power) to
Turn power On/Off
Adjust volume to talk on
your radio

Use  and  to
Scroll through menu settings
Change Channels

Accessory cover/flap



Use  to
Turn Scan On/Off
(Short press.)
Monitor the Frequency
(Long press.)

Use  to
Scroll through menus
Lock the keypad
(when held down
& not in a menu)

Operating Your T7000-Series Radio

Note: The microphone is located on the front of your radio, please refer to the diagram on page 18.



- Press and hold .
- Talk two-to-three inches away from the microphone.
- When you're finished talking, release .

While transmitting, the red indicator light located just below the antenna on the left front of the radio, glows, unless the Indicator Light has been disabled as described on page 20.

Talking Range



Optimal Range

Flat, open areas

- **Outdoor**



Medium Range

Buildings or trees

- **Outdoor**

Also near residential
buildings



Minimal Range

Dense foliage or mountains























- **Outdoor**

Also inside some buildings

- **Indoor**

Changing Your Radio's Settings through Button Combinations



Note: The following table lists the functions you can set by pressing and holding specific key combinations while turning your radio to the On position: 

Key(s) Pressed	Function
  	Reset factory settings by holding down for three seconds.
 	Enable VOX/Hands-free use without accessories.
 	Turns "Roger" Beeps/Talk Confirmation Tone, On or Off.
 	Turns Audible Button Beeps On or Off.
 	Disable backlight so it lights up when pressing  . The Indicator Light is also disabled. Enable backlight so it lights up at any press of a button. The Indicator Light is also enabled. <i>Please refer to page 21.</i>
  	Enable/Disable Repeater Channels by holding down  and  for three seconds. (T7200 only)
  	Select bandwidth between 12.5 kHz and 25 kHz. Does not apply to Channels  -  .









Note: For more specific information regarding Menu/ Button Combinations, please refer to Menu Functions on page 30.

Accessing the Backlight



Your radio has a Backlight that turns On automatically any time you press a front button. The Backlight turns Off automatically five seconds after you last pressed a front button.



- By pressing and holding  as you turn your radio On, you can disable the backlight.
- To return to normal Backlight operation, turn your radio Off and then back On while pressing and holding .





Lock

- To avoid accidentally changing radio operation, press  for three seconds. Now you will see .
- The Lock Feature locks ,  and , Weather (T7200 only), and Scan functions. When the keypad is locked you can still adjust the volume, transmit , send a Call Tone , and monitor  (Long Press).
- To unlock, press  for three seconds.

Checking Monitor/Signal Strength Indicator

 allows you to listen to all activity on a Channel to tell whether the Channel is currently in use.  can also help you determine when a radio is moving out of range.



- To check for Channel activity, press and hold  for three seconds, then release. You'll hear static if the Channel is clear and  will display. To avoid interrupted conversation, wait until the Channel is clear or switch to another Channel. To stop monitoring, briefly press  and release.

The  helps you determine when a radio is moving out of range by displaying a receive signal-strength value next to the  while you press and hold . This value from  (weakest) through  (strongest) indicates the relative strength of the incoming signal.





Note: Obstacles that block the signal path affect the strength of the incoming signal.

“Roger” Beeps/Talk Confirmation Tone

When you turn this feature On, your two-way radio transmits a unique tone when you finish transmitting. It’s like saying “Roger” or “Over” and lets others know you’re finished talking. If the person you are talking to does not hear the talk confirmation tone, you can enable it by pressing and holding  as you turn On your radio. Now, whenever you release , you let your friends know you’re finished talking by transmitting a “Roger” Beep tone. “Roger” Beeps will be disabled as the Default Setting.



Note: To toggle the Talk Confirmation Tone feature, turn your radio Off and then back On while pressing and holding .

Button Beeps

Every time you press a button on the front of your radio, it beeps unless you turn Button Beeps Off. To turn Button Beeps Off, turn your radio On while you press and hold . To turn Button Beeps back On, turn the radio Off and then back On again while you press and hold . Button Beeps will be turned On, out of the factory. On is the Default setting.

Changing your Radio's Settings

Setting the Channel

- Turn radio On.
- Press  or  to select Channel.



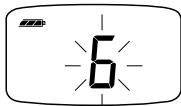

Note: The red indicator light below the antenna on the left front of the radio flashes every second when the Channel is in use.

To set Repeater Channels (T7200 only), please refer to Setting Repeater Channels on page 35.



Setting the Interference Eliminator Code







The Interference Eliminator Code helps minimize interference by providing you with a choice of code combinations.

- Turn radio On.
- To set, press  once the Code display begins to flash.
- Then press  or  to choose the Code.
- Press  to exit this menu.



Note: To hear everyone on your Channel, select Interference Eliminator Code .

You can specify a different Interference Eliminator Code for each Channel.

- To set a Channel and Code combination, press  or  to select the Channel.
- Press  and then press  or  to select a Code.
- To exit the menu, press .
- To set another Channel and Code combination, repeat these steps.

Note: To set your Repeater Interference Eliminator Code (T7200 only), please refer to Setting Repeater Interference Eliminator Codes on page 35.



Setting Eavesdrop Reducer (T7200 Only)



Your radio has the Eavesdrop Reducer feature, a scramble code that makes your transmissions sound garbled to anyone listening without the same Code. It doesn't guarantee secrecy, but it adds an extra layer of privacy.

Note: All the radios have to be set to the same Scramble Code for transmission to be clear.







- Turn radio On.
- To turn the Eavesdrop Reducer feature On, press as needed until is displayed.
- Then press or to choose the Code.
- Select Code -. Factory Default is set on , which means that the feature is Off.
- When you exit by pressing , radio displays .
- To turn the Eavesdrop Reducer feature Off, press as needed until is displayed, then select or until appears.
- Then press to exit.



Setting the Call Tone

Your radio can transmit different individual call tones to other radios in your group so you can alert the group that you want to talk to them. There are ten distinct individual call tones to choose from and you can also turn Call Tones Off by selecting Call Tone . Once selected, press to transmit the Call Tone to others.

To set your Call Tone:

- Turn radio On.
- Press  as needed to display: .
- You can press  or  to scroll through the available call tones.

The radio plays a sample of each individual Call tone as you scroll through them.

- The default is set on , or you may choose  - .

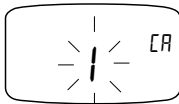

Microphone Gain

The sensitivity of your radio's microphone can be adjusted to fit different users or operating environments. Please refer to page 26.

Hands-Free Use/VOX

With Compatible VOX Accessories

- Turn radio Off.
- Open Accessory Cover.
- Insert plug of audio accessory firmly into Accessory Jack.
- Turn radio On. Radio will display: .
- Lower radio volume BEFORE placing accessory on head or in ear.
- To transmit, speak into Accessory Microphone and to receive, stop talking.
- VOX operation can be disabled by pressing  or removing audio accessory.

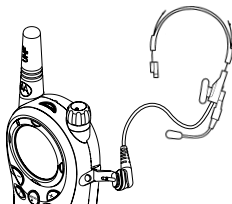



Note: There is a short delay between when you start talking and the radio transmits.

To order accessories, please refer to: www.motorola.com/talkabout

Without Accessories

- Enable VOX by pressing while turning the radio On.
- VOX operation can be temporarily disabled by pressing , will flash.
- A short press of will re-enable VOX. will be displayed (not flashing).

Note: There is a short delay between when you start talking and the radio transmits.

Setting Sensitivity Level

Adjusting your radio's Sensitivity Level helps minimize the possibility of unintended noises triggering a transmission, or enhances the ability to pick up quiet voices.

- Press as needed to display . The radio will also display the sensitivity type you are setting:
 - = Microphone Gain
 - = External VOX (with audio accessory) - appears if a VOX-capable audio accessory is inserted and VOX is enabled.
 - = Internal VOX (without accessory) - appears if internal VOX is enabled.





- Select Sensitivity Level of , , or by using or :
 - = **High Sensitivity**, for quiet environments
 - = **Medium Sensitivity**, for most environments
 - = **Low Sensitivity**, for noisy environments

Note: There is a short delay between when you start talking and the radio transmits.

Scanning

By using , you can monitor Channels and Codes for transmissions and lock in on the one that interests you. More importantly, you can find someone in your group who has accidentally changed Channels and is talking during your scan. You don't have to set a new Channel or Code, the radio just resets itself temporarily to that Channel and Code and you can start talking.



- To start scanning, briefly press .

Your Channel/Code screen displays  and begins to scroll through Channels. When the radio detects channel activity, it stops on that channel and displays its Channel and Code. You can talk to the person(s) transmitting without having to switch Channels by pressing .

- To stop scanning, briefly press .

If you press  while the radio is scanning, the radio will transmit on the Channel which was selected before you activated Scan.

If no transmission occurs within five seconds, scanning will resume.

If you want to scan channels without Interference Eliminator Codes, change the Code for your set Channel to  before you briefly press .

Note: To Scan Repeater Channels (T7200 only), refer to page 36.

Scan Manual Advance

If Scan stops on a Channel that you don't want, briefly press  to resume scanning for the next active Channel in the Scan List.







Scan Nuisance Delete

If Scan continuously stops on an undesired Channel, briefly press . This will temporarily remove the undesired Channel from being scanned. To restore the deleted Channel, turn Scan Off by pressing , then turn Scan back On by pressing  again.

Note: Your Home Channel is the Channel your radio was set to when you activated Scan. You cannot Nuisance Delete your Home Channel.

Editing Scan List











Scan List is changed by pressing  until  displays.

- The flashing Channel will appear on the display with a flashing  or .
- Press  or  to increase or decrease the Channel.
- Pressing  will change the Scan List to include  or exclude  that particular Channel.

Note: Your home Channel will be scanned even if it is deleted from the Scan List.

Setting the Battery Type



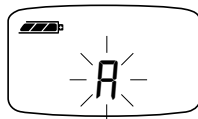

Note: Battery type needs to be set when non Motorola batteries are used. However, if you use the Motorola NiMH battery, the battery type menu will not display because your radio automatically detects the type of battery.



- Selecting the battery type, allows the battery meter to recognize and properly display the power usage for single-cell batteries.
- First, press  until  displays. Either  (Alkaline) or  (NiMH or NiCd rechargeable) is blinking.
- Press  or  until your choice of  or  displays.
- Then press  or  to exit.



Battery Meter

The battery meter located in the upper left corner of the display indicates how much battery power you have.

				
NiMH %	100-85	85-25	25-10	Final 10
Alkaline %	100-70	70-40	40-10	Final 10

The radio will power off when the voltage drops below a pre-determined level in order to protect the rechargeable battery. When the battery meter flashes; , the radio chirps after releasing  and every 5 minutes.

Battery Life

The following chart lists the appropriate battery life during Two-way Use* for Alkaline and NiMH batteries.

Battery Type	Two-way Use*
AA Alkaline (High Capacity)	22 Hours
Motorola NiMH Battery-pack	13 Hours

*Two-way Use is defined as 90% standby time, 5 % talk time, and 5% receive time.

Note: Use of Scan, VOX, Weather and other features may reduce Battery Life.



Menu Functions

Radio Model	Press	To
T7100	or one time	Change the Channel. <i>Please refer to page 23.</i>
	one time	Change the Interference Eliminator Code. <i>Please refer to page 23.</i>
	two times	Change the Call Tone (10 to choose from). Choose if you want to turn Call Tone Off. <i>Please refer to page 24.</i>
	three times	Sensitivity Level selection. <i>Please refer to Setting Sensitivity Level on page 26.</i>
	four times	Select (yes) or (no) for each Channel you want to keep or delete from your Scan List. <i>Please refer to page 27.</i>
	five times	Choose Battery setting type for alkaline, for rechargeable cells. <i>Please refer to page 28.</i> Note: This menu will not appear if the radio detects a Motorola rechargeable pack.

Menu Functions



Radio Model	Press	To
T7200	or one time	Change the Channel. <i>Please refer to page 23.</i> Can scroll through Repeater Channels after basic powerup sequence. <i>Please refer to Setting Repeater Channels on page 35.</i>
	one time	Choose the Interference Eliminator Code. <i>Please refer to Setting the Interference Eliminator Code on page 23.</i>
	two times	Choose Eavesdrop Reducer Code (0-3). <i>Please refer to Setting Eavesdrop Reducer (T7200 Only) on page 24.</i>
	three times	Change the Call Tone (0-10). <i>Please refer to Setting the Call Tone on page 24.</i>
	four times	Sensitivity Level selection. <i>Please refer to Setting Sensitivity Level on page 26.</i>



Menu Functions

Radio Model	Press	To
T7200	five times	Select <i>Y</i> (yes) or <i>n</i> (no) for each Channel you want to keep or delete from your Scan List. <i>Please refer to Scanning on page 27.</i>
	six times	Choose Battery setting type <i>A</i> for alkaline, <i>n</i> for rechargeable cells. <i>Please refer to page 28.</i> Note: This menu will not appear if the radio detects a Motorola rechargeable pack.

Advanced Features (T7100 and T7200)



Selecting Bandwidth

All Channels on your T7100 and/or T7200 GMRS radios are set to 12.5 kHz out of the factory:



FRS/GMRS	GMRS Direct	GMRS Repeater	FRS
1-7	15-22	15 r ^P - 22 r ^P If repeater operation is enabled. (T7200 only)	8-14 Permanently locked to 12.5 kHz on a 1/2 watt of power. You cannot change this setting.

By being set to 12.5 kHz bandwidth, your radio can communicate clearly with the Motorola T6400 GMRS radio and any FRS radio in your group.

You must match your radio's bandwidth to that of the other radios in your group. To match your bandwidth to that of the GMRS radios that you want to talk to at 25 kHz, you must set your radio to 25 kHz. To do this:

- Turn your radio Off.
- Turn your radio back On while pressing  and .
- A triple power-up chirp will sound indicating that your radio is now set to 25 kHz bandwidth on all GMRS Channels, if Button Beeps are enabled.
- Now you can talk to Motorola Talkabout Distance GMRS radios.
- All Channels except 8-14 are now set to 25 kHz.

To return to 12.5 kHz bandwidth:

- Turn your radio Off.
- Turn your radio back On while pressing  and .
- A single power-up chirp will sound indicating that your radio is now set to 12.5 kHz bandwidth on all Channels, if Button Beeps are enabled.

Advanced Features (T7200)

Understanding Repeater Channels

If you have a GMRS Repeater and wish to use it, you must set your T7200 to repeater mode. Those Channels are identified on the display by having both r^P in the Interference Eliminator Code area and **FREQ** at the bottom right of the display. They are identified as channels 15 r^P - 22 r^P .



To enable Repeater Channels on your T7200:

- Turn your radio Off.
- Turn your radio back On while you press and hold the  and  for 3 seconds.

A unique power-up chirp will sound (if Button Beeps are enabled) indicating that your radio now has repeater capability. Now you can talk to other T7200 radios that are set to your same Repeater Channel, Interference Eliminator Code, and Eavesdrop Reducer Code.

To disable Repeater Channels:

- Turn your Radio Off.
- Turn your radio back On while you press and hold the  and  for 3 seconds.

A single power-up chirp will sound (if Button Beeps are enabled) indicating that your radio now has returned to normal Channel mode.

Channels 15 r^P - 22 r^P will no longer appear on your display.

Setting Repeater Channels





Once you enable your Repeater Channels on your T7200:

- Press  to scroll up to Channel 15 r^P - 22 r^P , located just after Channel 22.
- When you scroll to a repeater Channel, the selected Interference Eliminator Code will be displayed briefly. Then, r^P will appear in these digits to indicate repeater operation. **FREQ** will also display when you are on a Repeater Channel.

Setting Repeater Interference Eliminator Codes

The Interference Eliminator Codes for GMRS Repeater Channels 15 r^P - 22 r^P and GMRS Direct Channels 15-22 are linked. This means that when you change the Code on a GMRS Repeater Channel, the Code on the equivalent GMRS Direct Channel will change as well and vice versa (i.e. If you are on Channel 15, Code 30 and you change to Code 31, then the Code will automatically change from 30 to 31 on Channel 15 r^P). To change your Repeater Interference Eliminator Code:

- Press the  to scroll up to any Channel between 15 r^P - 22 r^P .

- The Interference Eliminator Code assigned to the Repeater Channel selected will show for two seconds until r^P replaces it.
- Press  once and the Interference Eliminator Code will flash.
- Press  or  until you select an Interference Eliminator Code.
- Press  again or press .

Scanning Repeater Channels

If you have Repeater Channels and Scan enabled, **FREQ** will display as Scan is scrolling through or landing on Channels 15 r^P - 22 r^P .

Note: To enhance your radio's performance, remove the GMRS direct or GMRS Repeater Channels that you do not plan to use from the Scan List (see page 28.) For example, it would be beneficial to remove Channel 16 from your Scan List if you are using Channel 16 r^P and vice versa. Your radio will talk back on the correct transmit frequency if you follow this procedure.



If you need additional help, please refer to Scanning on page 27.

You may also refer to Frequency and Code Charts on page 42 for more details.

Weather (T7200)



You can't change the weather, but you can be prepared for it when you take your Motorola Talkabout T7200 radio with you. That's because it tunes into broadcasts by the United States National Oceanic and Atmospheric Administration (NOAA) Weather Radio and Environment Canada Weatheradio.

You can listen to a Weather Channel or you can even set your radio to alert you to emergency weather broadcasts that interrupt routine broadcasts.

Both NOAA and Environment Canada have transmitters located throughout the United States and Canada, respectively. These transmitters broadcast watches, forecasts, and other information 24 hours a day.

Note: Service may not be available in all areas. Check with your local weather office for frequency and details, or visit www.nws.noaa.gov/nwr, (Canada: www.msc-smc.ec.gc.ca/cd/factsheets/wxradio). The use of the NOAA logo does not provide an endorsement or implied endorsement by NOAA's National Weather Service nor does the use of the Weatheradio logo provide an endorsement or implied endorsement by Environment Canada.



Whenever you listen to a Weather Channel, you cannot use your radio for two-way communications. However, a weather alert will notify you while the radio is in two-way mode (if you have enabled weather alert) and the radio is On but not transmitting or receiving.

Turning On Weather Channel Reception

To turn on Weather Channel Reception, press and hold ☺. To turn off Weather Channel Reception and return to two-way mode, press and hold ☹ again.

Setting the Weather Channel

Your radio receives eight frequencies. See the Weather Frequency Chart on page 43. for a complete list.





- After turning on the weather broadcast, press  or  to select the strongest Channel.



As with two-way radio reception, Weather Channel Reception depends on how close you are to a transmitter and whether you are indoors or outdoors. Also, because Weather Channels are transmitted without Codes, they may contain static or noise.

Note: In some isolated areas, it may not be possible to receive Weather Channel Transmissions.

To Set Weather Alert:

- Switch to weather mode,
- press  once, and
- press  or  to select 4 (On).
- If you activate Weather Alert and return to two-way mode,  will display.



Note: The Talkabout T7200 two-way radios are designed to be two-way radios primarily, with the added utility of features such as Weather Alert. The radio uses the same circuitry for both two-way radio and weather alert receptions. Therefore, you can miss a weather alert while you are engaged in two-way communication (either transmitting or receiving). To ensure that you do not miss a weather alert, leave the radio in the Weather Mode.

Using Accessories

Make sure the radio is turned Off before plugging audio accessories into the accessory port. Before you place an accessory on your head or in your ear, turn the volume down. To order accessories, please refer to: www.motorola.com/talkabout.

Swivel Belt Holster

Your radio includes a Swivel Belt Holster for your convenience, which allows both plug-in and drop-in charging.

- Slide the bottom of the radio into the holster until it snaps into place.
- To remove, push the tab above the battery door and pull the radio from the holster.

In case of loss, please contact your point-of-sale or call 1-800-353-2729 and request replacement part number NNTN4106AR.

Remote Speaker Microphone

Lapel-mounted speaker/microphone provides hands-on, Push-To-Talk control for low profile radio operation without removing the radio from belt or carry case.

Ear-piece with Push-To-Talk Microphone

Discreet, lightweight ear-piece with hand-operated lapel or collar-mounted microphone. It allows clear communication without disturbance or interference.

Ear-piece with Boom Microphone

Discreet, lightweight ear-piece which fits comfortably around the ear while boom microphone allows for remote radio placement and is VOX/Hands-free compatible.

Headset with Swivel Boom Microphone

Comfortable, lightweight headset that is VOX/Hands-free compatible.

Earbud

Discreet, lightweight ear-piece which fits comfortably inside the ear allows clear message reception without disturbing others or when noise would interfere.

Flexible Ear Receiver

Lightweight ear-piece which fits comfortably and securely around the ear.

Face Plate

Attaching Face Plate

- **Turn the radio Off.**
- To attach radio face plate, insert face plate tabs into slots aligning face plate with the appropriate buttons.
- Snap into place.

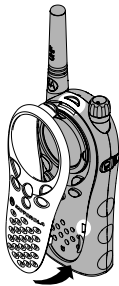

Removing Radio Face Plate

- **Turn the radio Off.**
- To remove radio face plate, press top tab and gently pull up on both SIDES of the bezel.
- Pick it up and off the keypad.



Use and Care



Use a soft damp cloth to clean the exterior.



Do not immerse in water.



Do not use alcohol or cleaning solutions.

If the radio gets wet...



Turn it Off and remove batteries.



Dry with soft cloth.



Do not use until completely dry.

Frequency and Code Charts

The charts on these pages provide frequency and code compatibility information. These charts are useful when using Motorola Talkabout two-way radios with other GMRS and FRS radios.

T7100 Channel	T7200 Channel	Code Display	Transmit Frequency (MHz)	Transmit Power (Watts)	Receive Frequency (MHz)	Description
1	1	0-38	462.5625	2	462.5625	FRS 1/GMRS Interstitial 1
2	2	0-38	462.5875	2	462.5875	FRS 2/GMRS Interstitial 2
3	3	0-38	462.6125	2	462.6125	FRS 3/GMRS Interstitial 3
4	4	0-38	462.6375	2	462.6375	FRS 4/GMRS Interstitial 4
5	5	0-38	462.6625	2	462.6625	FRS 5/GMRS Interstitial 5
6	6	0-38	462.6875	2	462.6875	FRS 6/GMRS Interstitial 6
7	7	0-38	462.7125	2	462.7125	FRS 7/GMRS Interstitial 7
8	8	0-38	467.5625	0.5	467.5625	FRS 8
9	9	0-38	467.5875	0.5	467.5875	FRS 9
10	10	0-38	467.6125	0.5	467.6125	FRS 10
11	11	0-38	467.6375	0.5	467.6375	FRS 11
12	12	0-38	467.6625	0.5	467.6625	FRS 12
13	13	0-38	467.6875	0.5	467.6875	FRS 13
14	14	0-38	467.7125	0.5	467.7125	FRS 14
15	15	0-38	462.5500	2	462.5500	GMRS Primary 1
16	16	0-38	462.5750	2	462.5750	GMRS Primary 2
17	17	0-38	462.6000	2	462.6000	GMRS Primary 3
18	18	0-38	462.6250	2	462.6250	GMRS Primary 4

T7100 Channel	T7200 Channel	Code Display	Transmit Frequency (MHz)	Transmit Power (Watts)	Receive Frequency (MHz)	Description
19	19	0-38	462.6500	2	462.6500	GMRS Primary 5
20	20	0-38	462.6750	2	462.6750	GMRS Primary 6
21	21	0-38	462.7000	2	462.7000	GMRS Primary 7
22	22	0-38	462.7250	2	462.7250	GMRS Primary 8
	15 <i>rP</i>	0-38	467.5500	2	462.5500	GMRS Repeater 1
	16 <i>rP</i>	0-38	467.5750	2	462.5750	GMRS Repeater 2
	17 <i>rP</i>	0-38	467.6000	2	462.6000	GMRS Repeater 3
	18 <i>rP</i>	0-38	467.6250	2	462.6250	GMRS Repeater 4
	19 <i>rP</i>	0-38	467.6500	2	462.6500	GMRS Repeater 5
	20 <i>rP</i>	0-38	467.6750	2	462.6750	GMRS Repeater 6
	21 <i>rP</i>	0-38	467.7000	2	462.7000	GMRS Repeater 7
	22 <i>rP</i>	0-38	467.7250	2	462.7250	GMRS Repeater 8

Weather Frequency Chart (T7200 Only)			
WX1	162.550	WX5	162.450
WX2	162.400	WX6	162.500
WX3	162.475	WX7	162.525
WX4	162.425	WX8	163.275

Carrier squelch (0) disables Interference Eliminator Codes. This allows you to monitor all activity on the Channel you are using. Interference Eliminator Codes help minimize interference by providing you with a choice of code combinations.

Interference Eliminator Codes

Code	Hz Freq	Code	Hz Freq	Code	Hz Freq
1	67.0	14	107.2	27	167.9
2	71.9	15	110.9	28	173.8
3	74.4	16	114.8	29	179.9
4	77.0	17	118.8	30	186.2
5	79.7	18	123.0	31	192.8
6	82.5	19	127.3	32	203.5
7	85.4	20	131.8	33	210.7
8	88.5	21	136.5	34	218.1
9	91.5	22	141.3	35	225.7
10	94.8	23	146.2	36	233.6
11	97.4	24	151.4	37	241.8
12	100.0	25	156.7	38	250.3
13	103.5	26	162.2		

Troubleshooting

Symptom	Try This:
No power	Reposition or replace Alkaline batteries. Recharge or replace NiMH battery.
Message not transmitted	Make sure  is completely pressed as you transmit. Reposition, replace, or recharge batteries.
Hearing other noises or conversation on a Channel	Confirm Interference Eliminator Code is set. Shared Channel or Interference Eliminator Code may be in use, try another.
Message scrambled	(T7200) Eavesdrop Reducer Code is On, or setting does not match other radios' settings; all radios must use the same Eavesdrop Reducer Code.
Limited talk range	Steel and/or concrete structures, heavy foliage, use in buildings or vehicles decrease range. Check for clear line of sight to improve transmission. Wearing radio close to body such as in a pocket or on a belt decreases range. Change location of radio.

Symptom

Try This:

Message not received

Confirm radios have the same Channel and Interference Eliminator Code settings.

Make sure  is **NOT** being pressed while trying to listen.

Reposition, replace, or recharge batteries.

Obstructions and operating indoors, or in vehicles, may interfere -- change location.

Heavy static or interference

Radios are too close, they must be at least five feet apart.

Radios are too far apart or obstacles interfering with transmission.

Keypad locked

Make sure keypad is unlocked. Unlock by pressing  for three seconds.

Low batteries

Recharge or replace NiMH battery. Replace AA batteries.

Extreme operating temperatures affect battery life.

Symptom**Try This:**

Audio sounds muffled/ excessively soft or distorted/ excessively loud.

Check with the person you are talking to and make sure your bandwidth matches (12.5 kHz or 25 kHz). See *Selecting Bandwidth* on page 33.

Difficulty talking from T7100 or T7200 to FRS radio on Channels 1-7.

Change to Channels 8-14 or move closer together.

Low battery meter reading although new batteries are installed

Verify that the radio is set to the correct battery type.

Cannot activate VOX

Feature not set and On. You can also increase the Sensitivity Level.
*Please refer to *Setting Sensitivity Level* on page 26.*

Motorola Limited Warranty

Motorola Personal Communications Products and Accessories Purchased in the United States and Canada

I. What This Warranty Covers

Defects in materials and workmanship in the following new **“Products”** manufactured, sold or certified by Motorola, with which this limited warranty is included in/on the package: (a) wireless cellular telephones, pagers and two-way radios that operate via “Personal Radio Service” (such as Family Radio Service and General Mobile Radio Service), together with software imbedded in any of these products, and (b) subject to the following exceptions, accessories or software sold for use with these products.

- Battery Exception. This limited warranty extends only to batteries in which the fully-charged capacity falls below 80% of rated capacity and batteries that leak;
- Software Exceptions. This limited warranty extends only to physical defects in the media (such as CD-ROM) that tangibly embodies each copy of any software sold and/or certified by Motorola for use with Products. Software that is not tangibly embodied in media and that is purchased separately from Products (such as software that is downloaded from the internet) comes **“as is” and without warranty**.

II. What the Period of Coverage Is

Subject to the following exceptions, one year from the date the Products are purchased by the first end-user:

- 90-Day Warranty Exception. The warranty is for 90 days for: (a) any software tangibly embodied in media or (b) any accessories for two-way radios that are covered by this warranty, as described in Section I, above.
- Limited Lifetime Warranty Exception. The warranty is a limited lifetime warranty for the lifetime of ownership by the first end-user of the following products, **only**: (a) decorative covers, including bezel, PhoneWrap™ or case (any model); and (b) ear buds and boom headsets that transmit mono sound through a wire connection (this does **not** include ear buds or boom headsets that either transmit stereo sound or that are wireless, or both).
- Repair / Replacement Exception. The warranty is for the balance of the original warranty or for 90 days from the date returned and delivered to the first end-user, whichever is longer.

III. Who is Covered

This warranty extends to you only if you are the first end-user purchaser.

IV. What We Will Do to Correct Warranty Problems

At no charge to you, we have the option to repair or replace the Products that do not conform to the warranty, or to refund the Products' purchase price. We may use functionally equivalent reconditioned/refurbished/pre-owned or new Products or parts. No software updates are provided.

V. How to Get Warranty Service

PLEASE CALL US – DO NOT SHIP:

USA

Cellular 1-800-331-6456

Paging 1-800-548-9954

FRS Radios 1-800-353-2729

TTY (Text Telephone)

1-888-390-6456

Accessories and software -- call the number designated for the product with which they are used.

Canada

All Products 1-800-461-4575

TTY (Text Telephone)

1-888-390-6456

You will receive instructions on how to ship the Products to Motorola or our designated resource. If instructed to ship the Products, you must ship them with freight, duties and insurance prepaid. Regardless of where you are instructed to return the Products, you must include: (a) a copy of your receipt, bill of sale or other comparable proof of purchase; (b) a written description of the problem; (c) the name of your service provider (if this Product requires subscription service); (d) the name and location of the installation facility (if applicable) and, most importantly; (e) your address and telephone number. If requested, you must also return all detachable parts such as antennas, batteries and chargers. **RETAIN YOUR ORIGINAL PROOF OF PURCHASE.**

For Products we ask you ship to us, we will ship repaired or replacement Products at our expense for the freight and insurance, but at your expense for any duties. If additional information is needed, please contact us at the telephone number listed above.

VI. What This Warranty Does Not Cover

- Products that are operated in combination with ancillary or peripheral equipment or software not furnished or otherwise certified by Motorola for use with the Products (“ancillary equipment”), or any damage to the Products or ancillary equipment as a result of such use. Among other things, “ancillary equipment” includes batteries, chargers, adaptors, and power supplies not manufactured or supplied by Motorola. Any of these voids the warranty.
- Someone other than Motorola (or its authorized service centers) tests, adjusts, installs, maintains, alters, modifies or services the Products in any way. Any of these voids the warranty.
- Rechargeable batteries that: (a) are charged by other than the Motorola-approved battery charger specified for charging such batteries; (b) have any broken seals or show evidence of tampering; (c) are used in equipment other than the Product for which they are specified; or (d) are charged and stored at temperatures greater than 60 degrees centigrade. Any of these voids the warranty.
- Products that have: (a) serial numbers or date tags that have been removed, altered or obliterated; (b) board serial numbers that do not match each other, or board serial numbers that do not match the housing; or (c) nonconforming or non-Motorola housings or parts. Any of these voids the warranty.

- Defects or damage that result from: (a) use of the Products in a manner that is not normal or customary; (b) improper operation or misuse; (c) accident or neglect such as dropping the Products onto hard surfaces; (d) contact with water, rain, extreme humidity or heavy perspiration; (e) contact with sand, dirt or the like; or (f) contact with extreme heat, or spills of food or liquid.
- Physical damage to the surface of the Products, including scratches, cracks or other damage to a display screen, lens or other externally exposed parts.
- Failure of Products that is due primarily to any communication service or signal you may subscribe to or use with the Products.
- Coil cords that are stretched or that have any broken modular tabs.
- Leased Products.

Flat-rate repair rates may apply to Products not covered by this warranty. To obtain information about Products needing repairs that are not covered by this warranty, please call the telephone number previously listed. We will provide information on repair availability, rates, methods of payment, where to send the Products, etc.

VII. Some Other Limitations

This is Motorola's complete warranty for the Products, and states your exclusive remedies. This warranty is given in lieu of all other express warranties. Implied warranties, including without limitation, the implied warranties of merchantability and fitness for a particular purpose, are given only if specifically required by applicable law. Otherwise, they are specifically excluded.

No warranty is made as to coverage, availability, or grade of service provided by the Products, whether through a service provider or otherwise.

No warranty is made that the software will meet your requirements or will work in combination with any hardware or applications software products provided by third parties, that the operation of the software products will be uninterrupted or error free, or that all defects in the software products will be corrected.

In no event shall Motorola be liable, whether in contract or tort (including negligence) for damages in excess of the purchase price of the Product, or for any indirect, incidental, special or consequential damages of any kind, or loss of revenue or profits, loss of business, loss of information or data, or other financial loss arising out of or in connection with the ability or inability to use the Products, to the full extent these damages may be disclaimed by law.

VIII. Patent and Software Provisions

At Motorola's expense, we will defend you, and pay costs and damages that may be finally awarded against you, to the extent that a lawsuit is based on a claim that the Products directly infringe a United States patent. Our obligation is conditioned on: (a) you notifying us promptly in writing when you receive notice of the claim; (b) you giving us sole control of the defense of the suit and all negotiations for its settlement or compromise; and (c) should the Products become, or in Motorola's opinion be likely to become, the subject of a claim of infringement of a United States patent, you permit us, at our option and expense, either to: procure for you the right to continue

using the Products; replace or modify them so that they become non-infringing; or grant you a credit for such Products, as depreciated, and accept their return. The depreciation will be an equal amount per year over the lifetime of the Products, as established by Motorola.

Motorola will have no liability to you with respect to any claim of patent infringement that is based upon the combination of the Products or parts furnished under this limited warranty with ancillary equipment, as defined in VI., above.

This is Motorola's entire liability with respect to infringement of patents by the Products.

IX. State Law and Other Jurisdiction Rights

Some states and other jurisdictions do not allow the exclusion or limitation of incidental or consequential damages, or limitation on the length of an implied warranty, so the above limitations or exclusions may not apply to you.

This warranty gives you specific legal rights, and you may also have other rights, which vary from jurisdiction to jurisdiction.

To obtain information on Motorola Personal Communications Products, including warranty service, accessories and optional Extended Warranties on selected Products, please call:

USA

Cellular 1-800-331-6456

Paging 1-800-548-9954

FRS Radios 1-800-353-2729

TTY (Text Telephone)

1-888-390-6456

Canada

All Products 1-800-461-4575

TTY (Text Telephone)

1-888-390-6456

Accessories and software -- call the telephone number designated above for the product with which they are used.

DO NOT SHIP PRODUCTS TO THESE ADDRESSES – INSTEAD PLEASE CALL.

To correspond with Motorola about the Products, please write us at
<http://www.motorola.com> or at:

In the USA:

Motorola, Inc.

600 North U.S. Highway 45

Libertyville, IL 60048

In Canada:

Motorola Canada Limited

5875 Whittle Road

Mississauga, ON L4Z 2H4

Software Copyright Notice

The Motorola products described in this manual may include copyrighted Motorola and third party software stored in semiconductor memories or other media. Laws in the United States and other countries preserve for Motorola and third party software providers certain exclusive rights for copyrighted software, such as the exclusive rights to distribute or reproduce the copyrighted software. Accordingly, any copyrighted software contained in the Motorola products may not be modified, reverse-engineered, distributed, or reproduced in any manner to the extent allowed by law. Furthermore, the purchase of the Motorola products shall not be deemed to grant either directly or by implication, estoppel, or otherwise, any license under the copyrights, patents, or patent applications of Motorola or any third party software provider, except for the normal, non-exclusive, royalty-free license to use that arises by operation of law in the sale of a product.

Patent Notice

This product is covered by one or more of the following United States patents.

5896277	5894292	5864752	5699006	5742484	6246866	D408396	D399821
D387758	D389158	5894592	5893027	5789098	5734975	5861850	D395882
D383745	D389827	D389139	5929825	5926514	5953640	6071640	D413022
D416252	D416893	D433001					

Export Law Assurances

This product is controlled under the export regulations of the United States of America and Canada. The Governments of the United States of America and Canada may restrict the exportation or re-exportation of this product to certain destinations. For further information contact the U.S. Department of Commerce or the Canadian Department of Foreign Affairs and International Trade.

Replacement of any transmitter component (crystal, semiconductor, etc.) not authorized by the FCC equipment authorization for this radio could violate FCC rules.

More specifically, changes or modifications not expressly approved by Motorola may void the user's authority granted by the FCC to operate this radio and should not be made. To comply with FCC requirements, transmitter adjustments should be made only by or under the supervision of a person certified as technically qualified to perform transmitter maintenance and repairs in the private land mobile and fixed services as certified by an organization representative of the user of those services. Replacement of any transmitter component (crystal, semiconductor, etc.) not authorized by the FCC equipment authorization for this radio could violate FCC rules.

Note: Use of this radio outside the country where it was intended to be distributed is subject to government regulations and may be prohibited

Talkabout T7100/T7200 Quick Reference

Function Appearance

Channel



Use or for 1 through 22.

Interference Eliminator Code

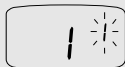

Use or for 0 through 38.

Eavesdrop Reducer



Use or for 1-3 or 0 for disables feature. (T7200 Only)

Function Appearance

Call Tone



Use or for 1 through 10 or Off = 0.

Mic Gain/Sensitivity Level



Use or for 1 low, 2 medium, or 3 high. G = Mic Gain, E = External VOX, i = Internal VOX.

Scan List



Use for Y/yes or n/no for each channel.









Battery Type



Use or for A = Alkaline n = NiMH or NiCd.

Talkabout T7100/T7200 Quick Reference





Talkabout T7000 Series Controls.

	<ul style="list-style-type: none">• Turn power On/Off• Adjust Volume		<ul style="list-style-type: none">• Talk on the radio• Exit a menu
	<ul style="list-style-type: none">• Weather*/ Backlight		<ul style="list-style-type: none">• Scroll through menus• Lock Keypad
	<ul style="list-style-type: none">• Transmit call tone	 or 	<ul style="list-style-type: none">• Scroll through and select settings
	<ul style="list-style-type: none">• Scan/Monitor		* T7200 Only

Weather Mode (T7200 Only)

Function	Appearance
----------	------------

Weather Channel		Press and hold  to access. Use  or  for 1 through 8.
-----------------	---	---

Weather Alert		Press  once. Use  or  for n (off) and 4 (on)
---------------	---	---

- **Up to 5-mile *Range**
*Range will vary based on terrain and conditions.
- **22 Channels (8 GMRS + 14 FRS), each with 38 Interference Eliminator codes**
GMRS channels feature increased power for longer range; 14 FRS channels ensure backward compatibility with FRS two-way radios. 38 interference eliminator codes per channel help minimize interference from other groups.
- **Motorola Quality**
Shock/drop/temperature tested to meet Motorola's High standards.
- **Multiple Audible Call Tones**

Accessories for T7000 series -

Convenient headphones, some with hands-free talk capabilities, mesh and waterproof carry cases, and rechargeable battery packs available from your retailer or www.motorola.com/talkabout

MOTOROLA, the Stylized M Logo, TALKABOUT, and all other trademarks indicated as such herein are trademarks of Motorola, Inc. © Reg. U.S. Pat. & Tm. Off. All other product or service names are the property of their respective owners. © 2002 Motorola, Inc. All rights reserved. Printed in Malaysia.

Motorola® Talkabout® T7000



Proof of Purchase

- **Plug-in/Drop-In Charging Capable**
- **Belt Clip/Carry Holster Included**
- **Talk Hands-Free (VOX)**
Advanced voice activation lets you talk hands-free.
- **“Roger” Beep/Talk Confirmation Tone**
Signals you're done talking.
- **Digital Audio Processing**
Provides crisper audio quality.
- **Scan**
Easily finds Channel and Code by searching all combinations.

- **Signal Strength Indicator**
Visual indicator lets you know when other radios are heading out of range while you're communicating.
- **Batteries (not included)**
Requires only 4 AA Alkaline batteries or 1 NiMH rechargeable battery .
- **Eavesdrop Reducer (T7200)**
Helps enhance privacy.
- **8 GMRS Repeater Channels (T7200)**
- **8 Weather Channels (T7200)**
- **1-Year Limited Warranty**
For details, call 1-800-353-2729.
- **Nuisance Delete**
Manual Advance Scan Features

Specification Chart

Transmit Power

2 W GMRS (conducted), 0.5 W FRS

Receiver Sensitivity

0.18uV

Audio Output

500 mW

Receiver Technology

Digital Direct Conversion - DZIF

Note: For T7200, weather radio service may not be available in all areas. Check with your local weather office for frequency and details or visit www.nws.noaa.gov/nwr in the US or www.msc-smc.ec.gc.ca/cd/factsheets/wxradio in Canada. The use of the NOAA logo does not provide an endorsement or implied endorsement by NOAA's National Weather Service nor does the use of the Weatheradio logo provide an endorsement or implied endorsement by Environment Canada.

**FCC GMRS
License Required**

**WARNING CHOKING HAZARD
SMALL PARTS**
Not for children under 3 years.
This product is not intended to be used
as a toy or plaything.